



**FCC 47 CFR PART 15 SUBPART E  
INDUSTRY CANADA RSS-210 ISSUE 8**

**CERTIFICATION TEST REPORT**

**FOR**

**Tablet with cellular GSM/GPRS/EGPRS/WCDMA/HSPA+/DC-  
HSDPA/CDMA1xRTT/1x Advanced/EV-DO Rev 0, A, B/LTE/IEEE 802.11a/b/g/n  
(MIMO 2x2) and Bluetooth Radio**

**MODEL NUMBER: A1475**

**FCC ID: BCGA1475  
IC: 579C-A1475**

**REPORT NUMBER: 13U15555-8**

**ISSUE DATE: SEPTEMBER 17, 2013**

*Prepared for*

**APPLE, INC.  
1 INFINITE LOOP  
CUPERTINO, CA 95014, U.S.A.**

*Prepared by*

**UL VERIFICATION SERVICES INC.  
47173 BENICIA STREET  
FREMONT, CA 94538, U.S.A.  
TEL: (510) 771-1000  
FAX: (510) 661-0888**



**NVLAP LAB CODE 200065-0**

Revision History

<u>Rev.</u>	<u>Issue Date</u>	<u>Revisions</u>	<u>Revised By</u>
--	09/17/13	Initial Issue	T. Chan

## TABLE OF CONTENTS

<b>1. ATTESTATION OF TEST RESULTS .....</b>	<b>7</b>
<b>2. TEST METHODOLOGY .....</b>	<b>8</b>
<b>3. FACILITIES AND ACCREDITATION .....</b>	<b>8</b>
<b>4. CALIBRATION AND UNCERTAINTY .....</b>	<b>8</b>
4.1. <i>MEASURING INSTRUMENT CALIBRATION .....</i>	<i>8</i>
4.2. <i>SAMPLE CALCULATION .....</i>	<i>8</i>
4.3. <i>MEASUREMENT UNCERTAINTY.....</i>	<i>8</i>
<b>5. EQUIPMENT UNDER TEST .....</b>	<b>9</b>
5.1. <i>DESCRIPTION OF EUT .....</i>	<i>9</i>
5.2. <i>MAXIMUM OUTPUT POWER.....</i>	<i>9</i>
5.3. <i>DESCRIPTION OF AVAILABLE ANTENNAS .....</i>	<i>11</i>
5.4. <i>SOFTWARE AND FIRMWARE.....</i>	<i>11</i>
5.5. <i>WORST-CASE CONFIGURATION AND MODE.....</i>	<i>11</i>
5.6. <i>DESCRIPTION OF TEST SETUP.....</i>	<i>12</i>
<b>6. TEST AND MEASUREMENT EQUIPMENT .....</b>	<b>15</b>
<b>7. ON TIME, DUTY CYCLE AND MEASUREMENT METHODS .....</b>	<b>16</b>
7.1. <i>ON TIME AND DUTY CYCLE RESULTS.....</i>	<i>16</i>
7.2. <i>MEASUREMENT METHOD FOR POWER AND PPSD.....</i>	<i>16</i>
7.3. <i>MEASUREMENT METHOD FOR AVERAGE SPURIOUS EMISSIONS ABOVE 1 GHz</i> 16	
7.4. <i>DUTY CYCLE PLOTS .....</i>	<i>17</i>
<b>8. ANTENNA PORT TEST RESULTS .....</b>	<b>19</b>
8.1. <i>802.11a SISO MODE IN THE 5.2 GHz BAND .....</i>	<i>19</i>
8.1.1. <i>26 dB BANDWIDTH.....</i>	<i>19</i>
8.1.2. <i>99% BANDWIDTH.....</i>	<i>22</i>
8.1.3. <i>AVERAGE POWER.....</i>	<i>25</i>
8.1.4. <i>OUTPUT POWER AND PSD.....</i>	<i>26</i>
8.2. <i>802.11n HT20 2TX STBC MODE IN THE 5.2 GHz BAND .....</i>	<i>30</i>
8.2.1. <i>26 dB BANDWIDTH.....</i>	<i>30</i>
8.2.2. <i>99% BANDWIDTH.....</i>	<i>34</i>
8.2.3. <i>AVERAGE POWER.....</i>	<i>38</i>
8.2.4. <i>OUTPUT POWER AND PPSD .....</i>	<i>39</i>
8.3. <i>802.11n HT20 2TX CDD MODE IN THE 5.2 GHz BAND .....</i>	<i>44</i>
8.3.1. <i>26 dB BANDWIDTH.....</i>	<i>44</i>
8.3.2. <i>AVERAGE POWER.....</i>	<i>48</i>
8.3.3. <i>OUTPUT POWER AND PPSD .....</i>	<i>49</i>

8.4. 802.11n HT40 SISO MODE IN THE 5.2 GHz BAND.....54  
8.4.1. 26 dB BANDWIDTH.....54  
8.4.2. 99% BANDWIDTH.....56  
8.4.3. AVERAGE POWER.....58  
8.4.4. OUTPUT POWER AND PPSD .....59  
8.5. 802.11n HT40 2TX STBC MODE IN THE 5.2 GHz BAND .....62  
8.5.1. 26 dB BANDWIDTH.....62  
8.5.2. 99% BANDWIDTH.....64  
8.5.3. AVERAGE POWER.....66  
8.5.4. OUTPUT POWER AND PPSD .....67  
8.6. 802.11n HT40 2TX CDD MODE IN THE 5.2 GHz BAND .....70  
8.6.1. 26 dB BANDWIDTH.....70  
8.6.2. 99% BANDWIDTH.....73  
8.6.3. AVERAGE POWER.....76  
8.6.4. OUTPUT POWER AND PPSD .....77  
8.7. 802.11a SISO MODE IN THE 5.3 GHz BAND .....81  
8.7.1. 26 dB BANDWIDTH.....81  
8.7.2. 99% BANDWIDTH.....84  
8.7.3. AVERAGE POWER.....87  
8.7.4. OUTPUT POWER AND PPSD .....88  
8.7.5. PEAK EXCURSION.....92  
8.8. 802.11n HT20 2TX CDD MODE IN THE 5.3 GHz BAND .....94  
8.8.1. 26 dB BANDWIDTH.....94  
8.8.2. 99% BANDWIDTH.....98  
8.8.3. AVERAGE POWER.....102  
8.8.4. OUTPUT POWER AND PPSD .....103  
8.8.5. PEAK EXCURSION.....108  
8.9. 802.11n HT40 SISO MODE IN THE 5.3 GHz BAND.....110  
8.9.1. 26 dB BANDWIDTH.....110  
8.9.2. 99% BANDWIDTH.....112  
8.9.3. AVERAGE POWER.....114  
8.9.4. OUTPUT POWER AND PPSD .....115  
8.9.5. PEAK EXCURSION.....118  
8.10. 802.11n HT40 2TX CDD MODE IN THE 5.3 GHz BAND.....120  
8.10.1. 26 dB BANDWIDTH.....120  
8.10.2. 99% BANDWIDTH.....123  
8.10.3. AVERAGE POWER.....126  
8.10.4. OUTPUT POWER AND PPSD .....127  
8.10.5. PEAK EXCURSION.....131  
8.11. 802.11a SISO MODE IN THE 5.6 GHz BAND .....133  
8.11.1. 26 dB BANDWIDTH.....133  
8.11.2. 99% BANDWIDTH.....136  
8.11.3. AVERAGE POWER.....139  
8.11.4. OUTPUT POWER AND PPSD .....140  
8.11.5. PEAK EXCURSION.....144  
8.12. 802.11n HT20 2TX CDD MODE IN THE 5.6 GHz BAND.....146  
8.12.1. 26 dB BANDWIDTH.....146  
8.12.2. 99% BANDWIDTH.....150

8.12.3. AVERAGE POWER..... 154  
8.12.4. OUTPUT POWER AND PPSD ..... 155  
8.12.5. PEAK EXCURSION..... 160  
8.13. 802.11n HT20 2TX STBC MODE IN THE 5.6 GHz BAND..... 162  
8.13.1. 26 dB BANDWIDTH..... 162  
8.13.2. 99% BANDWIDTH..... 164  
8.13.3. AVERAGE POWER..... 166  
8.13.4. OUTPUT POWER AND PPSD ..... 167  
8.13.5. PEAK EXCURSION..... 170  
8.14. 802.11n HT40 SISO MODE IN THE 5.6 GHz BAND ..... 172  
8.14.1. 26 dB BANDWIDTH..... 172  
8.14.2. 99% BANDWIDTH..... 175  
8.14.3. AVERAGE POWER..... 178  
8.14.4. OUTPUT POWER AND PPSD ..... 179  
8.14.5. PEAK EXCURSION..... 183  
8.15. 802.11n HT40 2TX CDD MODE IN THE 5.6 GHz BAND..... 185  
8.15.1. 26 dB BANDWIDTH..... 185  
8.15.2. 99% BANDWIDTH..... 189  
8.15.3. AVERAGE POWER..... 193  
8.15.4. OUTPUT POWER AND PPSD ..... 194  
8.15.5. PEAK EXCURSION..... 199  
**9. RADIATED TEST RESULTS.....201**  
9.1. LIMITS AND PROCEDURE.....201  
9.2. TRANSMITTER ABOVE 1 GHz.....202  
9.2.1. 802.11a SISO MODE IN THE 5.2 GHz BAND .....202  
9.2.2. 802.11n HT20 2TX CDD MODE IN THE 5.2 GHz BAND .....207  
9.2.3. 802.11n HT20 2TX STBC MODE IN THE 5.2 GHz BAND .....215  
9.2.4. 802.11n HT40 SISO MODE IN THE 5.2 GHz BAND.....216  
9.2.5. 802.11n HT40 2TX CDD MODE IN THE 5.2 GHz BAND .....222  
9.2.6. 802.11n HT40 2TX STBC MODE IN THE 5.2 GHz BAND .....228  
9.2.7. 802.11a SISO MODE IN THE 5.3 GHz BAND .....229  
9.2.8. 802.11n HT20 2TX CDD MODE IN THE 5.3 GHz BAND .....237  
9.2.9. 802.11n HT40 SISO MODE IN THE 5.3 GHz BAND.....245  
9.2.10. 802.11n HT40 2TX CDD MODE IN THE 5.3 GHz BAND .....251  
9.2.11. 802.11a SISO MODE IN THE 5.6 GHz BAND .....257  
9.2.12. 802.11n HT20 2TX CDD MODE IN THE 5.6 GHz BAND .....266  
9.2.13. 802.11n HT20 2TX STBC MODE IN THE 5.6 GHz BAND .....275  
9.2.14. 802.11n HT40 SISO MODE IN THE 5.6 GHz BAND.....276  
9.2.15. 802.11n HT40 2TX CDD MODE IN THE 5.6 GHz BAND .....285  
9.2.16. 2.4GHz and 5GHz Band Co-Location .....294  
9.3. WORST-CASE ABOVE 18 GHz .....298  
9.4. WORST-CASE BELOW 1 GHz.....304  
**10. AC POWER LINE CONDUCTED EMISSIONS .....306**  
**11. DYNAMIC FREQUENCY SELECTION .....309**  
11.1. OVERVIEW.....309  
11.1.1. LIMITS.....309

11.1.2. TEST AND MEASUREMENT SYSTEM.....312  
11.1.3. SETUP OF EUT.....315  
11.1.4. SETUP OF EUT (CLIENT-TO-CLIENT COMMUNICATIONS MODE).....316  
11.1.5. ESCRIPTION OF EUT .....317  
11.2. RESULTS FOR 20 MHz BANDWIDTH.....319  
11.2.1. TEST CHANNEL .....319  
11.2.2. RADAR WAVEFORM AND TRAFFIC.....319  
11.2.3. OVERLAPPING CHANNEL TESTS.....321  
11.2.4. MOVE AND CLOSING TIME .....321  
11.3. RESULTS FOR 40 MHz BANDWIDTH.....326  
11.3.1. TEST CHANNEL .....326  
11.3.2. RADAR WAVEFORM AND TRAFFIC.....326  
11.3.3. OVERLAPPING CHANNEL TESTS.....328  
11.3.4. MOVE AND CLOSING TIME .....328  
11.3.5. NON-OCCUPANCY PERIOD .....333  
11.4. CLIENT-TO-CLIENT COMMUNICATIONS MODE RESULTS FOR 20 MHz  
BANDWIDTH.....334  
11.4.1. TEST CHANNEL .....334  
11.4.2. RADAR WAVEFORM AND TRAFFIC.....334  
11.4.3. OVERLAPPING CHANNEL TESTS.....336  
11.4.4. MOVE AND CLOSING TIME .....336  
11.5. CLIENT-TO-CLIENT COMMUNICATIONS MODE RESULTS FOR 40 MHz  
BANDWIDTH.....341  
11.5.1. TEST CHANNEL .....341  
11.5.2. RADAR WAVEFORM AND TRAFFIC.....341  
11.5.3. OVERLAPPING CHANNEL TESTS.....343  
11.5.4. MOVE AND CLOSING TIME .....343  
**12. SETUP PHOTOS .....348**

# 1. ATTESTATION OF TEST RESULTS

**COMPANY NAME:** APPLE, INC.  
1 INFINITE LOOP  
CUPERTINO, CA 95014, U.S.A.

**EUT DESCRIPTION:** Tablet with cellular GSM/GPRS/EGPRS/WCDMA/HSPA+/DC-HSDPA/CDMA1xRTT/1x Advanced/EV-DO Rev 0, A, B/LTE/IEEE 802.11a/b/g/n (MIMO 2x2) and Bluetooth radio.

**MODEL:** A1475

**SERIAL NUMBER:** DLXL104WFMNF

**DATE TESTED:** JULY 7 - SEPTEMBER 03, 2013

APPLICABLE STANDARDS	
STANDARD	TEST RESULTS
CFR 47 Part 15 Subpart E	Pass
INDUSTRY CANADA RSS-210 Issue 8 Annex 9	Pass
INDUSTRY CANADA RSS-GEN Issue 3	Pass

UL Verification Services Inc. tested the above equipment in accordance with the requirements set forth in the above standards. All indications of Pass/Fail in this report are opinions expressed by UL Verification Services Inc. based on interpretations and/or observations of test results. Measurement Uncertainties were not taken into account and are published for informational purposes only. The test results show that the equipment tested is capable of demonstrating compliance with the requirements as documented in this report.

**Note:** The results documented in this report apply only to the tested sample, under the conditions and modes of operation as described herein. This document may not be altered or revised in any way unless done so by UL Verification Services Inc. and all revisions are duly noted in the revisions section. Any alteration of this document not carried out by UL Verification Services Inc. will constitute fraud and shall nullify the document. This report must not be used by the client to claim product certification, approval, or endorsement by NVLAP, NIST, any agency of the Federal Government, or any agency of any government.

Approved & Released For  
UL Verification Services Inc. By:

Tested By:



Thu Chan  
WiSE Operations Manager  
UL Verification Services Inc.

Tom Chen  
WiSE Engineer  
UL Verification Services Inc

## 2. TEST METHODOLOGY

The tests documented in this report were performed in accordance with FCC CFR 47 Part 2, FCC CFR 47 Part 15, FCC 06-96, FCC KDB 789033, ANSI C63.10-2009, RSS-GEN Issue 3, and RSS-210 Issue 8.

## 3. FACILITIES AND ACCREDITATION

The test sites and measurement facilities used to collect data are located at 47173 Benicia Street, Fremont, California, USA.

UL Verification Services Inc. is accredited by NVLAP, Laboratory Code 200065-0. The full scope of accreditation can be viewed at <http://www.ccsemc.com>.

## 4. CALIBRATION AND UNCERTAINTY

### 4.1. MEASURING INSTRUMENT CALIBRATION

The measuring equipment utilized to perform the tests documented in this report has been calibrated in accordance with the manufacturer's recommendations, and is traceable to recognized national standards.

### 4.2. SAMPLE CALCULATION

Where relevant, the following sample calculation is provided:

$$\begin{aligned} \text{Field Strength (dBuV/m)} &= \text{Measured Voltage (dBuV)} + \text{Antenna Factor (dB/m)} + \\ &\text{Cable Loss (dB)} - \text{Preamp Gain (dB)} \\ 36.5 \text{ dBuV} + 18.7 \text{ dB/m} + 0.6 \text{ dB} - 26.9 \text{ dB} &= 28.9 \text{ dBuV/m} \end{aligned}$$

### 4.3. MEASUREMENT UNCERTAINTY

Where relevant, the following measurement uncertainty levels have been estimated for tests performed on the apparatus:

PARAMETER	UNCERTAINTY
Conducted Disturbance, 0.15 to 30 MHz	3.52 dB
Radiated Disturbance, 30 to 1000 MHz	4.94 dB

Uncertainty figures are valid to a confidence level of 95%.



## 5. EQUIPMENT UNDER TEST

### 5.1. DESCRIPTION OF EUT

The Apple iPad Model A1475 is a tablet device with multimedia functions (music, application support, and video), cellular GSM/GPRS/EGPRS/WCDMA/HSPA+/DC-HSDPA/CDMA 1xRTT/EV-DO Rev 0, A, B /LTE radio, WIFI 802.11a/b/g/n MIMO and Bluetooth. The rechargeable battery is not user accessible.

### 5.2. MAXIMUM OUTPUT POWER

The transmitter has a maximum conducted output power as follows:

Frequency Range (MHz)	Mode	Output Power (dBm)	Output Power (mW)
<b>5.2GHz BAND</b>			
5180 - 5240	802.11a SISO	14.14	25.94
5180 - 5240	802.11n HT20, 2TX STBC	14.00	25.12
5180 - 5240	802.11n HT20 2TX CDD	13.52	22.49
5190 - 5230	802.11n HT40 SISO	15.95	39.36
5190 - 5230	802.11n HT40, 2TX STBC	16.75	47.32
5190 - 5230	802.11n HT40, 2TX CDD	15.93	39.17
<b>5.3GHz BAND</b>			
5260 - 5320	802.11a SISO	16.62	45.92
5260 - 5320	802.11n HT20 2TX CDD	19.80	95.50
5270 - 5310	802.11n HT40 SISO	16.53	44.98
5270 - 5310	802.11n HT40 2TX CDD	19.46	88.31
<b>5.6GHz BAND</b>			
5500 - 5700	802.11a SISO	16.43	43.95
5500 - 5700	802.11n HT20 2TX CDD	18.95	78.52
5580	802.11n HT20 2TX STBC	19.58	90.78
5510 - 5670	802.11n HT40 SISO	16.60	45.71
5510 - 5670	802.11n HT40 2TX CDD	19.55	90.16

**List of test reduction and modes covering other modes:**

<b>Antenna Port Testing</b>		
<b>Frequency Range (MHz)</b>	<b>Mode</b>	<b>Covered by</b>
<b>5.2 GHz band, 1TX</b>		
5180 - 5240	802.11n SISO	802.11a SISO
<b>5.2 GHz band, 2TX</b>		
5180 - 5240	802.11a 2TX CDD	802.11n HT20 CDD 2TX
5190 - 5230	802.11n HT40 2TX STBC/SDM	802.11n HT40 CDD 2TX
<b>5.3 GHz band, SISO</b>		
5180 - 5240	802.11n SISO	802.11a SISO
<b>5.3 GHz band, 2TX</b>		
5260 - 5320	802.11a 2TX CDD	802.11n HT20 CDD 2TX
5260 - 5320	802.11n HT20 2TX STBC/SDM	802.11n HT20 CDD 2TX
5270 - 5310	802.11n HT40 2TX STBC/SDM	802.11n HT40 CDD 2TX
<b>5.6GHz Band 2TX</b>		
5500 - 5700	802.11a 2TX CDD	802.11n HT20 CDD 2TX
5500 - 5700	802.11n SISO	802.11a SISO
5500 - 5700	802.11n HT20 2TX STBC/SDM	802.11n HT20 CDD 2TX
5510-5670	802.11n HT40 2TX STBC/SDM	802.11n HT40 CDD 2TX

<b>Radiated Testing</b>		
<b>Frequency Range (MHz)</b>	<b>Mode</b>	<b>Covered by</b>
<b>5.2 GHz band, 1TX</b>		
5180 - 5240	802.11n SISO	802.11a SISO
<b>5.2 GHz band, 2TX</b>		
5180 - 5240	802.11a 2TX CDD	802.11n HT20 CDD 2TX
5180 - 5240	802.11n HT20 2TX STBC/SDM	802.11n HT20 CDD 2TX
5190 - 5230	802.11n HT40 2TX STBC/SDM	802.11n HT40 CDD 2TX
<b>5.3 GHz band, SISO</b>		
5260 - 5320	802.11n SISO	802.11a SISO
<b>5.3 GHz band, 2TX</b>		
5260 - 5320	802.11a 2TX CDD	802.11n HT20 CDD 2TX
5260 - 5320	802.11n HT20 2TX STBC/SDM	802.11n HT20 CDD 2TX
5270 - 5310	802.11n HT40 2TX STBC/SDM	802.11n HT40 CDD 2TX
<b>5.6GHz Band 2TX</b>		
5500 - 5700	802.11a 2TX CDD	802.11n HT20 CDD 2TX
5500 - 5700	802.11n SISO	802.11a SISO
5500 - 5700	802.11n HT20 2TX STBC/SDM	802.11n HT20 CDD 2TX
5510 - 5670	802.11n HT40 2TX STBC/SDM	802.11n HT40 CDD 2TX

### 5.3. DESCRIPTION OF AVAILABLE ANTENNAS

Frequency Band (GHz)	Antenna Gain (dBi)		Uncorrelated Gain (dBi)	Correlated Gain (dBi)
	Tx1	Tx2		
5.2	2.37	2.07	<b>2.22</b>	<b>5.23</b>
5.3	2.60	2.11	<b>2.36</b>	<b>5.37</b>
5.5	3.66	3.99	<b>3.83</b>	<b>6.84</b>

### 5.4. SOFTWARE AND FIRMWARE

The test utility software used during testing was Broadcom WL Tool Version 6.25.86.

### 5.5. WORST-CASE CONFIGURATION AND MODE

The fundamental of the EUT was investigated in three orthogonal orientations X,Y,Z, it was determined that Z orientation was worst-case orientation for 5GHz; therefore, all final radiated testing was performed with the EUT in Z orientation for 5GHz.

Worst-Case data rates, as provided by the client, were as follows:

802.11a mode: 6 Mbps  
802.11n HT20mode: MCS0  
802.11n HT40mode: MCS0

Worst-case mode and channel used for 30-1000 MHz radiated and power line conducted emissions was including headset, AC charger and the mode and channel with the highest output power.

For all modes with single chain, chain 0 was selected per the software provided by the client. Based on the client a preliminary investigation was performed on the two chains and chain 0 was found to be worst-case.

## 5.6. DESCRIPTION OF TEST SETUP

### SUPPORT EQUIPMENT

Support Equipment List				
Description	Manufacturer	Model	Serial Number	FCC ID
AC/DC adapter	Apple	A1401	60812	DoC
Earphone	Apple	NA	NA	NA

### I/O CABLES (CONDUCTED TEST)

I/O Cable List						
Cable No	Port	# of identical ports	Connector Type	Cable Type	Cable Length (m)	Remarks
1	Antenna	1	SMA	Un-Shielded	0.1m	To Spectrum Analyzer

### I/O CABLES (RADIATED TEST)

I/O Cable List						
Cable No	Port	# of identical ports	Connector Type	Cable Type	Cable Length (m)	Remarks
1	Audio	1	Jack	Un-Shielded	0.5m	NA

### I/O CABLES (AC POWER CONDUCTED TEST)

I/O Cable List						
Cable No	Port	# of identical ports	Connector Type	Cable Type	Cable Length (m)	Remarks
1	AC	1	US115	Un-Shielded	2m	NA
2	DC	1	USB	Un-Shielded	2m	NA
3	Audio	1	Jack	Un-Shielded	0.5m	NA

**SETUP DIAGRAM FOR CONDUCTED TESTS**

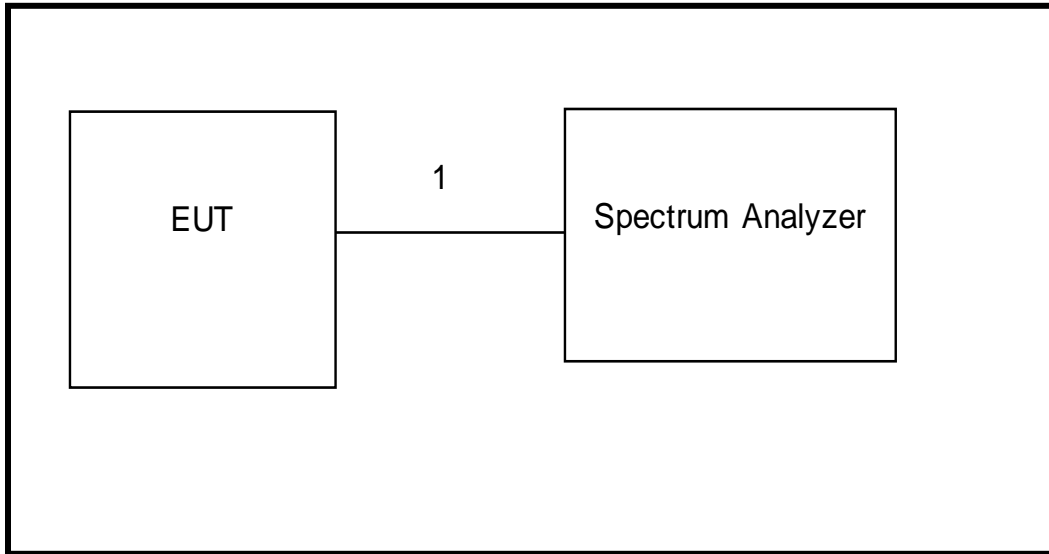

**SETUP DIAGRAM FOR RADIATED TESTS**

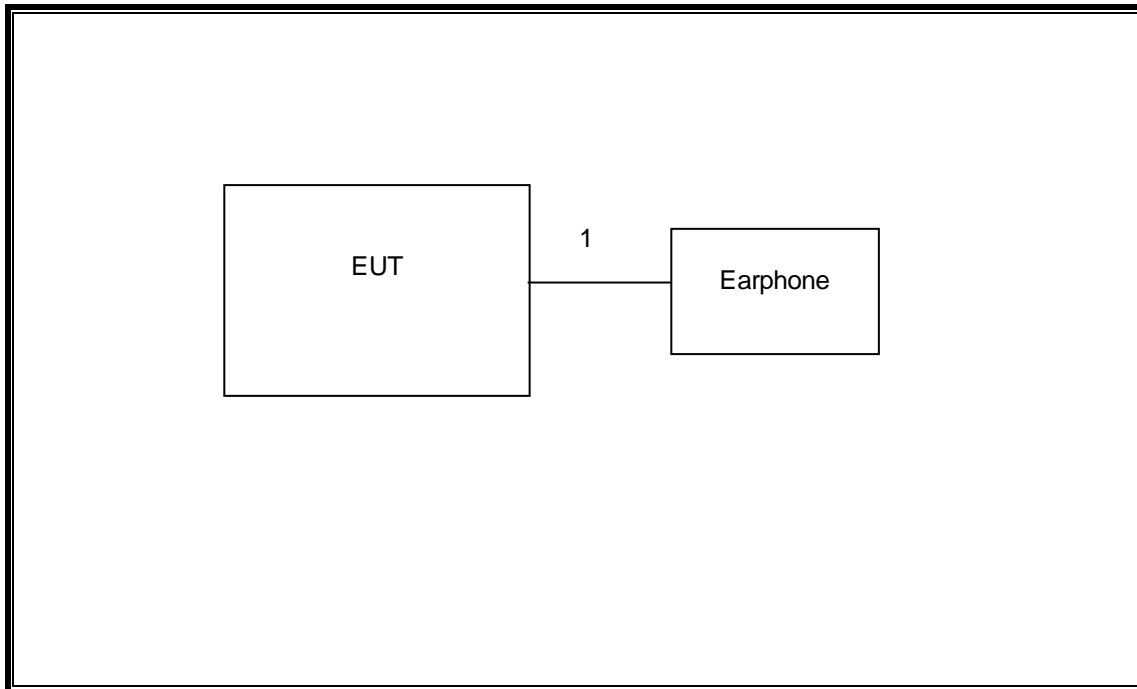

**SETUP DIAGRAM FOR BELOW 1GHZ & AC POWER CONDUCTED TESTS**

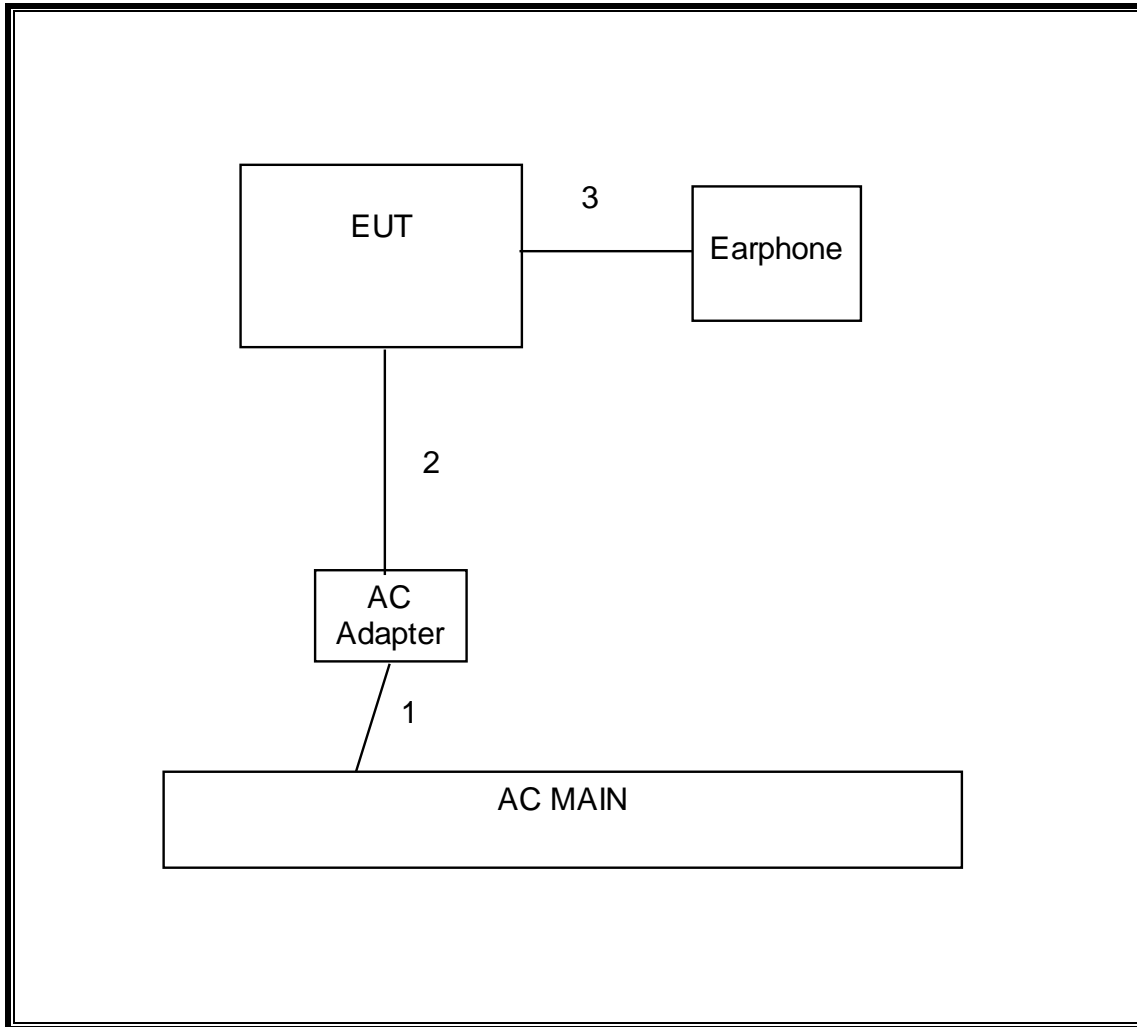

## 6. TEST AND MEASUREMENT EQUIPMENT

The following test and measurement equipment was utilized for the tests documented in this report:

Test Equipment List				
Description	Manufacturer	Model	Asset	Cal Due
Horn Antenna 1-18GHz	ETS Lindgren	3117	F00131	02/19/14
Preamplifier, 1300 MHz	Agilent / HP	8447D	C00580	01/28/14
Antenna, Horn, 26.5 GHz	ARA	SWH-28	C01015	05/06/14
Antenna, Biconolog, 30MHz-1 GHz	Sunol Sciences	JB3	F00027	03/07/14
Peak / Average Power Sensor	Agilent / HP	E9323A	F00163	04/03/14
P-Series single channel Power Meter	Agilent / HP	N1911A	F00164	04/03/14
Spectrum Analyzer, 3Hz-44GHz	Agilent	N9030A	F00127	02/22/14
Spectrum Analyzer, 3Hz-44GHz	Agilent	E4446A	C01012	10/21/13
PreApmplifier, 1-26.5GHz	Agilent	8449B	C01052	10/22/13
Antenna, Horn, 40 GHz	ARA	MWH-2640/B	F00194	05/14/14
EMI Test Receiver, 30 MHz	R & S	ESHS 20	N02396	08/15/14
Preamplifier, 40 GHz	Miteq	NSP4000-SP2	C00990	08/20/14

## 7. ON TIME, DUTY CYCLE AND MEASUREMENT METHODS

### LIMITS

None; for reporting purposes only.

### PROCEDURE

KDB 789033 Zero-Span Spectrum Analyzer Method.

### 7.1. ON TIME AND DUTY CYCLE RESULTS

Mode	ON Time B (msec)	Period (msec)	Duty Cycle x (linear)	Duty Cycle (%)	Duty Cycle Correction Factor (dB)	1/T Minimum VBW (kHz)
802.11a 20 MHz	2.064	2.092	0.987	98.7%	0.00	0.010
802.11n HT20	1.908	1.936	0.986	98.6%	0.00	0.010
802.11n HT40	0.925	0.942	0.981	98.1%	0.00	0.010

### 7.2. MEASUREMENT METHOD FOR POWER AND PPSD

The Duty Cycle is greater than or equal to 98% therefore KDB 789033 Method SA-1 is used.

The Duty Cycle is greater than or equal to 98% therefore KDB 789033 Method SA-1 Alternative is used.

### 7.3. MEASUREMENT METHOD FOR AVERAGE SPURIOUS EMISSIONS ABOVE 1 GHz

The Duty Cycle is greater than or equal to 98%, KDB 789033 Method AD with Power RMS Averaging is used.



### 7.4. DUTY CYCLE PLOTS

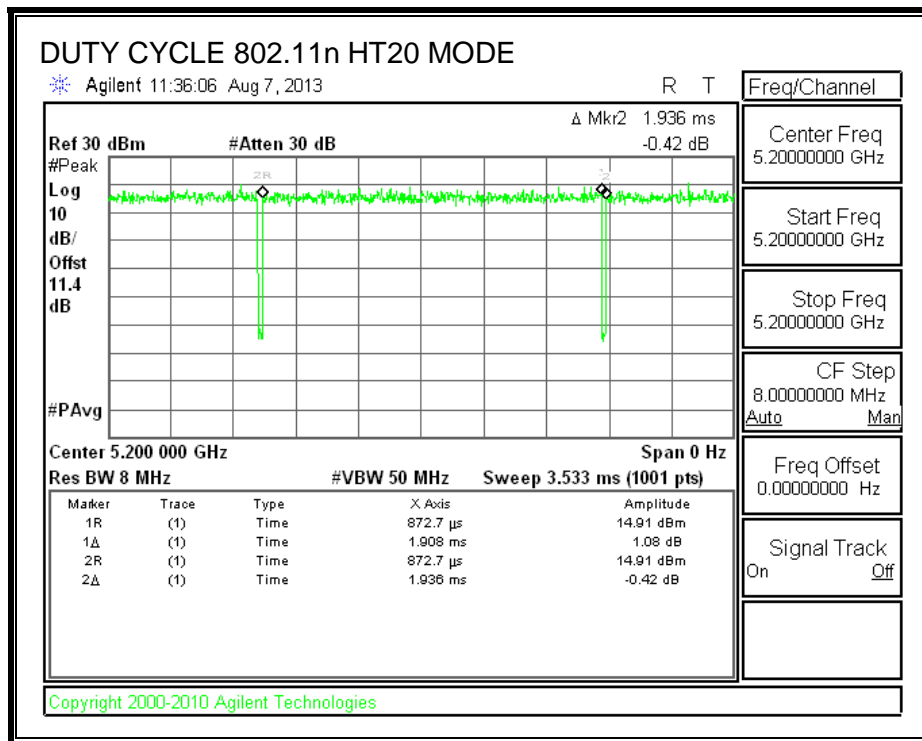
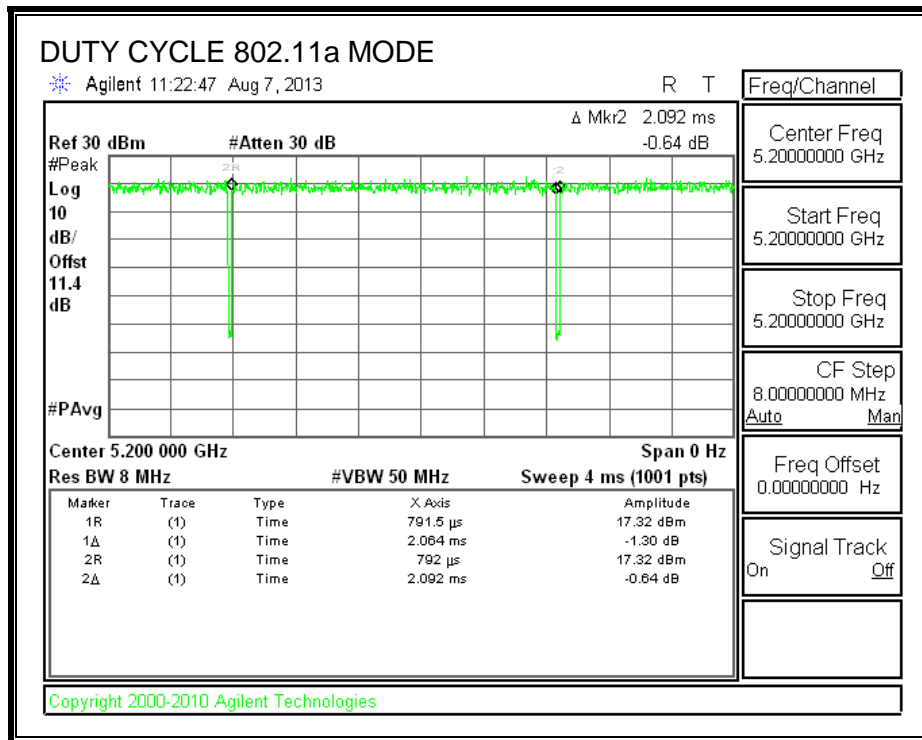

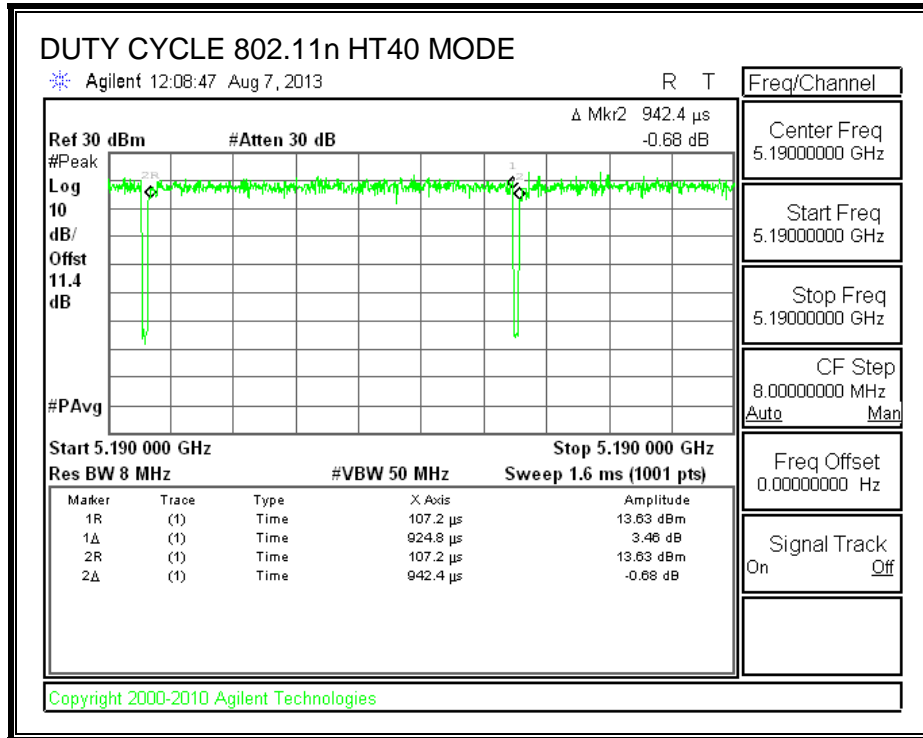

## 8. ANTENNA PORT TEST RESULTS

### 8.1. 802.11a SISO MODE IN THE 5.2 GHz BAND

#### 8.1.1. 26 dB BANDWIDTH

#### LIMITS

None; for reporting purposes only.

#### RESULTS

Channel	Frequency (MHz)	26 dB Bandwidth (MHz)
Low	5180	19.48
Mid	5200	19.44
High	5240	19.52

**26 dB BANDWIDTH**

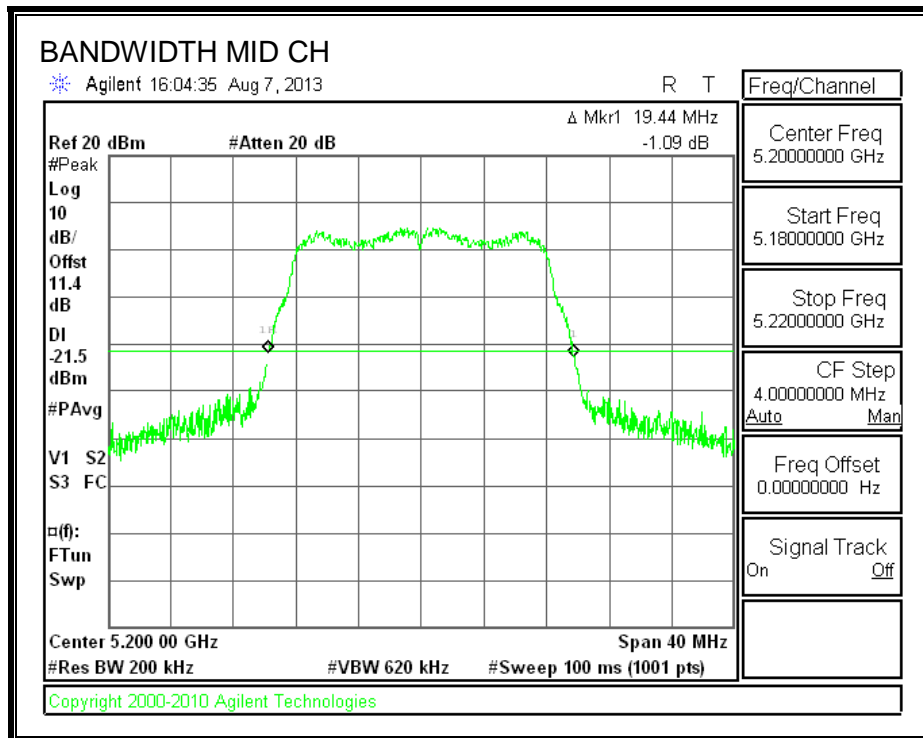
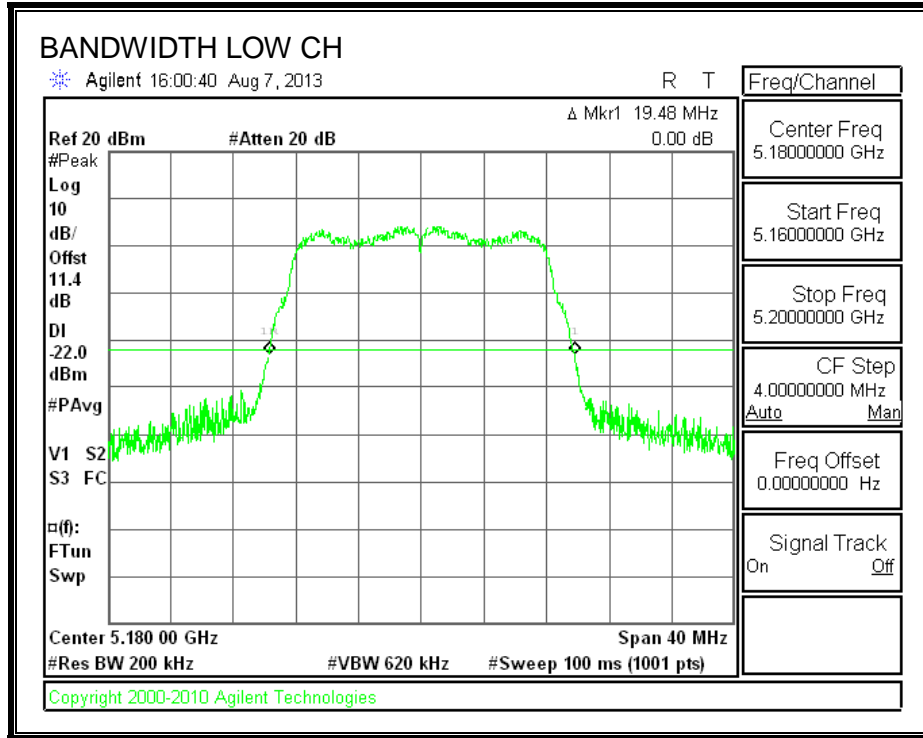

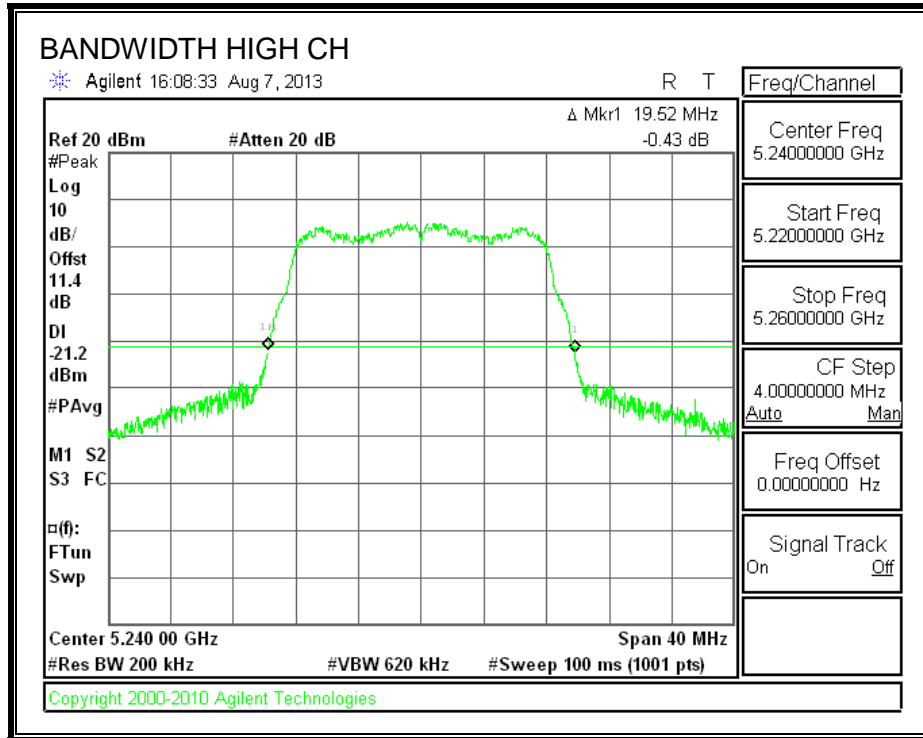

### 8.1.2. 99% BANDWIDTH

#### LIMITS

None; for reporting purposes only.

#### RESULTS

Channel	Frequency (MHz)	99% Bandwidth (MHz)
Low	5180	16.3689
Mid	5200	16.3851
High	5240	16.3485

**99% BANDWIDTH**

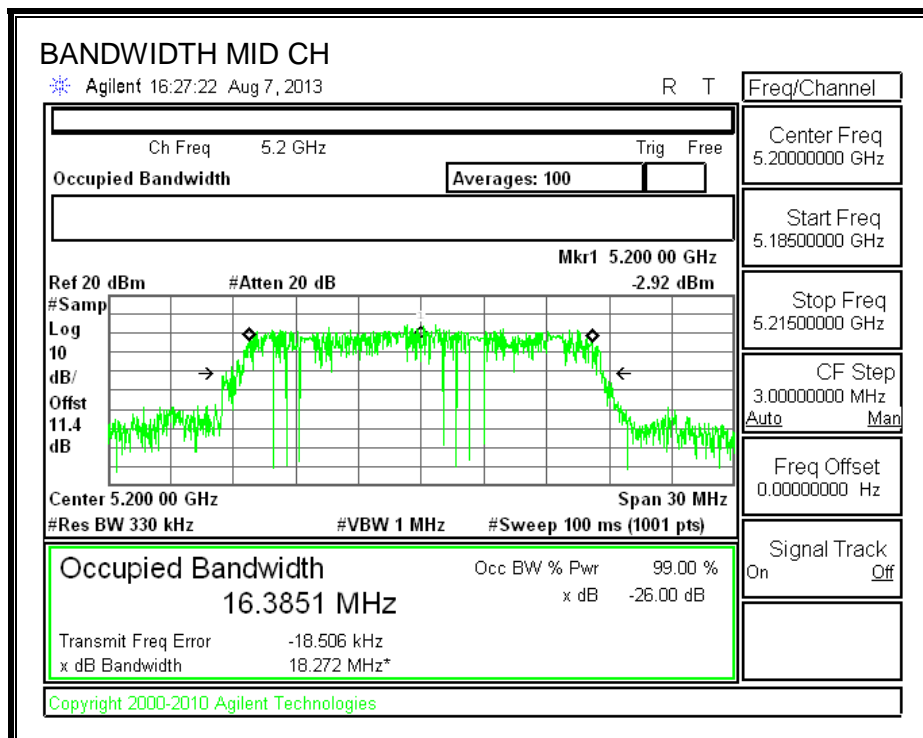
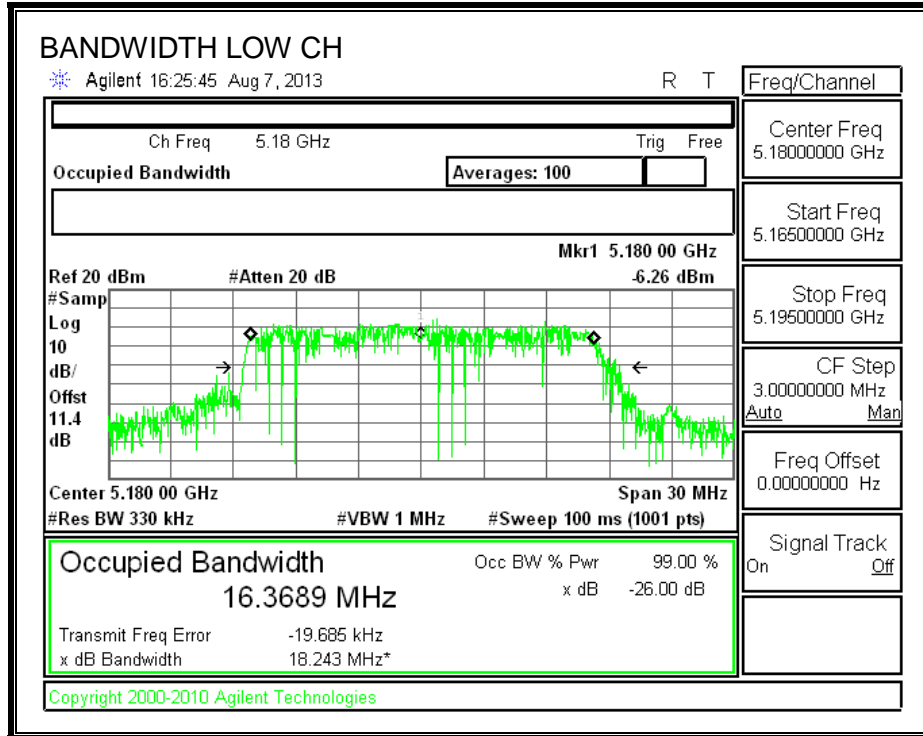

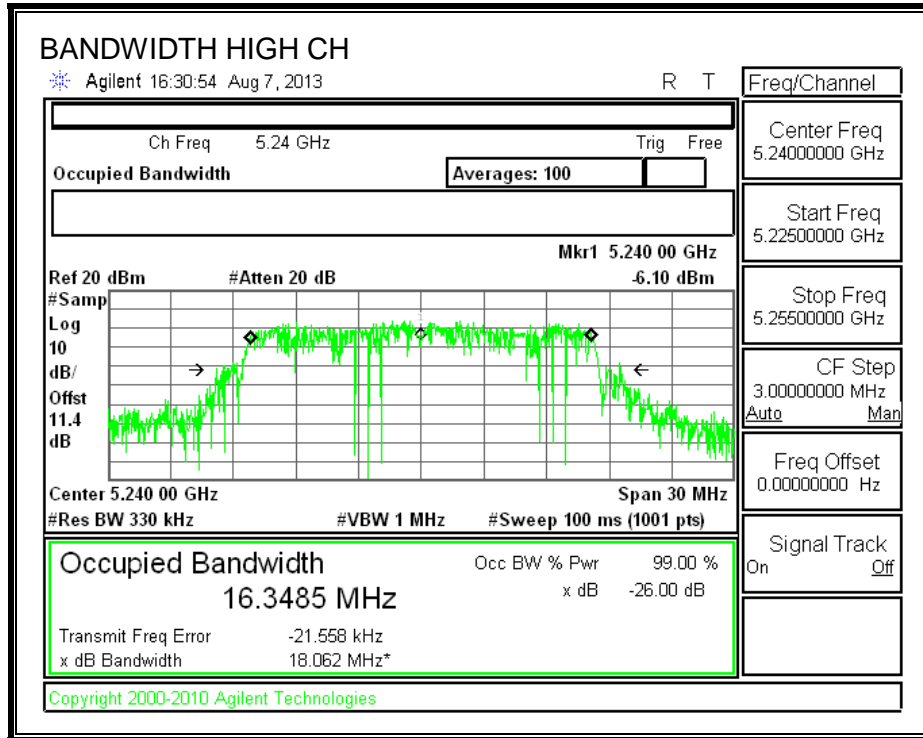



### 8.1.3. AVERAGE POWER

#### LIMITS

None; for reporting purposes only.

#### TEST PROCEDURE

The transmitter output is connected to a power meter.

The cable assembly insertion loss of 11.4 dB (including 10 dB pad and 1.4 dB cable) was entered as an offset in the power meter to allow for direct reading of power.

#### RESULTS

Channel	Frequency (MHz)	Power (dBm)
Low	5180	13.87
Mid	5200	13.85
High	5240	13.88

## **8.1.4. OUTPUT POWER AND PSD**

### **LIMITS**

FCC §15.407 (a) (1)

For the band 5.15–5.25 GHz, the maximum conducted output power over the frequency band of operation shall not exceed the lesser of 50 mW or  $4 \text{ dBm} + 10 \log B$ , where B is the 26–dB emission bandwidth in MHz. In addition, the peak power spectral density shall not exceed 4 dBm in any 1–MHz band. If transmitting antennas of directional gain greater than 6 dBi are used, both the maximum conducted output power and the peak power spectral density shall be reduced by the amount in dB that the directional gain of the antenna exceeds 6 dBi.

IC RSS-210 A9.2 (1)

The maximum e.i.r.p. shall not exceed 200 mW or  $10 + 10 \log_{10} B$ , dBm, whichever power is less. B is the 99% emission bandwidth in MHz. The e.i.r.p. spectral density shall not exceed 10 dBm in any 1.0 MHz band.

### **DIRECTIONAL ANTENNA GAIN**

There is only one transmitter output therefore the directional gain is equal to the antenna gain.

**RESULTS**

**Bandwidth and Antenna Gain**

Channel	Frequency (MHz)	Min 26 dB BW (MHz)	Min 99% BW (MHz)	Directional Gain (dBi)
Low	5180	19.48	16.37	2.37
Mid	5200	19.44	16.39	2.37
High	5240	19.52	16.35	2.37

**Limits**

Channel	Frequency (MHz)	FCC Power Limit (dBm)	IC EIRP Limit (dBm)	Max IC Power (dBm)	Power Limit (dBm)	FCC PSD Limit (dBm)	IC eirp PSD Limit (dBm)	PSD Limit (dBm)
Low	5180	16.90	22.14	19.77	16.90	4.00	10.00	4.00
Mid	5200	16.89	22.14	19.77	16.89	4.00	10.00	4.00
High	5240	16.90	22.13	19.76	16.90	4.00	10.00	4.00

<b>Duty Cycle CF (dB)</b>	0.00	<b>Included in Calculations of Corr'd Power &amp; PSD</b>
---------------------------	------	---

**Output Power Results**

Channel	Frequency (MHz)	Chain 0 Meas Power (dBm)	Total Corr'd Power (dBm)	Power Limit (dBm)	Power Margin (dB)
Low	5180	14.02	14.02	16.90	-2.88
Mid	5200	14.14	14.14	16.89	-2.75
High	5240	14.13	14.13	16.90	-2.77

**PSD Results**

Channel	Frequency (MHz)	Chain 0 Meas PSD (dBm)	Total Corr'd PSD (dBm)	PSD Limit (dBm)	PSD Margin (dB)
Low	5180	3.92	3.92	4.00	-0.08
Mid	5200	3.92	3.92	4.00	-0.08
High	5240	3.99	3.99	4.00	-0.01

**OUTPUT POWER AND PSD, Chain 0**

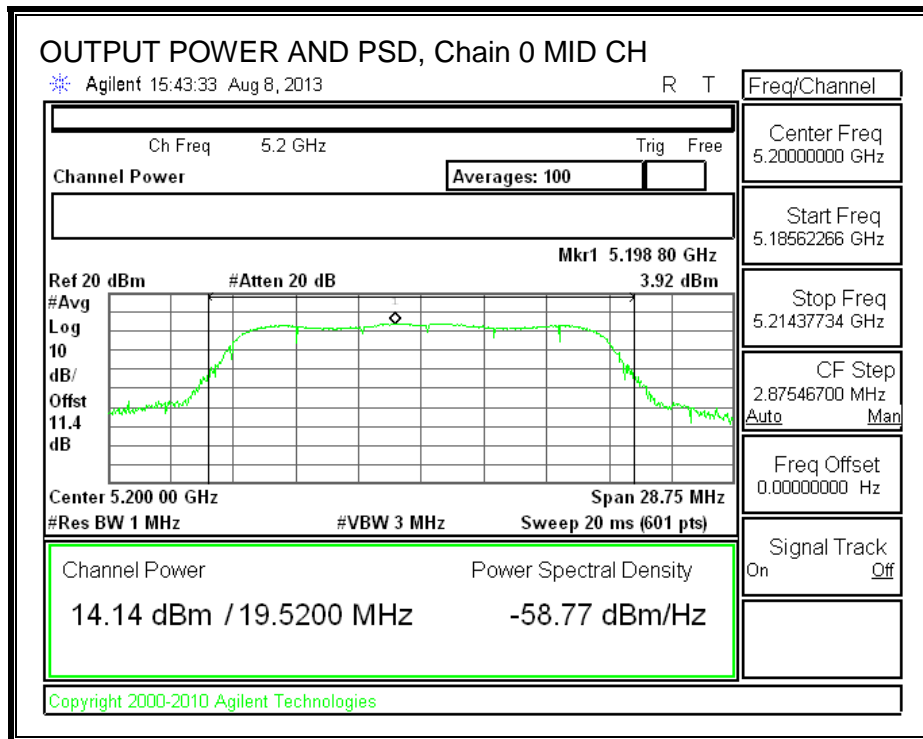
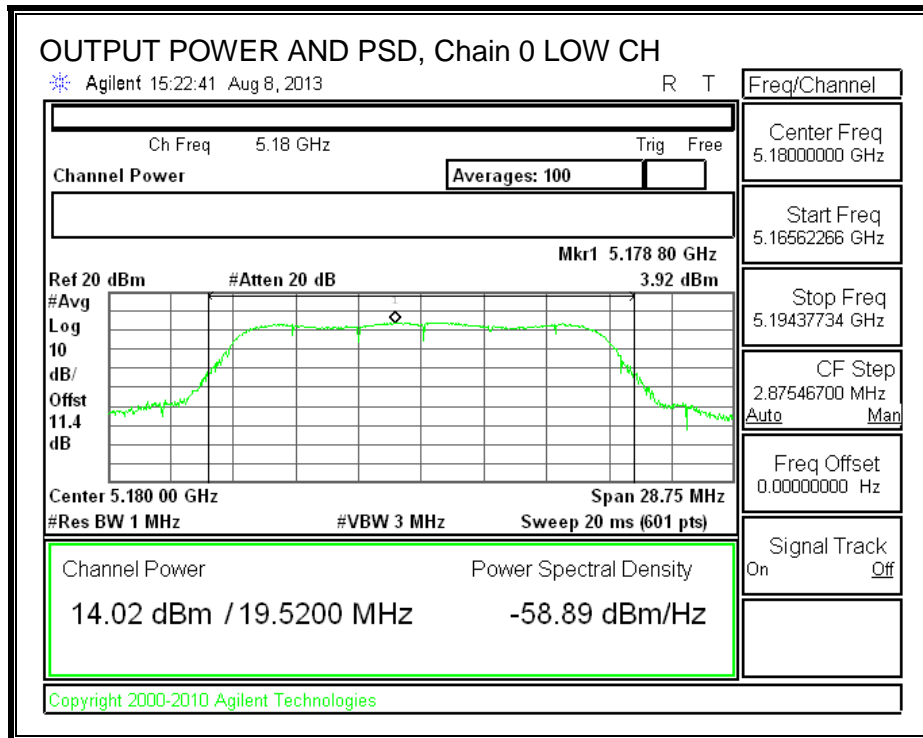

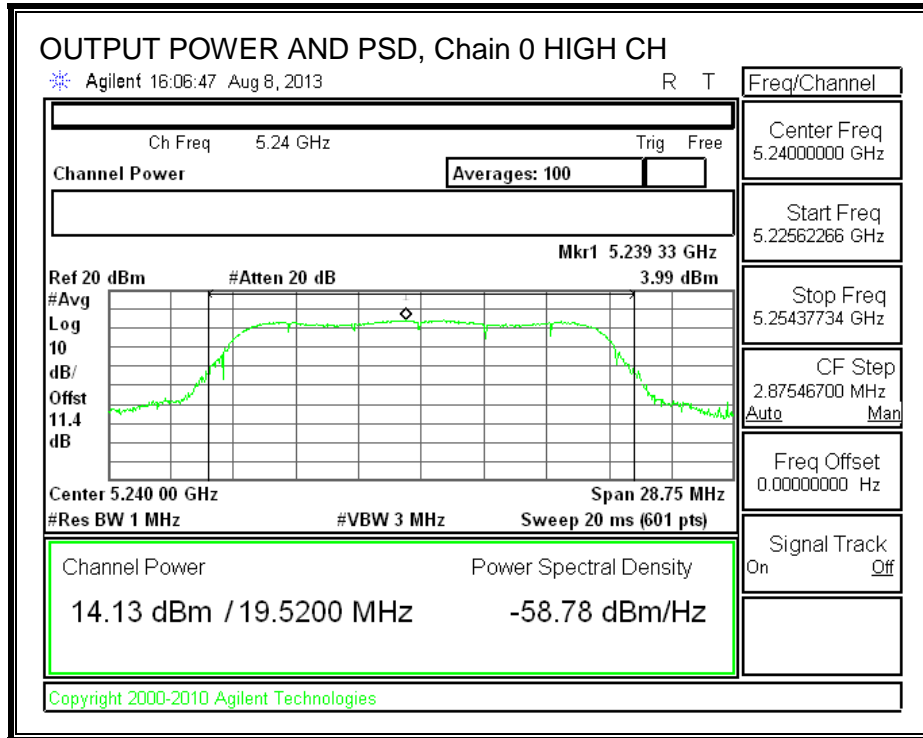

## 8.2. 802.11n HT20 2TX STBC MODE IN THE 5.2 GHz BAND

### 8.2.1. 26 dB BANDWIDTH

#### LIMITS

None; for reporting purposes only.

#### RESULTS

Channel	Frequency (MHz)	26 dB BW Chain 0 (MHz)	26 dB BW Chain 1 (MHz)
Low	5180	19.64	19.56
Mid	5200	19.64	19.56
High	5240	19.72	19.52

**26 dB BANDWIDTH, Chain 0**

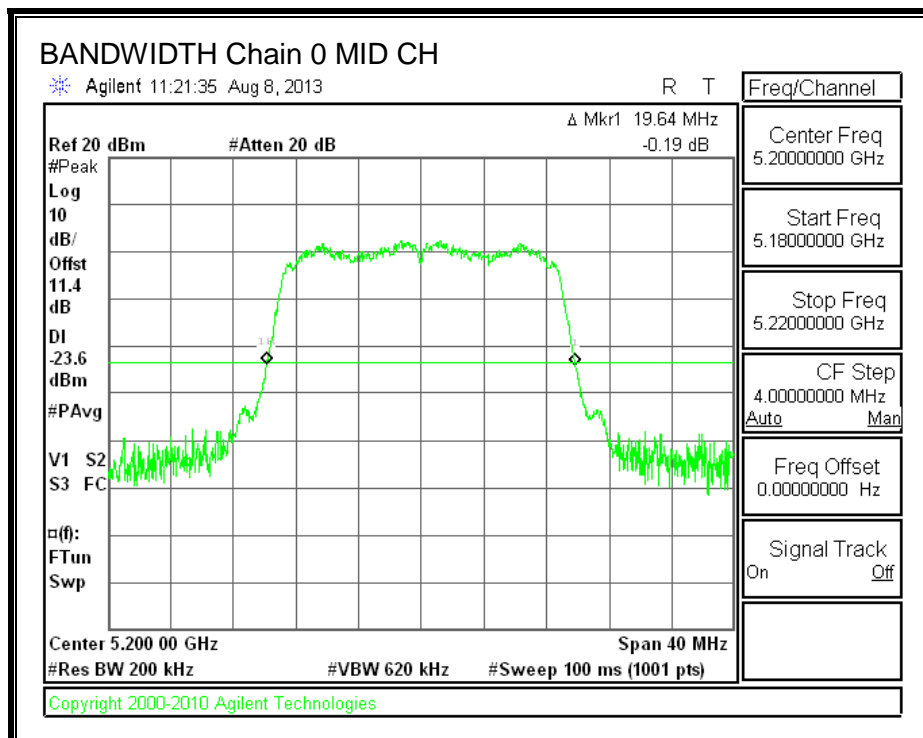
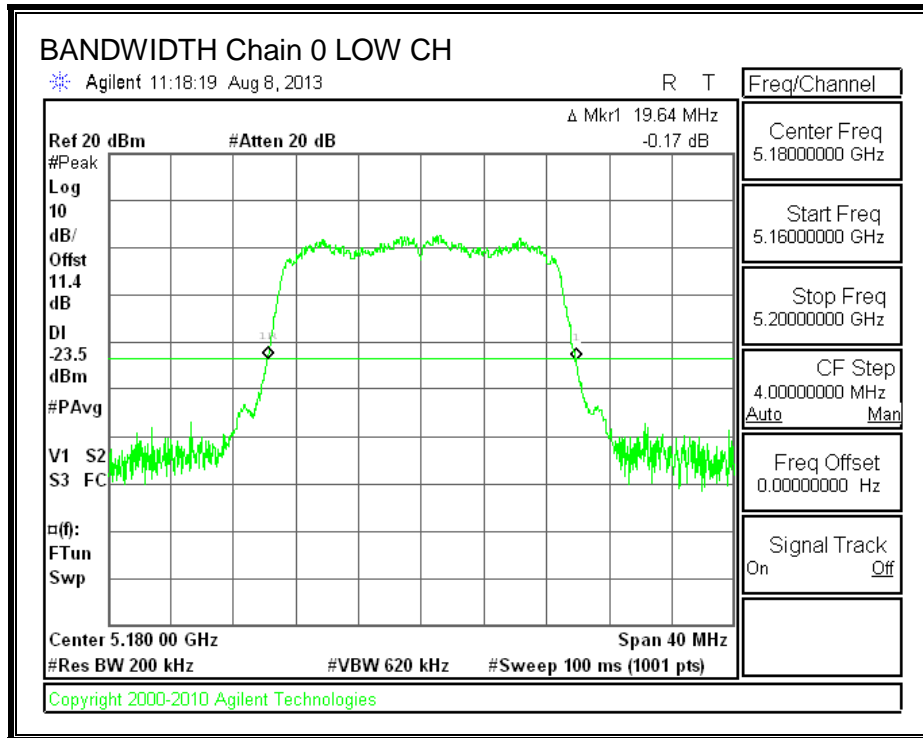

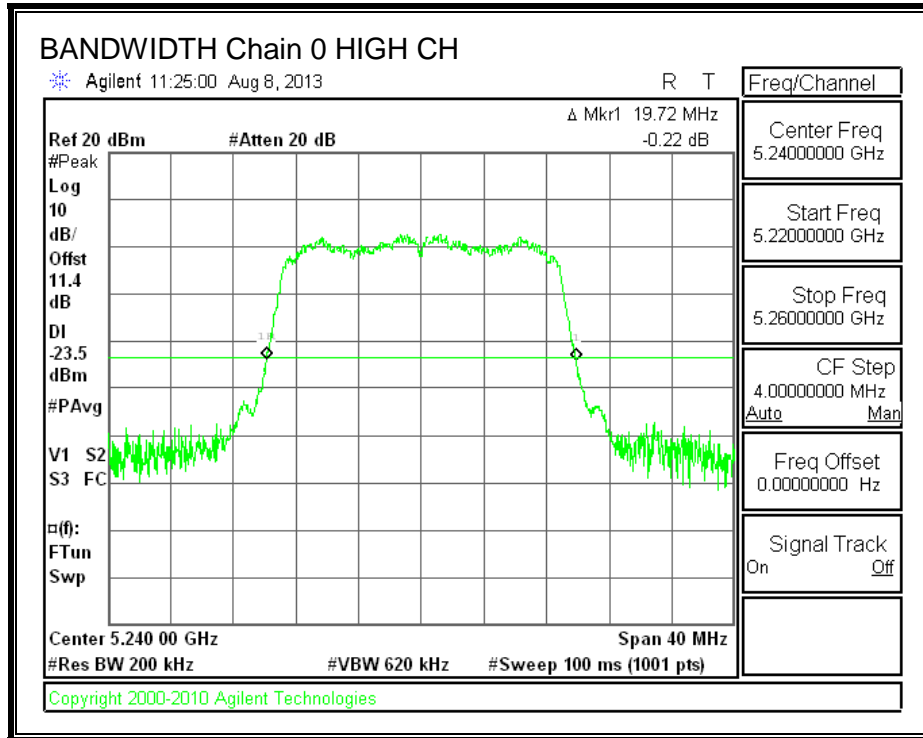

**26 dB BANDWIDTH, Chain 1**

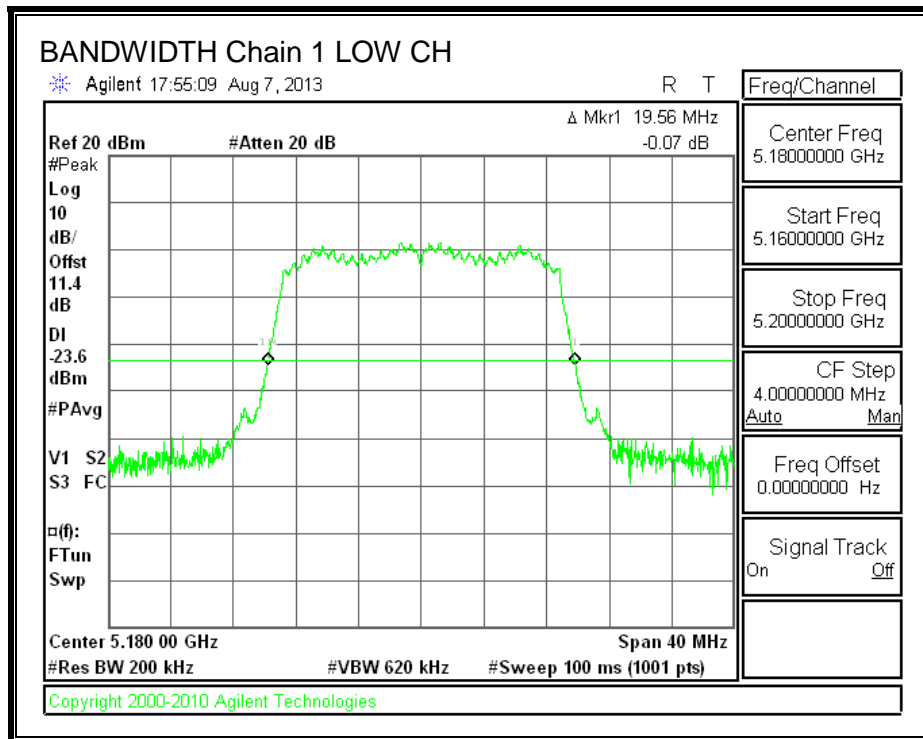



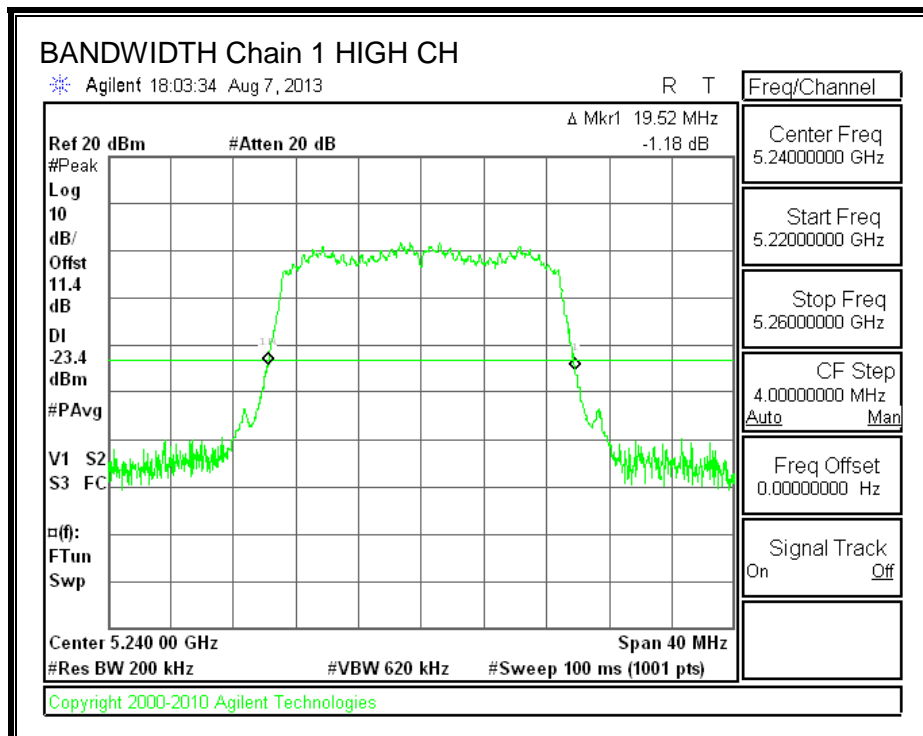
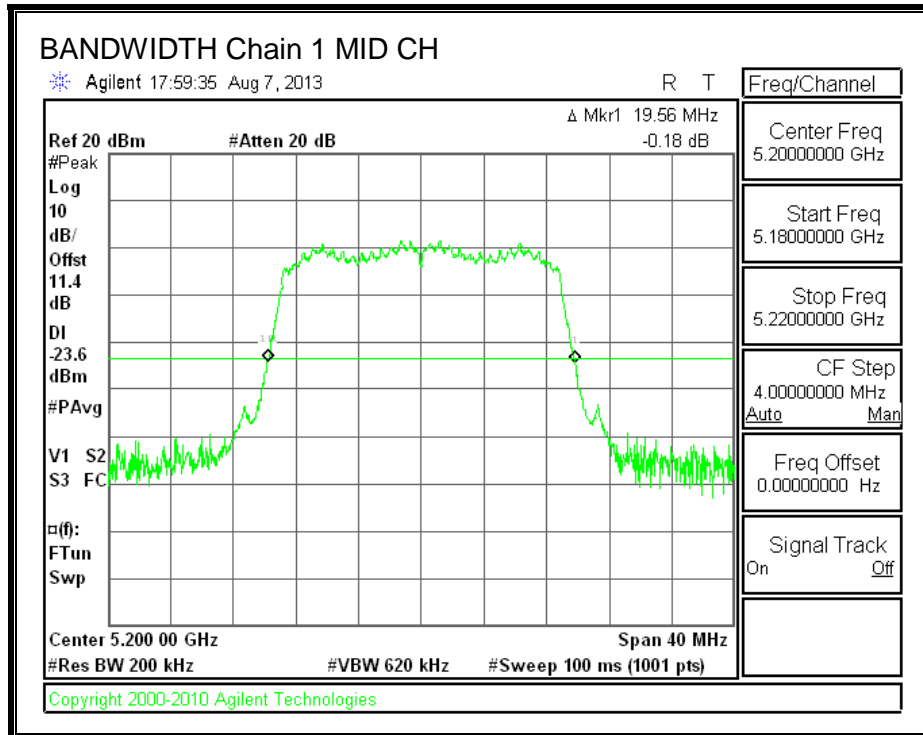

### 8.2.2. 99% BANDWIDTH

#### LIMITS

None; for reporting purposes only.

#### RESULTS

Channel	Frequency (MHz)	99% BW Chain 0 (MHz)	99% BW Chain 1 (MHz)
Low	5180	17.6583	17.6012
Mid	5200	17.6414	17.6420
High	5240	17.6548	17.6297

**99% BANDWIDTH, Chain 0**

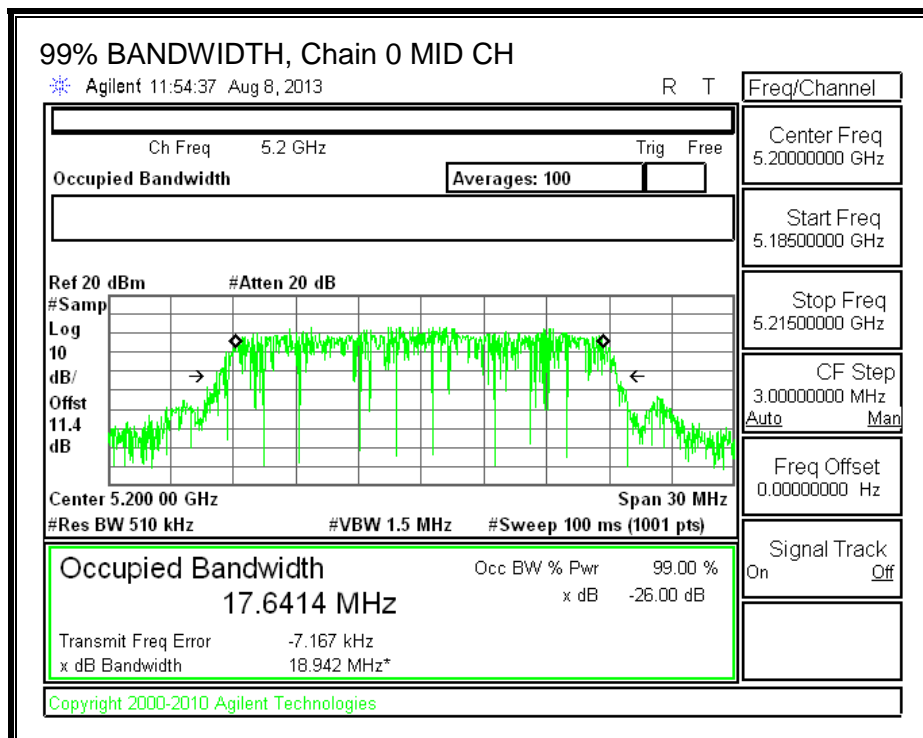
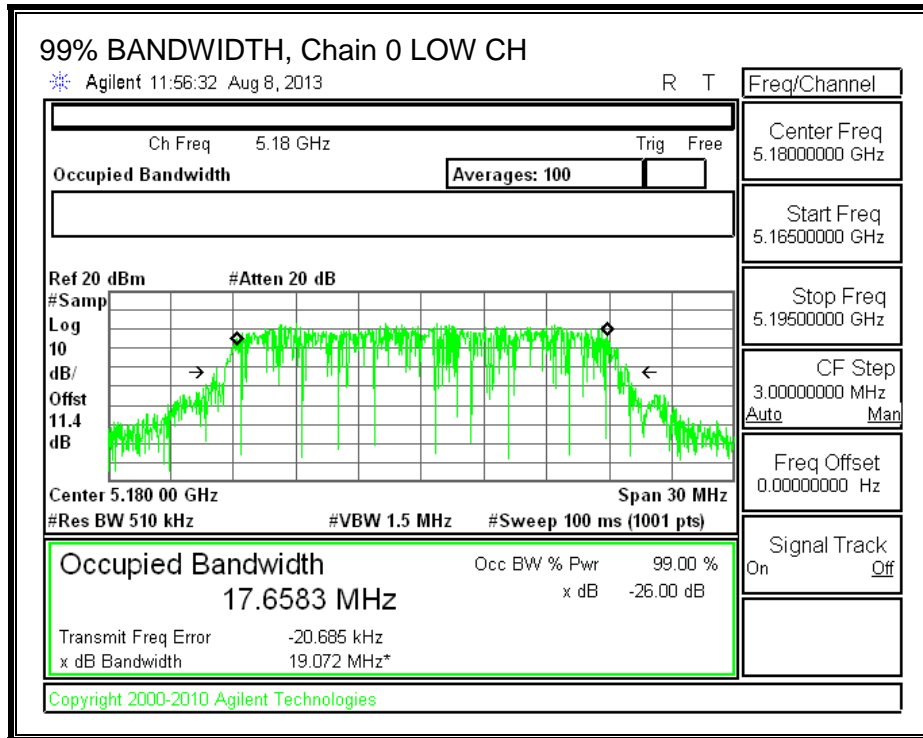

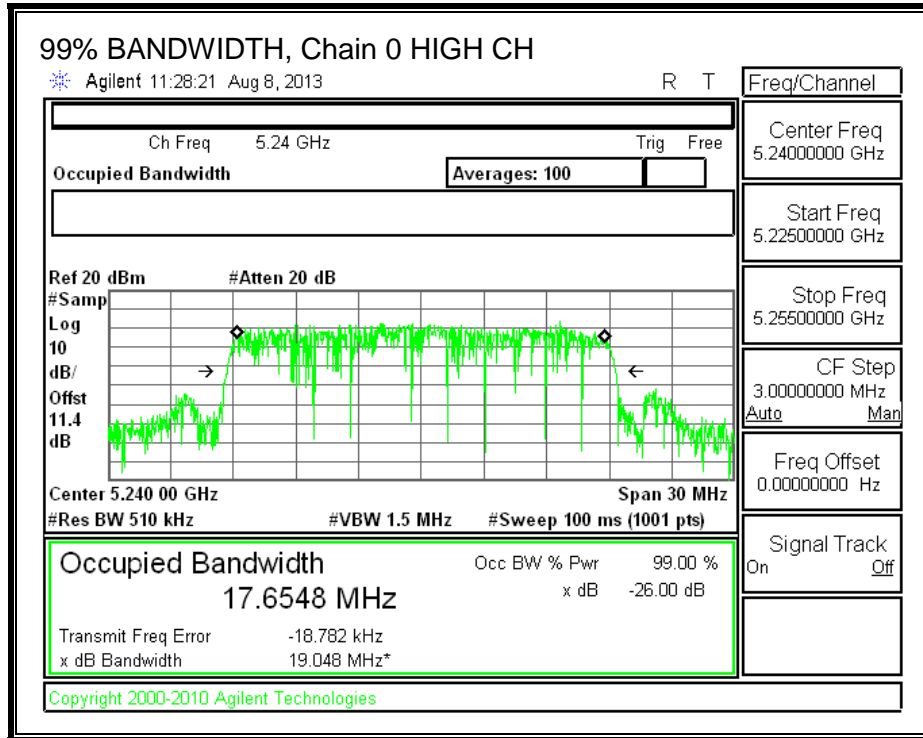

**99% BANDWIDTH, Chain 1**

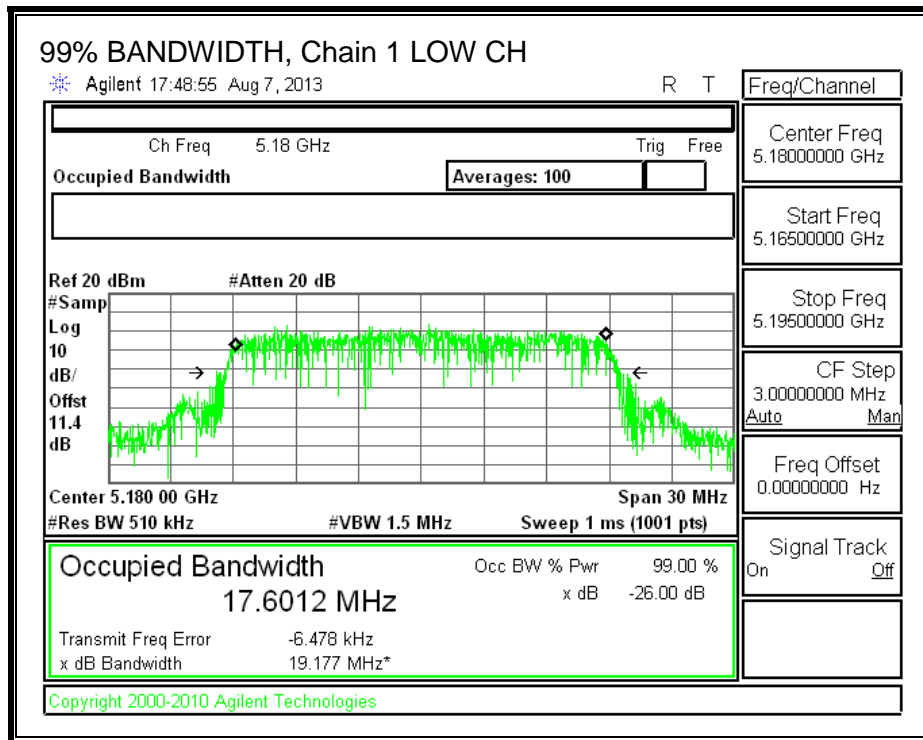

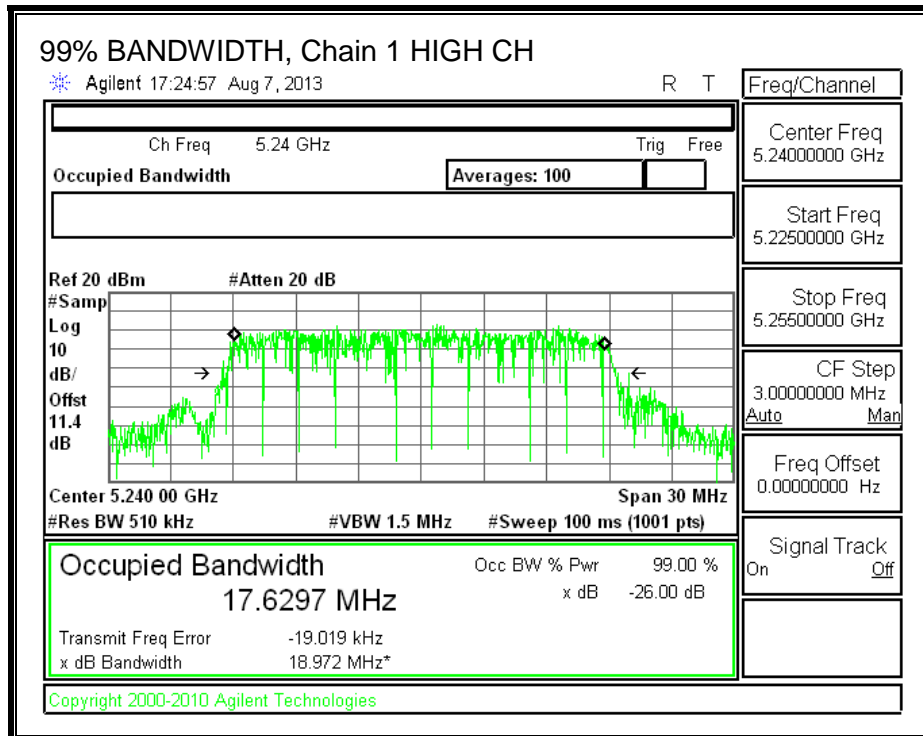
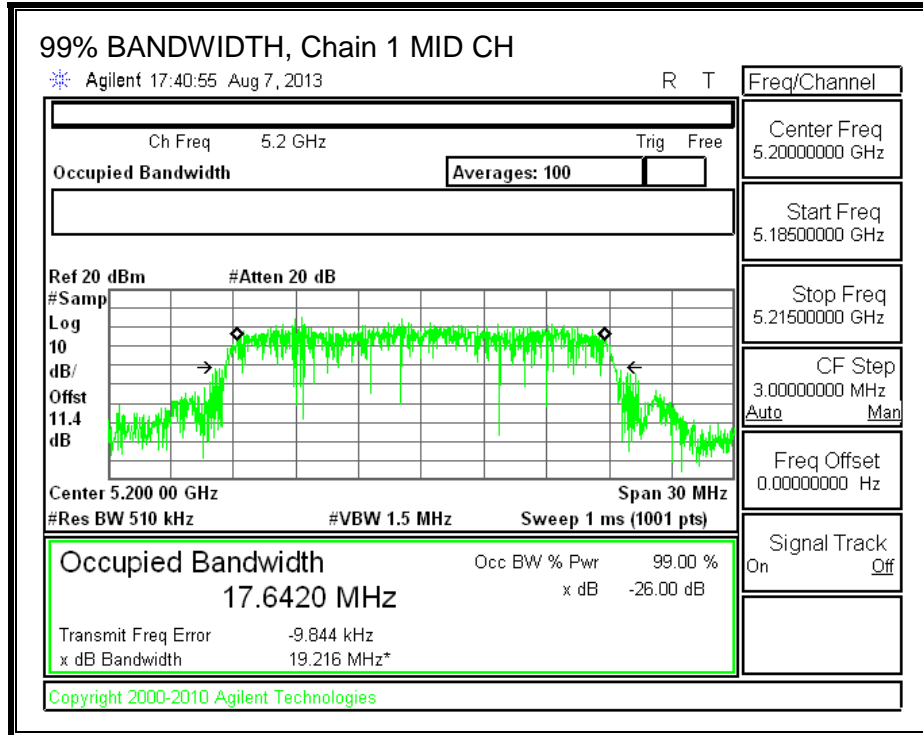

### 8.2.3. AVERAGE POWER

#### LIMITS

None; for reporting purposes only.

#### TEST PROCEDURE

The transmitter output is connected to a power meter.

The cable assembly insertion loss of 11.4 dB (including 10 dB pad and 1.4 dB cable) was entered as an offset in the power meter to allow for direct reading of power.

#### RESULTS

##### Average Power Results

Channel	Frequency (MHz)	Chain 0 Power (dBm)	Chain 1 Power (dBm)	Total Power (dBm)
Low	5180	10.78	10.78	13.79
Mid	5200	10.88	10.77	13.84
High	5240	10.87	10.76	13.83

**8.2.4. OUTPUT POWER AND PPSD**

**LIMITS**

FCC §15.407 (a) (1)

For the band 5.15–5.25 GHz, the maximum conducted output power over the frequency band of operation shall not exceed the lesser of 50 mW or 4 dBm + 10 log B, where B is the 26–dB emission bandwidth in MHz. In addition, the peak power spectral density shall not exceed 4 dBm in any 1–MHz band. If transmitting antennas of directional gain greater than 6 dBi are used, both the maximum conducted output power and the peak power spectral density shall be reduced by the amount in dB that the directional gain of the antenna exceeds 6 dBi.

IC RSS-210 A9.2 (1)

The maximum e.i.r.p. shall not exceed 200 mW or 10 + 10 log<sub>10</sub> B, dBm, whichever power is less. B is the 99% emission bandwidth in MHz. The e.i.r.p. spectral density shall not exceed 10 dBm in any 1.0 MHz band.

**DIRECTIONAL ANTENNA GAIN**

For output power, the TX chains are uncorrelated and the antenna gain is unequal among the chains. The directional gain is:

Chain 0 Antenna Gain (dBi)	Chain 1 Antenna Gain (dBi)	Uncorrelated Chains Directional Gain (dBi)
2.37	2.07	2.22

For PPSD, the TX chains are correlated and the antenna gain is unequal among the chains. The directional gain is:

Chain 0 Antenna Gain (dBi)	Chain 1 Antenna Gain (dBi)	Correlated Chains Directional Gain (dBi)
2.37	2.07	5.23

**RESULTS**

**Bandwidth and Antenna Gain**

Channel	Frequency (MHz)	Min 26 dB BW (MHz)	Min 99% BW (MHz)	Uncorrelated Directional Gain (dBi)
Low	5180	19.56	17.60	2.22
Mid	5200	19.56	17.64	2.22
High	5240	19.52	17.63	2.22

**Limits**

Channel	Frequency (MHz)	FCC Power Limit (dBm)	IC EIRP Limit (dBm)	Max IC Power (dBm)	Power Limit (dBm)	FCC PPSD Limit (dBm)	IC eirp PSD Limit (dBm)	PPSD Limit (dBm)
Low	5180	16.91	22.46	20.24	16.91	4.00	10.00	4.00
Mid	5200	16.91	22.47	20.25	16.91	4.00	10.00	4.00
High	5240	16.90	22.46	20.24	16.90	4.00	10.00	4.00

<b>Duty Cycle CF (dB)</b>	0.00	<b>Included in Calculations of Corr'd Power &amp; PPSD</b>
---------------------------	------	--

**Output Power Results**

Channel	Frequency (MHz)	Chain 0 Meas Power (dBm)	Chain 1 Meas Power (dBm)	Total Corr'd Power (dBm)	Power Limit (dBm)	Power Margin (dB)
Low	5180	10.89	10.94	13.93	16.91	-2.99
Mid	5200	10.92	10.87	13.90	16.91	-3.01
High	5240	11.13	10.84	14.00	16.90	-2.91

**PPSD Results**

Channel	Frequency (MHz)	Chain 0 Meas PPSD (dBm)	Chain 1 Meas PPSD (dBm)	Total Corr'd PPSD (dBm)	PPSD Limit (dBm)	PPSD Margin (dB)
Low	5180	-0.21	-0.82	2.50	4.00	-1.50
Mid	5200	1.02	-1.09	3.10	4.00	-0.90
High	5240	-0.24	-1.03	2.40	4.00	-1.60



**OUTPUT POWER AND PPSD, Chain 0**

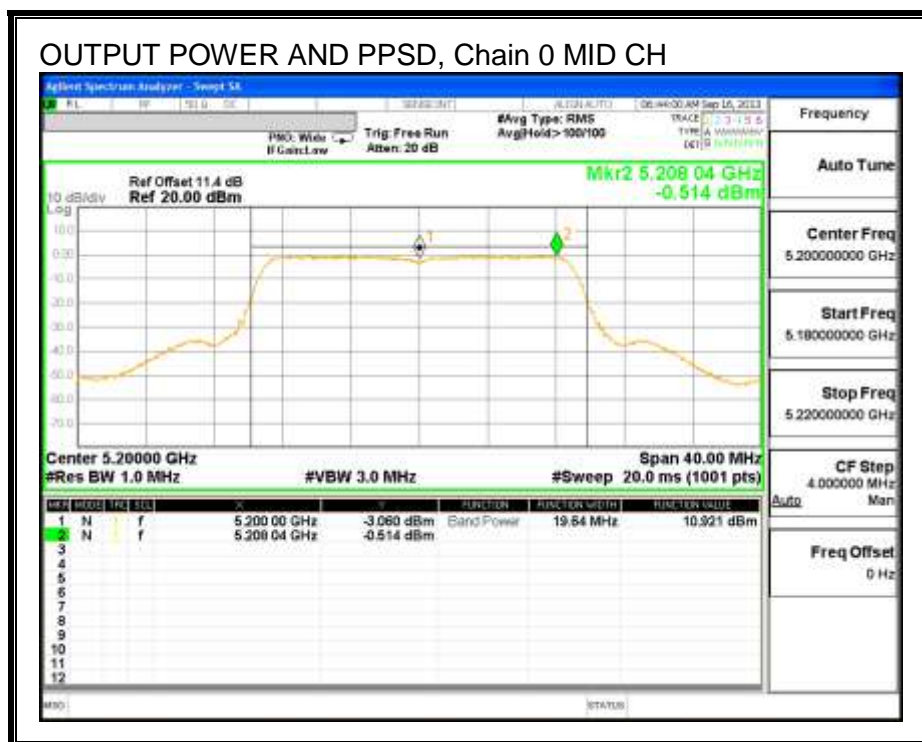
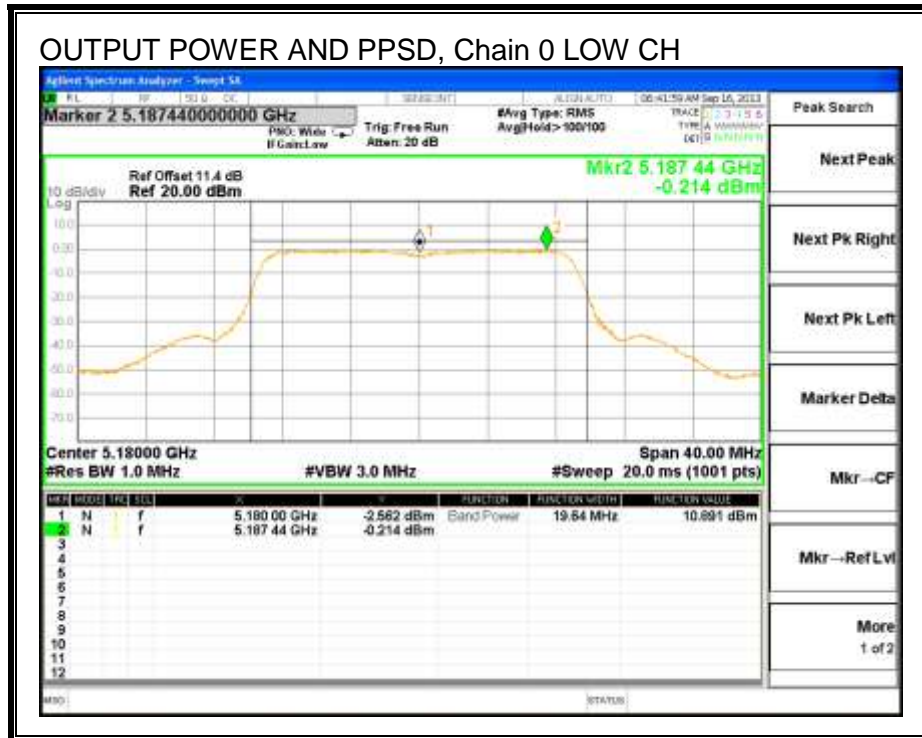

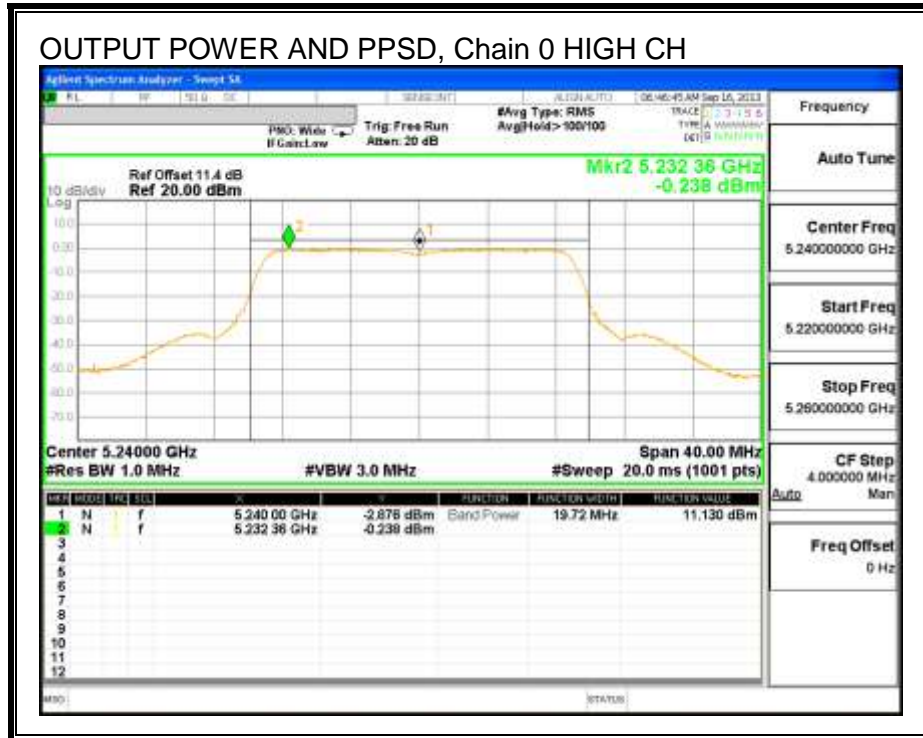

**OUTPUT POWER AND PPSD, Chain 1**

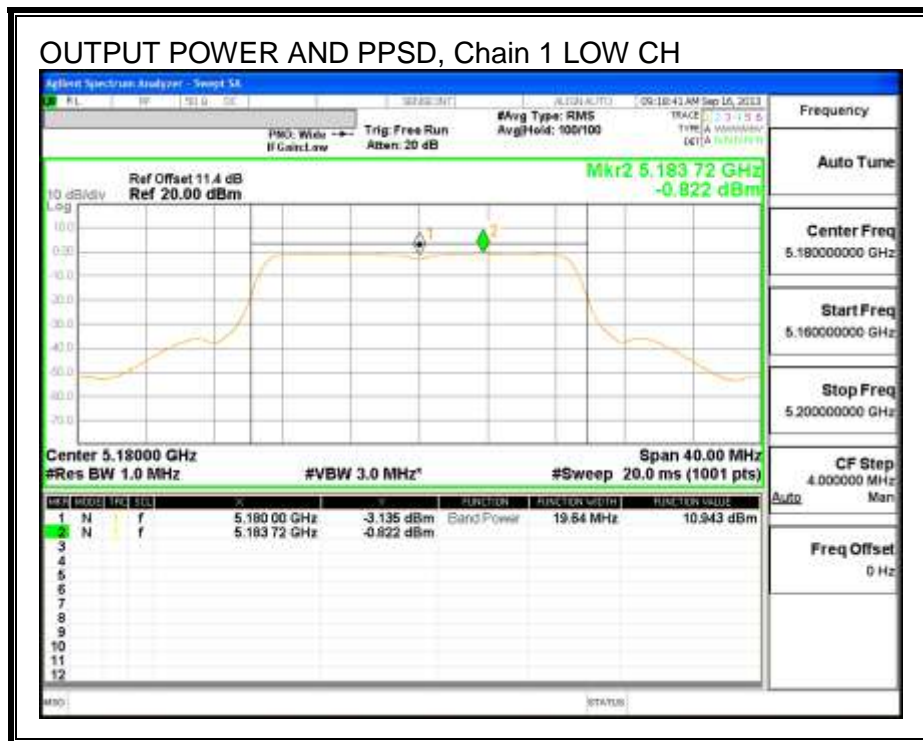

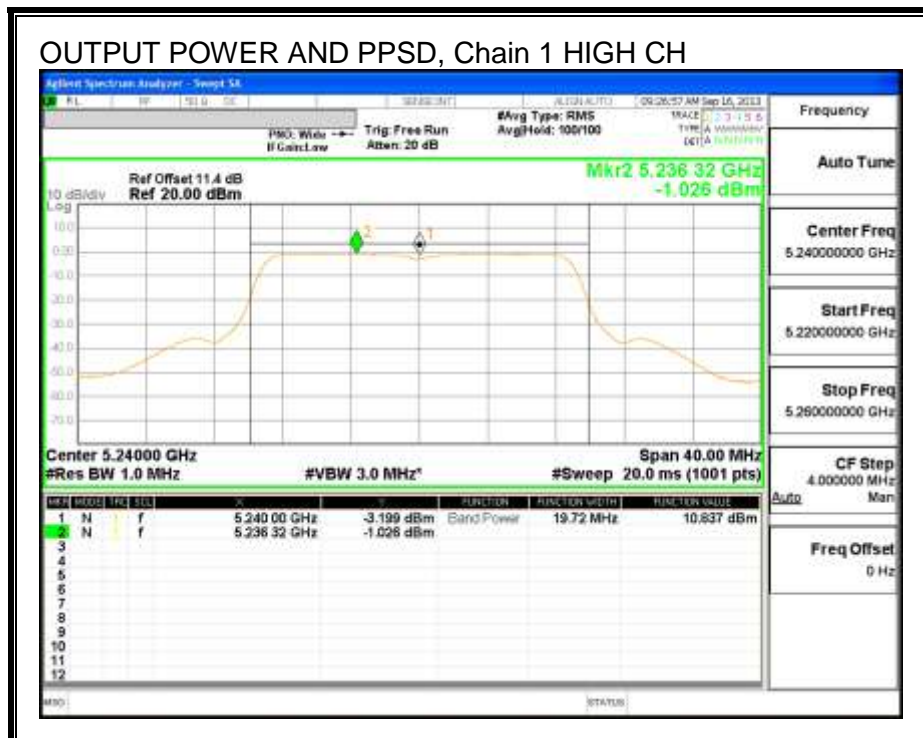
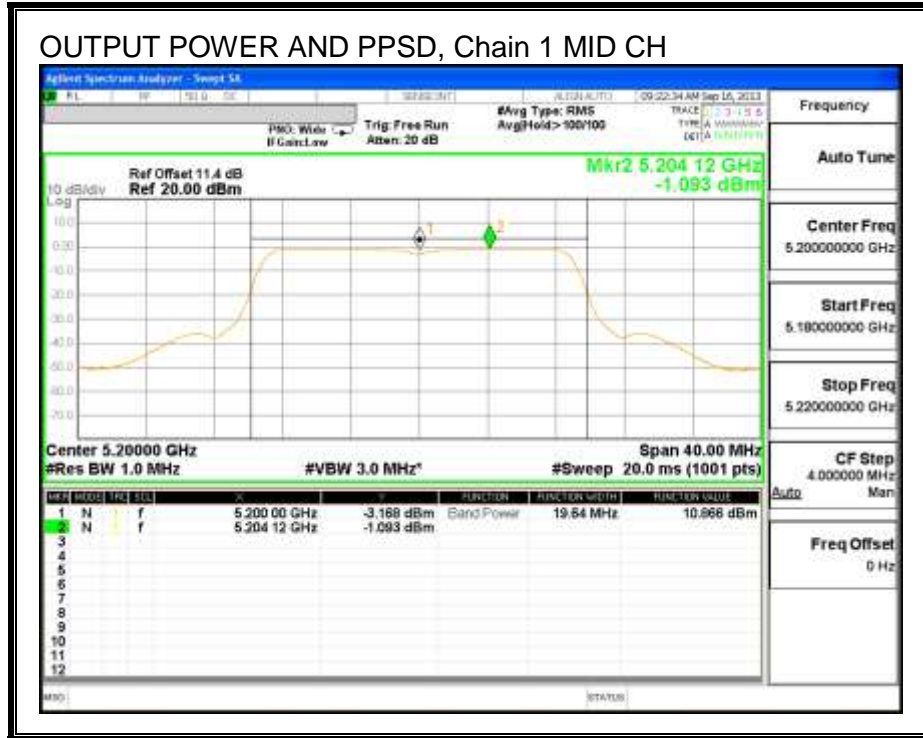

### 8.3. 802.11n HT20 2TX CDD MODE IN THE 5.2 GHZ BAND

#### 8.3.1. 26 dB BANDWIDTH

##### LIMITS

None; for reporting purposes only.

##### RESULTS

Channel	Frequency (MHz)	26 dB BW Chain 0 (MHz)	26 dB BW Chain 1 (MHz)
Low	5180	20.60	20.52
Mid	5200	20.72	20.76
High	5240	20.68	20.52

**26 dB BANDWIDTH, Chain 0**

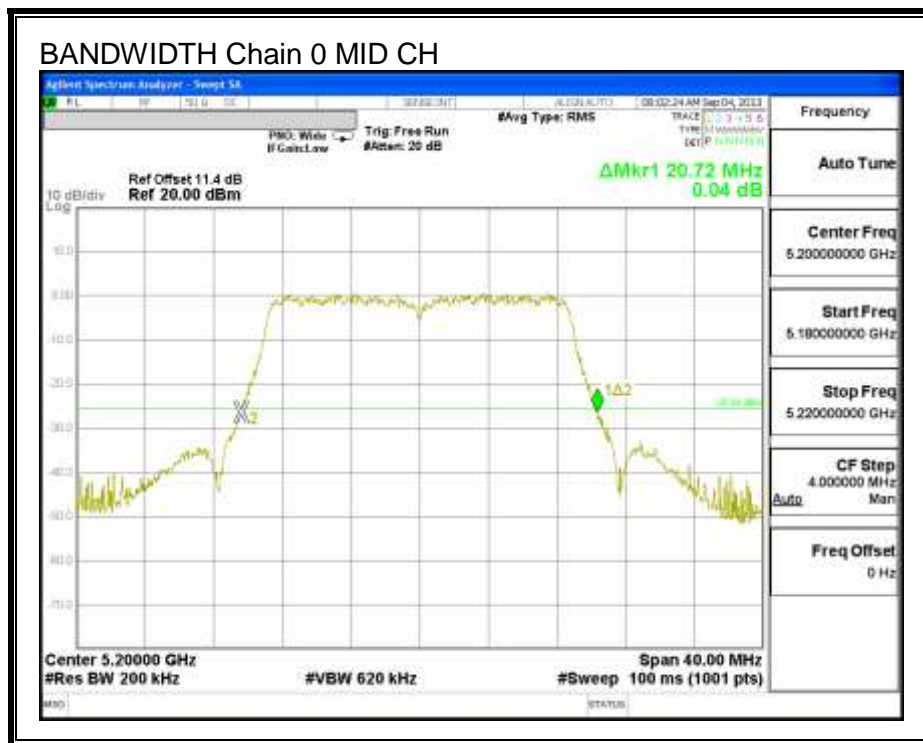
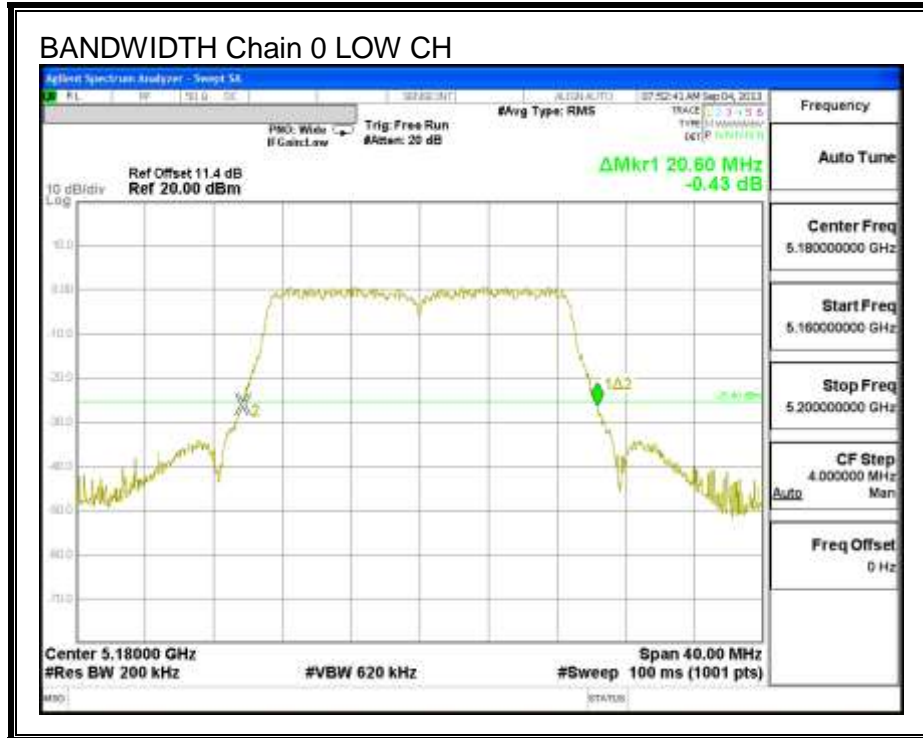

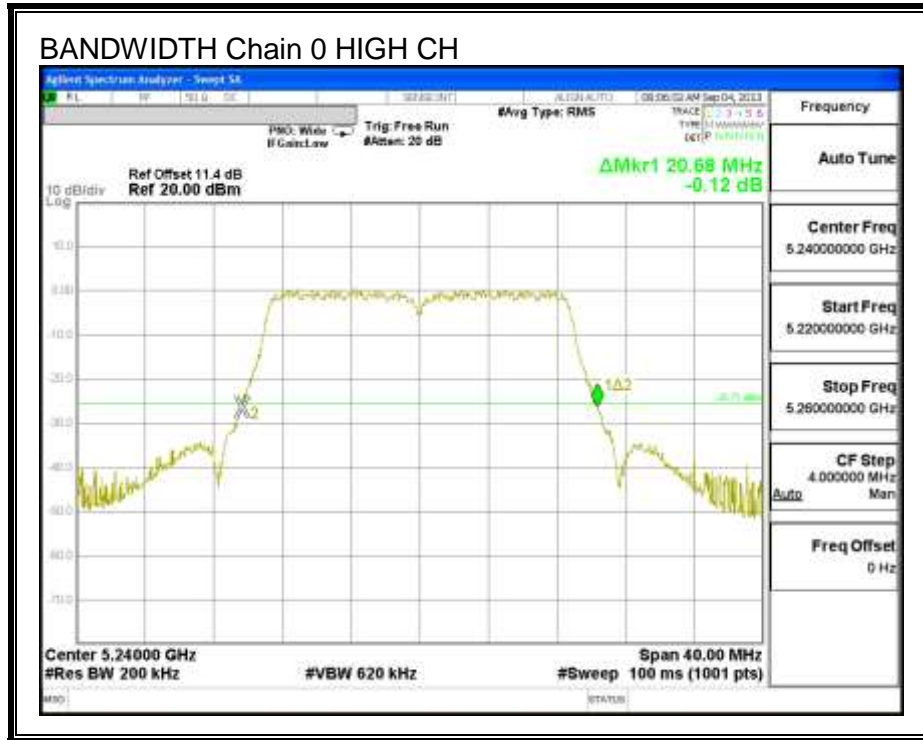

**26 dB BANDWIDTH, Chain 1**

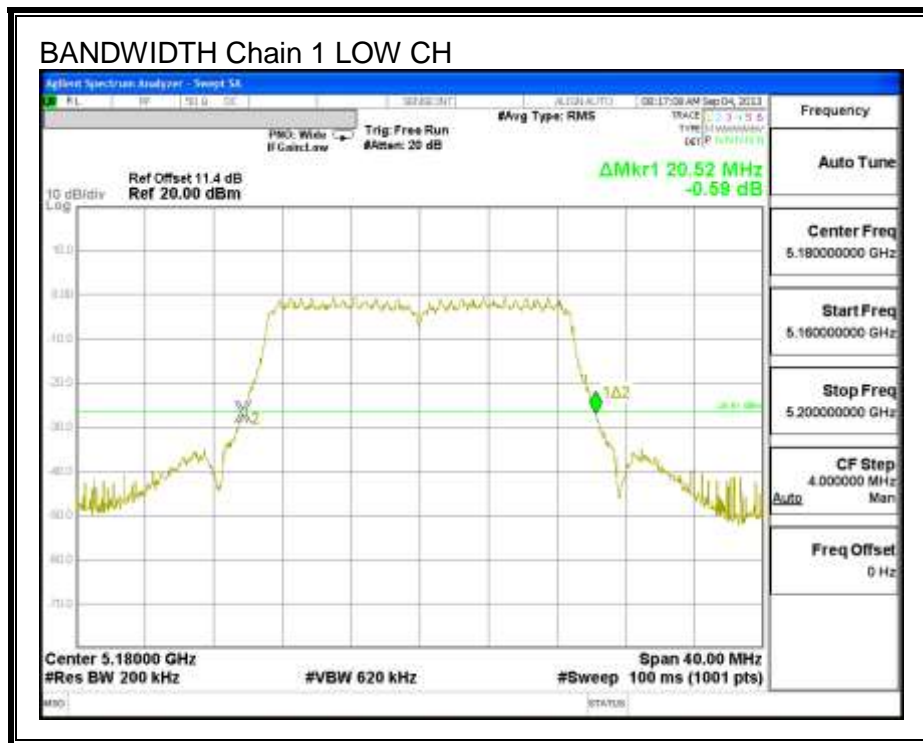



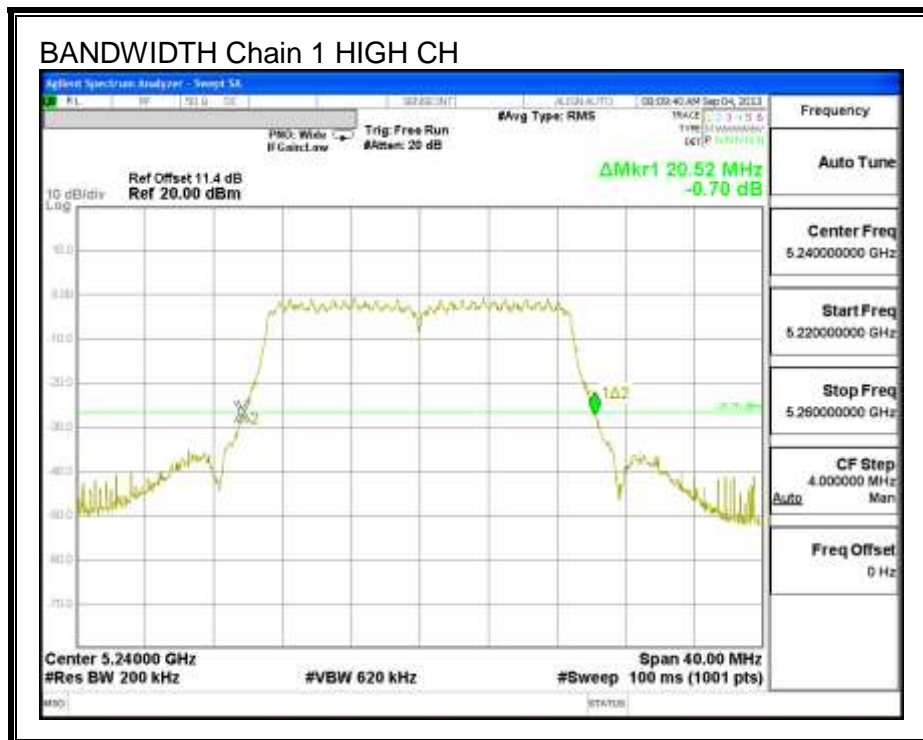
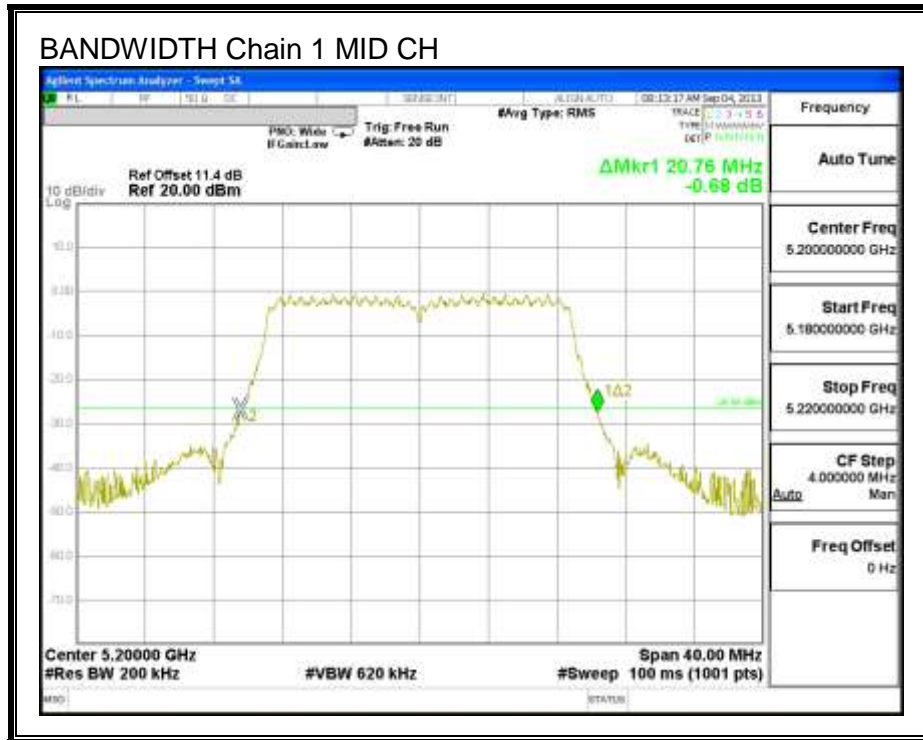

### 8.3.2. AVERAGE POWER

#### LIMITS

None; for reporting purposes only.

#### TEST PROCEDURE

The transmitter output is connected to a power meter.

The cable assembly insertion loss of 11.4 dB (including 10 dB pad and 1.4 dB cable) was entered as an offset in the power meter to allow for direct reading of power.

#### RESULTS

##### Power Results

Frequency (MHz)	Chain 0 Power (dBm)	Chain 1 Power (dBm)	Total Power (dBm)
5180	10.24	10.23	13.25
5200	10.32	10.28	13.31
5240	10.36	10.47	13.43



### 8.3.3. OUTPUT POWER AND PPSD

#### LIMITS

FCC §15.407 (a) (1)

For the band 5.15–5.25 GHz, the maximum conducted output power over the frequency band of operation shall not exceed the lesser of 50 mW or 4 dBm + 10 log B, where B is the 26–dB emission bandwidth in MHz. In addition, the peak power spectral density shall not exceed 4 dBm in any 1–MHz band. If transmitting antennas of directional gain greater than 6 dBi are used, both the maximum conducted output power and the peak power spectral density shall be reduced by the amount in dB that the directional gain of the antenna exceeds 6 dBi.

IC RSS-210 A9.2 (1)

The maximum e.i.r.p. shall not exceed 200 mW or 10 + 10 log<sub>10</sub> B, dBm, whichever power is less. B is the 99% emission bandwidth in MHz. The e.i.r.p. spectral density shall not exceed 10 dBm in any 1.0 MHz band.

#### DIRECTIONAL ANTENNA GAIN

For output power, the TX chains are uncorrelated and the antenna gain is unequal among the chains. The directional gain is:

Chain 0 Antenna Gain (dBi)	Chain 1 Antenna Gain (dBi)	Uncorrelated Chains Directional Gain (dBi)
2.37	2.07	2.22

For PPSD, the TX chains are correlated and the antenna gain is unequal among the chains. The directional gain is:

Chain 0 Antenna Gain (dBi)	Chain 1 Antenna Gain (dBi)	Correlated Chains Directional Gain (dBi)
2.37	2.07	5.23

**RESULTS**

**Bandwidth and Antenna Gain**

Channel	Frequency (MHz)	Min 26 dB BW (MHz)	Min 99% BW (MHz)	Uncorrelated Directional Gain (dBi)	Correlated Directional Gain (dBi)
Low	5180	20.52	17.60	2.22	5.23
Mid	5200	20.76	17.64	2.22	5.23
High	5240	20.52	17.63	2.22	5.23

**Limits**

Channel	Frequency (MHz)	FCC Power Limit (dBm)	IC EIRP Limit (dBm)	Max IC Power (dBm)	Power Limit (dBm)	FCC PPSD Limit (dBm)	IC eirp PSD Limit (dBm)	PPSD Limit (dBm)
Low	5180	17.00	22.46	20.24	17.00	4.00	10.00	4.00
Mid	5200	17.00	22.47	20.25	17.00	4.00	10.00	4.00
High	5240	17.00	22.46	20.24	17.00	4.00	10.00	4.00

<b>Duty Cycle CF (dB)</b>	0.00	<b>Included in Calculations of Corr'd Power &amp; PPSP</b>
---------------------------	------	--

**Output Power Results**

Channel	Frequency (MHz)	Chain 0 Meas Power (dBm)	Chain 1 Meas Power (dBm)	Total Corr'd Power (dBm)	Power Limit (dBm)	Power Margin (dB)
Low	5180	10.48	10.34	13.42	17.00	-3.58
Mid	5200	10.37	10.37	13.38	17.00	-3.62
High	5240	10.53	10.48	13.52	17.00	-3.48

**PPSD Results**

Channel	Frequency (MHz)	Chain 0 Meas PPSD (dBm)	Chain 1 Meas PPSD (dBm)	Total Corr'd PPSD (dBm)	PPSD Limit (dBm)	PPSD Margin (dB)
Low	5180	-0.56	-1.49	2.01	4.00	-1.99
Mid	5200	-3.44	-1.49	0.65	4.00	-3.35
High	5240	-3.30	-1.38	0.78	4.00	-3.22

**OUTPUT POWER AND PPSD, Chain 0**

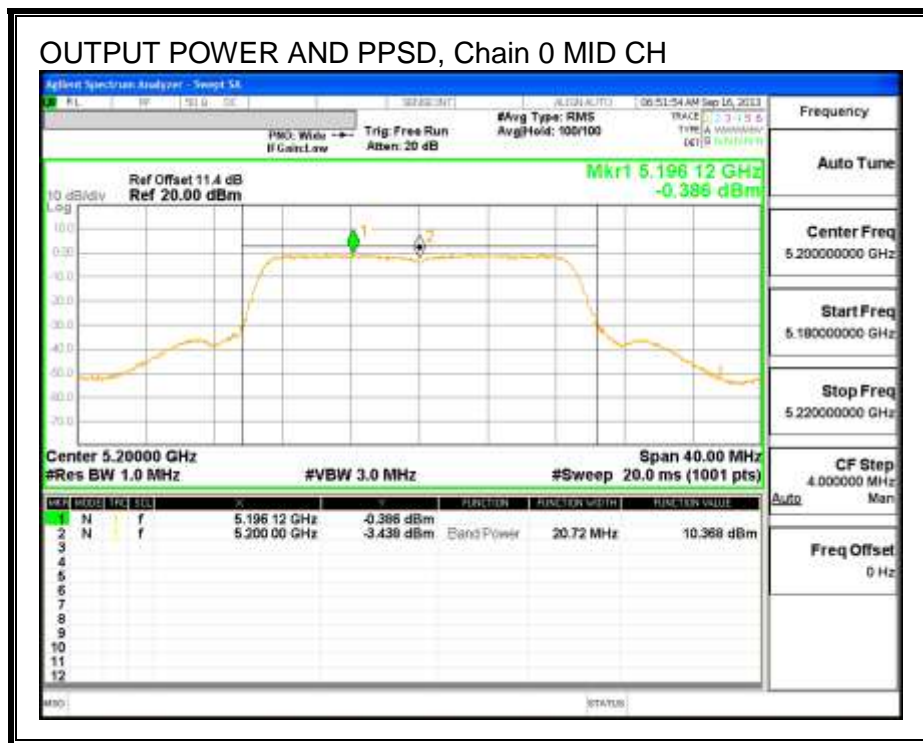
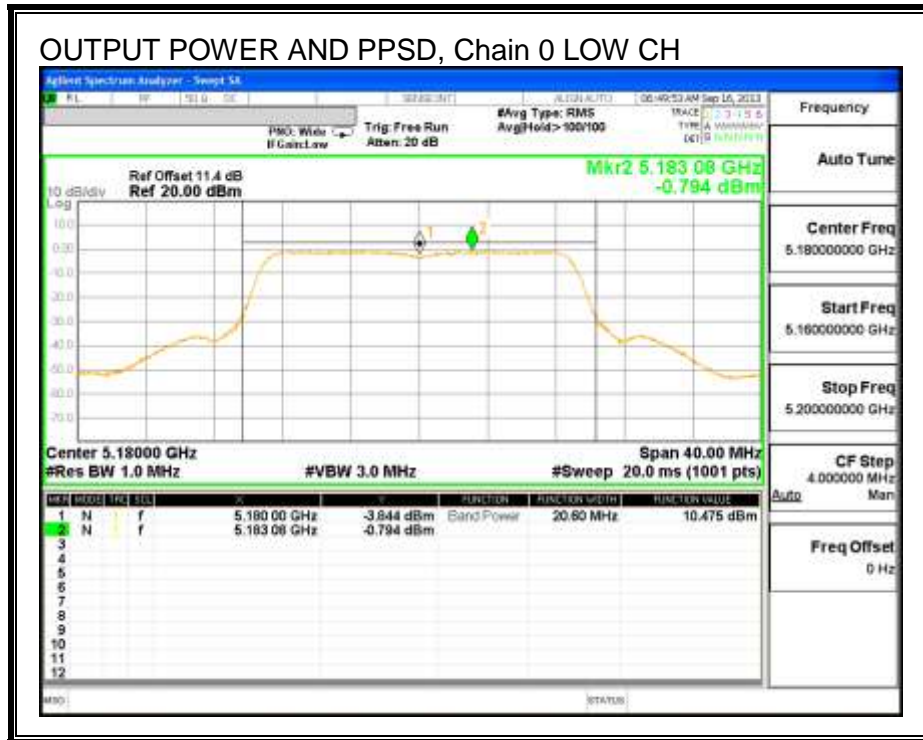

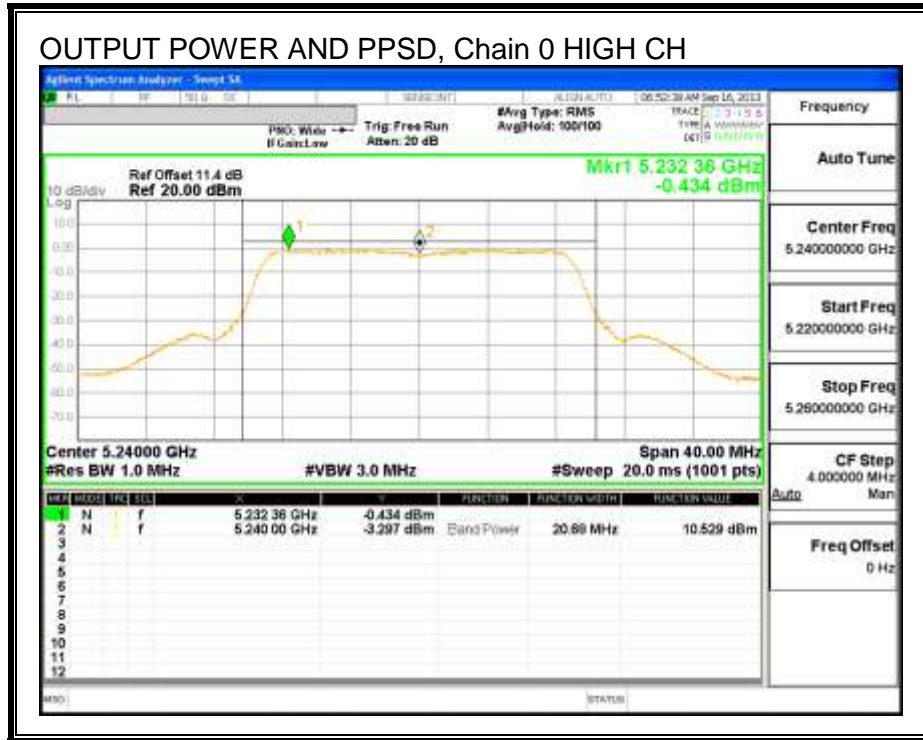

### OUTPUT POWER AND PPSD, Chain 1

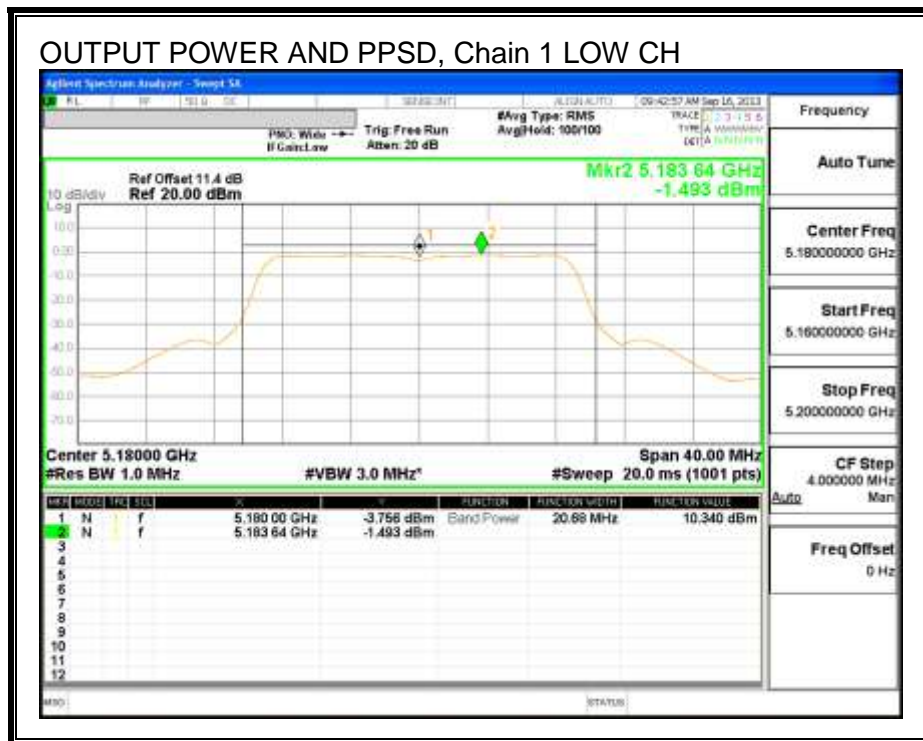

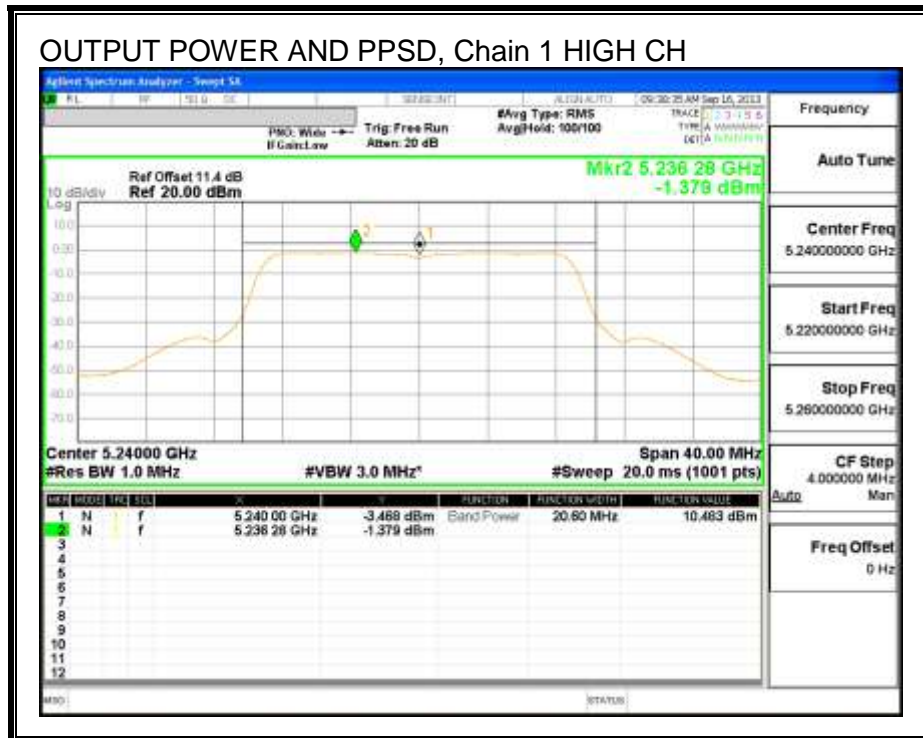
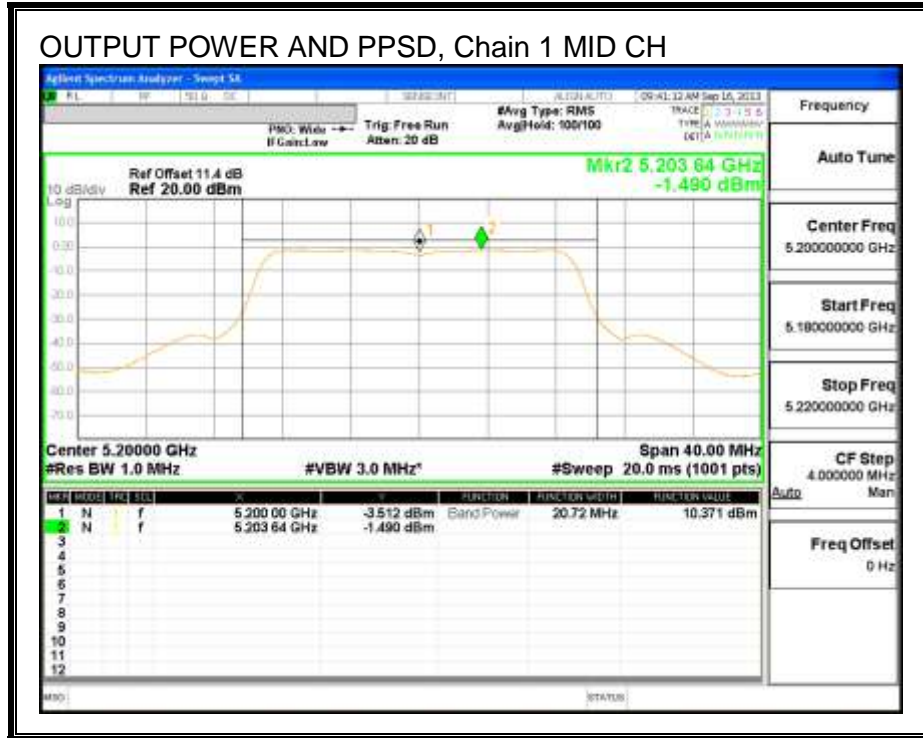

## 8.4. 802.11n HT40 SISO MODE IN THE 5.2 GHz BAND

### 8.4.1. 26 dB BANDWIDTH

#### LIMITS

None; for reporting purposes only.

#### RESULTS

Channel	Frequency (MHz)	26 dB Bandwidth (MHz)
Low	5190	40.14
High	5230	40.14

**26 dB BANDWIDTH**

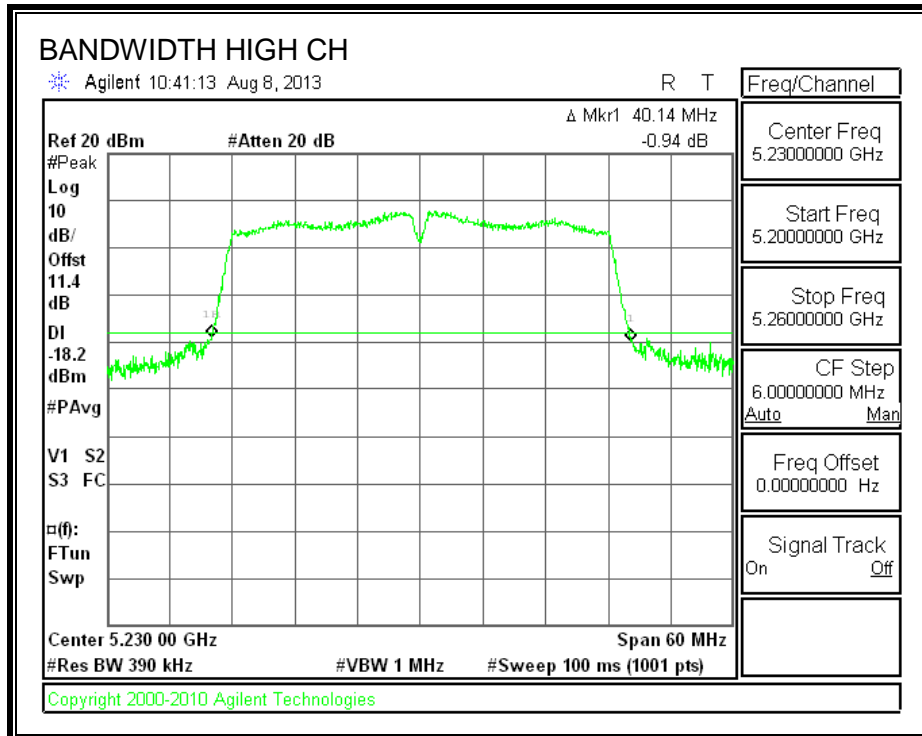
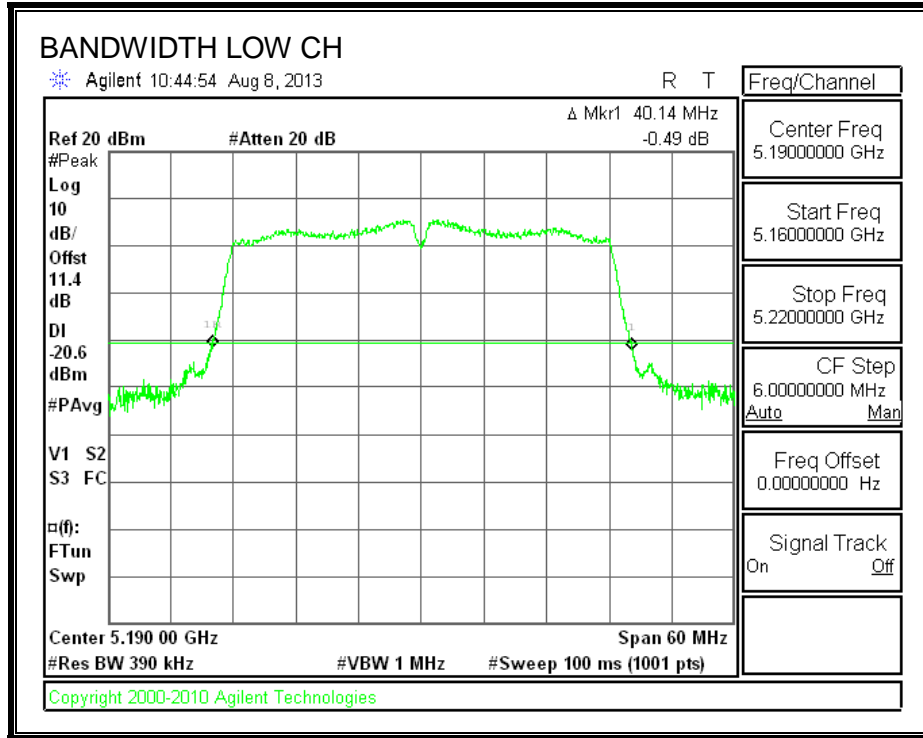

### 8.4.2. 99% BANDWIDTH

#### LIMITS

None; for reporting purposes only.

#### RESULTS

Channel	Frequency (MHz)	99% Bandwidth (MHz)
Low	5190	36.3445
High	5230	36.3971



**99% BANDWIDTH**

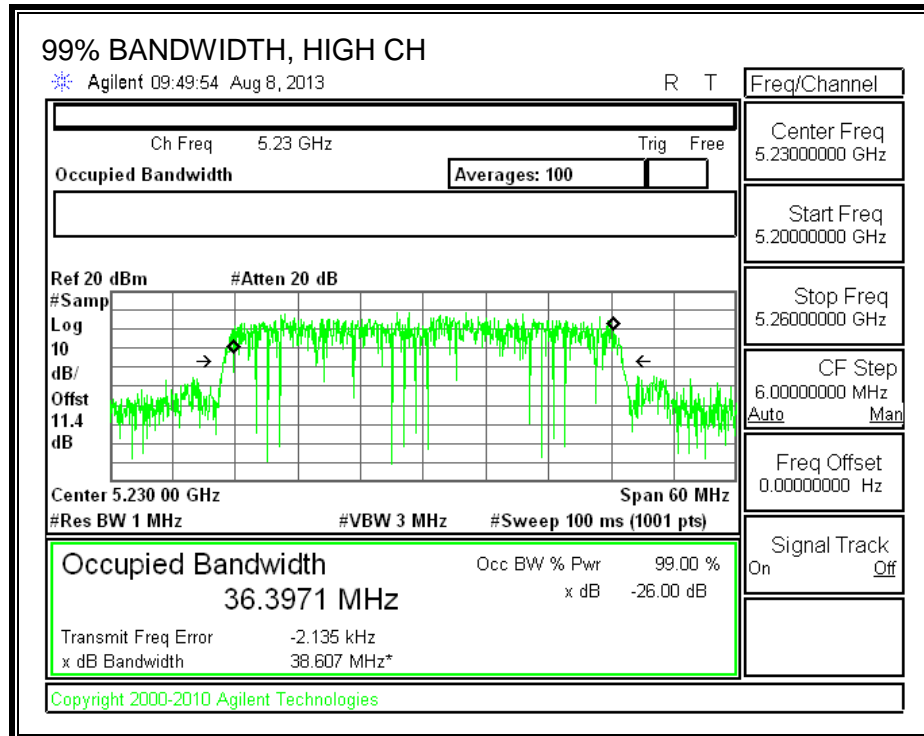
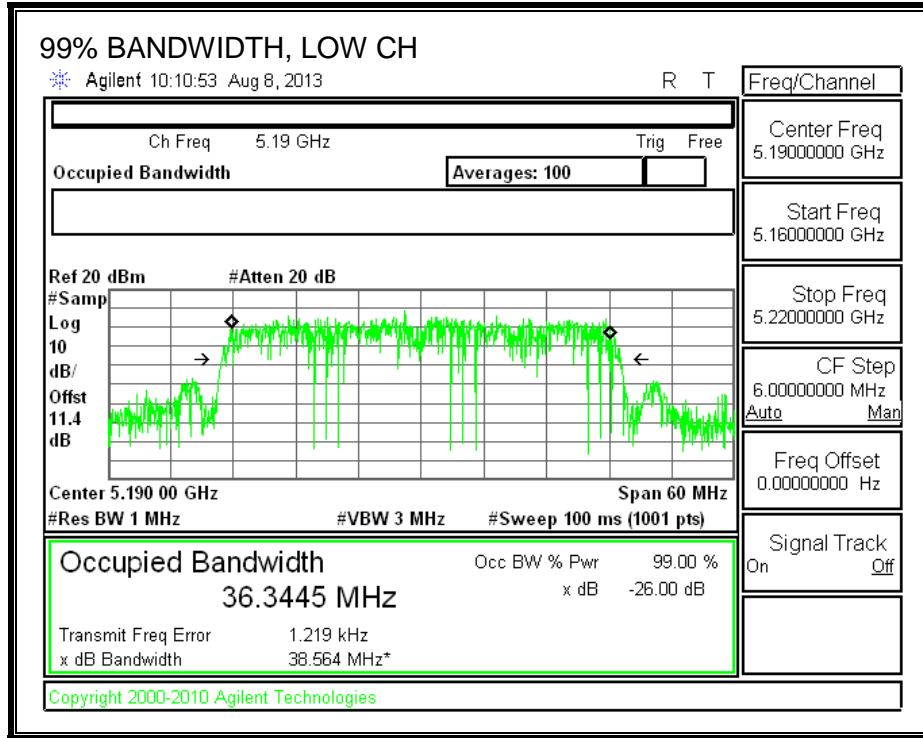

### 8.4.3. AVERAGE POWER

#### LIMITS

None; for reporting purposes only.

#### TEST PROCEDURE

The transmitter output is connected to a power meter.

The cable assembly insertion loss of 11.4 dB (including 10 dB pad and 1.4 dB cable) was entered as an offset in the power meter to allow for direct reading of power.

#### RESULTS

Channel	Frequency (MHz)	Power (dBm)
Low	5190	12.87
High	5230	15.92

#### **8.4.4. OUTPUT POWER AND PPSD**

##### **LIMITS**

FCC §15.407 (a) (1)

For the band 5.15–5.25 GHz, the maximum conducted output power over the frequency band of operation shall not exceed the lesser of 50 mW or  $4 \text{ dBm} + 10 \log B$ , where B is the 26–dB emission bandwidth in MHz. In addition, the peak power spectral density shall not exceed 4 dBm in any 1–MHz band. If transmitting antennas of directional gain greater than 6 dBi are used, both the maximum conducted output power and the peak power spectral density shall be reduced by the amount in dB that the directional gain of the antenna exceeds 6 dBi.

IC RSS-210 A9.2 (1)

The maximum e.i.r.p. shall not exceed 200 mW or  $10 + 10 \log_{10} B$ , dBm, whichever power is less. B is the 99% emission bandwidth in MHz. The e.i.r.p. spectral density shall not exceed 10 dBm in any 1.0 MHz band.

##### **DIRECTIONAL ANTENNA GAIN**

There is only one transmitter output therefore the directional gain is equal to the antenna gain.

**RESULTS**

**Bandwidth and Antenna Gain**

Channel	Frequency (MHz)	Min 26 dB BW (MHz)	Min 99% BW (MHz)	Directional Gain (dBi)
Low	5190	40.14	36.34	2.37
High	5230	40.14	36.40	2.37

**Limits**

Channel	Frequency (MHz)	FCC Power Limit (dBm)	IC EIRP Limit (dBm)	Max IC Power (dBm)	Power Limit (dBm)	FCC PPSD Limit (dBm)	IC eirp PSD Limit (dBm)	PPSD Limit (dBm)
Low	5190	17.00	23.00	20.63	17.00	4.00	10.00	4.00
High	5230	17.00	23.00	20.63	17.00	4.00	10.00	4.00

<b>Duty Cycle CF (dB)</b>	0.00	<b>Included in Calculations of Corr'd Power &amp; PPSD</b>
---------------------------	------	--

**Output Power Results**

Channel	Frequency (MHz)	Chain 0 Meas Power (dBm)	Total Corr'd Power (dBm)	Power Limit (dBm)	Power Margin (dB)
Low	5190	12.91	12.91	17.00	-4.09
High	5230	15.95	15.95	17.00	-1.05

**PPSD Results**

Channel	Frequency (MHz)	Chain 0 Meas PPSD (dBm)	Total Corr'd PPSD (dBm)	PPSD Limit (dBm)	PPSD Margin (dB)
Low	5190	0.33	0.33	4.00	-3.67
High	5230	3.28	3.28	4.00	-0.72

**OUTPUT POWER AND PPSD, Chain 0**

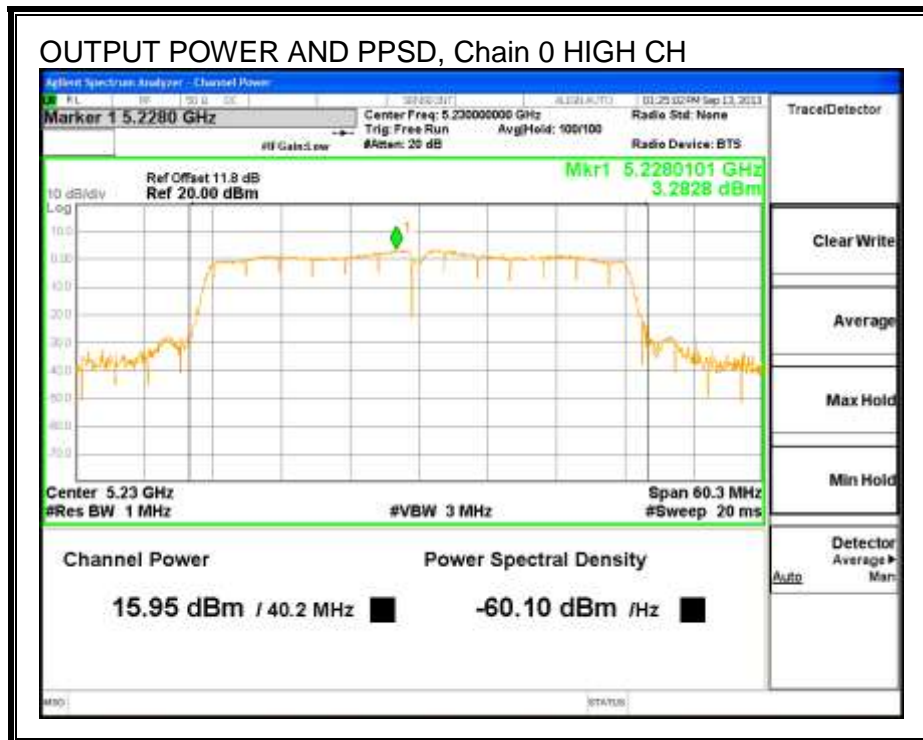
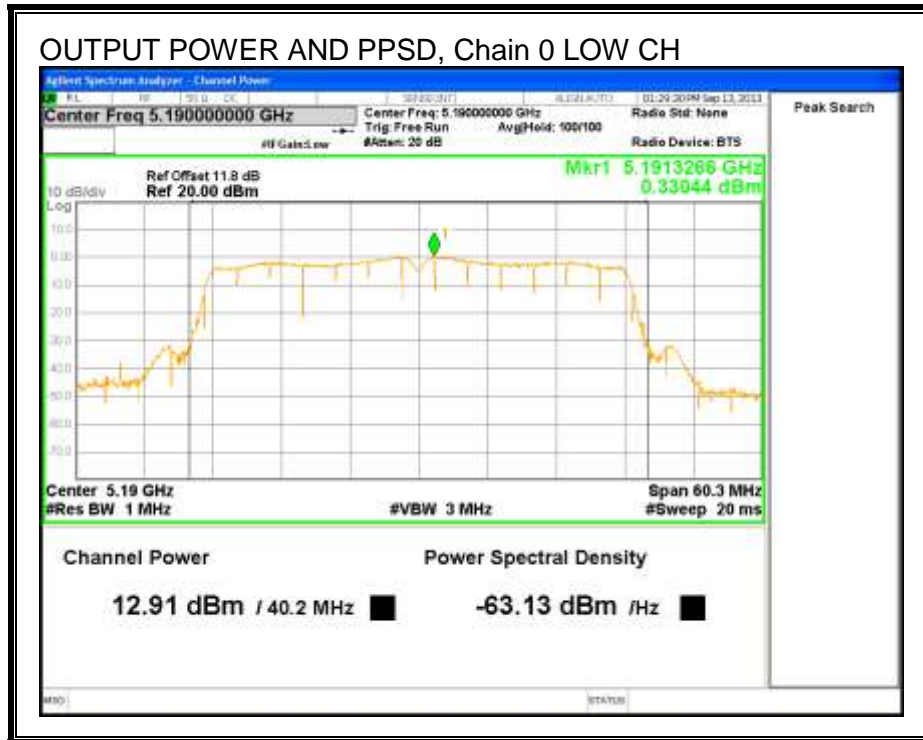

## 8.5. 802.11n HT40 2TX STBC MODE IN THE 5.2 GHz BAND

### 8.5.1. 26 dB BANDWIDTH

#### LIMITS

None; for reporting purposes only.

#### RESULTS

Channel	Frequency (MHz)	26 dB BW Chain 0 (MHz)	26 dB BW Chain 1 (MHz)
High	5230	39.84	39.54

**26 dB BANDWIDTH, Chain 0**

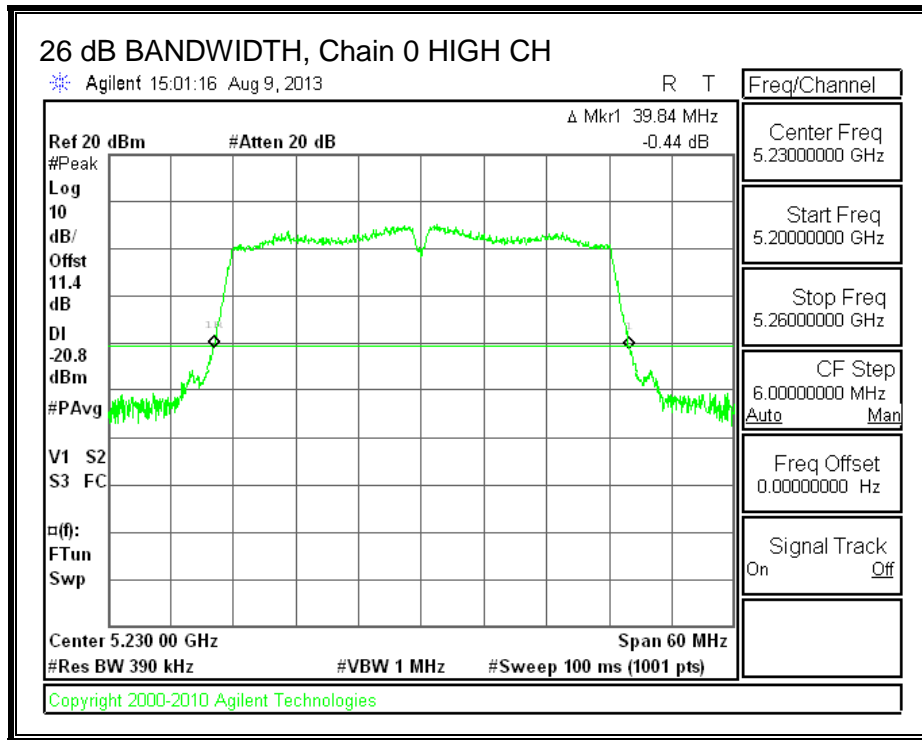

**26 dB BANDWIDTH, Chain 1**

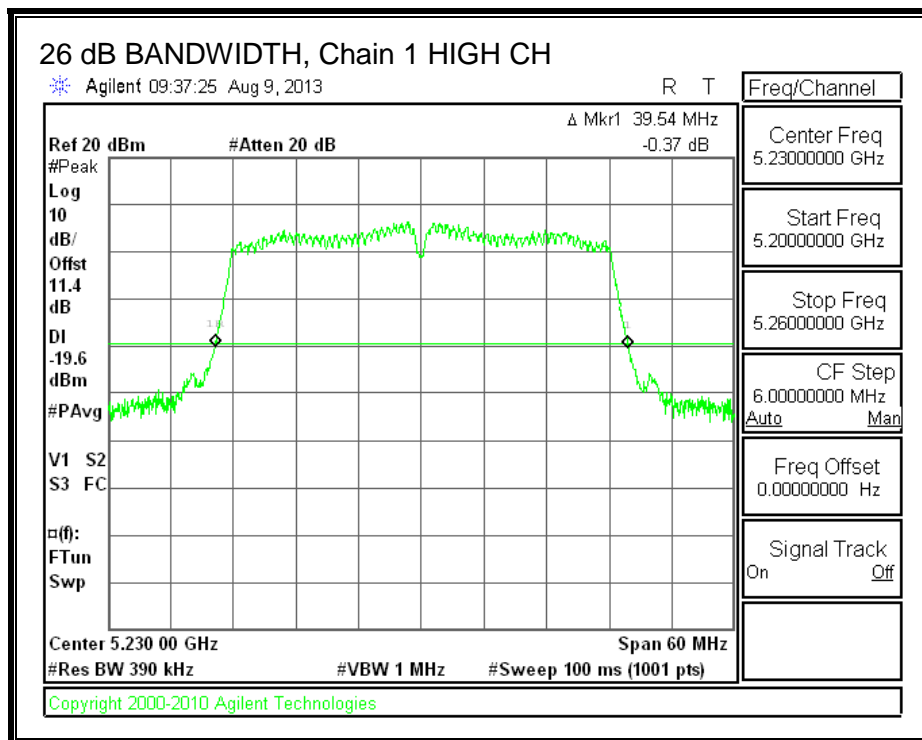

### 8.5.2. 99% BANDWIDTH

#### LIMITS

None; for reporting purposes only.

#### RESULTS

Channel	Frequency (MHz)	99% BW Chain 0 (MHz)	99% BW Chain 1 (MHz)
High	5230	36.3381	36.3365



**99% BANDWIDTH, Chain 0**

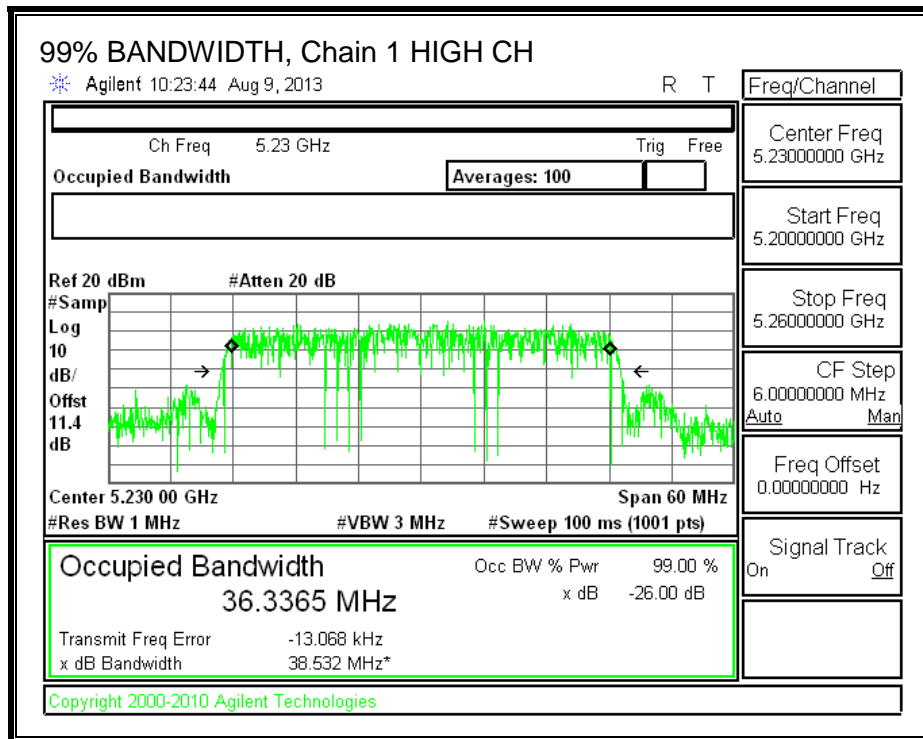
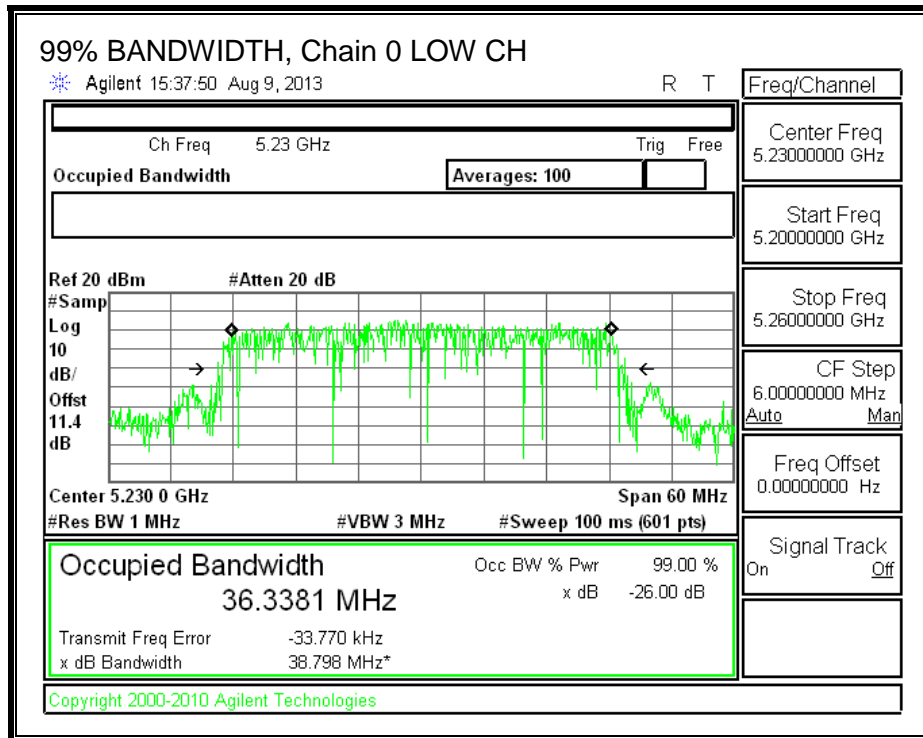

### 8.5.3. AVERAGE POWER

#### LIMITS

None; for reporting purposes only.

#### TEST PROCEDURE

The transmitter output is connected to a power meter.

The cable assembly insertion loss of 11.4 dB (including 10 dB pad and 1.4 dB cable) was entered as an offset in the power meter to allow for direct reading of power.

#### RESULTS

##### Average Power Results

Channel	Frequency (MHz)	Chain 0 Power (dBm)	Chain 1 Power (dBm)	Total Power (dBm)
High	5230	13.42	13.48	16.46

**8.5.4. OUTPUT POWER AND PPSD**

**LIMITS**

FCC §15.407 (a) (1)

For the band 5.15–5.25 GHz, the maximum conducted output power over the frequency band of operation shall not exceed the lesser of 50 mW or 4 dBm + 10 log B, where B is the 26–dB emission bandwidth in MHz. In addition, the peak power spectral density shall not exceed 4 dBm in any 1–MHz band. If transmitting antennas of directional gain greater than 6 dBi are used, both the maximum conducted output power and the peak power spectral density shall be reduced by the amount in dB that the directional gain of the antenna exceeds 6 dBi.

IC RSS-210 A9.2 (1)

The maximum e.i.r.p. shall not exceed 200 mW or 10 + 10 log<sub>10</sub> B, dBm, whichever power is less. B is the 99% emission bandwidth in MHz. The e.i.r.p. spectral density shall not exceed 10 dBm in any 1.0 MHz band.

**DIRECTIONAL ANTENNA GAIN**

For output power, the TX chains are uncorrelated and the antenna gain is unequal among the chains. The directional gain is:

Chain 0 Antenna Gain (dBi)	Chain 1 Antenna Gain (dBi)	Uncorrelated Chains Directional Gain (dBi)
2.37	2.07	2.22

For PPSD, the TX chains are correlated and the antenna gain is unequal among the chains. The directional gain is:

Chain 0 Antenna Gain (dBi)	Chain 1 Antenna Gain (dBi)	Correlated Chains Directional Gain (dBi)
2.37	2.07	5.23

**RESULTS**

**Bandwidth and Antenna Gain**

Channel	Frequency (MHz)	Min 26 dB BW (MHz)	Min 99% BW (MHz)	Uncorrelat Directional Gain (dBi)
High	5230	44.00	44.00	2.22

**Limits**

Channel	Frequency (MHz)	FCC Power Limit (dBm)	IC EIRP Limit (dBm)	Max IC Power (dBm)	Power Limit (dBm)	FCC PPSD Limit (dBm)	IC eirp PSD Limit (dBm)	PPSD Limit (dBm)
High	5230	17.00	23.00	20.78	17.00	4.00	10.00	4.00

<b>Duty Cycle CF (dB)</b>	0.00	<b>Included in Calculations of Corr'd Power &amp; PPSD</b>
---------------------------	------	--

**Output Power Results**

Channel	Frequency (MHz)	Chain 0 Meas Power (dBm)	Chain 1 Meas Power (dBm)	Total Corr'd Power (dBm)	Power Limit (dBm)	Power Margin (dB)
High	5230	13.80	13.68	16.75	17.00	-0.25

**PPSD Results**

Channel	Frequency (MHz)	Chain 0 Meas PPSD (dBm)	Chain 1 Meas PPSD (dBm)	Total Corr'd PPSD (dBm)	PPSD Limit (dBm)	PPSD Margin (dB)
High	5230	1.04	0.52	3.80	4.00	-0.20

**OUTPUT POWER AND PPSD, Chain 0**

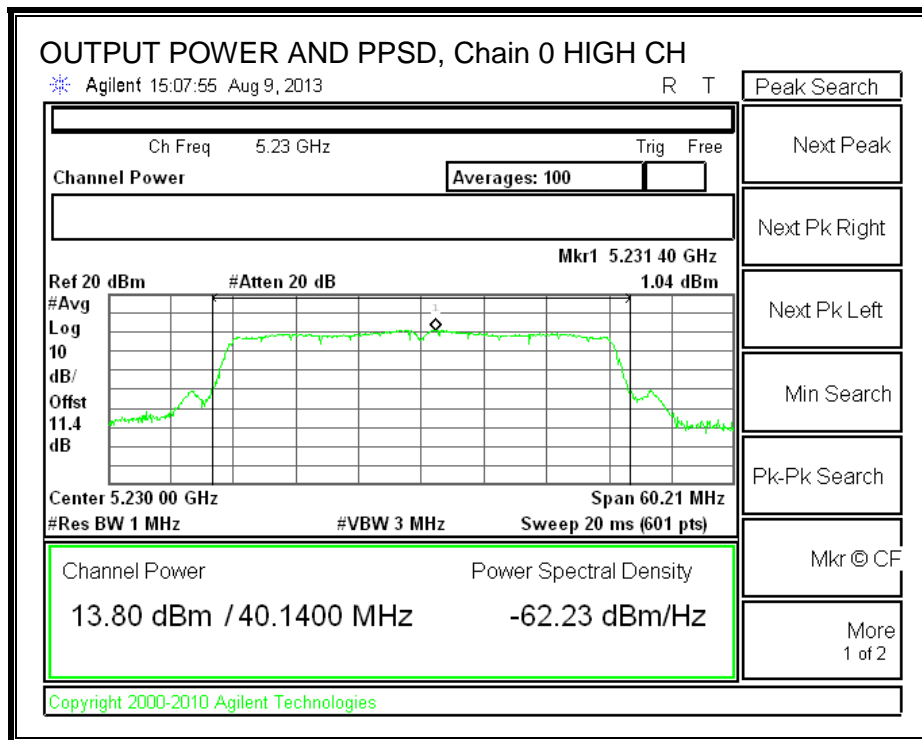

**OUTPUT POWER AND PPSD, Chain 1**

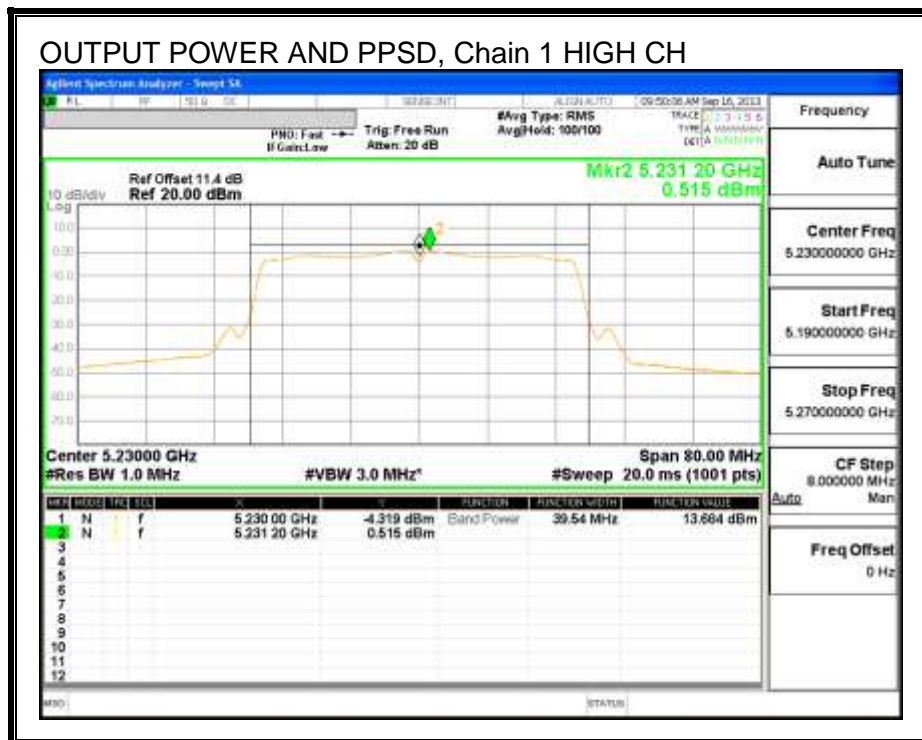

## 8.6. 802.11n HT40 2TX CDD MODE IN THE 5.2 GHz BAND

### 8.6.1. 26 dB BANDWIDTH

#### LIMITS

None; for reporting purposes only.

#### RESULTS

Channel	Frequency (MHz)	26 dB BW Chain 0 (MHz)	26 dB BW Chain 1 (MHz)
Low	5190	40.14	39.54
High	5230	39.90	39.66

**26 dB BANDWIDTH, Chain 0**

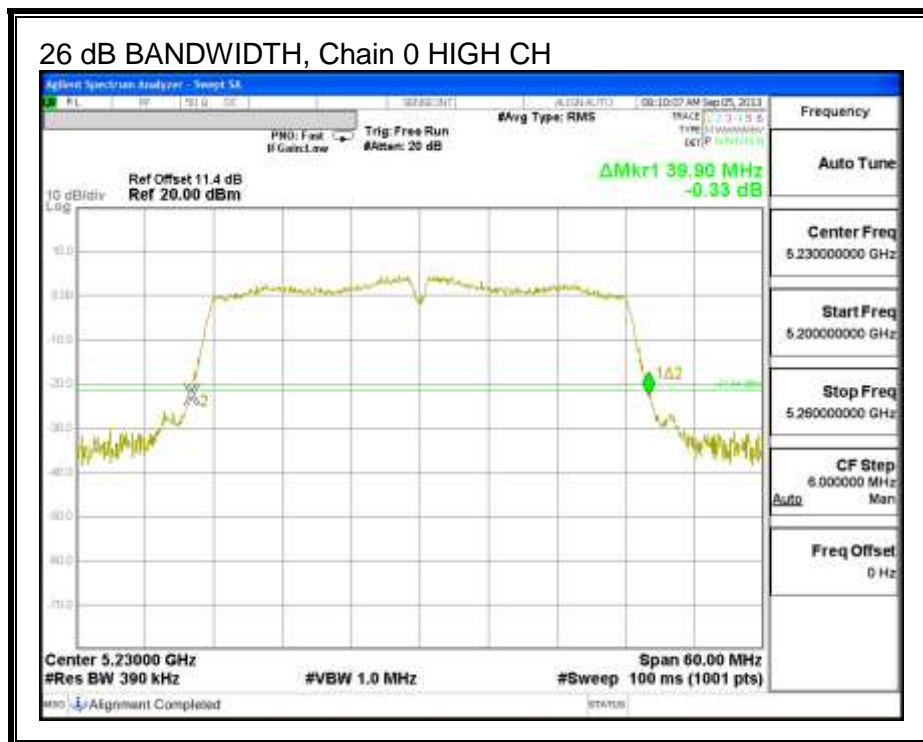
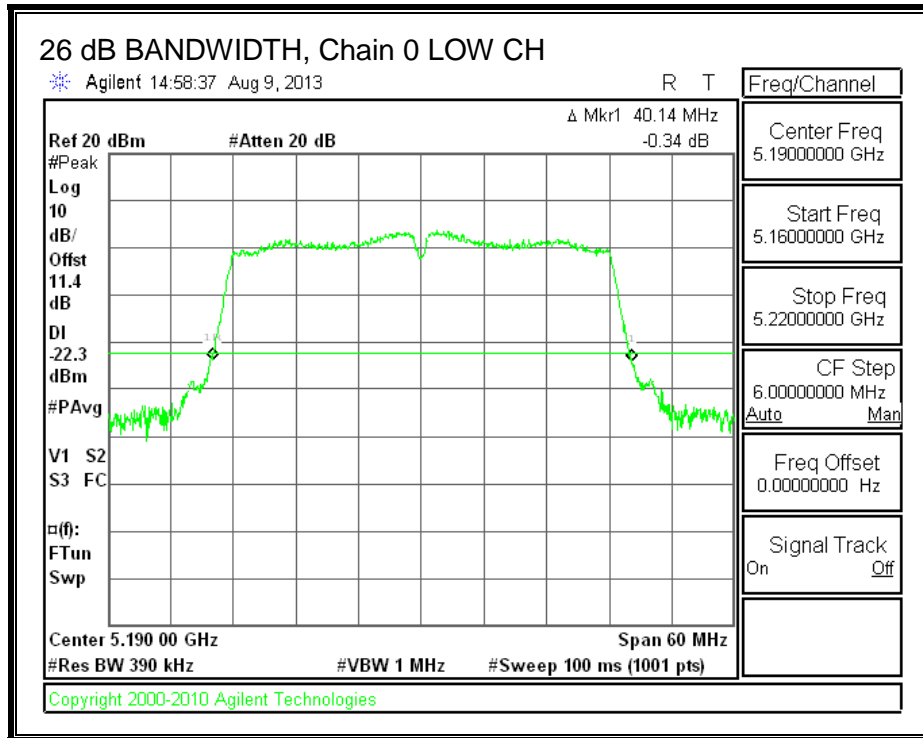

**26 dB BANDWIDTH, Chain 1**

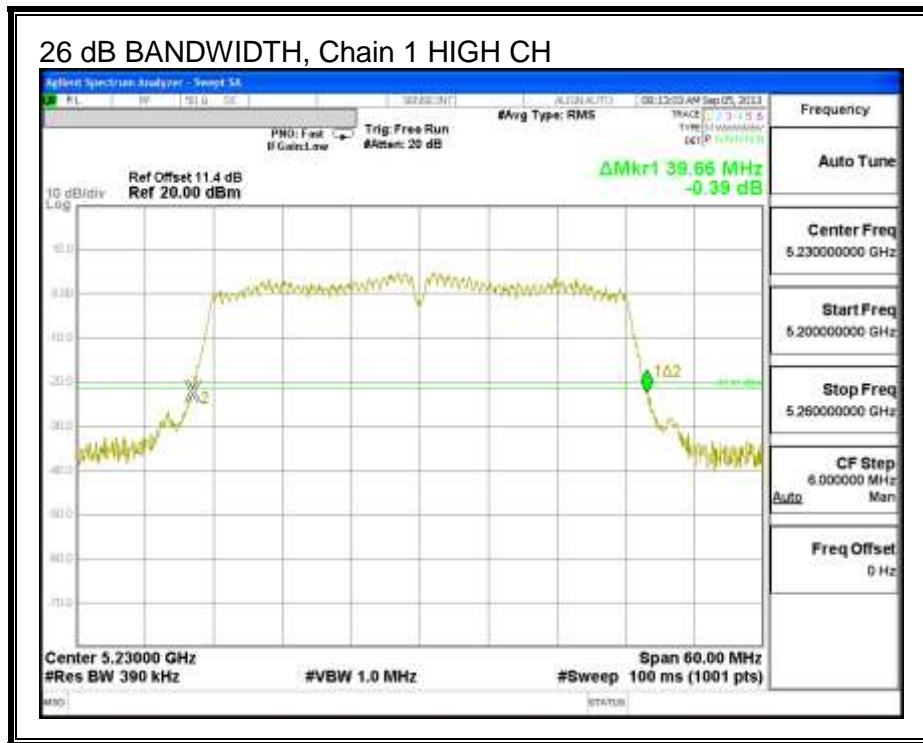
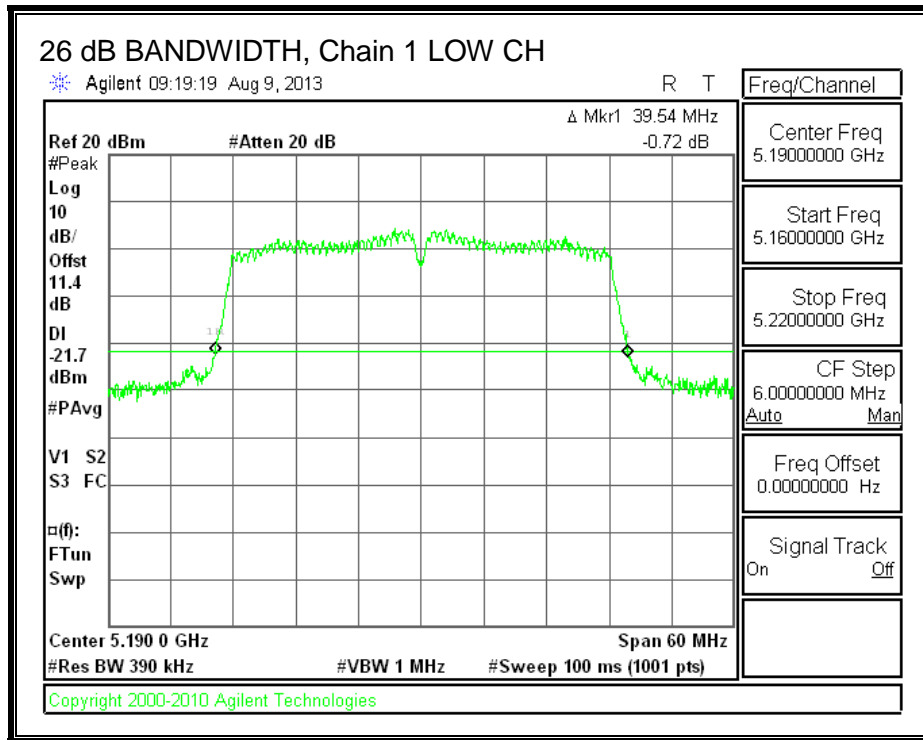



### 8.6.2. 99% BANDWIDTH

#### LIMITS

None; for reporting purposes only.

#### RESULTS

Channel	Frequency (MHz)	99% BW Chain 0 (MHz)	99% BW Chain 1 (MHz)
Low	5190	36.3329	36.3507
High	5230	36.5740	36.4550

**99% BANDWIDTH, Chain 0**

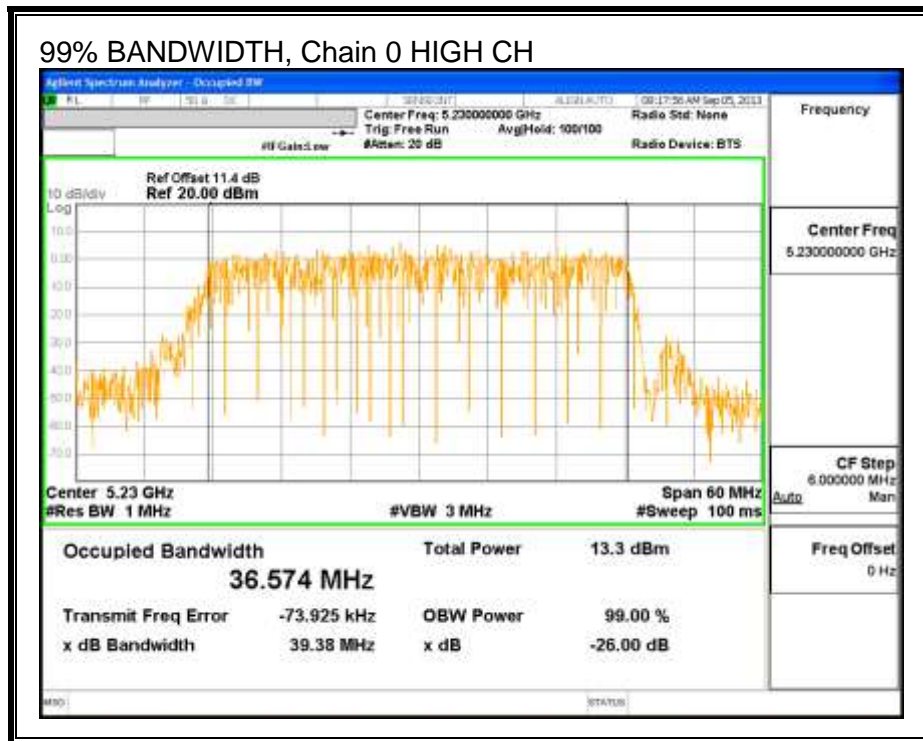
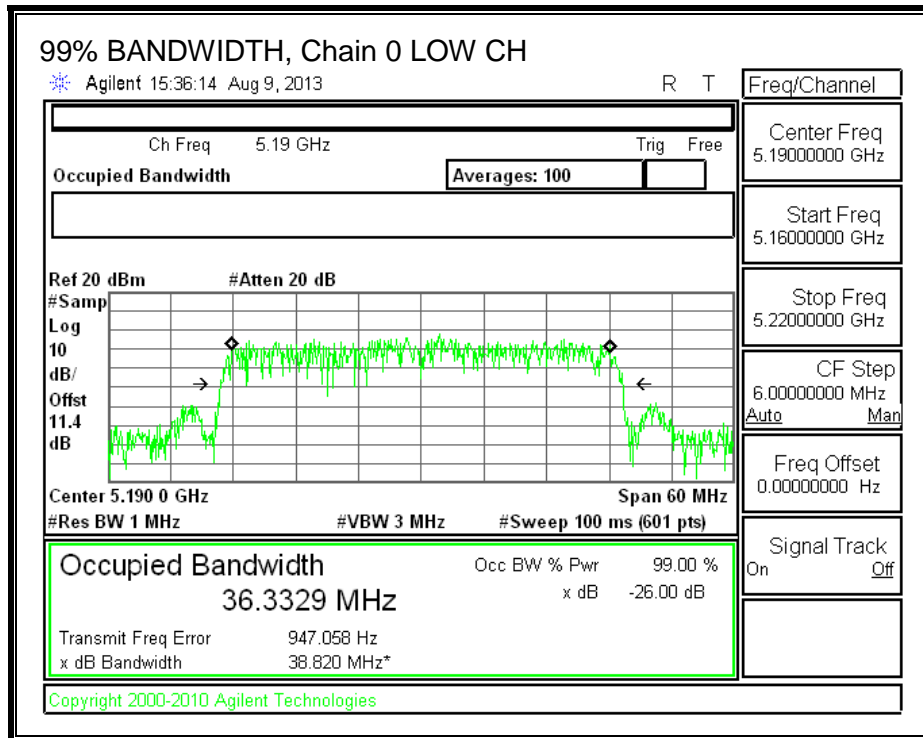

**99% BANDWIDTH, Chain 1**

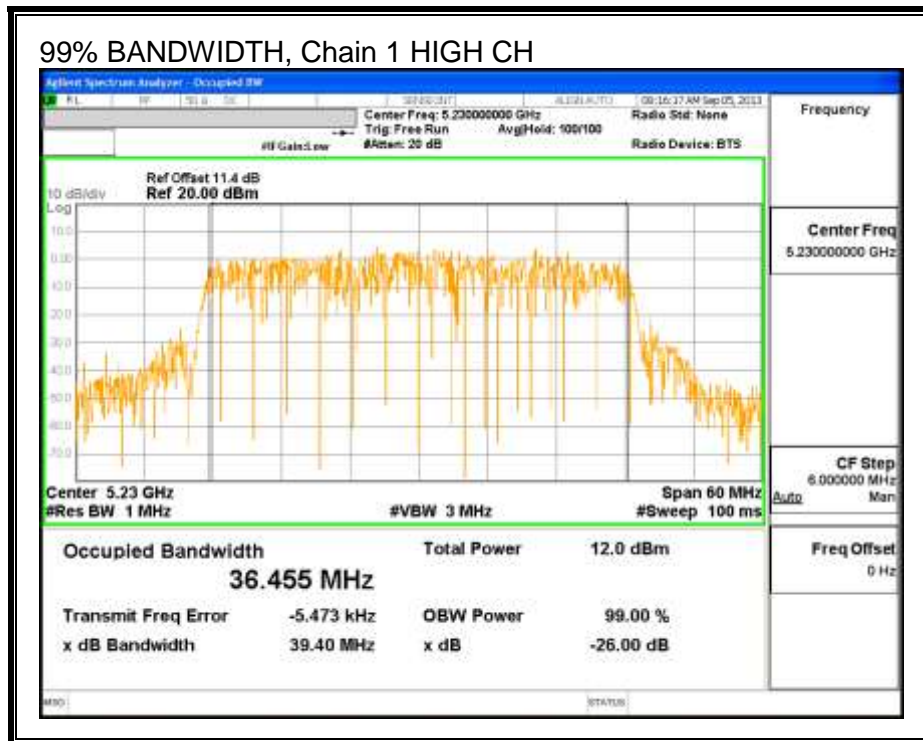
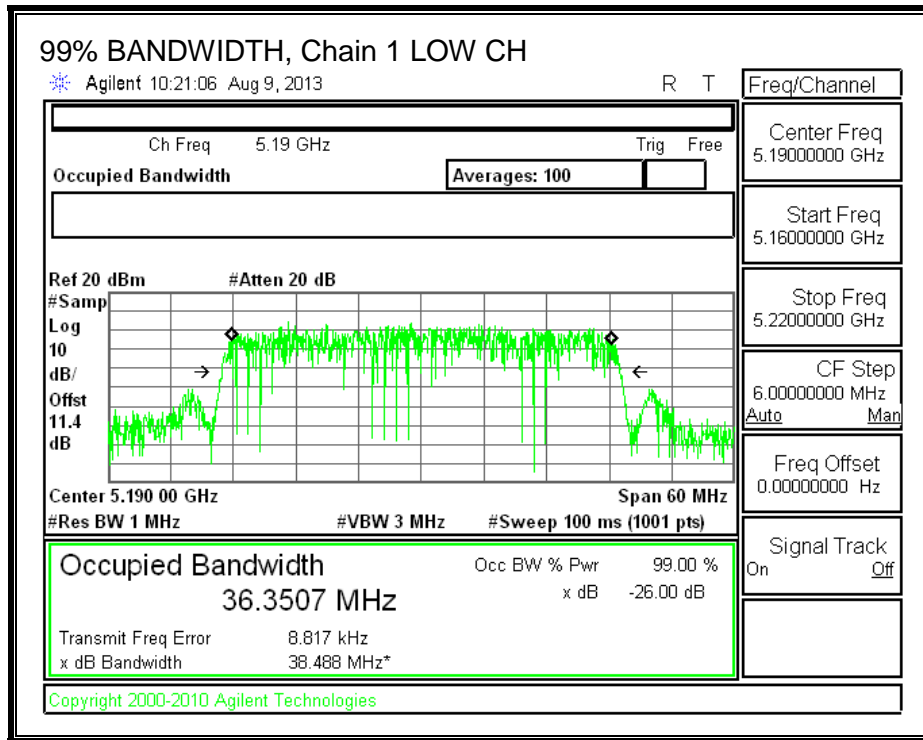

### 8.6.3. AVERAGE POWER

#### LIMITS

None; for reporting purposes only.

#### TEST PROCEDURE

The transmitter output is connected to a power meter.

The cable assembly insertion loss of 11.4 dB (including 10 dB pad and 1.4 dB cable) was entered as an offset in the power meter to allow for direct reading of power.

#### RESULTS

##### Average Power Results

Channel	Frequency (MHz)	Chain 0 Power (dBm)	Chain 1 Power (dBm)	Total Power (dBm)
Low	5190	11.38	11.37	14.39
High	5230	12.87	12.86	15.88

**8.6.4. OUTPUT POWER AND PPSD**

**LIMITS**

FCC §15.407 (a) (1)

For the band 5.15–5.25 GHz, the maximum conducted output power over the frequency band of operation shall not exceed the lesser of 50 mW or 4 dBm + 10 log B, where B is the 26–dB emission bandwidth in MHz. In addition, the peak power spectral density shall not exceed 4 dBm in any 1–MHz band. If transmitting antennas of directional gain greater than 6 dBi are used, both the maximum conducted output power and the peak power spectral density shall be reduced by the amount in dB that the directional gain of the antenna exceeds 6 dBi.

IC RSS-210 A9.2 (1)

The maximum e.i.r.p. shall not exceed 200 mW or 10 + 10 log<sub>10</sub> B, dBm, whichever power is less. B is the 99% emission bandwidth in MHz. The e.i.r.p. spectral density shall not exceed 10 dBm in any 1.0 MHz band.

**DIRECTIONAL ANTENNA GAIN**

For output power, the TX chains are uncorrelated and the antenna gain is unequal among the chains. The directional gain is:

Chain 0 Antenna Gain (dBi)	Chain 1 Antenna Gain (dBi)	Uncorrelated Chains Directional Gain (dBi)
2.37	2.07	2.22

For PPSD, the TX chains are correlated and the antenna gain is unequal among the chains. The directional gain is:

Chain 0 Antenna Gain (dBi)	Chain 1 Antenna Gain (dBi)	Correlated Chains Directional Gain (dBi)
2.37	2.07	5.23

**RESULTS**

Channel	Frequency (MHz)	Min 26 dB BW (MHz)	Min 99% BW (MHz)	Uncorrelat Directional Gain (dBi)	Correlat Directio nal Gain (dBi)
Low	5190	39.54	36.33	2.22	5.23
High	5230	39.66	36.46	2.22	5.23

**Limits**

Channel	Frequency (MHz)	FCC Power Limit (dBm)	IC EIRP Limit (dBm)	Max IC Power (dBm)	Power Limit (dBm)	FCC PPSD Limit (dBm)	IC eirp PSD Limit (dBm)	PPSD Limit (dBm)
Low	5190	17.00	23.00	20.78	17.00	4.00	10.00	4.00
High	5230	17.00	23.00	20.78	17.00	4.00	10.00	4.00

<b>Duty Cycle CF (dB)</b>	0.00	<b>Included in Calculations of Corr'd Power &amp; PSD</b>
---------------------------	------	---

**Output Power Results**

Channel	Frequency (MHz)	Chain 0 Meas Power (dBm)	Chain 1 Meas Power (dBm)	Total Corr'd Power (dBm)	Power Limit (dBm)	Power Margin (dB)
Low	5190	11.60	11.57	14.60	17.00	-2.40
High	5230	12.94	12.89	15.93	17.00	-1.07

**PPSD Results**

Channel	Frequency (MHz)	Chain 0 Meas PPSD (dBm)	Chain 1 Meas PPSD (dBm)	Total Corr'd PPSD (dBm)	PPSD Limit (dBm)	PPSD Margin (dB)
Low	5190	-0.67	-0.88	2.24	4.00	-1.76
High	5230	0.48	-0.26	3.14	4.00	-0.86

**OUTPUT POWER AND PPSD, Chain 0**

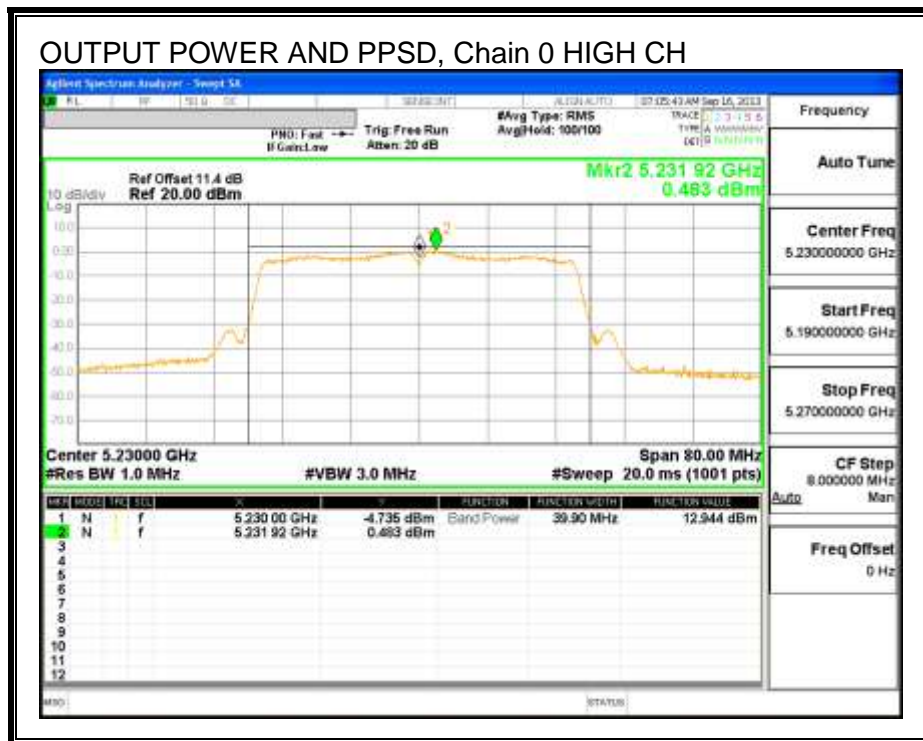
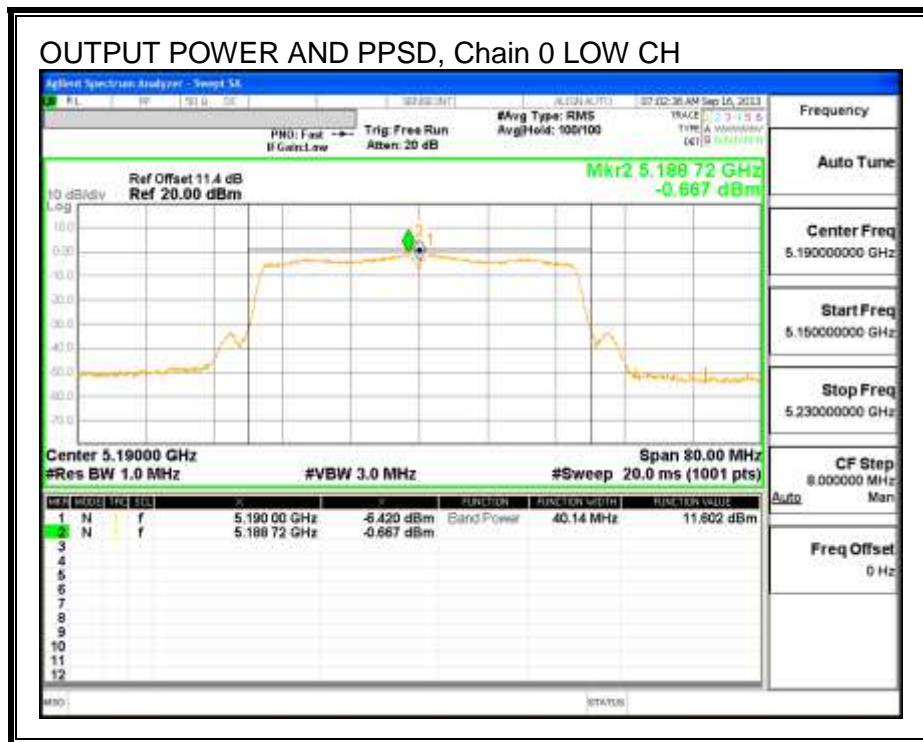

**OUTPUT POWER AND PPSD, Chain 1**

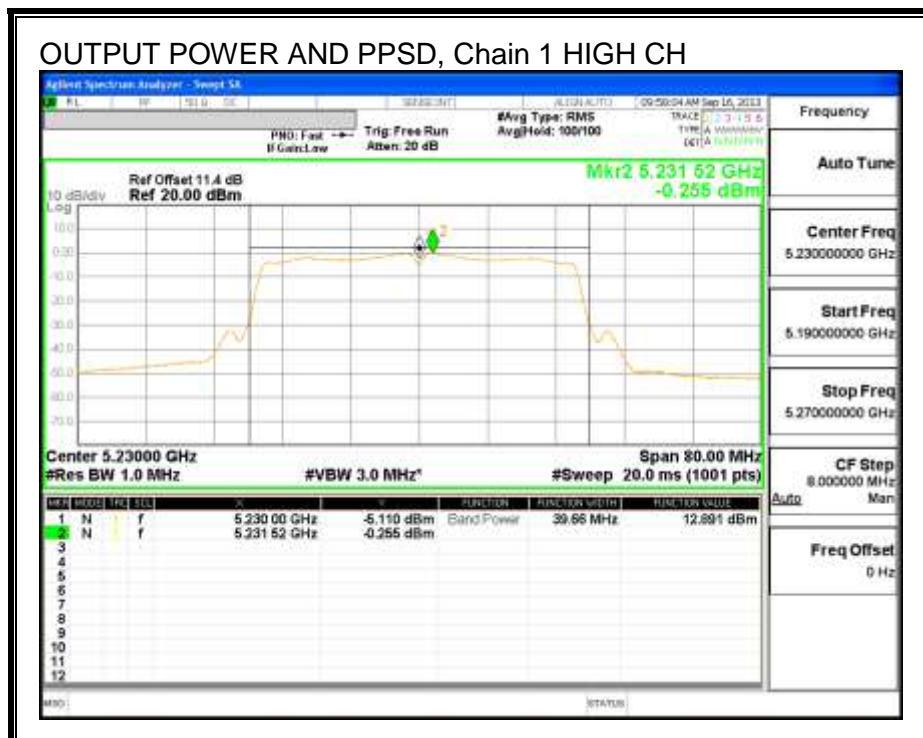
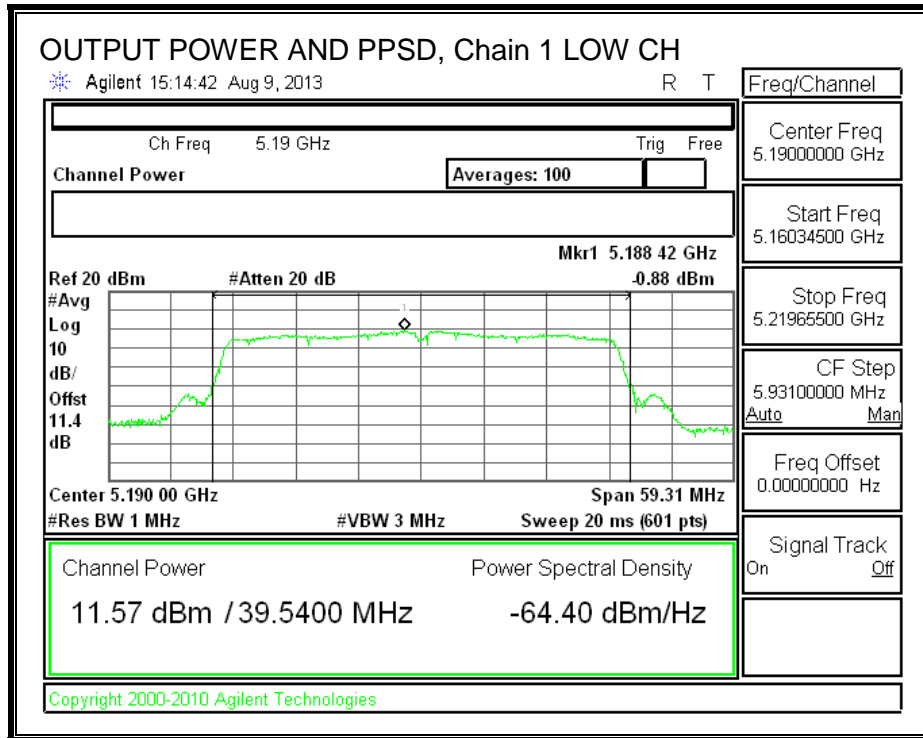



## 8.7. 802.11a SISO MODE IN THE 5.3 GHZ BAND

### 8.7.1. 26 dB BANDWIDTH

#### LIMITS

None; for reporting purposes only.

#### RESULTS

Channel	Frequency (MHz)	26 dB Bandwidth (MHz)
Low	5260	19.48
Mid	5300	19.53
High	5320	19.47

**26 dB BANDWIDTH**

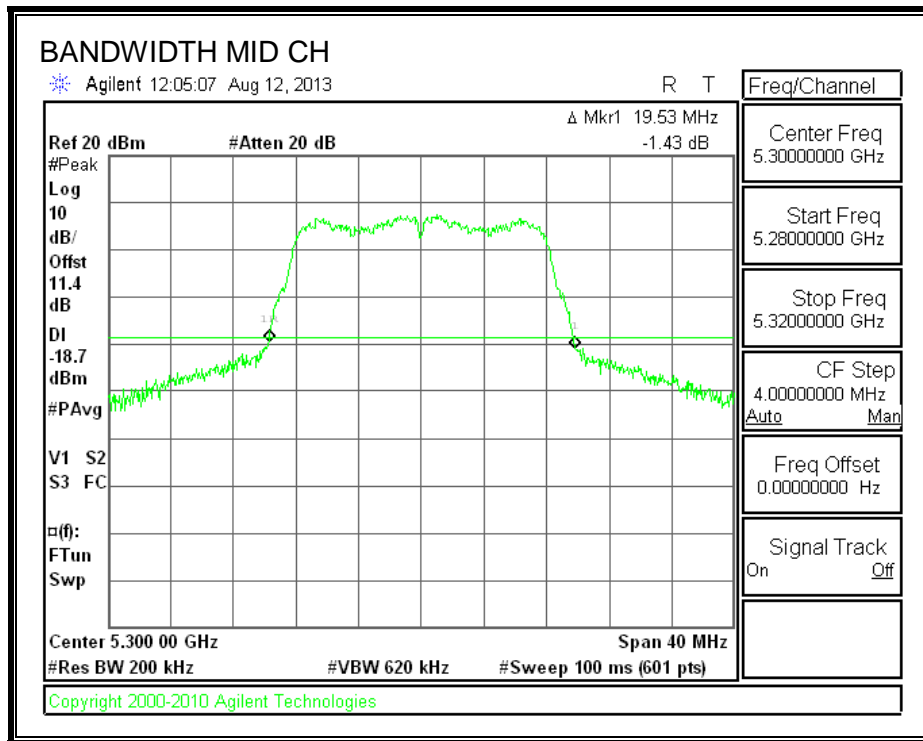
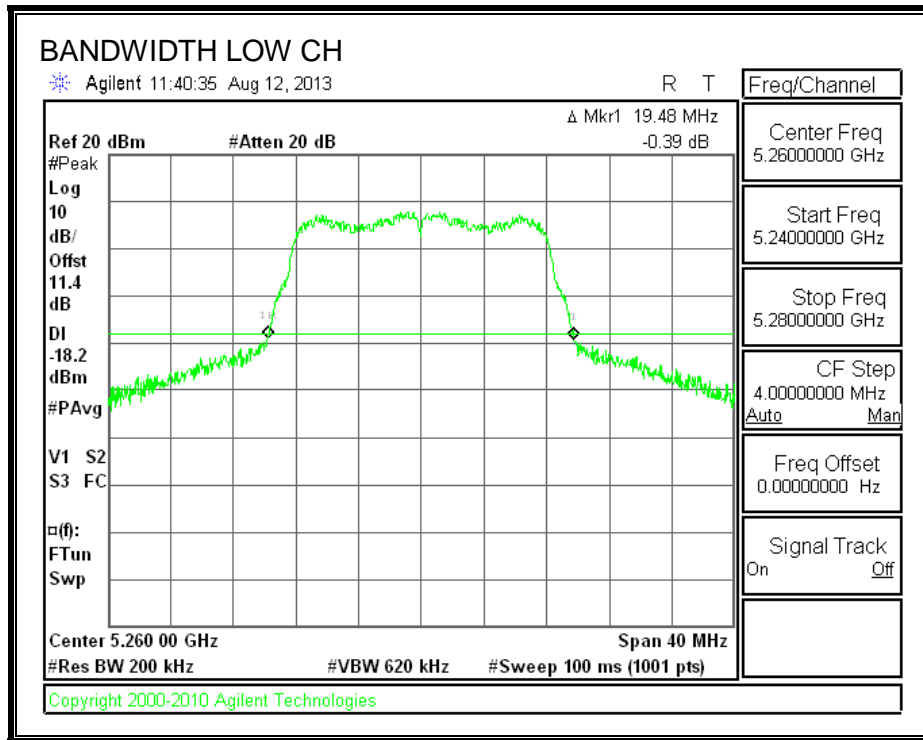

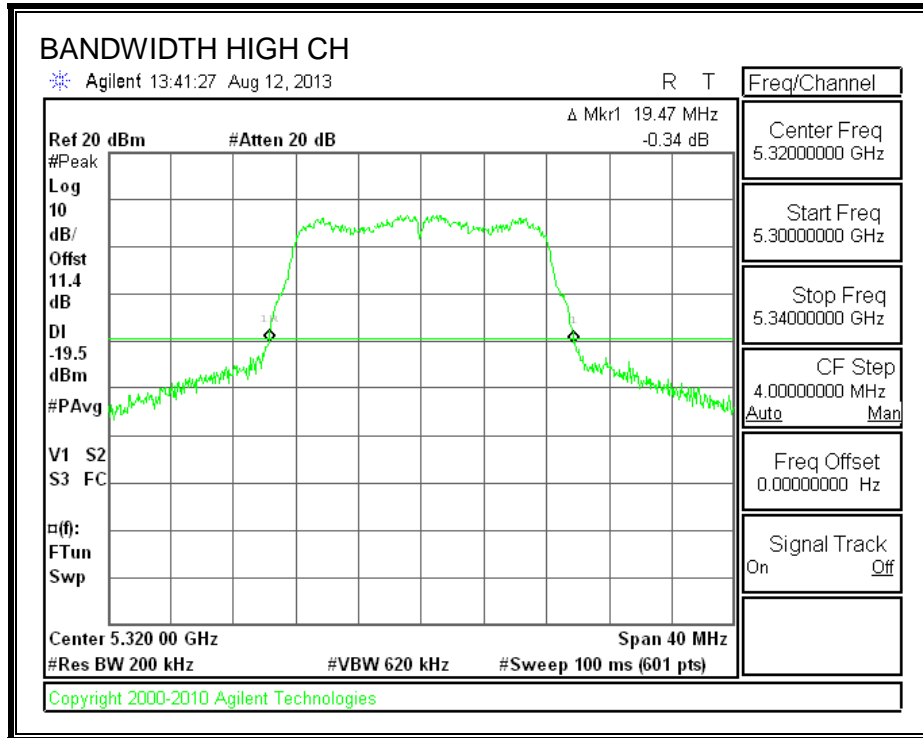

## 8.7.2. 99% BANDWIDTH

### LIMITS

None; for reporting purposes only.

### RESULTS

Channel	Frequency (MHz)	99% Bandwidth (MHz)
Low	5260	16.3600
Mid	5300	16.3707
High	5320	16.3514

**99% BANDWIDTH**

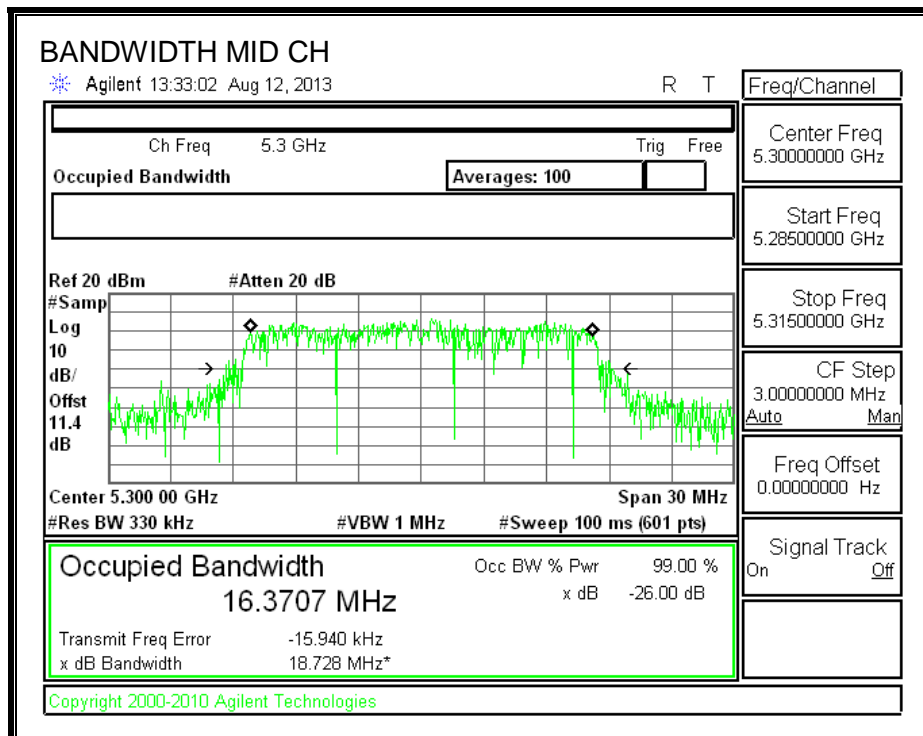
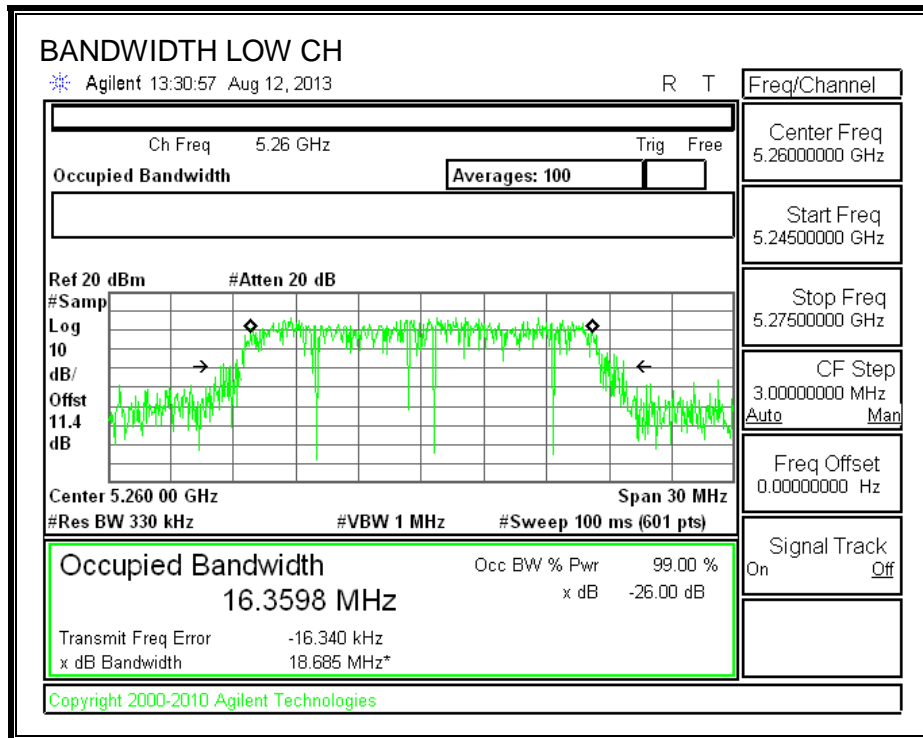

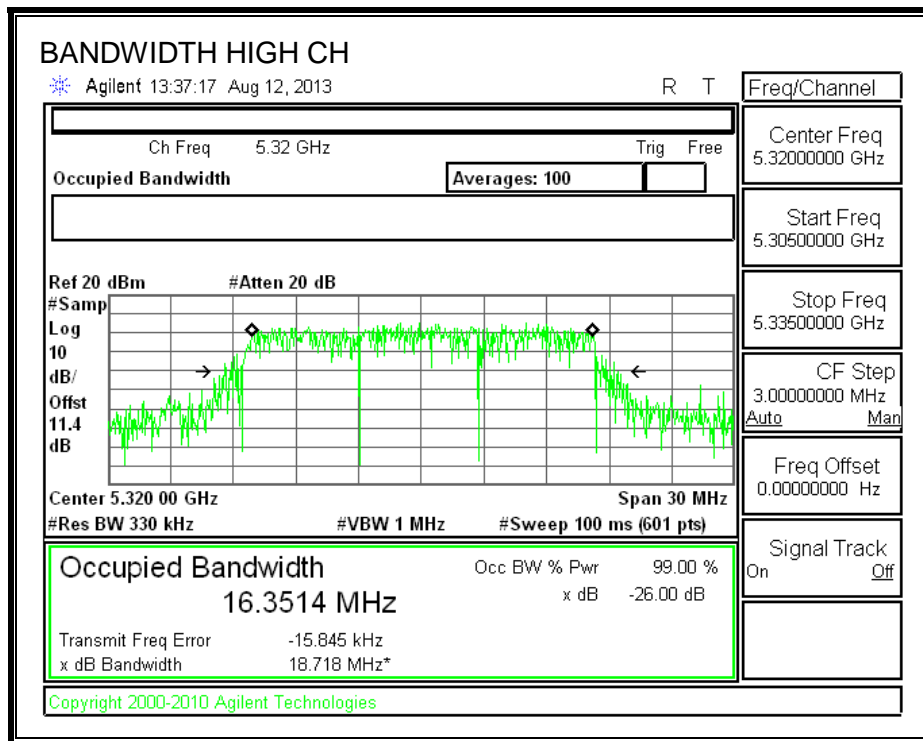

### 8.7.3. AVERAGE POWER

#### LIMITS

None; for reporting purposes only.

#### TEST PROCEDURE

The transmitter output is connected to a power meter.

The cable assembly insertion loss of 11.4 dB (including 10 dB pad and 1.4 dB cable) was entered as an offset in the power meter to allow for direct reading of power.

#### RESULTS

Channel	Frequency (MHz)	Power (dBm)
Low	5260	16.45
Mid	5300	16.45
High	5320	14.97

## **8.7.4. OUTPUT POWER AND PPSD**

### **LIMITS**

FCC §15.407 (a) (1)

For the band 5.25–5.35 GHz, the maximum conducted output power over the frequency band of operation shall not exceed the lesser of 250 mW or  $11 \text{ dBm} + 10 \log B$ , where B is the 26–dB emission bandwidth in MHz. In addition, the peak power spectral density shall not exceed 11 dBm in any 1–MHz band. If transmitting antennas of directional gain greater than 6 dBi are used, both the maximum conducted output power and the peak power spectral density shall be reduced by the amount in dB that the directional gain of the antenna exceeds 6 dBi.

IC RSS-210 A9.2 (1)

The maximum e.i.r.p. shall not exceed 200 mW or  $10 + 10 \log_{10} B$ , dBm, whichever power is less. B is the 99% emission bandwidth in MHz. The e.i.r.p. spectral density shall not exceed 10 dBm in any 1.0 MHz band.

### **DIRECTIONAL ANTENNA GAIN**

There is only one transmitter output therefore the directional gain is equal to the antenna gain.



**RESULTS**

**Bandwidth and Antenna Gain**

Channel	Frequency (MHz)	Min 26 dB BW (MHz)	Min 99% BW (MHz)	Directional Gain (dBi)
Low	5260	19.480	16.360	2.600
Mid	5300	19.530	16.371	2.600
High	5320	19.470	16.351	2.600

**Limits**

Channel	Frequency (MHz)	FCC Power Limit (dBm)	IC Power Limit (dBm)	IC EIRP Limit (dBm)	Power Limit (dBm)	FCC PPSD Limit (dBm)	IC PSD Limit (dBm)	PPSD Limit (dBm)
Low	5260	23.90	23.14	29.14	23.14	11.00	11.00	11.00
Mid	5300	23.91	23.14	29.14	23.14	11.00	11.00	11.00
High	5320	23.89	23.14	29.14	23.14	11.00	11.00	11.00

<b>Duty Cycle CF (dB)</b>	0.00	<b>Included in Calculations of Corr'd Power &amp; PPSD</b>
---------------------------	------	--

**Output Power Results**

Channel	Frequency (MHz)	Chain 0 Meas Power (dBm)	Total Corr'd Power (dBm)	Power Limit (dBm)	Power Margin (dB)
Low	5260	16.62	16.62	23.14	-6.52
Mid	5300	16.51	16.51	23.14	-6.63
High	5320	15.07	15.07	23.14	-8.06

**PPSD Results**

Channel	Frequency (MHz)	Chain 0 Meas PPSD (dBm)	Total Corr'd PPSD (dBm)	PPSD Limit (dBm)	PPSD Margin (dB)
Low	5260	6.58	6.58	11.00	-4.42
Mid	5300	6.41	6.41	11.00	-4.59
High	5320	3.73	3.73	11.00	-7.27

**OUTPUT POWER AND PPSD, Chain 0**

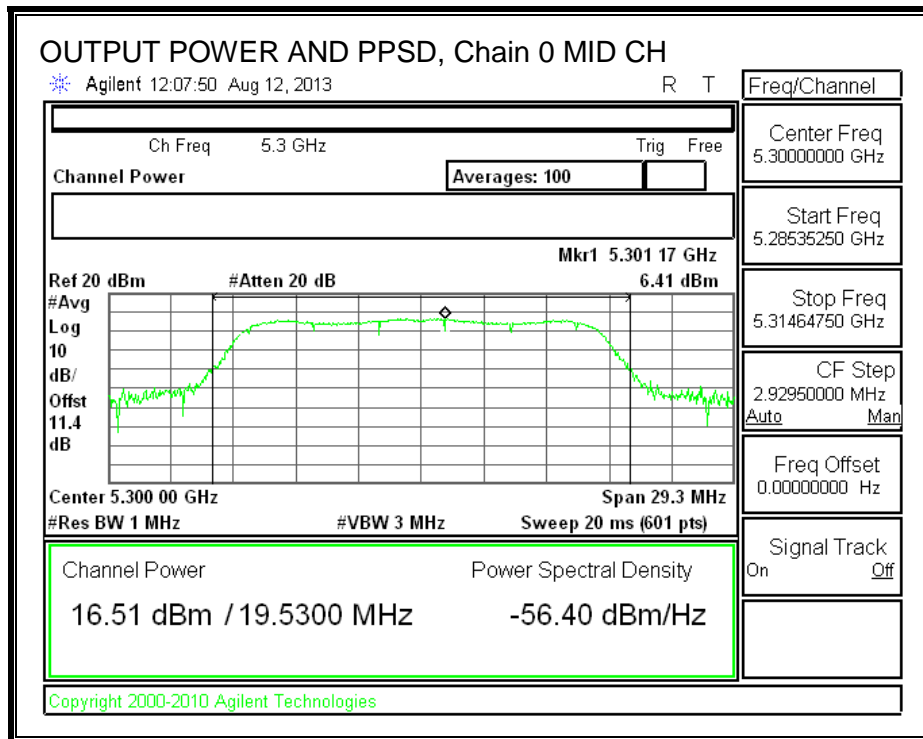
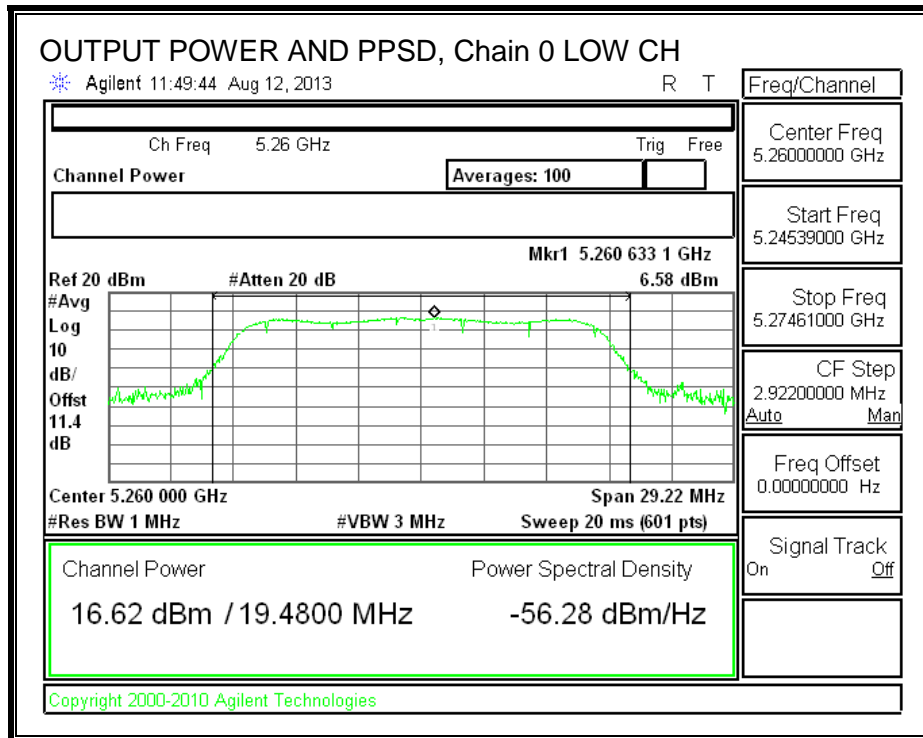

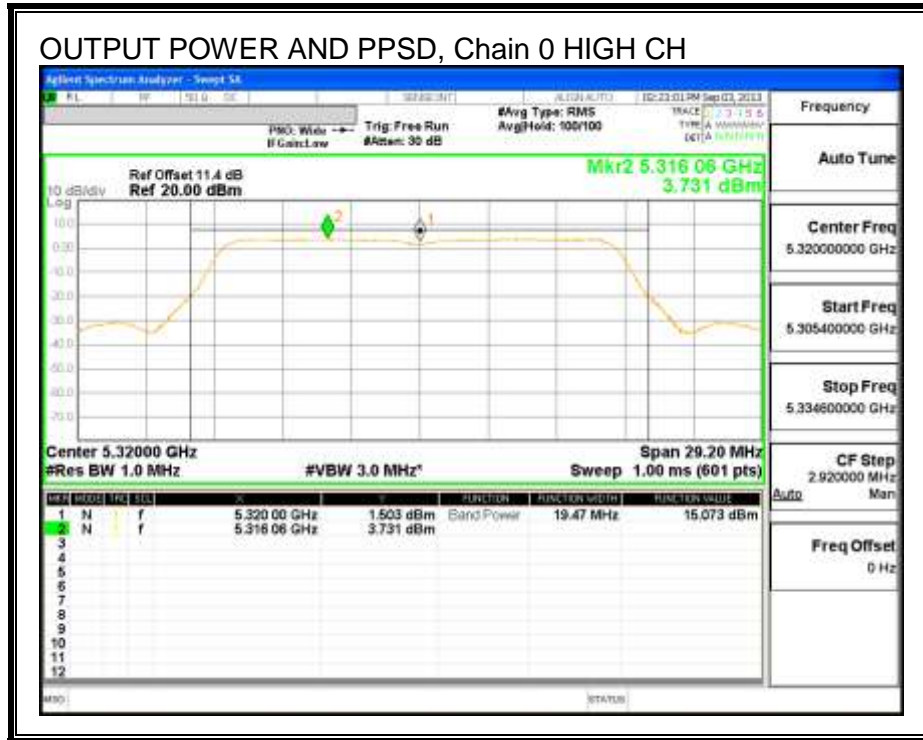

### 8.7.5. PEAK EXCURSION

#### LIMITS

FCC §15.407 (a) (6)

The ratio of the peak excursion of the modulation envelope (measured using a peak hold function) to the peak transmit power (measured as specified above) shall not exceed 13 dB across any 1 MHz bandwidth or the emission bandwidth whichever is less.

#### RESULTS

Channel	Frequency (MHz)	PK Level (dBm)	PSD (dBm)	DCCF (dB)	Peak Excursion (dB)	Limit (dB)	Margin (dB)
Mid	5300	12.81	6.41	0.00	6.40	13	-6.60

**PEAK EXCURSION**

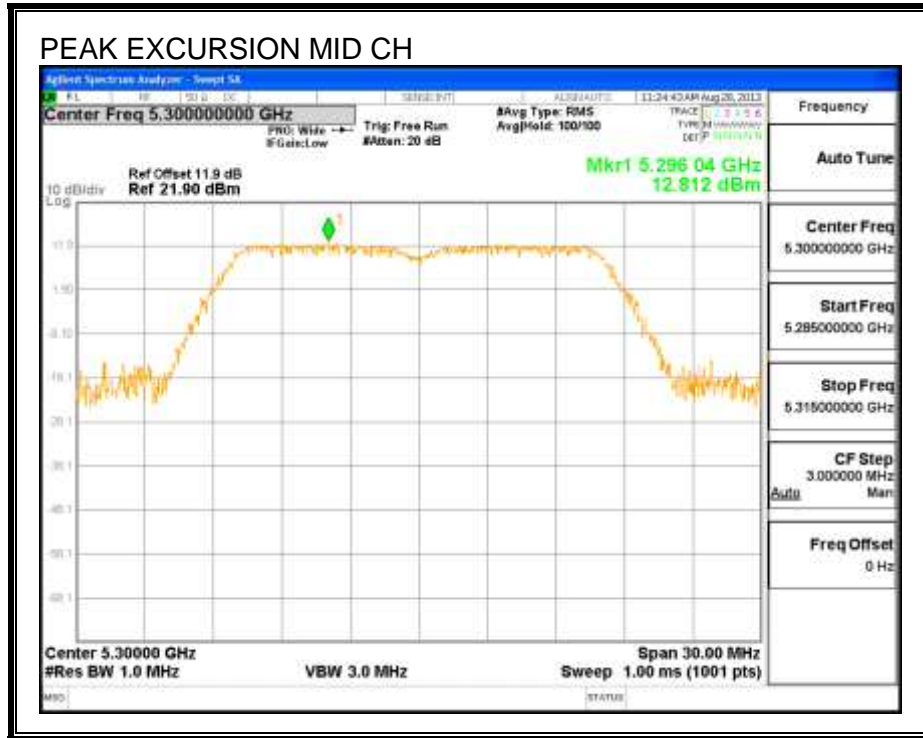

## 8.8. 802.11n HT20 2TX CDD MODE IN THE 5.3 GHz BAND

### 8.8.1. 26 dB BANDWIDTH

#### LIMITS

None; for reporting purposes only.

#### RESULTS

Channel	Frequency (MHz)	26 dB BW Chain 0 (MHz)	26 dB BW Chain 1 (MHz)
Low	5260	19.87	19.73
Mid	5300	19.87	19.87
High	5320	19.73	19.73

**26 dB BANDWIDTH, Chain 0**

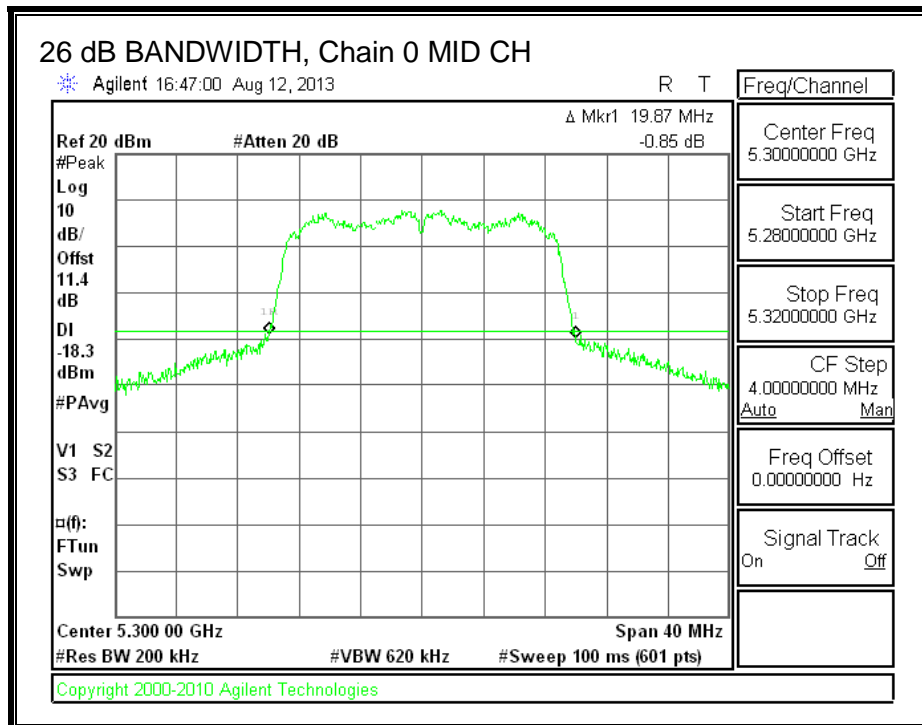
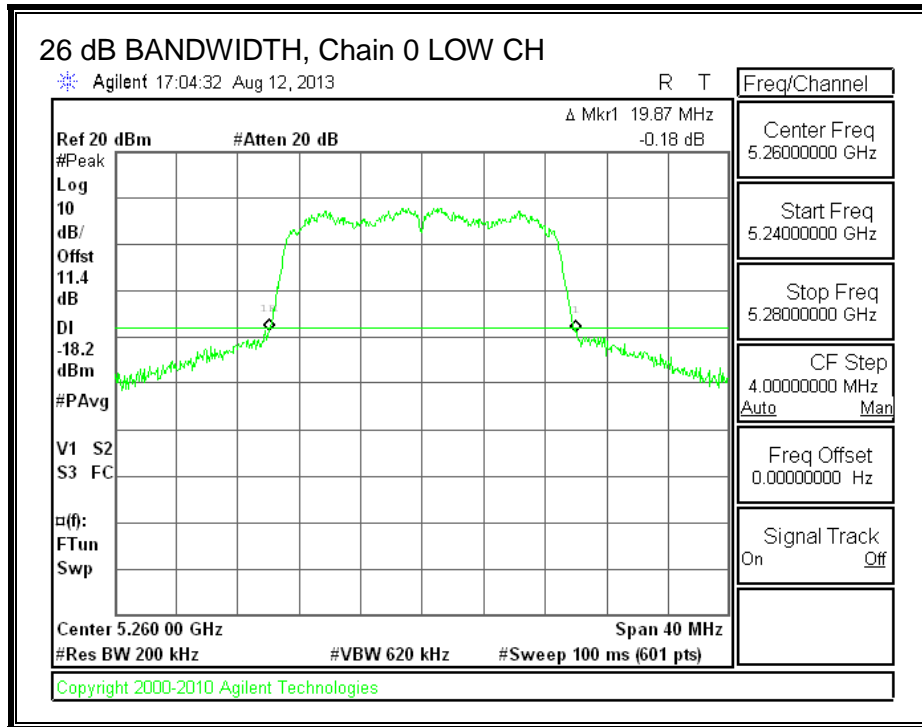

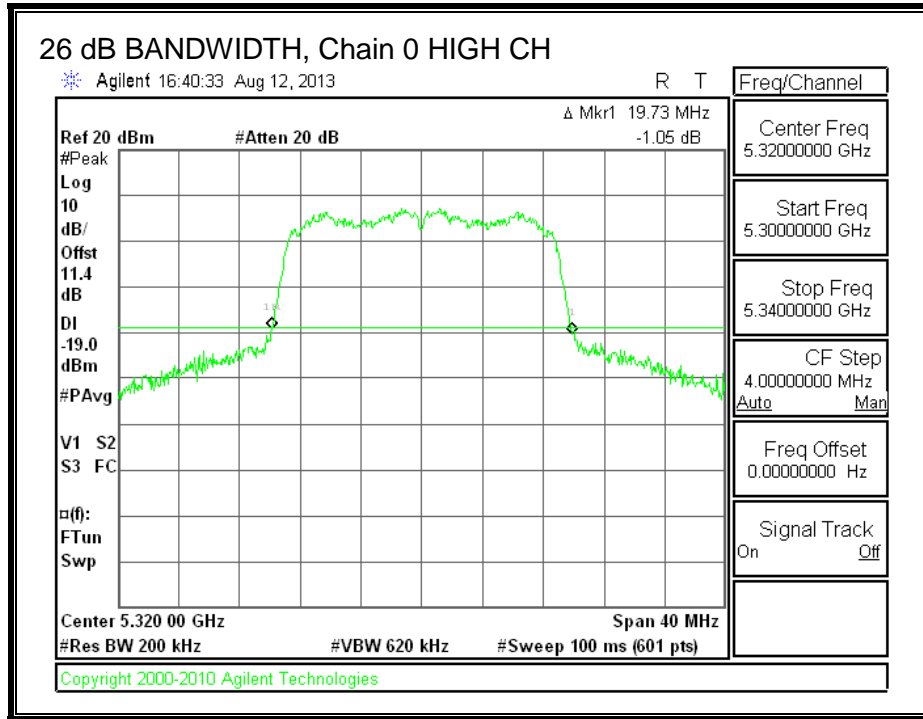

**26 dB BANDWIDTH, Chain 1**

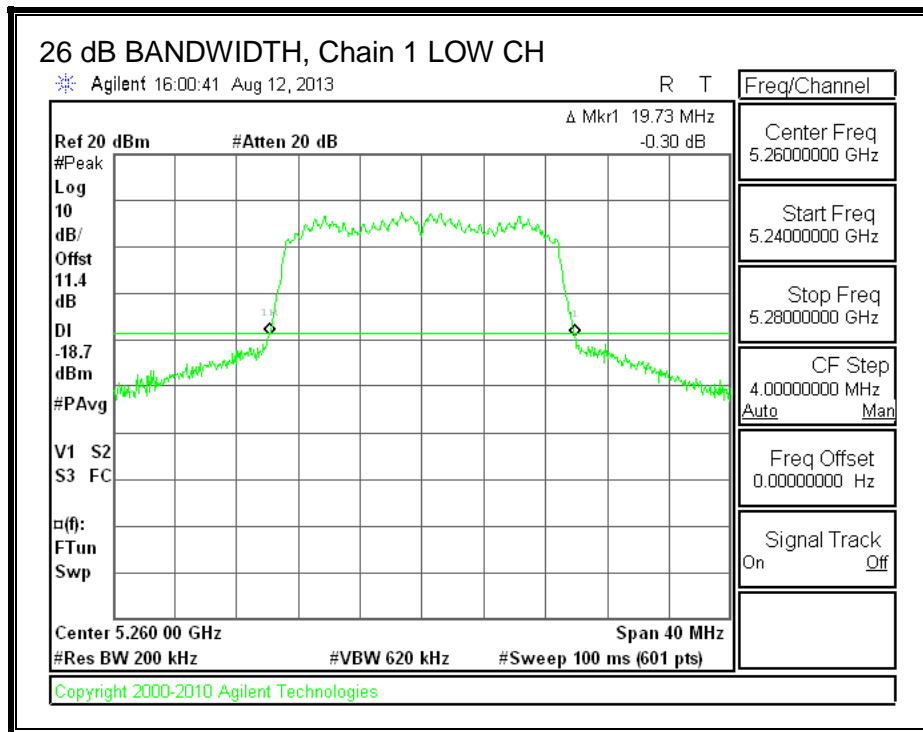



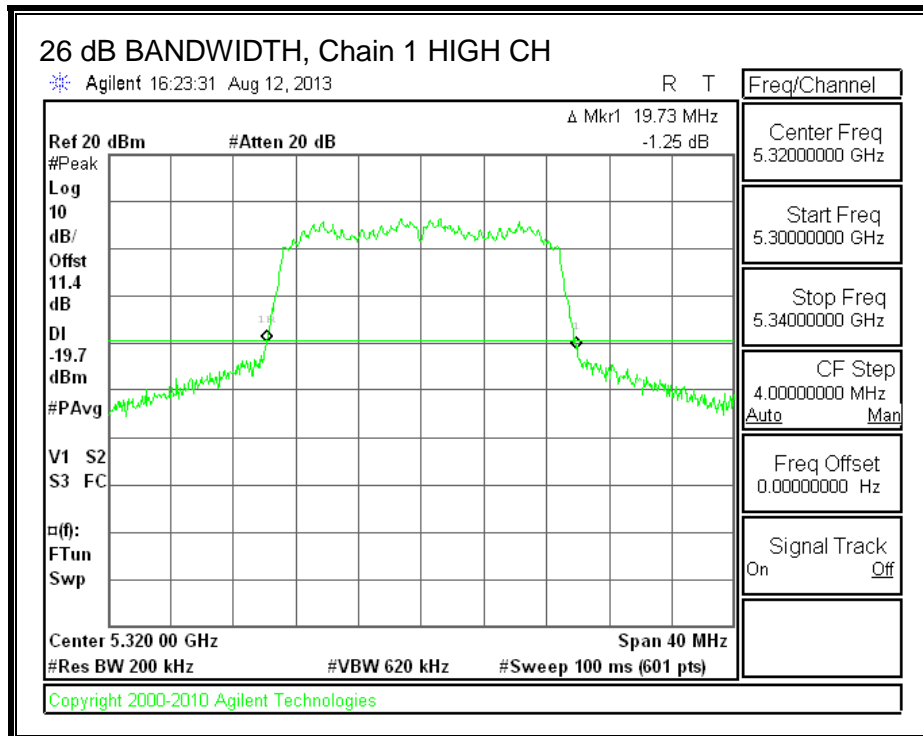
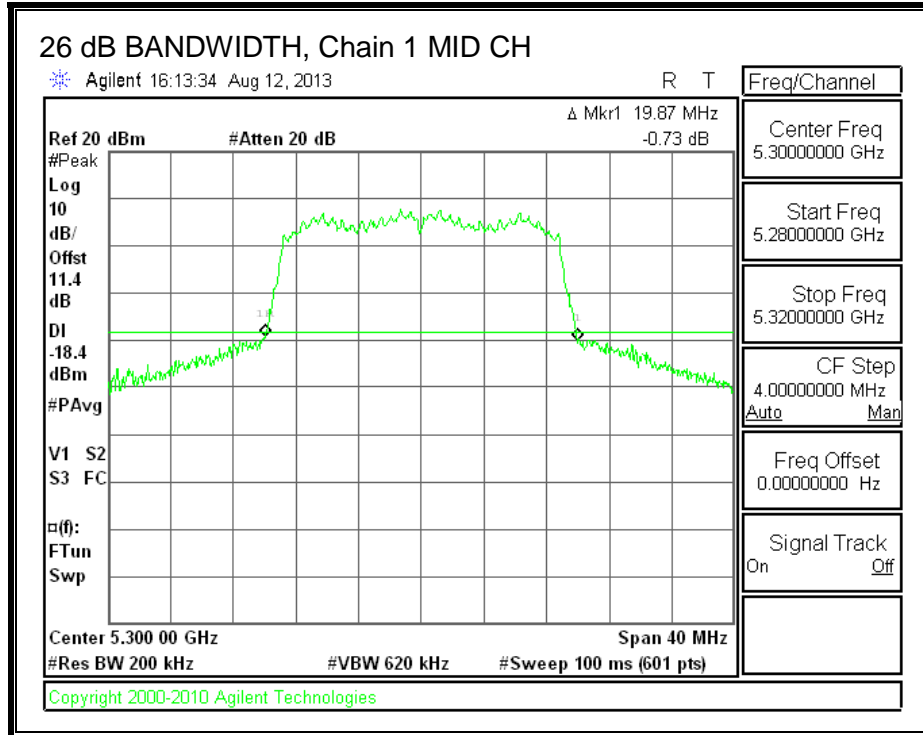

## 8.8.2. 99% BANDWIDTH

### LIMITS

None; for reporting purposes only.

### RESULTS

Channel	Frequency (MHz)	99% BW Chain 0 (MHz)	99% BW Chain 1 (MHz)
Low	5260	17.5798	17.5810
Mid	5300	17.5814	17.5618
High	5320	17.5676	17.5694

**99% BANDWIDTH**

**99% BANDWIDTH, Chain 0**

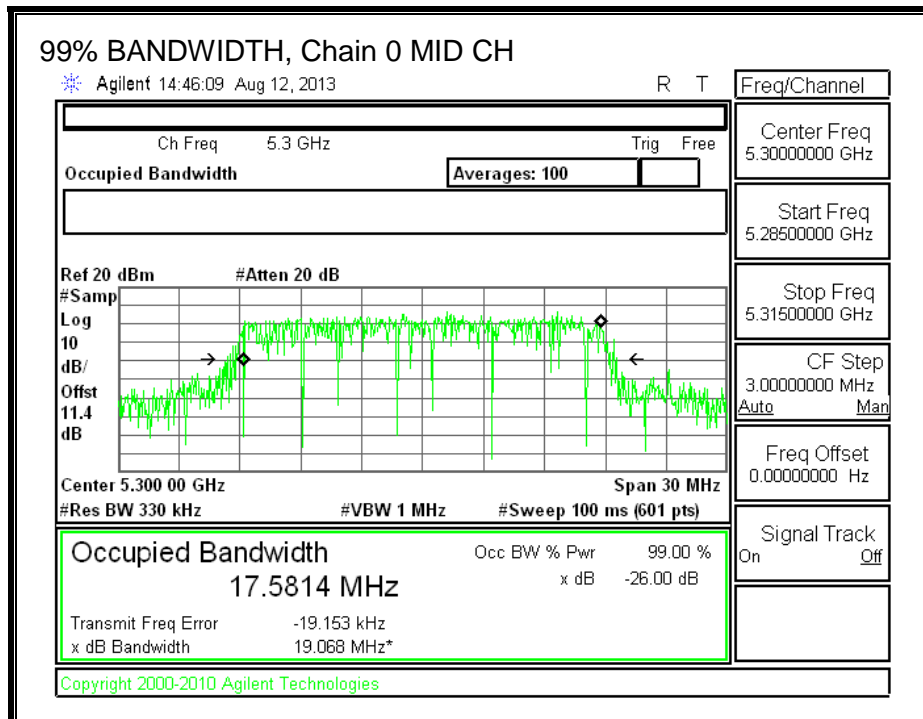
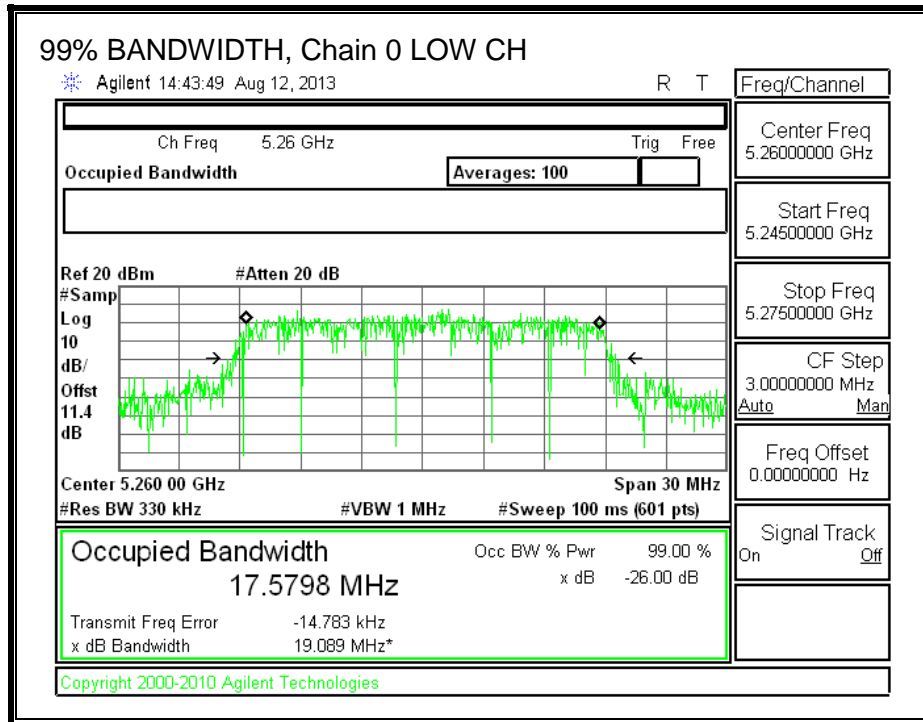

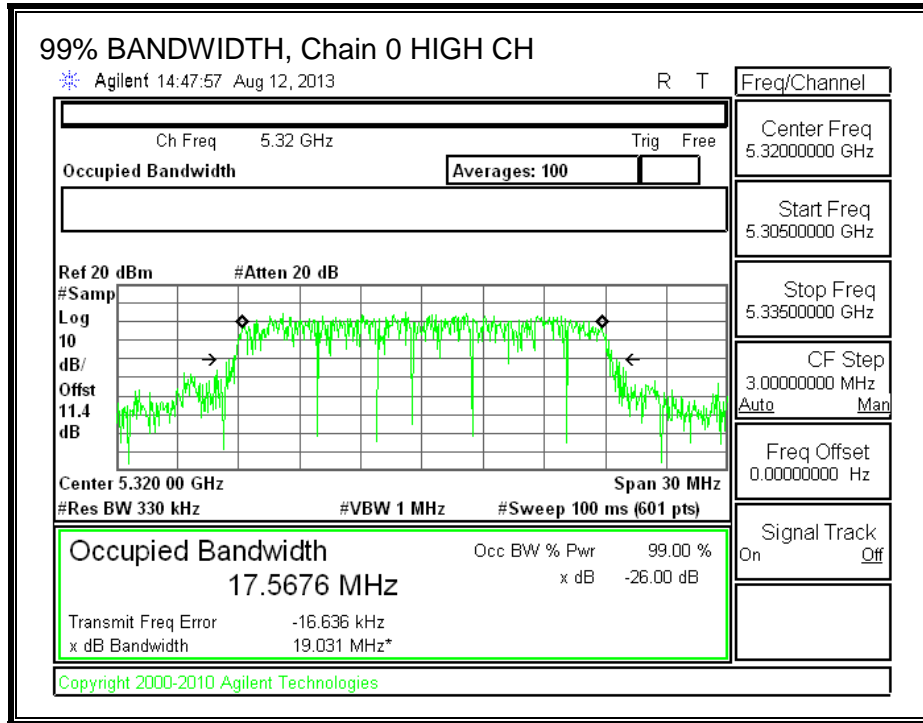

**99% BANDWIDTH, Chain 1**

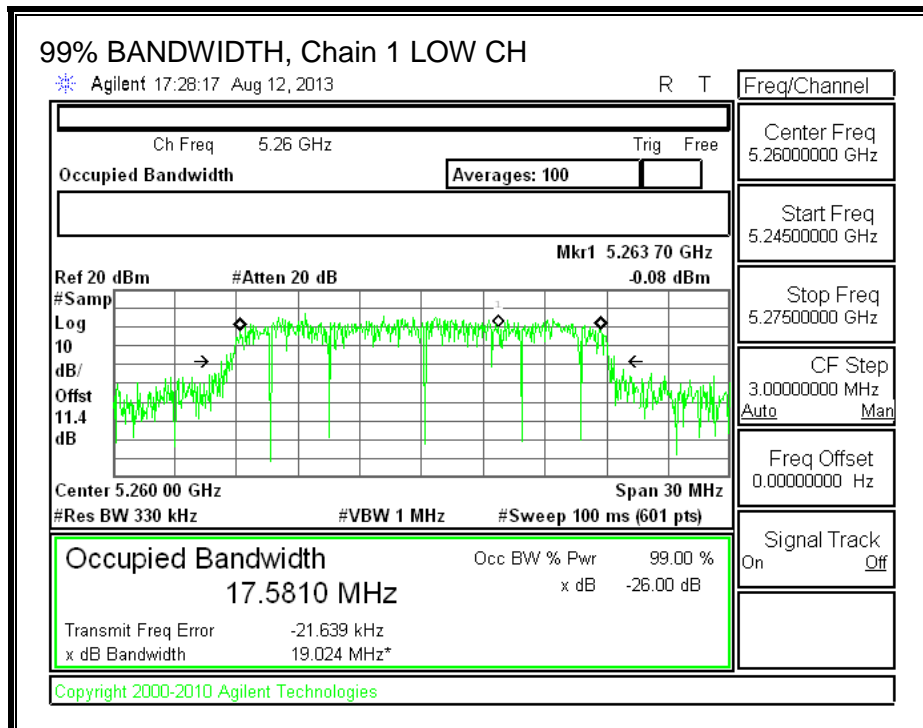

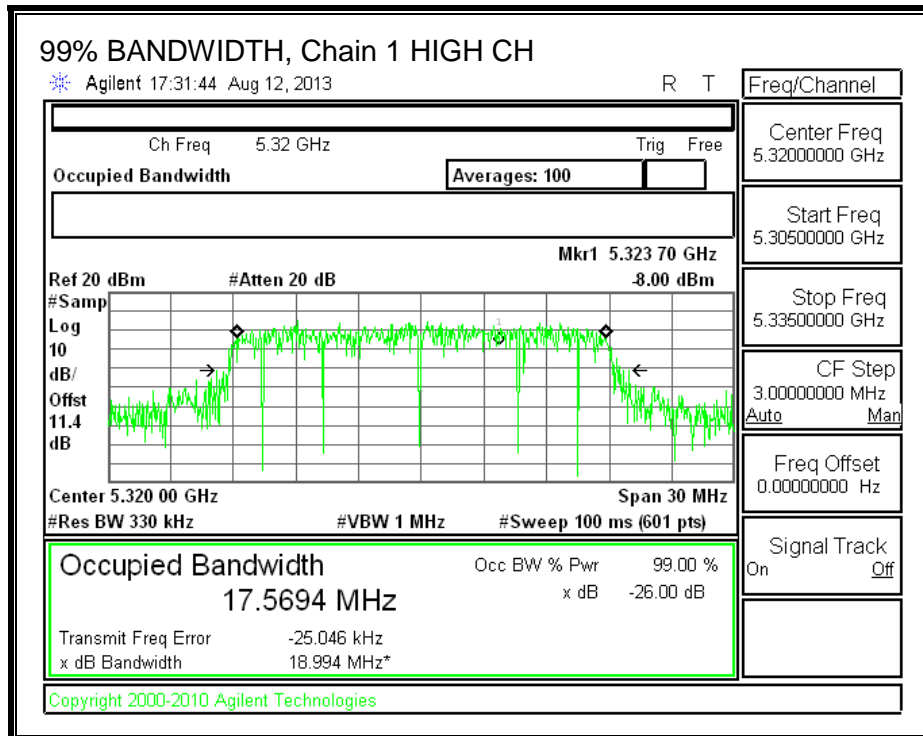
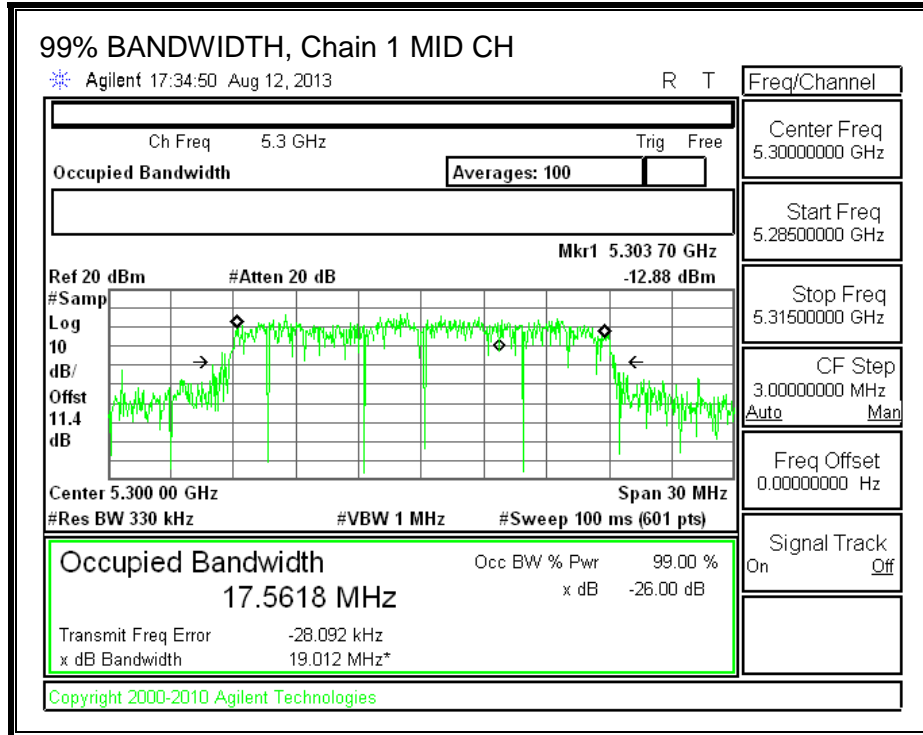

### 8.8.3. AVERAGE POWER

#### LIMITS

None; for reporting purposes only.

#### TEST PROCEDURE

The transmitter output is connected to a power meter.

The cable assembly insertion loss of 11.4 dB (including 10 dB pad and 1.4 dB cable) was entered as an offset in the power meter to allow for direct reading of power.

#### RESULTS

##### Average Power Results

Channel	Frequency (MHz)	Chain 0 Power (dBm)	Chain 1 Power (dBm)	Total Power (dBm)
Low	5260	16.28	16.34	19.32
Mid	5300	16.47	16.38	19.44
High	5320	13.96	13.94	16.96

**8.8.4. OUTPUT POWER AND PPSD**

**LIMITS**

FCC §15.407 (a) (1)

For the band 5.25–5.35 GHz, the maximum conducted output power over the frequency band of operation shall not exceed the lesser of 250 mW or 11 dBm + 10 log B, where B is the 26–dB emission bandwidth in MHz. In addition, the peak power spectral density shall not exceed 11 dBm in any 1–MHz band. If transmitting antennas of directional gain greater than 6 dBi are used, both the maximum conducted output power and the peak power spectral density shall be reduced by the amount in dB that the directional gain of the antenna exceeds 6 dBi.

IC RSS-210 A9.2 (1)

The maximum e.i.r.p. shall not exceed 200 mW or 10 + 10 log<sub>10</sub> B, dBm, whichever power is less. B is the 99% emission bandwidth in MHz. The e.i.r.p. spectral density shall not exceed 10 dBm in any 1.0 MHz band.

**DIRECTIONAL ANTENNA GAIN**

For output power, the TX chains are uncorrelated and the antenna gain is unequal among the chains. The directional gain is:

Chain 0 Antenna Gain (dBi)	Chain 1 Antenna Gain (dBi)	Uncorrelated Chains Directional Gain (dBi)
2.60	2.11	2.36

For PPSD, the TX chains are correlated and the antenna gain is unequal among the chains. The directional gain is:

Chain 0 Antenna Gain (dBi)	Chain 1 Antenna Gain (dBi)	Correlated Chains Directional Gain (dBi)
2.60	2.11	5.37

**RESULTS**

**Bandwidth and Antenna Gain**

Channel	Frequency (MHz)	Min 26 dB BW (MHz)	Min 99% BW (MHz)	Uncorrelated Directional Gain (dBi)	Correlated Directional Gain (dBi)
Low	5260	19.73	17.58	2.36	5.37
Mid	5300	19.87	17.56	2.36	5.37
High	5320	19.73	17.57	2.36	5.37

**Limits**

Channel	Frequency (MHz)	FCC Power Limit (dBm)	IC Power Limit (dBm)	IC EIRP Limit (dBm)	Power Limit (dBm)	FCC PPSD Limit (dBm)	IC PSD Limit (dBm)	PPSD Limit (dBm)
Low	5260	23.95	23.45	29.45	23.45	11.00	11.00	11.00
Mid	5300	23.98	23.45	29.45	23.45	11.00	11.00	11.00
High	5320	23.95	23.45	29.45	23.45	11.00	11.00	11.00

<b>Duty Cycle CF (dB)</b>	0.00	<b>Included in Calculations of Corr'd Power &amp; PPSD</b>
---------------------------	------	--

**Output Power Results**

Channel	Frequency (MHz)	Chain 0 Meas Power (dBm)	Chain 1 Meas Power (dBm)	Total Corr'd Power (dBm)	Power Limit (dBm)	Power Margin (dB)
Low	5260	16.96	16.62	19.80	23.45	-3.65
Mid	5300	16.89	16.67	19.79	23.45	-3.65
High	5320	14.14	14.04	17.10	23.45	-6.34

**PPSD Results**

Channel	Frequency (MHz)	Chain 0 Meas PPSD (dBm)	Chain 1 Meas PPSD (dBm)	Total Corr'd PPSD (dBm)	PPSD Limit (dBm)	PPSD Margin (dB)
Low	5260	6.73	6.87	9.81	11.00	-1.19
Mid	5300	6.74	6.64	9.70	11.00	-1.30
High	5320	2.56	2.18	5.38	11.00	-5.62



**OUTPUT POWER AND PPSD, Chain 0**

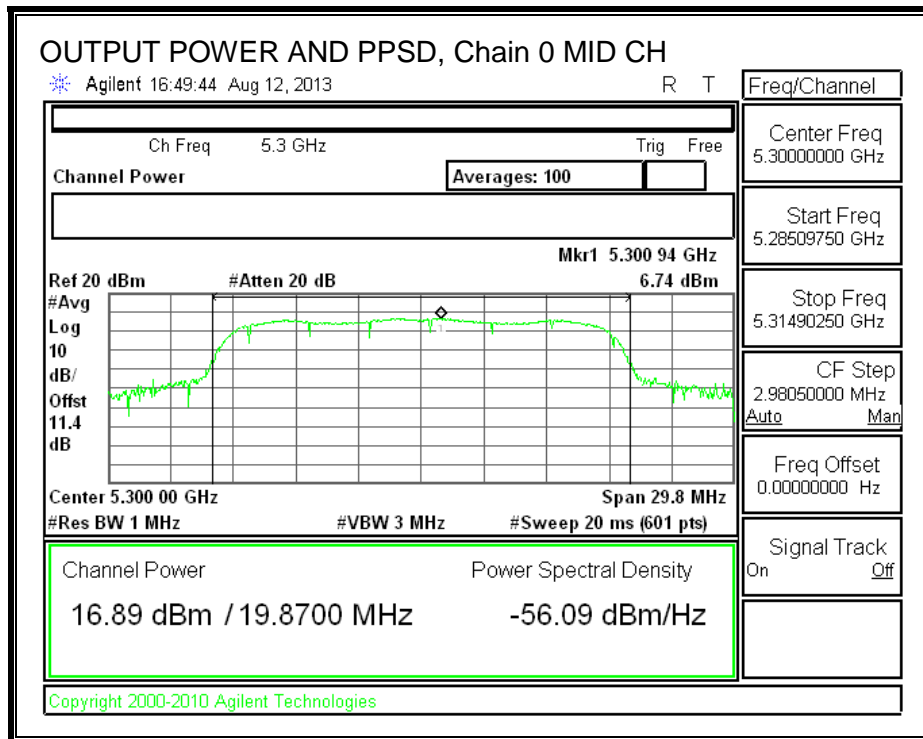
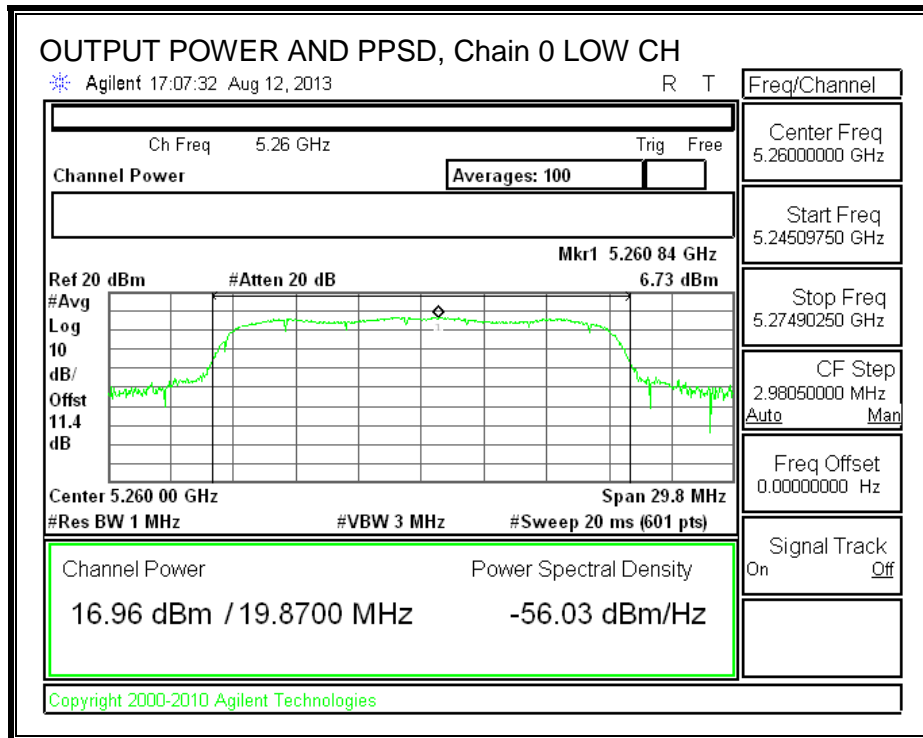

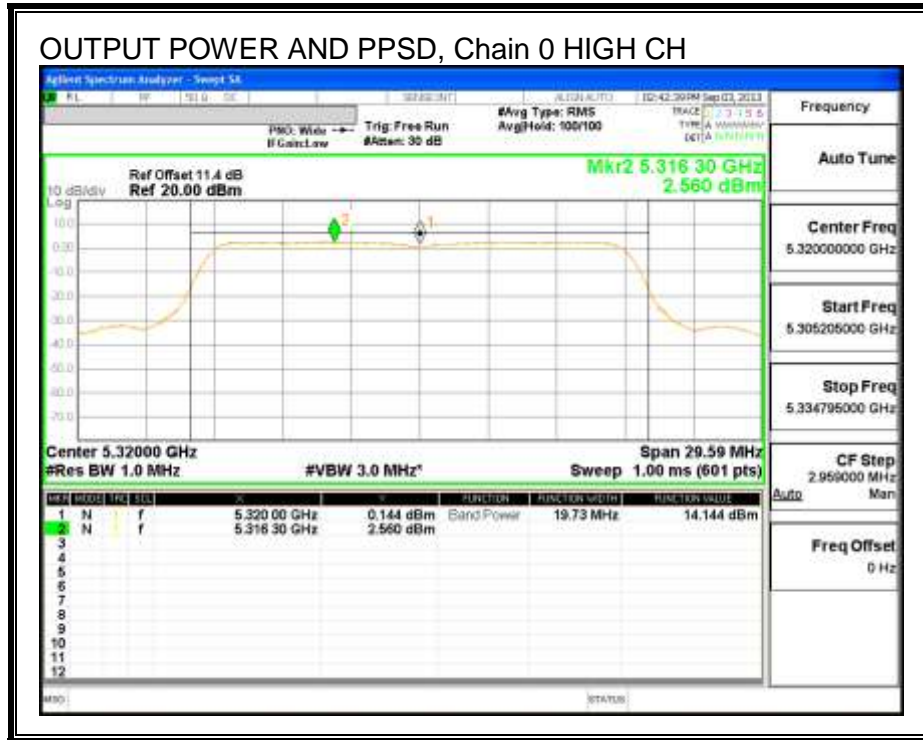

### OUTPUT POWER AND PPSD, Chain 1

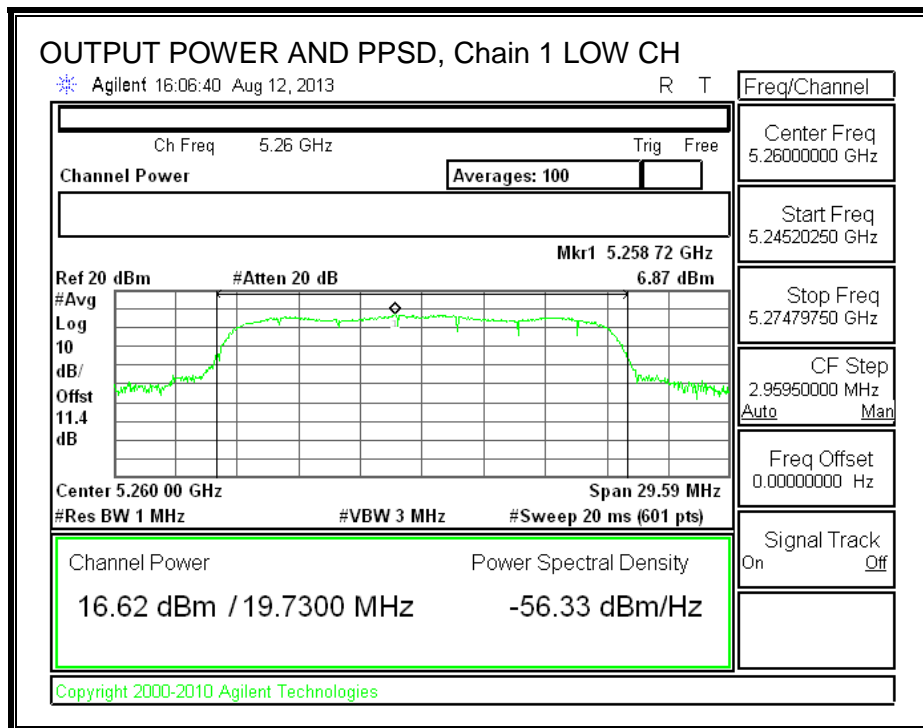

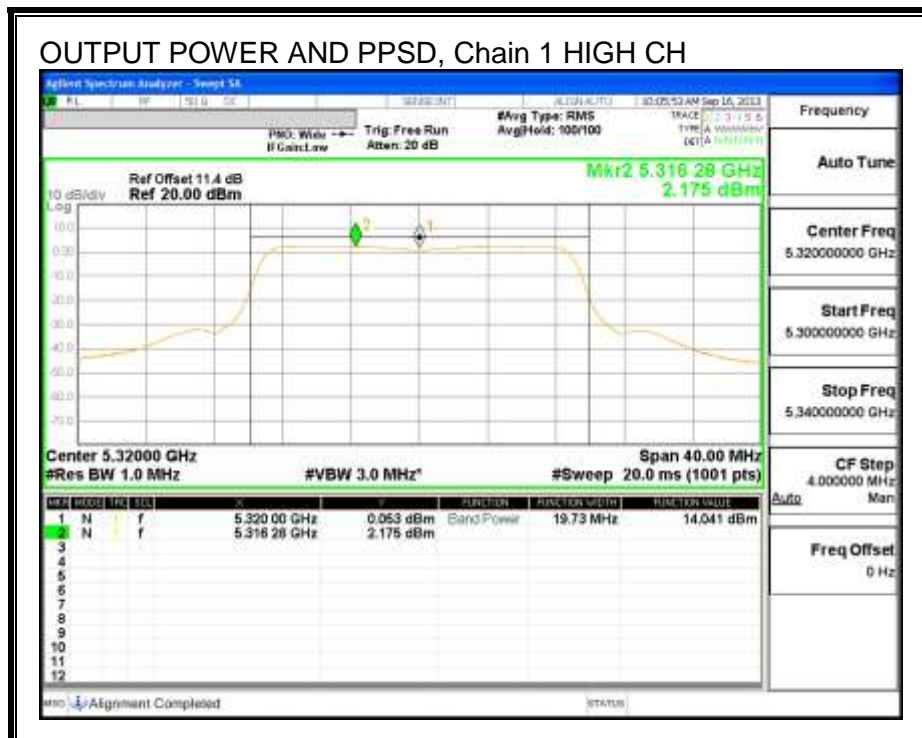
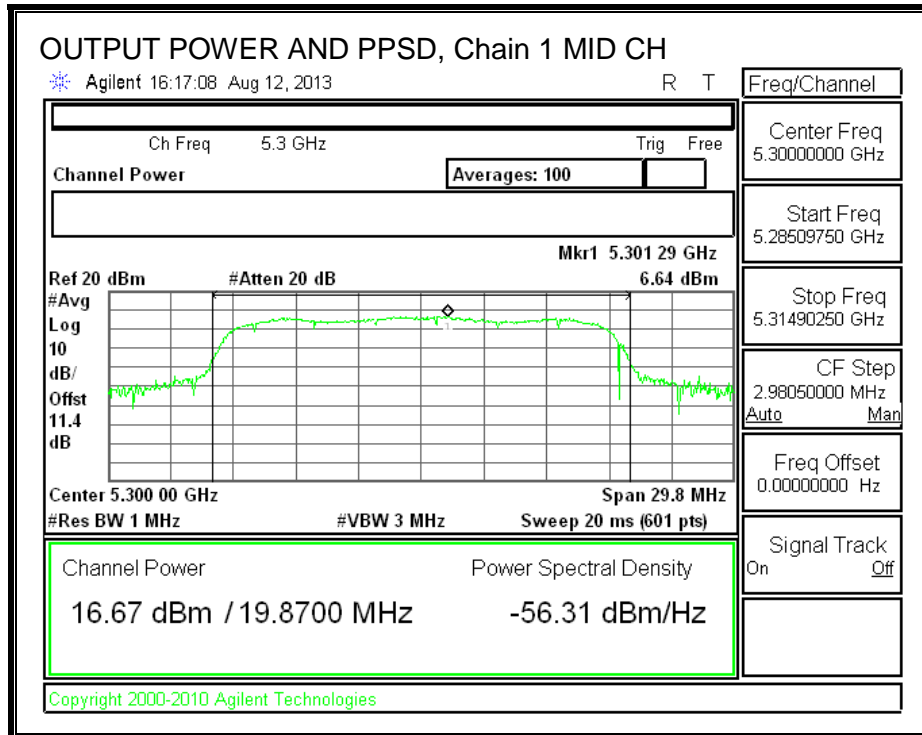

### 8.8.5. PEAK EXCURSION

#### LIMITS

FCC §15.407 (a) (6)

The ratio of the peak excursion of the modulation envelope (measured using a peak hold function) to the peak transmit power (measured as specified above) shall not exceed 13 dB across any 1 MHz bandwidth or the emission bandwidth whichever is less.

#### RESULTS

Chain 0

Channel	Frequency (MHz)	PK Level (dBm)	PSD (dBm)	DCCF (dB)	Peak Excursion (dB)	Limit (dB)	Margin (dB)
Mid	5300	12.65	6.74	0.00	5.91	13	-7.09

Chain 1

Channel	Frequency (MHz)	PK Level (dBm)	PSD (dBm)	DCCF (dB)	Peak Excursion (dB)	Limit (dB)	Margin (dB)
Mid	5300	12.79	6.64	0.00	6.15	13	-6.85

**PEAK EXCURSION, Chain 0**

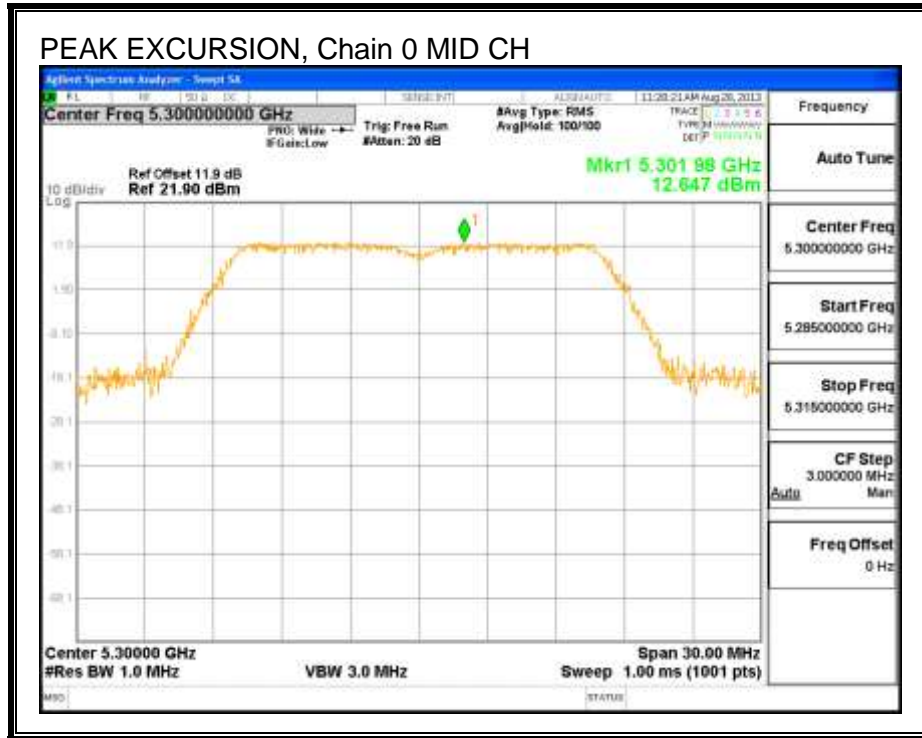

**PEAK EXCURSION, Chain 1**

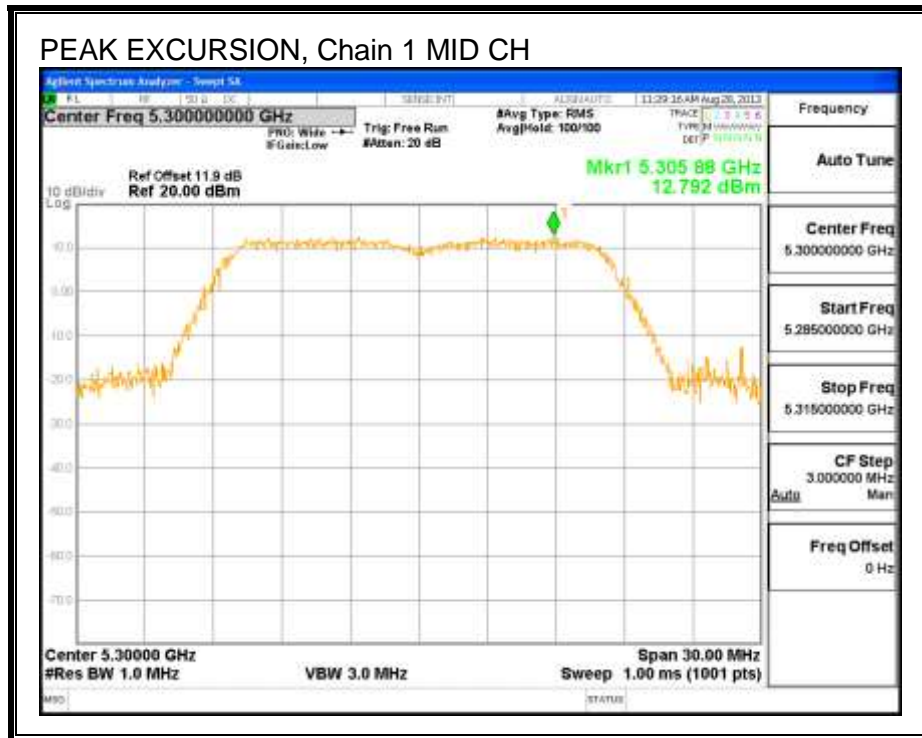

## 8.9. 802.11n HT40 SISO MODE IN THE 5.3 GHz BAND

### 8.9.1. 26 dB BANDWIDTH

#### LIMITS

None; for reporting purposes only.

#### RESULTS

Channel	Frequency (MHz)	26 dB Bandwidth (MHz)
Low	5270	40.00
High	5310	40.13

**26 dB BANDWIDTH**

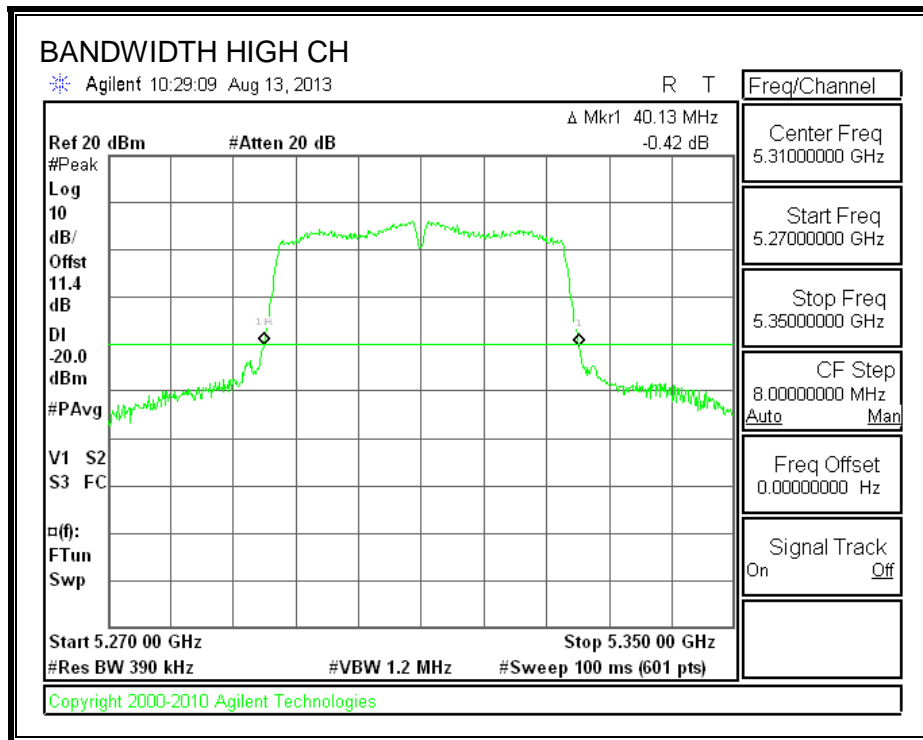
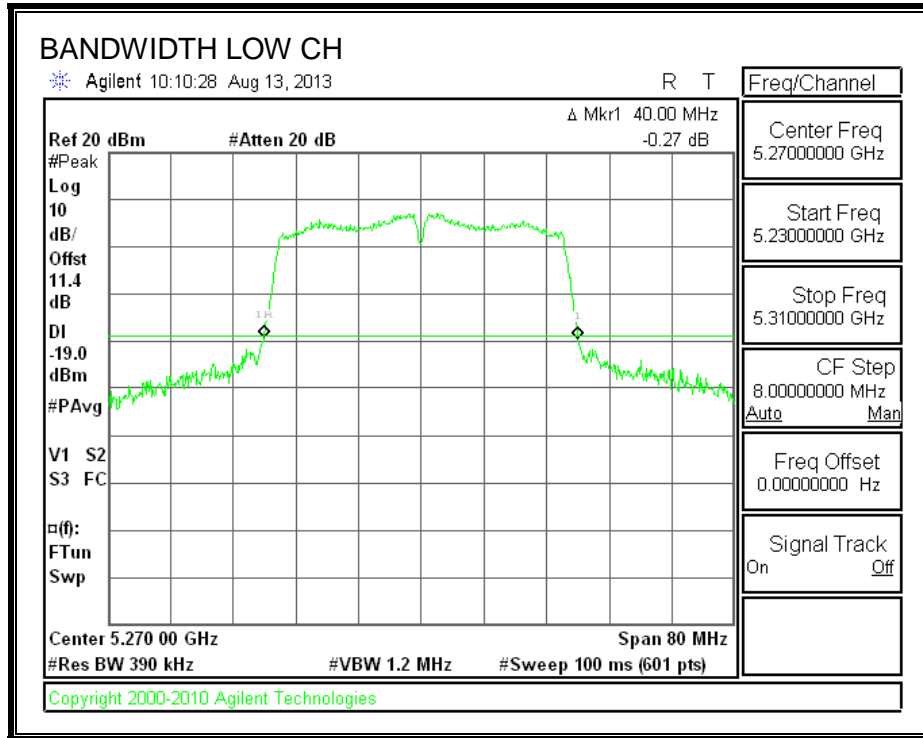

### 8.9.2. 99% BANDWIDTH

#### LIMITS

None; for reporting purposes only.

#### RESULTS

Channel	Frequency (MHz)	99% Bandwidth (MHz)
Low	5270	36.2310
High	5310	36.2270



**99% BANDWIDTH**

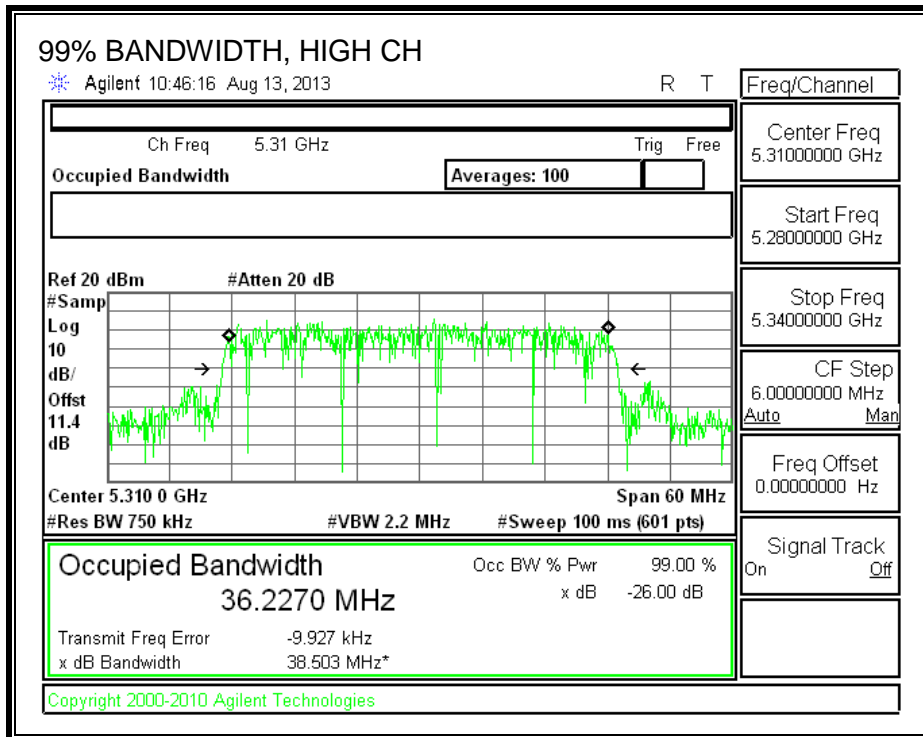
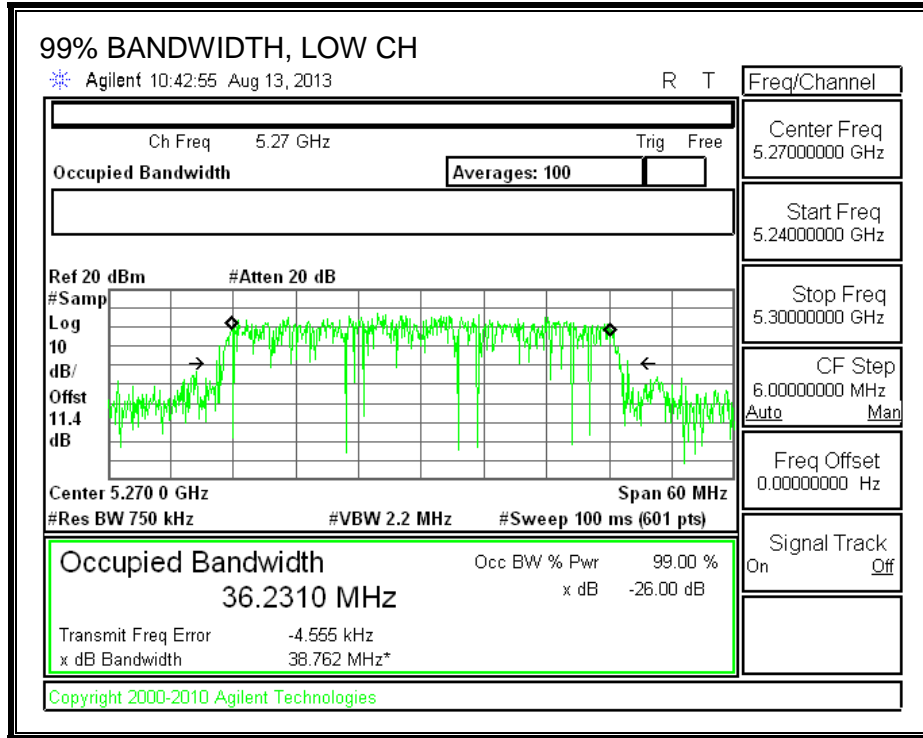

### 8.9.3. AVERAGE POWER

#### LIMITS

None; for reporting purposes only.

#### TEST PROCEDURE

The transmitter output is connected to a power meter.

The cable assembly insertion loss of 11.9 dB (including 10 dB pad and 1.9 dB cable) was entered as an offset in the power meter to allow for direct reading of power.

#### RESULTS

Channel	Frequency (MHz)	Power (dBm)
Low	5270	16.26
High	5310	14.37

## **8.9.4. OUTPUT POWER AND PPSD**

### **LIMITS**

FCC §15.407 (a) (1)

For the band 5.25–5.35 GHz, the maximum conducted output power over the frequency band of operation shall not exceed the lesser of 250 mW or  $11 \text{ dBm} + 10 \log B$ , where B is the 26–dB emission bandwidth in MHz. In addition, the peak power spectral density shall not exceed 11 dBm in any 1–MHz band. If transmitting antennas of directional gain greater than 6 dBi are used, both the maximum conducted output power and the peak power spectral density shall be reduced by the amount in dB that the directional gain of the antenna exceeds 6 dBi.

IC RSS-210 A9.2 (1)

The maximum e.i.r.p. shall not exceed 200 mW or  $10 + 10 \log_{10} B$ , dBm, whichever power is less. B is the 99% emission bandwidth in MHz. The e.i.r.p. spectral density shall not exceed 10 dBm in any 1.0 MHz band.

### **DIRECTIONAL ANTENNA GAIN**

There is only one transmitter output therefore the directional gain is equal to the antenna gain.

**RESULTS**

**Bandwidth and Antenna Gain**

Channel	Frequency (MHz)	Min 26 dB BW (MHz)	Min 99% BW (MHz)	Directional Gain (dBi)
Low	5270	40.00	36.23	2.60
High	5310	40.13	36.23	2.60

**Limits**

Channel	Frequency (MHz)	FCC Power Limit (dBm)	IC Power Limit (dBm)	IC EIRP Limit (dBm)	Power Limit (dBm)	FCC PPSD Limit (dBm)	IC PSD Limit (dBm)	PPSD Limit (dBm)
Low	5270	24.00	24.00	30.00	24.00	11.00	11.00	11.00
High	5310	24.00	24.00	30.00	24.00	11.00	11.00	11.00

<b>Duty Cycle CF (dB)</b>	0.00	<b>Included in Calculations of Corr'd Power &amp; PPSD</b>
---------------------------	------	--

**Output Power Results**

Channel	Frequency (MHz)	Chain 0 Meas Power (dBm)	Total Corr'd Power (dBm)	Power Limit (dBm)	Power Margin (dB)
Low	5270	16.53	16.53	24.00	-7.47
High	5310	14.52	14.52	24.00	-9.48

**PPSD Results**

Channel	Frequency (MHz)	Chain 0 Meas PPSD (dBm)	Total Corr'd PPSD (dBm)	PPSD Limit (dBm)	PPSD Margin (dB)
Low	5270	3.76	3.76	11.00	-7.24
High	5310	1.25	1.25	11.00	-9.75

**OUTPUT POWER AND PPSD, Chain 0**

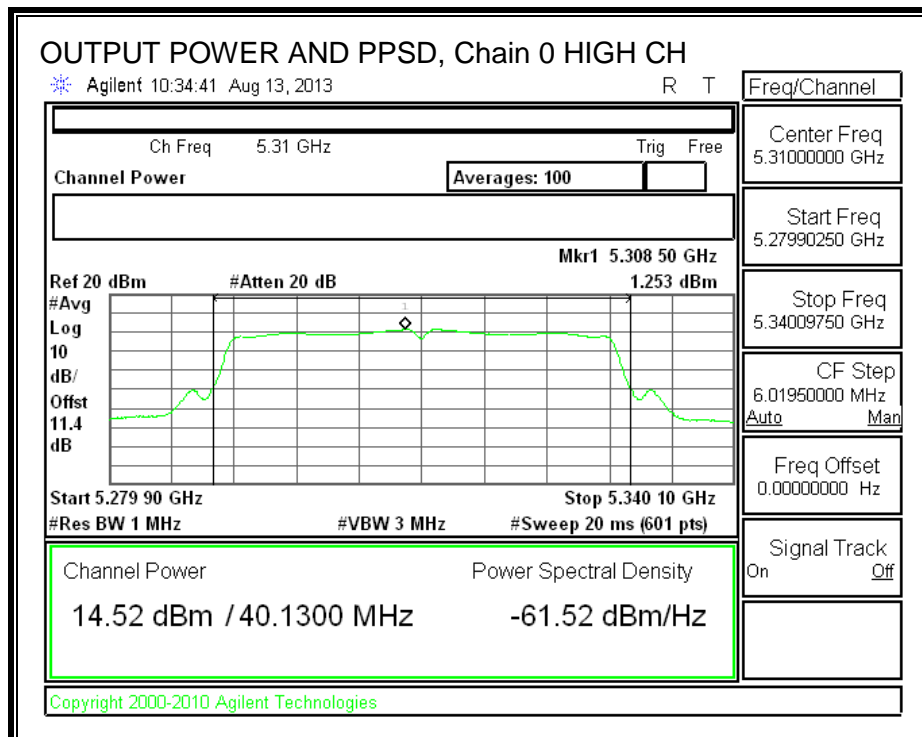
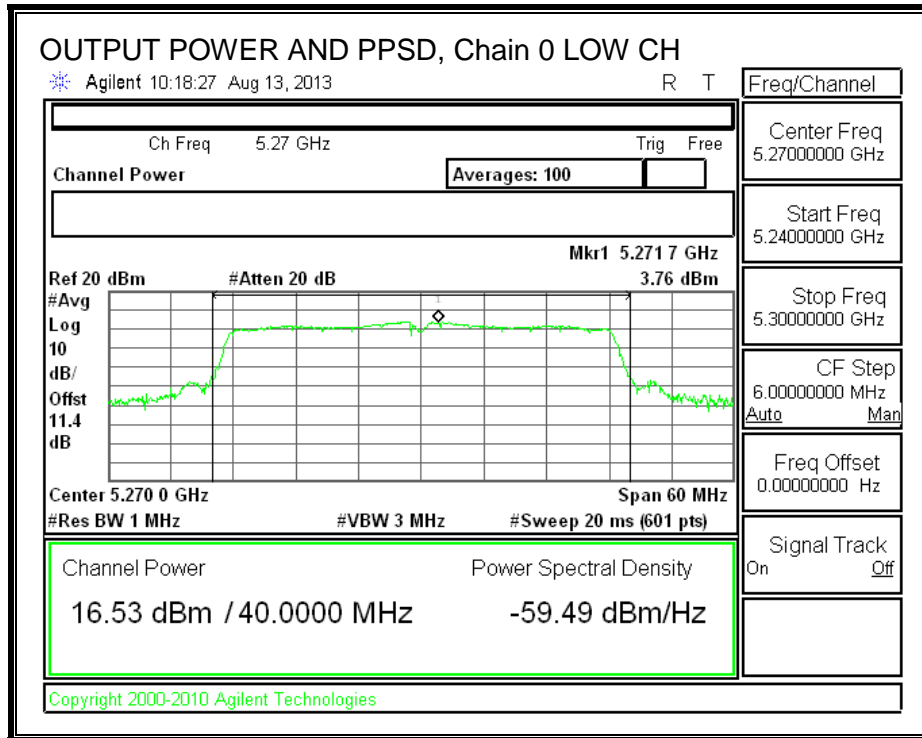

### 8.9.5. PEAK EXCURSION

#### LIMITS

FCC §15.407 (a) (6)

The ratio of the peak excursion of the modulation envelope (measured using a peak hold function) to the peak transmit power (measured as specified above) shall not exceed 13 dB across any 1 MHz bandwidth or the emission bandwidth whichever is less.

#### RESULTS

Channel	Frequency (MHz)	PK Level (dBm)	PSD (dBm)	DCCF (dB)	Peak Excursion (dB)	Limit (dB)	Margin (dB)
Mid	5270	11.15	3.76	0.00	7.39	13	-5.61

**PEAK EXCURSION**

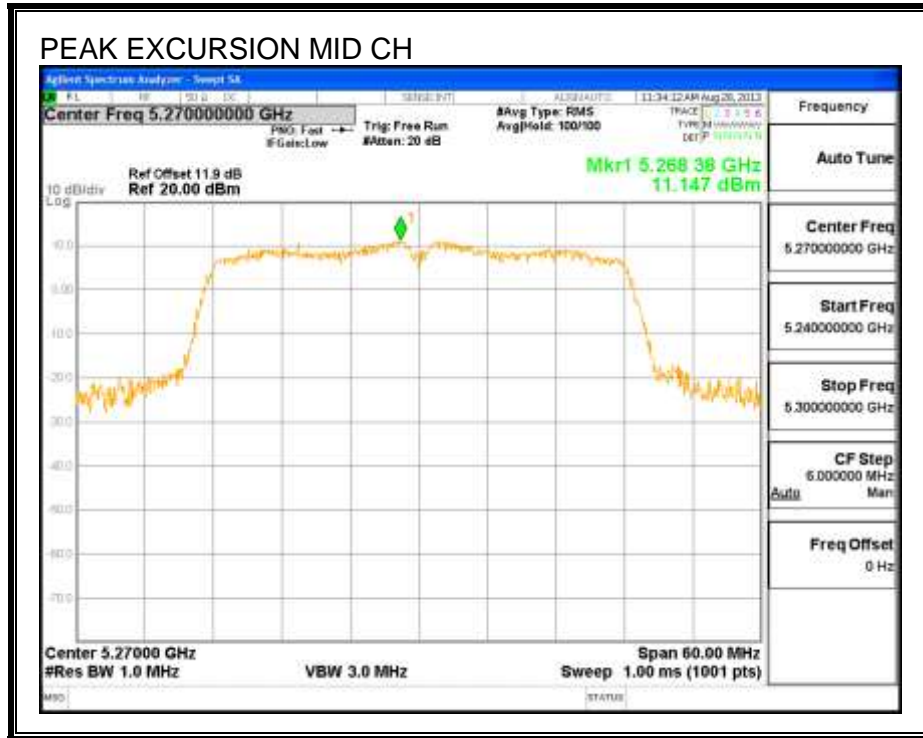

## 8.10. 802.11n HT40 2TX CDD MODE IN THE 5.3 GHZ BAND

### 8.10.1. 26 dB BANDWIDTH

#### LIMITS

None; for reporting purposes only.

#### RESULTS

Channel	Frequency (MHz)	26 dB BW Chain 0 (MHz)	26 dB BW Chain 1 (MHz)
Low	5270	44.6	39.8
High	5310	40.2	39.6



**26 dB BANDWIDTH**

**26 dB BANDWIDTH, Chain 0**

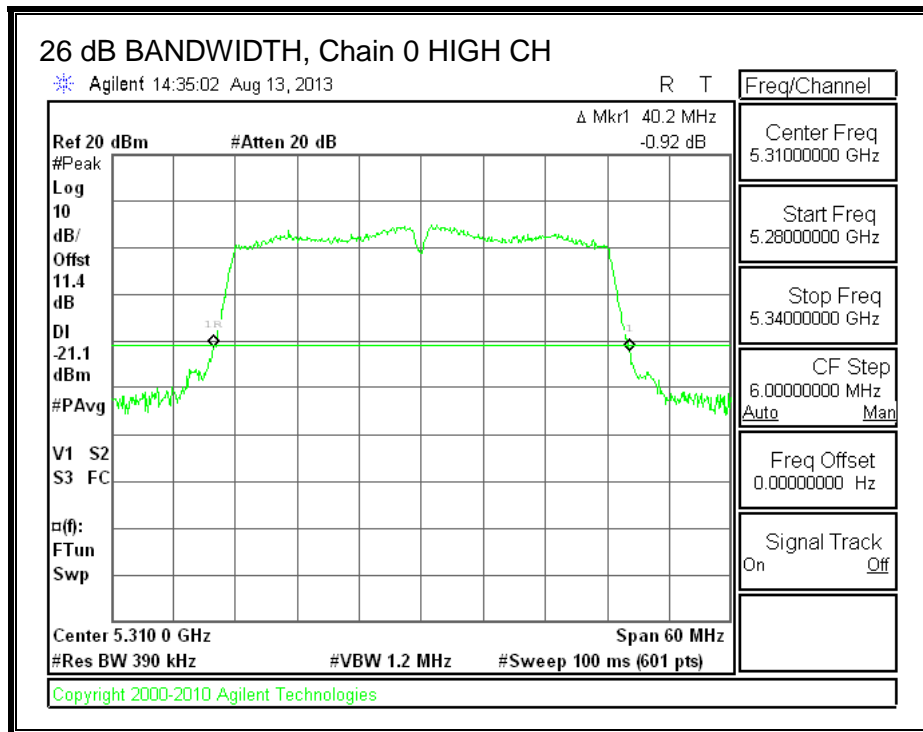
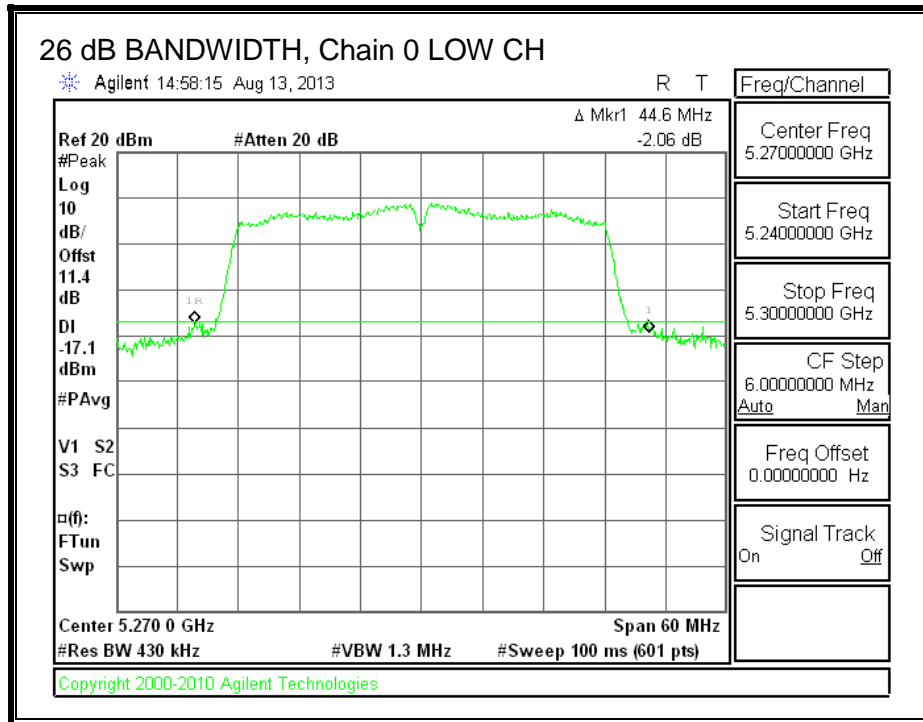

**26 dB BANDWIDTH, Chain 1**

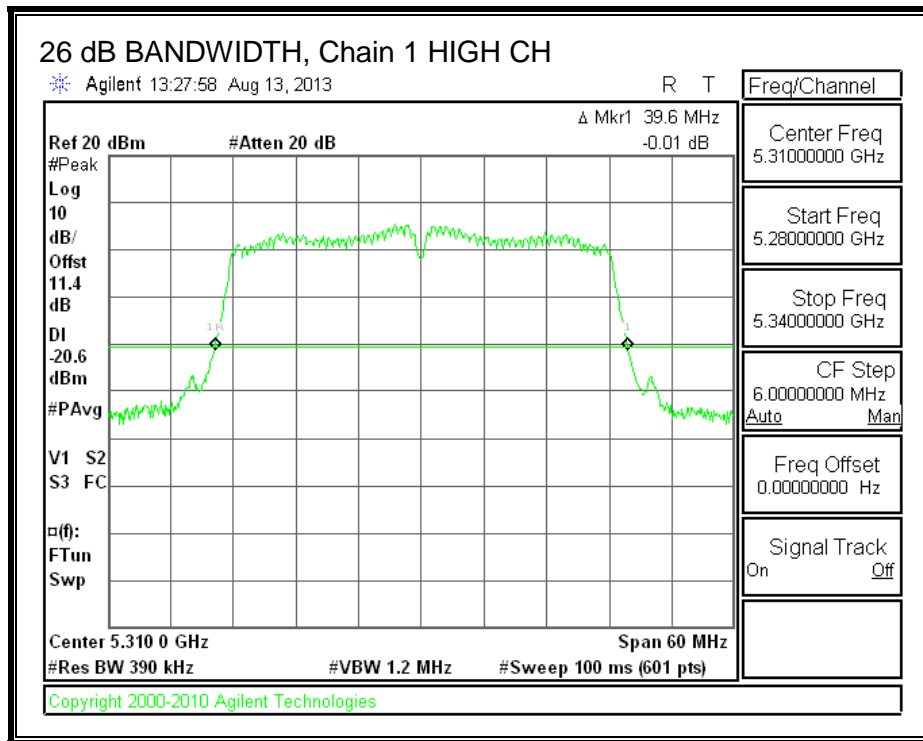
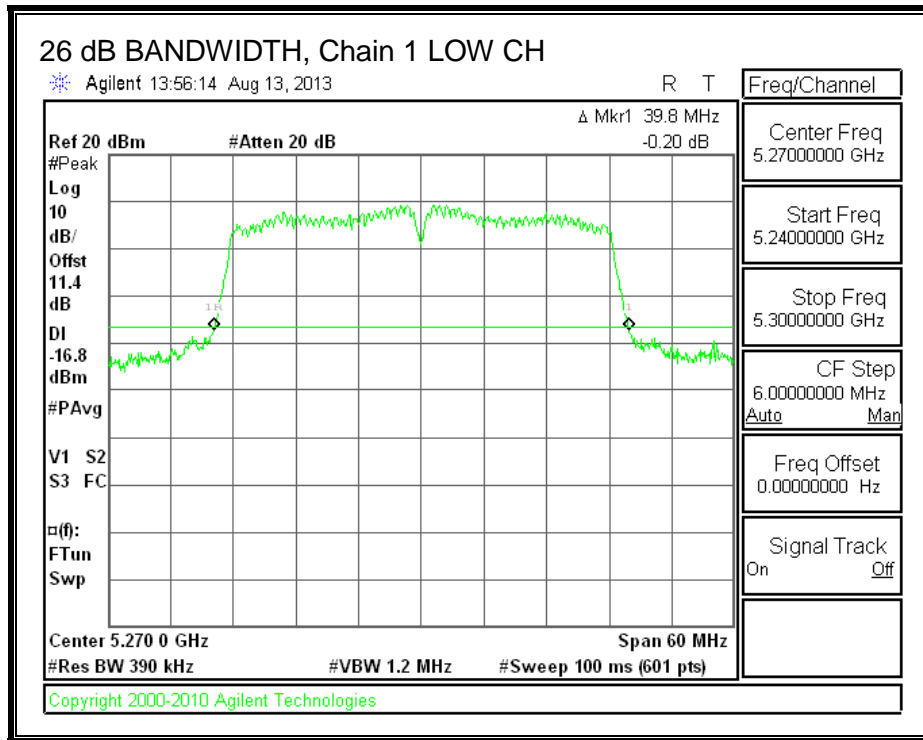

**8.10.2. 99% BANDWIDTH**

**LIMITS**

None; for reporting purposes only.

**RESULTS**

Channel	Frequency (MHz)	99% BW Chain 0 (MHz)	99% BW Chain 1 (MHz)
Low	5270	36.26	36.21
High	5310	36.23	36.19

**99% BANDWIDTH**

**99% BANDWIDTH, Chain 0**

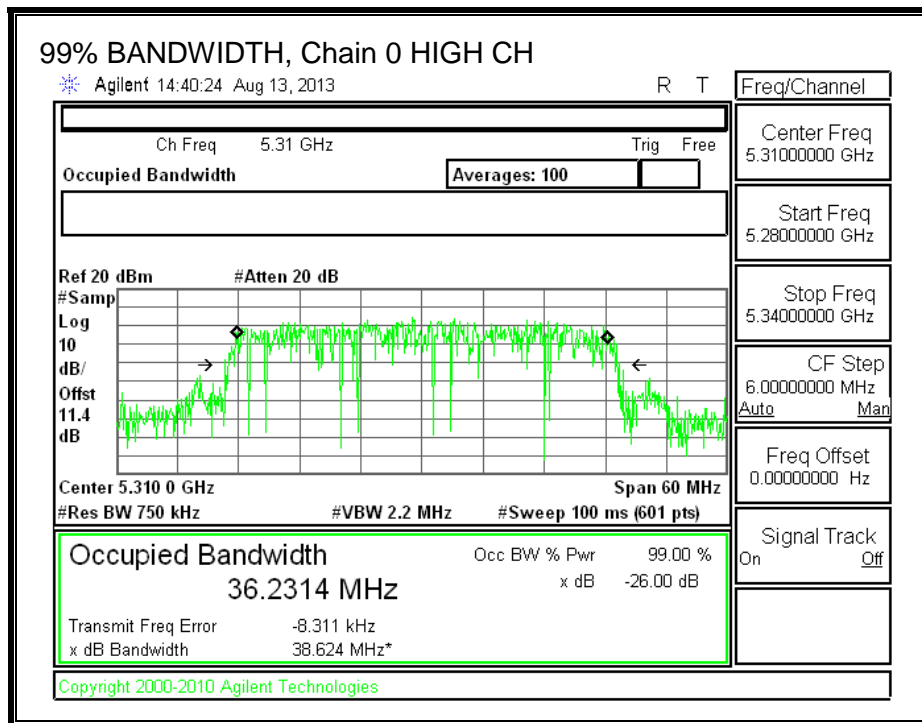
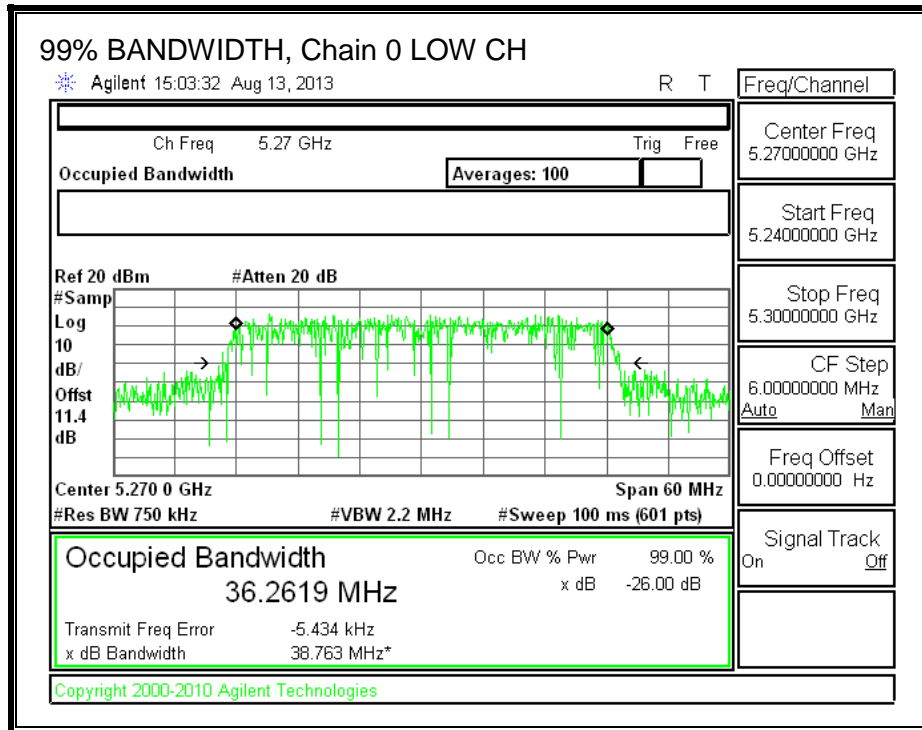

**99% BANDWIDTH, Chain 1**

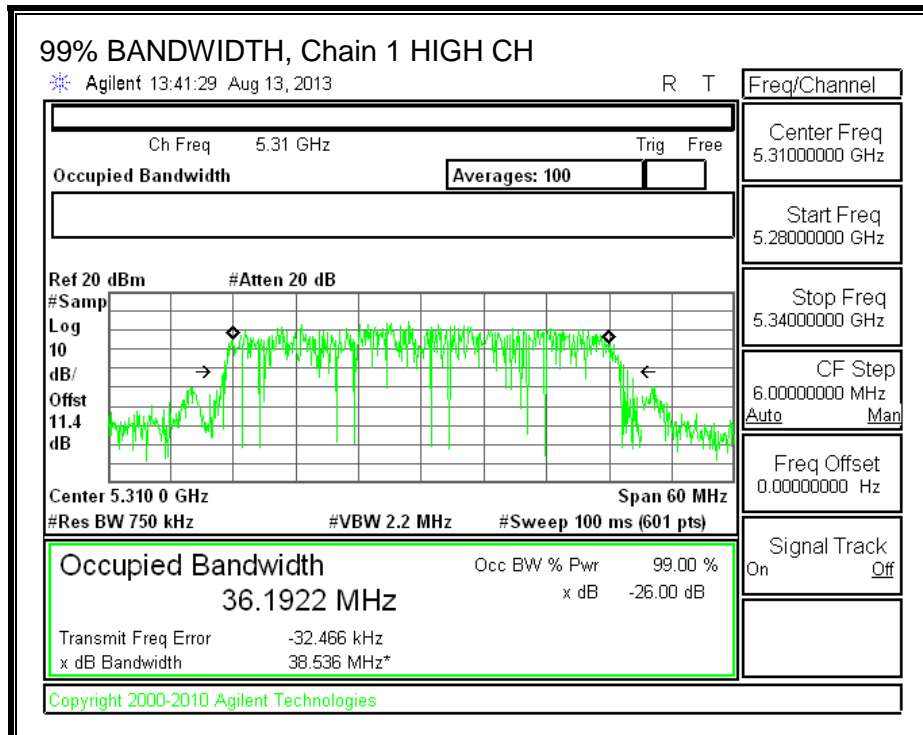
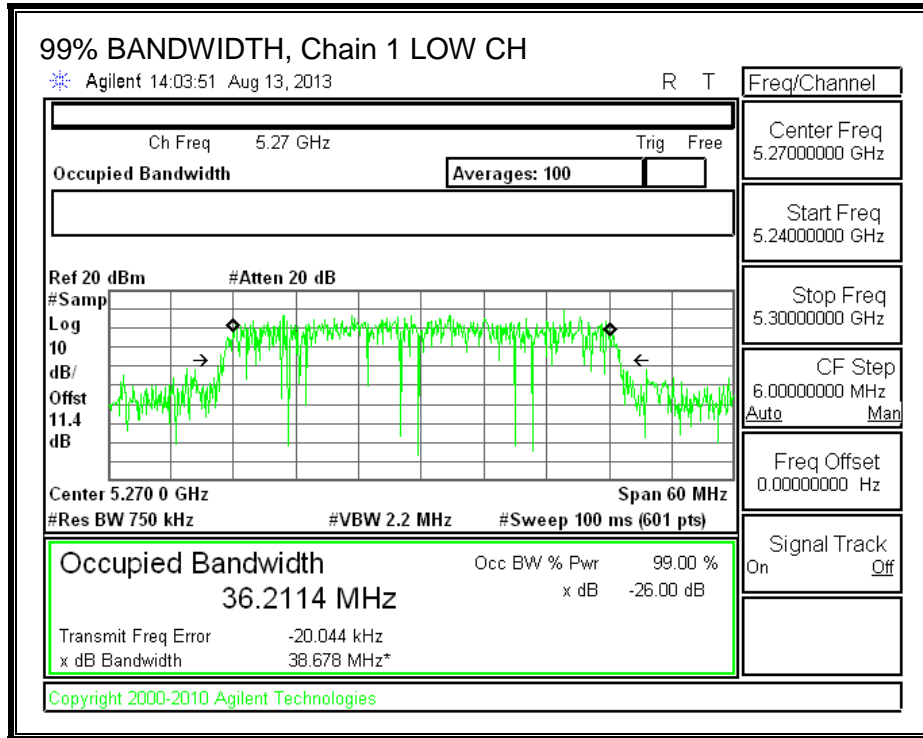

### 8.10.3. AVERAGE POWER

#### LIMITS

None; for reporting purposes only.

#### TEST PROCEDURE

The transmitter output is connected to a power meter.

The cable assembly insertion loss of 11.4 dB (including 10 dB pad and 1.4dB cable) was entered as an offset in the power meter to allow for direct reading of power.

#### RESULTS

##### Average Power Results

Channel	Frequency (MHz)	Chain 0 Power (dBm)	Chain 1 Power (dBm)	Total Power (dBm)
Low	5270	16.26	16.18	19.23
High	5310	12.34	12.48	15.42

**8.10.4. OUTPUT POWER AND PPSD**

**LIMITS**

FCC §15.407 (a) (1)

For the band 5.25–5.35 GHz, the maximum conducted output power over the frequency band of operation shall not exceed the lesser of 250 mW or 11 dBm + 10 log B, where B is the 26–dB emission bandwidth in MHz. In addition, the peak power spectral density shall not exceed 11 dBm in any 1–MHz band. If transmitting antennas of directional gain greater than 6 dBi are used, both the maximum conducted output power and the peak power spectral density shall be reduced by the amount in dB that the directional gain of the antenna exceeds 6 dBi.

IC RSS-210 A9.2 (1)

The maximum e.i.r.p. shall not exceed 200 mW or 10 + 10 log<sub>10</sub> B, dBm, whichever power is less. B is the 99% emission bandwidth in MHz. The e.i.r.p. spectral density shall not exceed 10 dBm in any 1.0 MHz band.

**DIRECTIONAL ANTENNA GAIN**

For output power, the TX chains are uncorrelated and the antenna gain is unequal among the chains. The directional gain is:

Chain 0 Antenna Gain (dBi)	Chain 1 Antenna Gain (dBi)	Uncorrelated Chains Directional Gain (dBi)
2.60	2.11	2.36

For PPSD, the TX chains are correlated and the antenna gain is unequal among the chains. The directional gain is:

Chain 0 Antenna Gain (dBi)	Chain 1 Antenna Gain (dBi)	Correlated Chains Directional Gain (dBi)
2.60	2.11	5.37

**RESULTS**

**Bandwidth and Antenna Gain**

Channel	Frequency (MHz)	Min 26 dB BW (MHz)	Min 99% BW (MHz)	Uncorrelate Directional Gain (dBi)	Correlated Directional Gain (dBi)
Low	5270	39.80	36.21	2.36	5.37
High	5310	39.00	36.19	2.36	5.37

**Limits**

Channel	Frequency (MHz)	FCC Power Limit (dBm)	IC Power Limit (dBm)	IC EIRP Limit (dBm)	Power Limit (dBm)	FCC PPSD Limit (dBm)	IC PSD Limit (dBm)	PPSD Limit (dBm)
Low	5270	24.00	24.00	30.00	24.00	11.00	11.00	11.00
High	5310	24.00	24.00	30.00	24.00	11.00	11.00	11.00

<b>Duty Cycle CF (dB)</b>	0.00	<b>Included in Calculations of Corr'd Power &amp; PPSD</b>
---------------------------	------	--

**Output Power Results**

Channel	Frequency (MHz)	Chain 0 Meas Power (dBm)	Chain 1 Meas Power (dBm)	Total Corr'd Power (dBm)	Power Limit (dBm)	Power Margin (dB)
Low	5270	16.28	16.62	19.46	24.00	-4.54
High	5310	12.73	12.57	15.66	24.00	-8.34

**PPSD Results**

Channel	Frequency (MHz)	Chain 0 Meas PPSD (dBm)	Chain 1 Meas PPSD (dBm)	Total Corr'd PPSD (dBm)	PPSD Limit (dBm)	PPSD Margin (dB)
Low	5270	3.59	4.20	6.91	11.00	-4.09
High	5310	0.01	-0.09	2.97	11.00	-8.03



**OUTPUT POWER AND PPSD, Chain 0**

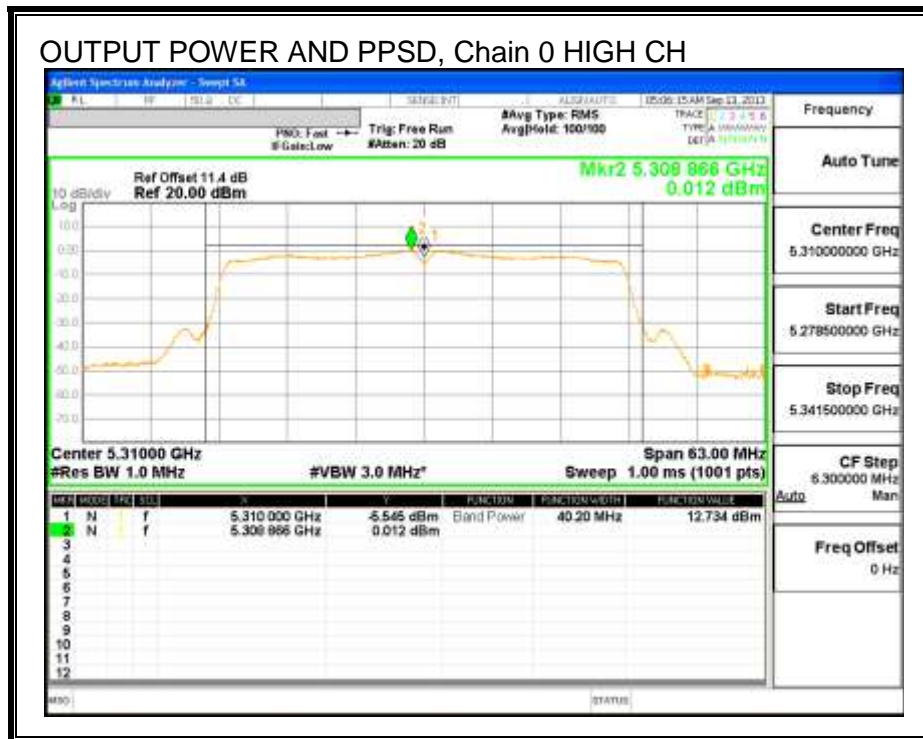
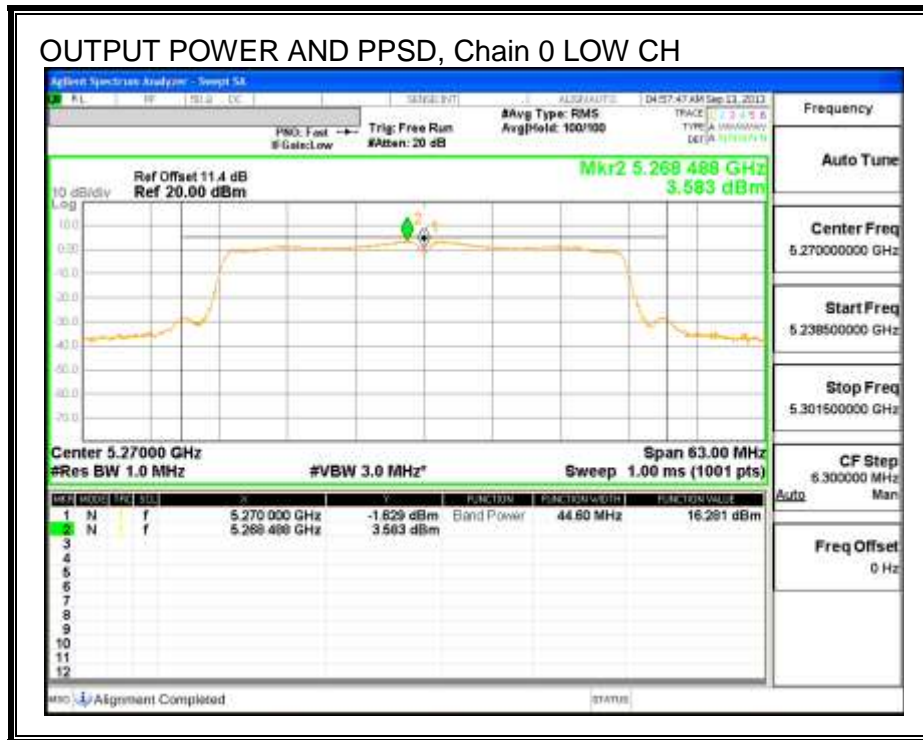

**OUTPUT POWER AND PPSD, Chain 1**

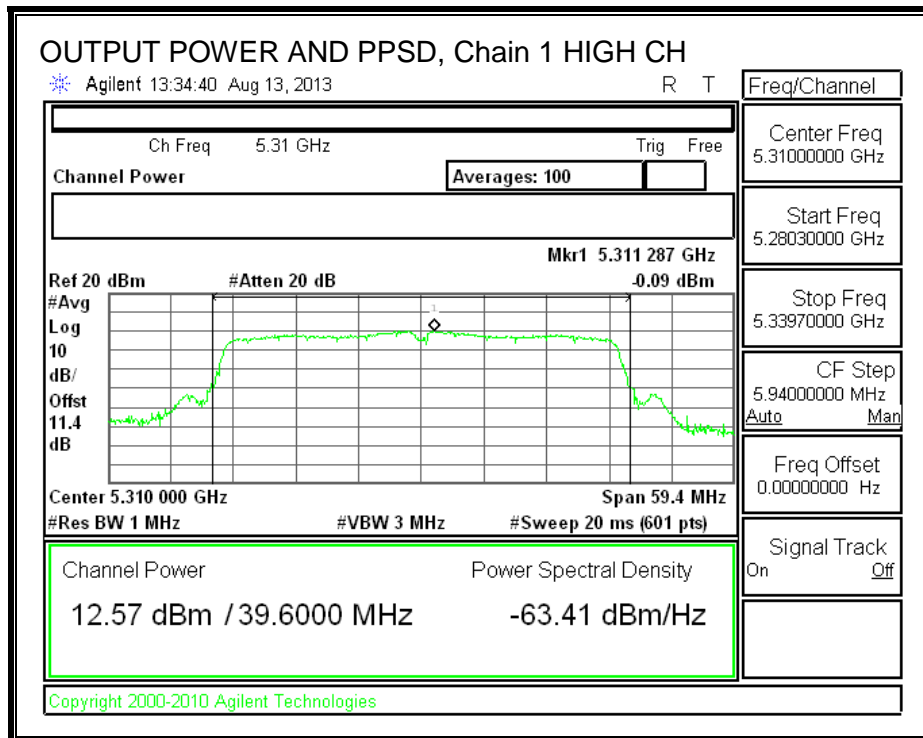
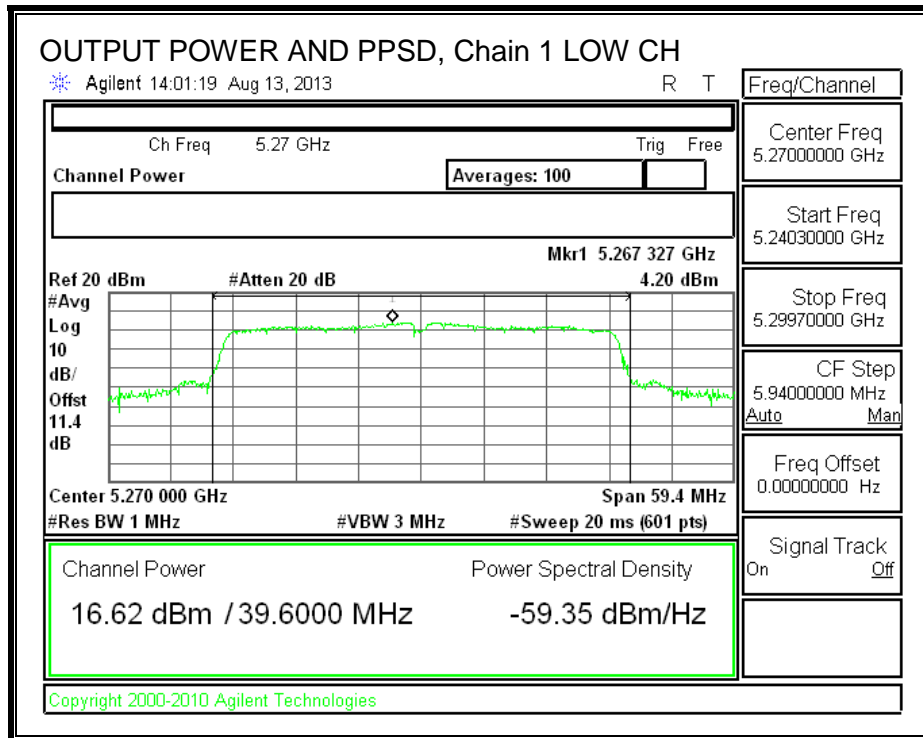

### 8.10.5. PEAK EXCURSION

#### LIMITS

FCC §15.407 (a) (6)

The ratio of the peak excursion of the modulation envelope (measured using a peak hold function) to the peak transmit power (measured as specified above) shall not exceed 13 dB across any 1 MHz bandwidth or the emission bandwidth whichever is less.

#### RESULTS

Chain 0

Channel	Frequency (MHz)	PK Level (dBm)	PSD (dBm)	DCCF (dB)	Peak Excursion (dB)	Limit (dB)	Margin (dB)
Mid	5270	11.51	4.47	0.00	7.04	13	-5.96

Chain 1

Channel	Frequency (MHz)	PK Level (dBm)	PSD (dBm)	DCCF (dB)	Peak Excursion (dB)	Limit (dB)	Margin (dB)
Mid	5270	11.84	4.20	0.00	7.64	13	-5.36

**PEAK EXCURSION, Chain 0**

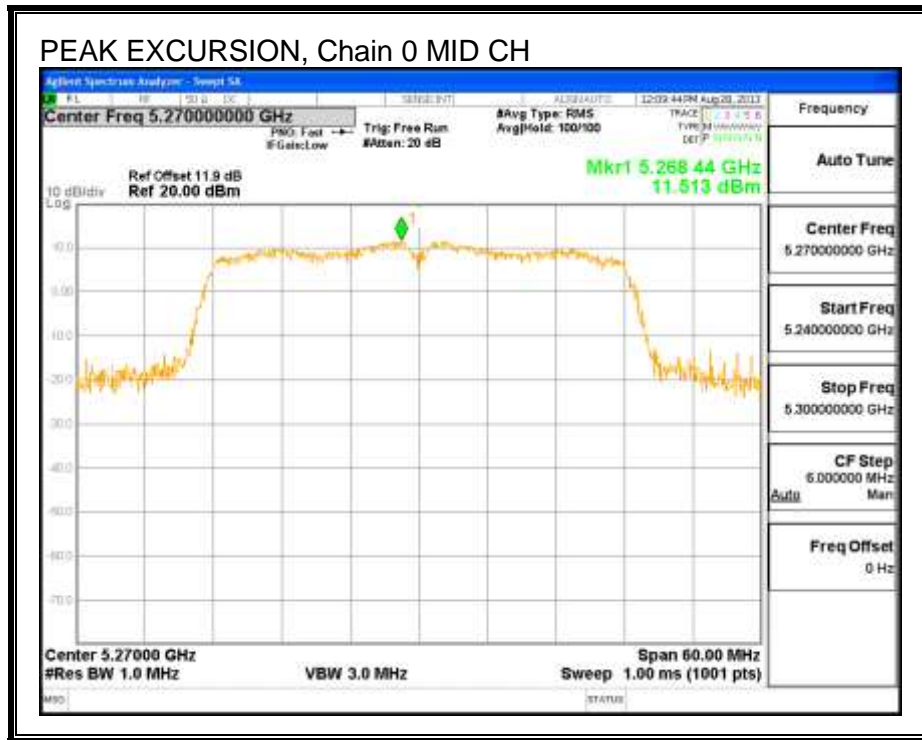

**PEAK EXCURSION, Chain 1**

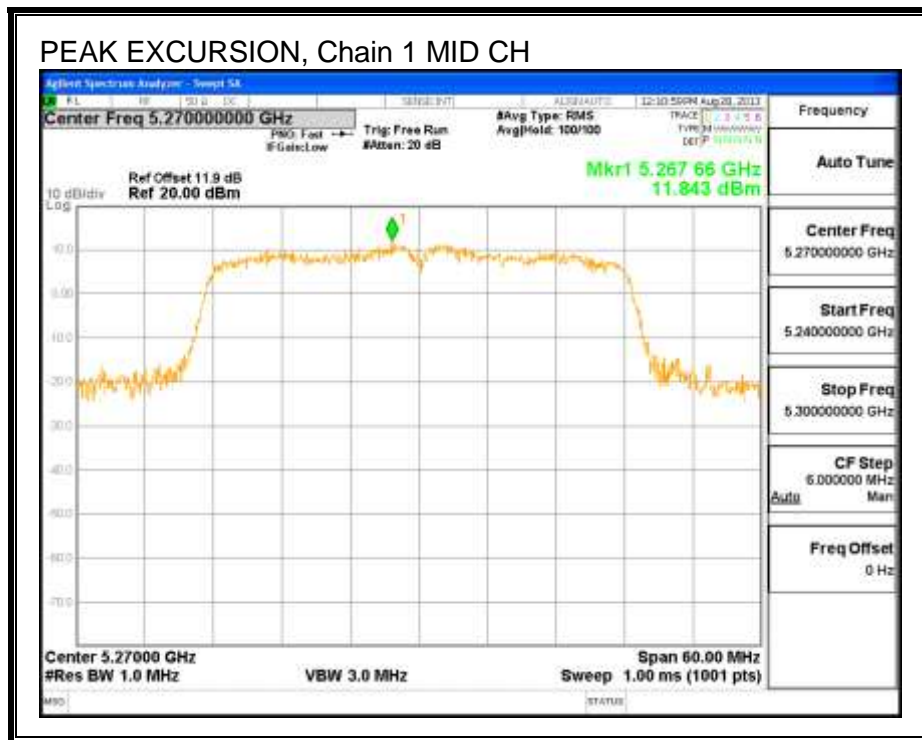

## 8.11. 802.11a SISO MODE IN THE 5.6 GHz BAND

### 8.11.1. 26 dB BANDWIDTH

#### LIMITS

None; for reporting purposes only.

#### RESULTS

Channel	Frequency (MHz)	26 dB Bandwidth (MHz)
Low	5500	19.53
Mid	5580	19.47
High	5700	19.47

**26 dB BANDWIDTH**

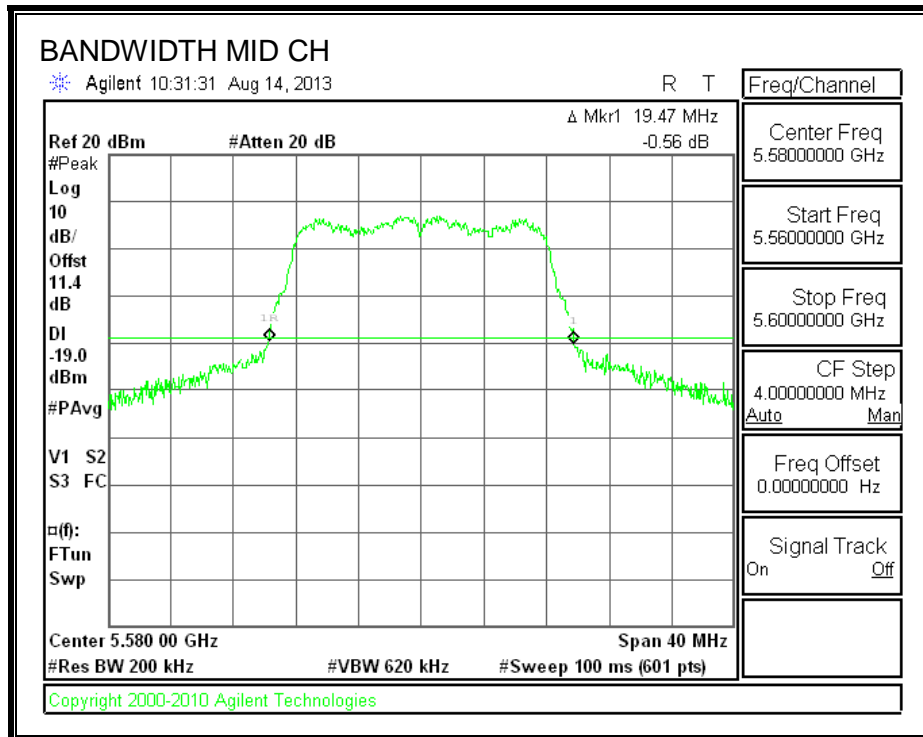
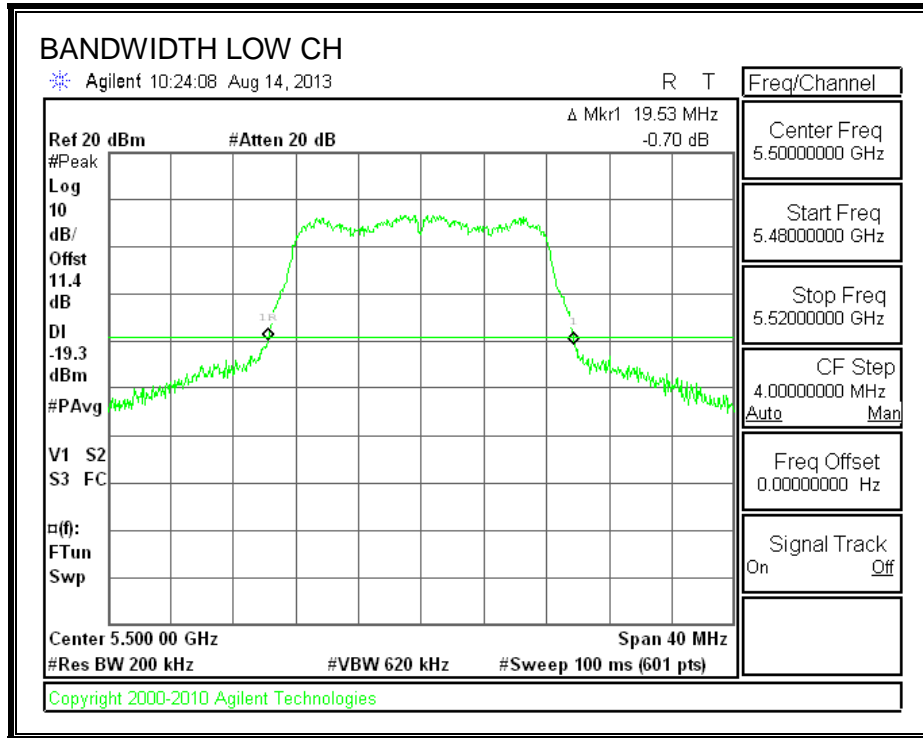

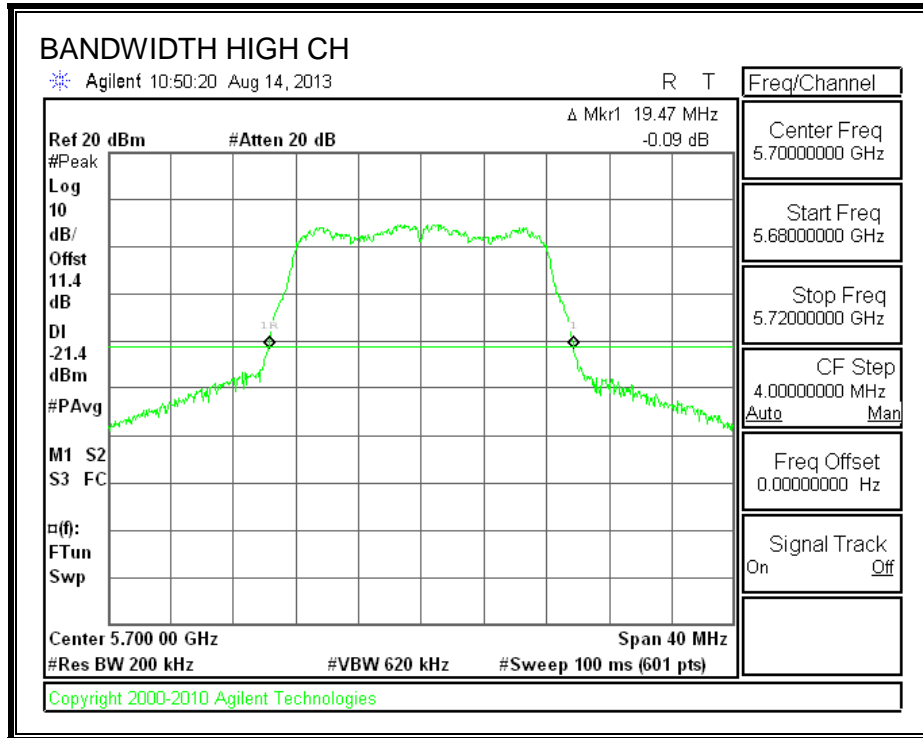

**8.11.2. 99% BANDWIDTH**

**LIMITS**

None; for reporting purposes only.

**RESULTS**

Channel	Frequency (MHz)	99% Bandwidth (MHz)
Low	5500	16.3518
Mid	5580	16.3525
High	5700	16.3541



**99% BANDWIDTH**

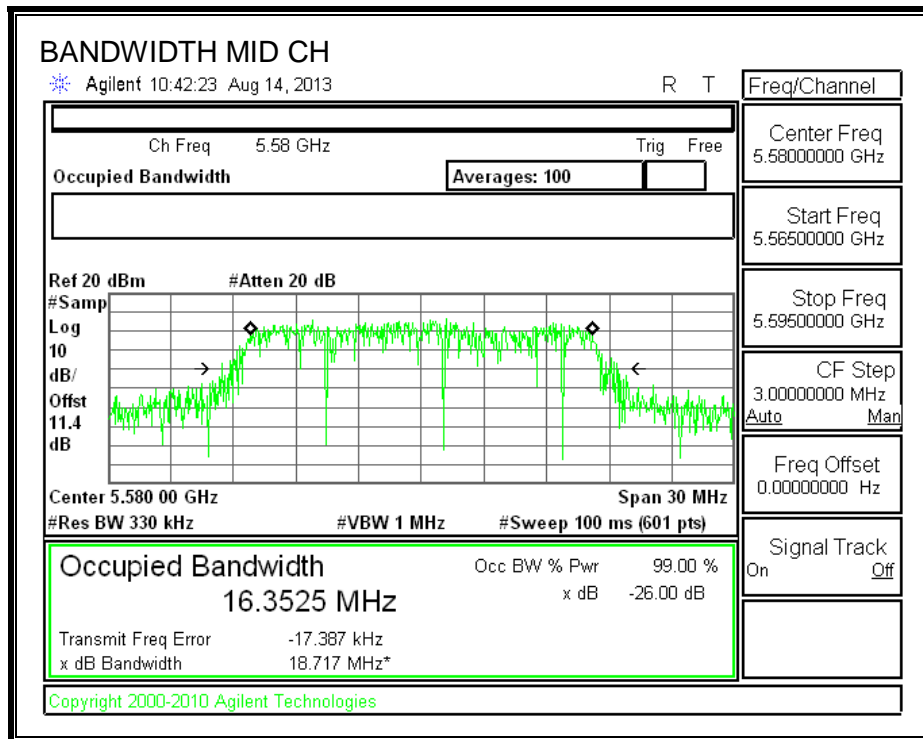
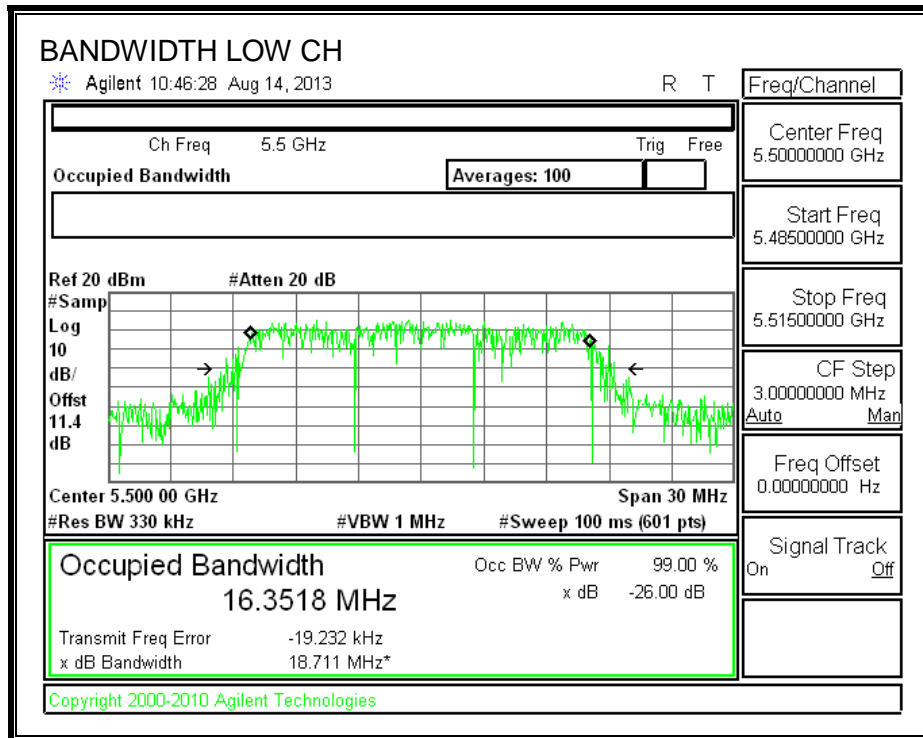

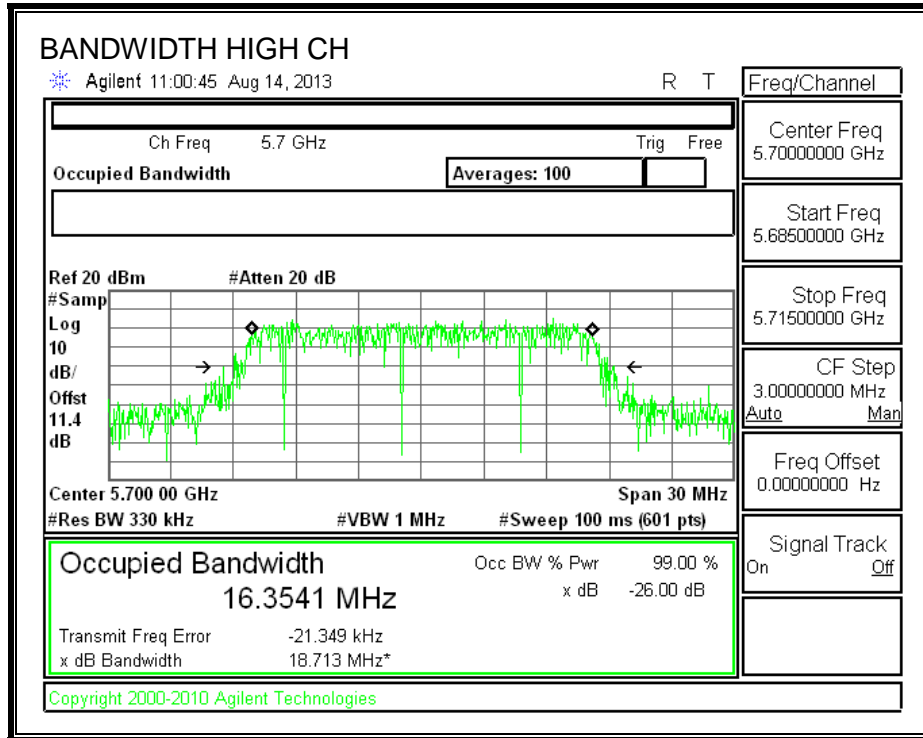

### 8.11.3. AVERAGE POWER

#### LIMITS

None; for reporting purposes only.

#### TEST PROCEDURE

The transmitter output is connected to a power meter.

The cable assembly insertion loss of 11.4 dB (including 10 dB pad and 1.4 dB cable) was entered as an offset in the power meter to allow for direct reading of power.

#### RESULTS

Channel	Frequency (MHz)	Power (dBm)
Low	5500	14.98
Mid	5580	16.40
High	5700	14.43

#### **8.11.4. OUTPUT POWER AND PPSD**

##### **LIMITS**

FCC §15.407 (a) (1)

For the band 5.5–5.7 GHz, the maximum conducted output power over the frequency band of operation shall not exceed the lesser of 250 mW or  $11 \text{ dBm} + 10 \log B$ , where B is the 26–dB emission bandwidth in MHz. In addition, the peak power spectral density shall not exceed 11 dBm in any 1–MHz band. If transmitting antennas of directional gain greater than 6 dBi are used, both the maximum conducted output power and the peak power spectral density shall be reduced by the amount in dB that the directional gain of the antenna exceeds 6 dBi.

IC RSS-210 A9.2 (1)

The maximum e.i.r.p. shall not exceed 200 mW or  $10 + 10 \log_{10} B$ , dBm, whichever power is less. B is the 99% emission bandwidth in MHz. The e.i.r.p. spectral density shall not exceed 10 dBm in any 1.0 MHz band.

##### **DIRECTIONAL ANTENNA GAIN**

There is only one transmitter output therefore the directional gain is equal to the antenna gain.

**RESULTS**

**Bandwidth and Antenna Gain**

Channel	Frequency (MHz)	Min 26 dB BW (MHz)	Min 99% BW (MHz)	Directional Gain (dBi)
Low	5500	19.53	16.35	3.99
Mid	5580	19.47	16.36	3.99
High	5700	19.47	16.35	3.99

**Limits**

Channel	Frequency (MHz)	FCC Power Limit (dBm)	IC Power Limit (dBm)	IC EIRP Limit (dBm)	Power Limit (dBm)	FCC PPSD Limit (dBm)	IC PSD Limit (dBm)	PPSD Limit (dBm)
Low	5500	23.91	23.14	29.14	23.14	11.00	11.00	11.00
Mid	5580	23.89	23.14	29.14	23.14	11.00	11.00	11.00
High	5700	23.89	23.14	29.14	23.14	11.00	11.00	11.00

<b>Duty Cycle CF (dB)</b>	0.00	<b>Included in Calculations of Corr'd Power &amp; PPSD</b>
---------------------------	------	--

**Output Power Results**

Channel	Frequency (MHz)	Chain 0 Meas Power (dBm)	Total Corr'd Power (dBm)	Power Limit (dBm)	Power Margin (dB)
Low	5500	15.13	15.13	23.14	-8.01
Mid	5580	16.43	16.43	23.14	-6.71
High	5700	14.46	14.46	23.14	-8.67

**PPSD Results**

Channel	Frequency (MHz)	Chain 0 Meas PPSD (dBm)	Total Corr'd PPSD (dBm)	PPSD Limit (dBm)	PPSD Margin (dB)
Low	5500	3.65	3.65	11.00	-7.36
Mid	5580	6.26	6.26	11.00	-4.74
High	5700	2.87	2.87	11.00	-8.13

**OUTPUT POWER AND PPSD, Chain 0**

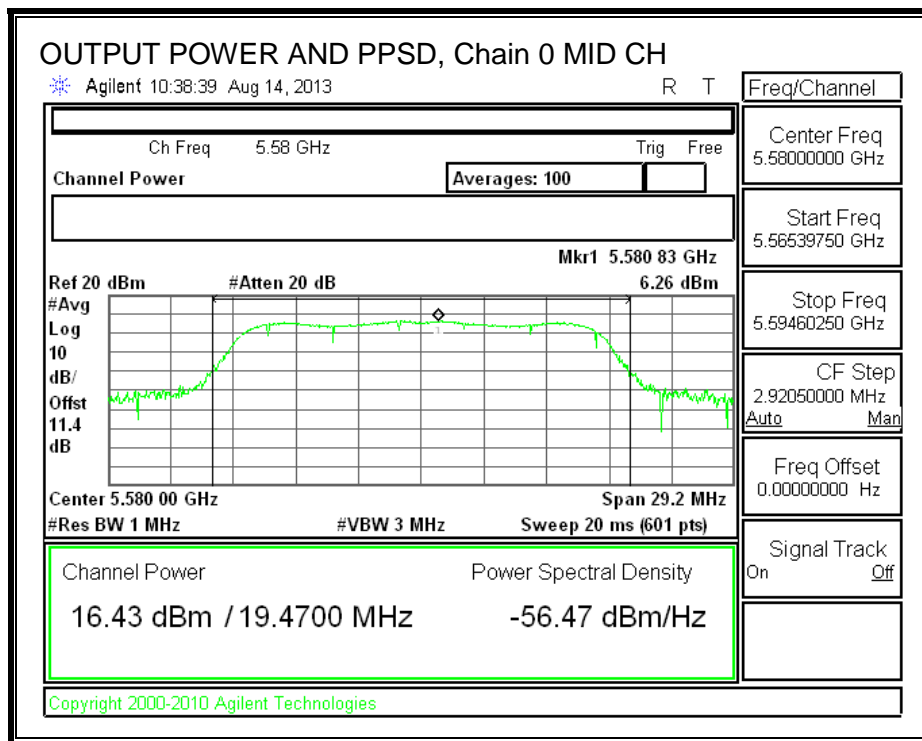
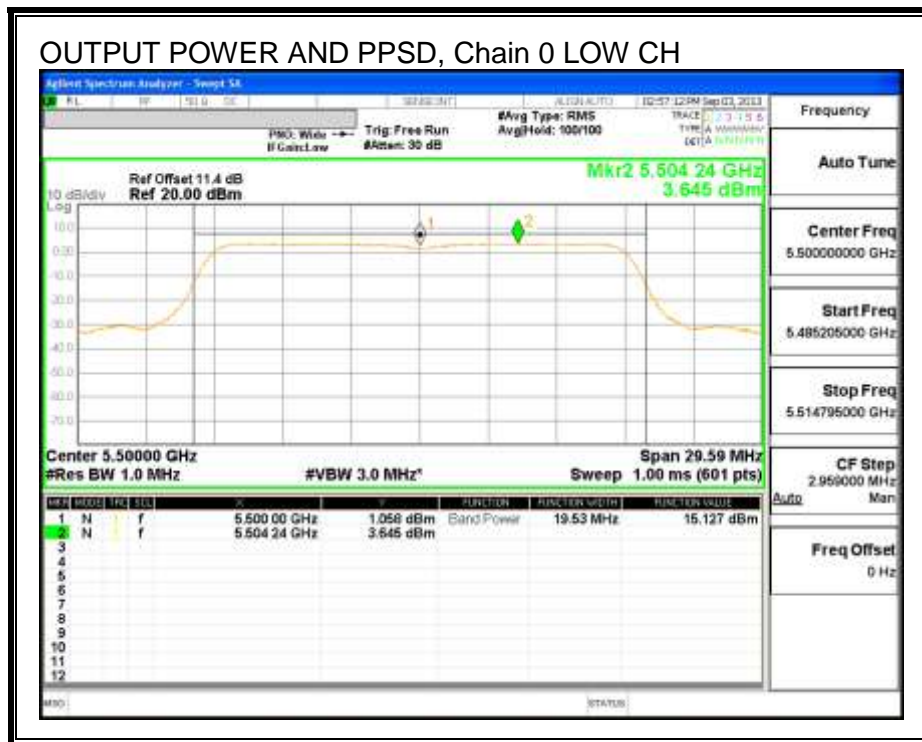

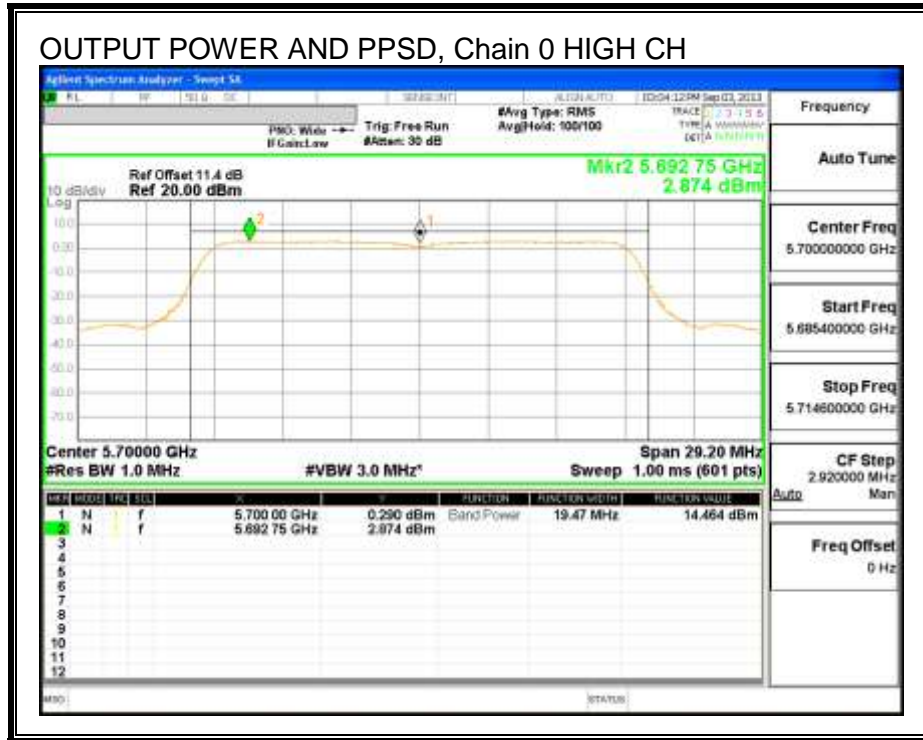

### 8.11.5. PEAK EXCURSION

#### LIMITS

FCC §15.407 (a) (6)

The ratio of the peak excursion of the modulation envelope (measured using a peak hold function) to the peak transmit power (measured as specified above) shall not exceed 13 dB across any 1 MHz bandwidth or the emission bandwidth whichever is less.

#### RESULTS

Channel	Frequency (MHz)	PK Level (dBm)	PSD (dBm)	DCCF (dB)	Peak Excursion (dB)	Limit (dB)	Margin (dB)
Mid	5580	12.82	6.26	0.00	6.56	13	-6.44



**PEAK EXCURSION**

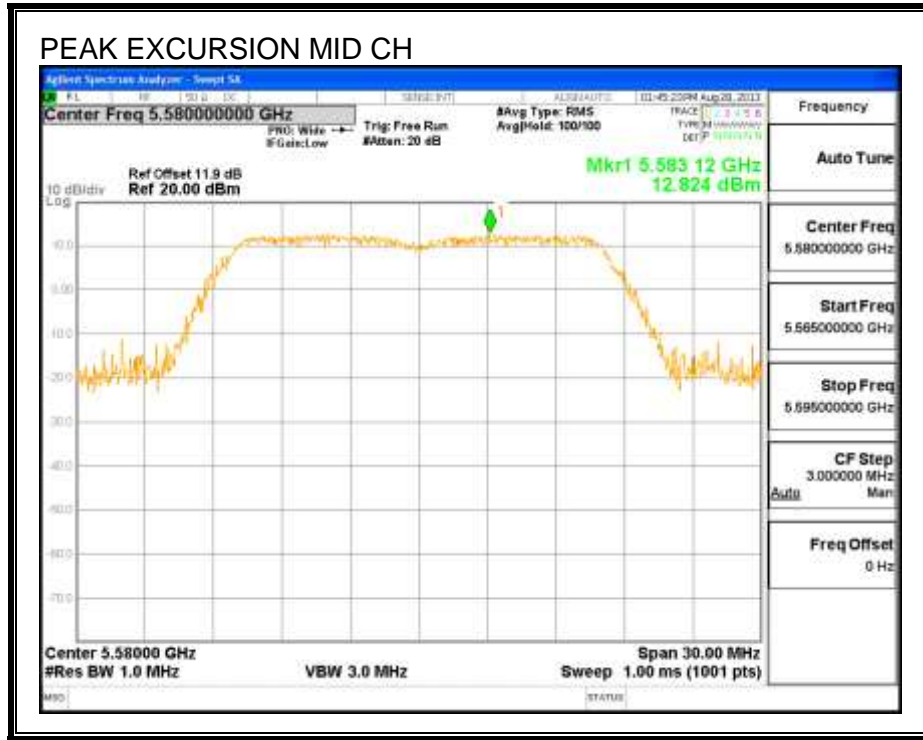

## 8.12. 802.11n HT20 2TX CDD MODE IN THE 5.6 GHz BAND

### 8.12.1. 26 dB BANDWIDTH

#### LIMITS

None; for reporting purposes only.

#### RESULTS

Channel	Frequency (MHz)	26 dB BW Chain 0 (MHz)	26 dB BW Chain 1 (MHz)
Low	5500	19.70	19.73
Mid	5580	19.85	19.80
High	5700	19.75	19.80

**26 dB BANDWIDTH**

**26 dB BANDWIDTH, Chain 0**

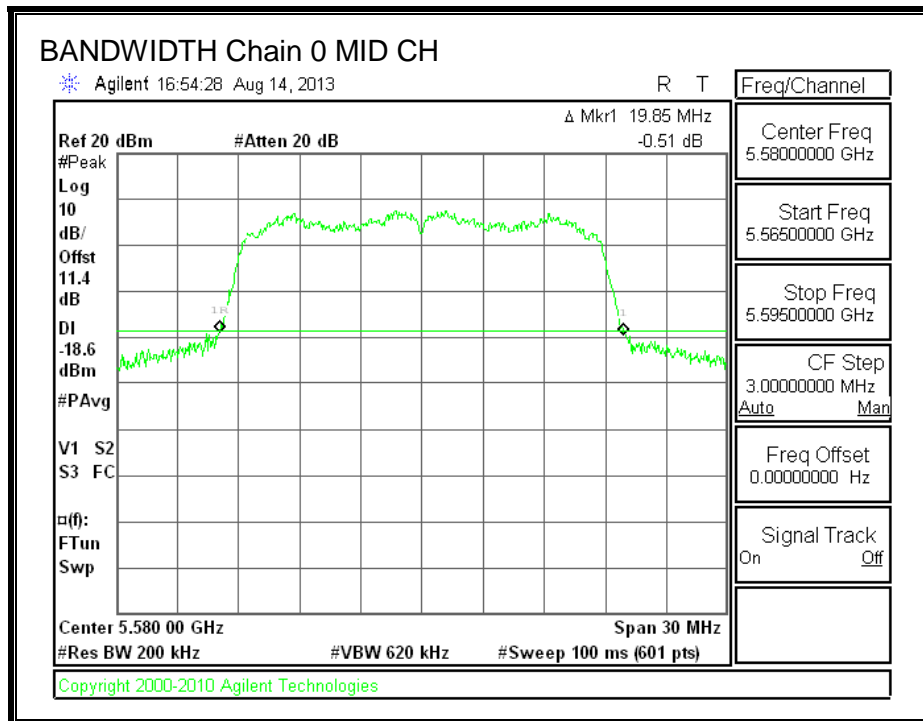
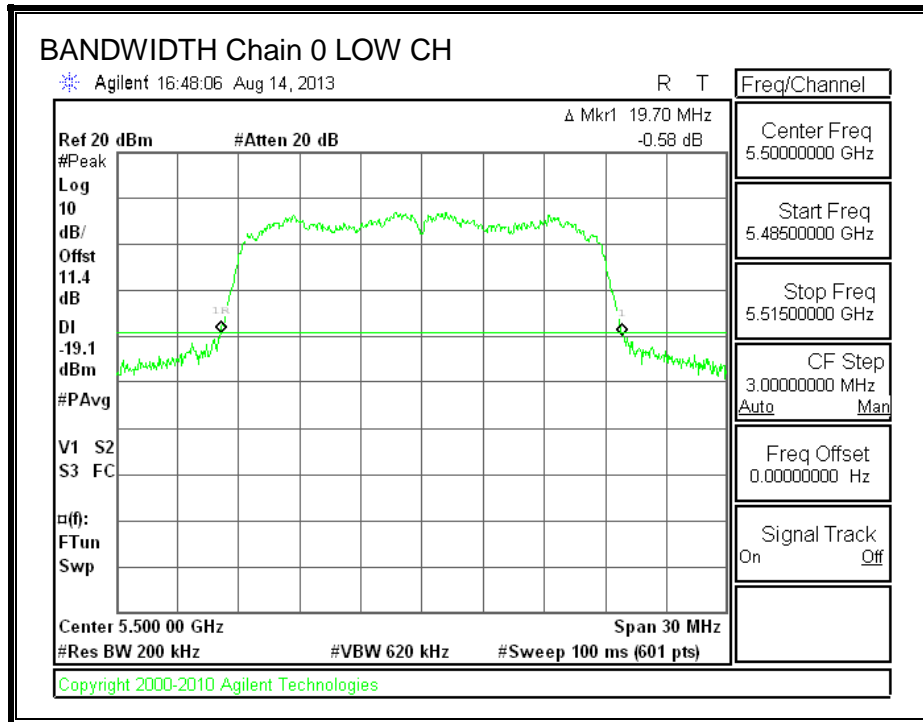

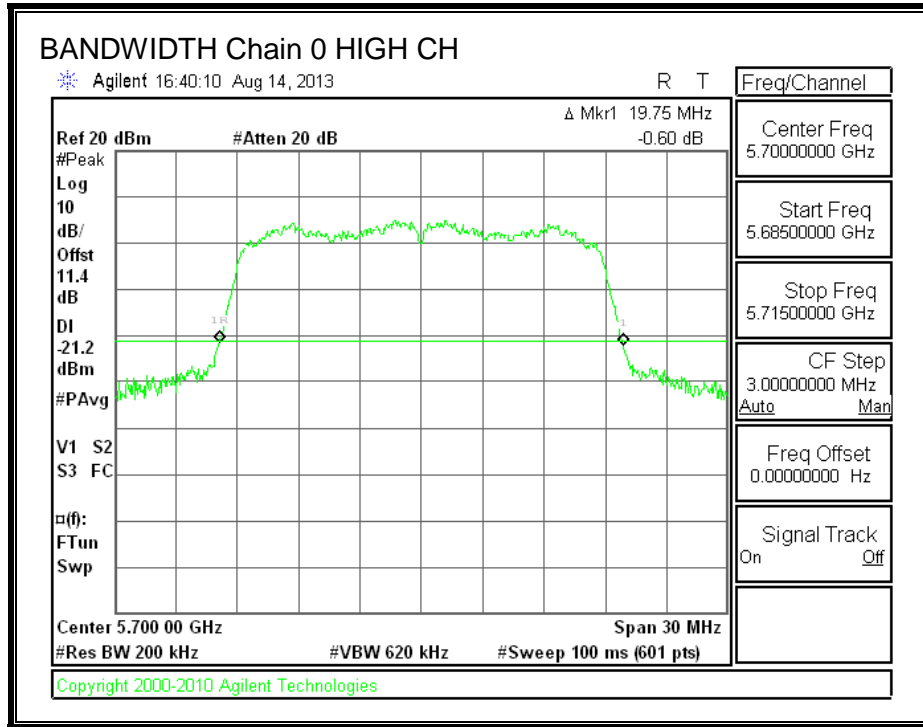

**26 dB BANDWIDTH, Chain 1**

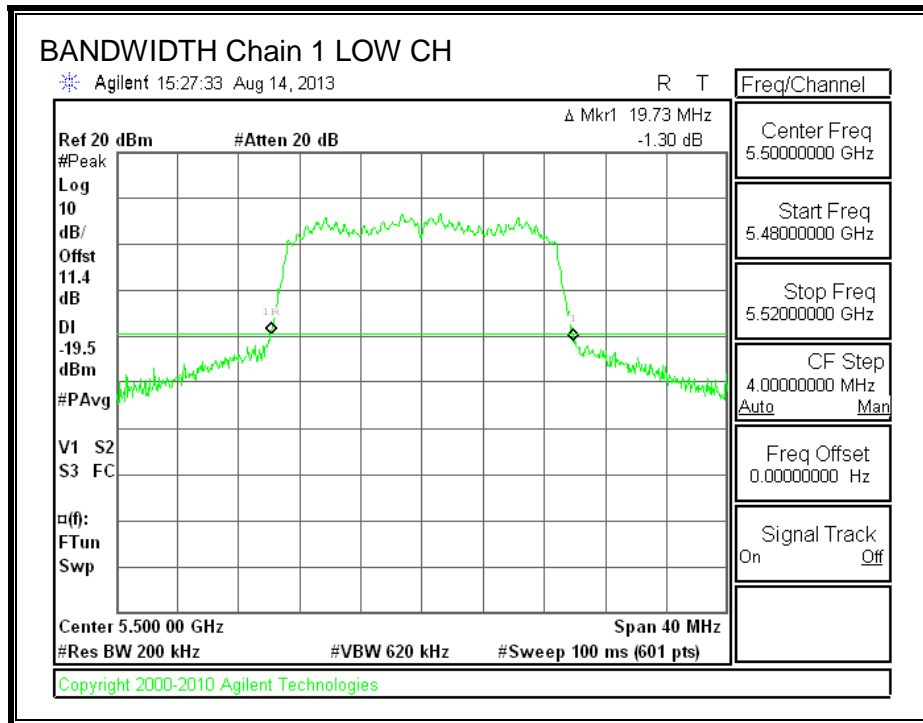

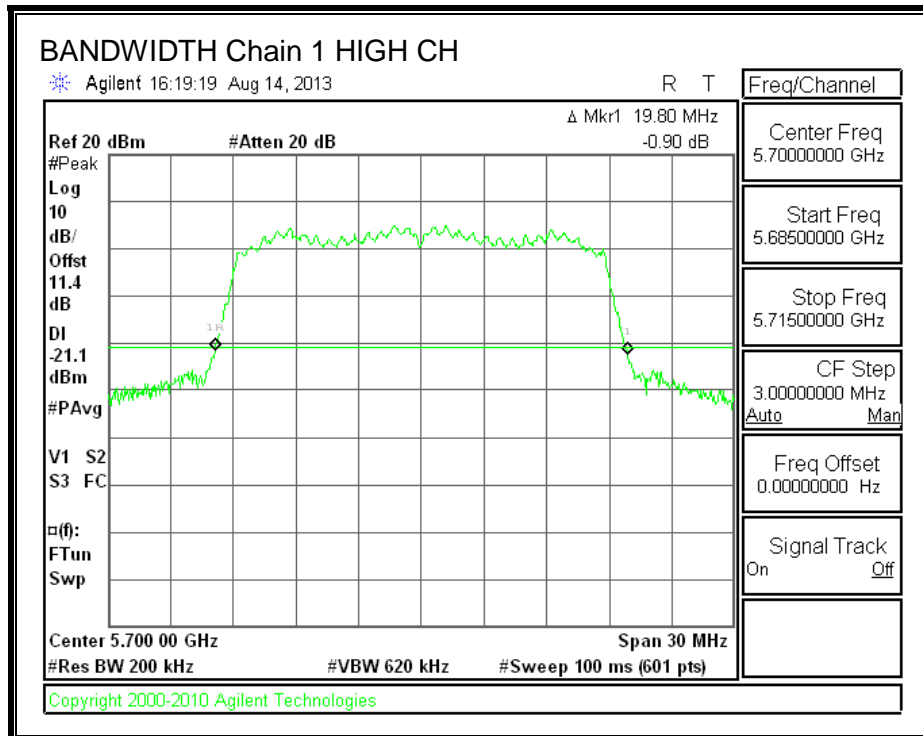
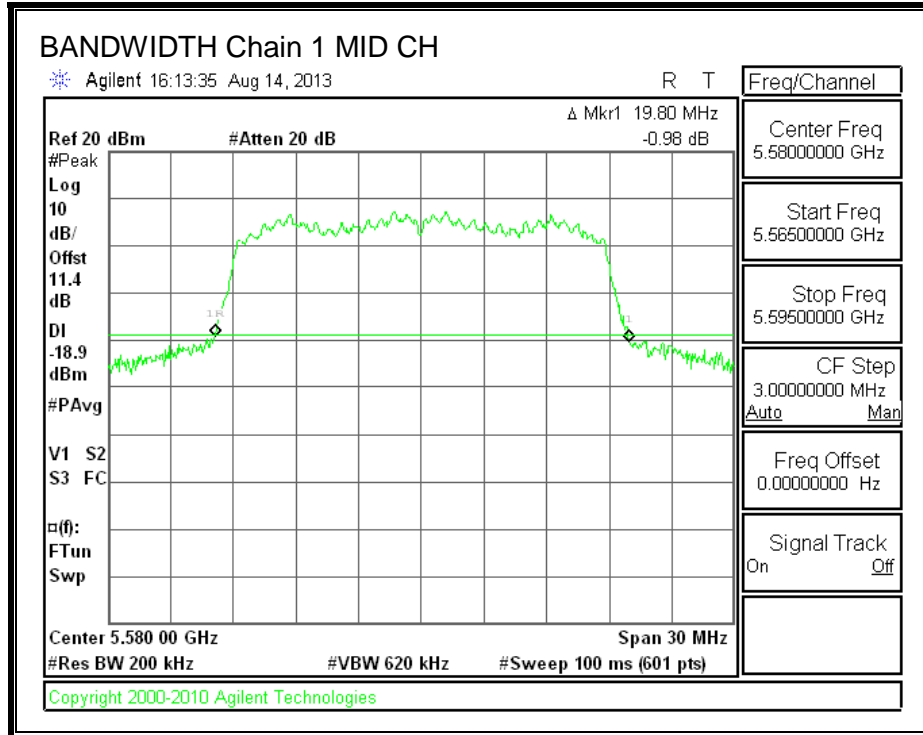

**8.12.2. 99% BANDWIDTH**

**LIMITS**

None; for reporting purposes only.

**RESULTS**

Channel	Frequency (MHz)	99% BW Chain 0 (MHz)	99% BW Chain 1 (MHz)
Low	5500	17.5875	17.5274
Mid	5580	17.5832	17.5781
High	5700	17.5824	17.5690

**99% BANDWIDTH**

**99% BANDWIDTH, Chain 0**

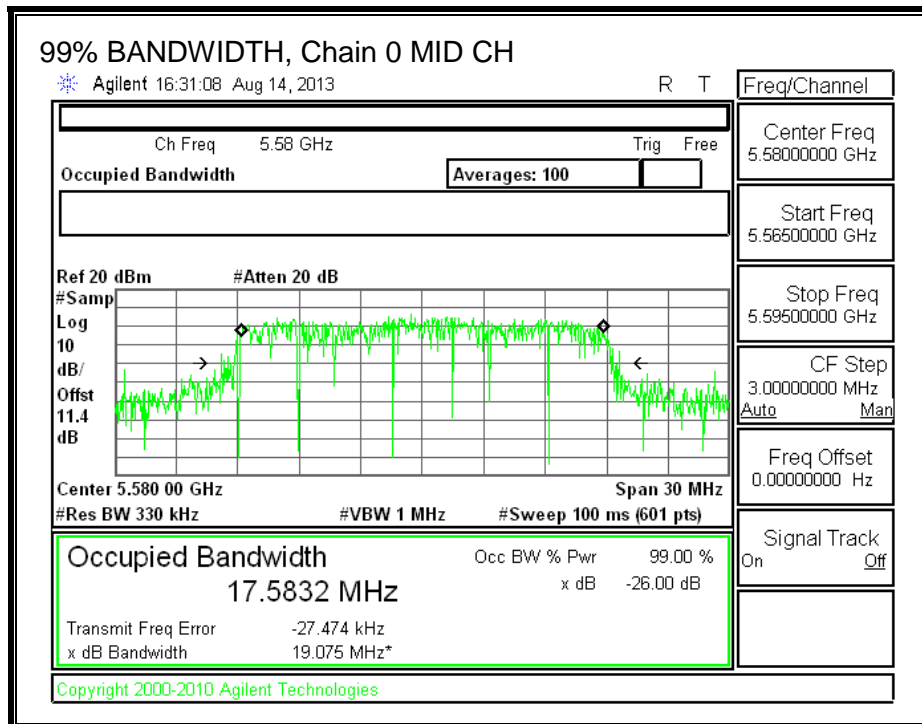
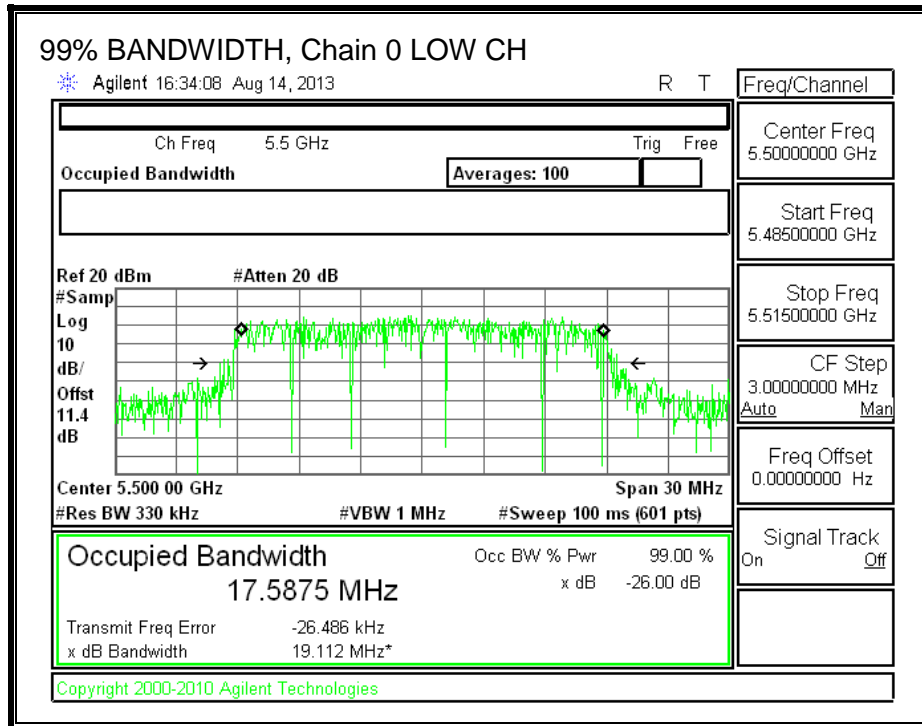

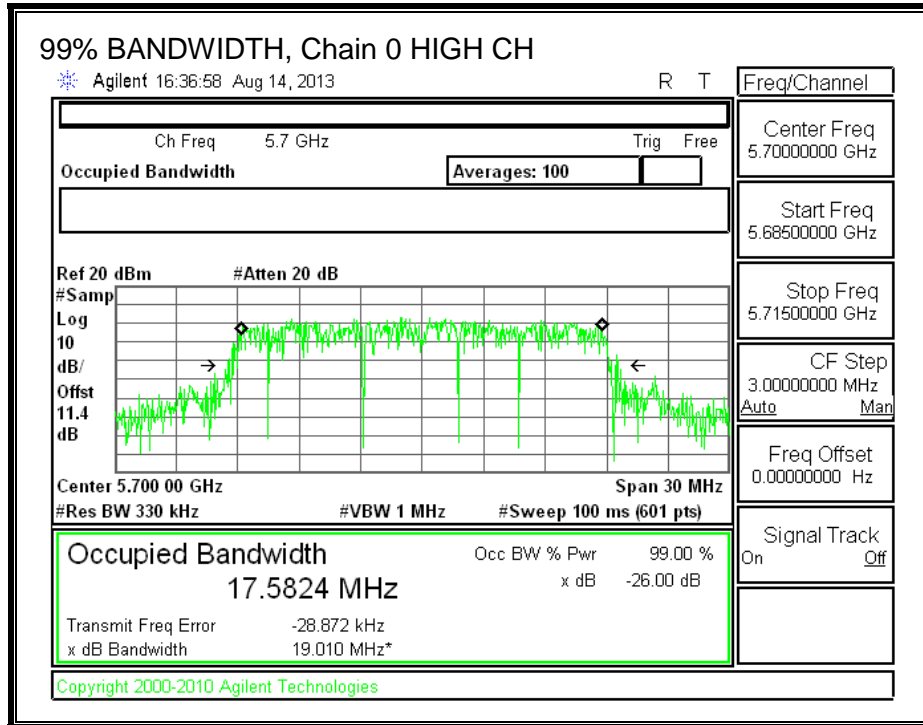

**99% BANDWIDTH, Chain 1**

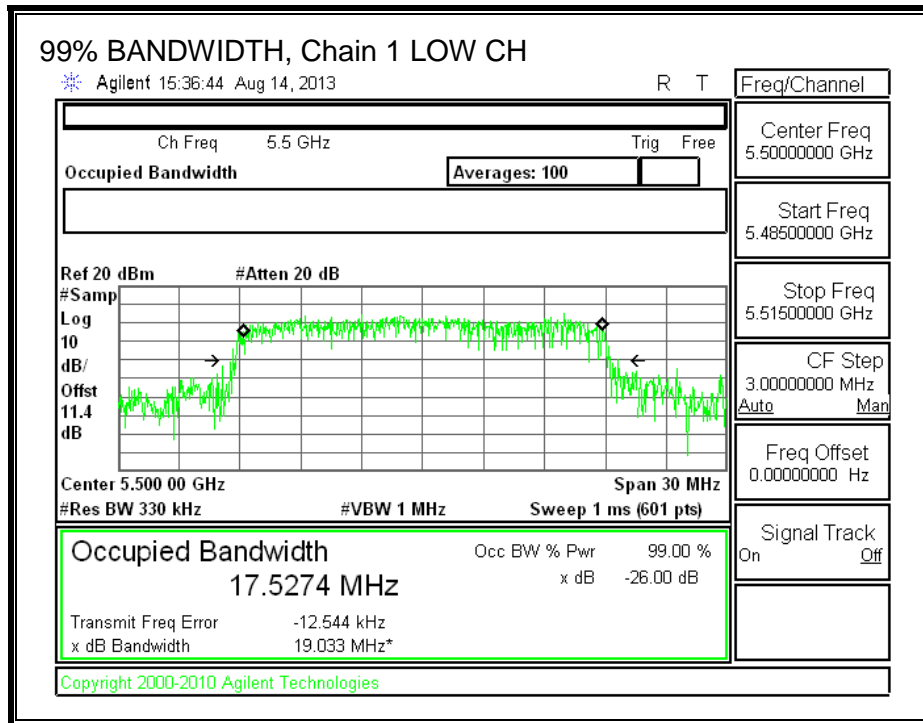



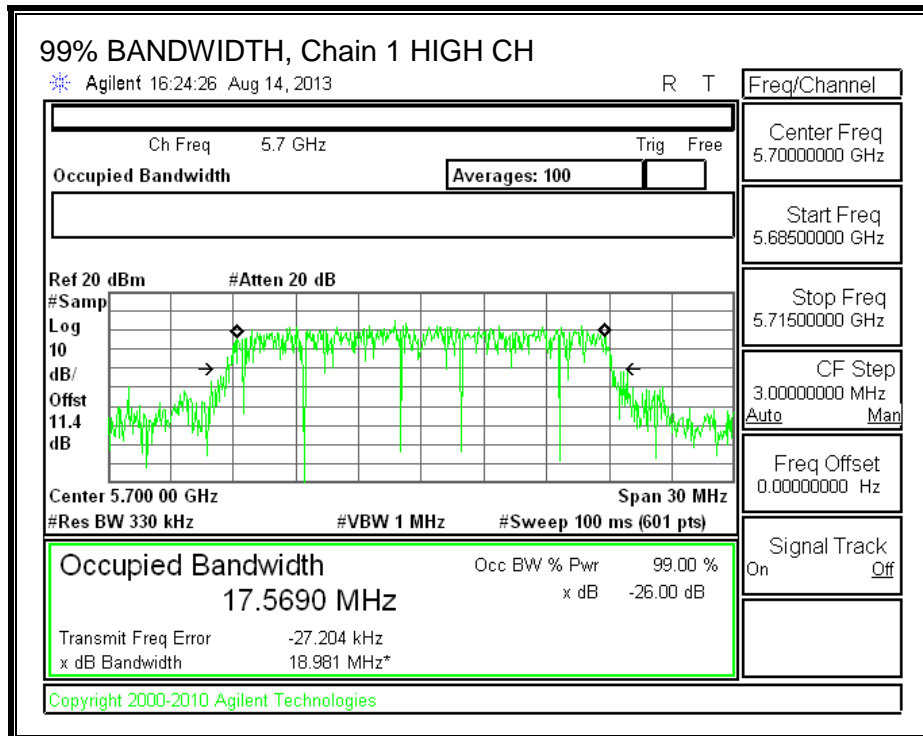
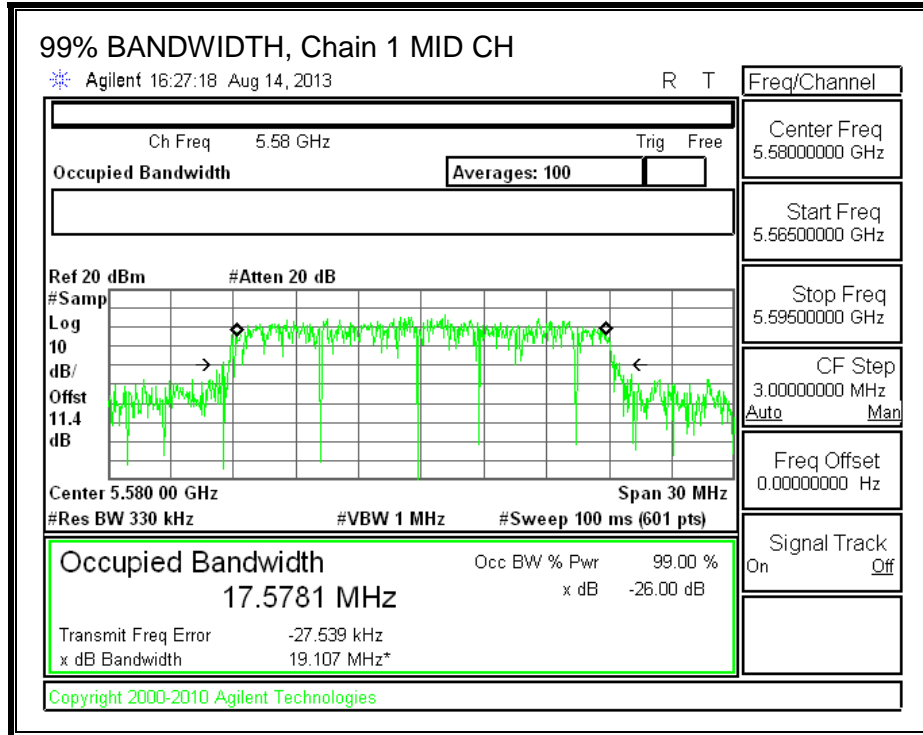

### 8.12.3. AVERAGE POWER

#### LIMITS

None; for reporting purposes only.

#### TEST PROCEDURE

The transmitter output is connected to a power meter.

The cable assembly insertion loss of 12 dB (including 10 dB pad and 2 dB cable) was entered as an offset in the power meter to allow for direct reading of power.

#### RESULTS

##### Average Power Results

Channel	Frequency (MHz)	Chain 0 Power (dBm)	Chain 1 Power (dBm)	Total Power (dBm)
Low	5500	13.90	13.89	16.91
Mid	5580	15.82	15.80	18.82
High	5700	12.95	12.70	15.84

**8.12.4. OUTPUT POWER AND PPSD**

**LIMITS**

FCC §15.407 (a) (1)

For the band 5.5–5.7 GHz, the maximum conducted output power over the frequency band of operation shall not exceed the lesser of 250 mW or 11 dBm + 10 log B, where B is the 26–dB emission bandwidth in MHz. In addition, the peak power spectral density shall not exceed 11 dBm in any 1–MHz band. If transmitting antennas of directional gain greater than 6 dBi are used, both the maximum conducted output power and the peak power spectral density shall be reduced by the amount in dB that the directional gain of the antenna exceeds 6 dBi.

IC RSS-210 A9.2 (1)

The maximum e.i.r.p. shall not exceed 200 mW or 10 + 10 log<sub>10</sub> B, dBm, whichever power is less. B is the 99% emission bandwidth in MHz. The e.i.r.p. spectral density shall not exceed 10 dBm in any 1.0 MHz band.

**DIRECTIONAL ANTENNA GAIN**

For output power, the TX chains are uncorrelated and the antenna gain is unequal among the chains. The directional gain is:

Chain 0 Antenna Gain (dBi)	Chain 1 Antenna Gain (dBi)	Uncorrelated Chains Directional Gain (dBi)
3.66	3.99	3.83

For PPSD, the TX chains are correlated and the antenna gain is unequal among the chains. The directional gain is:

Chain 0 Antenna Gain (dBi)	Chain 1 Antenna Gain (dBi)	Correlated Chains Directional Gain (dBi)
3.66	3.99	6.84

**RESULTS**

**Bandwidth and Antenna Gain**

Channel	Frequency (MHz)	Min 26 dB BW (MHz)	Min 99% BW (MHz)	Uncorrelated Directional Gain (dBi)	Correlated Directional Gain (dBi)
Low	5500	19.70	17.53	3.83	6.84
Mid	5580	19.80	17.58	3.83	6.84
High	5700	19.80	17.57	3.83	6.84

**Limits**

Channel	Frequency (MHz)	FCC Power Limit (dBm)	IC Power Limit (dBm)	IC EIRP Limit (dBm)	Power Limit (dBm)	FCC PPSD Limit (dBm)	IC PSD Limit (dBm)	PPSD Limit (dBm)
Low	5500	23.94	23.44	29.44	23.44	10.16	11.00	10.16
Mid	5580	23.97	23.45	29.45	23.45	10.16	11.00	10.16
High	5700	23.97	23.45	29.45	23.45	10.16	11.00	10.16

<b>Duty Cycle CF (dB)</b>	0.00	<b>Included in Calculations of Corr'd Power &amp; PPSD</b>
---------------------------	------	--

**Output Power Results**

Channel	Frequency (MHz)	Chain 0 Meas Power (dBm)	Chain 1 Meas Power (dBm)	Total Corr'd Power (dBm)	Power Limit (dBm)	Power Margi n (dB)
Low	5500	14.00	14.08	17.05	23.44	-6.39
Mid	5580	15.88	16.00	18.95	23.45	-4.50
High	5700	13.04	12.77	15.92	23.45	-7.53

**PPSD Results**

Channel	Frequency (MHz)	Chain 0 Meas PPSD (dBm)	Chain 1 Meas PPSD (dBm)	Total Corr'd PPSD (dBm)	PPSD Limit (dBm)	PPSD Margi n (dB)
Low	5500	4.57	2.35	6.61	10.16	-3.55
Mid	5580	6.48	5.91	9.21	10.16	-0.95
High	5700	3.12	4.17	6.69	10.16	-3.47

**OUTPUT POWER AND PPSD, Chain 0**

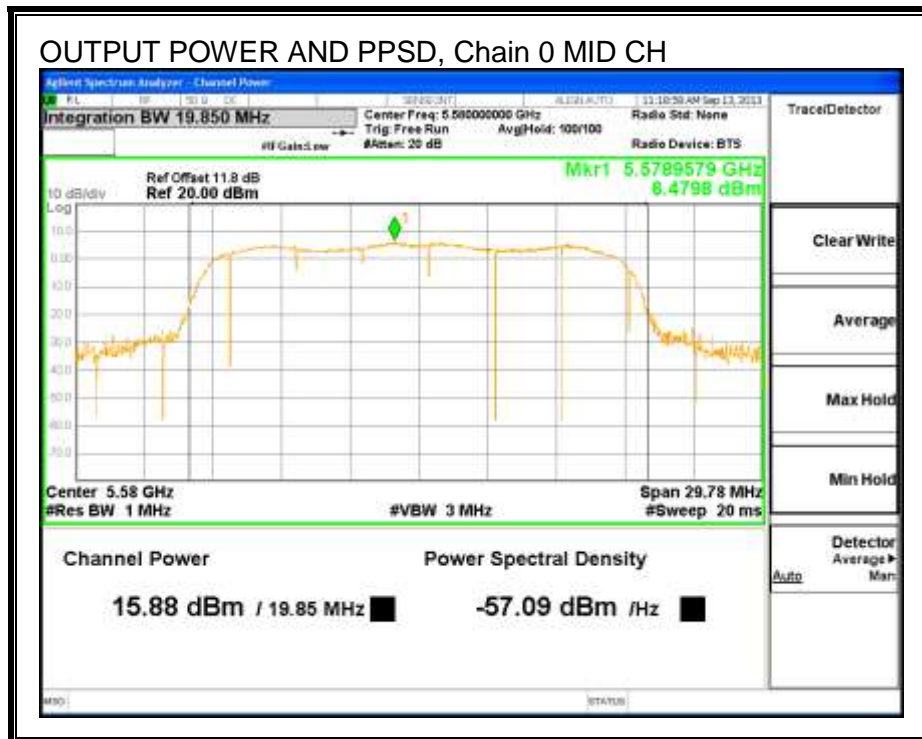
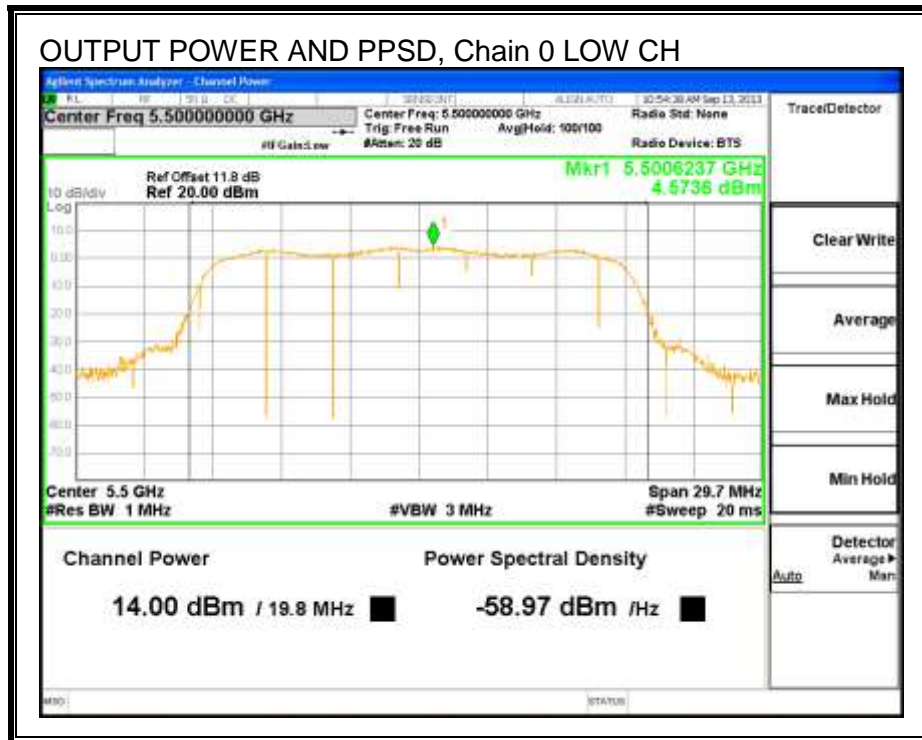

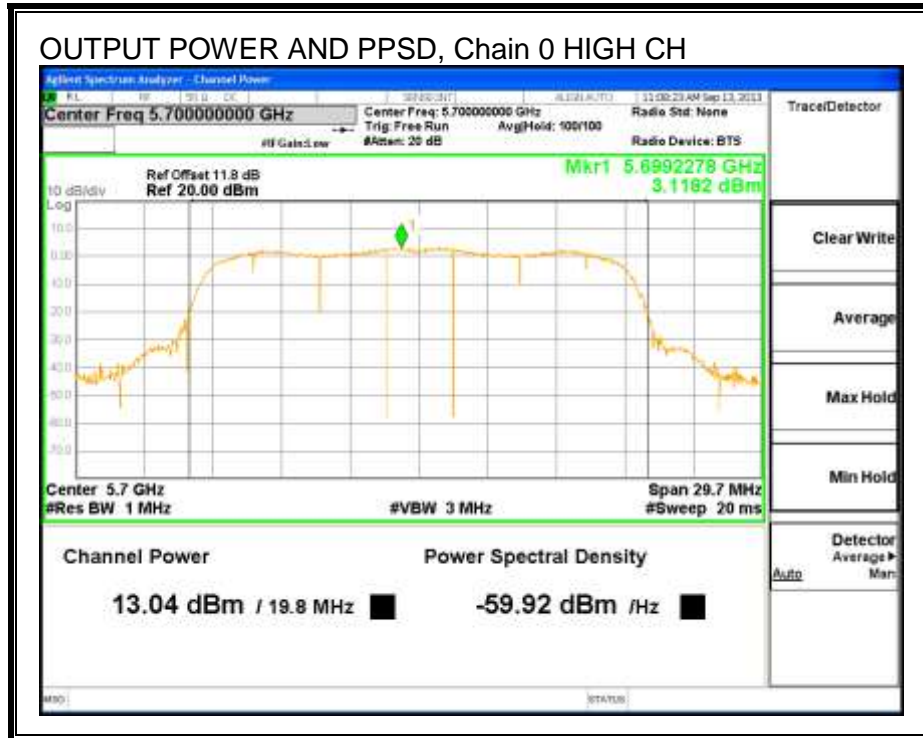

OUTPUT POWER AND PPSD, Chain 1

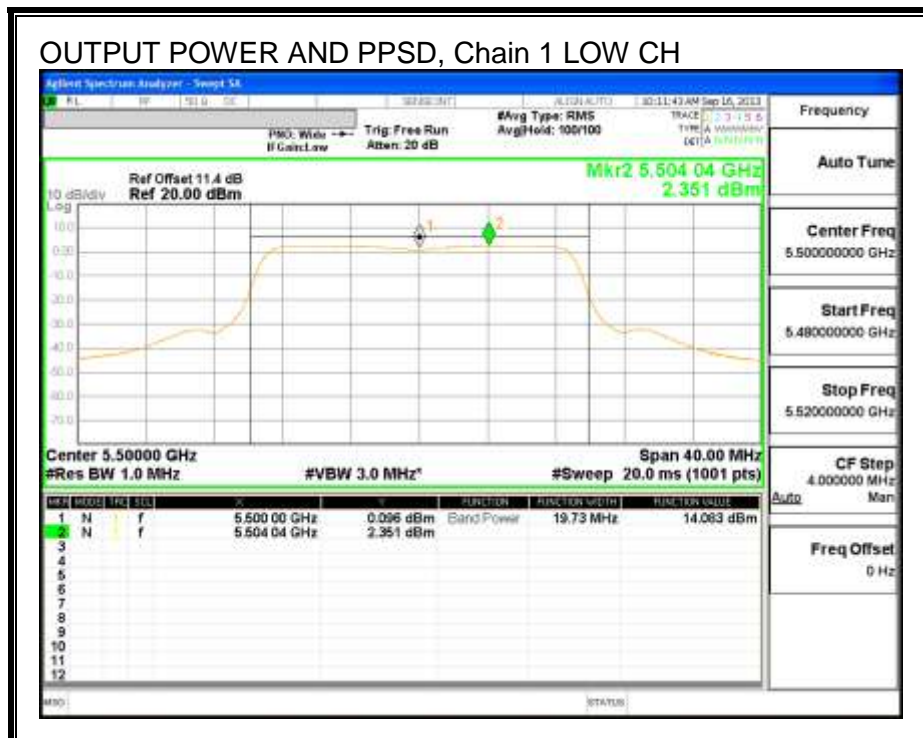

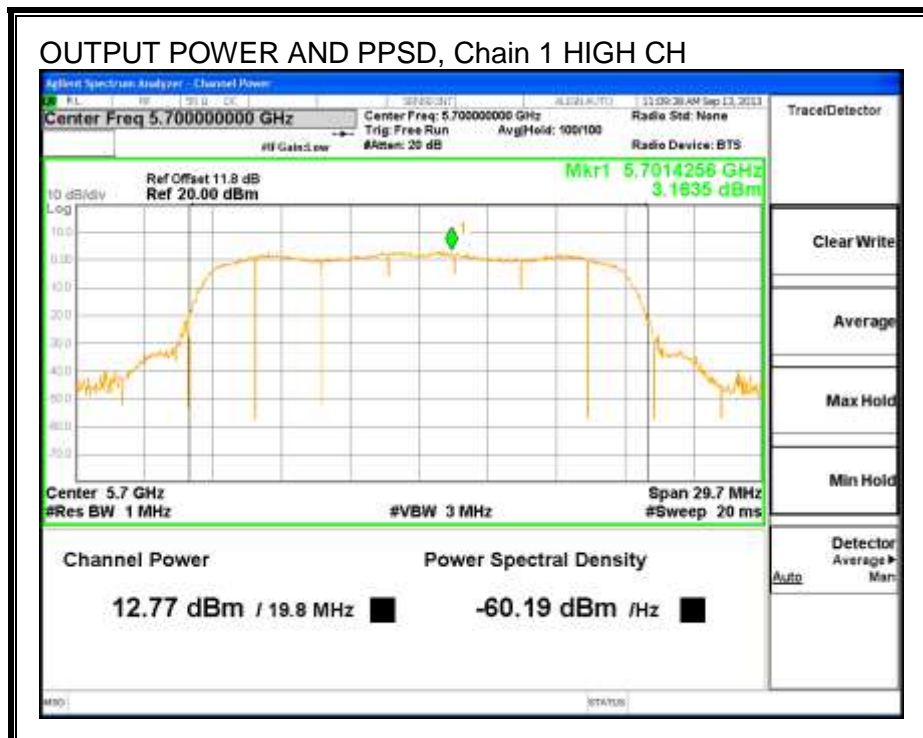
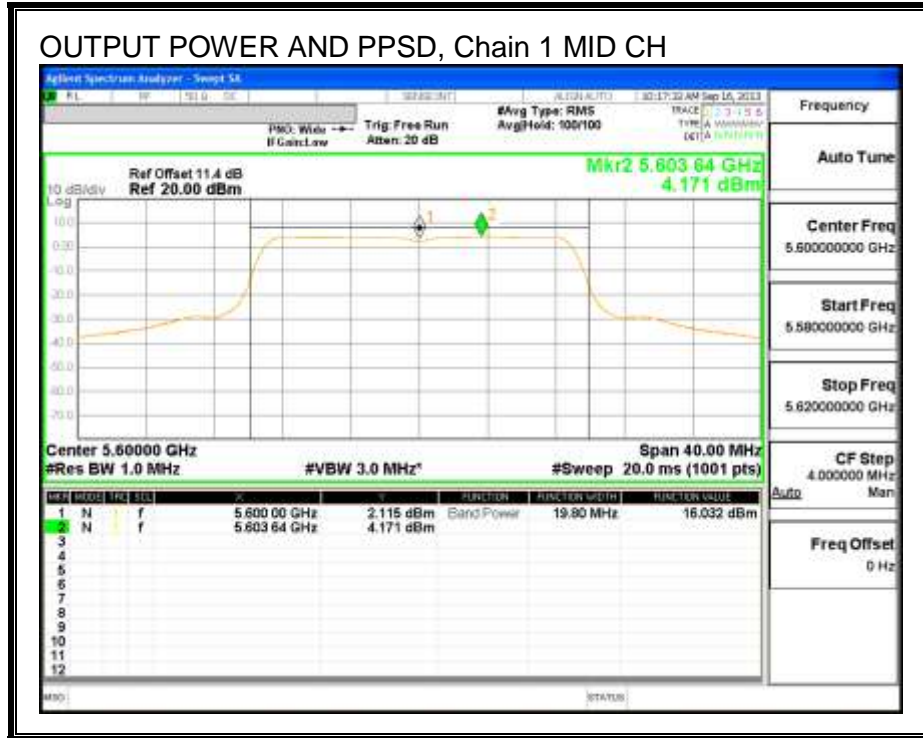

**8.12.5. PEAK EXCURSION**

**LIMITS**

FCC §15.407 (a) (6)

The ratio of the peak excursion of the modulation envelope (measured using a peak hold function) to the peak transmit power (measured as specified above) shall not exceed 13 dB across any 1 MHz bandwidth or the emission bandwidth whichever is less.

**RESULTS**

Chain 0

Channel	Frequency (MHz)	PK Level (dBm)	PSD (dBm)	DCCF (dB)	Peak Excursion (dB)	Limit (dB)	Margin (dB)
Mid	5580	12.79	6.21	0.00	6.58	13	-6.42

Chain 1

Channel	Frequency (MHz)	PK Level (dBm)	PSD (dBm)	DCCF (dB)	Peak Excursion (dB)	Limit (dB)	Margin (dB)
Mid	5580	13.33	5.88	0.00	7.45	13	-5.55



**PEAK EXCURSION, Chain 0**

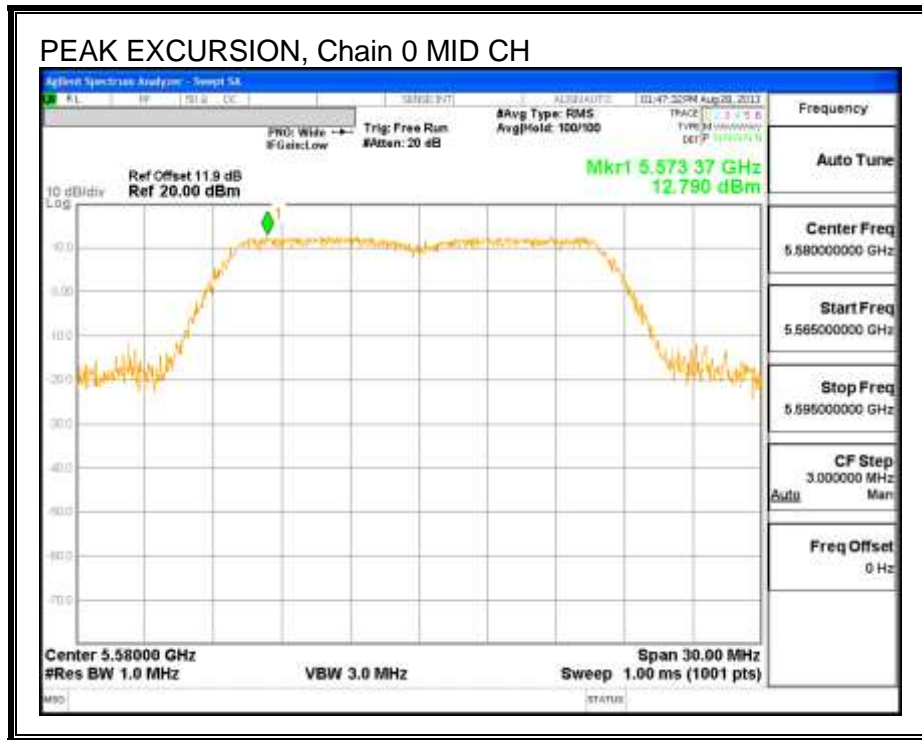

**PEAK EXCURSION, Chain 1**

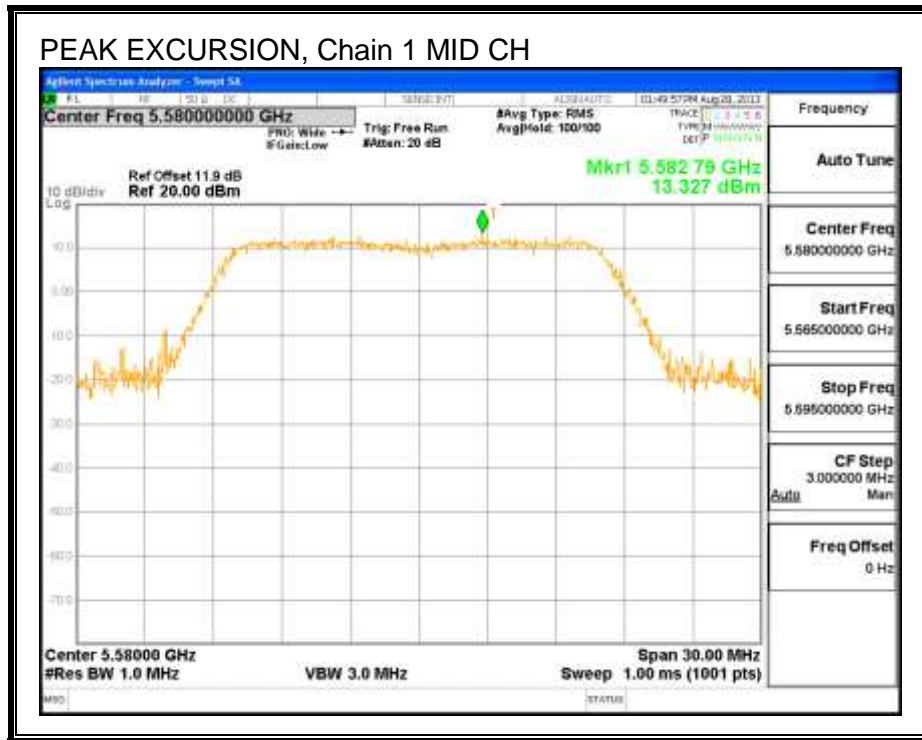

### 8.13. 802.11n HT20 2TX STBC MODE IN THE 5.6 GHz BAND

#### 8.13.1. 26 dB BANDWIDTH

##### LIMITS

None; for reporting purposes only.

##### RESULTS

Channel	Frequency (MHz)	26 dB BW Chain 0 (MHz)	26 dB BW Chain 1 (MHz)
Mid	5580	20.85	20.70

**26 dB BANDWIDTH**

**26 dB BANDWIDTH, Chain 0**

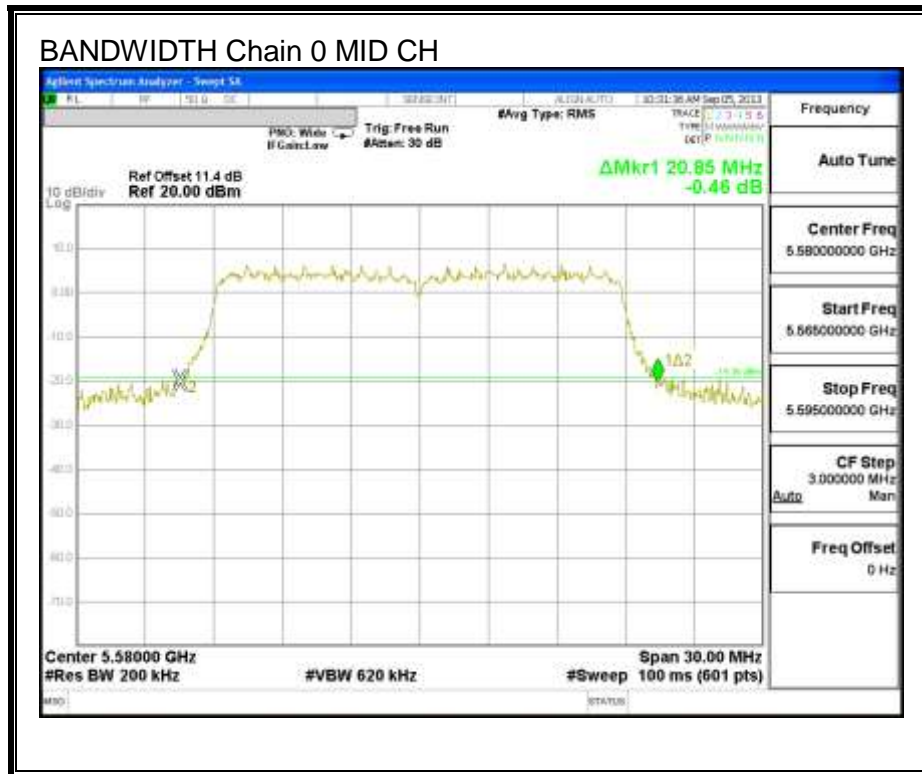

**26 dB BANDWIDTH, Chain 1**

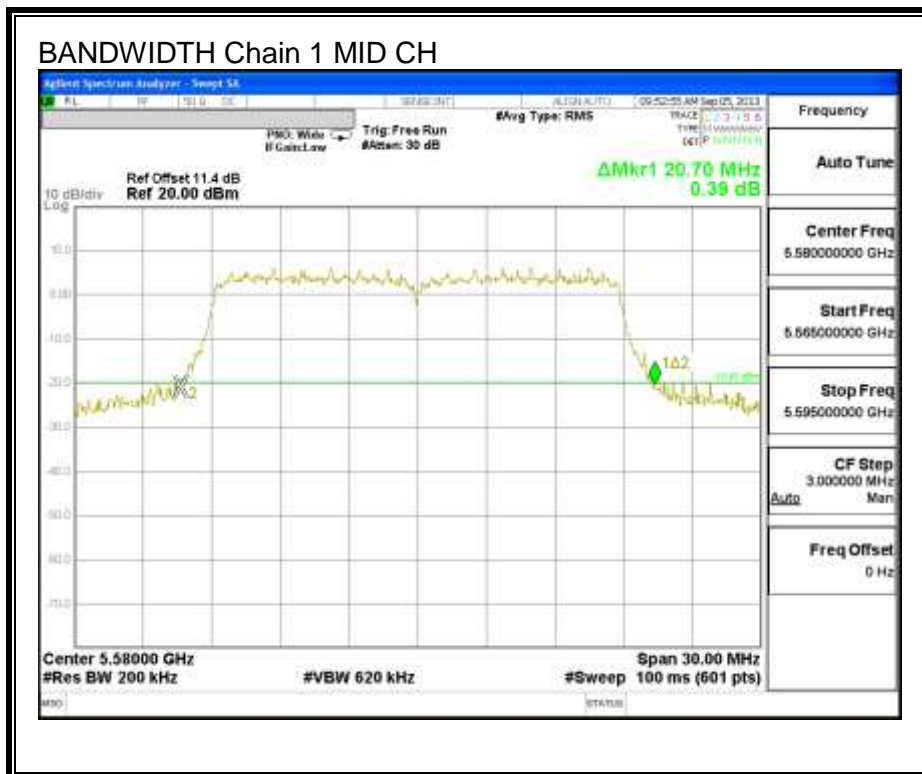

**8.13.2. 99% BANDWIDTH**

**LIMITS**

None; for reporting purposes only.

**RESULTS**

Channel	Frequency (MHz)	99% BW Chain 0 (MHz)	99% BW Chain 1 (MHz)
Mid	5580	18.3940	18.1480

**99% BANDWIDTH**

**99% BANDWIDTH, Chain 0**

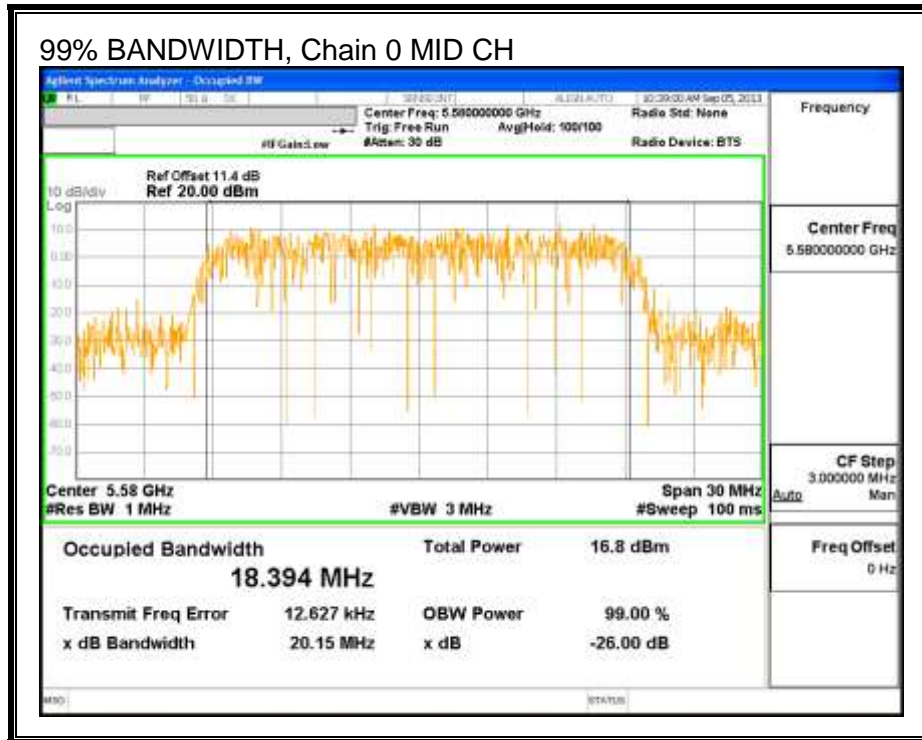

**99% BANDWIDTH, Chain 1**

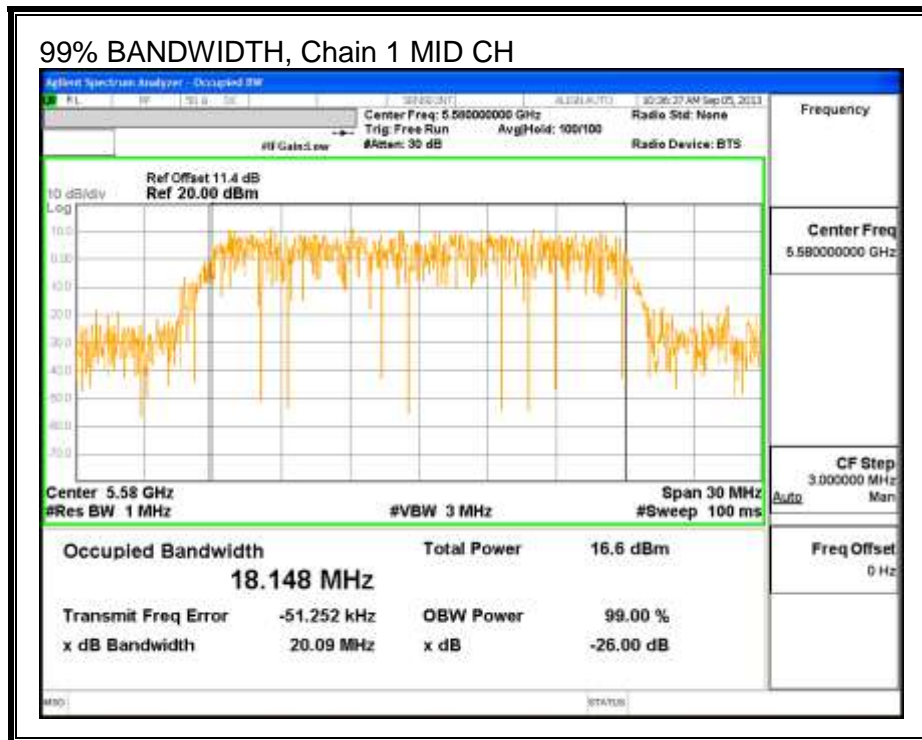

### 8.13.3. AVERAGE POWER

#### LIMITS

None; for reporting purposes only.

#### TEST PROCEDURE

The transmitter output is connected to a power meter.

The cable assembly insertion loss of 12 dB (including 10 dB pad and 2 dB cable) was entered as an offset in the power meter to allow for direct reading of power.

#### RESULTS

##### Average Power Results

Channel	Frequency (MHz)	Chain 0 Power (dBm)	Chain 1 Power (dBm)	Total Power (dBm)
Mid	5580	16.46	16.21	19.35

**8.13.4. OUTPUT POWER AND PPSD**

**LIMITS**

FCC §15.407 (a) (1)

For the band 5.5–5.7 GHz, the maximum conducted output power over the frequency band of operation shall not exceed the lesser of 250 mW or 11 dBm + 10 log B, where B is the 26–dB emission bandwidth in MHz. In addition, the peak power spectral density shall not exceed 11 dBm in any 1–MHz band. If transmitting antennas of directional gain greater than 6 dBi are used, both the maximum conducted output power and the peak power spectral density shall be reduced by the amount in dB that the directional gain of the antenna exceeds 6 dBi.

IC RSS-210 A9.2 (1)

The maximum e.i.r.p. shall not exceed 200 mW or 10 + 10 log10 B, dBm, whichever power is less. B is the 99% emission bandwidth in MHz. The e.i.r.p. spectral density shall not exceed 10 dBm in any 1.0 MHz band.

**DIRECTIONAL ANTENNA GAIN**

For output power, the TX chains are uncorrelated and the antenna gain is unequal among the chains. The directional gain is:

Chain 0 Antenna Gain (dBi)	Chain 1 Antenna Gain (dBi)	Uncorrelated Chains Directional Gain (dBi)
3.66	3.99	3.83

For PPSD, the TX chains are correlated and the antenna gain is unequal among the chains. The directional gain is:

Chain 0 Antenna Gain (dBi)	Chain 1 Antenna Gain (dBi)	Correlated Chains Directional Gain (dBi)
3.66	3.99	6.84

**RESULTS**

**Bandwidth and Antenna Gain**

Channel	Frequency (MHz)	Min 26 dB BW (MHz)	Min 99% BW (MHz)	Uncorrelated Directional Gain (dBi)
Mid	5580	20.85	18.39	3.83

**Limits**

Channel	Frequency (MHz)	FCC Power Limit (dBm)	IC Power Limit (dBm)	IC EIRP Limit (dBm)	Power Limit (dBm)	FCC PPSD Limit (dBm)	IC PSD Limit (dBm)	PPSD Limit (dBm)
Mid	5580	24.00	23.65	29.65	23.65	11.00	11.00	11.00

<b>Duty Cycle CF (dB)</b>	0.00	<b>Included in Calculations of Corr'd Power &amp; PPSD</b>
---------------------------	------	--

**Output Power Results**

Channel	Frequency (MHz)	Chain 0 Meas Power (dBm)	Chain 1 Meas Power (dBm)	Total Corr'd Power (dBm)	Power Limit (dBm)	Power Margi n (dB)
Mid	5580	16.88	16.24	19.58	23.65	-4.06

**PPSD Results**

Channel	Frequency (MHz)	Chain 0 Meas PPSD (dBm)	Chain 1 Meas PPSD (dBm)	Total Corr'd PPSD (dBm)	PPSD Limit (dBm)	PPSD Margi n (dB)
Mid	5580	5.49	4.90	8.22	11.00	-2.78



**OUTPUT POWER AND PPSD, Chain 0**

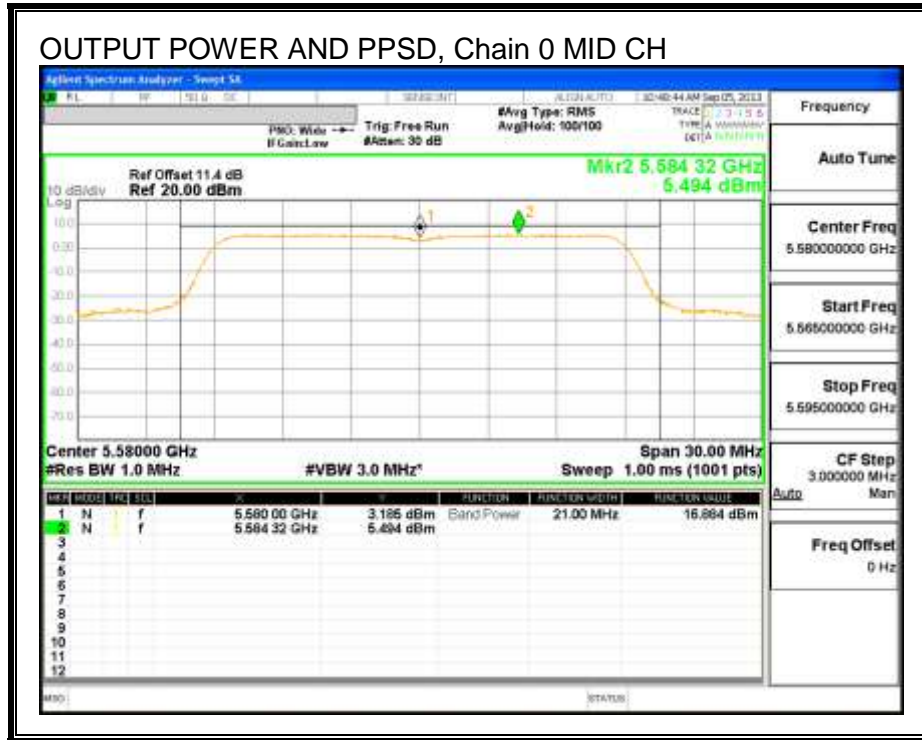

**OUTPUT POWER AND PPSD, Chain 1**

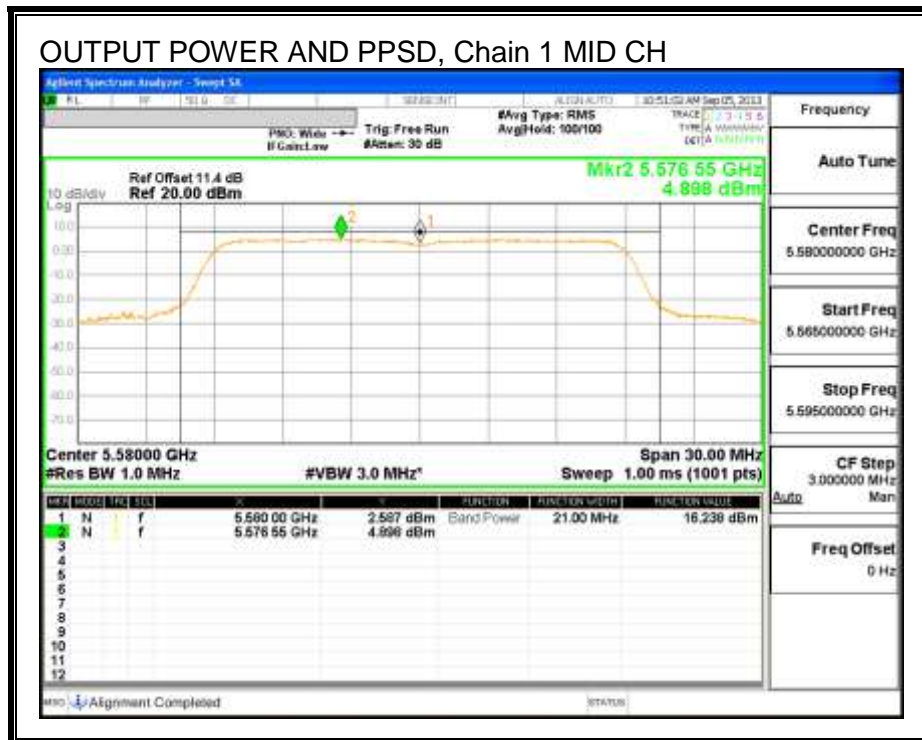

**8.13.5. PEAK EXCURSION**

**LIMITS**

FCC §15.407 (a) (6)

The ratio of the peak excursion of the modulation envelope (measured using a peak hold function) to the peak transmit power (measured as specified above) shall not exceed 13 dB across any 1 MHz bandwidth or the emission bandwidth whichever is less.

**RESULTS**

Chain 0

Channel	Frequency (MHz)	PK Level (dBm)	PSD (dBm)	DCCF (dB)	Peak Excursion (dB)	Limit (dB)	Margin (dB)
Mid	5580	13.89	5.49	0.00	8.40	13	-4.60

Chain 1

Channel	Frequency (MHz)	PK Level (dBm)	PSD (dBm)	DCCF (dB)	Peak Excursion (dB)	Limit (dB)	Margin (dB)
Mid	5580	12.14	4.90	0.00	7.24	13	-5.77

**PEAK EXCURSION, Chain 0**

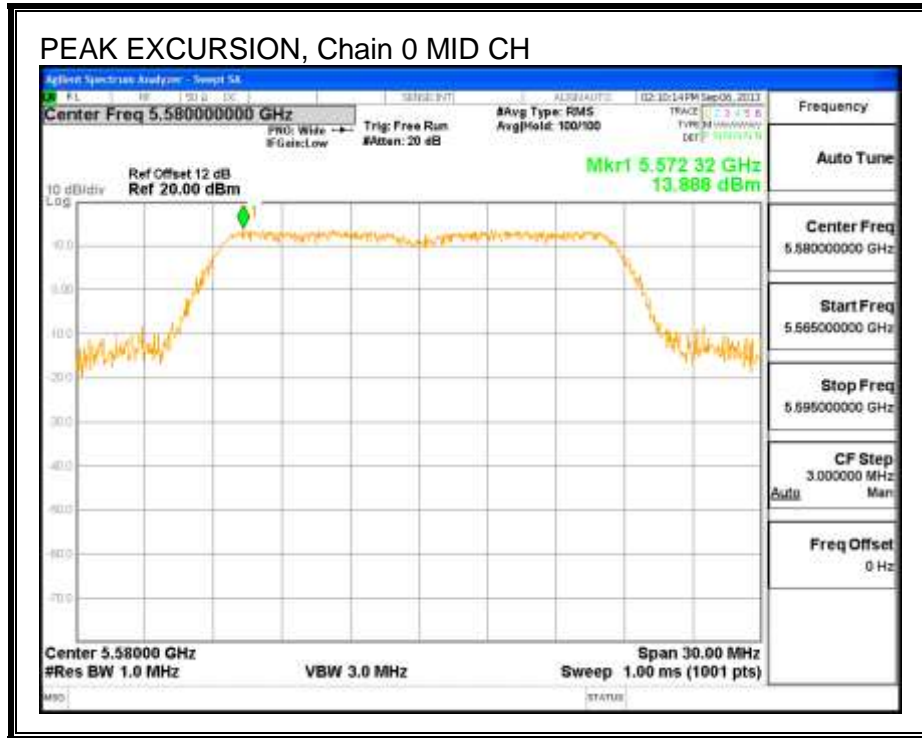

**PEAK EXCURSION, Chain 1**

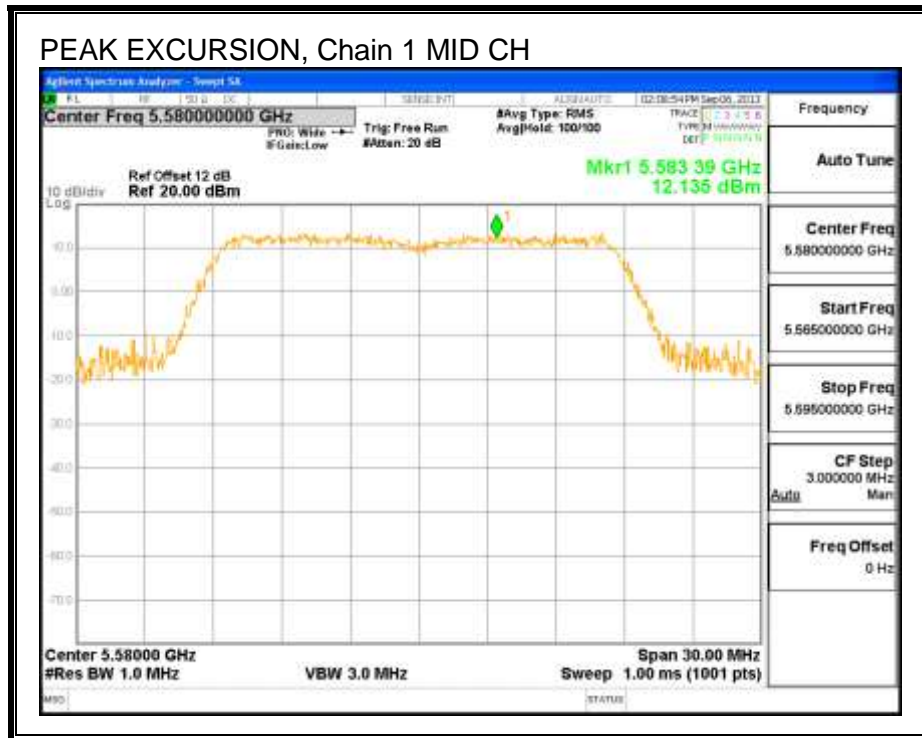

## 8.14. 802.11n HT40 SISO MODE IN THE 5.6 GHz BAND

### 8.14.1. 26 dB BANDWIDTH

#### LIMITS

None; for reporting purposes only.

#### RESULTS

Channel	Frequency (MHz)	26 dB Bandwidth (MHz)
Low	5510	40.02
Mid	5550	40.37
High	5670	40.37

**26 dB BANDWIDTH**

