



**FCC CFR47 PART 15 SUBPART E  
INDUSTRY CANADA RSS-210 ISSUE 8**

**CERTIFICATION TEST REPORT**

**FOR**

**The Apple iPad is a tablet device with iPod functions (music, application support,  
and video), 802.11a/b/g/n radio, and Bluetooth radio functions**

**MODEL NUMBER: A1458, A1459, A1460\***

**FCC ID: BCGA1458**

**IC: 579C-A1458**

**REPORT NUMBER: 12U14507-2**

**ISSUE DATE: AUGUST 15, 2012**

*Prepared for*  
**APPLE, INC.**  
**1 INFINITE LOOP**  
**CUPERTINO, CA 95014, U.S.A.**

*Prepared by*  
**UL CCS**  
**47173 BENICIA STREET**  
**FREMONT, CA 94538, U.S.A.**  
**TEL: (510) 771-1000**  
**FAX: (510) 661-0888**

\*Models differences are detailed within the body of this report



NVLAP LAB CODE 200065-0

Revision History

<u>Rev.</u>	<u>Issue Date</u>	<u>Revisions</u>	<u>Revised By</u>
--	08/15/12	Initial Issue	F. Ibrahim

## TABLE OF CONTENTS

<b>1. ATTESTATION OF TEST RESULTS.....</b>	<b>6</b>
<b>2. TEST METHODOLOGY .....</b>	<b>7</b>
<b>3. FACILITIES AND ACCREDITATION.....</b>	<b>7</b>
<b>4. CALIBRATION AND UNCERTAINTY .....</b>	<b>7</b>
4.1. MEASURING INSTRUMENT CALIBRATION .....	7
4.2. SAMPLE CALCULATION.....	7
4.3. MEASUREMENT UNCERTAINTY.....	7
<b>5. EQUIPMENT UNDER TEST .....</b>	<b>8</b>
5.1. DESCRIPTION OF EUT.....	8
5.2. DESCRIPTION OF MODELS DIFFERENCES.....	8
5.3. MAXIMUM OUTPUT POWER.....	9
5.4. DESCRIPTION OF AVAILABLE ANTENNAS.....	9
5.5. SOFTWARE AND FIRMWARE.....	10
5.6. WORST-CASE CONFIGURATION AND MODE.....	10
5.7. DESCRIPTION OF TEST SETUP.....	11
<b>6. TEST AND MEASUREMENT EQUIPMENT .....</b>	<b>14</b>
<b>7. ON TIME, DUTY CYCLE AND MEASUREMENT METHODS.....</b>	<b>15</b>
7.1. ON TIME AND DUTY CYCLE RESULTS.....	15
7.2. MEASUREMENT METHOD FOR POWER AND PPSD.....	15
7.3. MEASUREMENT METHOD FOR AVG SPURIOUS EMISSIONS ABOVE 1 GHz.....	15
7.4. DUTY CYCLE PLOTS.....	16
<b>8. ANTENNA PORT TEST RESULTS .....</b>	<b>18</b>
8.1. 802.11a MODE IN THE 5.2 GHz BAND.....	18
8.1.1. 26 dB BANDWIDTH .....	18
8.1.2. 99% BANDWIDTH .....	21
8.1.3. AVERAGE POWER .....	24
8.1.4. OUTPUT POWER AND PPSD.....	25
8.1.5. PEAK EXCURSION .....	30
8.2. 802.11n HT20 MODE IN THE 5.2 GHz BAND.....	33
8.2.1. 26 dB BANDWIDTH .....	33
8.2.2. 99% BANDWIDTH .....	36
8.2.3. AVERAGE POWER .....	39
8.2.4. OUTPUT POWER AND PPSD.....	40
8.2.5. PEAK EXCURSION .....	45
8.3. 802.11n HT40 MODE IN THE 5.2 GHz BAND.....	48
8.3.1. 26 dB BANDWIDTH .....	48

8.3.2.	99% BANDWIDTH .....	50
8.3.3.	AVERAGE POWER .....	52
8.3.4.	OUTPUT POWER AND PPSD.....	53
8.3.5.	PEAK EXCURSION .....	57
8.4.	<i>802.11a MODE IN THE 5.3 GHz BAND</i> .....	59
8.4.1.	26 dB BANDWIDTH .....	59
8.4.2.	99% BANDWIDTH .....	62
8.4.3.	AVERAGE POWER .....	65
8.4.4.	OUTPUT POWER AND PPSD.....	66
8.4.5.	PEAK EXCURSION .....	71
8.4.6.	TPC POWER.....	74
8.5.	<i>802.11n HT20 MODE IN THE 5.3 GHz BAND</i> .....	75
8.5.1.	26 dB BANDWIDTH .....	75
8.5.2.	99% BANDWIDTH .....	78
8.5.3.	AVERAGE POWER .....	81
8.5.4.	OUTPUT POWER AND PPSD.....	82
8.5.5.	PEAK EXCURSION .....	87
8.5.6.	TPC POWER.....	90
8.6.	<i>802.11n HT40 MODE IN THE 5.3 GHz BAND</i> .....	91
8.6.1.	26 dB BANDWIDTH .....	91
8.6.2.	99% BANDWIDTH .....	93
8.6.3.	AVERAGE POWER .....	95
8.6.4.	OUTPUT POWER AND PPSD.....	96
8.6.5.	PEAK EXCURSION .....	100
8.6.6.	TPC POWER.....	102
8.7.	<i>802.11a MODE IN THE 5.6 GHz BAND</i> .....	103
8.7.1.	26 dB BANDWIDTH .....	103
8.7.2.	99% BANDWIDTH .....	107
8.7.3.	AVERAGE POWER .....	111
8.7.4.	OUTPUT POWER AND PPSD.....	112
8.7.5.	PEAK EXCURSION .....	118
8.7.6.	TPC POWER.....	121
8.7.7.	CONDUCTED WEATHER RADAR BAND EMISSIONS .....	122
8.8.	<i>802.11n HT20 MODE IN THE 5.6 GHz BAND</i> .....	123
8.8.1.	26 dB BANDWIDTH .....	123
8.8.2.	99% BANDWIDTH .....	127
8.8.3.	AVERAGE POWER .....	131
8.8.4.	OUTPUT POWER AND PPSD.....	132
8.8.5.	PEAK EXCURSION .....	138
8.8.6.	TPC POWER.....	141
8.8.7.	CONDUCTED WEATHER RADAR BAND EMISSIONS .....	142
8.9.	<i>802.11n HT40 MODE IN THE 5.6 GHz BAND</i> .....	143
8.9.1.	26 dB BANDWIDTH .....	143
8.9.2.	99% BANDWIDTH .....	146
8.9.3.	AVERAGE POWER .....	149
8.9.4.	OUTPUT POWER AND PPSD.....	150
8.9.5.	PEAK EXCURSION .....	155
8.9.6.	TPC POWER.....	158
8.9.7.	CONDUCTED WEATHER RADAR BAND EMISSIONS .....	159

**9. RADIATED TEST RESULTS ..... 160**

9.1. *LIMITS AND PROCEDURE ..... 160*

9.2. *TRANSMITTER ABOVE 1 GHz ..... 161*

9.2.1. TX ABOVE 1 GHz 802.11a MODE IN THE 5.2 GHz BAND..... 161

9.2.2. TX ABOVE 1 GHz 802.11n HT20 MODE IN THE 5.2 GHz BAND..... 164

9.2.3. TX ABOVE 1 GHz 802.11n HT40 MODE IN THE 5.2 GHz BAND..... 167

9.2.4. TX ABOVE 1 GHz 802.11a MODE IN THE 5.3 GHz BAND..... 170

9.2.5. TX ABOVE 1 GHz 802.11n HT20 MODE IN THE 5.3 GHz BAND..... 173

9.2.6. TX ABOVE 1 GHz 802.11n HT40 MODE IN THE 5.3 GHz BAND..... 176

9.2.7. TX ABOVE 1 GHz 802.11a MODE IN THE 5.6 GHz BAND..... 179

9.2.8. TX ABOVE 1 GHz 802.11n HT20 MODE IN THE 5.6 GHz BAND..... 183

9.2.9. TX ABOVE 1 GHz 802.11n HT40 MODE IN THE 5.6 GHz BAND..... 187

9.2.1. 2.4GHZ AND 5GHZ BAND CO-LOCATION..... 191

9.3. *WORST-CASE BELOW 1 GHz..... 194*

**10. AC POWER LINE CONDUCTED EMISSIONS ..... 197**

**11. DYNAMIC FREQUENCY SELECTION ..... 201**

11.1. *OVERVIEW..... 201*

11.1.1. LIMITS ..... 201

11.1.2. TEST AND MEASUREMENT SYSTEM ..... 204

11.1.3. SETUP OF EUT..... 207

11.1.4. DESCRIPTION OF EUT ..... 209

11.2. *CLIENT MODE RESULTS FOR 20 MHz BANDWIDTH ..... 211*

11.2.1. TEST CHANNEL ..... 211

11.2.2. RADAR WAVEFORM AND TRAFFIC ..... 211

11.2.3. OVERLAPPING CHANNEL TESTS ..... 213

11.2.4. MOVE AND CLOSING TIME ..... 213

11.3. *CLIENT MODE RESULTS FOR 40 MHz BANDWIDTH ..... 218*

11.3.1. TEST CHANNEL ..... 218

11.3.2. RADAR WAVEFORM AND TRAFFIC ..... 218

11.3.3. OVERLAPPING CHANNEL TESTS ..... 220

11.3.4. MOVE AND CLOSING TIME ..... 220

11.3.5. NON-OCCUPANCY PERIOD..... 225

11.4. *CLIENT-TO-CLIENT COMMUNICATIONS MODE RESULTS FOR 20 MHz BANDWIDTH..... 226*

11.4.1. TEST CHANNEL ..... 226

11.4.2. RADAR WAVEFORM AND TRAFFIC ..... 226

11.4.3. OVERLAPPING CHANNEL TESTS ..... 228

11.4.4. MOVE AND CLOSING TIME ..... 228

**12. SETUP PHOTOS ..... 233**

# 1. ATTESTATION OF TEST RESULTS

**COMPANY NAME:** APPLE, INC.  
1 INFINITE LOOP  
CUPERTINO, CA, 95014, U.S.A.

**EUT DESCRIPTION:** The Apple iPad is a tablet device with iPod functions (music, application support, and video), 802.11a/b/g/n radio, and Bluetooth radio functions

**MODEL:** A1458, A1459, & A1460

**SERIAL NUMBER:** 20558

**DATE TESTED:** AUGUST 3-13, 2012

APPLICABLE STANDARDS	
STANDARD	TEST RESULTS
CFR 47 Part 15 Subpart E	Pass
INDUSTRY CANADA RSS-210 Issue 8 Annex 9	Pass
INDUSTRY CANADA RSS-GEN Issue 3	Pass

UL CCS tested the above equipment in accordance with the requirements set forth in the above standards. All indications of Pass/Fail in this report are opinions expressed by UL CCS based on interpretations and/or observations of test results. Measurement Uncertainties were not taken into account and are published for informational purposes only. The test results show that the equipment tested is capable of demonstrating compliance with the requirements as documented in this report.

**Note:** The results documented in this report apply only to the tested sample, under the conditions and modes of operation as described herein. This document may not be altered or revised in any way unless done so by UL CCS and all revisions are duly noted in the revisions section. Any alteration of this document not carried out by UL CCS will constitute fraud and shall nullify the document. This report must not be used by the client to claim product certification, approval, or endorsement by NVLAP, NIST, any agency of the Federal Government, or any agency of any government.

Approved & Released For UL CCS By:

Tested By:



FRANK IBRAHIM  
EMC SUPERVISOR  
UL CCS

TOM CHEN  
EMC ENGINEER  
UL CCS

## 2. TEST METHODOLOGY

The tests documented in this report were performed in accordance with FCC CFR 47 Part 2, FCC CFR 47 Part 15, FCC 06-96, FCC KDB 789033, ANSI C63.10-2003, RSS-GEN Issue 3, and RSS-210 Issue 8.

## 3. FACILITIES AND ACCREDITATION

The test sites and measurement facilities used to collect data are located at 47173 Benicia Street, Fremont, California, USA.

UL CCS is accredited by NVLAP, Laboratory Code 200065-0. The full scope of accreditation can be viewed at <http://www.ccsemc.com>.

## 4. CALIBRATION AND UNCERTAINTY

### 4.1. MEASURING INSTRUMENT CALIBRATION

The measuring equipment utilized to perform the tests documented in this report has been calibrated in accordance with the manufacturer's recommendations, and is traceable to recognized national standards.

### 4.2. SAMPLE CALCULATION

Where relevant, the following sample calculation is provided:

$$\begin{aligned} \text{Field Strength (dBuV/m)} &= \text{Measured Voltage (dBuV)} + \text{Antenna Factor (dB/m)} + \\ &\text{Cable Loss (dB)} - \text{Preamp Gain (dB)} \\ 36.5 \text{ dBuV} + 18.7 \text{ dB/m} + 0.6 \text{ dB} - 26.9 \text{ dB} &= 28.9 \text{ dBuV/m} \end{aligned}$$

### 4.3. MEASUREMENT UNCERTAINTY

Where relevant, the following measurement uncertainty levels have been estimated for tests performed on the apparatus:

PARAMETER	UNCERTAINTY
Conducted Disturbance, 0.15 to 30 MHz	3.52 dB
Radiated Disturbance, 30 to 1000 MHz	4.94 dB

Uncertainty figures are valid to a confidence level of 95%.

## 5. EQUIPMENT UNDER TEST

### 5.1. DESCRIPTION OF EUT

The EUT is a iPad tablet device with iPod functions (music, application support, and video), 802.11a/b/g/n radio, and Bluetooth radio functions.

### 5.2. DESCRIPTION OF MODELS DIFFERENCES

FCC ID: BCGA1458  
IC ID: 579C-A1458  
Model #: A1458

Model A1458, is a tablet with multimedia functions (music, application support, and video) IEEE 802.11a/b/g/n radio and Bluetooth radio. The rechargeable battery is not user accessible.

FCC ID: BCGA1459  
IC ID: 579C-A1459  
Model #: A1459

Model A1459, is a tablet with multimedia functions (music, application support, and video), cellular GSM/GPRS/EGPRS/WCDMA/HSPA+/DC-HSDPA/LTE radio, IEEE 802.11a/b/g/n and Bluetooth radio. The rechargeable battery is not user accessible.

FCC ID: BCGA1460  
IC ID: 579C-A1460  
Model #: A1460

Model A1460, is a tablet with multimedia functions (music, application support, and video), cellular GSM/GPRS/EGPRS/WCDMA/HSPA+/DC-HSDPA/CDMA1xRTT/ EV-DO Rev 0, A, B / LTE radio, IEEE 802.11a/b/g/n radio and Bluetooth radio. The rechargeable battery is not user accessible.



### 5.3. MAXIMUM OUTPUT POWER

The transmitter has a maximum conducted output power as follows:

Frequency Range (MHz)	Mode	Output Power (dBm)	Output Power (mW)
5180 - 5240	802.11a	14.295	26.884
5180 - 5240	802.11n HT20	14.322	27.052
5190 - 5230	802.11n HT40	15.428	34.898
5260 - 5320	802.11a	17.983	62.849
5260 - 5320	802.11n HT20	17.941	62.244
5270 - 5310	802.11n HT40	18.070	64.121
5500 - 5700	802.11a	19.021	79.818
5500 - 5700	802.11n HT20	18.879	77.250
5510 - 5670	802.11n HT40	18.531	71.302

### 5.4. DESCRIPTION OF AVAILABLE ANTENNAS

The radio utilizes a PIFA antenna, with a maximum gain as shown below:

Frequency Band (GHz)	Antenna Gain (dBi)
2.4-2.4835	-0.26
5.15-5.25	4.63
5.25-5.35	4.25
5.5-5.7	4.51
5.725-5.85	4.9

---

## **5.5. SOFTWARE AND FIRMWARE**

The firmware installed in the EUT during testing was 10A378

The EUT driver software installed during testing was Broadcom\_Rel\_6\_10\_56\_172

The test utility software used during testing was WL\_tool.

## **5.6. WORST-CASE CONFIGURATION AND MODE**

For the fundamental investigation, since the EUT is a portable device that has three orientations; X, Y and Z orientations have been investigated, also with AC/DC adapter, and earphone, and the worst case was found to be at Y orientation without AC adapter and earphone.

For Radiated Emissions below 1 GHz and Power line Conducted Emissions, the channel with the highest conducted output power was selected as a worst-case scenario.

Worst-case data rates as provided by the manufacturer are:

For 11a mode: 6Mbps

For 11n HT20 MCS0

For 11n HT40 MCS0

## 5.7. DESCRIPTION OF TEST SETUP

### SUPPORT EQUIPMENT

PERIPHERAL SUPPORT EQUIPMENT LIST				
Description	Manufacturer	Model	Serial Number	FCC ID
AC Adapter	Apple	A1401	D060812	DoC
Power Splitter	Krytar	158010	99250	N/A
Dc Power Supply	Agilent	E3610A	KR24104150	N/A
Laptop PC	Apple	MacBook Pro	AOU269116	N/A

### I/O CABLES (CONDUCTED SETUP)

I/O CABLE LIST						
Cable No.	Port	#of Identical Ports	Connector Type	Cable Type	Cable Length	Remarks
1	AC	2	AC	Un-shielded	2.0m	N/A
2	DC	1	DC	Un-shielded	1.0m	N/A
3	Antenna Port	1	Splitter	Un-shielded	0.1m	N/A
4	RF out	1	Spectrum Analyzer	Un-Shielded	None	N/A
5	RF out	1	Power Meter	Shielded	None	NA

### I/O CABLES (RADIATED SETUP)

I/O Cable List						
Cable No	Port	# of identical ports	Connector Type	Cable Type	Cable Length (m)	Remarks
1	DC	1	MINI USB	UN-SHELDED	1.0m	N/A
2	AUDIO	1	MINI JACK	UN-SHELDED	1.0m	N/A

**SETUP DIAGRAM FOR CONDUCTED TEST**

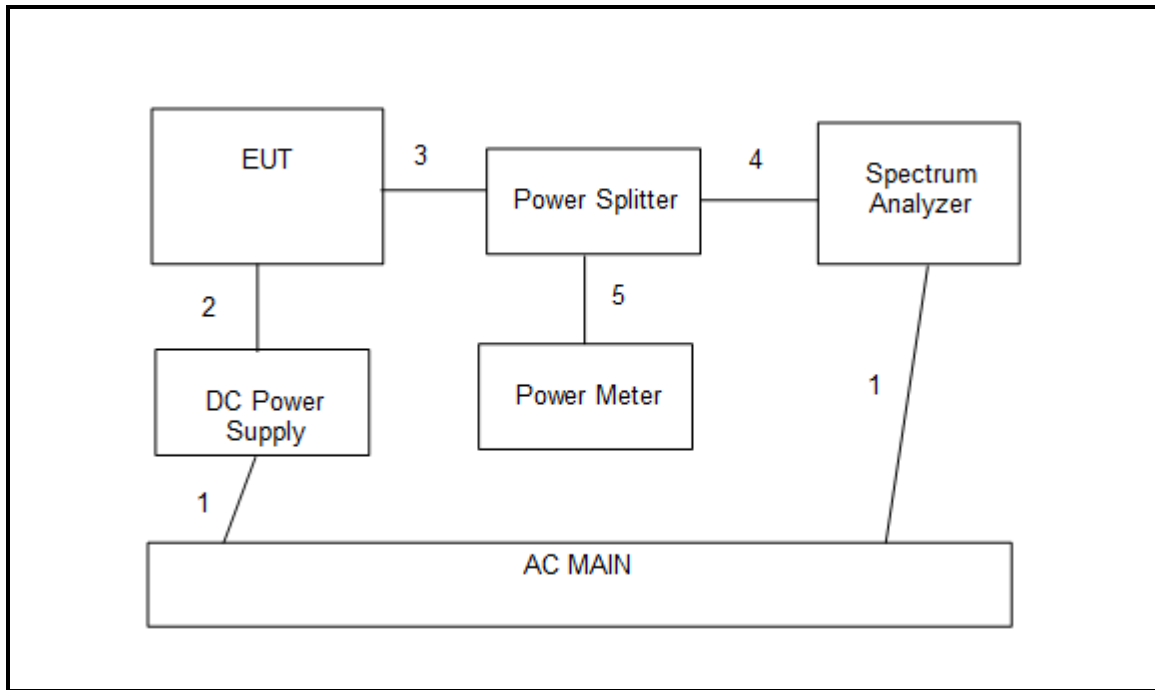

**SETUP DIAGRAM FOR RADIATED TEST**

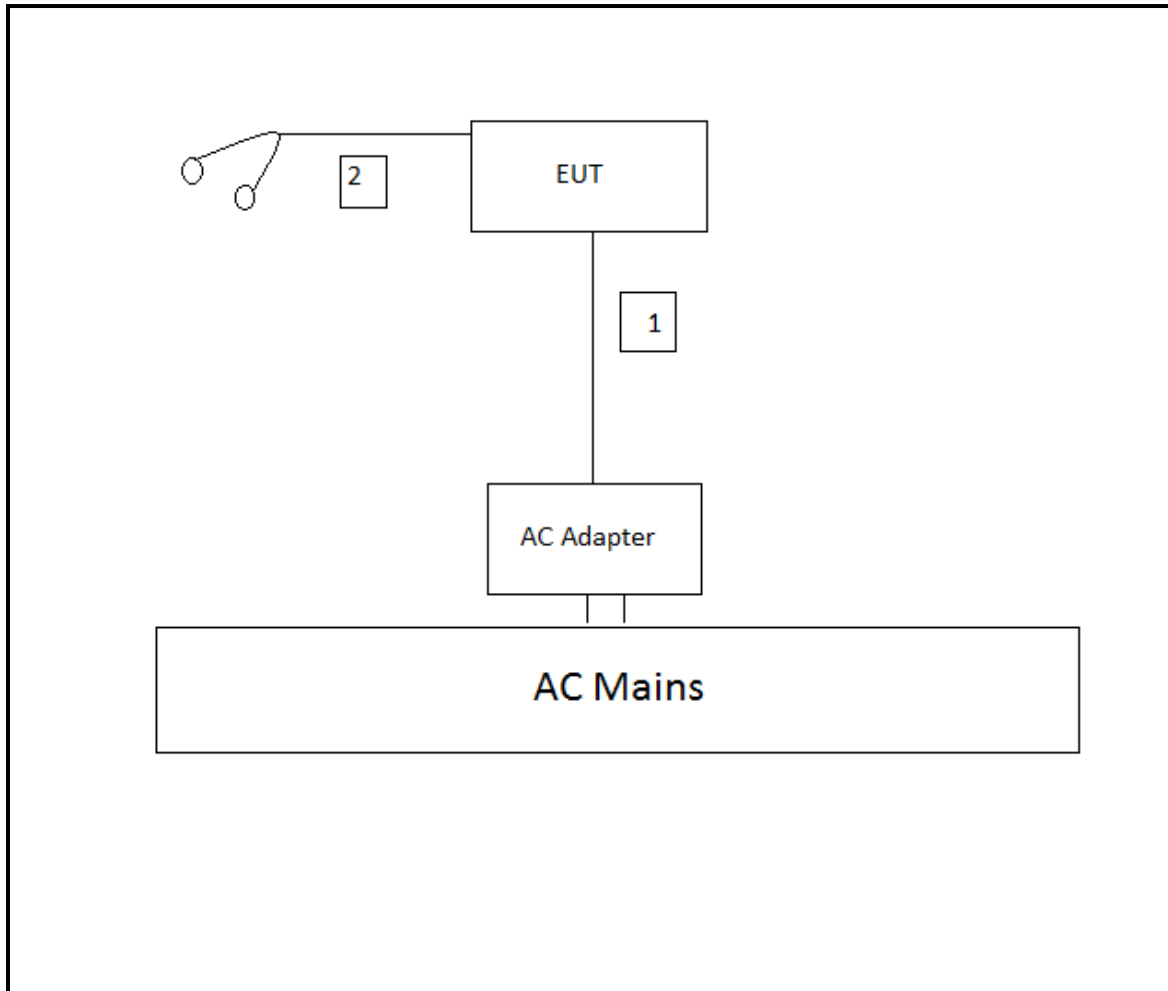

## 6. TEST AND MEASUREMENT EQUIPMENT

The following test and measurement equipment was utilized for the tests documented in this report:

Test Equipment List				
Description	Manufacturer	Model	Asset	Cal Due
Preamplifier, 26.5 GHz	Agilent / HP	8449B	C01052	11/11/12
Antenna, Horn, 18 GHz	EMCO	3115	C00945	10/06/12
Preamplifier, 1300 MHz	Agilent / HP	8447D	C00580	11/11/12
Antenna, Bilog, 2 GHz	Sunol Sciences	JB1		02/07/13
Horn Antenna, 26.5 GHz	ARA	MWH-1826/B	C00589	04/23/13
Horn Antenna, 40 GHz	ARA	MWH-2640/B	C00981	06/14/13
Preamplifier, 40 GHz	Miteq	NSP4000-SP2	C00990	03/14/13
Reject Filter, 2.0-2.9 GHz	Micro-Tronics	BRM50702	N02684	CNR
High Pass Filter, 7.6 GHz	Micro-Tronics	HPM13195	N02682	CNR
Spectrum Analyzer, 44 GHz	Agilent / HP	E4446A	C01069	12/15/12
E-Series Power Sensor 9 kHg~18 GHz	Agilent	E9304A	1260847C	05/23/13
P-Series single channel Power Meter	Agilent / HP	N1911A		07/27/13
Reject Filter, 5.725-5.825 GHz	Micro-Tronics	BRC13192	N02676	CNR
Reject Filter, 2.4-2.5 GHz	Micro-Tronics	BRM50702	N02685	CNR
Highpass Filter, 7.6 GHz	Micro-Tronics	HPM13195	N02682	CNR
EMI Test Receiver, 30MHz	R & S	ESHS 20	N02396	08/19/13
LISN, 30 MHz	FCC	LISN-50/250-25-2	N02625	12/13/12

## 7. ON TIME, DUTY CYCLE AND MEASUREMENT METHODS

### LIMITS

None; for reporting purposes only.

### PROCEDURE

KDB 789033 Zero-Span Spectrum Analyzer Method.

### 7.1. ON TIME AND DUTY CYCLE RESULTS

Mode	ON Time B (msec)	Period (msec)	Duty Cycle x (linear)	Duty Cycle (%)	Duty Cycle Correction Factor (dB)	1/B Minimum VBW (kHz)
802.11a 20 MHz	2.050	2.079	0.986	98.6%	0.06	0.488
802.11n HT20	1.903	1.930	0.986	98.6%	0.06	0.525
802.11n HT40	0.943	0.960	0.983	98.3%	0.08	1.060

### 7.2. MEASUREMENT METHOD FOR POWER AND PPSD

For 802.11a and 802.11n HT20 modes, the Duty Cycle is greater than or equal to 98% therefore KDB 789033 Method SA-1 is used.

For 802.11n HT40 mode, the Duty Cycle is greater than or equal to 98% therefore KDB 789033 Method SA-1 is used.

### 7.3. MEASUREMENT METHOD FOR AVG SPURIOUS EMISSIONS ABOVE 1 GHz

For 802.11a and 802.11n HT20 modes, the Duty Cycle is greater than or equal to 98%, KDB 789033 Method VB with Power RMS Averaging is used.

For 802.11n HT40 mode, the Duty Cycle is greater than or equal to 98%, KDB 789033 Method VB with Power RMS Averaging is used.

### 7.4. DUTY CYCLE PLOTS

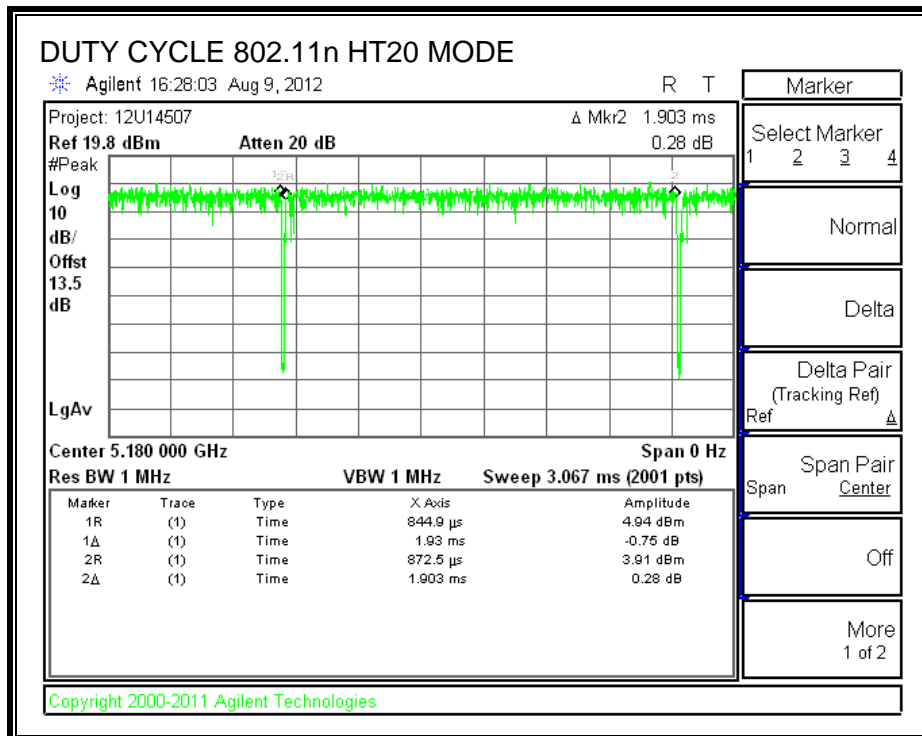
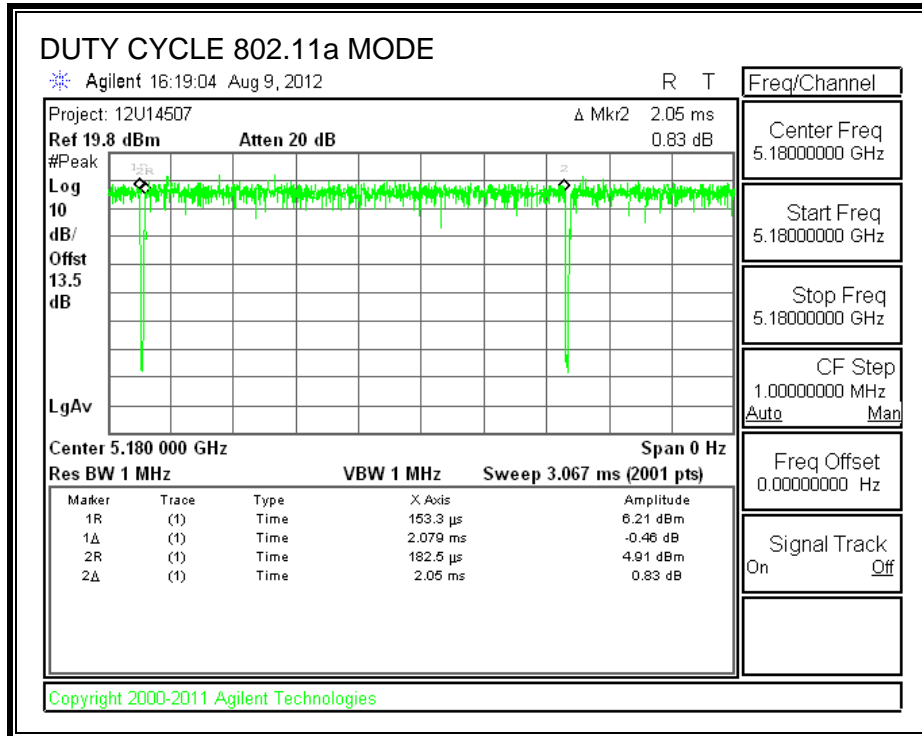



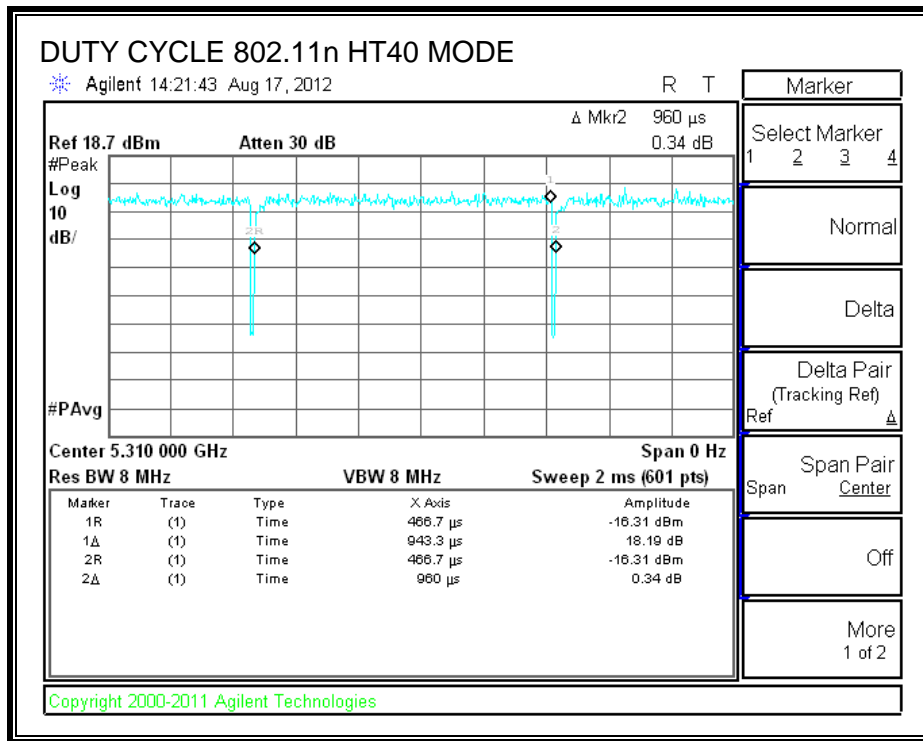

## 8. ANTENNA PORT TEST RESULTS

### 8.1. 802.11a MODE IN THE 5.2 GHz BAND

#### 8.1.1. 26 dB BANDWIDTH

##### LIMITS

None; for reporting purposes only.

##### RESULTS

Channel	Frequency (MHz)	26 dB Bandwidth (MHz)
Low	5180	18.85
Mid	5200	18.85
High	5240	18.95

**26 dB BANDWIDTH**

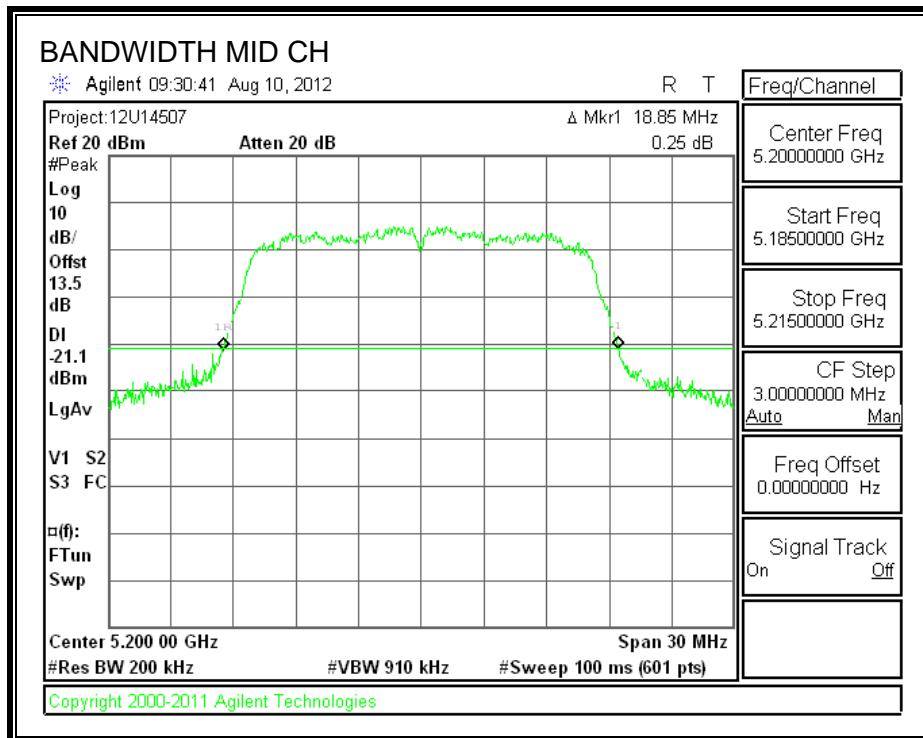
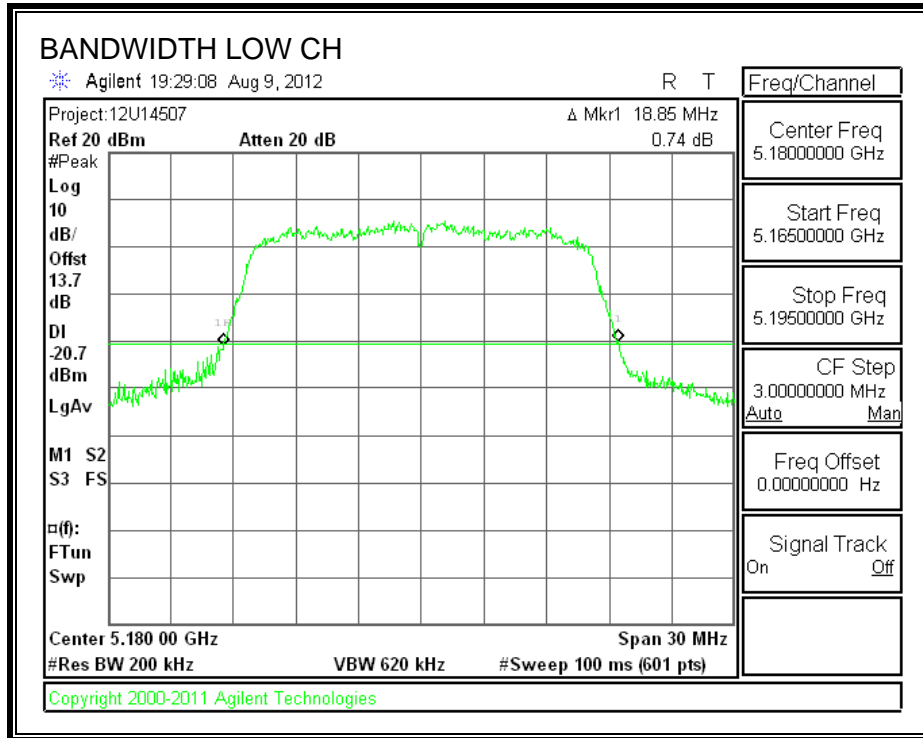

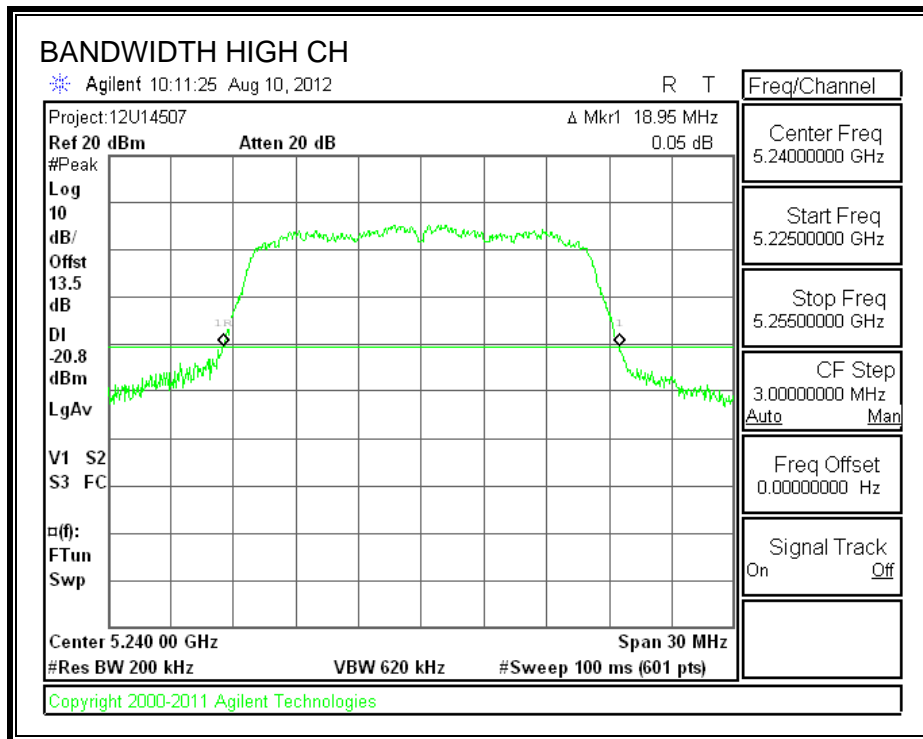

**8.1.2. 99% BANDWIDTH**

**LIMITS**

None; for reporting purposes only.

**RESULTS**

Channel	Frequency (MHz)	99% Bandwidth (MHz)
Low	5180	16.3450
Mid	5200	16.3510
High	5240	16.3412

**99% BANDWIDTH**

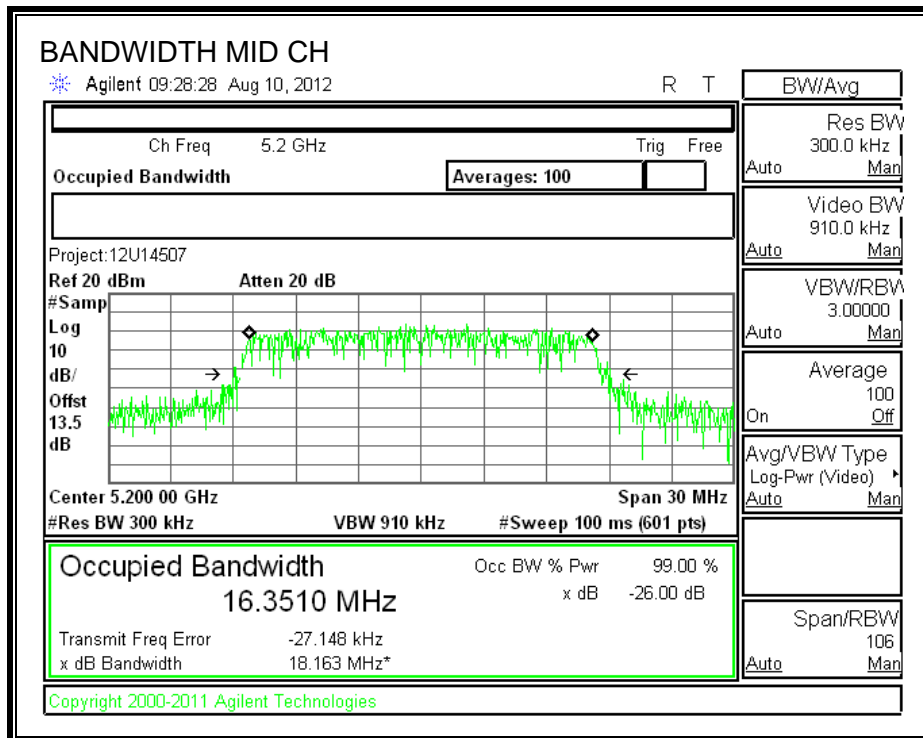
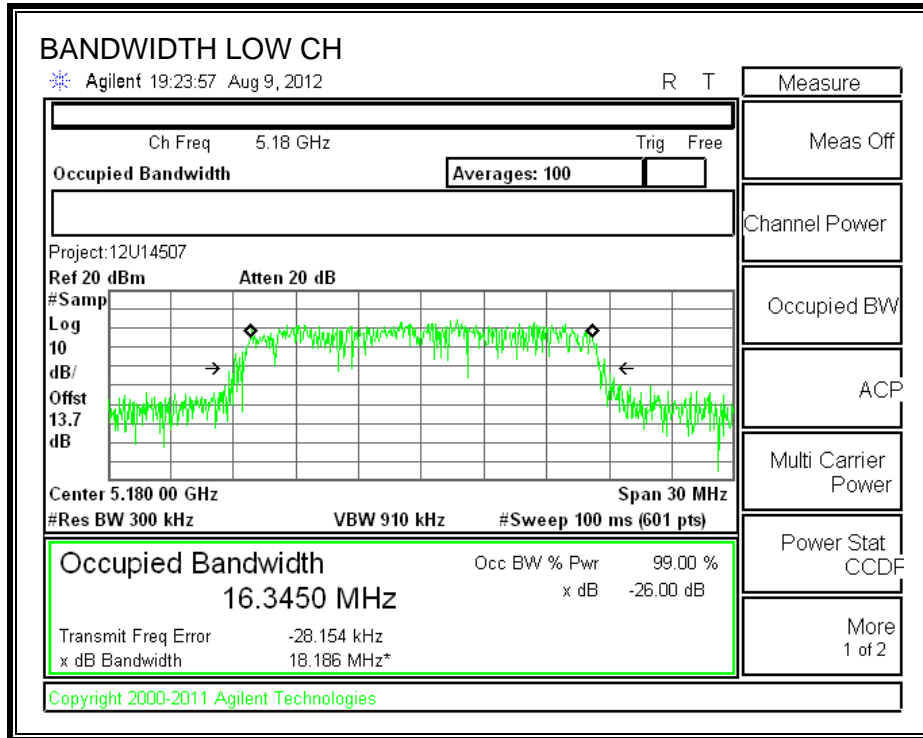

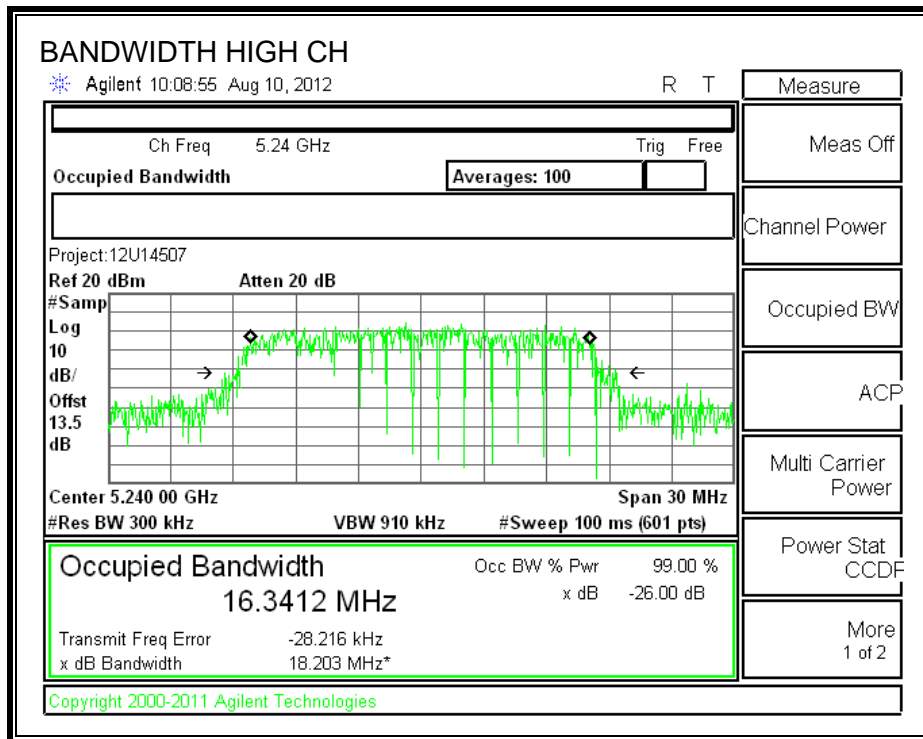

### **8.1.3. AVERAGE POWER**

#### **LIMITS**

None; for reporting purposes only.

#### **TEST PROCEDURE**

The transmitter output is connected to a power meter.

The cable assembly insertion loss of 13.5 dB (including 12 dB pad and 1.5 dB cable) was entered as an offset in the power meter to allow for direct reading of power.

#### **RESULTS**

Channel	Frequency (MHz)	Power (dBm)
Low	5180	13.98
Mid	5200	13.98
High	5240	13.98



## **8.1.4. OUTPUT POWER AND PPSD**

### **LIMITS**

#### **FCC §15.407 (a) (1):**

For the band 5.15–5.25 GHz, the maximum conducted output power over the frequency band of operation shall not exceed the lesser of 50 mW or  $4 \text{ dBm} + 10 \log B$ , where B is the 26-dB emission bandwidth in MHz. In addition, the peak power spectral density shall not exceed 4 dBm in any 1-MHz band. If transmitting antennas of directional gain greater than 6 dBi are used, both the maximum conducted output power and the peak power spectral density shall be reduced by the amount in dB that the directional gain of the antenna exceeds 6 dBi.

#### **IC RSS-210 A9.2 (1):**

For the 5.15 – 5.25 GHz band, The maximum e.i.r.p. shall not exceed 200 mW or  $10 + 10 \log B$ , dBm, whichever power is less. B is the 99% emission bandwidth in MHz. The e.i.r.p. spectral density shall not exceed 10 dBm in any 1.0 MHz band.

### **DIRECTIONAL ANTENNA GAIN**

There is only one transmitter output therefore the directional gain is equal to the antenna gain.

**RESULTS**

**Limits FCC 15.407**

Channel	Frequency (MHz)	Fixed Limit (dBm)	B (MHz)	4 + 10 Log B Limit (dBm)	Directional Gain (dBi)	Power Limit (dBm)	PPSD Limit (dBm)
Low	5180	17	18.85	22.75	4.63	17.00	4.00
Mid	5200	17	18.85	22.75	4.63	17.00	4.00
High	5240	17	18.95	22.78	4.63	17.00	4.00

**Output Power Results**

Channel	Frequency (MHz)	Meas Power (dBm)	Corr'd Power (dBm)	Power Limit (dBm)	Power Margin (dB)
Low	5180	14.295	14.295	17.00	-2.705
Mid	5200	14.279	14.279	17.00	-2.721
High	5240	14.227	14.227	17.00	-2.773

**PPSD Results**

Channel	Frequency (MHz)	Meas PPSD (dBm)	Corr'd PPSD (dBm)	PPSD Limit (dBm)	PPSD Margin (dB)
Low	5180	3.84	3.84	4.00	-0.16
Mid	5200	3.83	3.83	4.00	-0.17
High	5240	3.84	3.84	4.00	-0.16

**IC RSS-210 A9.2 (1)**

Channel	Frequency (MHz)	Fixed EIRP Limit (dBm)	B 99% (MHz)	10 + 10 Log B EIRP Limit (dBm)	Directional Gain (dBi)	Power Limit (dBm)	PPSD Limit (dBm)
Low	5180	23	16.3450	22.1338	4.63	22.1338	10.0000
Mid	5200	23	16.3510	22.1354	4.63	22.1354	10.0000
High	5240	23	16.3412	22.1328	4.63	22.1328	10.0000

**Output Power Results**

Channel	Frequency (MHz)	Meas Power (dBm)	Corr'd Power (dBm)	Directional Gain (dBi)	Power EIRP Limit (dBm)	Power Margin (dB)
Low	5180	14.295	14.295	2.09	22.1338	-5.7488
Mid	5200	14.279	14.279	2.09	22.1354	-5.7664
High	5240	14.227	14.227	2.09	22.1328	-5.8158

**PPSD Results**

Channel	Frequency (MHz)	Meas PPSD (dBm)	Corr'd PPSD (dBm)	Directional Gain (dBi)	PPSD EIRP Limit (dBm)	PPSD Margin (dB)
Low	5180	3.84	3.84	2.09	10.0000	-4.0700
Mid	5200	3.83	3.83	2.09	10.0000	-4.0800
High	5240	3.84	3.84	2.09	10.0000	-4.0700

**OUTPUT POWER AND PPSD**

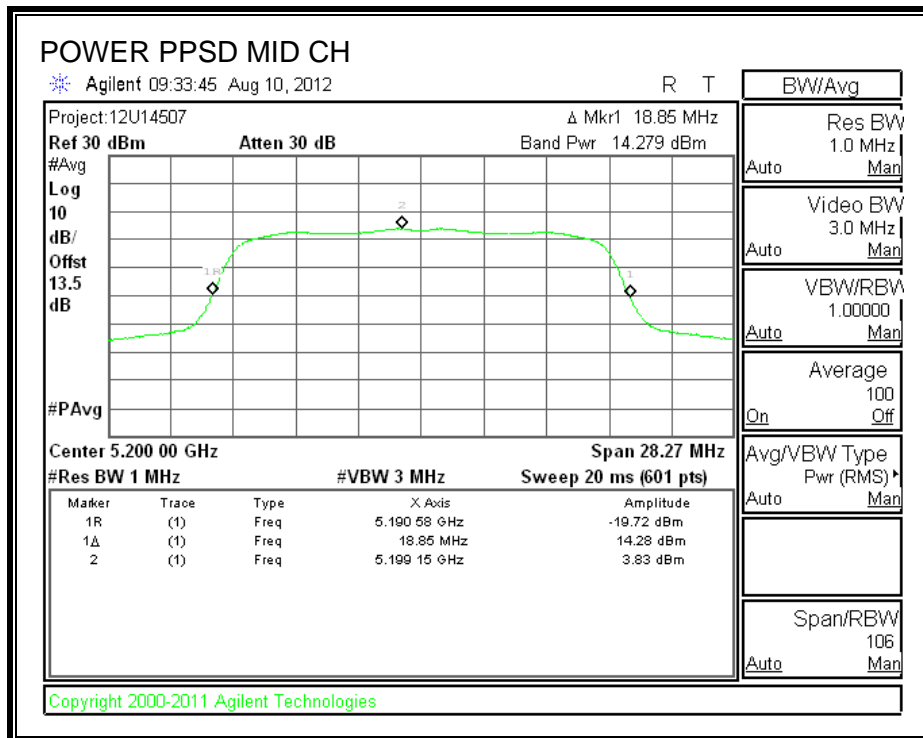
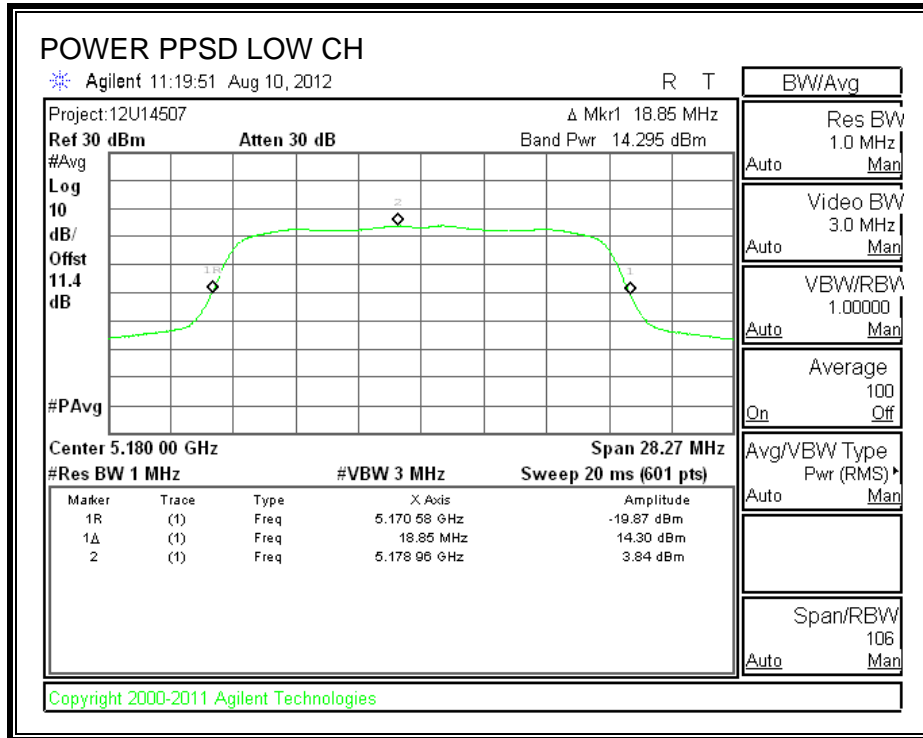

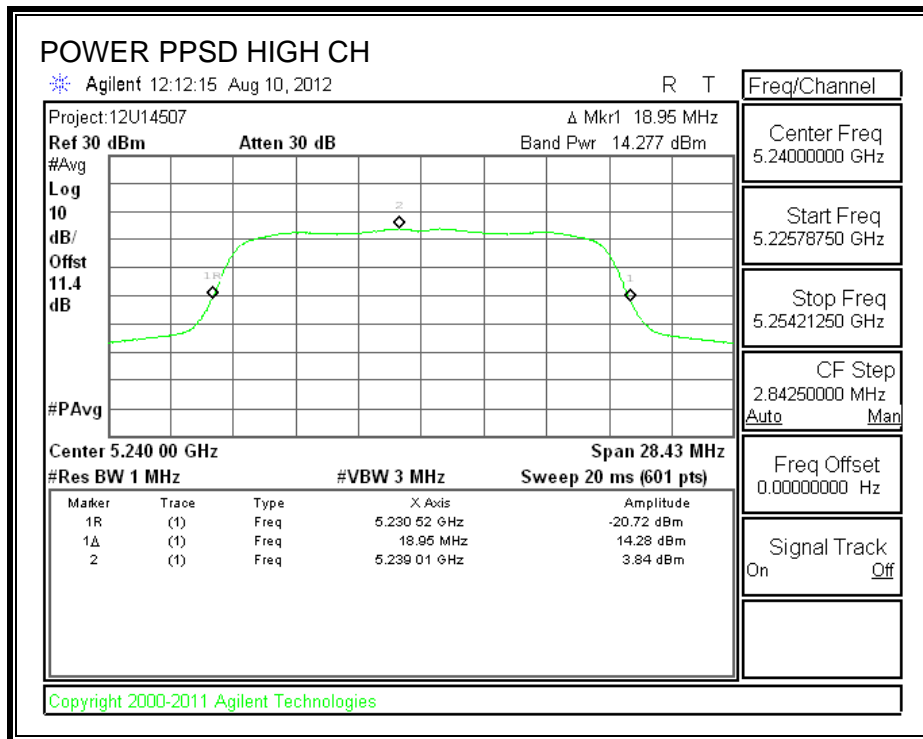

### 8.1.5. PEAK EXCURSION

#### LIMITS

FCC §15.407 (a) (6)

The ratio of the peak excursion of the modulation envelope (measured using a peak hold function) to the peak transmit power (measured as specified above) shall not exceed 13 dB across any 1 MHz bandwidth or the emission bandwidth whichever is less.

#### RESULTS

Channel	Frequency (MHz)	Peak Excursion (dB)	Limit (dB)	Margin (dB)
Low	5180	10.72	13	-2.28
Mid	5200	10.03	13	-2.97
High	5240	9.75	13	-3.25

**PEAK EXCURSION**

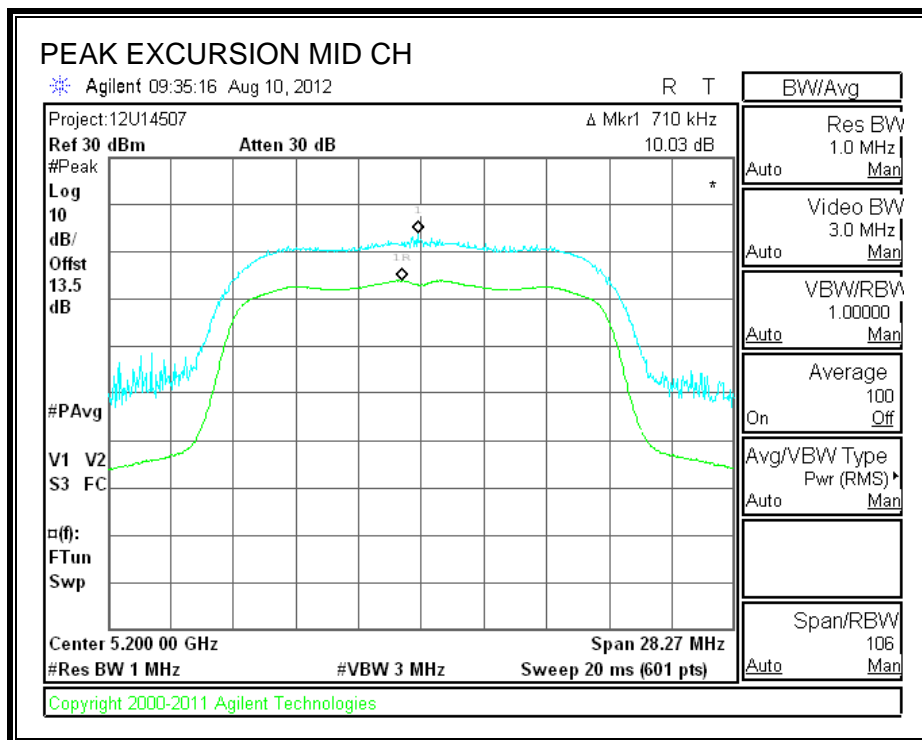
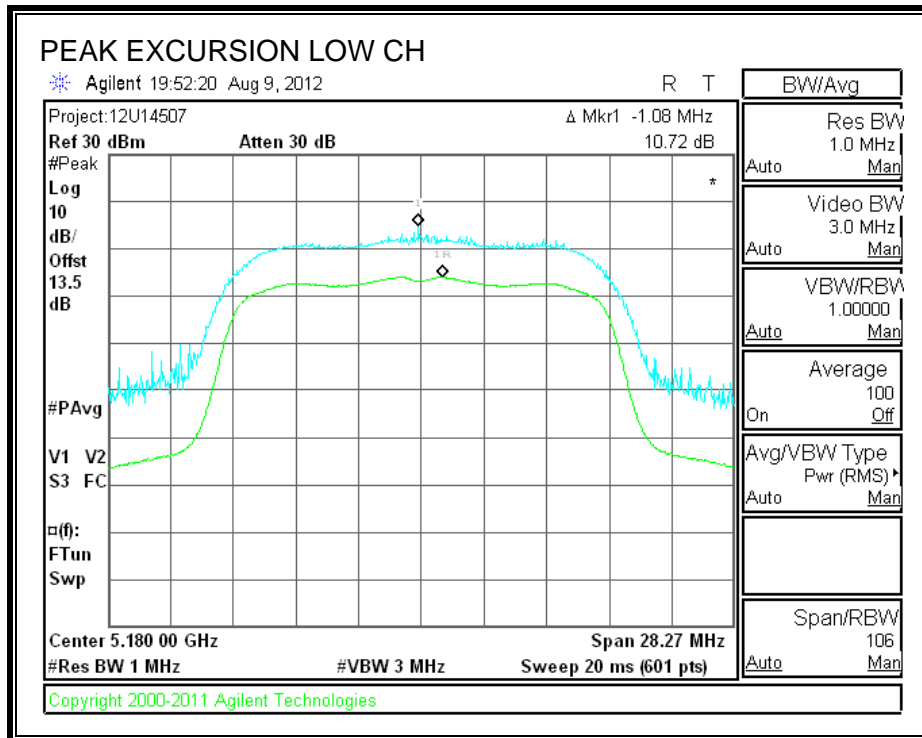

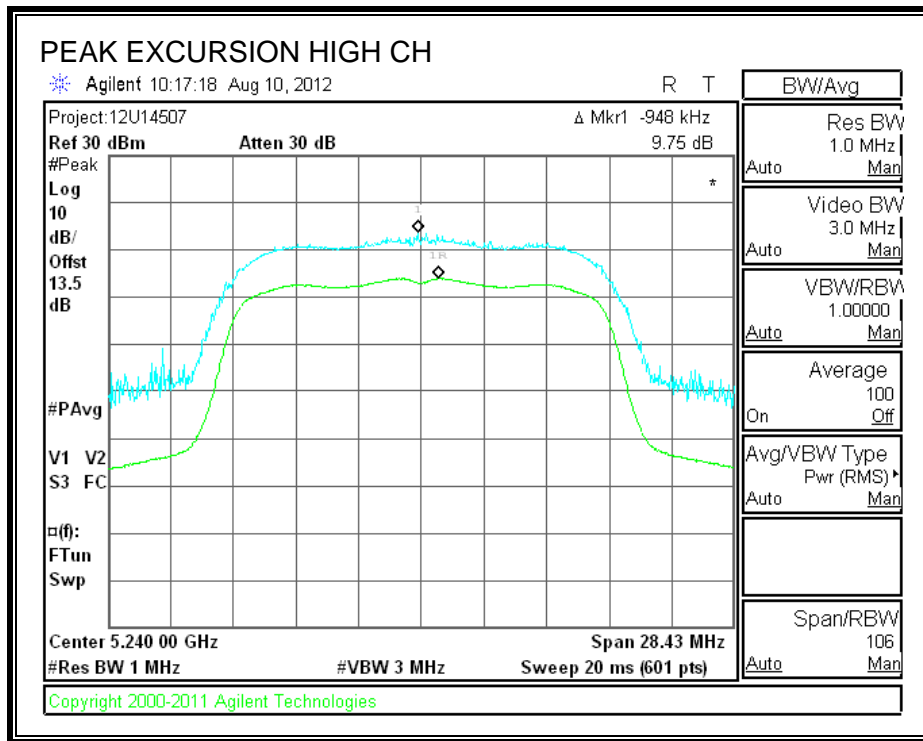



**8.2. 802.11n HT20 MODE IN THE 5.2 GHz BAND**

**8.2.1. 26 dB BANDWIDTH**

**LIMITS**

None; for reporting purposes only.

**RESULTS**

Channel	Frequency (MHz)	26 dB Bandwidth (MHz)
Low	5180	19.20
Mid	5200	19.15
High	5240	19.25

**26 dB BANDWIDTH**

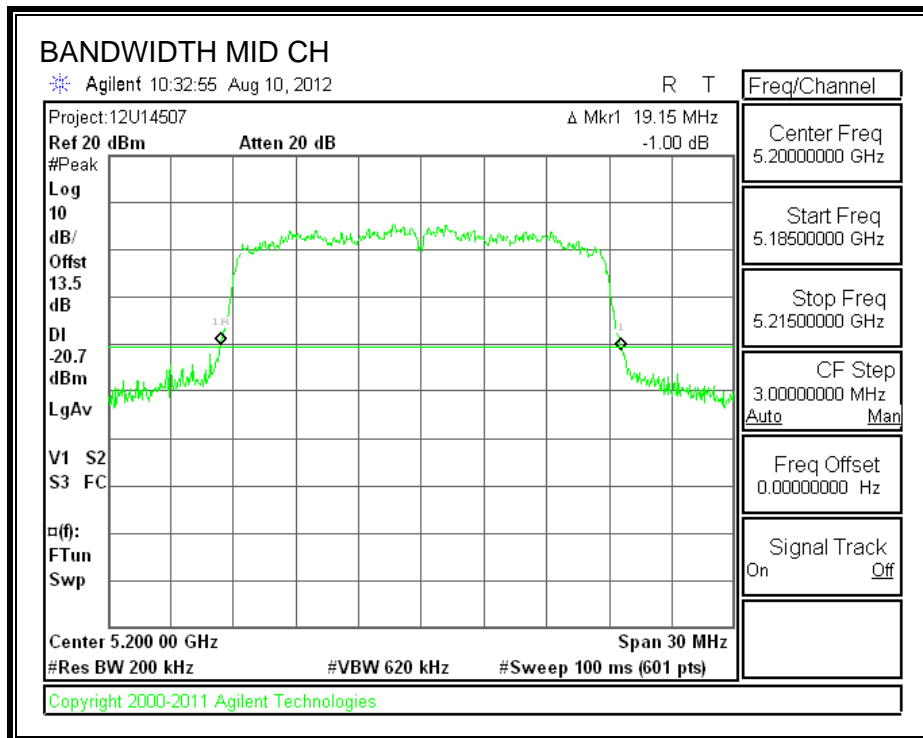
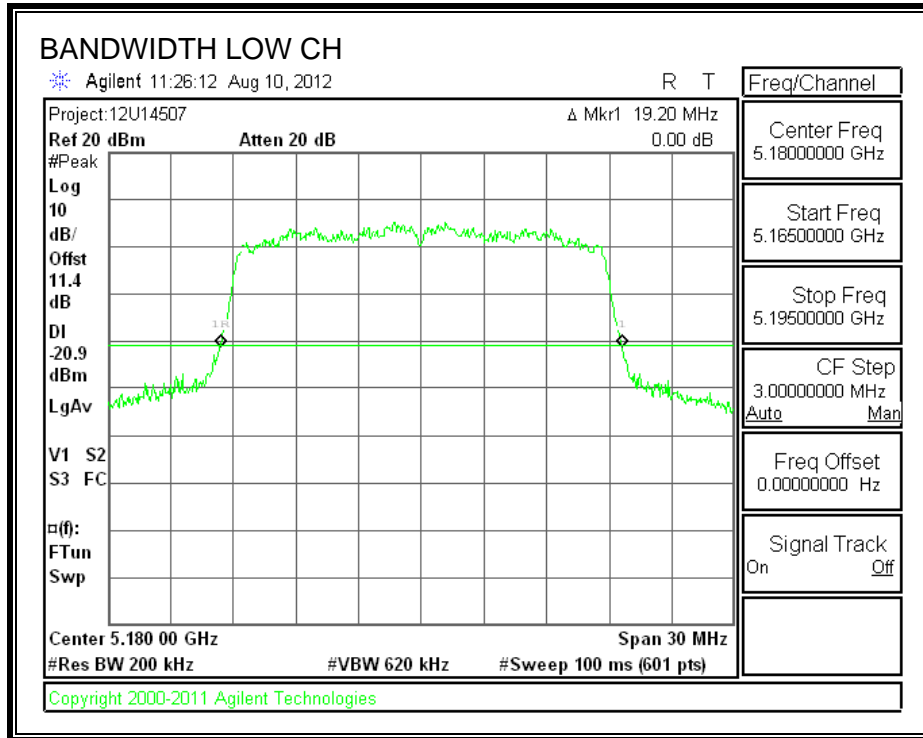

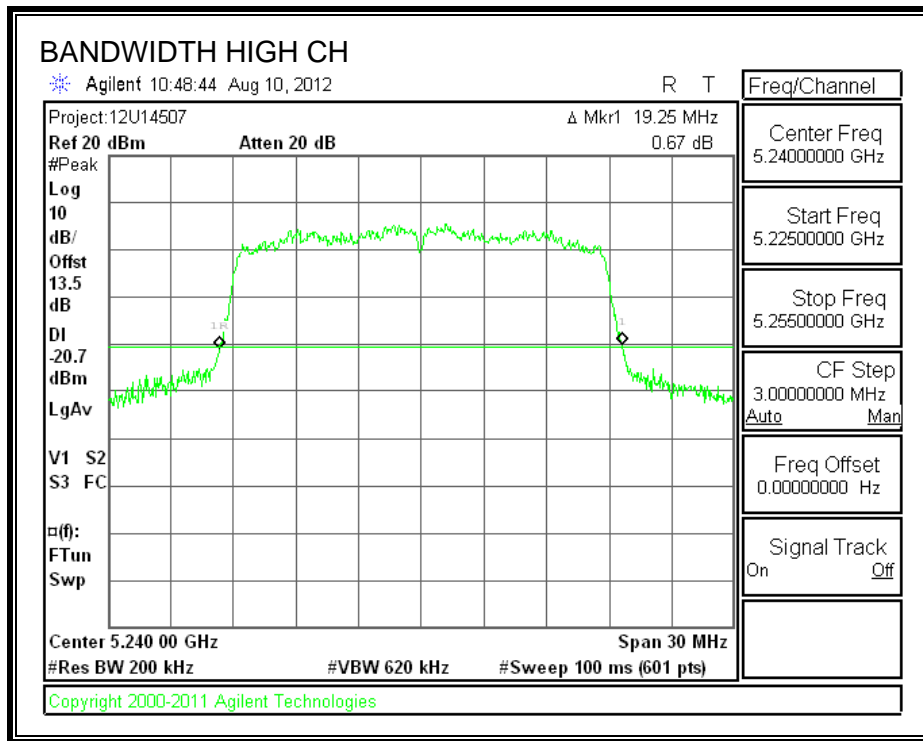

**8.2.2. 99% BANDWIDTH**

**LIMITS**

None; for reporting purposes only.

**RESULTS**

Channel	Frequency (MHz)	99% Bandwidth (MHz)
Low	5180	17.5332
Mid	5200	17.5315
High	5240	17.5264

**99% BANDWIDTH**

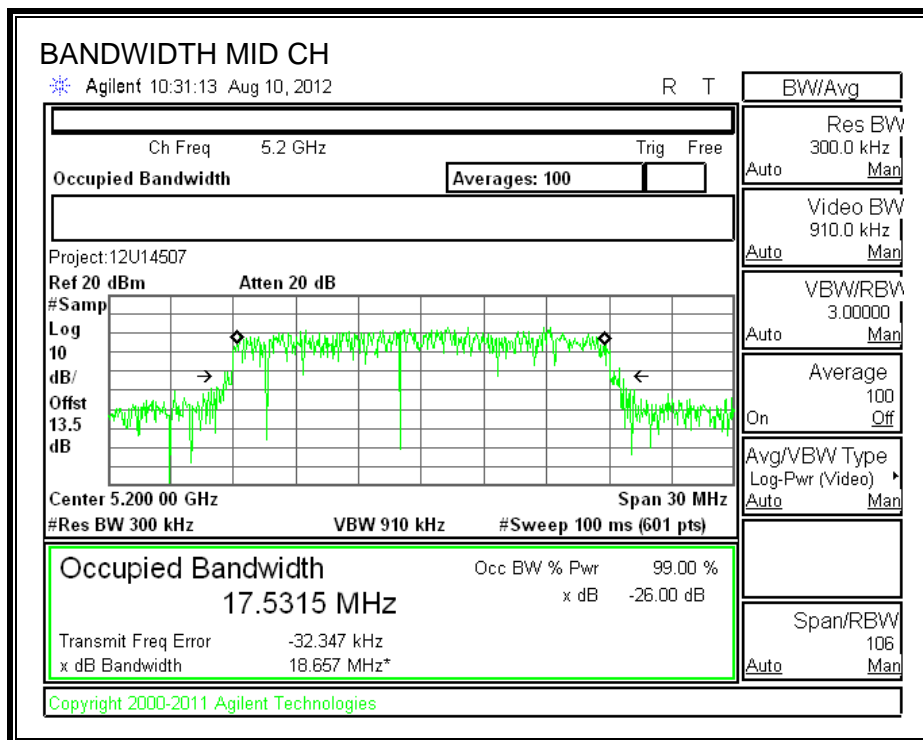
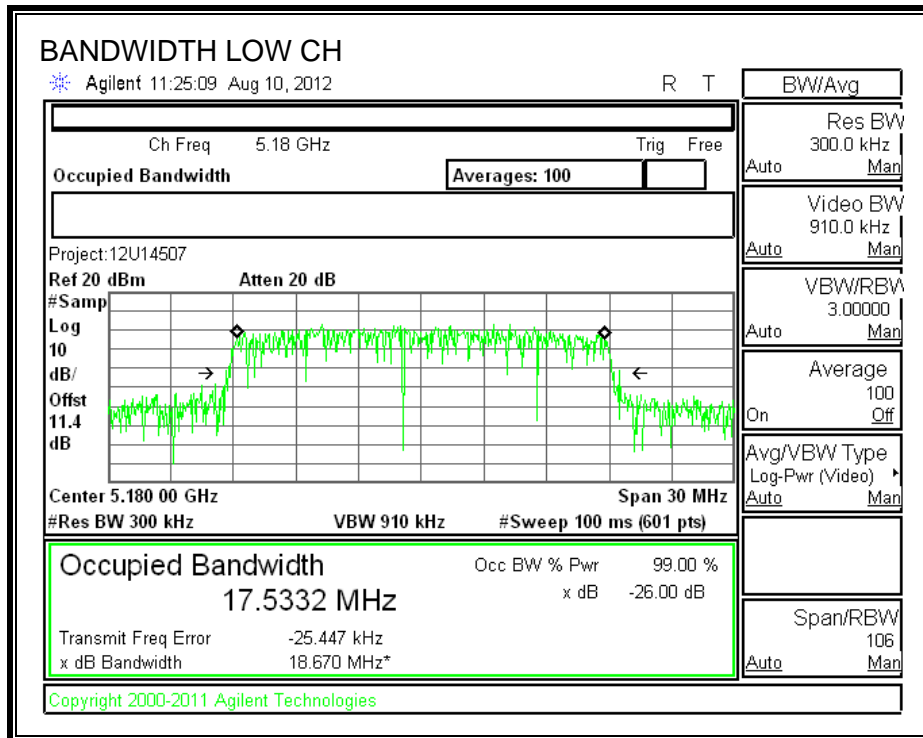

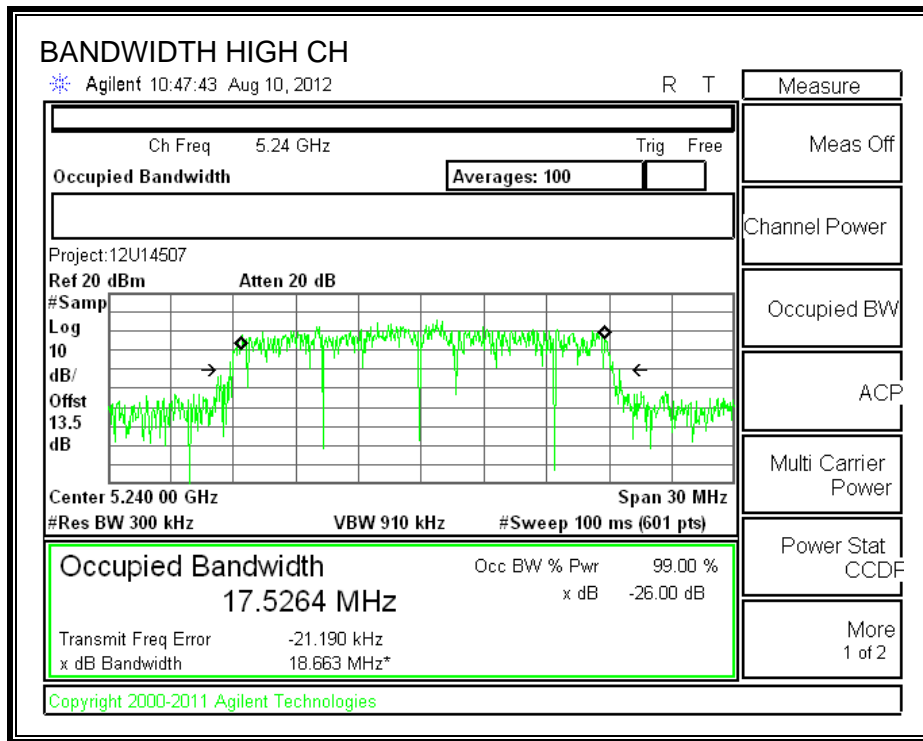

---

### 8.2.3. AVERAGE POWER

#### LIMITS

None; for reporting purposes only.

#### TEST PROCEDURE

The transmitter output is connected to a power meter.

The cable assembly insertion loss of 11.4 dB (including 10 dB pad and 1.4 dB cable) was entered as an offset in the power meter to allow for direct reading of power.

#### RESULTS

Channel	Frequency (MHz)	Power (dBm)
Low	5180	13.99
Mid	5200	14.00
High	5240	13.99

## **8.2.4. OUTPUT POWER AND PPSD**

### **LIMITS**

#### **FCC §15.407 (a) (1):**

For the band 5.15–5.25 GHz, the maximum conducted output power over the frequency band of operation shall not exceed the lesser of 50 mW or  $4 \text{ dBm} + 10 \log B$ , where B is the 26-dB emission bandwidth in MHz. In addition, the peak power spectral density shall not exceed 4 dBm in any 1-MHz band. If transmitting antennas of directional gain greater than 6 dBi are used, both the maximum conducted output power and the peak power spectral density shall be reduced by the amount in dB that the directional gain of the antenna exceeds 6 dBi.

#### **IC RSS-210 A9.2 (1):**

For the 5.15 – 5.25 GHz band, The maximum e.i.r.p. shall not exceed 200 mW or  $10 + 10 \log B$ , dBm, whichever power is less. B is the 99% emission bandwidth in MHz. The e.i.r.p. spectral density shall not exceed 10 dBm in any 1.0 MHz band.

### **DIRECTIONAL ANTENNA GAIN**

There is only one transmitter output therefore the directional gain is equal to the antenna gain.



**RESULTS**

**Limits FCC 15.407**

Channel	Frequency (MHz)	Fixed Limit (dBm)	B (MHz)	4 + 10 Log B Limit (dBm)	Directional Gain (dBi)	Power Limit (dBm)	PPSD Limit (dBm)
Low	5180	17	19.20	16.83	4.63	16.83	4.00
Mid	5200	17	19.15	16.82	4.63	16.82	4.00
High	5240	17	19.25	16.84	4.63	16.84	4.00

**Output Power Results**

Channel	Frequency (MHz)	Meas Power (dBm)	Corr'd Power (dBm)	Power Limit (dBm)	Power Margin (dB)
Low	5180	14.174	14.174	16.83	-2.659
Mid	5200	14.281	14.281	16.82	-2.541
High	5240	14.322	14.322	16.84	-2.522

**PPSD Results**

Channel	Frequency (MHz)	Meas PPSD (dBm)	Corr'd PPSD (dBm)	PPSD Limit (dBm)	PPSD Margin (dB)
Low	5180	3.56	3.56	4.00	-0.44
Mid	5200	3.65	3.65	4.00	-0.35
High	5240	3.72	3.72	4.00	-0.28

**IC RSS-210 A9.2(1)**

Channel	Frequency (MHz)	Fixed Limit (dBm)	B 99% (MHz)	4 + 10 Log B Limit (dBm)	Directional Gain (dBi)	Power Limit (dBm)	PPSD Limit (dBm)
Low	5180	23	17.5332	16.4386	4.63	16.4386	4.0000
Mid	5200	23	17.5315	16.4382	4.63	16.4382	4.0000
High	5240	23	17.5264	16.4369	4.63	16.4369	4.0000

**Output Power Results**

Channel	Frequency (MHz)	Meas Power (dBm)	Corr'd Power (dBm)	Power Limit (dBm)	Power Margin (dB)
Low	5180	14.174	14.174	16.44	-2.265
Mid	5200	14.281	14.281	16.44	-2.157
High	5240	14.322	14.322	16.44	-2.115

**PPSD Results**

Channel	Frequency (MHz)	Meas PPSD (dBm)	Corr'd PPSD (dBm)	PPSD Limit (dBm)	PPSD Margin (dB)
Low	5180	3.56	3.56	4.00	-0.44
Mid	5200	3.65	3.65	4.00	-0.35
High	5240	3.72	3.72	4.00	-0.28

**OUTPUT POWER AND PPSD**

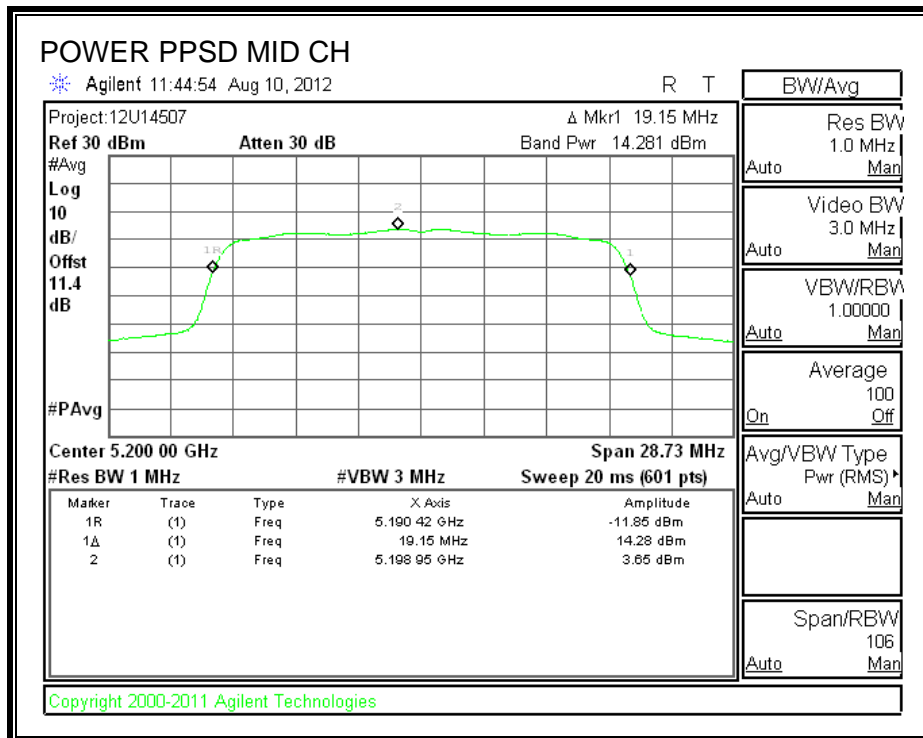
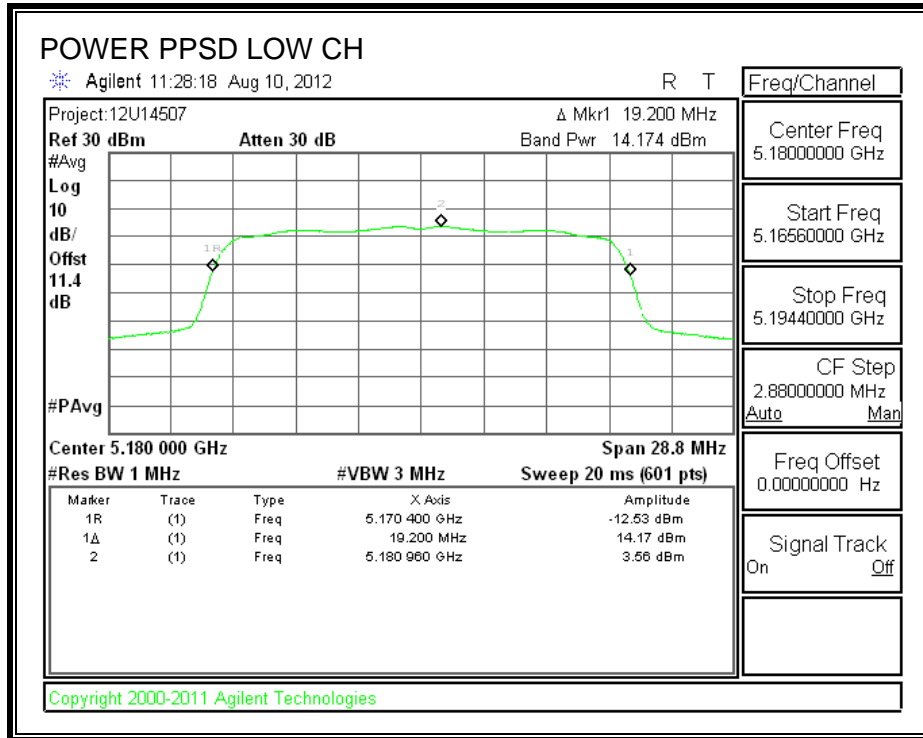

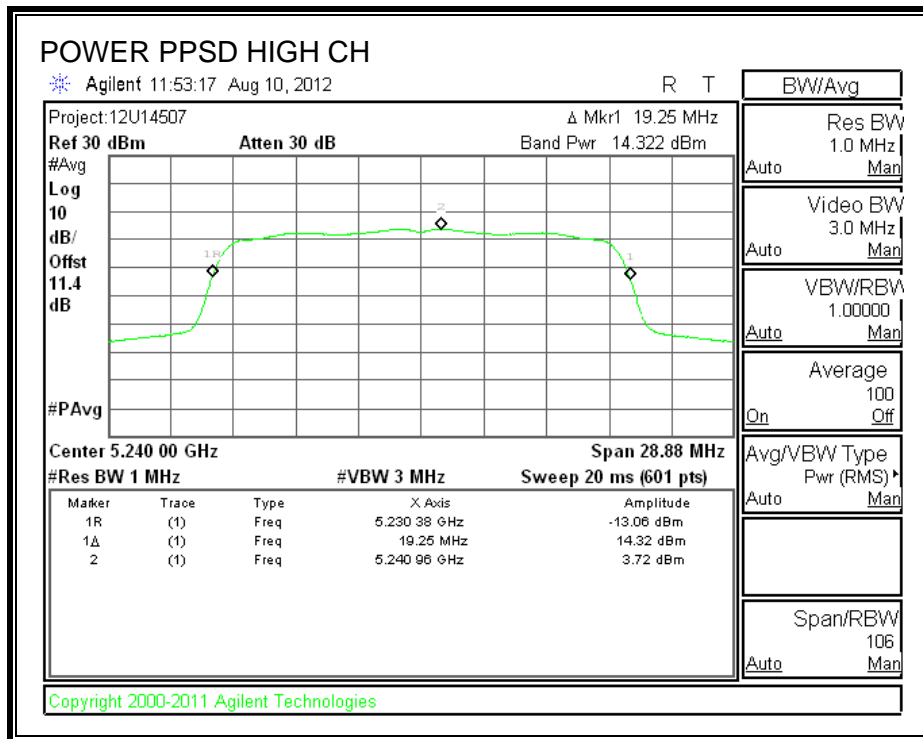

## 8.2.5. PEAK EXCURSION

### LIMITS

FCC §15.407 (a) (6)

The ratio of the peak excursion of the modulation envelope (measured using a peak hold function) to the peak transmit power (measured as specified above) shall not exceed 13 dB across any 1 MHz bandwidth or the emission bandwidth whichever is less.

### RESULTS

Channel	Frequency (MHz)	Peak Excursion (dB)	Limit (dB)	Margin (dB)
Low	5180	8.72	13	-4.28
Mid	5200	9.46	13	-3.54
High	5240	9.19	13	-3.81

**PEAK EXCURSION**

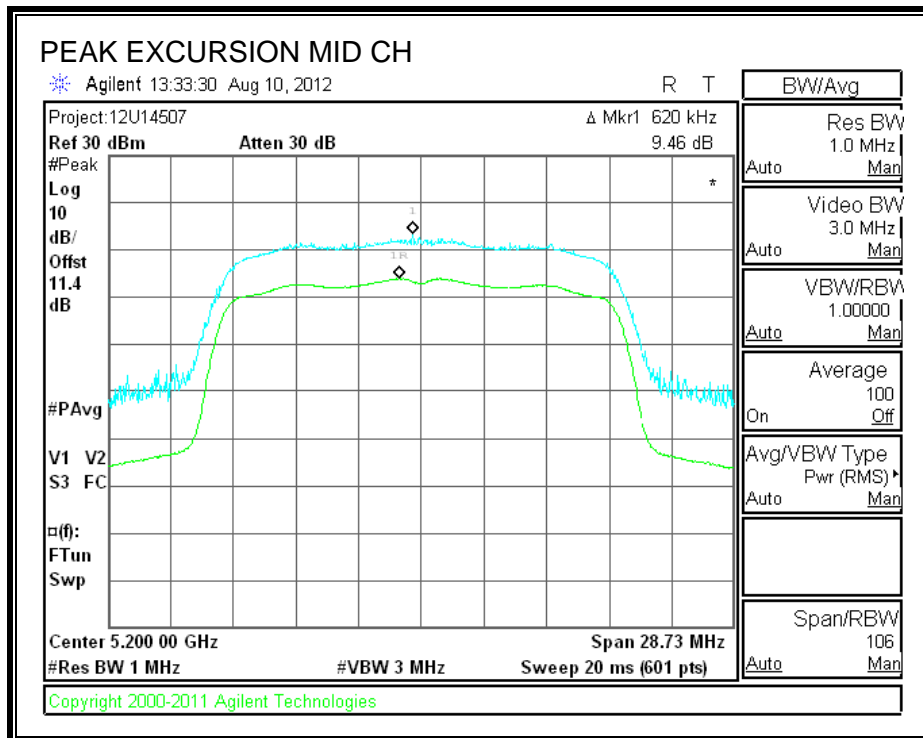
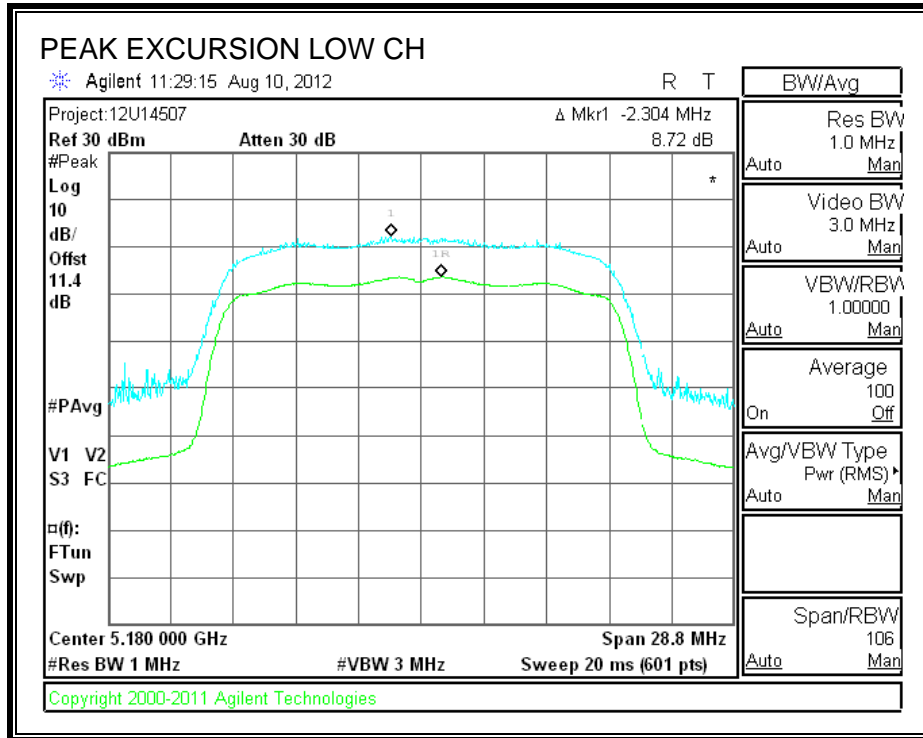

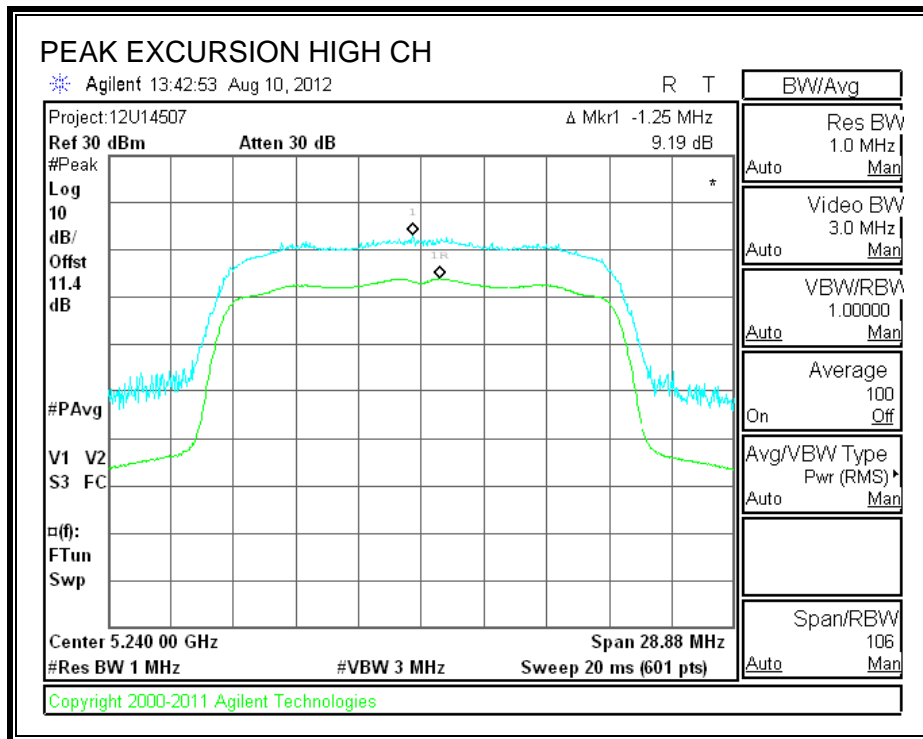

**8.3. 802.11n HT40 MODE IN THE 5.2 GHz BAND**

**8.3.1. 26 dB BANDWIDTH**

**LIMITS**

None; for reporting purposes only.

**RESULTS**

Channel	Frequency (MHz)	26 dB Bandwidth (MHz)
Low	5190	44.83
High	5230	45.42



**26 dB BANDWIDTH**

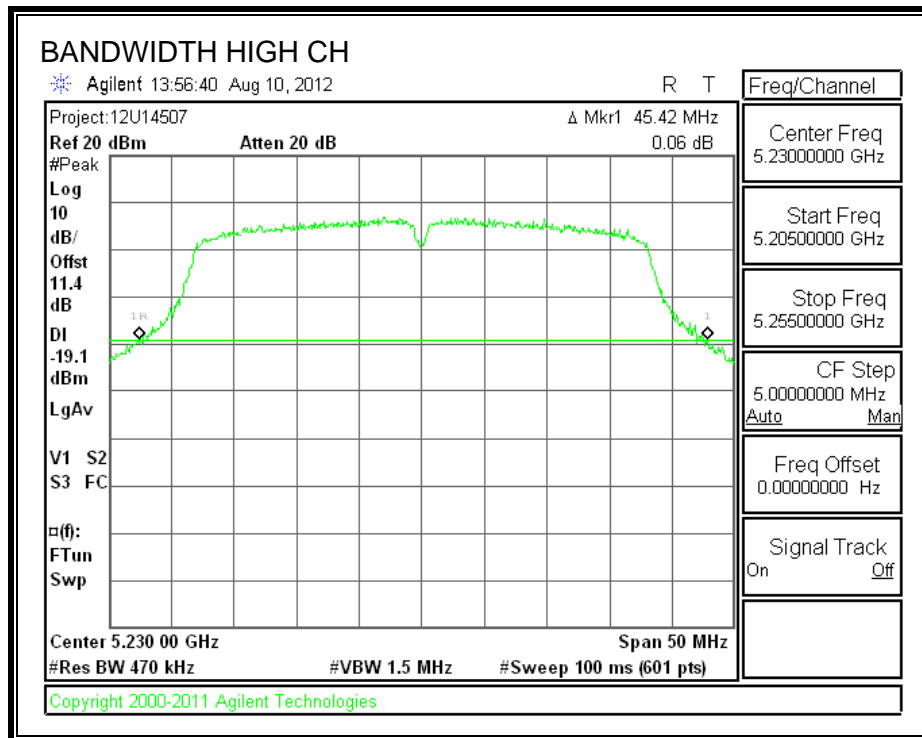
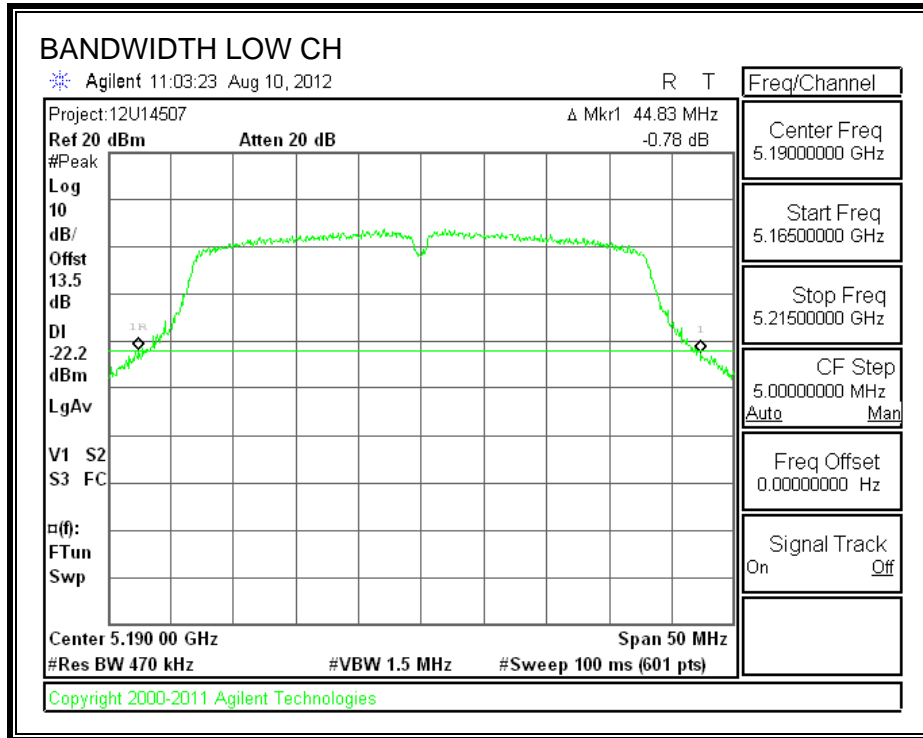

**8.3.2. 99% BANDWIDTH**

**LIMITS**

None; for reporting purposes only.

**RESULTS**

Channel	Frequency (MHz)	99% Bandwidth (MHz)
Low	5190	35.8147
High	5230	35.8179

**99% BANDWIDTH**

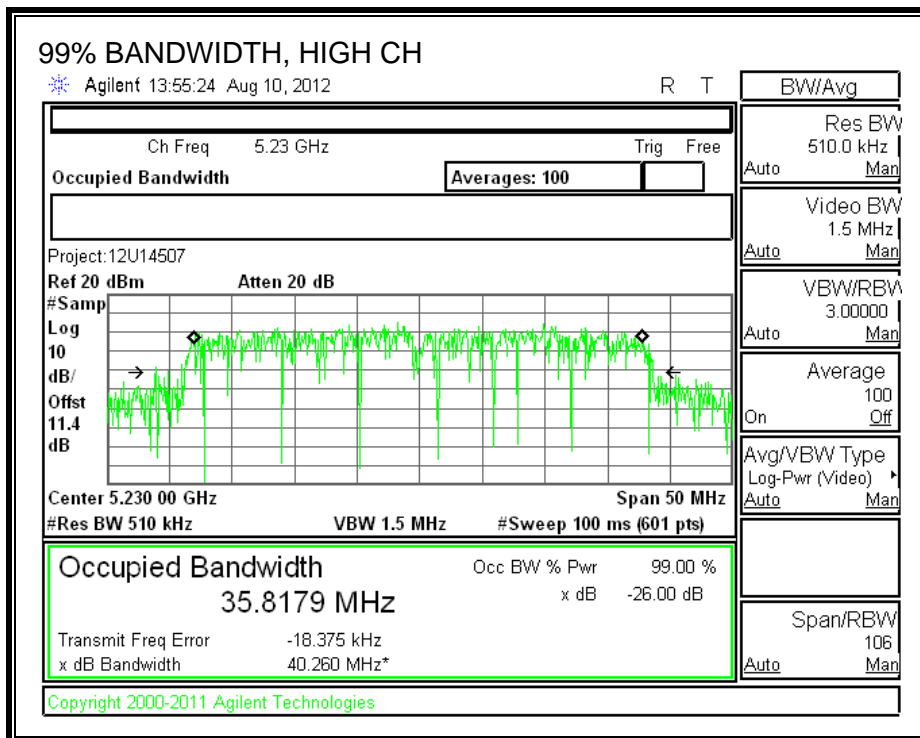
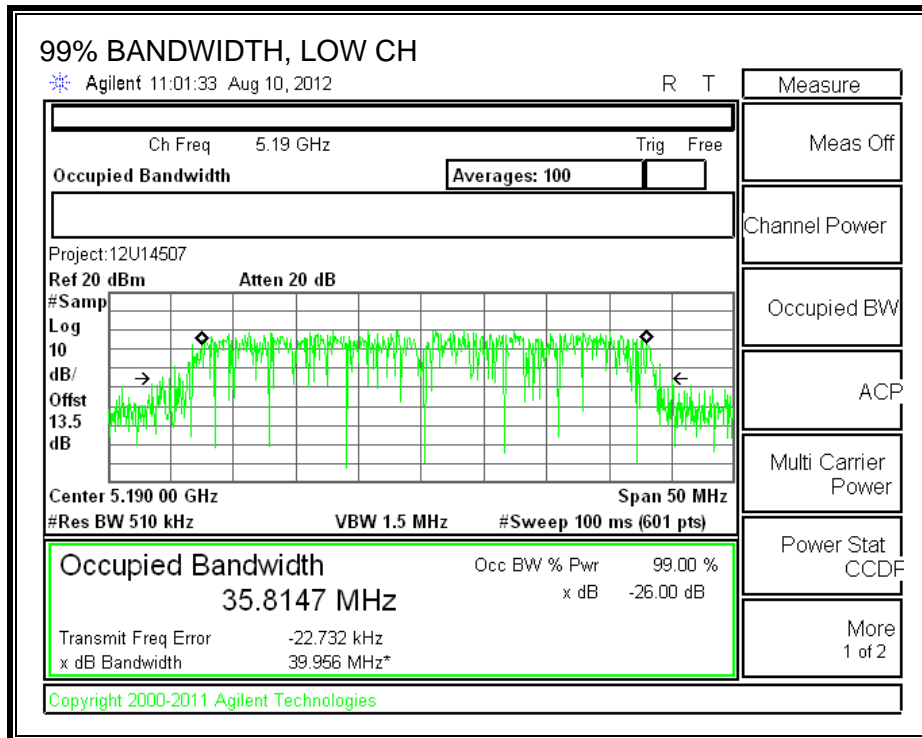

---

### 8.3.3. AVERAGE POWER

#### LIMITS

None; for reporting purposes only.

#### TEST PROCEDURE

The transmitter output is connected to a power meter.

The cable assembly insertion loss of 11.4 dB (including 10 dB pad and 1.4 dB cable) was entered as an offset in the power meter to allow for direct reading of power.

#### RESULTS

Channel	Frequency (MHz)	Power (dBm)
Low	5190	12.0
High	5230	15.5

### **8.3.4. OUTPUT POWER AND PPSD**

#### **LIMITS**

##### **FCC §15.407 (a) (1):**

For the band 5.15–5.25 GHz, the maximum conducted output power over the frequency band of operation shall not exceed the lesser of 50 mW or  $4 \text{ dBm} + 10 \log B$ , where B is the 26-dB emission bandwidth in MHz. In addition, the peak power spectral density shall not exceed 4 dBm in any 1-MHz band. If transmitting antennas of directional gain greater than 6 dBi are used, both the maximum conducted output power and the peak power spectral density shall be reduced by the amount in dB that the directional gain of the antenna exceeds 6 dBi.

##### **IC RSS-210 A9.2 (1):**

For the 5.15 – 5.25 GHz band, The maximum e.i.r.p. shall not exceed 200 mW or  $10 + 10 \log B$ , dBm, whichever power is less. B is the 99% emission bandwidth in MHz. The e.i.r.p. spectral density shall not exceed 10 dBm in any 1.0 MHz band.

#### **DIRECTIONAL ANTENNA GAIN**

There is only one transmitter output therefore the directional gain is equal to the antenna gain.

**RESULTS**

**Limits FCC 15.407**

Channel	Frequency (MHz)	Fixed Limit (dBm)	B (MHz)	4 + 10 Log B Limit (dBm)	Directional Gain (dBi)	Power Limit (dBm)	PPSD Limit (dBm)
Low	5190	17	44.83	20.52	4.63	17.00	4.00
High	5230	17	45.42	20.57	4.63	17.00	4.00

**Output Power Results**

Channel	Frequency (MHz)	Meas Power (dBm)	Corr'd Power (dBm)	Power Limit (dBm)	Power Margin (dB)
Low	5190	12.224	12.224	17.00	-4.776
High	5230	15.428	15.428	17.00	-1.572

**PPSD Results**

Channel	Frequency (MHz)	Meas PPSD (dBm)	Corr'd PPSD (dBm)	PPSD Limit (dBm)	PPSD Margin (dB)
Low	5190	-1.84	-1.84	4.00	-5.84
High	5230	1.38	1.38	4.00	-2.62

**IC RSS-210 A9.2(1)**

Channel	Frequency (MHz)	Fixed Limit (dBm)	B 99% (MHz)	4 + 10 Log B Limit (dBm)	Directional Gain (dBi)	Power Limit (dBm)	PPSD Limit (dBm)
Low	5190	23	35.8147	19.5406	4.63	19.5406	4.0000
High	5230	23	35.8179	19.5410	4.63	19.5410	4.0000

**Output Power Results**

Channel	Frequency (MHz)	Meas Power (dBm)	Corr'd Power (dBm)	Power Limit (dBm)	Power Margin (dB)
Low	5190	12.224	12.224	19.5406	-7.3166
High	5230	15.428	15.428	19.5410	-4.1130

**PPSD Results**

Channel	Frequency (MHz)	Meas PPSD (dBm)	Corr'd PPSD (dBm)	PPSD Limit (dBm)	PPSD Margin (dB)
Low	5190	-1.84	-1.84	4.0000	-5.84
High	5230	1.38	1.38	4.0000	-2.62

**OUTPUT POWER AND PPSD**

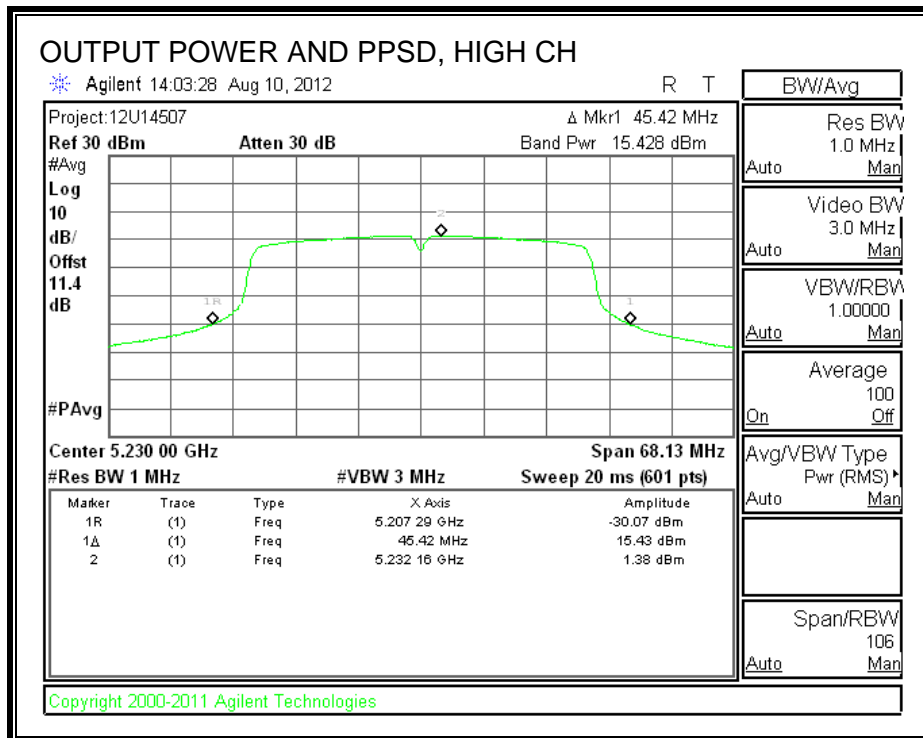
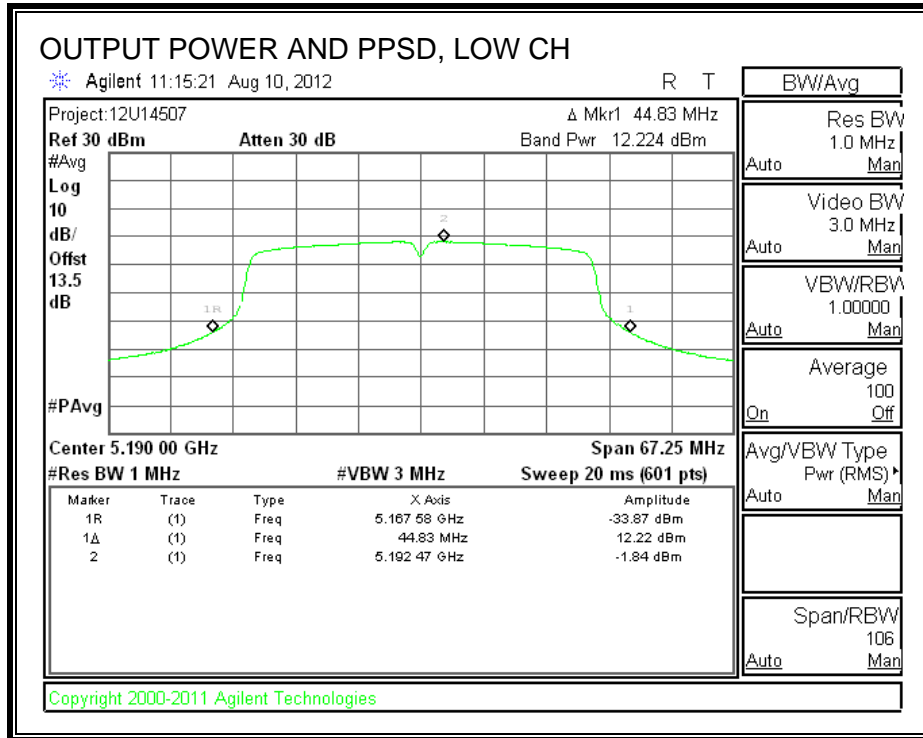



### 8.3.5. PEAK EXCURSION

#### LIMITS

FCC §15.407 (a) (6)

The ratio of the peak excursion of the modulation envelope (measured using a peak hold function) to the peak transmit power (measured as specified above) shall not exceed 13 dB across any 1 MHz bandwidth or the emission bandwidth whichever is less.

#### RESULTS

Channel	Frequency (MHz)	Peak Excursion (dB)	Limit (dB)	Margin (dB)
Low	5190	10.11	13	-2.89
High	5230	9.26	13	-3.74

**PEAK EXCURSION**

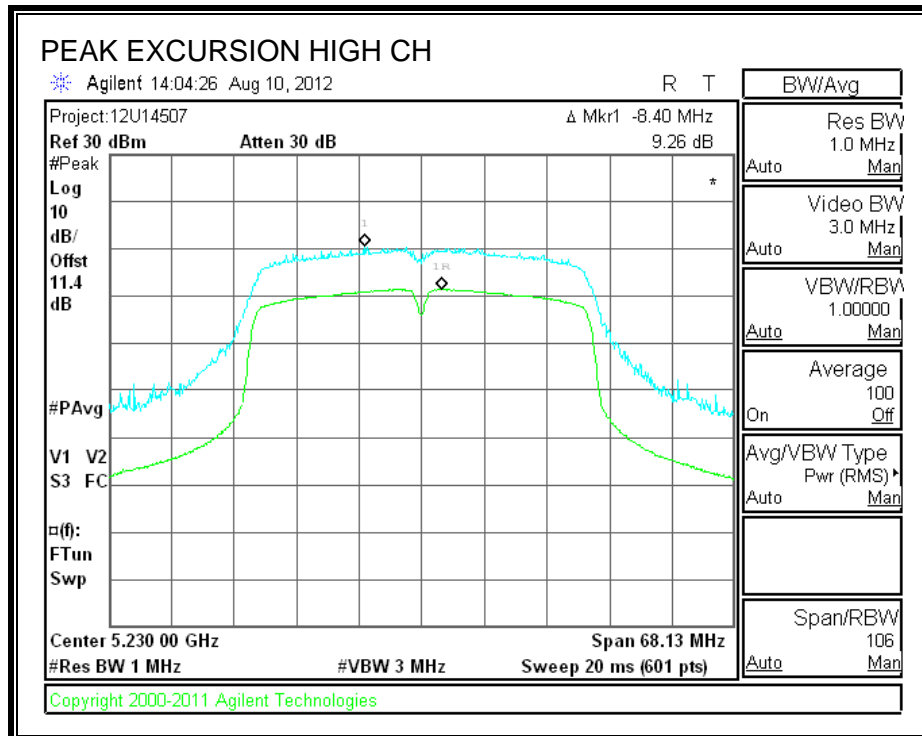
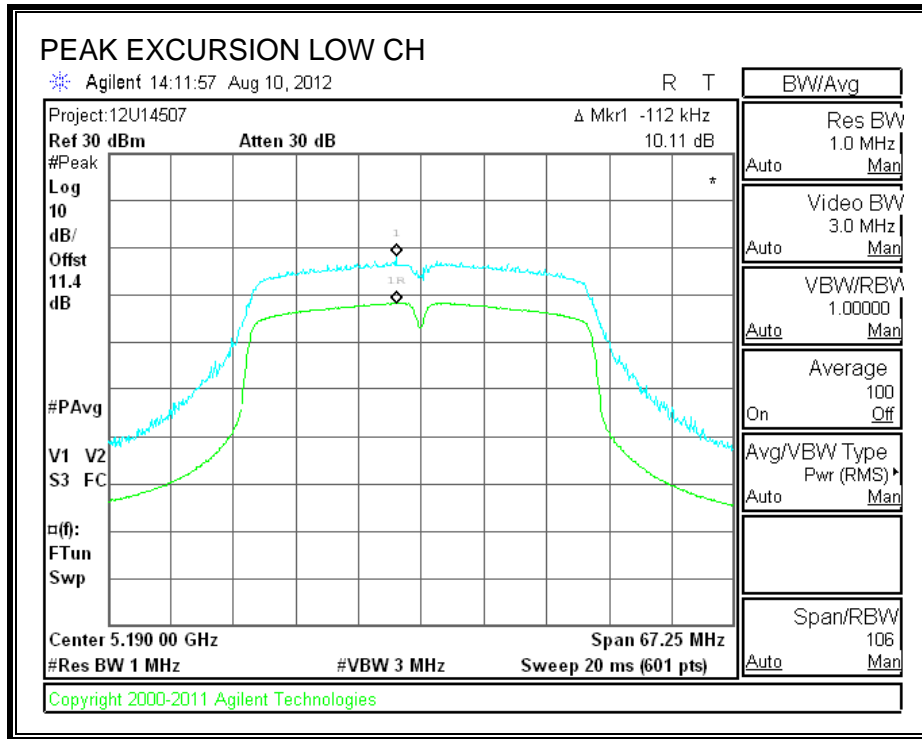

---

## **8.4. 802.11a MODE IN THE 5.3 GHz BAND**

### **8.4.1. 26 dB BANDWIDTH**

#### **LIMITS**

None; for reporting purposes only.

#### **RESULTS**

Channel	Frequency (MHz)	26 dB Bandwidth (MHz)
Low	5260	20.75
Mid	5300	20.95
High	5320	19.25

**26 dB BANDWIDTH**

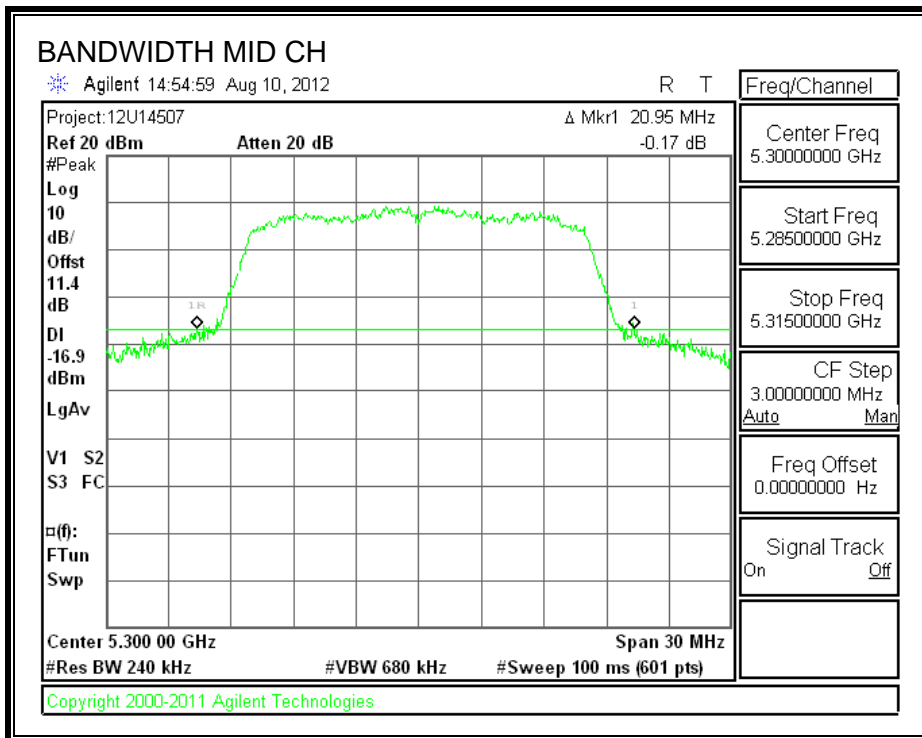
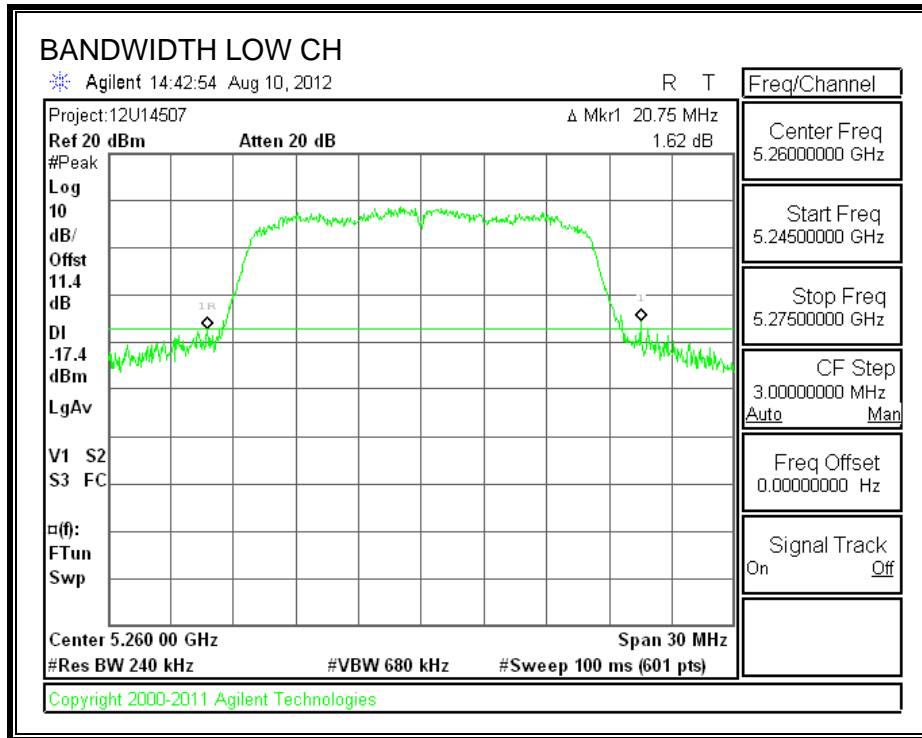

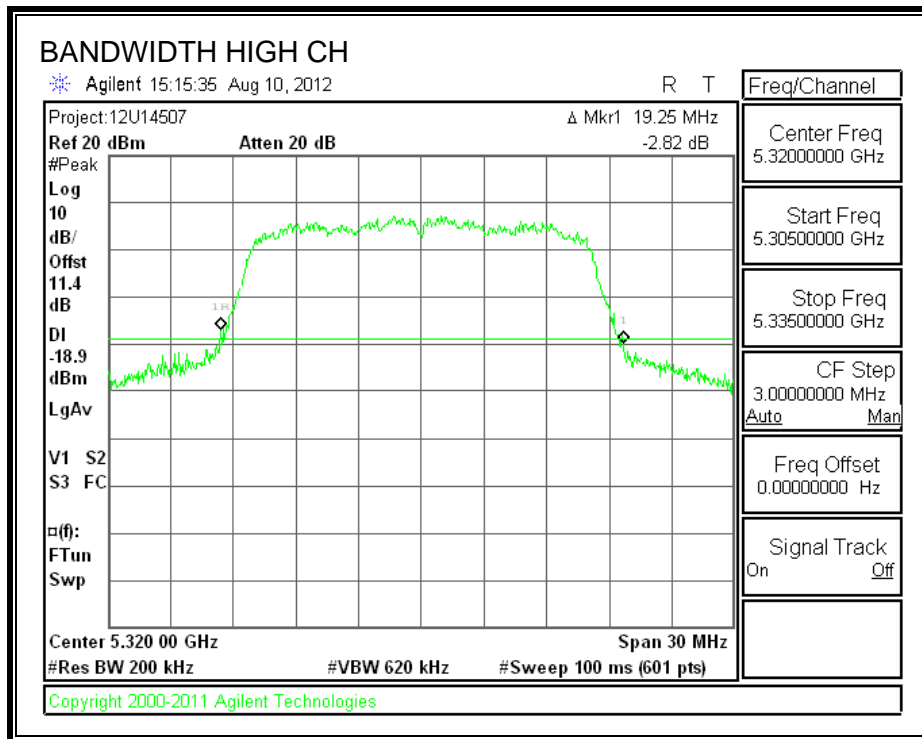

**8.4.2. 99% BANDWIDTH**

**LIMITS**

None; for reporting purposes only.

**RESULTS**

Channel	Frequency (MHz)	99% Bandwidth (MHz)
Low	5260	16.3495
Mid	5300	16.3502
High	5320	16.3483

**99% BANDWIDTH**

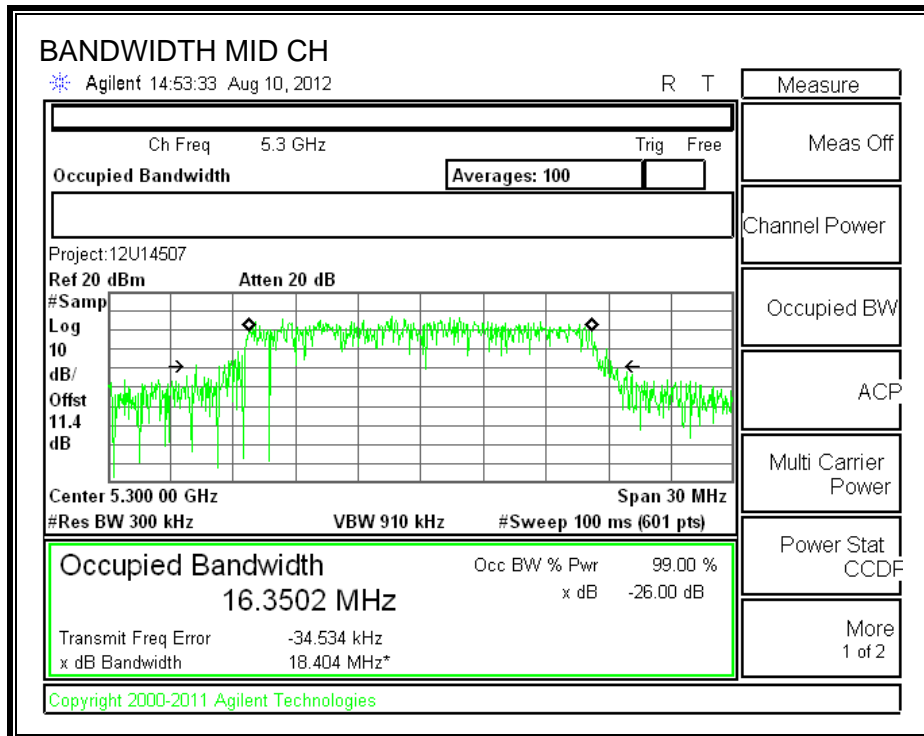
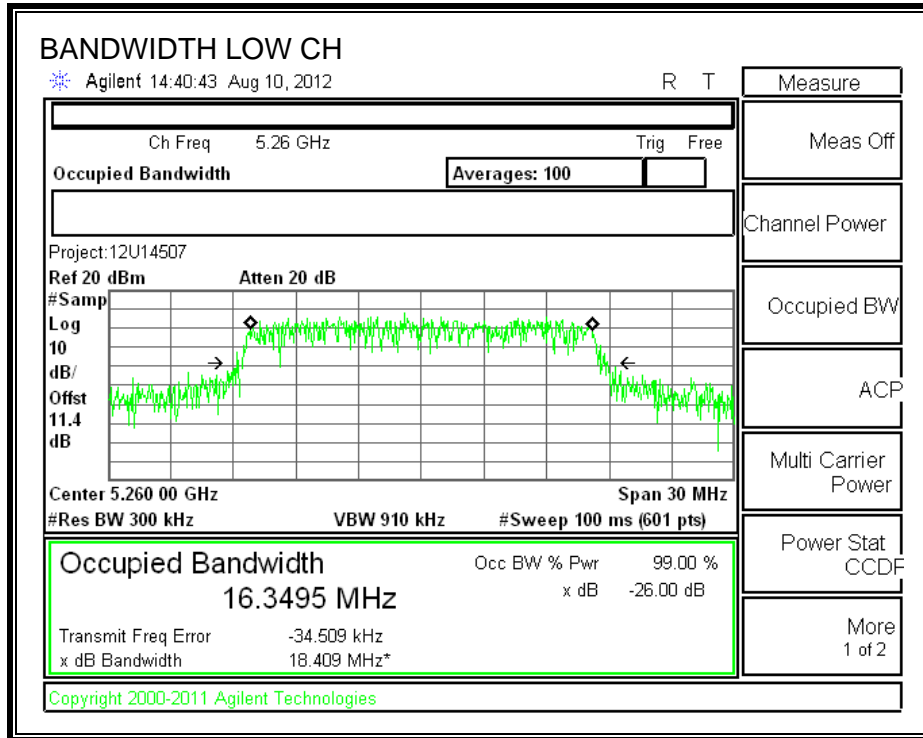

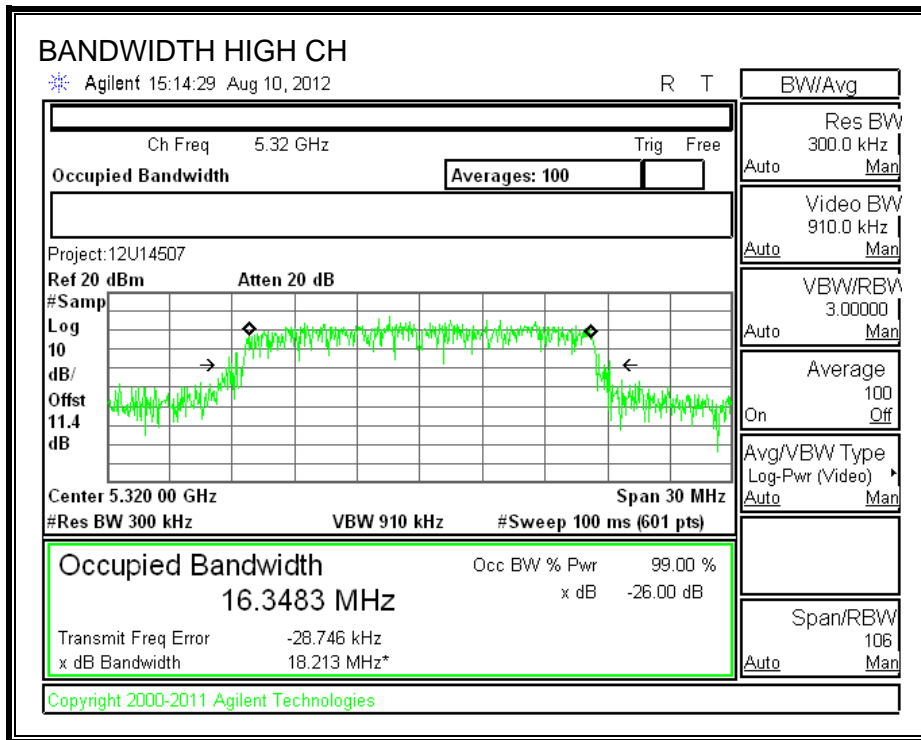



### **8.4.3. AVERAGE POWER**

#### **LIMITS**

None; for reporting purposes only.

#### **TEST PROCEDURE**

The transmitter output is connected to a power meter.

The cable assembly insertion loss of 11.4 dB (including 10 dB pad and 1.4 dB cable) was entered as an offset in the power meter to allow for direct reading of power.

#### **RESULTS**

Channel	Frequency (MHz)	Power (dBm)
Low	5260	17.5
Mid	5300	17.5
High	5320	16.0

---

#### **8.4.4. OUTPUT POWER AND PPSD**

##### **LIMITS**

FCC §15.407 (a) (2)

IC RSS-210 A9.2 (2)

For the 5.25–5.35 GHz and 5.47–5.725 GHz bands, the maximum conducted output power over the frequency bands of operation shall not exceed the lesser of 250 mW or  $11 \text{ dBm} + 10 \log B$ , where B is the 26 dB emission bandwidth in megahertz. In addition, the peak power spectral density shall not exceed 11 dBm in any 1 megahertz band. If transmitting antennas of directional gain greater than 6 dBi are used, both the maximum conducted output power and the peak power spectral density shall be reduced by the amount in dB that the directional gain of the antenna exceeds 6 dBi.

##### **DIRECTIONAL ANTENNA GAIN**

There is only one transmitter output therefore the directional gain is equal to the antenna gain.

**RESULTS**

**Limits FCC 15.407**

Channel	Frequency (MHz)	Fixed Limit (dBm)	B (MHz)	11 + 10 Log B Limit (dBm)	Directional Gain (dBi)	Power Limit (dBm)	PPSD Limit (dBm)
Low	5260	24	20.75	24.17	4.25	24.00	11.00
Mid	5300	24	20.95	24.21	4.25	24.00	11.00
High	5320	24	19.25	23.84	4.25	23.84	11.00

**Output Power Results**

Channel	Frequency (MHz)	Meas Power (dBm)	Corr'd Power (dBm)	Power Limit (dBm)	Power Margin (dB)
Low	5260	17.538	17.538	24.00	-6.462
Mid	5300	17.733	17.733	24.00	-6.267
High	5320	17.983	17.983	23.84	-5.861

**PPSD Results**

Channel	Frequency (MHz)	Meas PPSD (dBm)	Corr'd PPSD (dBm)	PPSD Limit (dBm)	PPSD Margin (dB)
Low	5260	7.10	7.10	11.00	-3.90
Mid	5300	7.30	7.30	11.00	-3.70
High	5320	7.54	7.54	11.00	-3.46

**IC RSS-210 A9.2 (1)**

Channel	Frequency (MHz)	Fixed Limit (dBm)	B 99% (MHz)	11 + 10 Log B Limit (dBm)	Directional Gain (dBi)	Power Limit (dBm)	PPSD Limit (dBm)
Low	5260	24	16.3495	23.1350	4.25	23.1350	11.0000
Mid	5300	24	16.3502	23.1352	4.25	23.1352	11.0000
High	5320	24	16.3483	23.1347	4.25	23.1347	11.0000

**Output Power Results**

Channel	Frequency (MHz)	Meas Power (dBm)	Corr'd Power (dBm)	Power Limit (dBm)	Power Margin (dB)
Low	5260	17.538	17.538	23.1350	-5.5970
Mid	5300	17.733	17.733	23.1352	-5.4022
High	5320	17.983	17.983	23.1347	-5.1517

**PPSD Results**

Channel	Frequency (MHz)	Meas PPSD (dBm)	Corr'd PPSD (dBm)	PPSD Limit (dBm)	PPSD Margin (dB)
Low	5260	7.10	7.10	11.0000	-3.9000
Mid	5300	7.30	7.30	11.0000	-3.7000
High	5320	7.54	7.54	11.0000	-3.4600

**OUTPUT POWER AND PPSD**

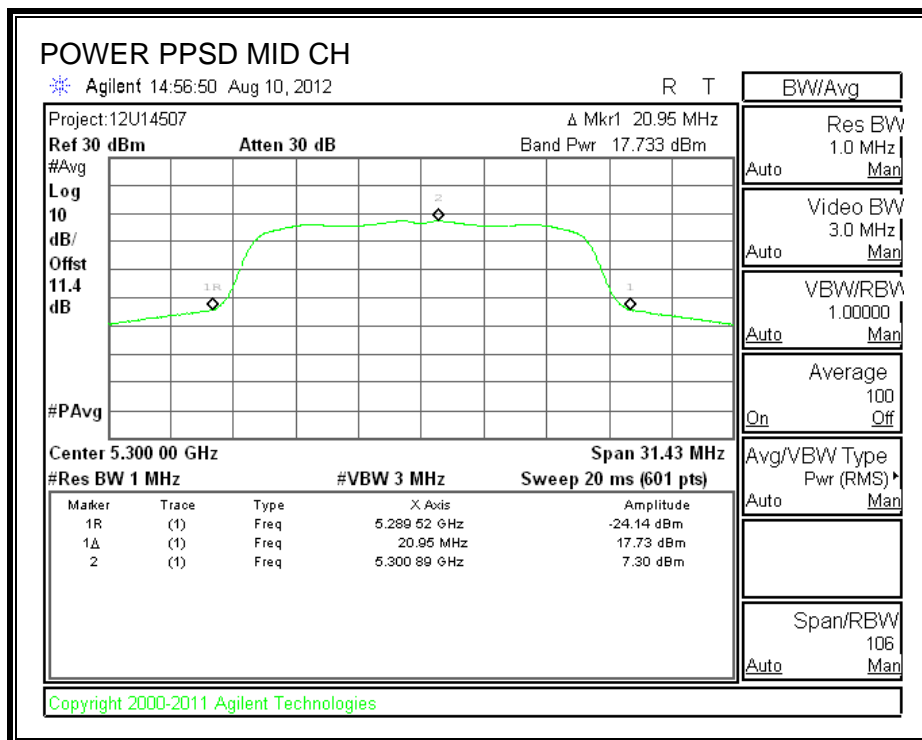
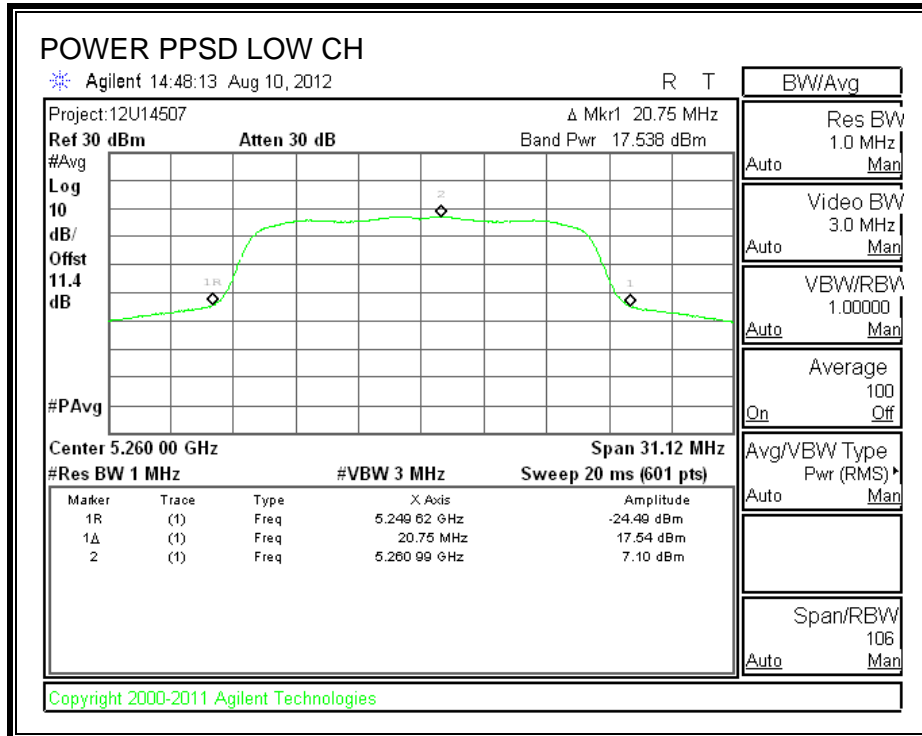

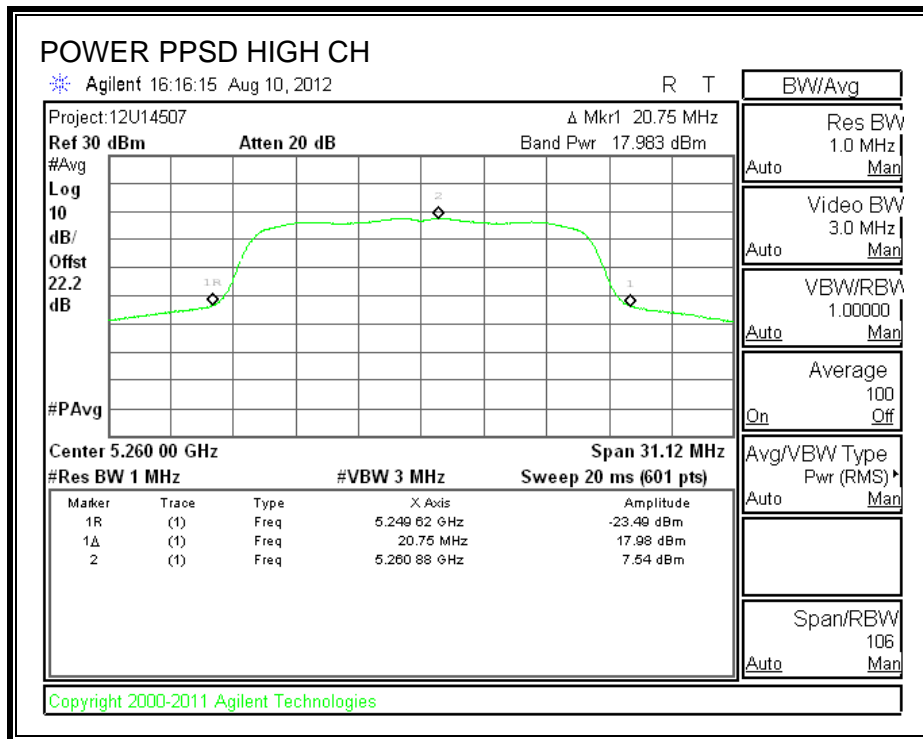

### 8.4.5. PEAK EXCURSION

#### LIMITS

FCC §15.407 (a) (6)

The ratio of the peak excursion of the modulation envelope (measured using a peak hold function) to the peak transmit power (measured as specified above) shall not exceed 13 dB across any 1 MHz bandwidth or the emission bandwidth whichever is less.

#### RESULTS

Channel	Frequency (MHz)	Peak Excursion (dB)	Limit (dB)	Margin (dB)
Low	5260	9.60	13	-3.40
Mid	5300	9.09	13	-3.91
High	5320	9.82	13	-3.18

**PEAK EXCURSION**

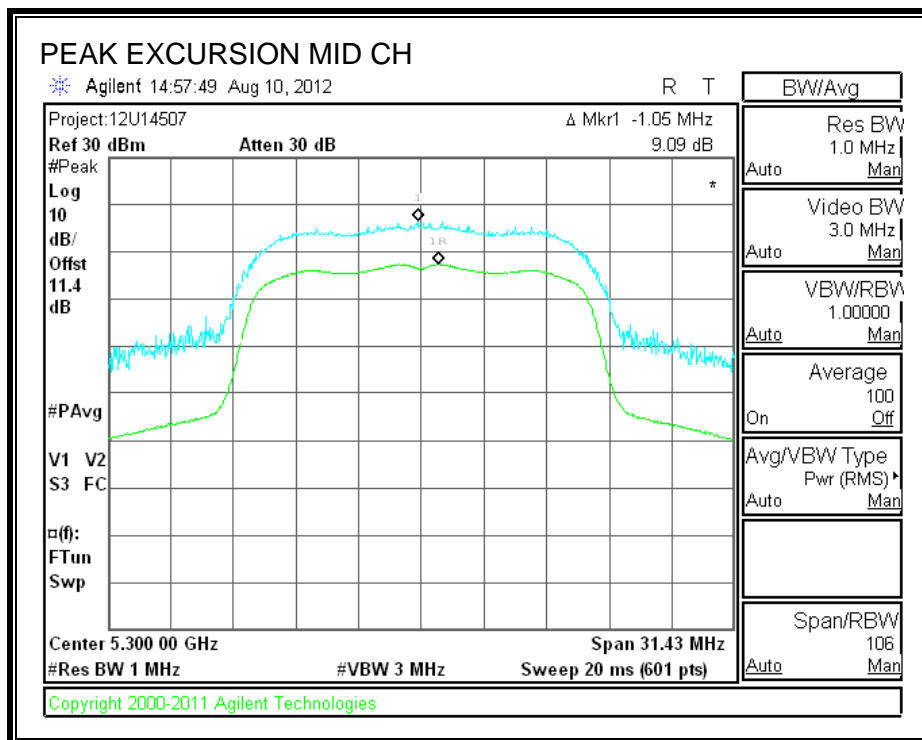
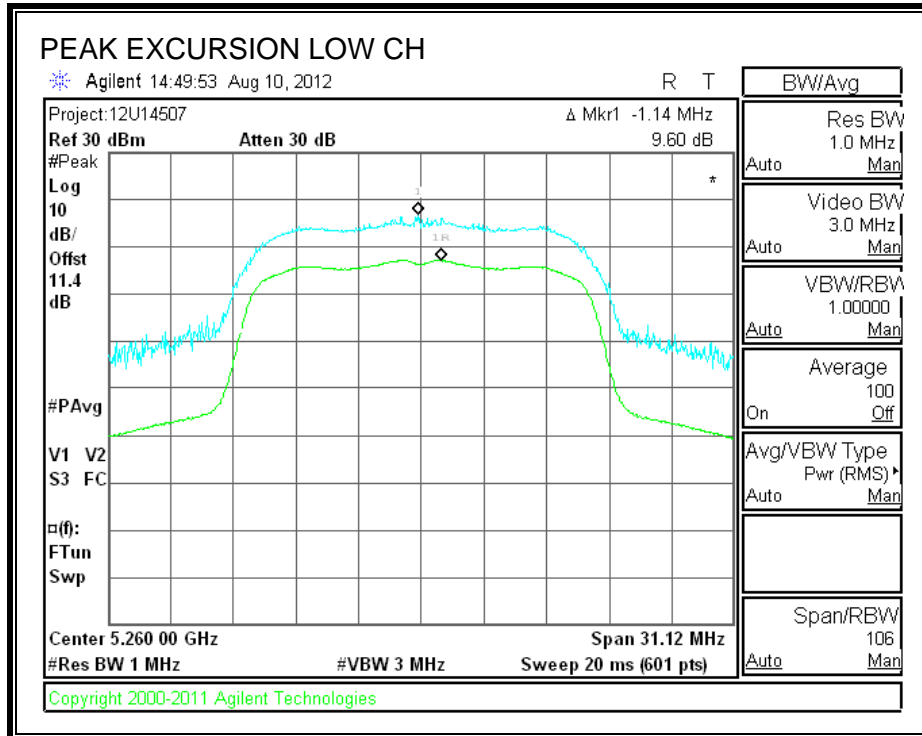



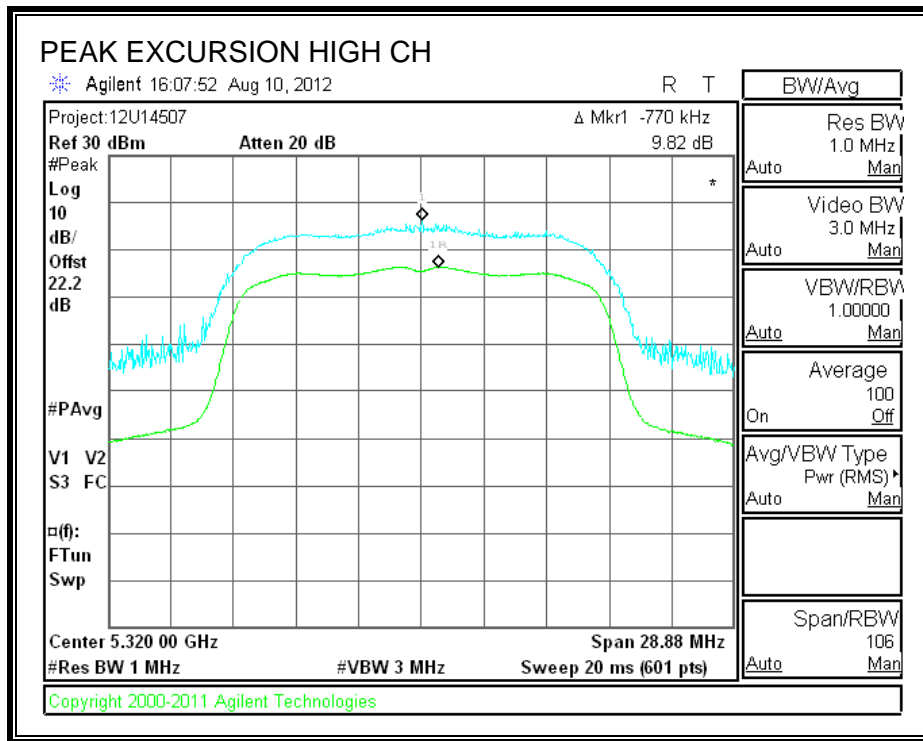

### **8.4.6. TPC POWER**

#### **LIMITS**

FCC §15.407 (h) (1)

IC RSS-210 A9.2 (2)

Transmit power control (TPC). U-NII devices operating in the 5.25–5.35 GHz band and the 5.47–5.725 GHz band shall employ a TPC mechanism. The U-NII device is required to have the capability to operate at least 6 dB below the mean EIRP value of 30 dBm. A TPC mechanism is not required for systems with an e.i.r.p. of less than 500 mW.

#### **DIRECTIONAL ANTENNA GAIN**

There is only one transmitter output therefore the directional gain is equal to the antenna gain.

#### **RESULTS**

EIRP = 18.043 dBm + 4.25 dBi = **22.293 dBm**, which is less than the threshold of 500 mW (27 dBm); therefore, TPC is not required.

**8.5. 802.11n HT20 MODE IN THE 5.3 GHz BAND**

**8.5.1. 26 dB BANDWIDTH**

**LIMITS**

None; for reporting purposes only.

**RESULTS**

Channel	Frequency (MHz)	26 dB Bandwidth (MHz)
Low	5260	23.70
Mid	5300	22.40
High	5320	19.95

**26 dB BANDWIDTH**

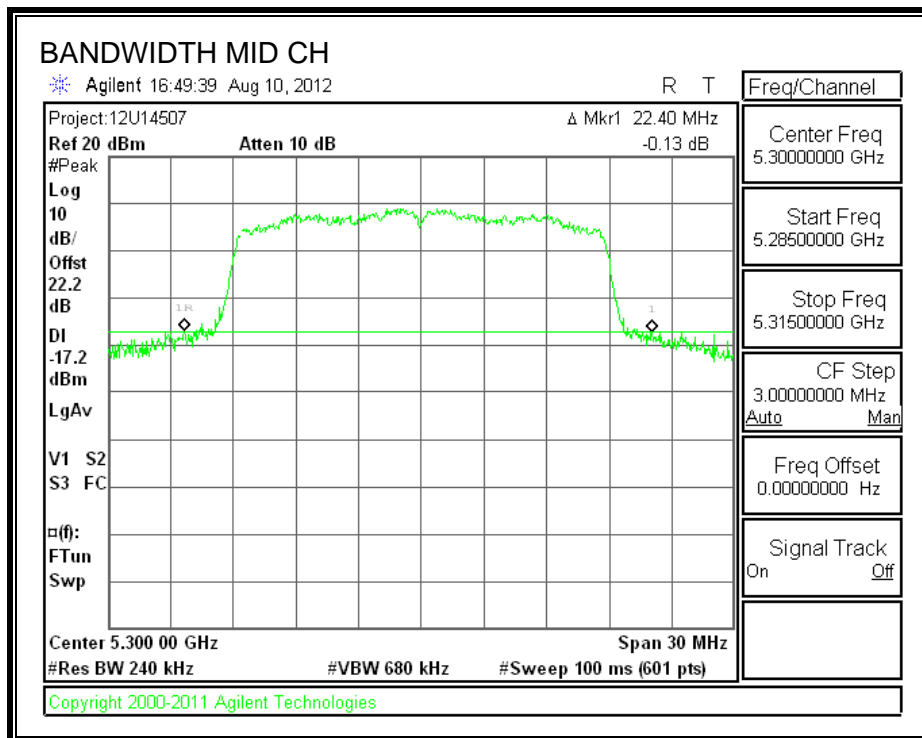
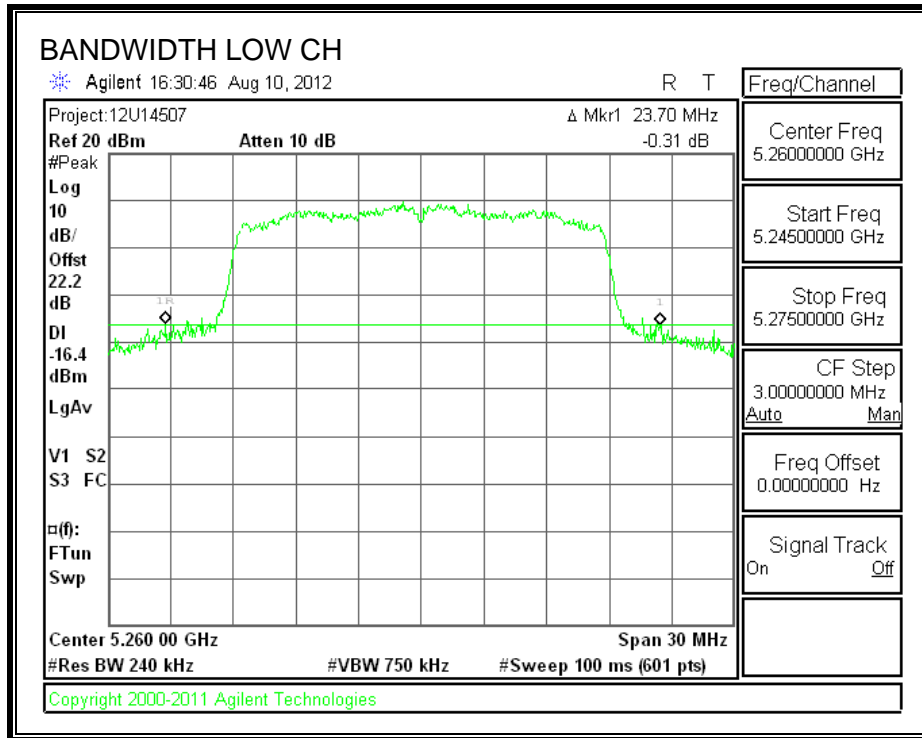

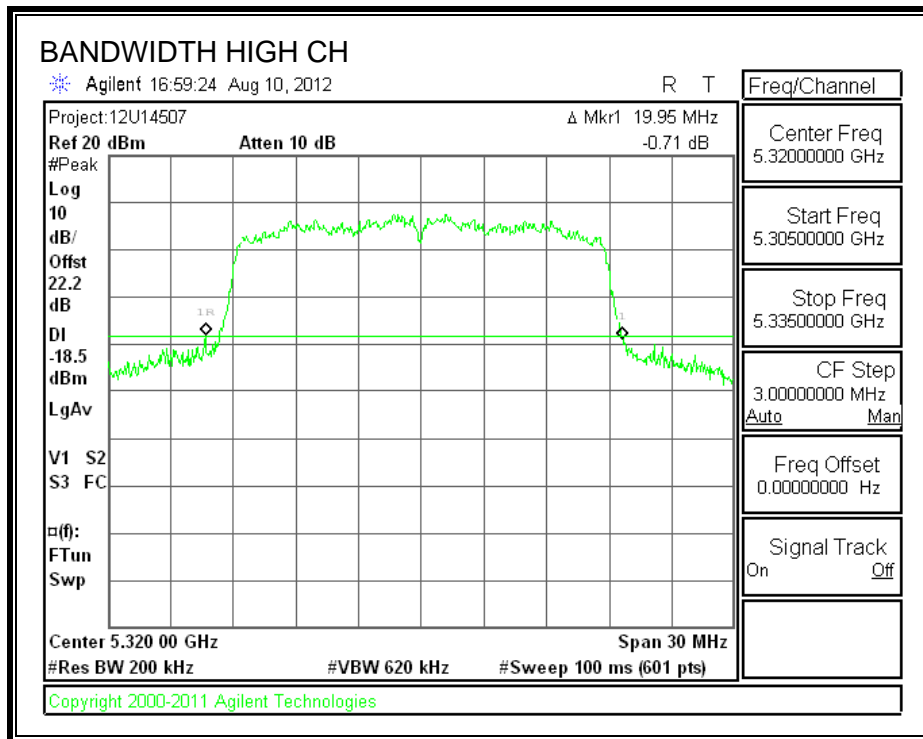

**8.5.2. 99% BANDWIDTH**

**LIMITS**

None; for reporting purposes only.

**RESULTS**

Channel	Frequency (MHz)	99% Bandwidth (MHz)
Low	5260	17.5359
Mid	5300	17.5444
High	5320	17.5384

**99% BANDWIDTH**

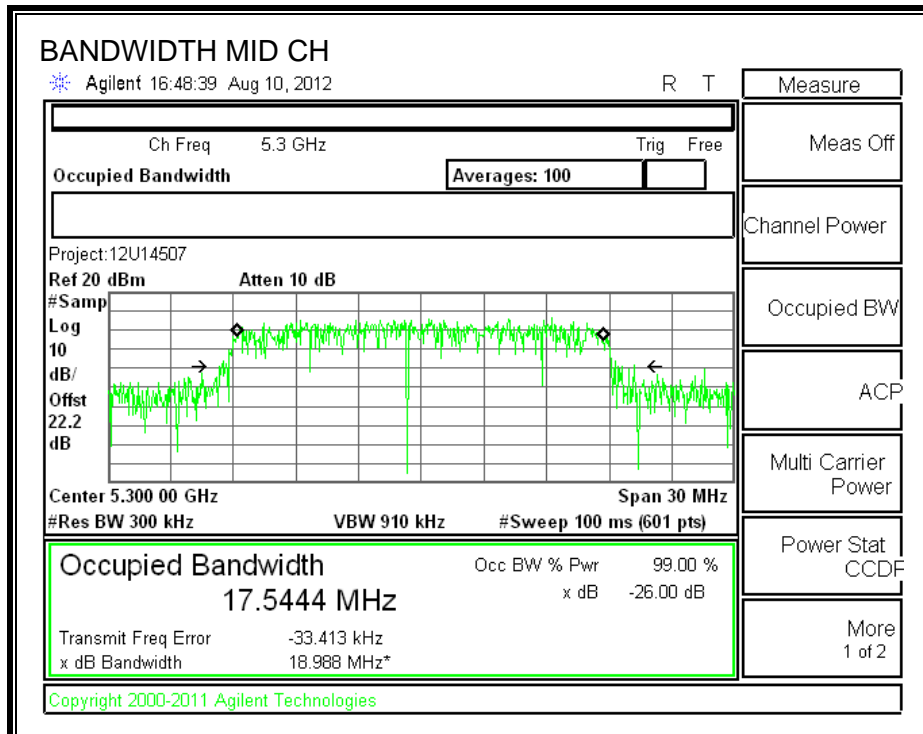
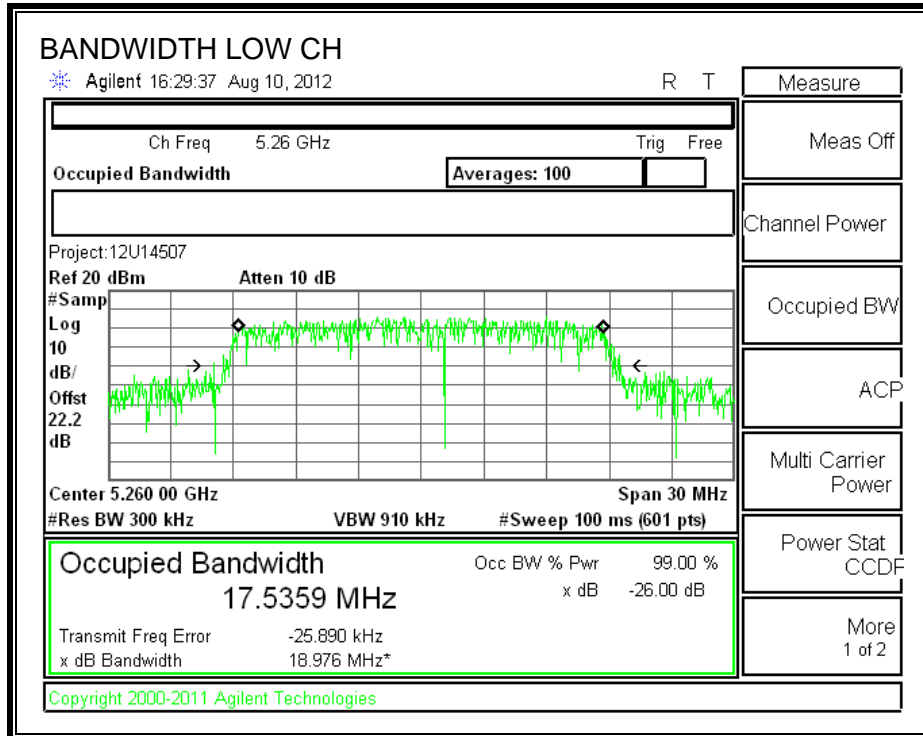

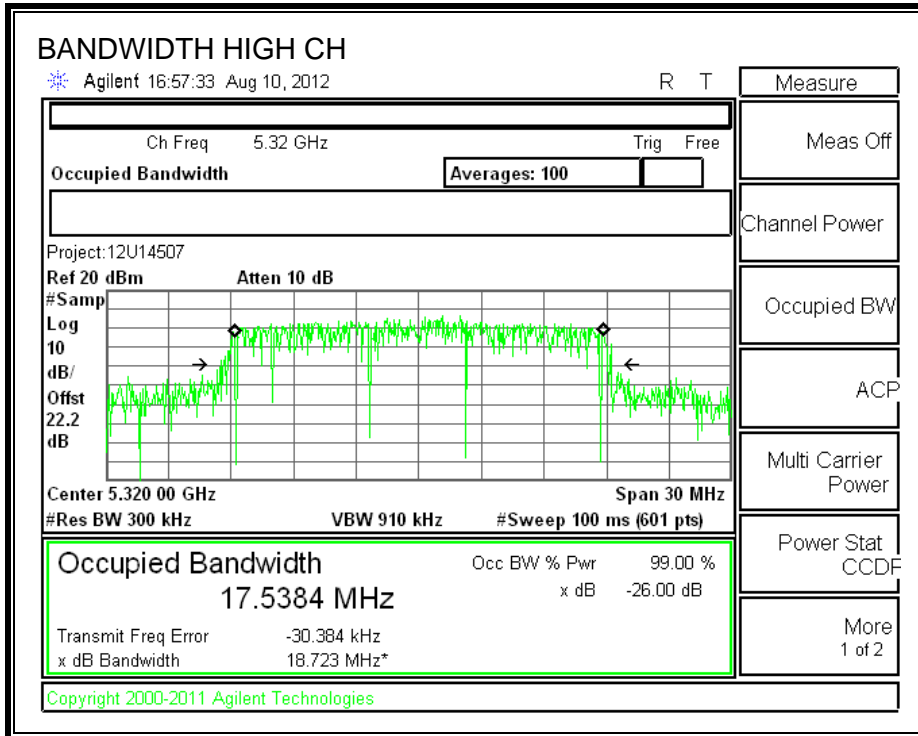



### **8.5.3. AVERAGE POWER**

#### **LIMITS**

None; for reporting purposes only.

#### **TEST PROCEDURE**

The transmitter output is connected to a power meter.

The cable assembly insertion loss of 11.4 dB (including 10 dB pad and 1.4 dB cable) was entered as an offset in the power meter to allow for direct reading of power.

#### **RESULTS**

Channel	Frequency (MHz)	Power (dBm)
Low	5260	17.5
Mid	5300	17.5
High	5320	16.0

---

## 8.5.4. OUTPUT POWER AND PPSD

### LIMITS

FCC §15.407 (a) (2)

IC RSS-210 A9.2 (2)

For the 5.25–5.35 GHz and 5.47–5.725 GHz bands, the maximum conducted output power over the frequency bands of operation shall not exceed the lesser of 250 mW or  $11 \text{ dBm} + 10 \log B$ , where B is the 26 dB emission bandwidth in megahertz. In addition, the peak power spectral density shall not exceed 11 dBm in any 1 megahertz band. If transmitting antennas of directional gain greater than 6 dBi are used, both the maximum conducted output power and the peak power spectral density shall be reduced by the amount in dB that the directional gain of the antenna exceeds 6 dBi.

### DIRECTIONAL ANTENNA GAIN

There is only one transmitter output therefore the directional gain is equal to the antenna gain.

**RESULTS**

**Limits FCC 15.407**

Channel	Frequency (MHz)	Fixed Limit (dBm)	B (MHz)	11 + 10 Log B Limit (dBm)	Directional Gain (dBi)	Power Limit (dBm)	PPSD Limit (dBm)
Low	5260	24	23.70	24.75	4.25	24.00	11.00
Mid	5300	24	22.40	24.50	4.25	24.00	11.00
High	5320	24	19.95	24.00	4.25	24.00	11.00

**Output Power Results**

Channel	Frequency (MHz)	Meas Power (dBm)	Corr'd Power (dBm)	Power Limit (dBm)	Power Margin (dB)
Low	5260	17.941	17.941	24.00	-6.059
Mid	5300	17.751	17.751	24.00	-6.249
High	5320	16.702	16.702	24.00	-7.297

**PPSD Results**

Channel	Frequency (MHz)	Meas PPSD (dBm)	Corr'd PPSD (dBm)	PPSD Limit (dBm)	PPSD Margin (dB)
Low	5260	7.30	7.30	11.00	-3.70
Mid	5300	7.11	7.11	11.00	-3.89
High	5320	6.08	6.08	11.00	-4.92

**IC RSS-210 A9.2(1)**

Channel	Frequency (MHz)	Fixed Limit (dBm)	B 99% (MHz)	11 + 10 Log B Limit (dBm)	Directional Gain (dBi)	Power Limit (dBm)	PPSD Limit (dBm)
Low	5260	24	17.5359	23.4393	4.25	23.4393	11.0000
Mid	5300	24	17.5444	23.4414	4.25	23.4414	11.0000
High	5320	24	17.5384	23.4399	4.25	23.4399	11.0000

**Output Power Results**

Channel	Frequency (MHz)	Meas Power (dBm)	Corr'd Power (dBm)	Power Limit (dBm)	Power Margin (dB)
Low	5260	17.941	17.941	23.4393	-5.4983
Mid	5300	17.751	17.751	23.4414	-5.6904
High	5320	16.702	16.702	23.4399	-6.7379

**PPSD Results**

Channel	Frequency (MHz)	Meas PPSD (dBm)	Corr'd PPSD (dBm)	PPSD Limit (dBm)	PPSD Margin (dB)
Low	5260	7.30	7.30	11.0000	-3.7000
Mid	5300	7.11	7.11	11.0000	-3.8900
High	5320	6.08	6.08	11.0000	-4.9200

**OUTPUT POWER AND PPSD**

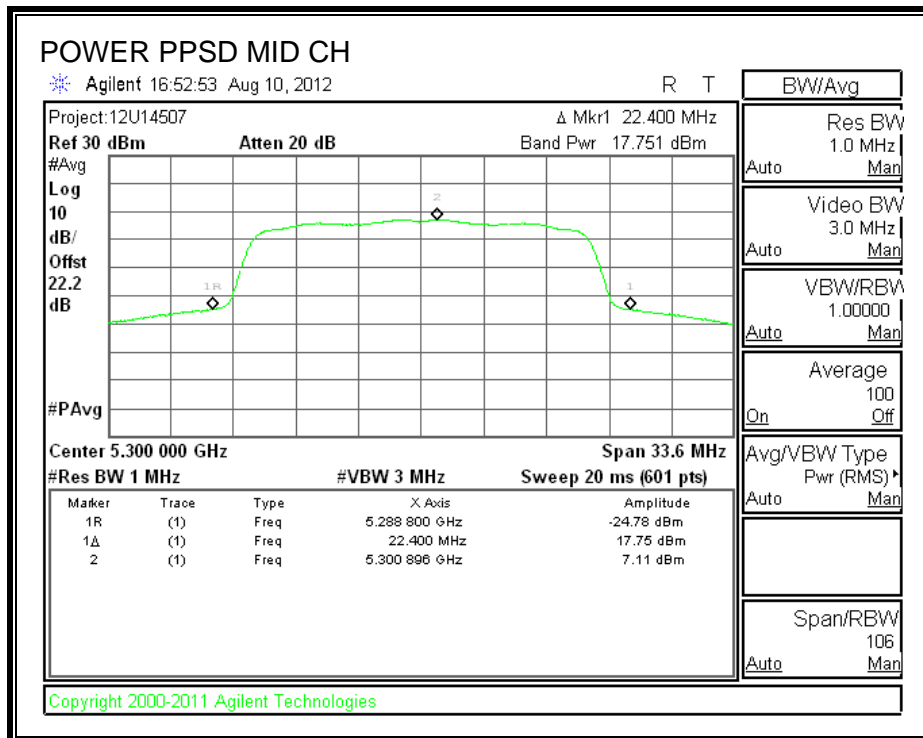
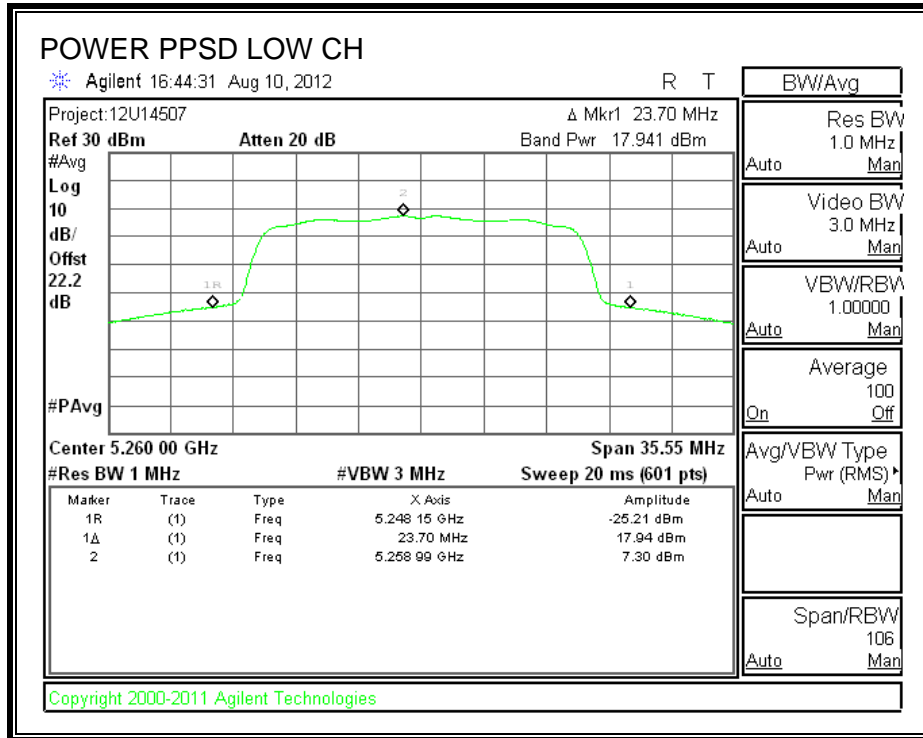

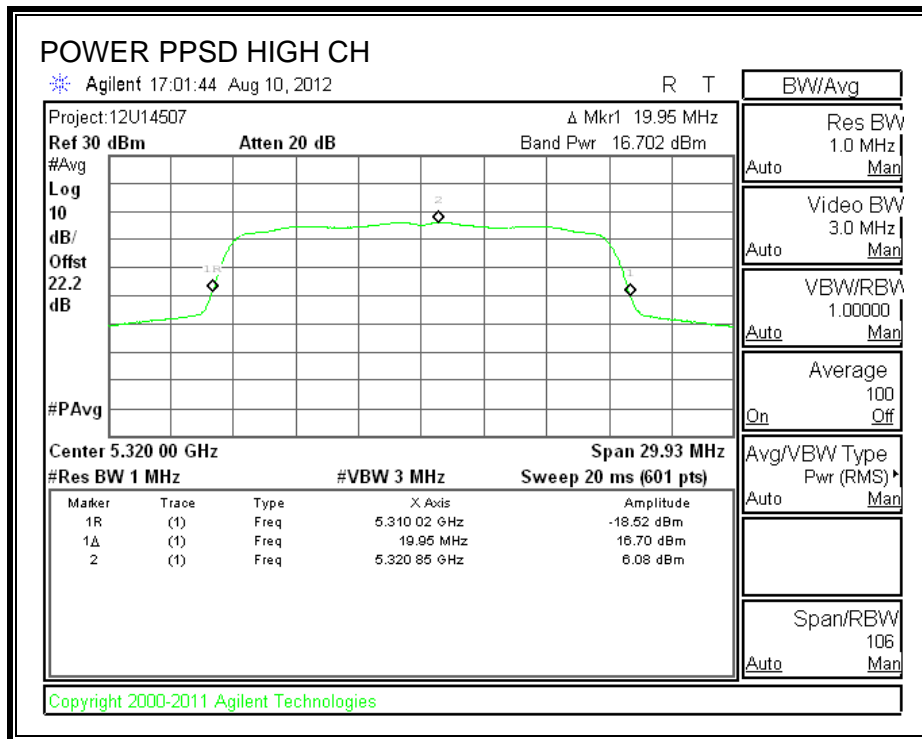

### 8.5.5. PEAK EXCURSION

#### LIMITS

FCC §15.407 (a) (6)

The ratio of the peak excursion of the modulation envelope (measured using a peak hold function) to the peak transmit power (measured as specified above) shall not exceed 13 dB across any 1 MHz bandwidth or the emission bandwidth whichever is less.

#### RESULTS

Channel	Frequency (MHz)	Peak Excursion (dB)	Limit (dB)	Margin (dB)
Low	5260	9.28	13	-3.72
Mid	5300	9.42	13	-3.58
High	5320	9.09	13	-3.91

**PEAK EXCURSION**

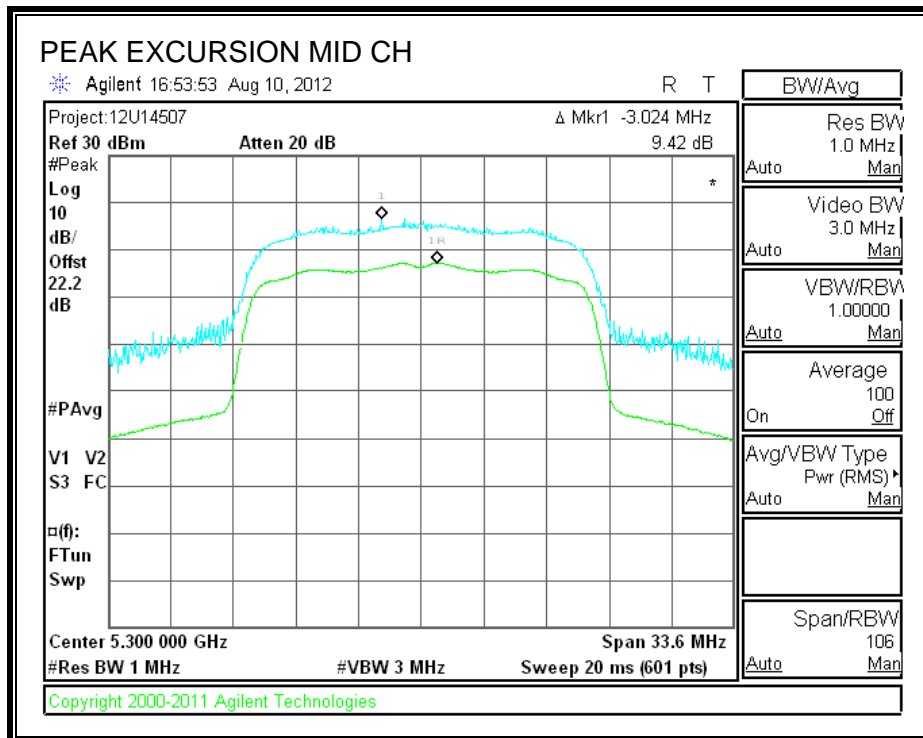
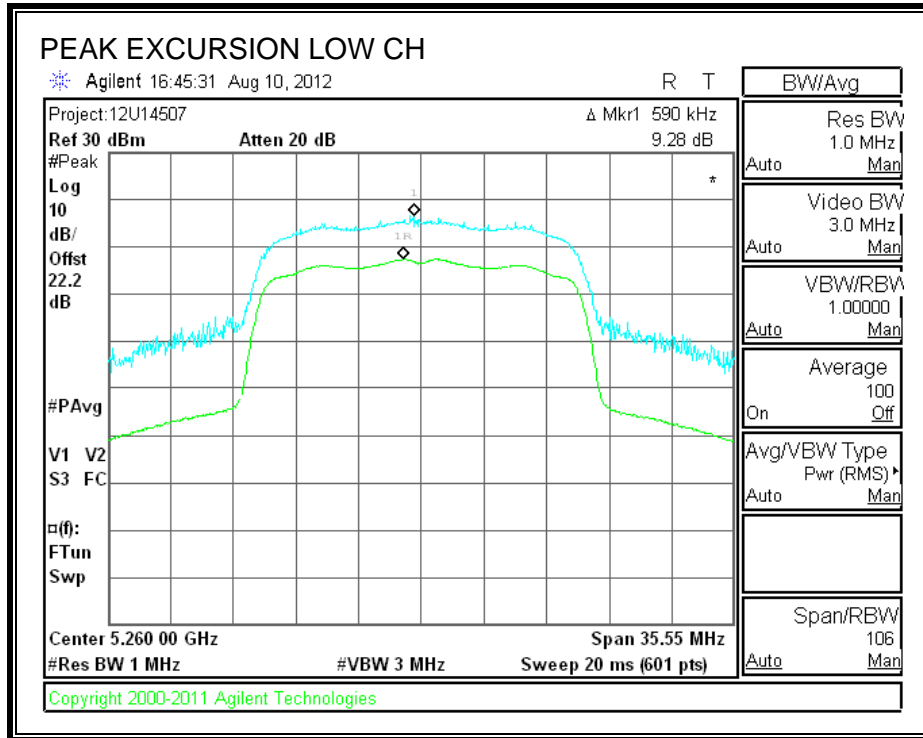



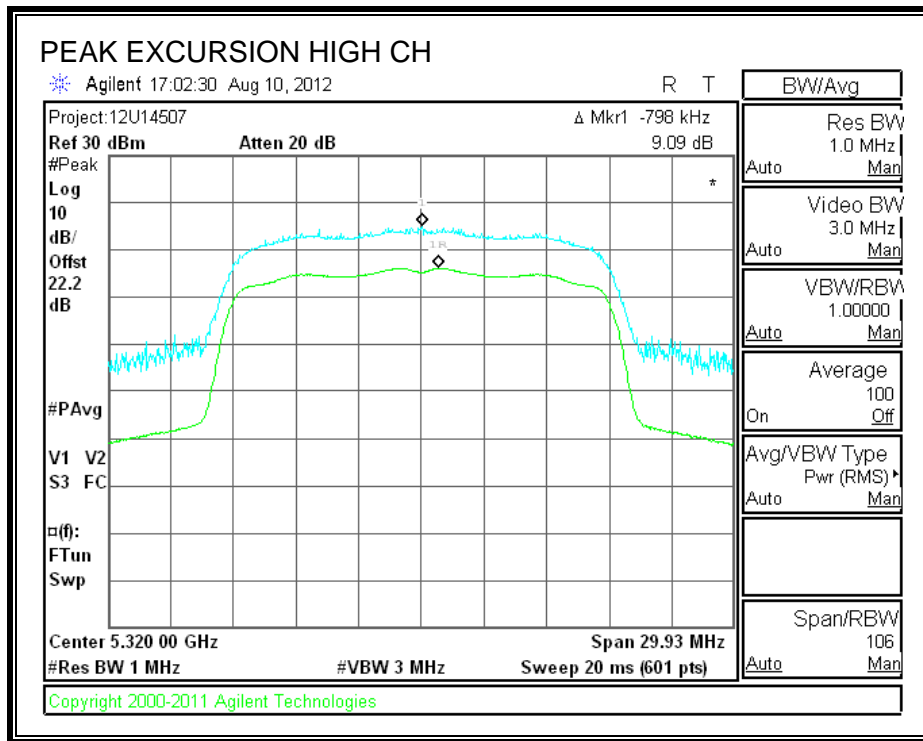

### **8.5.6. TPC POWER**

#### **LIMITS**

FCC §15.407 (h) (1)

IC RSS-210 A9.2 (2)

Transmit power control (TPC). U-NII devices operating in the 5.25–5.35 GHz band and the 5.47–5.725 GHz band shall employ a TPC mechanism. The U-NII device is required to have the capability to operate at least 6 dB below the mean EIRP value of 30 dBm. A TPC mechanism is not required for systems with an e.i.r.p. of less than 500 mW.

#### **DIRECTIONAL ANTENNA GAIN**

There is only one transmitter output therefore the directional gain is equal to the antenna gain.

#### **RESULTS**

EIRP = 18.001 dBm + 4.25 dBi = **22.251 dBm**, which is less than the threshold of 500 mW (27 dBm); therefore, TPC is not required

**8.6. 802.11n HT40 MODE IN THE 5.3 GHz BAND**

**8.6.1. 26 dB BANDWIDTH**

**LIMITS**

None; for reporting purposes only.

**RESULTS**

Channel	Frequency (MHz)	26 dB Bandwidth (MHz)
Low	5270	52.40
High	5310	44.83

**26 dB BANDWIDTH**

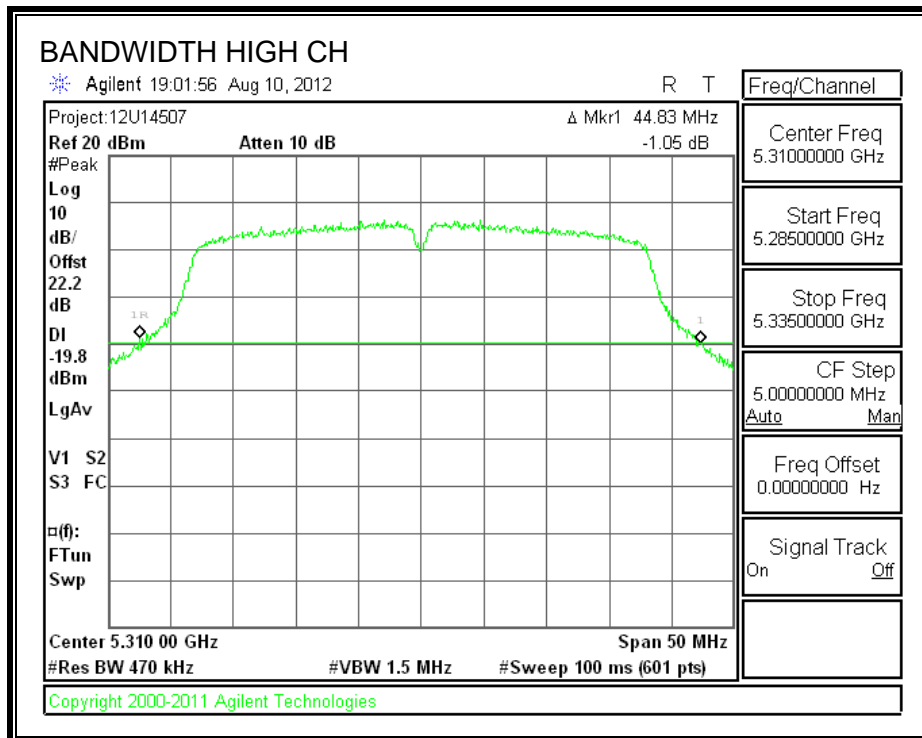
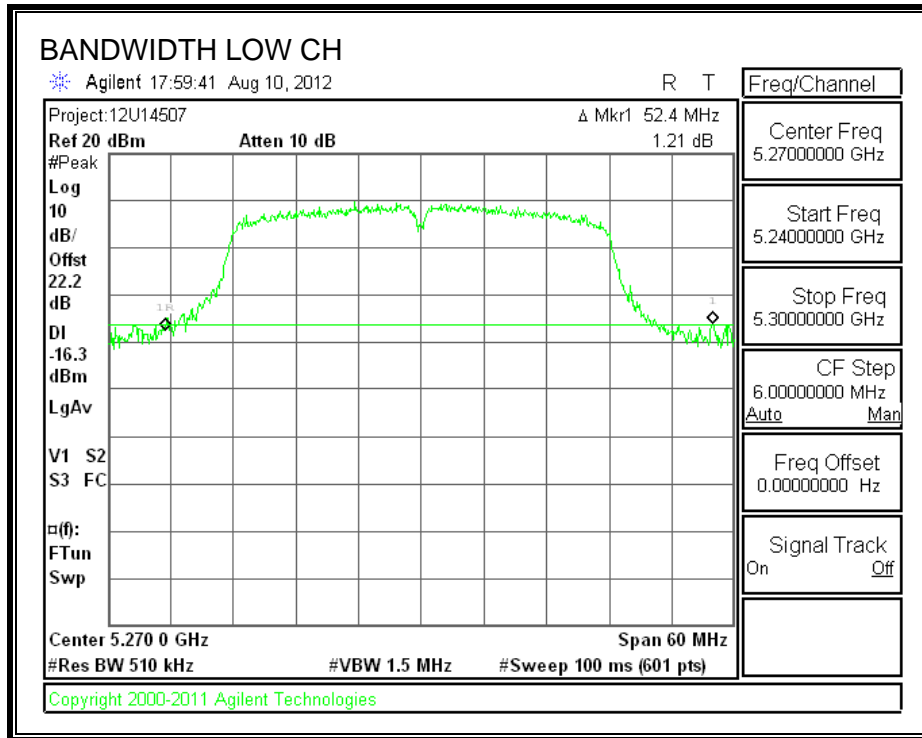

**8.6.2. 99% BANDWIDTH**

**LIMITS**

None; for reporting purposes only.

**RESULTS**

Channel	Frequency (MHz)	99% Bandwidth (MHz)
Low	5270	35.8536
High	5310	35.8268

**99% BANDWIDTH**

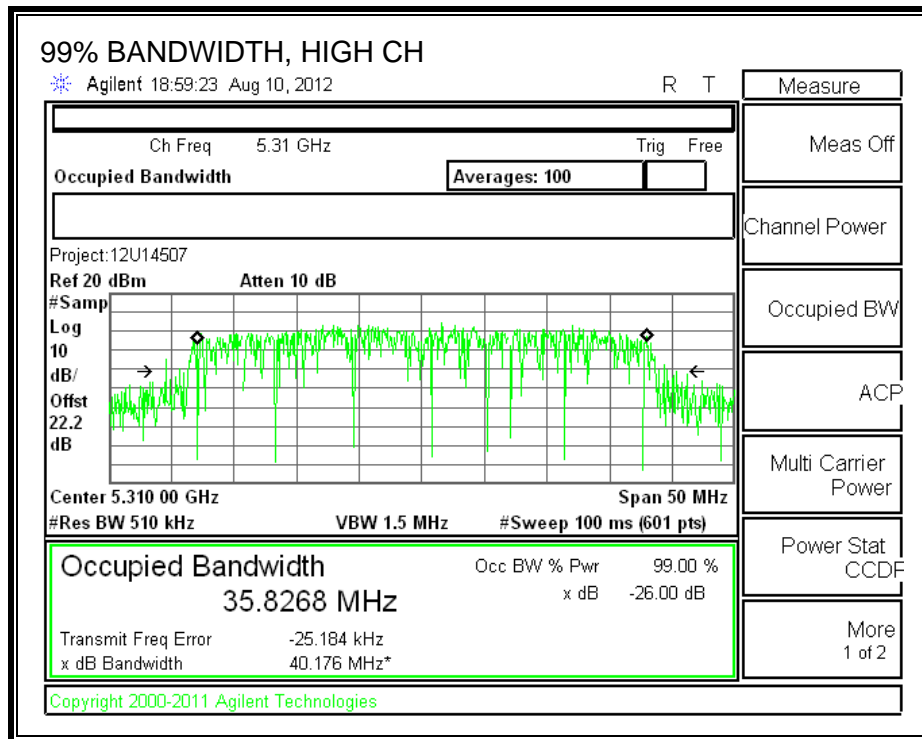
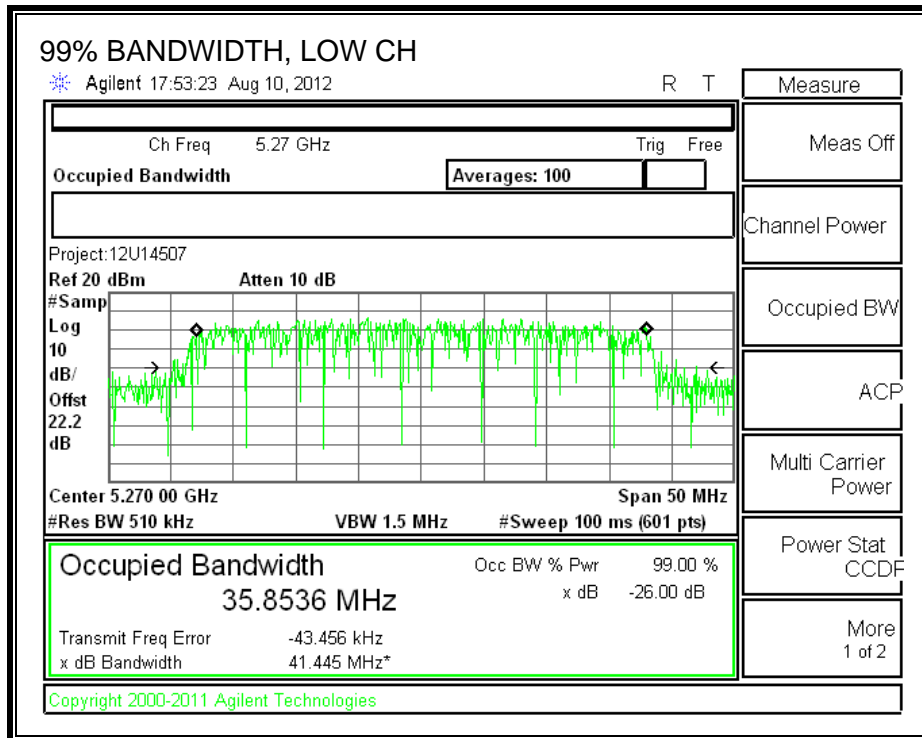

---

### 8.6.3. AVERAGE POWER

#### LIMITS

None; for reporting purposes only.

#### TEST PROCEDURE

The transmitter output is connected to a power meter.

The cable assembly insertion loss of 11.4 dB (including 10 dB pad and 1.4 dB cable) was entered as an offset in the power meter to allow for direct reading of power.

#### RESULTS

Channel	Frequency (MHz)	Power (dBm)
Low	5270	17.5
High	5310	14.0

---

## 8.6.4. OUTPUT POWER AND PPSD

### LIMITS

FCC §15.407 (a) (2)

IC RSS-210 A9.2 (2)

For the 5.25–5.35 GHz and 5.47–5.725 GHz bands, the maximum conducted output power over the frequency bands of operation shall not exceed the lesser of 250 mW or  $11 \text{ dBm} + 10 \log B$ , where B is the 26 dB emission bandwidth in megahertz. In addition, the peak power spectral density shall not exceed 11 dBm in any 1 megahertz band. If transmitting antennas of directional gain greater than 6 dBi are used, both the maximum conducted output power and the peak power spectral density shall be reduced by the amount in dB that the directional gain of the antenna exceeds 6 dBi.

### DIRECTIONAL ANTENNA GAIN

There is only one transmitter output therefore the directional gain is equal to the antenna gain.



**RESULTS**

**Limits FCC 15.407**

Channel	Frequency (MHz)	Fixed Limit (dBm)	B (MHz)	11 + 10 Log B Limit (dBm)	Directional Gain (dBi)	Power Limit (dBm)	PPSD Limit (dBm)
Low	5270	24	52.40	28.19	4.25	24.00	11.00
High	5310	24	44.83	27.52	4.25	24.00	11.00

**Output Power Results**

Channel	Frequency (MHz)	Meas Power (dBm)	Corr'd Power (dBm)	Power Limit (dBm)	Power Margin (dB)
Low	5270	18.070	18.070	24.00	-5.930
High	5310	14.738	14.738	24.00	-9.262

**PPSD Results**

Channel	Frequency (MHz)	Meas PPSD (dBm)	Corr'd PPSD (dBm)	PPSD Limit (dBm)	PPSD Margin (dB)
Low	5270	4.04	4.04	11.00	-6.96
High	5310	0.69	0.69	11.00	-10.31

**IC RSS-210 A9.2(1)**

Channel	Frequency (MHz)	Fixed Limit (dBm)	B 99% (MHz)	11 + 10 Log B Limit (dBm)	Directional Gain (dBi)	Power Limit (dBm)	PPSD Limit (dBm)
Low	5270	24	35.8536	26.5453	4.25	24.0000	11.0000
High	5310	24	35.8268	26.5421	4.25	24.0000	11.0000

**Output Power Results**

Channel	Frequency (MHz)	Meas Power (dBm)	Corr'd Power (dBm)	Power Limit (dBm)	Power Margin (dB)
Low	5270	18.070	18.070	24.0000	-5.9300
High	5310	14.738	14.738	24.0000	-9.2620

**PPSD Results**

Channel	Frequency (MHz)	Meas PPSD (dBm)	Corr'd PPSD (dBm)	PPSD Limit (dBm)	PPSD Margin (dB)
Low	5270	4.04	4.04	11.0000	-6.9600
High	5310	0.69	0.69	11.0000	-10.3100

**OUTPUT POWER AND PPSD**

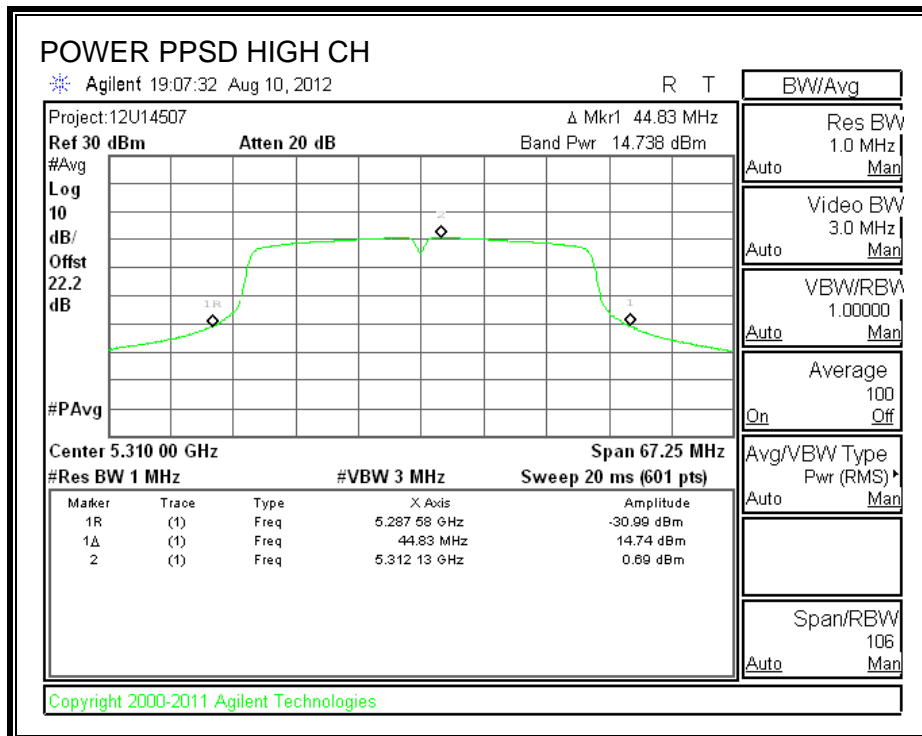
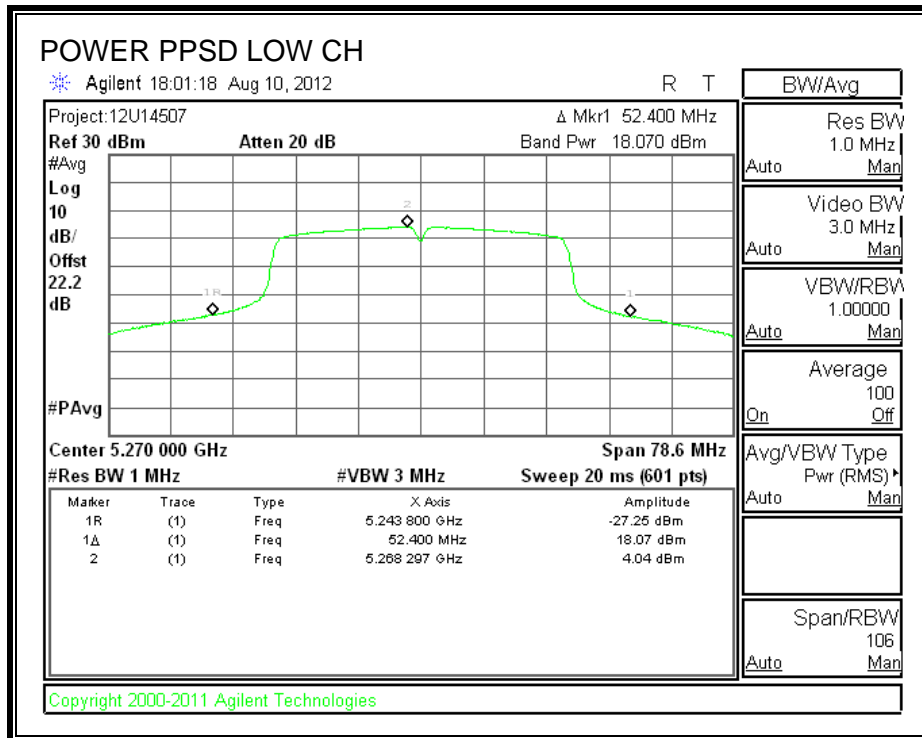

### 8.6.5. PEAK EXCURSION

#### LIMITS

FCC §15.407 (a) (6)

The ratio of the peak excursion of the modulation envelope (measured using a peak hold function) to the peak transmit power (measured as specified above) shall not exceed 13 dB across any 1 MHz bandwidth or the emission bandwidth whichever is less.

#### RESULTS

Channel	Frequency (MHz)	Peak Excursion (dB)	Limit (dB)	Margin (dB)
Low	5270	9.23	13	-3.77
High	5310	9.37	13	-3.63

**PEAK EXCURSION**

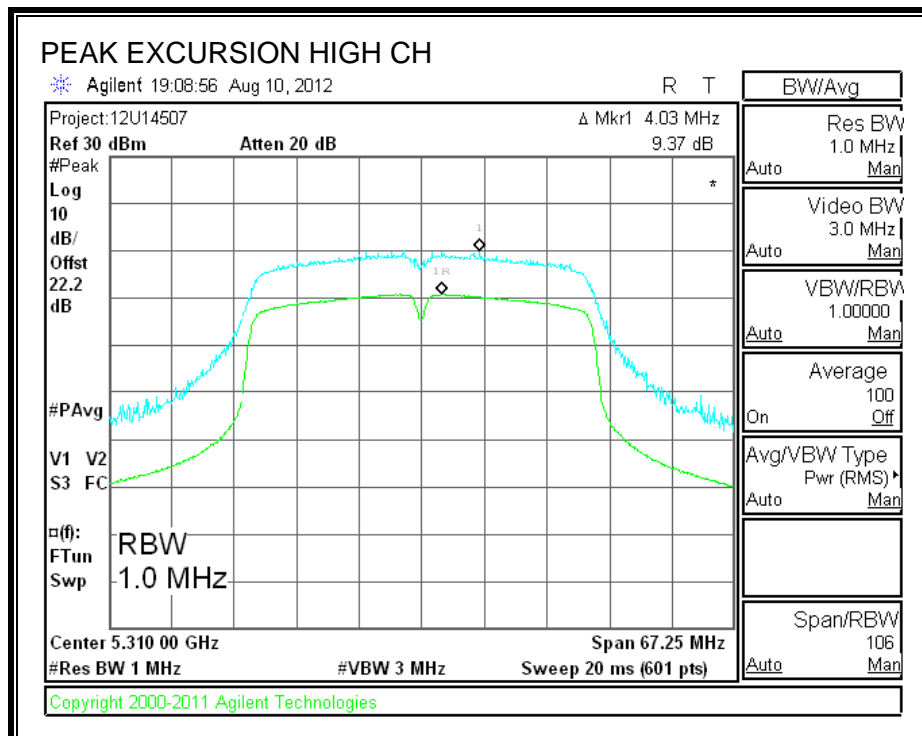
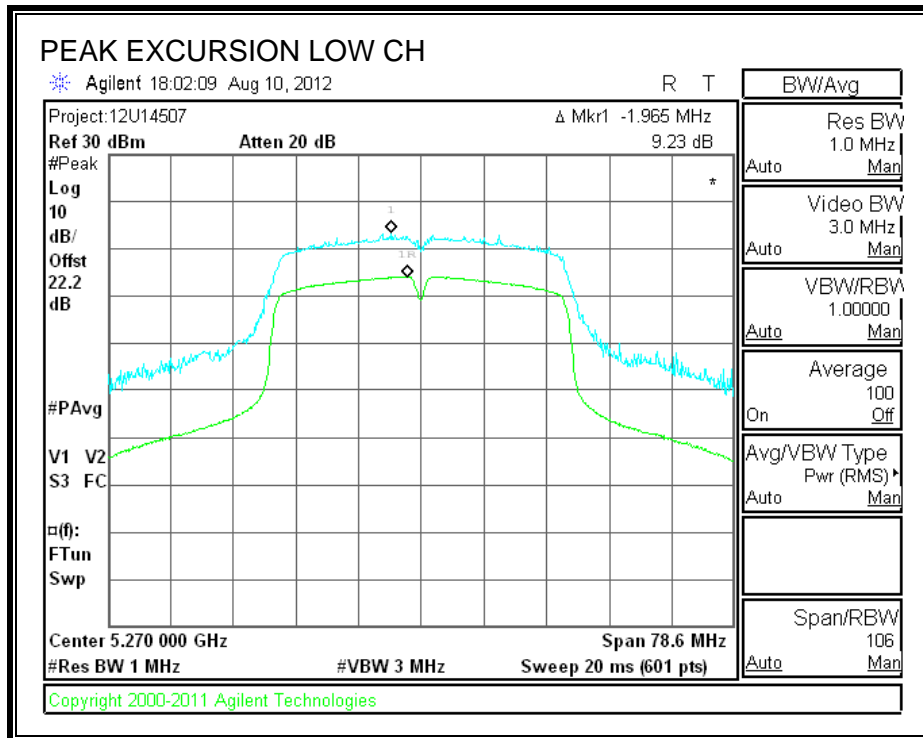

### **8.6.6. TPC POWER**

#### **LIMITS**

FCC §15.407 (h) (1)

IC RSS-210 A9.2 (2)

Transmit power control (TPC). U-NII devices operating in the 5.25–5.35 GHz band and the 5.47–5.725 GHz band shall employ a TPC mechanism. The U-NII device is required to have the capability to operate at least 6 dB below the mean EIRP value of 30 dBm. A TPC mechanism is not required for systems with an e.i.r.p. of less than 500 mW.

#### **DIRECTIONAL ANTENNA GAIN**

There is only one transmitter output therefore the directional gain is equal to the antenna gain.

#### **RESULTS**

EIRP = 18.2 dBm + 4.25 dBi = **22.45 dBm**, which is less than the threshold of 500 mW (27 dBm); therefore, TPC is not required

**8.7. 802.11a MODE IN THE 5.6 GHz BAND**

**8.7.1. 26 dB BANDWIDTH**

**LIMITS**

None; for reporting purposes only.

**RESULTS**

Channel	Frequency (MHz)	26 dB Bandwidth (MHz)
Low	5500	19.00
Low1	5520	22.83
Mid	5580	23.55
High1	5680	21.08
High	5700	18.95

**26 dB BANDWIDTH**

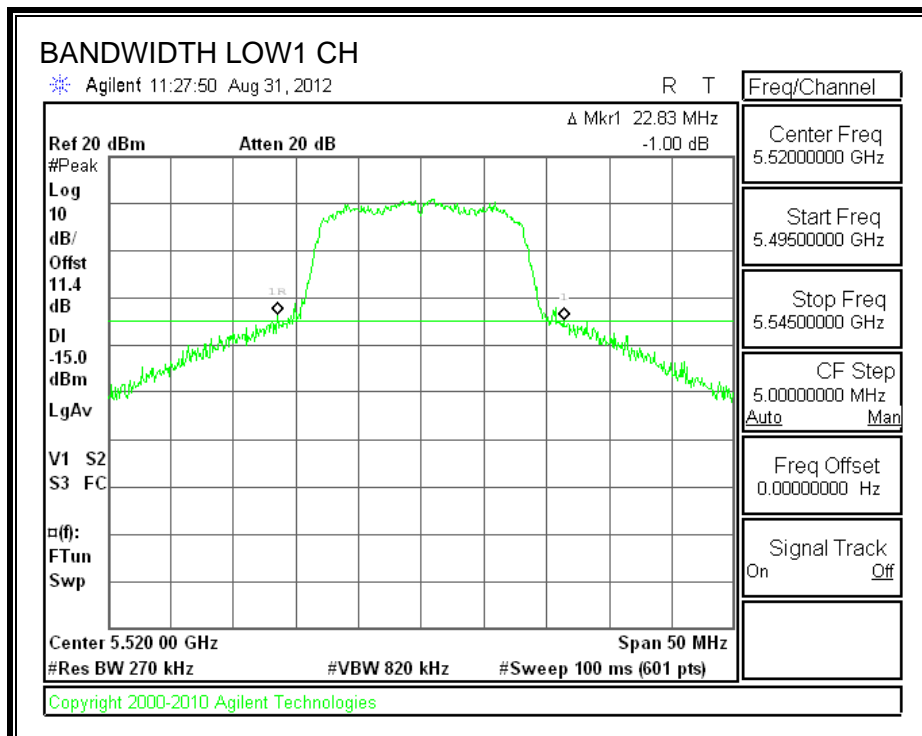
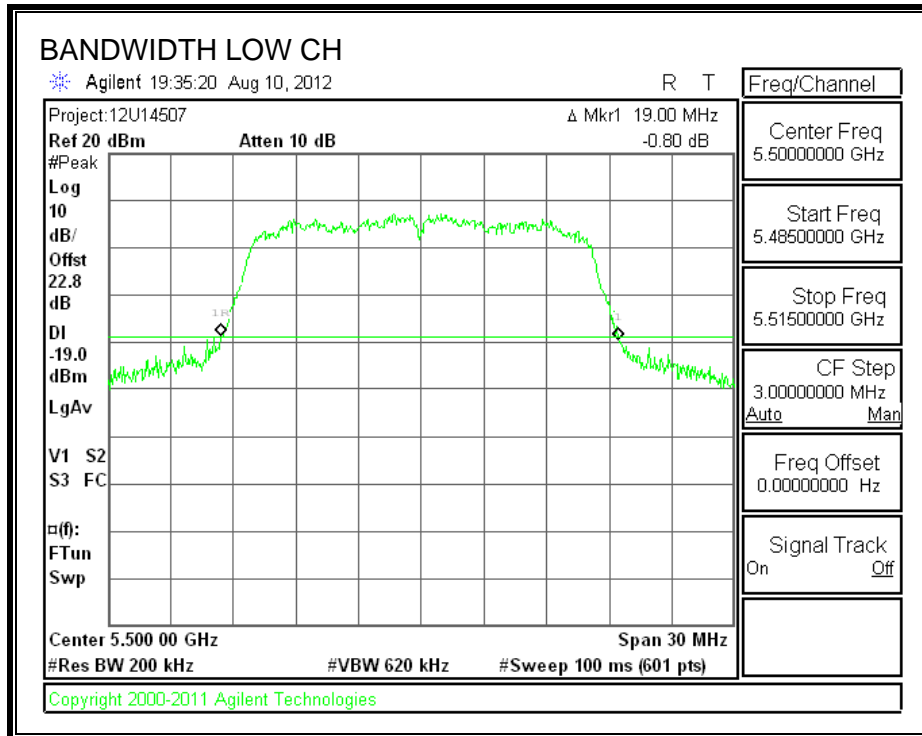



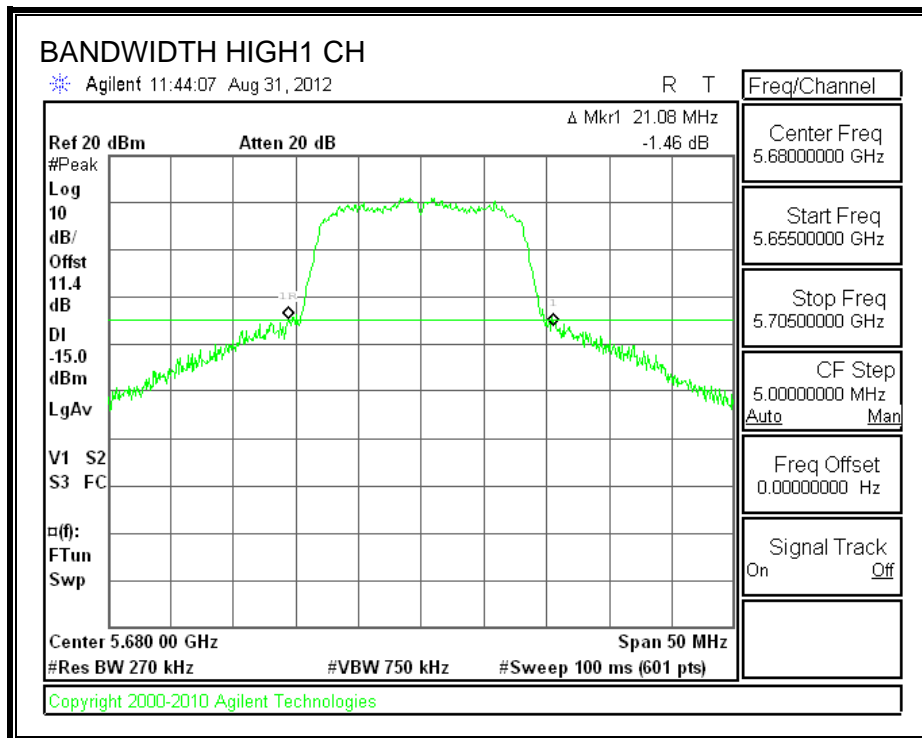
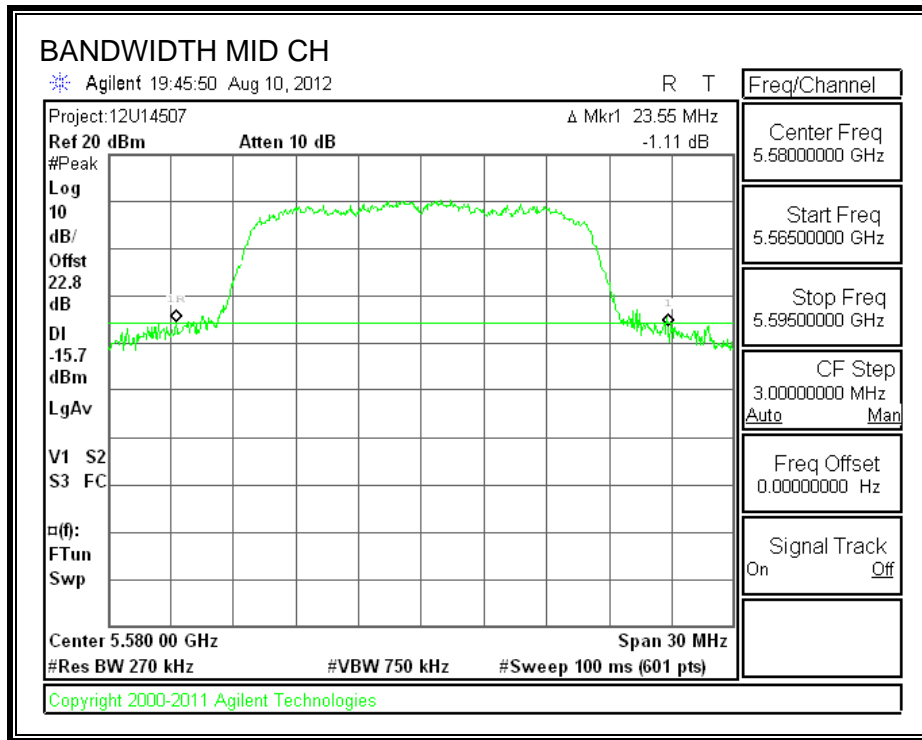

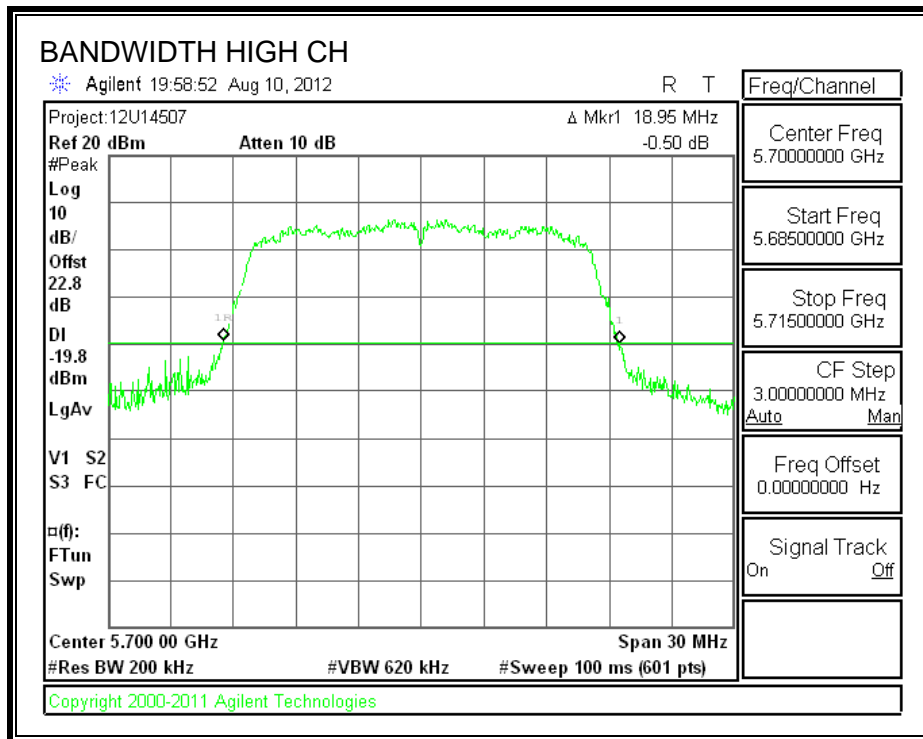

**8.7.2. 99% BANDWIDTH**

**LIMITS**

None; for reporting purposes only.

**RESULTS**

Channel	Frequency (MHz)	99% Bandwidth (MHz)
Low	5500	16.3454
Low1	5520	16.4097
Mid	5580	16.3627
High1	5680	16.4280
High	5700	16.3432

**99% BANDWIDTH**

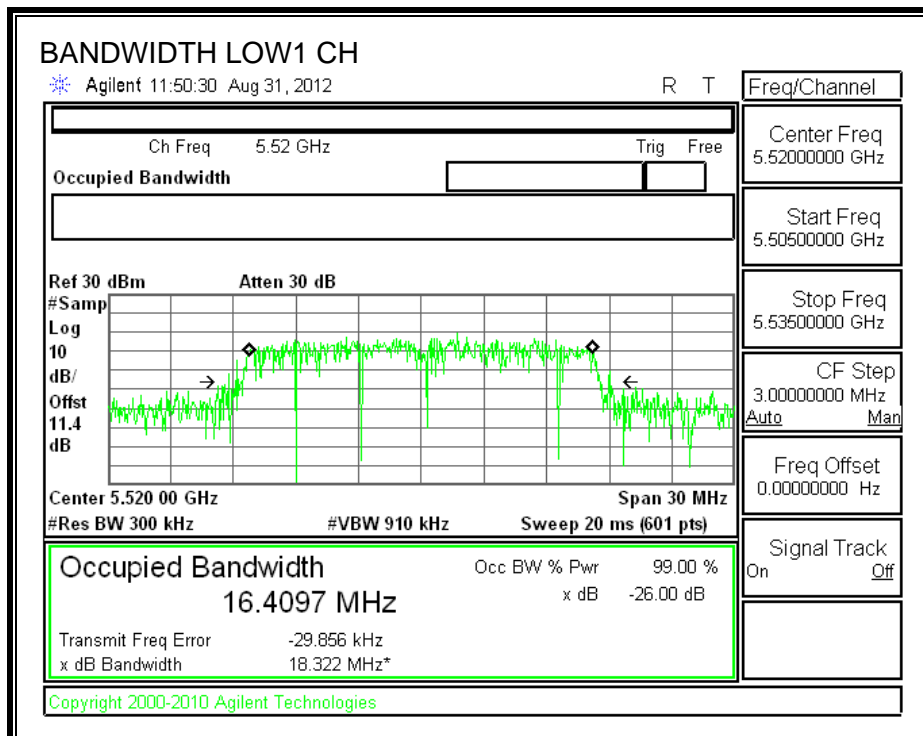
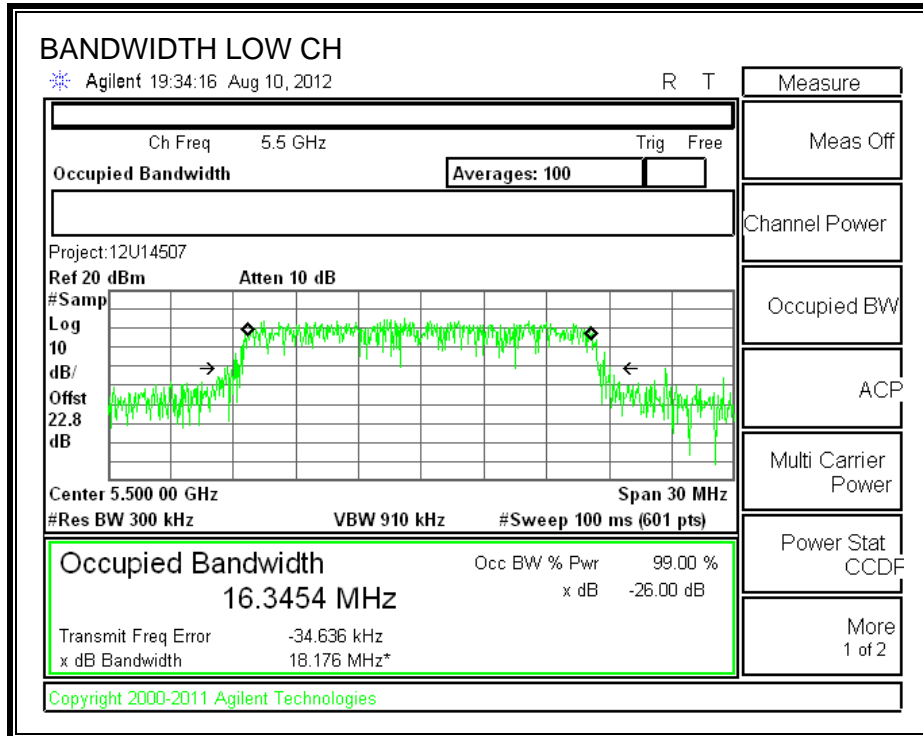

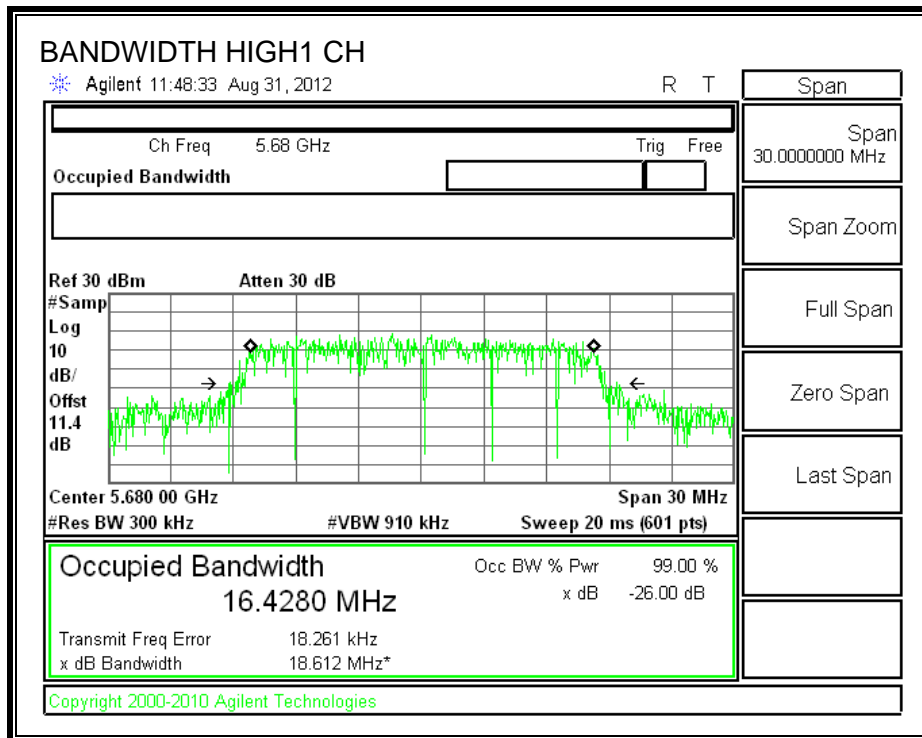
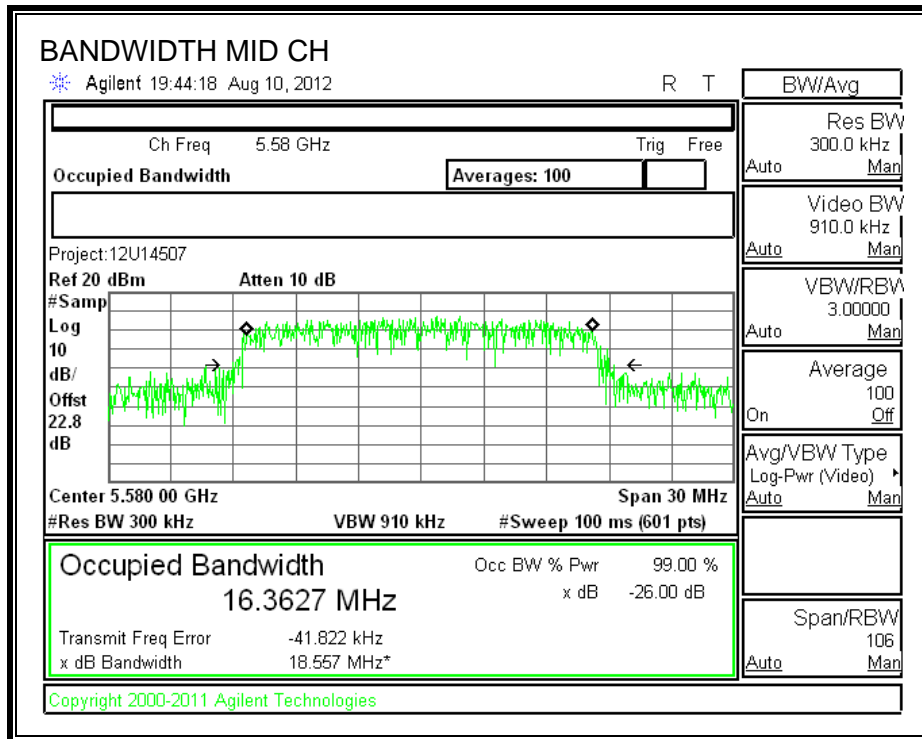

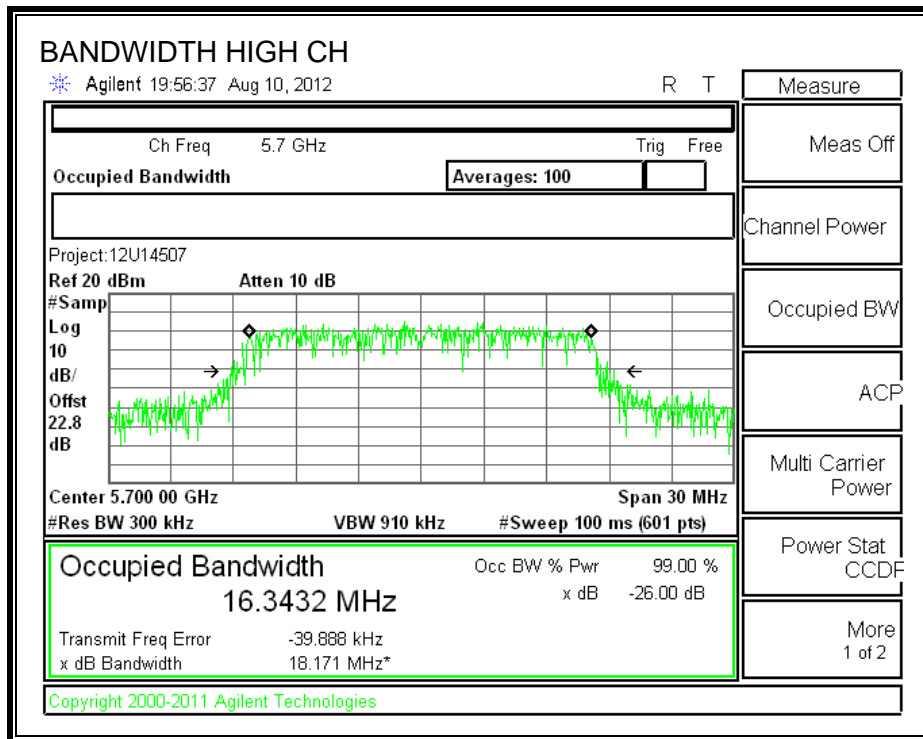

### **8.7.3. AVERAGE POWER**

#### **LIMITS**

None; for reporting purposes only.

#### **TEST PROCEDURE**

The transmitter output is connected to a power meter.

The cable assembly insertion loss of 11.4 dB (including 10 dB pad and 1.4 dB cable) was entered as an offset in the power meter to allow for direct reading of power.

#### **RESULTS**

Channel	Frequency (MHz)	Power (dBm)
Low	5500	15.49
Low1	5520	17.95
Mid	5580	17.98
High 1	5680	17.91
High	5700	15.00

---

## 8.7.4. OUTPUT POWER AND PPSD

### LIMITS

FCC §15.407 (a) (2)

IC RSS-210 A9.2 (3)

For the 5.25–5.35 GHz and 5.47–5.725 GHz bands, the maximum conducted output power over the frequency bands of operation shall not exceed the lesser of 250 mW or  $11 \text{ dBm} + 10 \log B$ , where B is the 26 dB emission bandwidth in megahertz. In addition, the peak power spectral density shall not exceed 11 dBm in any 1 megahertz band. If transmitting antennas of directional gain greater than 6 dBi are used, both the maximum conducted output power and the peak power spectral density shall be reduced by the amount in dB that the directional gain of the antenna exceeds 6 dBi.

### DIRECTIONAL ANTENNA GAIN

There is only one transmitter output therefore the directional gain is equal to the antenna gain.



**RESULTS**

**Limits FCC 15.407**

Channel	Frequency (MHz)	Fixed Limit (dBm)	B (MHz)	11 + 10 Log B Limit (dBm)	Directional Gain (dBi)	Power Limit (dBm)	PPSD Limit (dBm)
Low	5500	24	19.00	23.79	4.51	23.79	11.00
Low1	5520	24	22.83	24.59	4.51	24.00	11.00
Mid	5580	24	23.55	24.72	4.51	24.00	11.00
High1	5680	24	21.08	24.24	4.51	24.00	11.00
High	5700	24	18.95	23.78	4.51	23.78	11.00

**Output Power Results**

Channel	Frequency (MHz)	Meas Power (dBm)	Corr'd Power (dBm)	Power Limit (dBm)	Power Margin (dB)
Low	5500	16.394	16.394	23.79	-7.394
Low1	5520	18.972	18.972	24.00	-5.028
Mid	5580	18.393	18.393	24.00	-5.607
High1	5680	19.021	19.021	24.00	-4.979
High	5700	15.513	15.513	23.78	-8.263

**PPSD Results**

Channel	Frequency (MHz)	Meas PPSD (dBm)	Corr'd PPSD (dBm)	PPSD Limit (dBm)	PPSD Margin (dB)
Low	5500	5.95	5.95	11.00	-5.05
Low1	5520	8.53	8.53	11.00	-2.47
Mid	5580	7.95	7.95	11.00	-3.05
High1	5680	8.65	8.65	11.00	-2.35
High	5700	5.07	5.07	11.00	-5.93

**IC RSS-210 A9.2(1)**

Channel	Frequency (MHz)	Fixed Limit (dBm)	B 99% (MHz)	11 + 10 Log B Limit (dBm)	Directional Gain (dBi)	Power Limit (dBm)	PPSD Limit (dBm)
Low	5500	24	16.3454	23.1340	4.51	23.1340	11.0000
Low1	5520	24	16.4097	23.1510	4.51	23.1510	11.0000
Mid	5580	24	16.3627	23.1385	4.51	23.1385	11.0000
High1	5680	24	16.4280	23.1558	4.51	23.1558	11.0000
High	5700	24	16.3432	23.1334	4.51	23.1334	11.0000

**Output Power Results**

Channel	Frequency (MHz)	Meas Power (dBm)	Corr'd Power (dBm)	Power Limit (dBm)	Power Margin (dB)
Low	5500	16.394	16.394	23.1340	-6.7400
Low1	5520	18.972	18.972	23.1510	-4.1790
Mid	5580	18.393	18.393	23.1385	-4.7455
High1	5680	19.021	19.021	23.1558	-4.1348
High	5700	15.513	15.513	23.1334	-7.6204

**PPSD Results**

Channel	Frequency (MHz)	Meas PPSD (dBm)	Corr'd PPSD (dBm)	PPSD Limit (dBm)	PPSD Margin (dB)
Low	5500	5.95	5.95	11.0000	-5.0500
Low1	5520	8.53	8.53	11.0000	-2.4700
Mid	5580	7.95	7.95	11.0000	-3.0500
High1	5680	8.65	8.65	11.0000	-2.3500
High	5700	5.07	5.07	11.0000	-5.9300

**OUTPUT POWER AND PPSD**

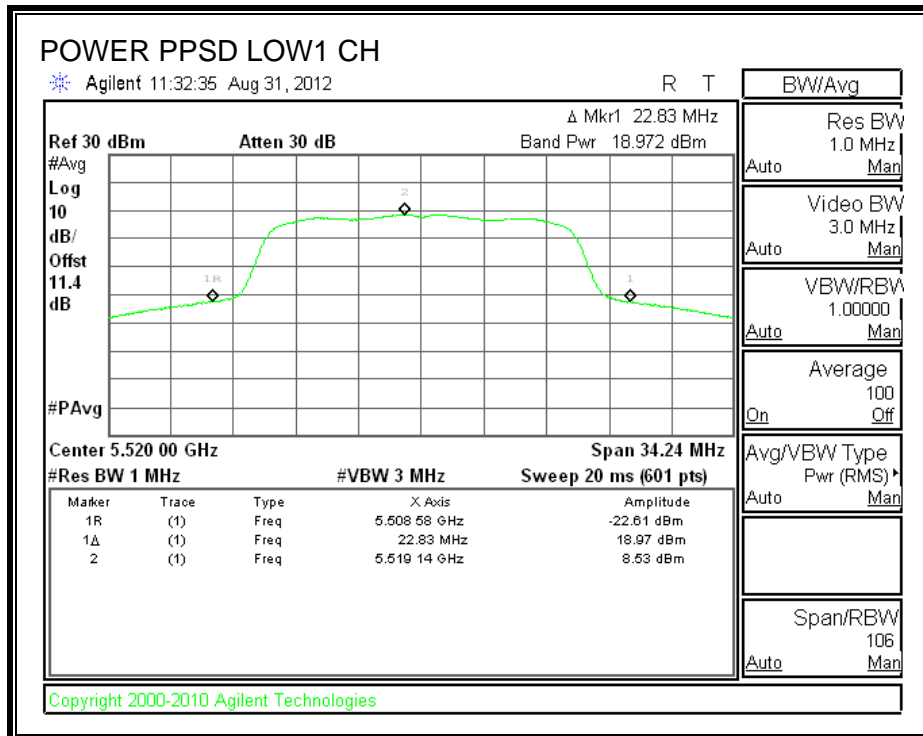
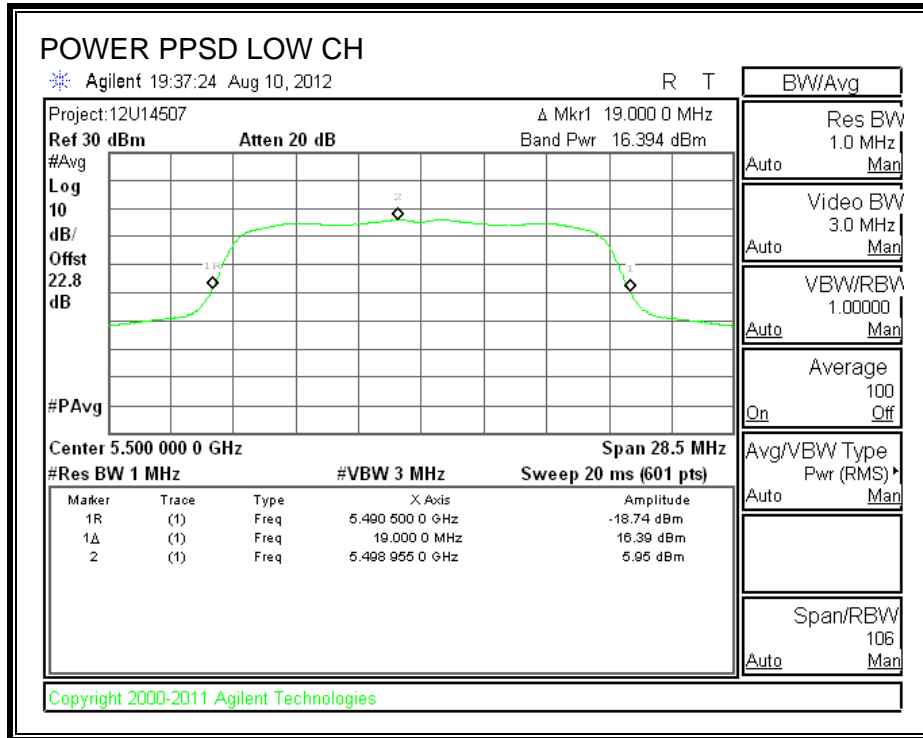

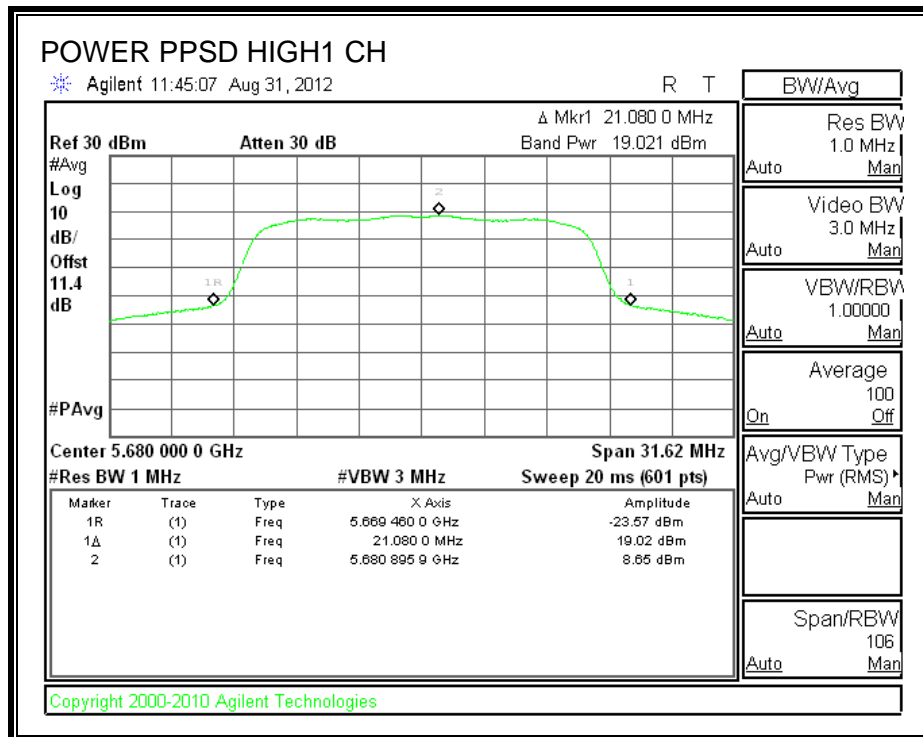
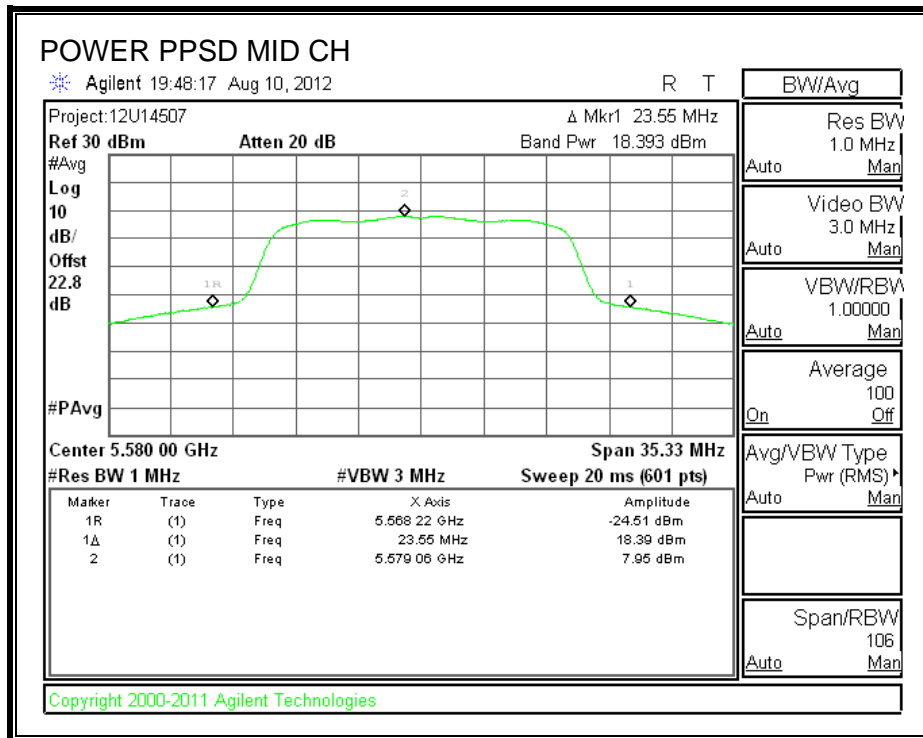

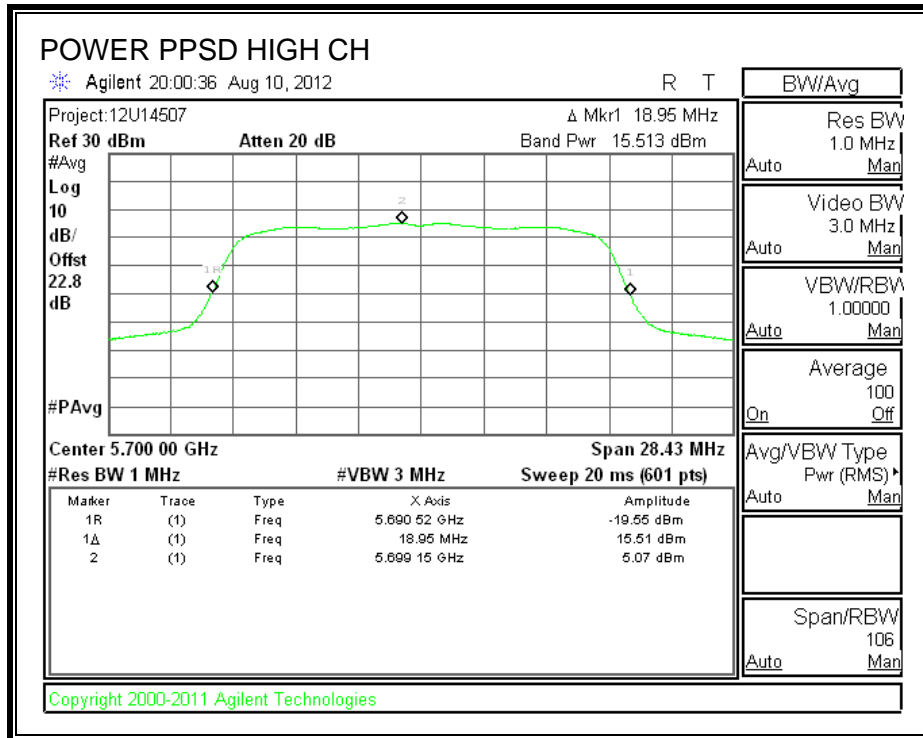

### 8.7.5. PEAK EXCURSION

#### LIMITS

FCC §15.407 (a) (6)

The ratio of the peak excursion of the modulation envelope (measured using a peak hold function) to the peak transmit power (measured as specified above) shall not exceed 13 dB across any 1 MHz bandwidth or the emission bandwidth whichever is less.

#### RESULTS

Channel	Frequency (MHz)	Peak Excursion (dB)	Limit (dB)	Margin (dB)
Low	5500	9.03	13	-3.97
Mid	5580	9.87	13	-3.13
High	5700	9.58	13	-3.42

**PEAK EXCURSION**

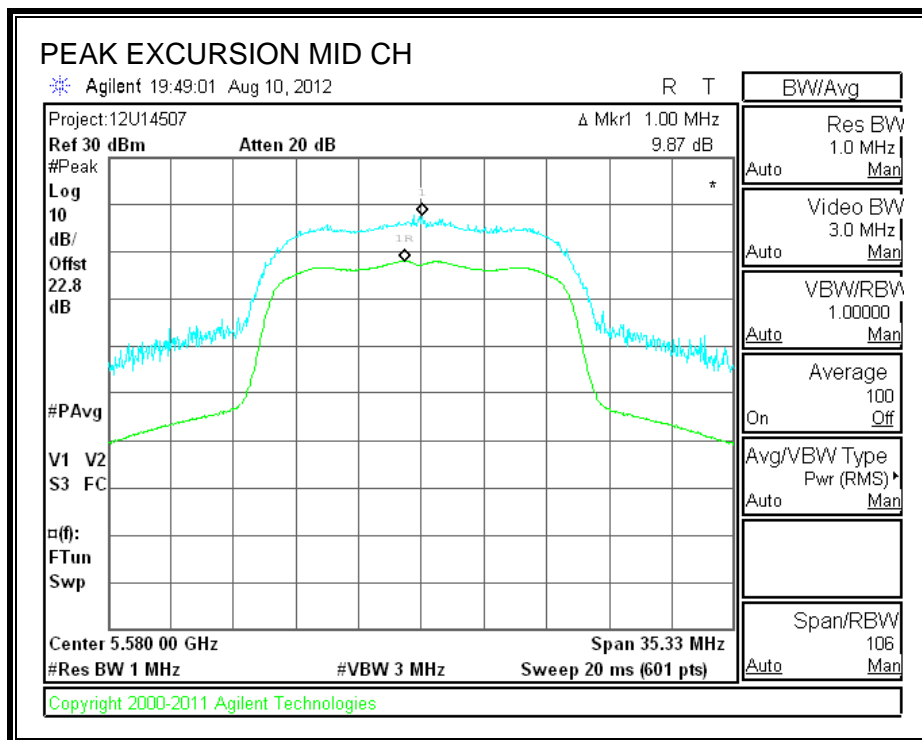
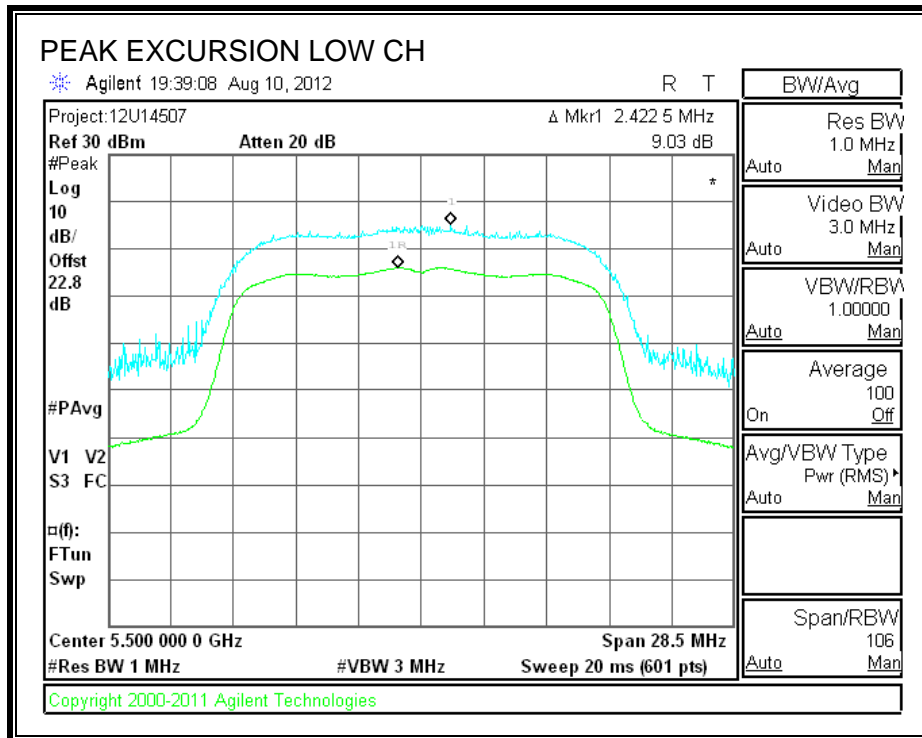

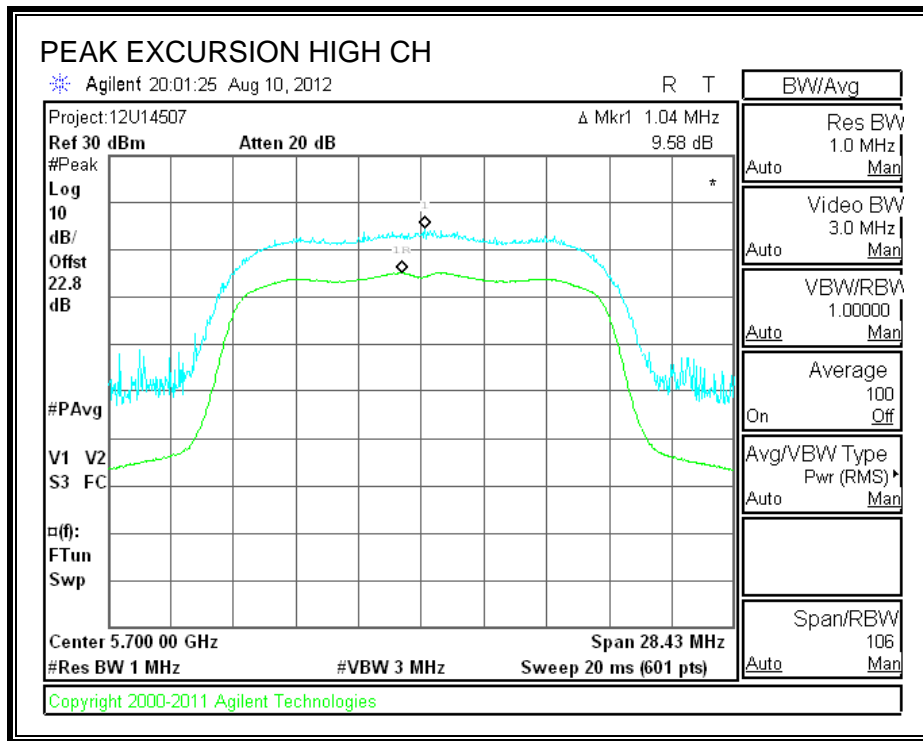



### **8.7.6. TPC POWER**

#### **LIMITS**

FCC §15.407 (h) (1)

IC RSS-210 A9.2 (3)

Transmit power control (TPC). U-NII devices operating in the 5.25–5.35 GHz band and the 5.47–5.725 GHz band shall employ a TPC mechanism. The U-NII device is required to have the capability to operate at least 6 dB below the mean EIRP value of 30 dBm. A TPC mechanism is not required for systems with an e.i.r.p. of less than 500 mW.

#### **DIRECTIONAL ANTENNA GAIN**

There is only one transmitter output therefore the directional gain is equal to the antenna gain.

#### **RESULTS**

EIRP = 18.453 dBm + 4.51 dBi = **22.963 dBm**, which is less than the threshold of 500 mW (27 dBm); therefore, TPC is not required

---

**8.7.7. CONDUCTED WEATHER RADAR BAND EMISSIONS**

Since the EUT is a client device, this test is not required.

**8.8. 802.11n HT20 MODE IN THE 5.6 GHz BAND**

**8.8.1. 26 dB BANDWIDTH**

**LIMITS**

None; for reporting purposes only.

**RESULTS**

Channel	Frequency (MHz)	26 dB Bandwidth (MHz)
Low	5500	19.25
Low1	5520	25.25
Mid	5580	25.10
High1	5580	22.67
High	5700	19.15

**26 dB BANDWIDTH**

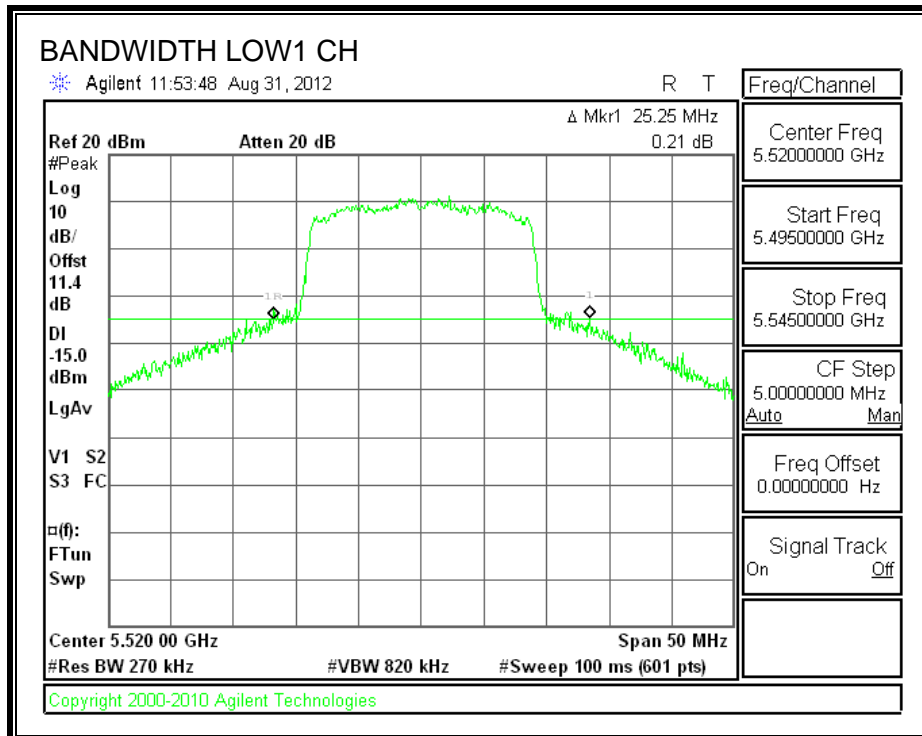
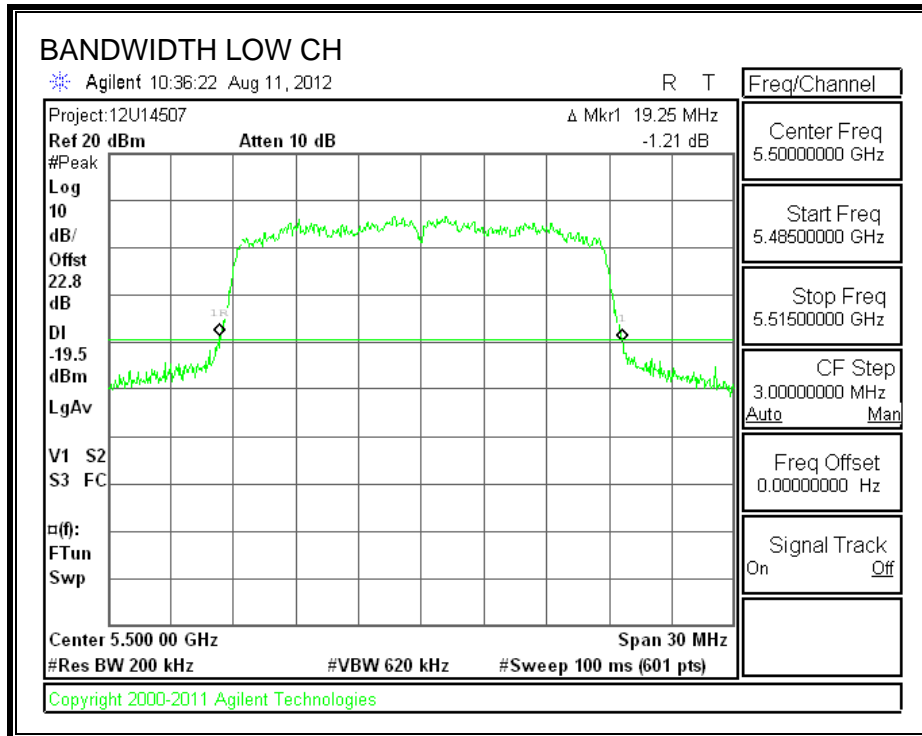

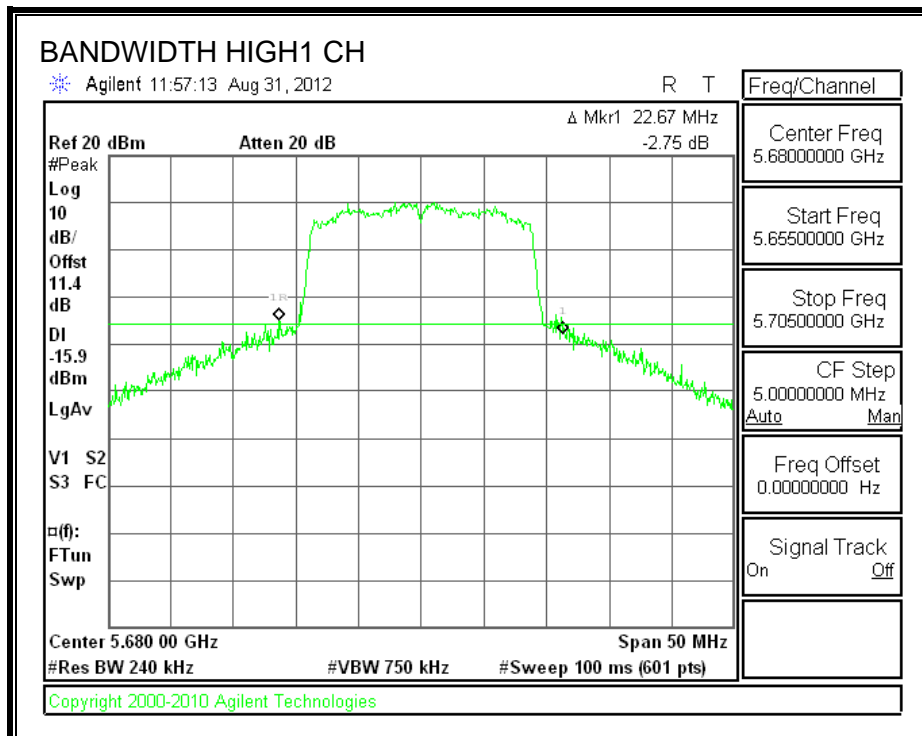
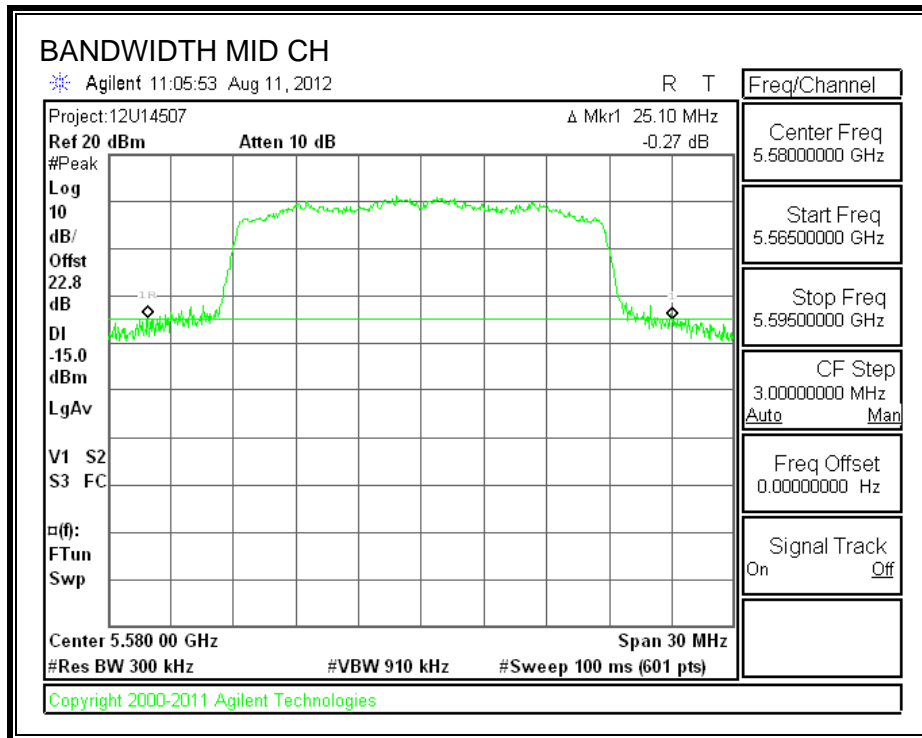

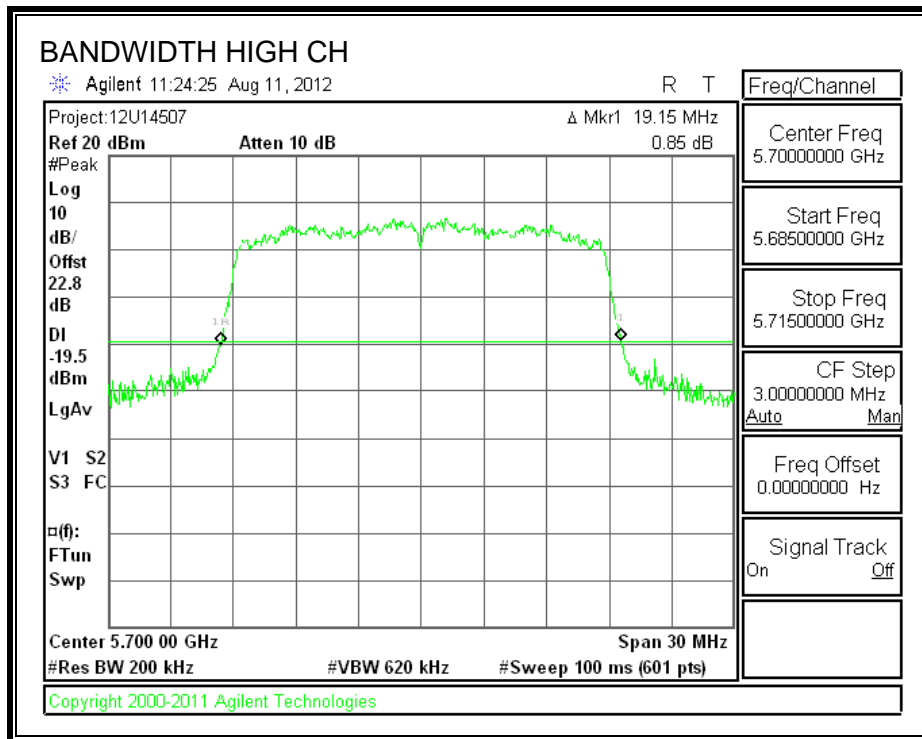

**8.8.2. 99% BANDWIDTH**

**LIMITS**

None; for reporting purposes only.

**RESULTS**

Channel	Frequency (MHz)	99% Bandwidth (MHz)
Low	5500	17.5429
Low1	5520	17.4932
Mid	5580	17.5380
High1	5680	17.5589
High	5700	17.5252

**99% BANDWIDTH**

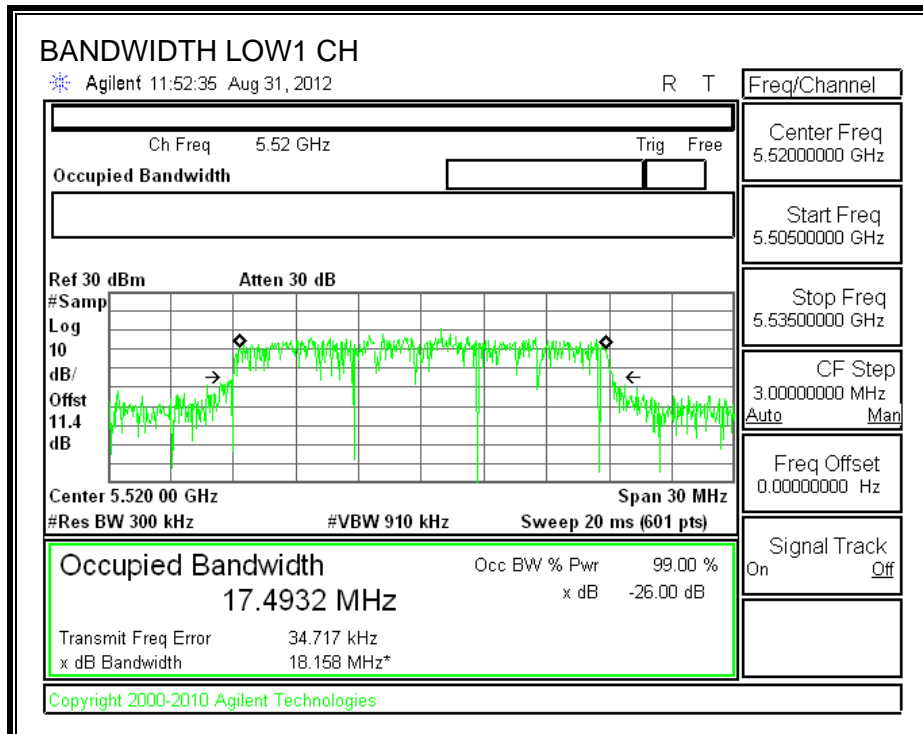
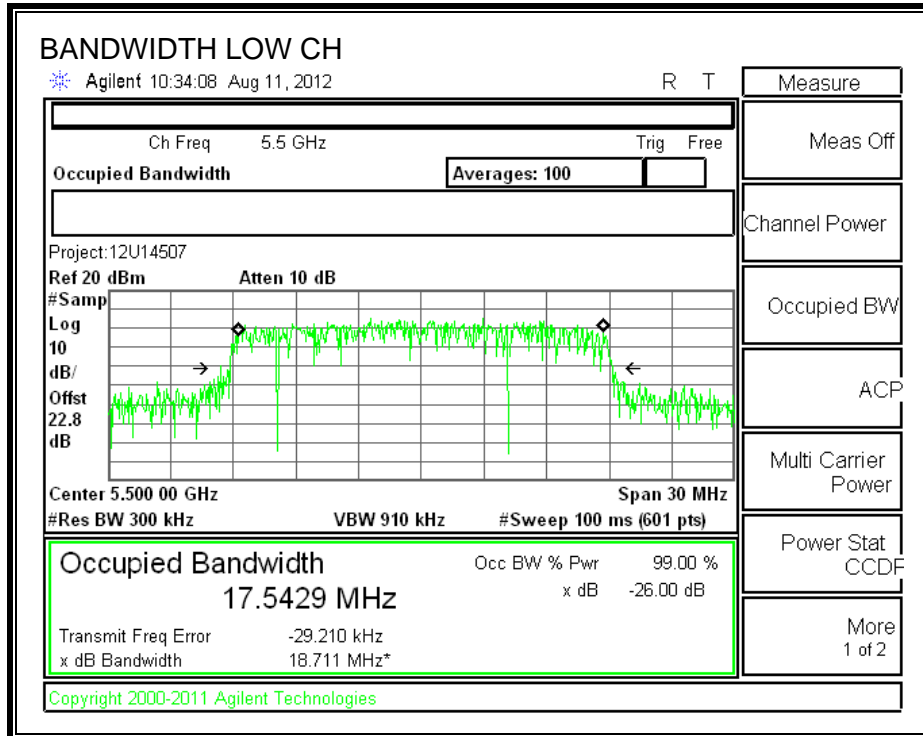



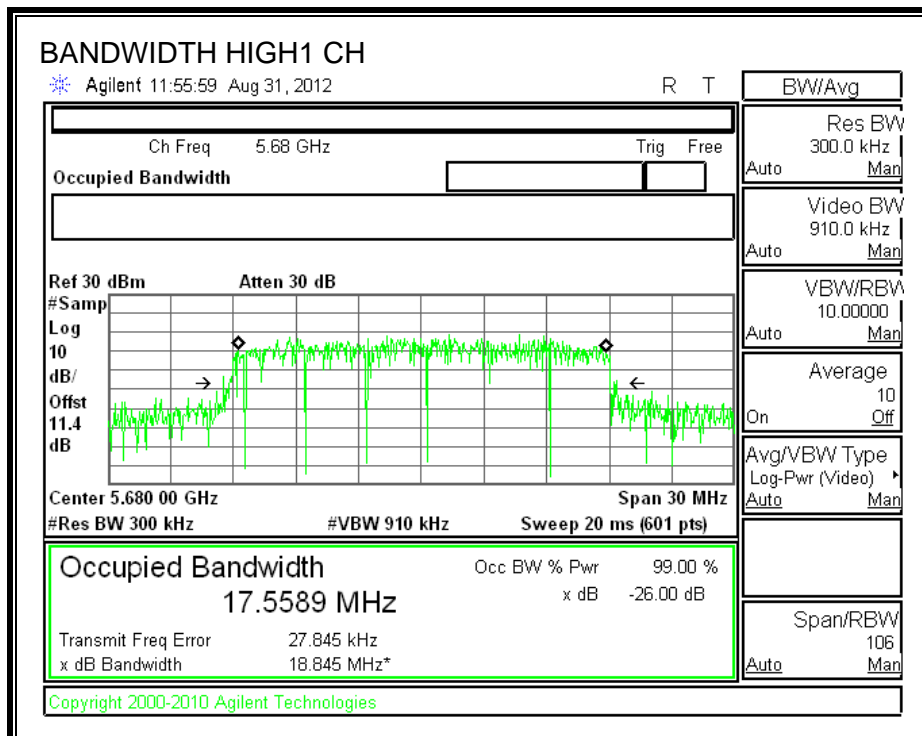
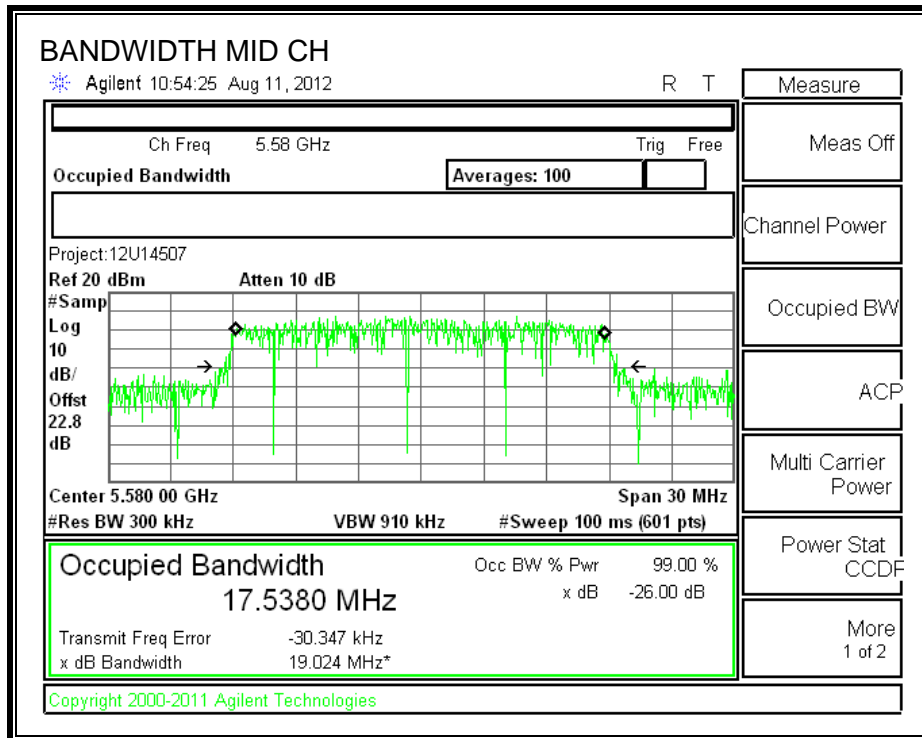

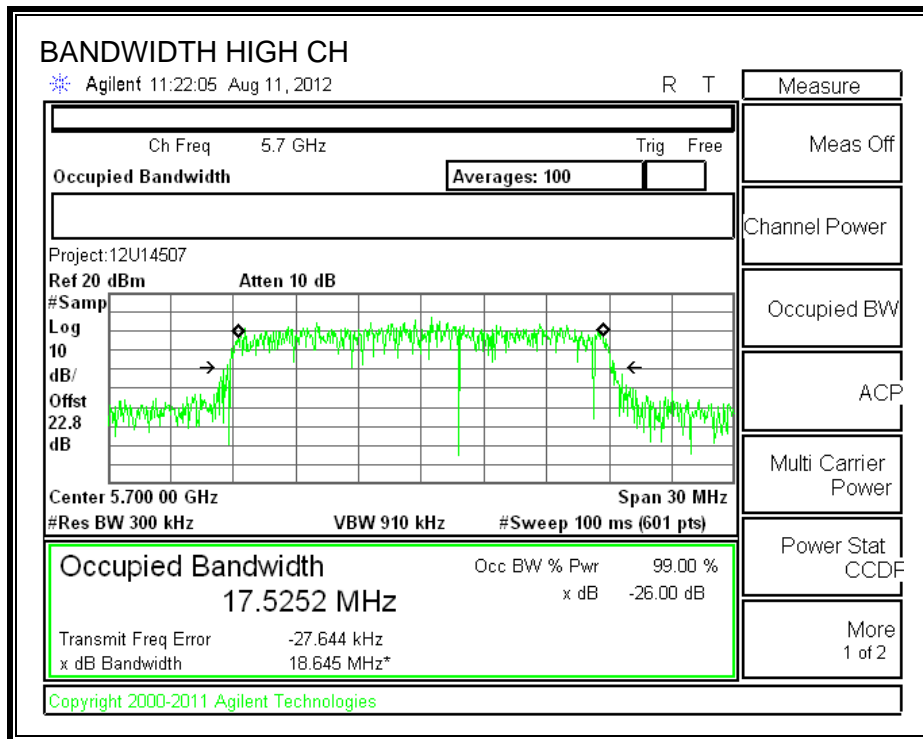

### **8.8.3. AVERAGE POWER**

#### **LIMITS**

None; for reporting purposes only.

#### **TEST PROCEDURE**

The transmitter output is connected to a power meter.

The cable assembly insertion loss of 11.4 dB (including 10 dB pad and 1.4 dB cable) was entered as an offset in the power meter to allow for direct reading of power.

#### **RESULTS**

Channel	Frequency (MHz)	Power (dBm)
Low	5500	14.92
Low1	5520	18.00
Mid	5580	18.00
High1	5680	17.97
High	5700	15.00

---

## **8.8.4. OUTPUT POWER AND PPSD**

### **LIMITS**

FCC §15.407 (a) (2)

IC RSS-210 A9.2 (3)

For the 5.25–5.35 GHz and 5.47–5.725 GHz bands, the maximum conducted output power over the frequency bands of operation shall not exceed the lesser of 250 mW or  $11 \text{ dBm} + 10 \log B$ , where B is the 26 dB emission bandwidth in megahertz. In addition, the peak power spectral density shall not exceed 11 dBm in any 1 megahertz band. If transmitting antennas of directional gain greater than 6 dBi are used, both the maximum conducted output power and the peak power spectral density shall be reduced by the amount in dB that the directional gain of the antenna exceeds 6 dBi.

### **DIRECTIONAL ANTENNA GAIN**

There is only one transmitter output therefore the directional gain is equal to the antenna gain.

**RESULTS**

**Limits FCC15.407**

Channel	Frequency (MHz)	Fixed Limit (dBm)	B (MHz)	11 + 10 Log B Limit (dBm)	Directional Gain (dBi)	Power Limit (dBm)	PPSD Limit (dBm)
Low	5500	24	19.25	23.84	4.51	23.84	11.00
Low1	5520	24	25.25	25.02	4.51	24.00	11.00
Mid	5580	24	25.10	25.00	4.51	24.00	11.00
High1	5680	24	22.67	24.55	4.51	24.00	11.00
High	5700	24	19.15	23.82	4.51	23.82	11.00

**Output Power Results**

Channel	Frequency (MHz)	Meas Power (dBm)	Corr'd Power (dBm)	Power Limit (dBm)	Power Margin (dB)
Low	5500	15.804	15.804	23.84	-8.040
Low1	5520	15.862	18.860	24.00	-5.140
Mid	5580	18.577	18.577	24.00	-5.423
High1	5680	18.879	18.879	24.00	-5.121
High	5700	15.792	15.792	23.82	-8.030

**PPSD Results**

Channel	Frequency (MHz)	Meas PSD (dBm)	Corr'd PSD (dBm)	PPSD Limit (dBm)	PPSD Margin (dB)
Low	5500	5.16	5.16	11.00	-5.84
Low1	5520	8.22	8.22	11.00	-2.78
Mid	5580	7.90	7.90	11.00	-3.10
High1	5680	8.24	8.24	11.00	-2.76
High	5700	5.18	5.18	11.00	-5.82

**IC RSS-210 A9.2(1)**

Channel	Frequency (MHz)	Fixed Limit (dBm)	B 99% (MHz)	11 + 10 Log B Limit (dBm)	Directional Gain (dBi)	Power Limit (dBm)	PPSD Limit (dBm)
Low	5500	24	17.5429	23.4410	4.51	23.4410	11.0000
Low1	5520	24	17.4932	23.4287	4.51	23.4287	11.0000
Mid	5580	24	17.5380	23.4398	4.51	23.4398	11.0000
High1	5680	24	17.5589	23.4450	4.51	23.4450	11.0000
High	5700	24	17.5252	23.4366	4.51	23.4366	11.0000

**Output Power Results**

Channel	Frequency (MHz)	Meas Power (dBm)	Corr'd Power (dBm)	Power Limit (dBm)	Power Margin (dB)
Low	5500	15.804	15.804	23.44	-7.6370
Low1	5520	15.862	15.862	23.43	-7.5667
Mid	5580	18.577	18.577	23.44	-4.8628
High1	5680	18.879	18.879	23.44	-4.5660
High	5700	15.792	15.792	23.44	-7.6446

**PPSD Results**

Channel	Frequency (MHz)	Meas PPSD (dBm)	Corr'd PPSD (dBm)	PPSD Limit (dBm)	PPSD Margin (dB)
Low	5500	5.16	5.16	11.0000	-5.8400
Low1	5520	8.22	8.22	11.0000	-2.7800
Mid	5580	7.90	7.90	11.0000	-3.1000
High1	5680	8.24	8.24	11.0000	-2.7600
High	5700	5.18	5.18	11.0000	-5.8200

**OUTPUT POWER AND PPSD**

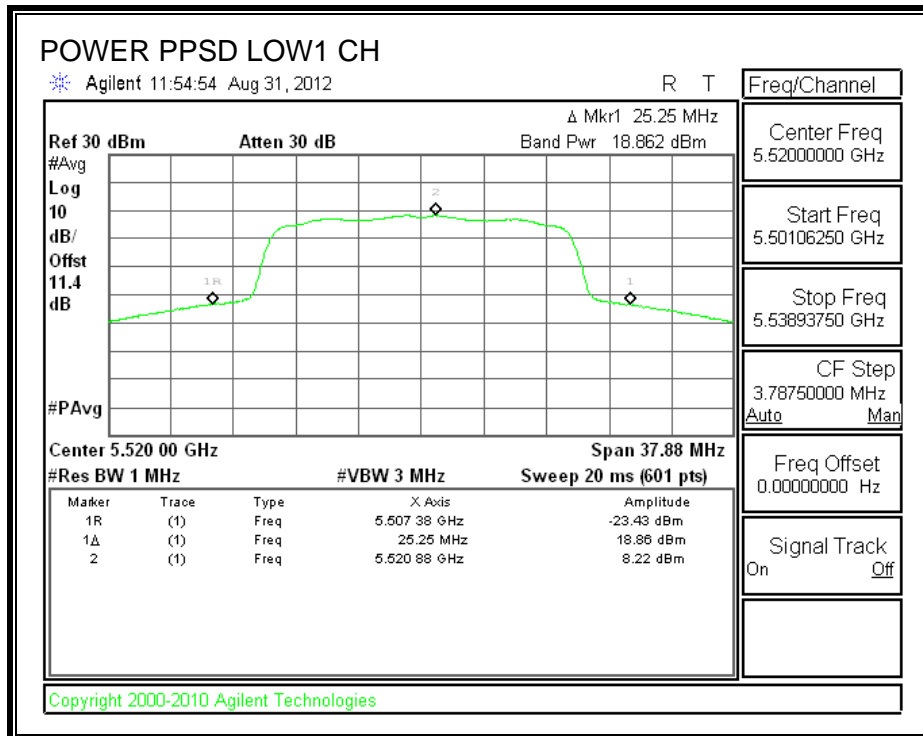
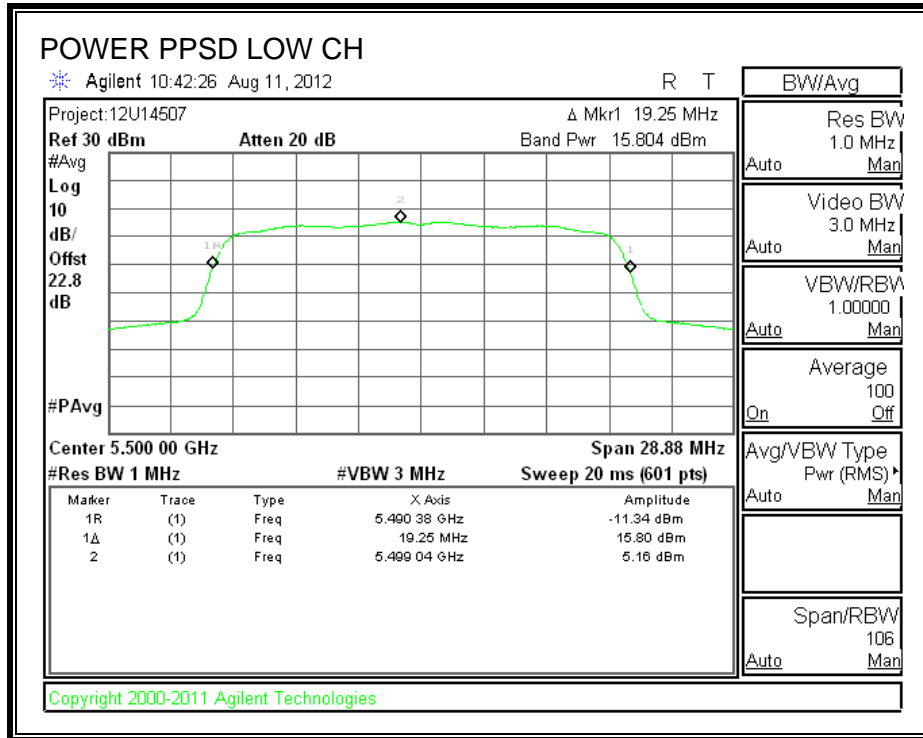

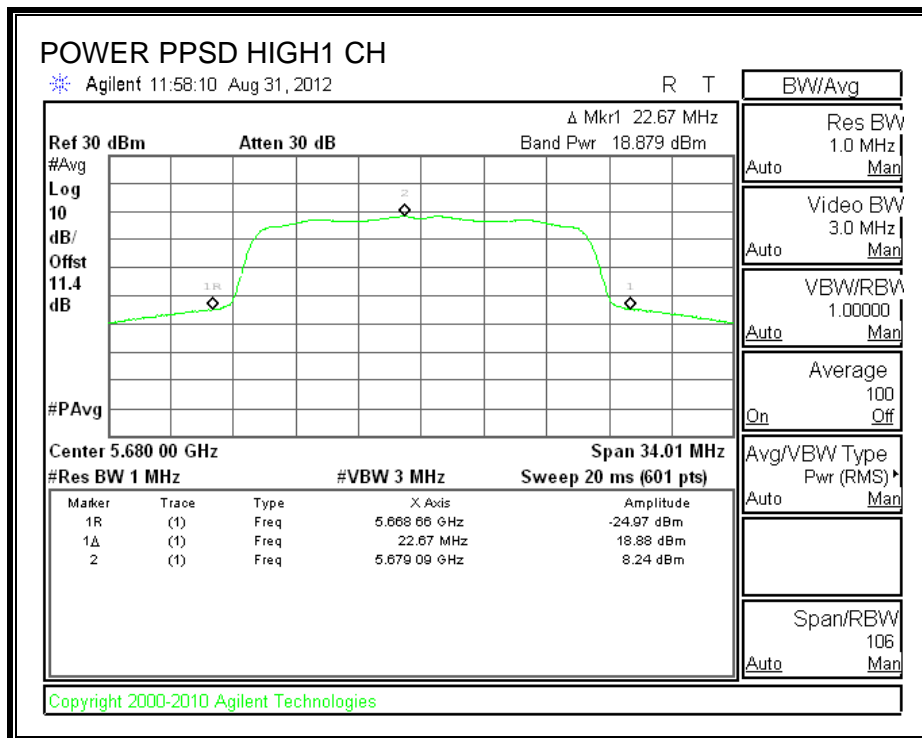
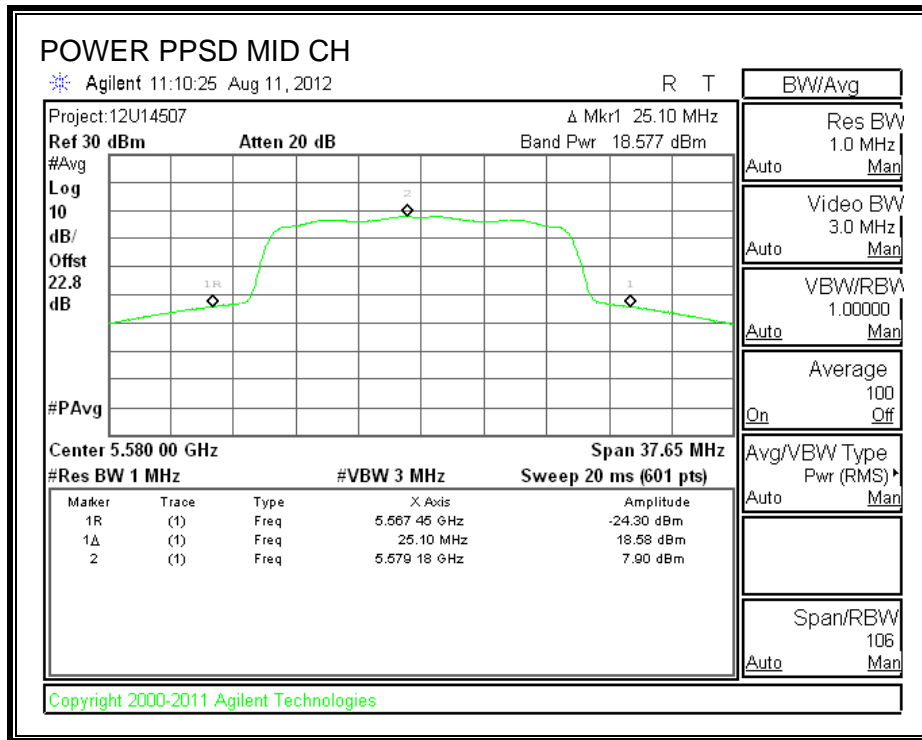



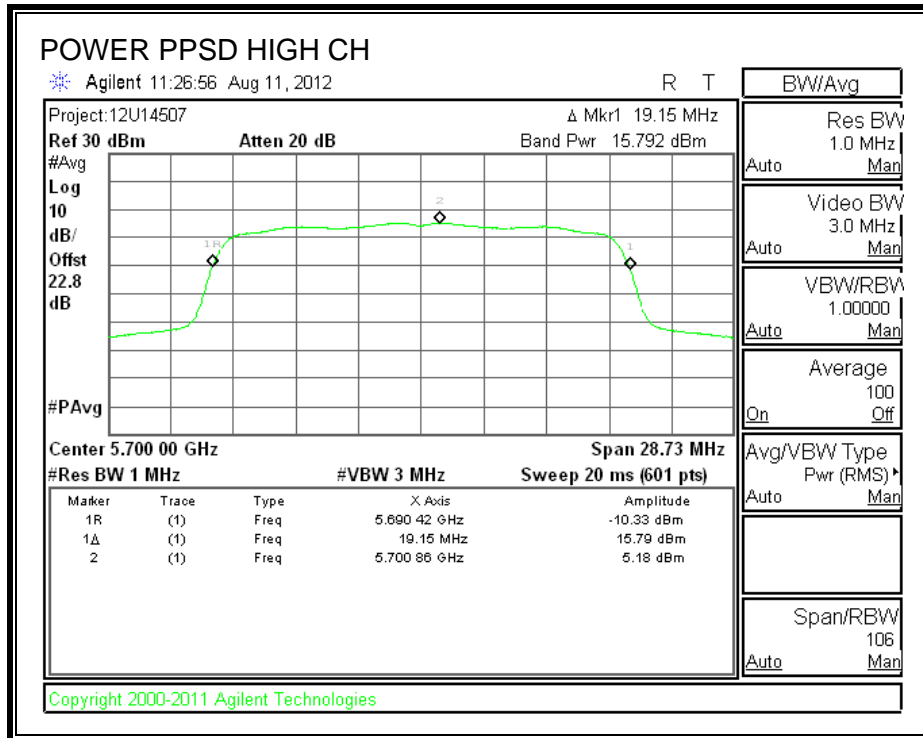

### 8.8.5. PEAK EXCURSION

#### LIMITS

FCC §15.407 (a) (6)

The ratio of the peak excursion of the modulation envelope (measured using a peak hold function) to the peak transmit power (measured as specified above) shall not exceed 13 dB across any 1 MHz bandwidth or the emission bandwidth whichever is less.

#### RESULTS

Channel	Frequency (MHz)	Peak Excursion (dB)	Limit (dB)	Margin (dB)
Low	5500	9.59	13	-3.41
Mid	5580	8.76	13	-4.24
High	5700	9.01	13	-3.99

**PEAK EXCURSION**

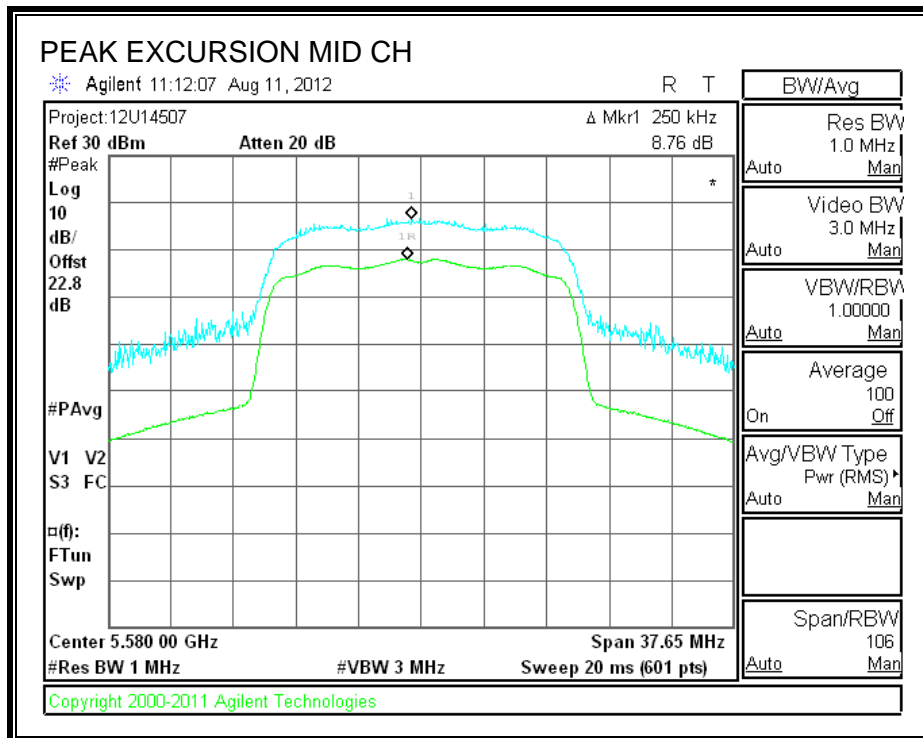
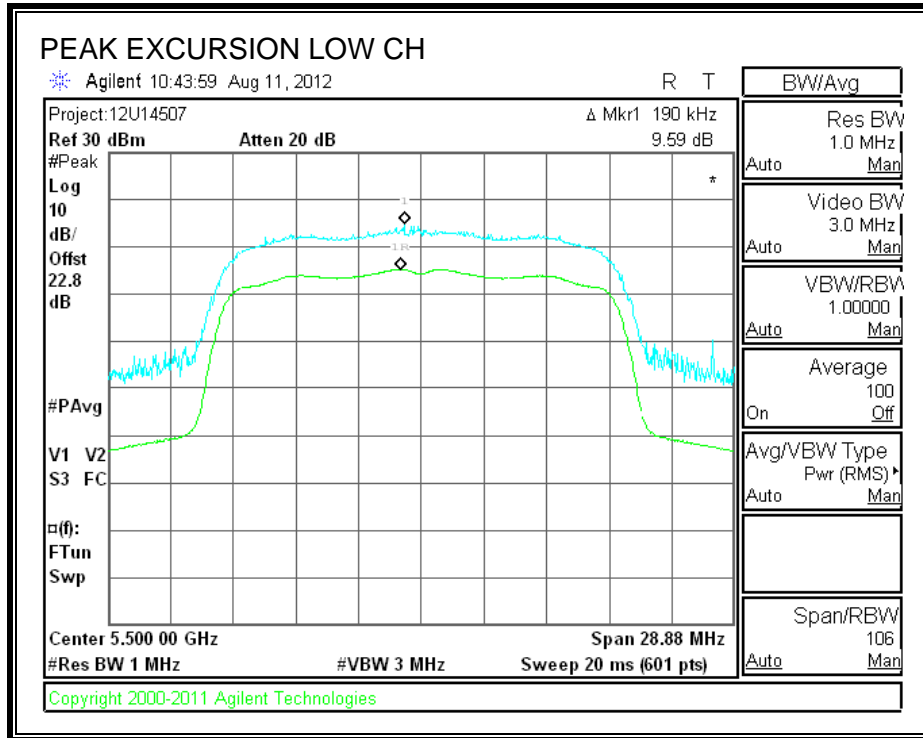

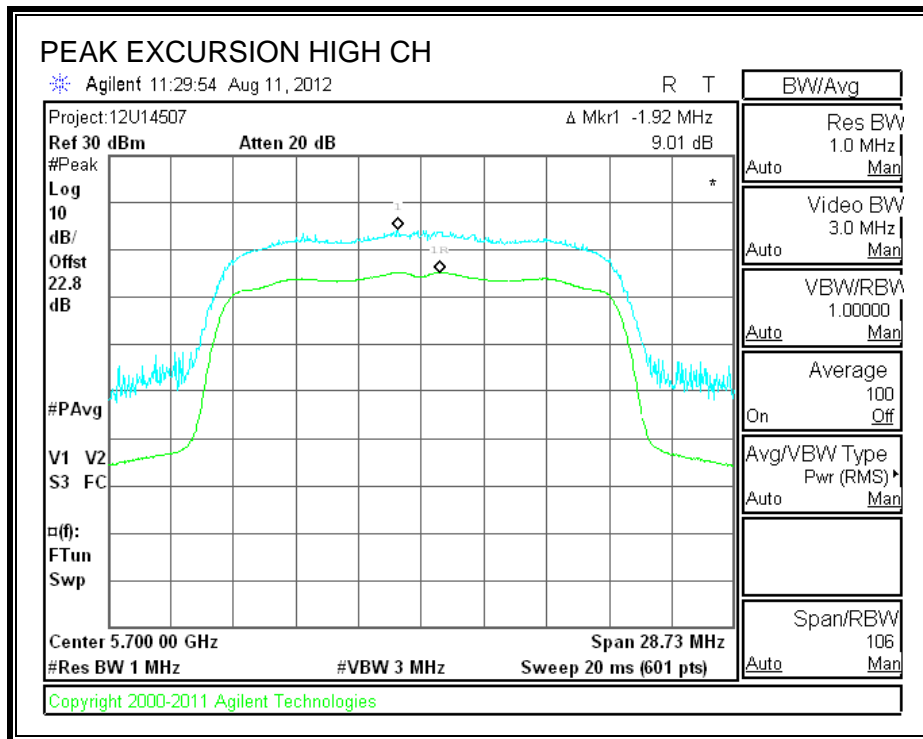

### **8.8.6. TPC POWER**

#### **LIMITS**

FCC §15.407 (h) (1)

IC RSS-210 A9.2 (3)

Transmit power control (TPC). U-NII devices operating in the 5.25–5.35 GHz band and the 5.47–5.725 GHz band shall employ a TPC mechanism. The U-NII device is required to have the capability to operate at least 6 dB below the mean EIRP value of 30 dBm. A TPC mechanism is not required for systems with an e.i.r.p. of less than 500 mW.

#### **DIRECTIONAL ANTENNA GAIN**

There is only one transmitter output therefore the directional gain is equal to the antenna gain.

#### **RESULTS**

EIRP = 18.637 dBm + 4.51 dBi = **23.147 dBm**, which is less than the threshold of 500 mW (27 dBm); therefore, TPC is not required

---

**8.8.7. CONDUCTED WEATHER RADAR BAND EMISSIONS**

Since the EUT is a client device, this test is not required.

## 8.9. 802.11n HT40 MODE IN THE 5.6 GHz BAND

### 8.9.1. 26 dB BANDWIDTH

#### LIMITS

None; for reporting purposes only.

#### RESULTS

Channel	Frequency (MHz)	26 dB Bandwidth (MHz)
Low	5510	45.00
Mid	5550	57.00
High	5670	43.90

**26 dB BANDWIDTH**

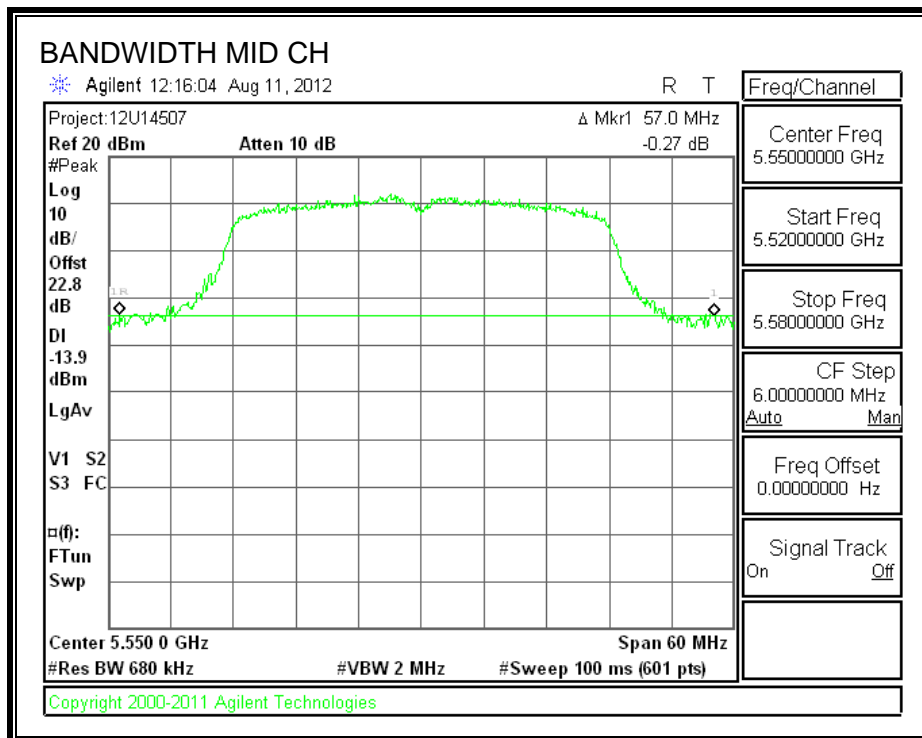
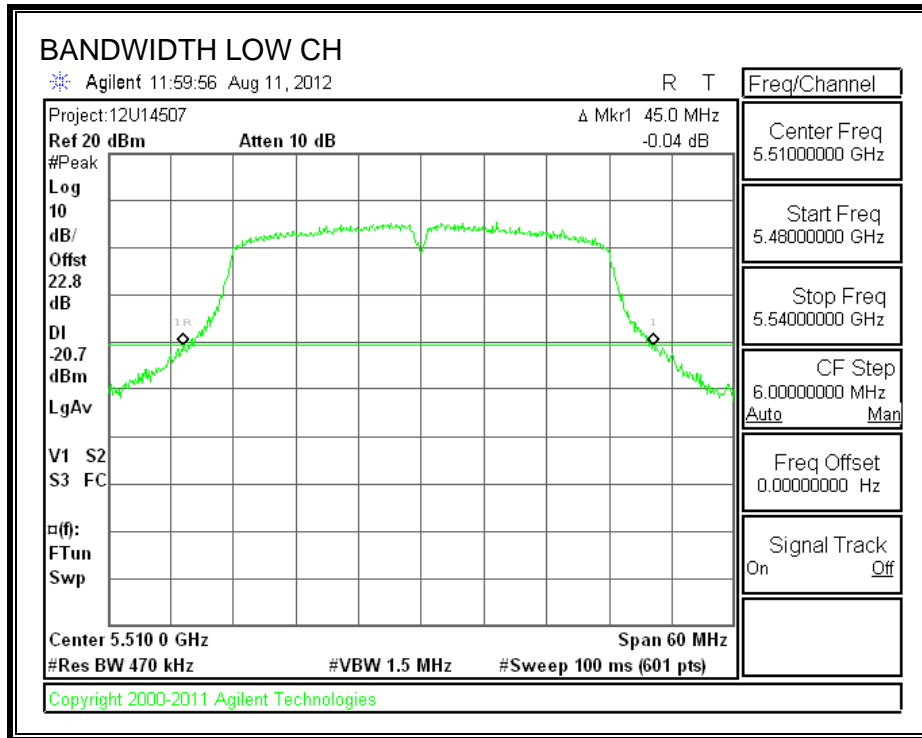



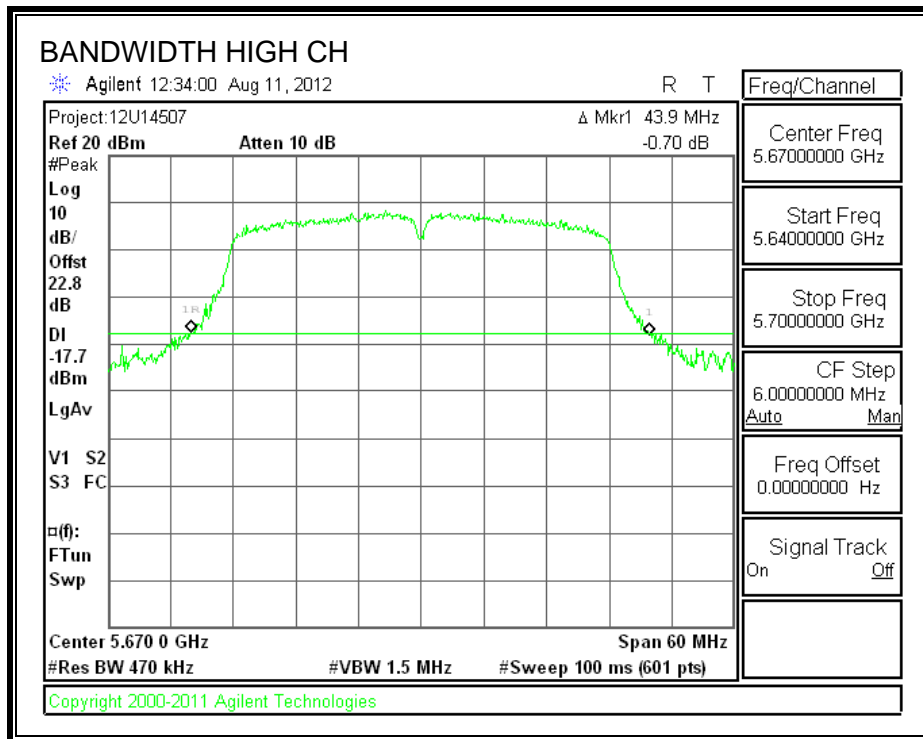

**8.9.2. 99% BANDWIDTH**

**LIMITS**

None; for reporting purposes only.

**RESULTS**

Channel	Frequency (MHz)	99% Bandwidth (MHz)
Low	5510	35.8493
Mid	5550	35.8658
High	5670	35.8122

**99% BANDWIDTH**

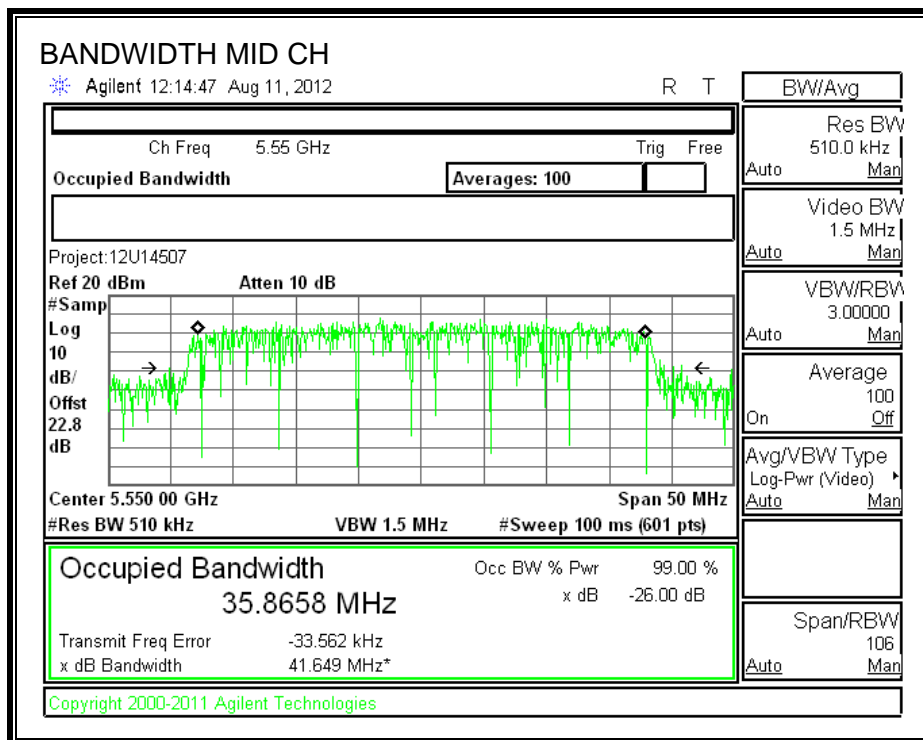
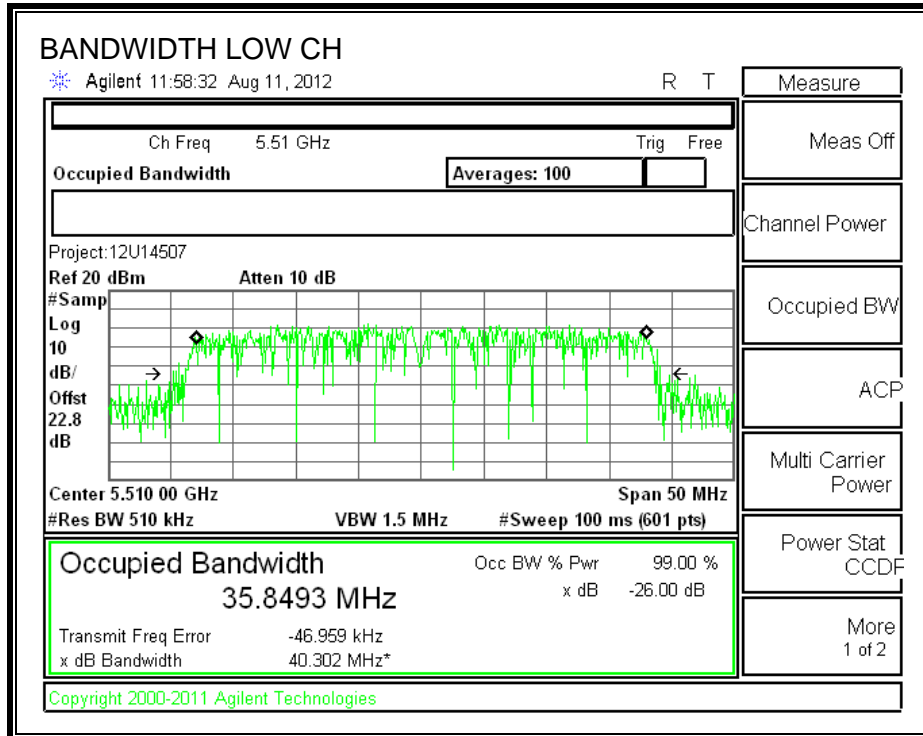

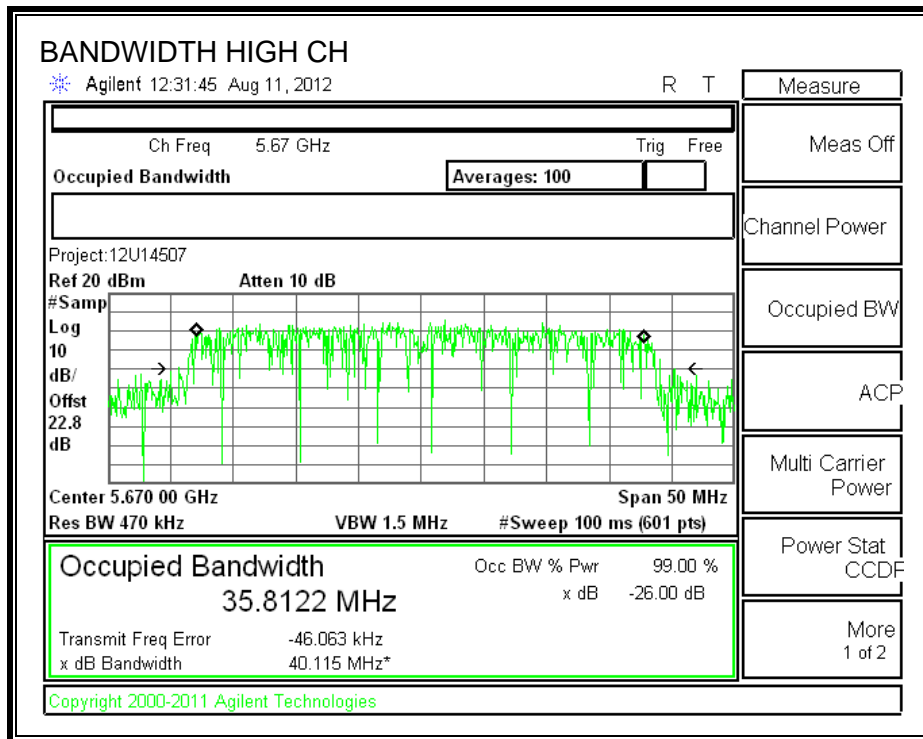

---

### 8.9.3. AVERAGE POWER

#### LIMITS

None; for reporting purposes only.

#### TEST PROCEDURE

The transmitter output is connected to a power meter.

The cable assembly insertion loss of 11.4 dB (including 10 dB pad and 1.4 dB cable) was entered as an offset in the power meter to allow for direct reading of power.

#### RESULTS

Channel	Frequency (MHz)	Power (dBm)
Low	5510	13.0
Mid	5550	18.0
High	5670	16.0

---

## 8.9.4. OUTPUT POWER AND PPSD

### LIMITS

FCC §15.407 (a) (2)

IC RSS-210 A9.2 (3)

For the 5.25–5.35 GHz and 5.47–5.725 GHz bands, the maximum conducted output power over the frequency bands of operation shall not exceed the lesser of 250 mW or  $11 \text{ dBm} + 10 \log B$ , where B is the 26 dB emission bandwidth in megahertz. In addition, the peak power spectral density shall not exceed 11 dBm in any 1 megahertz band. If transmitting antennas of directional gain greater than 6 dBi are used, both the maximum conducted output power and the peak power spectral density shall be reduced by the amount in dB that the directional gain of the antenna exceeds 6 dBi.

### DIRECTIONAL ANTENNA GAIN

There is only one transmitter output therefore the directional gain is equal to the antenna gain.

**RESULTS**

**Limits FCC15.407**

Channel	Frequency (MHz)	Fixed Limit (dBm)	B (MHz)	11 + 10 Log B Limit (dBm)	Directional Gain (dBi)	Power Limit (dBm)	PPSD Limit (dBm)
Low	5510	24	45.00	27.53	4.51	24.00	11.00
Mid	5550	24	57.00	28.56	4.51	24.00	11.00
High	5670	24	43.90	27.42	4.51	24.00	11.00

**Output Power Results**

Channel	Frequency (MHz)	Meas Power (dBm)	Corr'd Power (dBm)	Power Limit (dBm)	Power Margin (dB)
Low	5510	14.029	14.029	24.00	-9.971
Mid	5550	18.531	18.531	24.00	-5.469
High	5670	16.628	16.628	24.00	-7.372

**PPSD Results**

Channel	Frequency (MHz)	Meas PPSD (dBm)	Corr'd PPSD (dBm)	PPSD Limit (dBm)	PPSD Margin (dB)
Low	5510	-0.01	-0.01	11.00	-11.01
Mid	5550	4.42	4.42	11.00	-6.58
High	5670	2.60	2.60	11.00	-8.40

**IC RSS-210 A9.2(1)**

Channel	Frequency (MHz)	Fixed Limit (dBm)	B 99% (MHz)	11 + 10 Log B Limit (dBm)	Directional Gain (dBi)	Power Limit (dBm)	PPSD Limit (dBm)
Low	5510	24	35.8493	26.5448	4.51	24.0000	11.0000
Mid	5550	24	35.8658	26.5468	4.51	24.0000	11.0000
High	5670	24	35.8122	26.5403	4.51	24.0000	11.0000

**Output Power Results**

Channel	Frequency (MHz)	Meas Power (dBm)	Corr'd Power (dBm)	Power Limit (dBm)	Power Margin (dB)
Low	5510	14.029	14.029	24.0000	-9.9710
Mid	5550	18.531	18.531	24.0000	-5.4690
High	5670	16.628	16.628	24.0000	-7.3720

**PPSD Results**

Channel	Frequency (MHz)	Meas PPSD (dBm)	Corr'd PPSD (dBm)	PPSD Limit (dBm)	PPSD Margin (dB)
Low	5510	-0.01	-0.01	11.0000	-11.0100
Mid	5550	4.42	4.42	11.0000	-6.5800
High	5670	2.60	2.60	11.0000	-8.4000



**OUTPUT POWER AND PPSD**

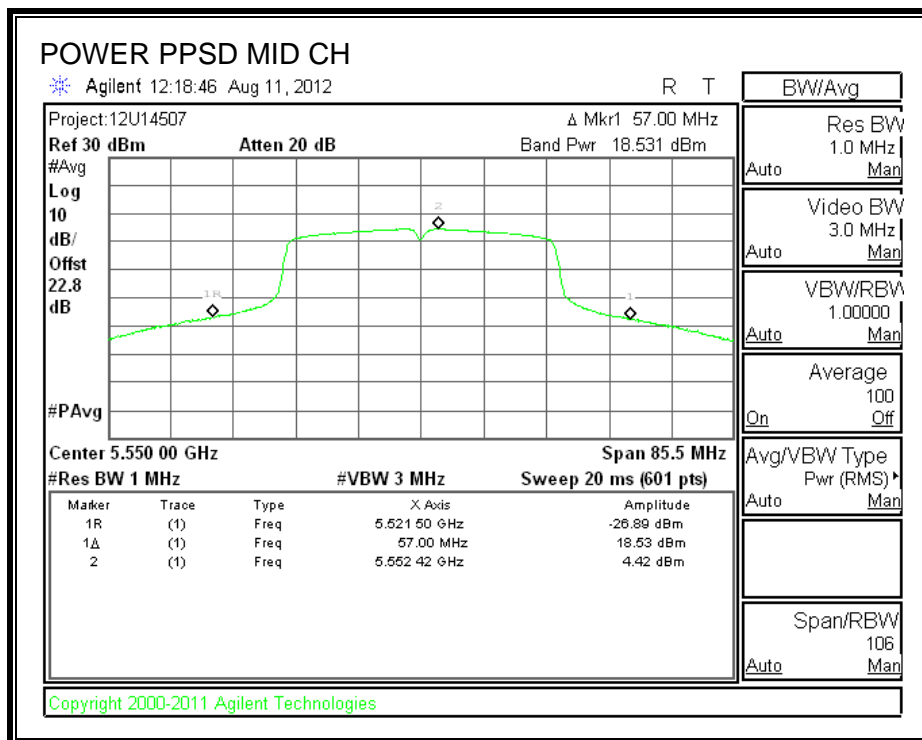
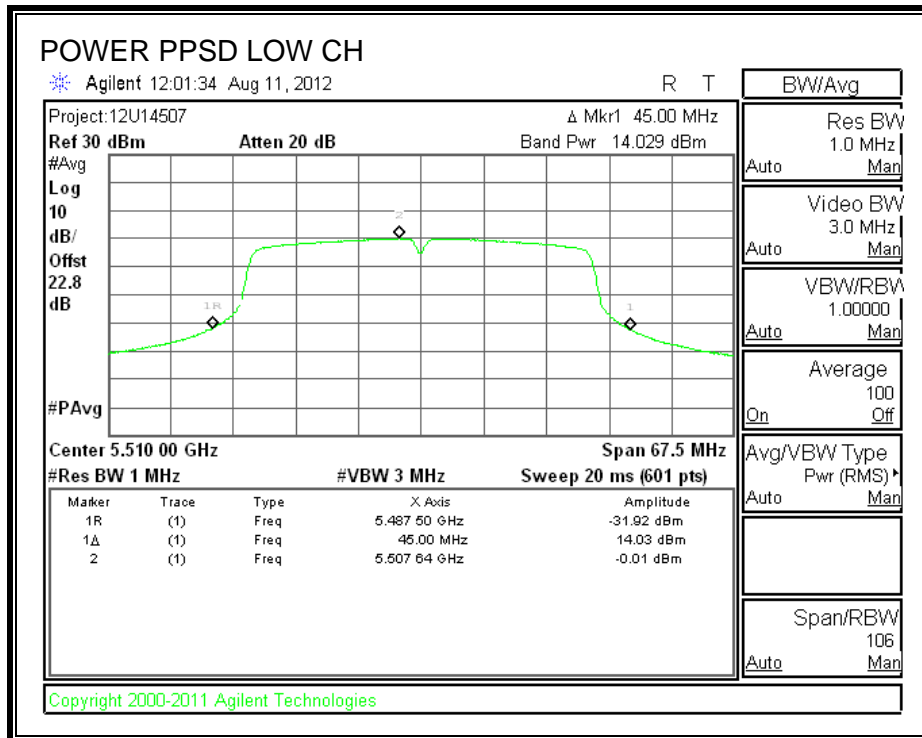

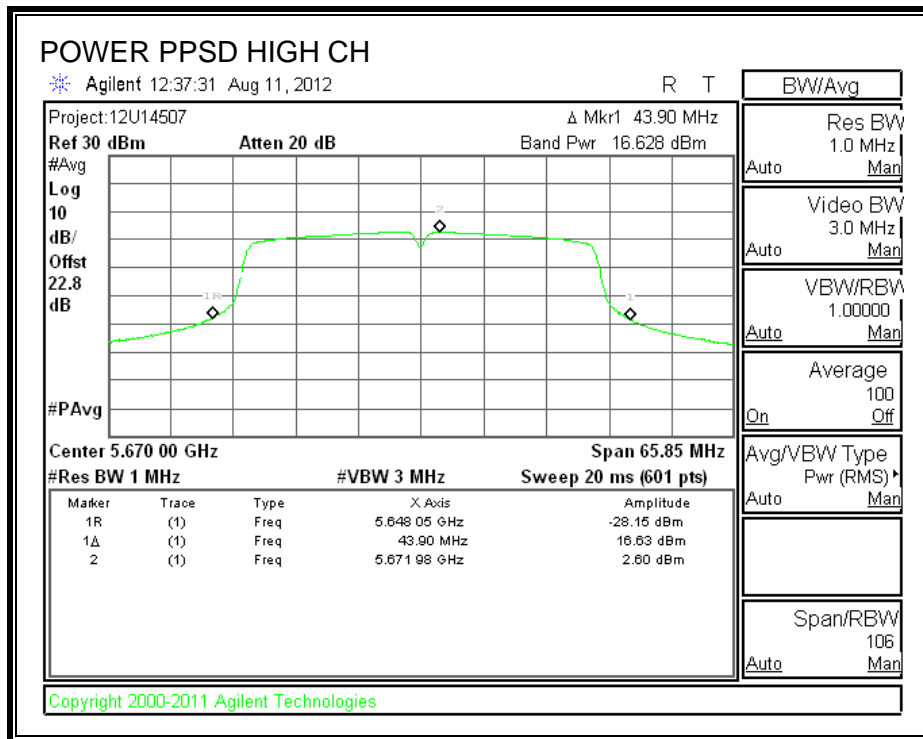

### 8.9.5. PEAK EXCURSION

#### LIMITS

FCC §15.407 (a) (6)

The ratio of the peak excursion of the modulation envelope (measured using a peak hold function) to the peak transmit power (measured as specified above) shall not exceed 13 dB across any 1 MHz bandwidth or the emission bandwidth whichever is less.

#### RESULTS

Channel	Frequency (MHz)	Peak Excursion (dB)	Limit (dB)	Margin (dB)
Low	5510	9.35	13	-3.65
Mid	5550	10.12	13	-2.88
High	5670	9.77	13	-3.23

**PEAK EXCURSION**

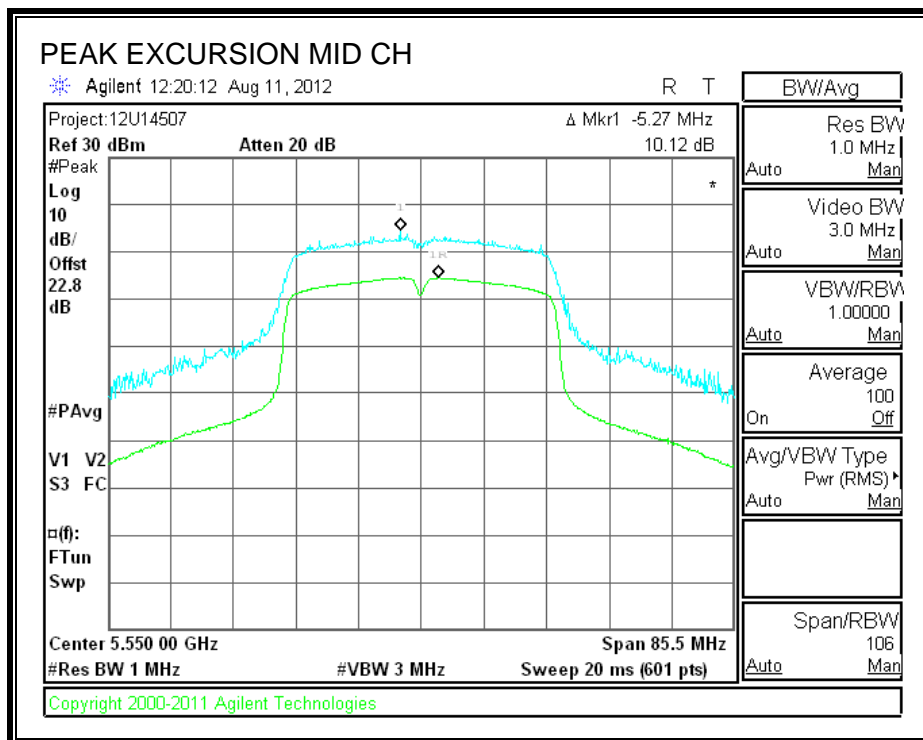
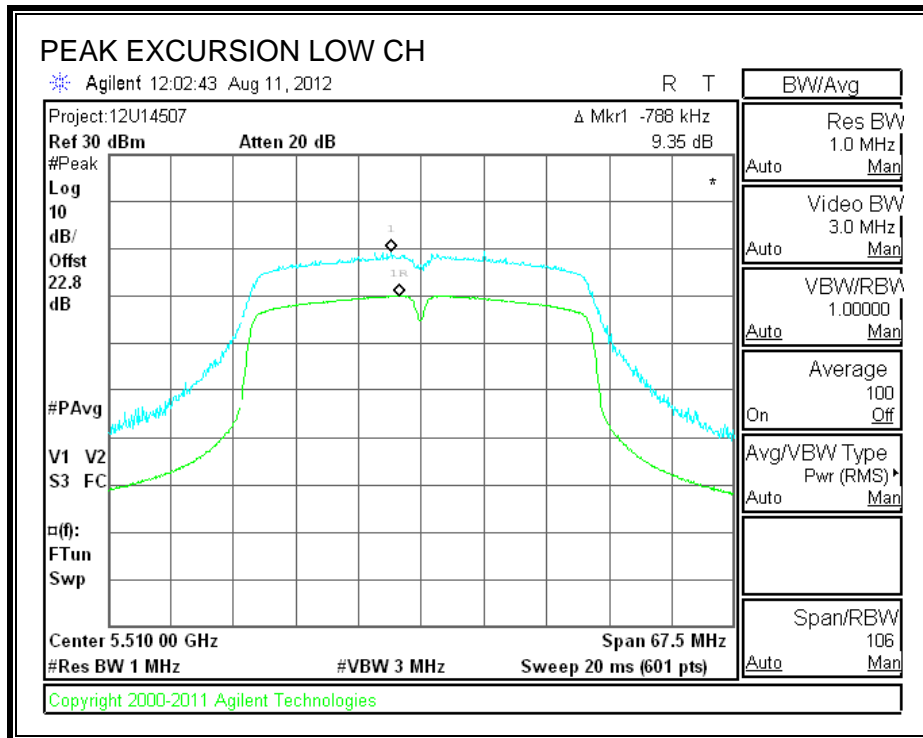

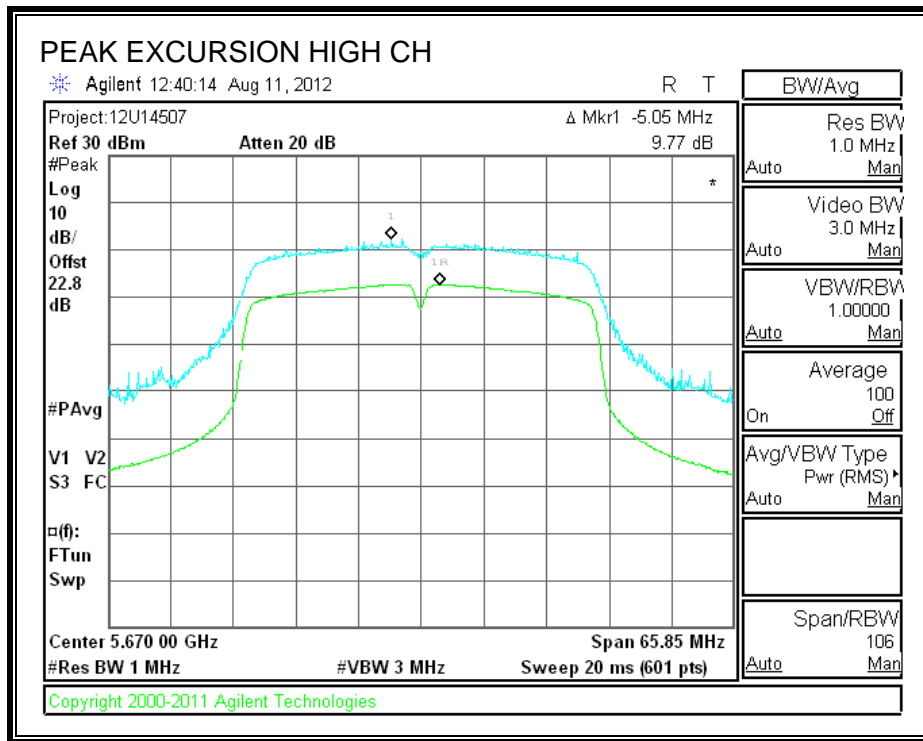

### **8.9.6. TPC POWER**

#### **LIMITS**

FCC §15.407 (h) (1)

IC RSS-210 A9.2 (3)

Transmit power control (TPC). U-NII devices operating in the 5.25–5.35 GHz band and the 5.47–5.725 GHz band shall employ a TPC mechanism. The U-NII device is required to have the capability to operate at least 6 dB below the mean EIRP value of 30 dBm. A TPC mechanism is not required for systems with an e.i.r.p. of less than 500 mW.

#### **DIRECTIONAL ANTENNA GAIN**

There is only one transmitter output therefore the directional gain is equal to the antenna gain.

#### **RESULTS**

EIRP = 18.661 dBm + 4.51 dBi = **23.171 dBm**, which is less than the threshold of 500 mW (27 dBm); therefore, TPC is not required

---

### **8.9.7. CONDUCTED WEATHER RADAR BAND EMISSIONS**

Since the EUT is a client device, this test is not required.

## 9. RADIATED TEST RESULTS

### 9.1. LIMITS AND PROCEDURE

#### LIMITS

FCC §15.205 and §15.209

IC RSS-210 Clause 2.6 (Transmitter)

IC RSS-GEN Clause 6 (Receiver)

Frequency Range (MHz)	Field Strength Limit (uV/m) at 3 m	Field Strength Limit (dBuV/m) at 3 m
30 - 88	100	40
88 - 216	150	43.5
216 - 960	200	46
Above 960	500	54

#### TEST PROCEDURE

The EUT is placed on a non-conducting table 80 cm above the ground plane. The antenna to EUT distance is 3 meters.

For measurements below 1 GHz the resolution bandwidth is set to 100 kHz for peak detection measurements or 120 kHz for quasi-peak detection measurements. Peak detection is used unless otherwise noted as quasi-peak.

For measurements above 1 GHz the resolution bandwidth is set to 1 MHz; the video bandwidth is set to 1 MHz for peak measurements and as applicable for average measurements.

The spectrum from 30 MHz to 40 GHz is investigated with the transmitter set to the lowest, middle, and highest channels in each applicable band.

The frequency range of interest is monitored at a fixed antenna height and EUT azimuth. The EUT is rotated through 360 degrees to maximize emissions received. The antenna is scanned from 1 to 4 meters above the ground plane to further maximize the emission. Measurements are made with the antenna polarized in both the vertical and the horizontal positions.



## 9.2. TRANSMITTER ABOVE 1 GHz

### 9.2.1. TX ABOVE 1 GHz 802.11a MODE IN THE 5.2 GHz BAND

#### RESTRICTED BANDEDGE (LOW CHANNEL)

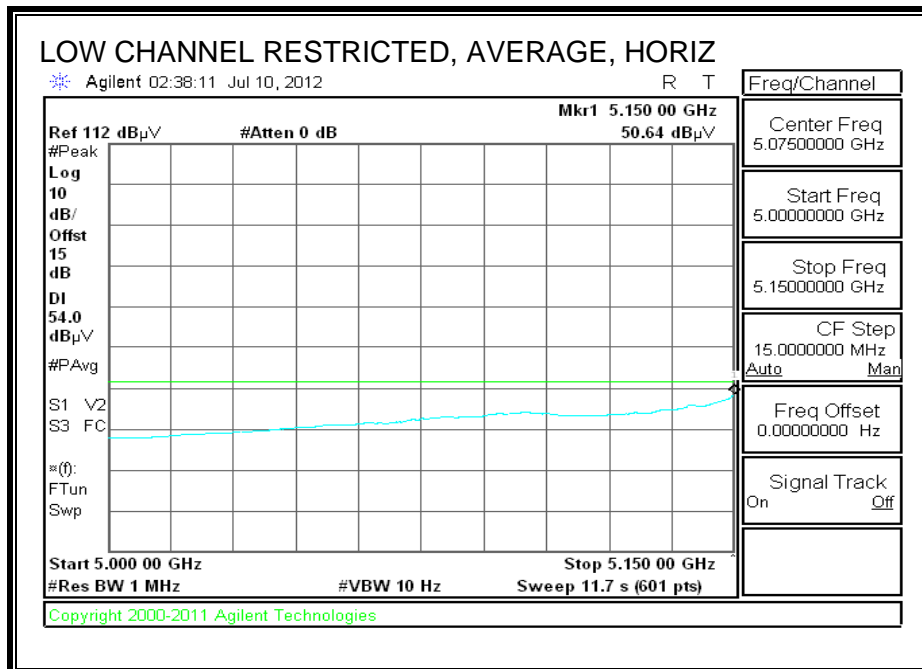
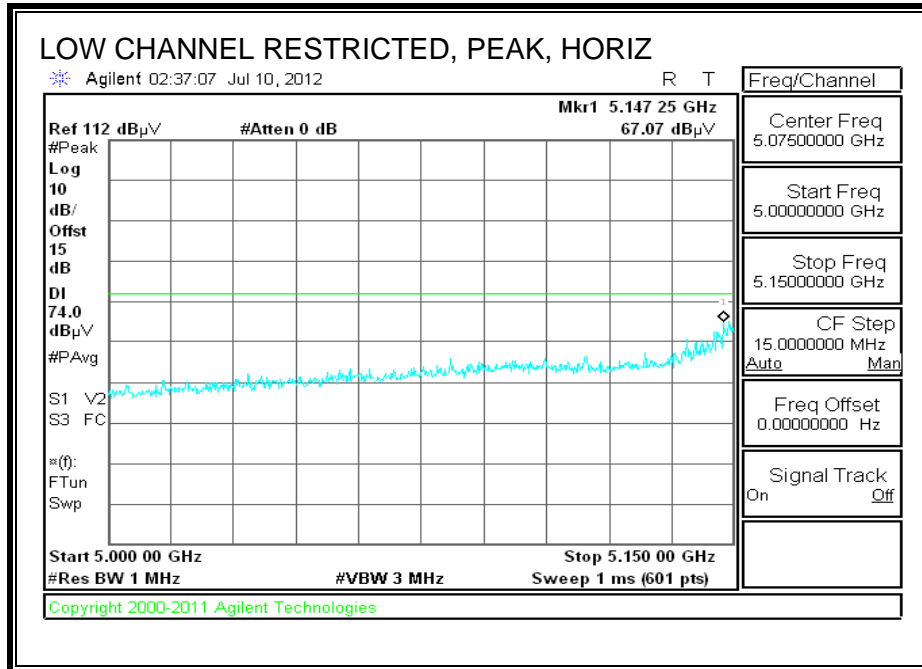

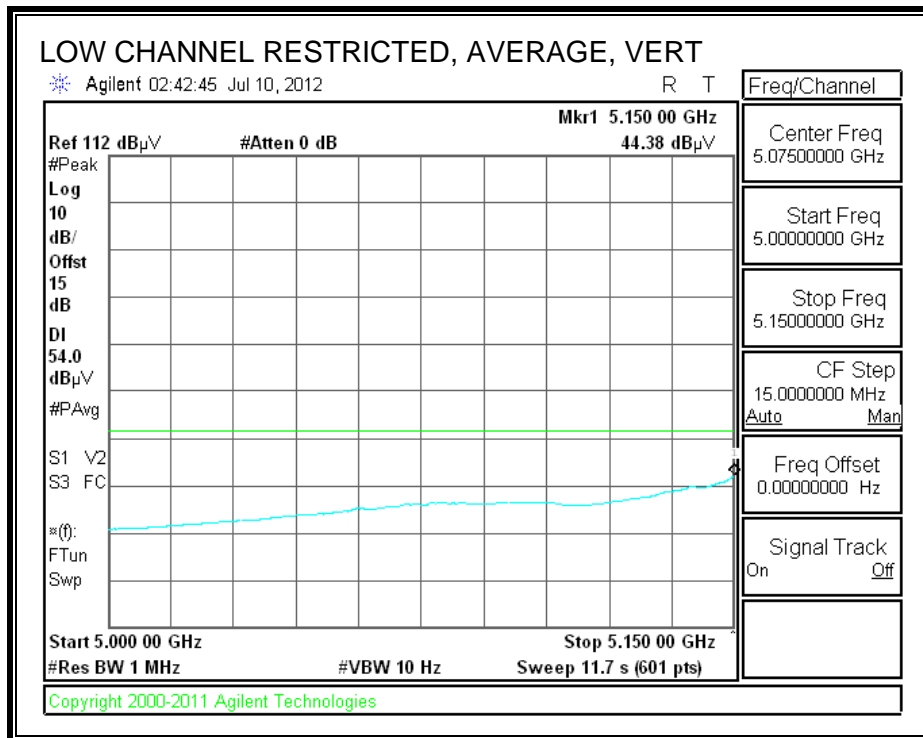
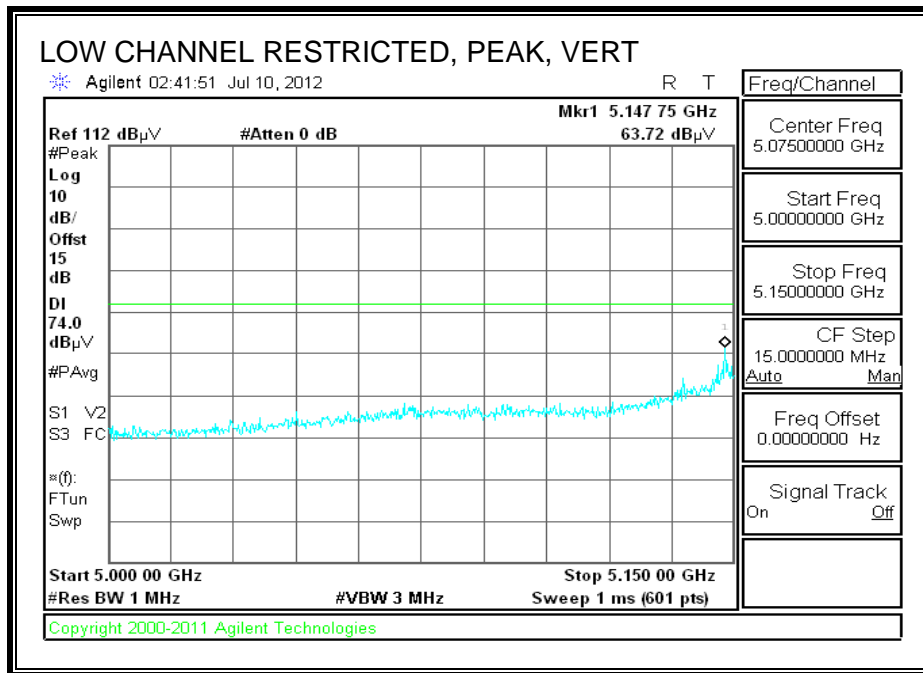

**HARMONICS AND SPURIOUS EMISSIONS**

**High Frequency Measurement  
 Compliance Certification Services, Fremont 5m Chamber**

Test Engr: Chin Pang  
 Date: 08/06/12  
 Project #: 12U14507  
 Company: Apple  
 Test Target: FCC 15.407  
 Mode Oper: TX, a mode, 5.2GHz

f Measurement Frequency Amp Preamp Gain Average Field Strength Limit  
 Dist Distance to Antenna D Corr Distance Correct to 3 meters Peak Field Strength Limit  
 Read Analyzer Reading Avg Average Field Strength @ 3 m Margin vs. Average Limit  
 AF Antenna Factor Peak Calculated Peak Field Strength Margin vs. Peak Limit  
 CL Cable Loss HPF High Pass Filter

f GHz	Dist (m)	Read dBuV	AF dB/m	CL dB	Amp dB	D Corr dB	Filtr dB	Corr. dBuV/m	Limit dBuV/m	Margin dB	Ant. Pol. V/H	Det. P/A/QP	Notes
<b>Low Ch. 5180MHz</b>													
15.540	3.0	35.0	39.0	12.5	-34.0	0.0	0.7	53.2	74.0	-20.8	V	P	
15.540	3.0	23.0	39.0	12.5	-34.0	0.0	0.7	41.2	54.0	-12.8	V	A	
15.540	3.0	36.0	39.0	12.5	-34.0	0.0	0.7	54.2	74.0	-19.8	H	P	
15.540	3.0	22.5	39.0	12.5	-34.0	0.0	0.7	40.7	54.0	-13.3	H	A	
<b>Mid Ch. 5200MHz</b>													
15.600	3.0	35.2	38.8	12.5	-34.0	0.0	0.7	53.3	74.0	-20.7	V	P	
15.600	3.0	22.4	38.8	12.5	-34.0	0.0	0.7	40.4	54.0	-13.6	V	A	
15.600	3.0	34.8	38.8	12.5	-34.0	0.0	0.7	52.9	74.0	-21.1	H	P	
15.600	3.0	22.4	38.8	12.5	-34.0	0.0	0.7	40.5	54.0	-13.5	H	A	
<b>High Ch. 5240MHz</b>													
15.720	3.0	35.3	38.4	12.6	-34.0	0.0	0.7	53.0	74.0	-21.0	V	P	
15.720	3.0	22.1	38.4	12.6	-34.0	0.0	0.7	39.8	54.0	-14.2	V	A	
15.720	3.0	35.1	38.4	12.6	-34.0	0.0	0.7	52.9	74.0	-21.1	H	P	
15.720	3.0	22.1	38.4	12.6	-34.0	0.0	0.7	39.8	54.0	-14.2	H	A	

Rev. 4.1.2.7

Note: No other emissions were detected above the system noise floor.

**9.2.2. TX ABOVE 1 GHz 802.11n HT20 MODE IN THE 5.2 GHz BAND**

**RESTRICTED BANDEDGE (LOW CHANNEL)**

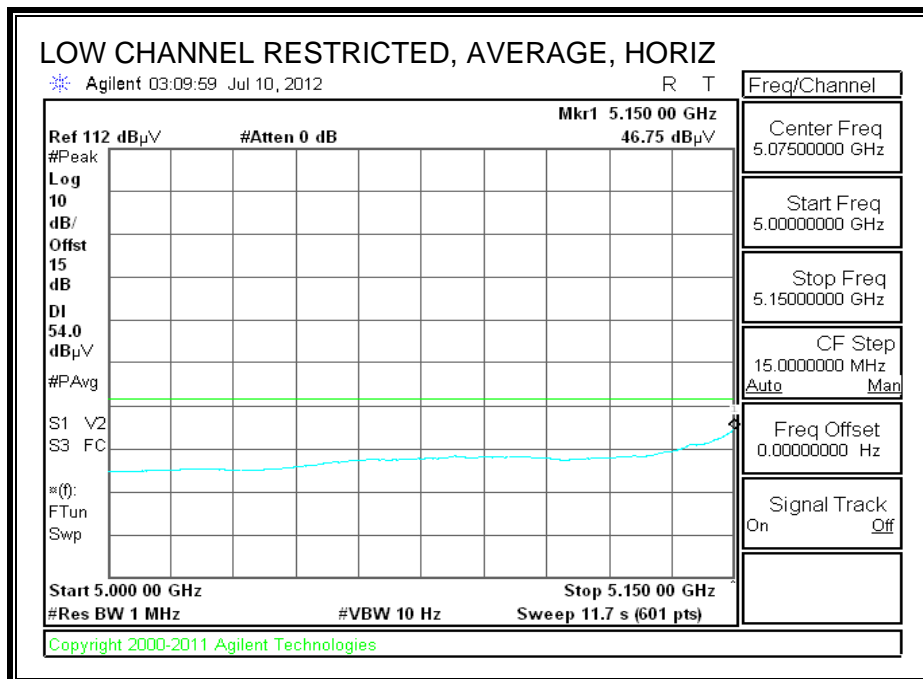
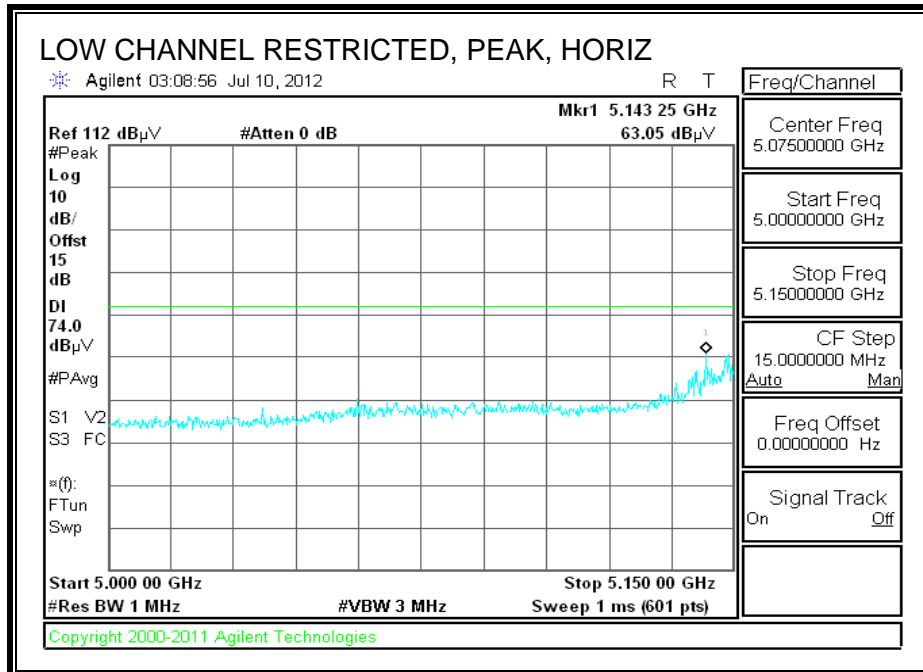

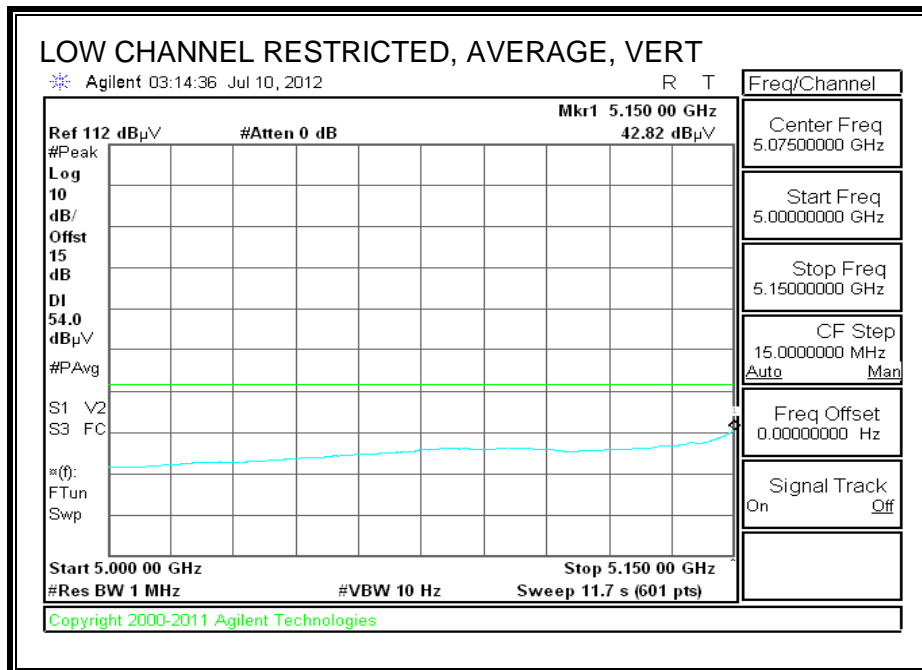
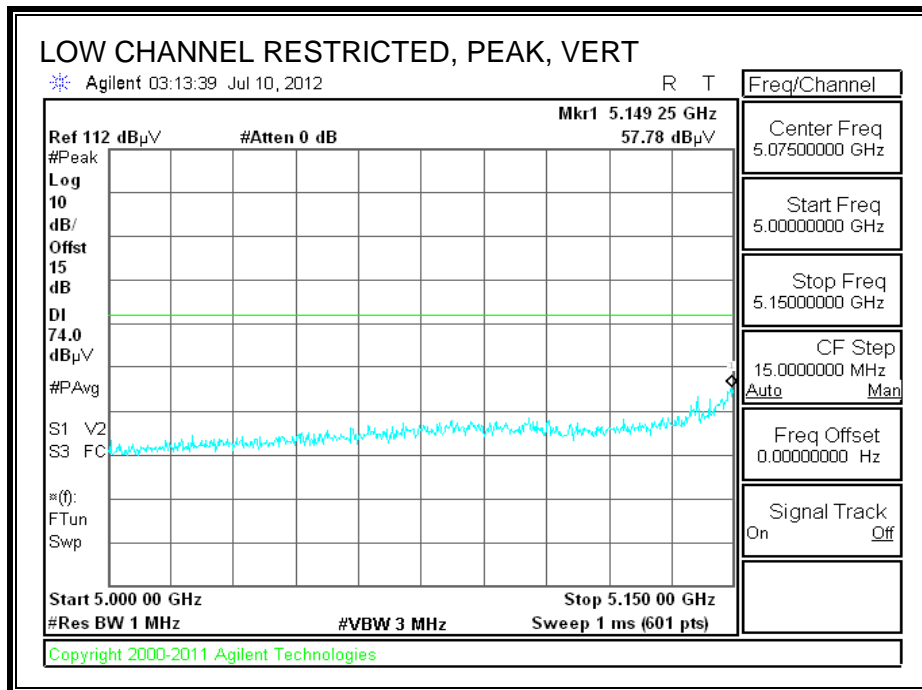

**HARMONICS AND SPURIOUS EMISSIONS**

**High Frequency Measurement  
 Compliance Certification Services, Fremont 5m Chamber**

Test Engr: Chin Pang  
 Date: 08/06/12  
 Project #: 12U14507  
 Company: Apple  
 Test Target: FCC 15.407  
 Mode Oper: HT20, TX, 5.2GHz

f Measurement Frequency Amp Preamp Gain Average Field Strength Limit  
 Dist Distance to Antenna D Corr Distance Correct to 3 meters Peak Field Strength Limit  
 Read Analyzer Reading Avg Average Field Strength @ 3 m Margin vs. Average Limit  
 AF Antenna Factor Peak Calculated Peak Field Strength Margin vs. Peak Limit  
 CL Cable Loss HPF High Pass Filter

f GHz	Dist (m)	Read dBuV	AF dB/m	CL dB	Amp dB	D Corr dB	Filtr dB	Corr. dBuV/m	Limit dBuV/m	Margin dB	Ant. Pol. V/H	Det. P/A/QP	Notes
<b>Low Ch. 5180MHz</b>													
15.540	3.0	35.7	39.0	12.5	-34.0	0.0	0.7	53.9	74.0	-20.1	H	P	
15.540	3.0	22.6	39.0	12.5	-34.0	0.0	0.7	40.8	54.0	-13.2	H	A	
15.540	3.0	35.4	39.0	12.5	-34.0	0.0	0.7	53.6	74.0	-20.4	V	P	
15.540	3.0	22.6	39.0	12.5	-34.0	0.0	0.7	40.8	54.0	-13.2	V	A	
<b>Mid Ch. 5200MHz</b>													
15.600	3.0	35.7	38.8	12.5	-34.0	0.0	0.7	53.7	74.0	-20.3	H	P	
15.600	3.0	22.4	38.8	12.5	-34.0	0.0	0.7	40.4	54.0	-13.6	H	A	
15.600	3.0	34.8	38.8	12.5	-34.0	0.0	0.7	52.8	74.0	-21.2	V	P	
15.600	3.0	22.3	38.8	12.5	-34.0	0.0	0.7	40.4	54.0	-13.6	V	A	
<b>High Ch. 5240MHz</b>													
15.720	3.0	35.0	38.4	12.6	-34.0	0.0	0.7	52.7	74.0	-21.3	H	P	
15.720	3.0	22.1	38.4	12.6	-34.0	0.0	0.7	39.9	54.0	-14.1	H	A	
15.720	3.0	34.4	38.4	12.6	-34.0	0.0	0.7	52.1	74.0	-21.9	V	P	
15.720	3.0	22.1	38.4	12.6	-34.0	0.0	0.7	39.8	54.0	-14.2	V	A	

Rev. 4.1.2.7

Note: No other emissions were detected above the system noise floor.

### 9.2.3. TX ABOVE 1 GHz 802.11n HT40 MODE IN THE 5.2 GHz BAND

#### RESTRICTED BANEDGE (LOW CHANNEL)

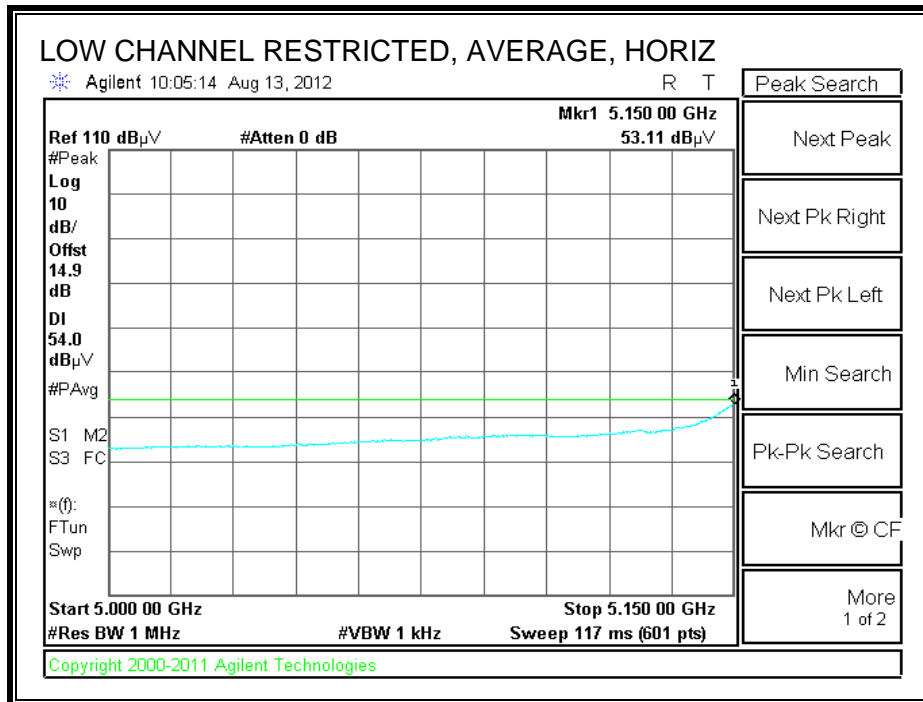
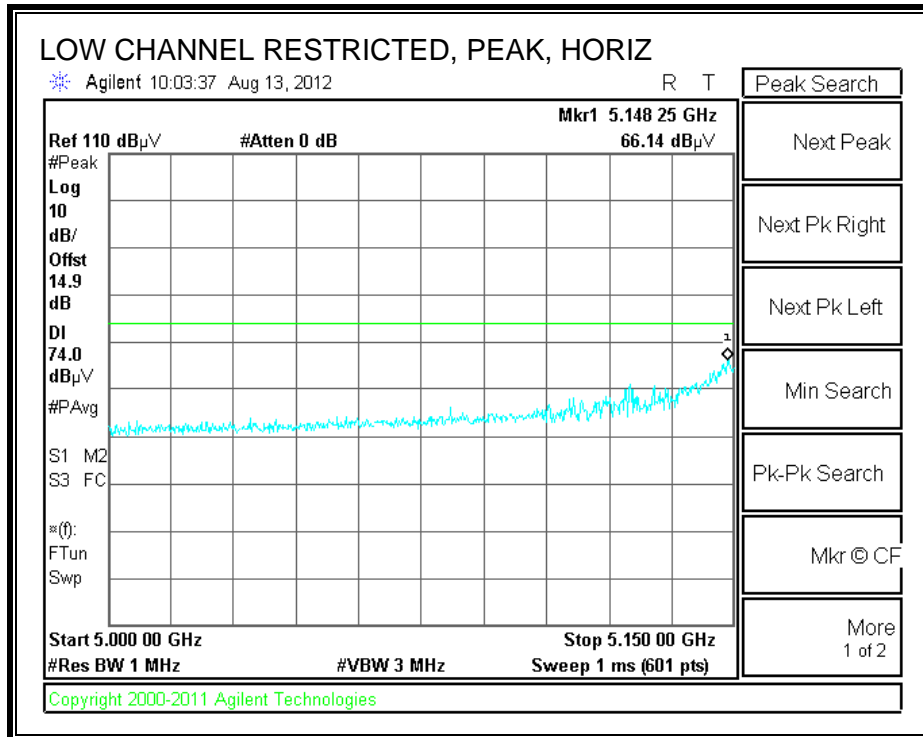

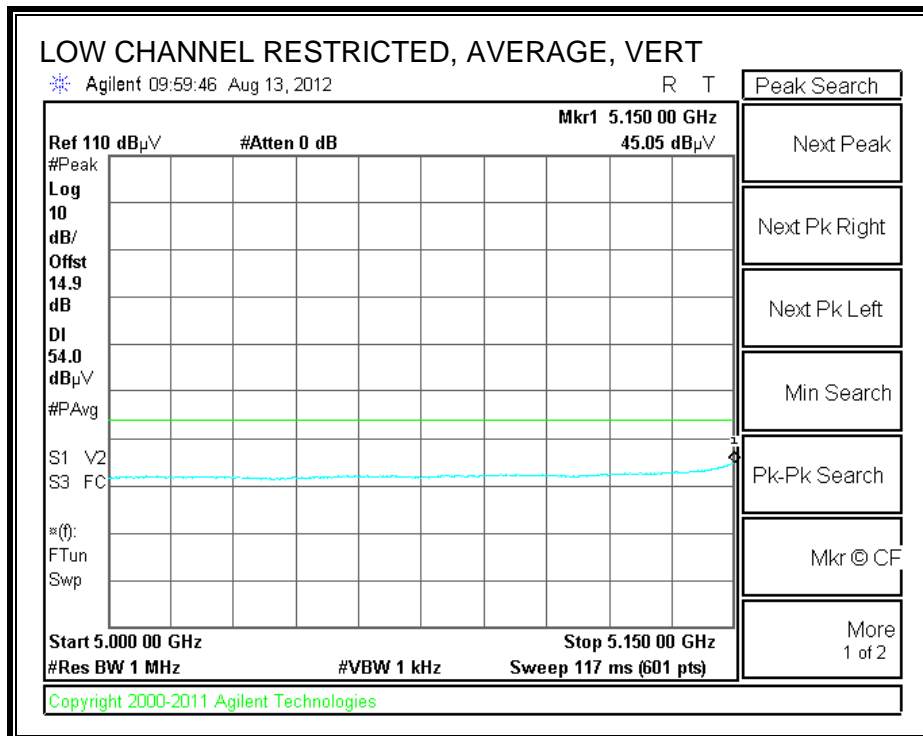
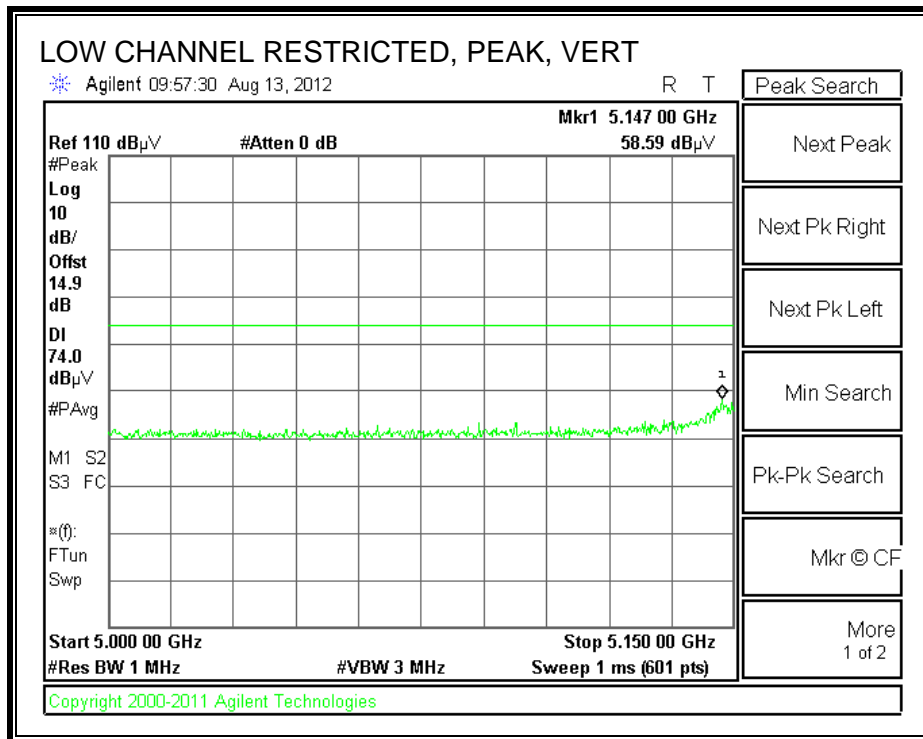



**HARMONICS AND SPURIOUS EMISSIONS**

**High Frequency Measurement**  
 Compliance Certification Services, Fremont 5m Chamber

Test Engr: Chin Pang  
 Date: 08/06/12  
 Project #: 12U14507  
 Company: Apple  
 Test Target: FCC 15.407  
 Mode Oper: HT40, 5.2GHz, TX

f Measurement Frequency Amp Preamp Gain Average Field Strength Limit  
 Dist Distance to Antenna D Corr Distance Correct to 3 meters Peak Field Strength Limit  
 Read Analyzer Reading Avg Average Field Strength @ 3 m Margin vs. Average Limit  
 AF Antenna Factor Peak Calculated Peak Field Strength Margin vs. Peak Limit  
 CL Cable Loss HPF High Pass Filter

f GHz	Dist (m)	Read dBuV	AF dB/m	CL dB	Amp dB	D Corr dB	Filtr dB	Corr. dBuV/m	Limit dBuV/m	Margin dB	Ant. Pol. V/H	Det. P/A/QP	Notes
<b>Low Ch. 5190MHz</b>													
15.570	3.0	34.9	38.9	12.5	-34.0	0.0	0.7	53.0	74.0	-21.0	V	P	
15.570	3.0	22.5	38.9	12.5	-34.0	0.0	0.7	40.6	54.0	-13.4	V	A	
15.570	3.0	35.7	38.9	12.5	-34.0	0.0	0.7	53.8	74.0	-20.2	V	P	
15.570	3.0	22.6	38.9	12.5	-34.0	0.0	0.7	40.7	54.0	-13.3	V	A	
<b>High Ch. 5230MHz</b>													
15.690	3.0	35.9	38.5	12.6	-34.0	0.0	0.7	53.7	74.0	-20.3	H	P	
15.690	3.0	22.5	38.5	12.6	-34.0	0.0	0.7	40.3	54.0	-13.7	H	A	
15.690	3.0	35.9	38.5	12.6	-34.0	0.0	0.7	53.8	74.0	-20.2	V	P	
15.690	3.0	22.5	38.5	12.6	-34.0	0.0	0.7	40.3	54.0	-13.7	V	A	

Rev. 4.1.2.7

Note: No other emissions were detected above the system noise floor.

**9.2.4. TX ABOVE 1 GHz 802.11a MODE IN THE 5.3 GHz BAND**

**RESTRICTED BANDEDGE (HIGH CHANNEL)**

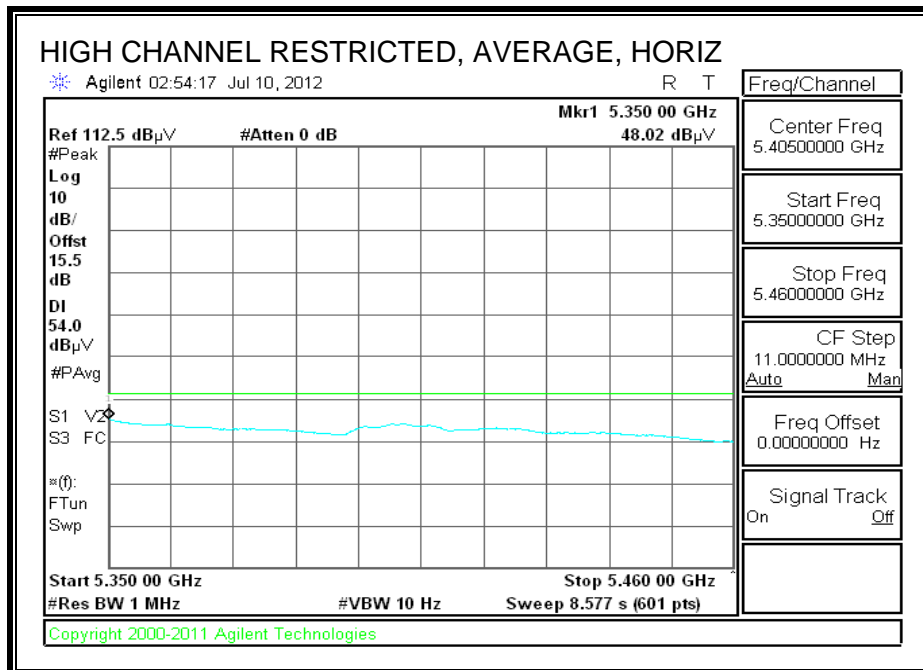
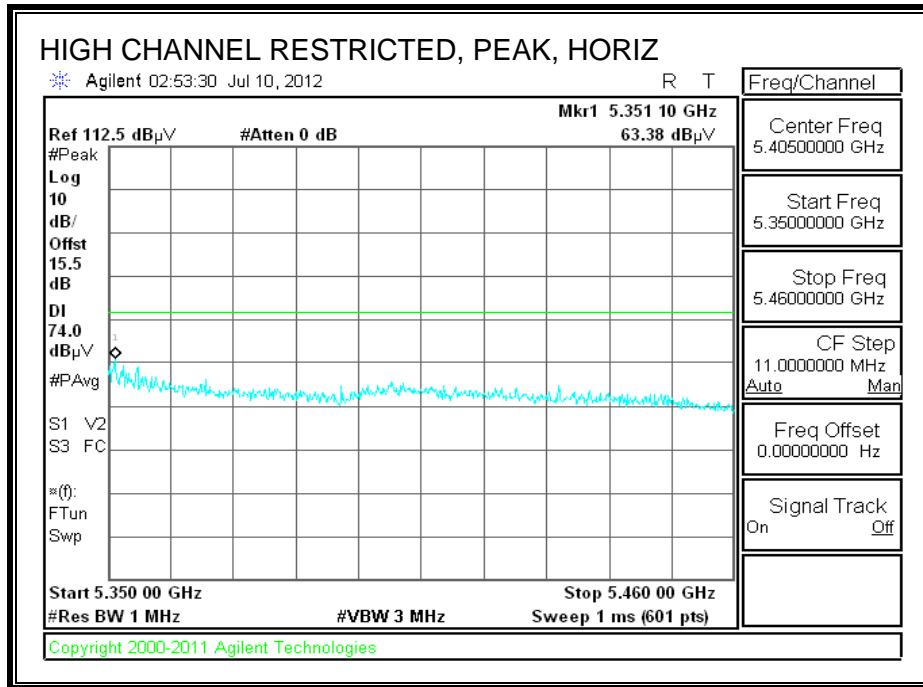

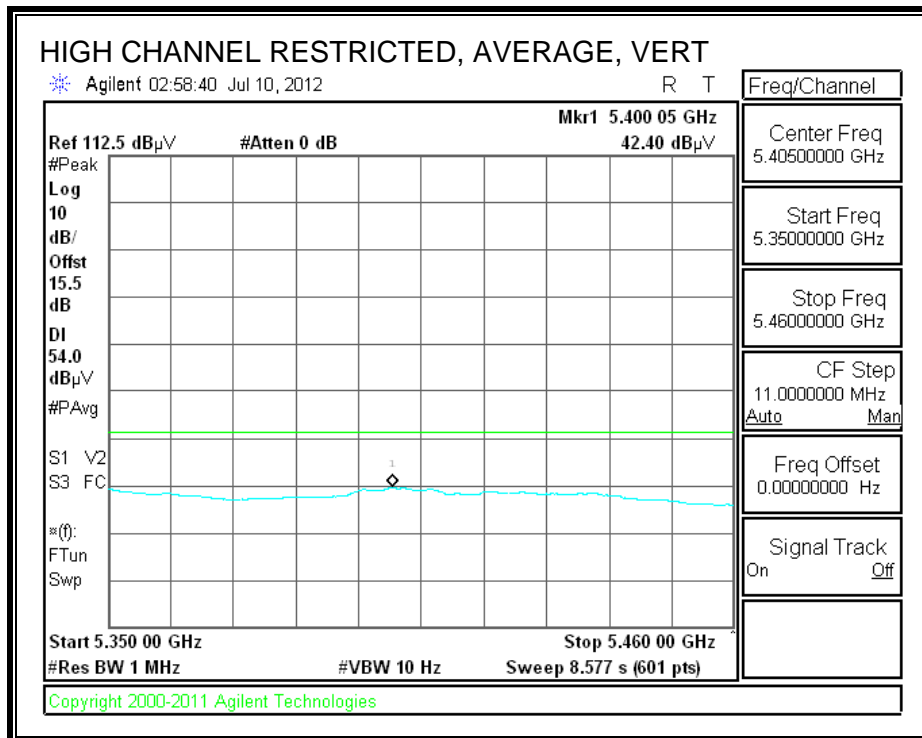
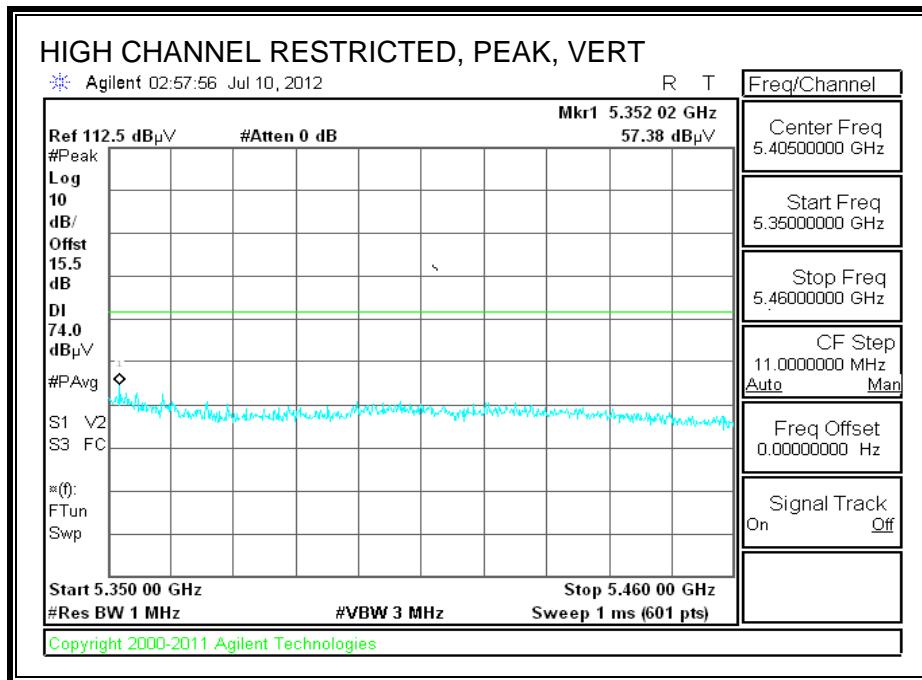

**HARMONICS AND SPURIOUS EMISSIONS**

**High Frequency Measurement**  
 Compliance Certification Services, Fremont 5m Chamber

Test Engr: Chin Pang  
 Date: 08/06/12  
 Project #: 12U14507  
 Company: Apple  
 Test Target: FCC 15.407  
 Mode Oper: a mode, 5.3GHz

f Measurement Frequency Amp Preamp Gain Average Field Strength Limit  
 Dist Distance to Antenna D Corr Distance Correct to 3 meters Peak Field Strength Limit  
 Read Analyzer Reading Avg Average Field Strength @ 3 m Margin vs. Average Limit  
 AF Antenna Factor Peak Calculated Peak Field Strength Margin vs. Peak Limit  
 CL Cable Loss HPF High Pass Filter

f GHz	Dist (m)	Read dBuV	AF dB/m	CL dB	Amp dB	D Corr dB	Filtr dB	Corr. dB	Limit dBuV/m	Margin dB	Ant. Pol. V/H	Det. P/A/QP	Notes
<b>Low Ch. 5260MHz</b>													
15.780	3.0	35.9	38.2	12.6	-33.9	0.0	0.7	53.5	74.0	-20.5	V	P	
15.780	3.0	22.2	38.2	12.6	-33.9	0.0	0.7	39.8	54.0	-14.2	V	A	
15.780	3.0	35.4	38.2	12.6	-33.9	0.0	0.7	53.0	74.0	-21.0	H	P	
15.780	3.0	22.3	38.2	12.6	-33.9	0.0	0.7	39.9	54.0	-14.1	H	A	
<b>Mid Ch. 5300MHz</b>													
10.600	3.0	34.7	38.3	9.7	-35.7	0.0	0.8	47.7	74.0	-26.3	V	P	
10.600	3.0	22.0	38.3	9.7	-35.7	0.0	0.8	35.0	54.0	-19.0	V	A	
15.900	3.0	35.5	37.8	12.7	-33.9	0.0	0.7	52.7	74.0	-21.3	V	P	
15.900	3.0	22.6	37.8	12.7	-33.9	0.0	0.7	39.9	54.0	-14.1	V	A	
10.600	3.0	35.0	38.3	9.7	-35.7	0.0	0.8	48.0	74.0	-26.0	H	P	
10.600	3.0	22.4	38.3	9.7	-35.7	0.0	0.8	35.4	54.0	-18.6	H	A	
15.900	3.0	35.8	37.8	12.7	-33.9	0.0	0.7	53.1	74.0	-20.9	H	P	
15.900	3.0	22.6	37.8	12.7	-33.9	0.0	0.7	39.9	54.0	-14.1	H	A	
<b>High Ch. 5320MHz</b>													
10.640	3.0	34.7	38.3	9.7	-35.7	0.0	0.8	47.7	74.0	-26.3	V	P	
10.640	3.0	21.5	38.3	9.7	-35.7	0.0	0.8	34.5	54.0	-19.5	V	A	
15.960	3.0	35.9	37.6	12.7	-33.9	0.0	0.7	53.0	74.0	-21.0	V	P	
15.960	3.0	22.6	37.6	12.7	-33.9	0.0	0.7	39.7	54.0	-14.3	V	A	
10.640	3.0	34.7	38.3	9.7	-35.7	0.0	0.8	47.7	74.0	-26.3	H	P	
10.640	3.0	21.5	38.3	9.7	-35.7	0.0	0.8	34.6	54.0	-19.4	H	A	
15.960	3.0	35.8	37.6	12.7	-33.9	0.0	0.7	52.9	74.0	-21.1	H	P	
15.960	3.0	22.6	37.6	12.7	-33.9	0.0	0.7	39.7	54.0	-14.3	H	A	

Rev. 4.1.2.7

Note: No other emissions were detected above the system noise floor.

**9.2.5. TX ABOVE 1 GHz 802.11n HT20 MODE IN THE 5.3 GHz BAND**

**RESTRICTED BANDEDGE (HIGH CHANNEL)**

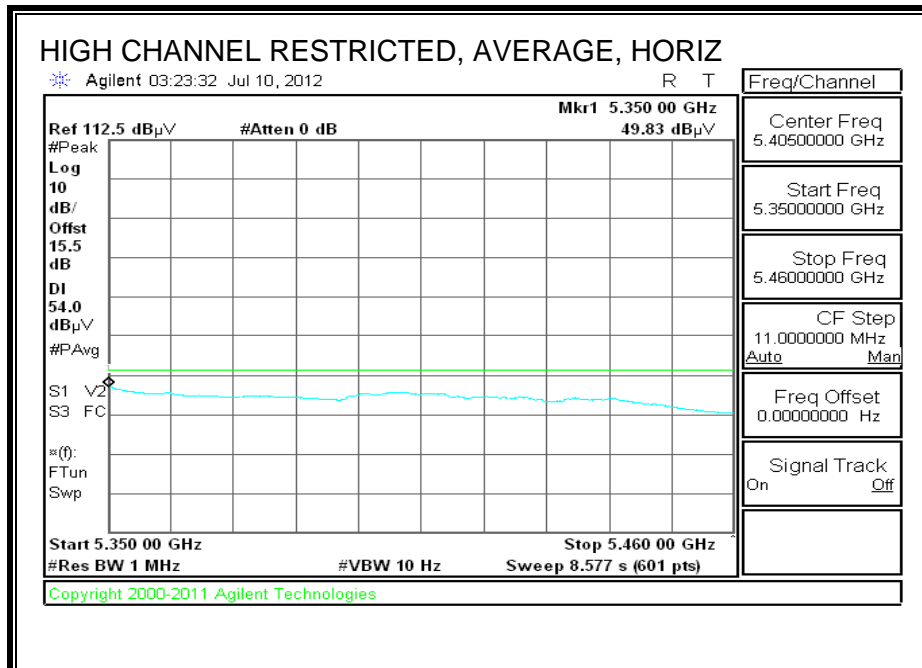
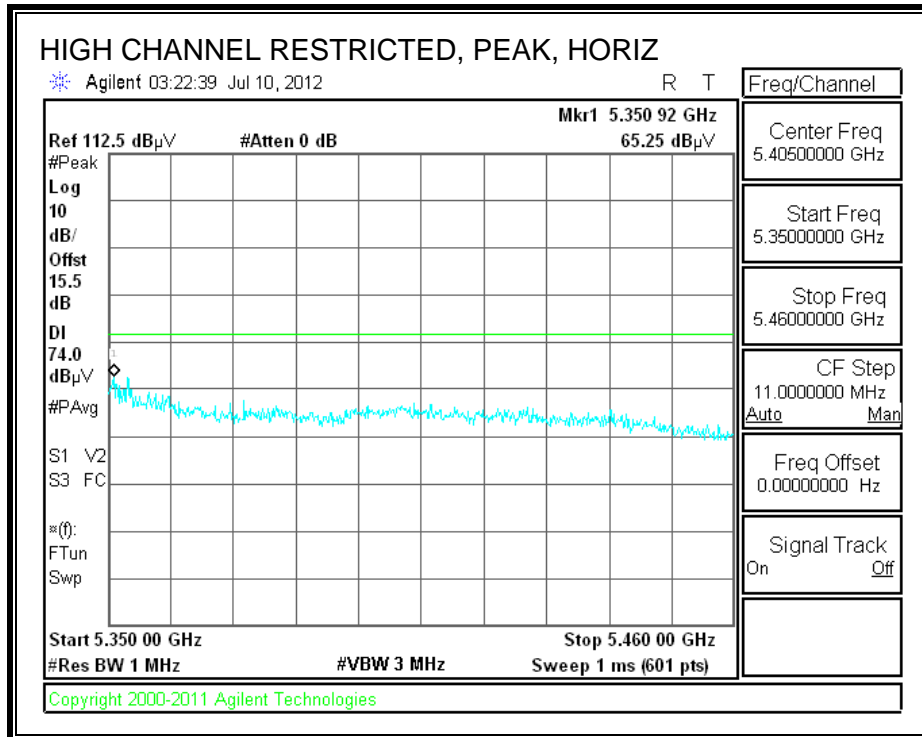

**HIGH CHANNEL RESTRICTED, PEAK, VERT**

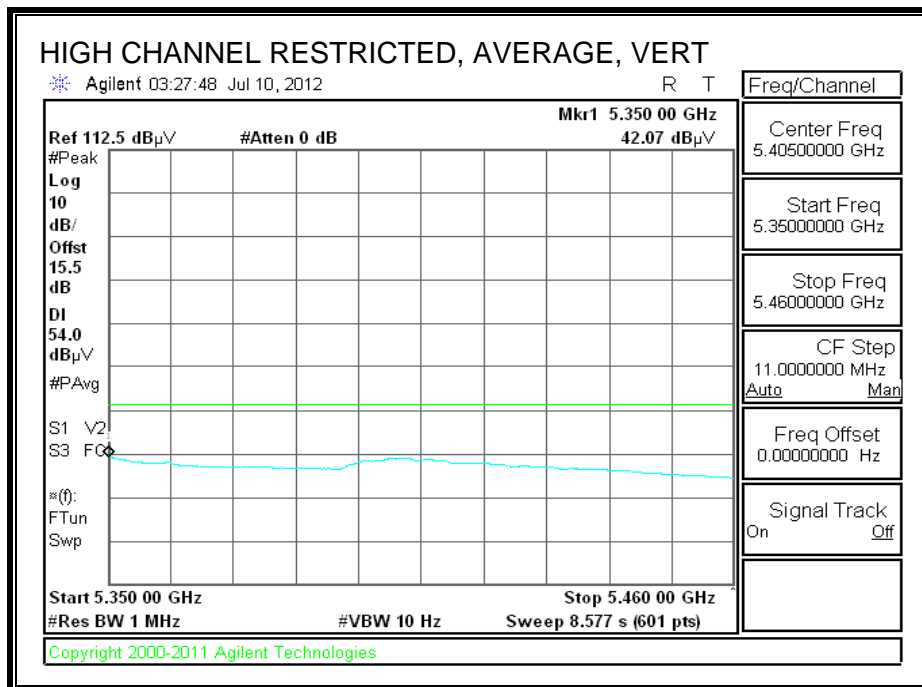
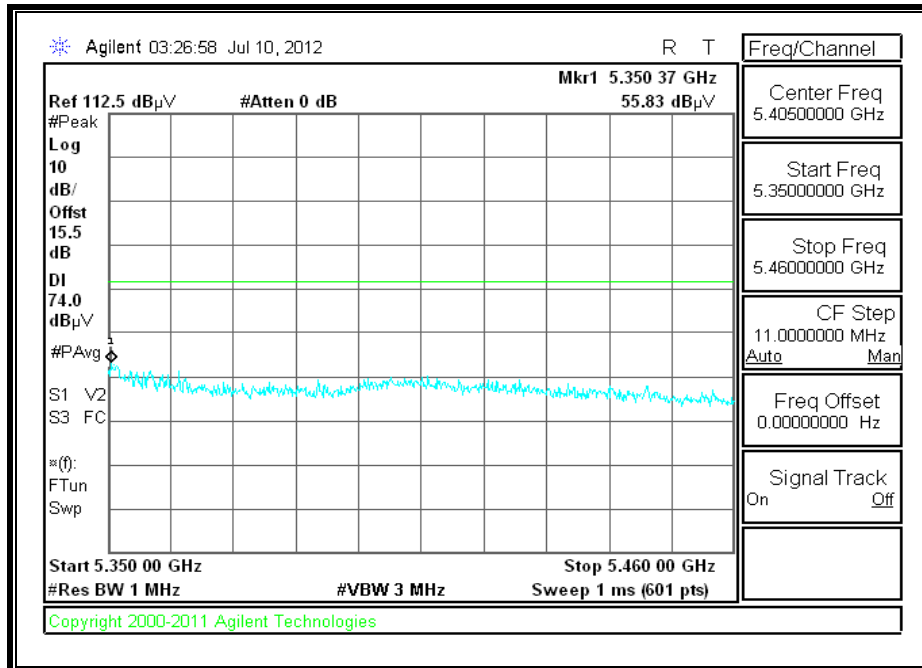

**HARMONICS AND SPURIOUS EMISSIONS**

**High Frequency Measurement  
 Compliance Certification Services, Fremont 5m Chamber**

Test Engr: Chin Pang  
 Date: 08/06/12  
 Project #: 12U14507  
 Company: Apple  
 Test Target: FCC 15.407  
 Mode Oper: HT20, 5.3GHz

f Measurement Frequency Amp Preamp Gain Average Field Strength Limit  
 Dist Distance to Antenna D Corr Distance Correct to 3 meters Peak Field Strength Limit  
 Read Analyzer Reading Avg Average Field Strength @ 3 m Margin vs. Average Limit  
 AF Antenna Factor Peak Calculated Peak Field Strength Margin vs. Peak Limit  
 CL Cable Loss HPF High Pass Filter

f GHz	Dist (m)	Read dBuV	AF dB/m	CL dB	Amp dB	D Corr dB	Filtr dB	Corr. dB	Limit dBuV/m	Margin dB	Ant. Pol. V/H	Det. P/A/QP	Notes
<b>Low Ch, 5260MHz</b>													
15.780	3.0	35.4	38.2	12.6	-33.9	0.0	0.7	53.0	74.0	-21.0	H	P	
15.780	3.0	22.2	38.2	12.6	-33.9	0.0	0.7	39.8	54.0	-14.2	H	A	
15.780	3.0	35.5	38.2	12.6	-33.9	0.0	0.7	53.1	74.0	-20.9	V	P	
15.780	3.0	22.2	38.2	12.6	-33.9	0.0	0.7	39.8	54.0	-14.2	V	A	
<b>Mid Ch, 5300MHz</b>													
10.600	3.0	34.2	38.3	9.7	-35.7	0.0	0.8	47.1	74.0	-26.9	H	P	
10.600	3.0	21.6	38.3	9.7	-35.7	0.0	0.8	34.6	54.0	-19.4	H	A	
15.900	3.0	35.8	37.8	12.7	-33.9	0.0	0.7	53.1	74.0	-20.9	H	P	
15.900	3.0	22.6	37.8	12.7	-33.9	0.0	0.7	39.9	54.0	-14.1	H	A	
10.600	3.0	34.2	38.3	9.7	-35.7	0.0	0.8	47.2	74.0	-26.8	V	P	
10.600	3.0	21.6	38.3	9.7	-35.7	0.0	0.8	34.6	54.0	-19.4	V	A	
15.900	3.0	35.4	37.8	12.7	-33.9	0.0	0.7	52.7	74.0	-21.3	V	P	
15.900	3.0	22.6	37.8	12.7	-33.9	0.0	0.7	39.9	54.0	-14.1	V	A	
<b>High Ch, 5320MHz</b>													
10.640	3.0	35.5	38.3	9.7	-35.7	0.0	0.8	48.5	74.0	-25.5	H	P	
10.640	3.0	21.6	38.3	9.7	-35.7	0.0	0.8	34.6	54.0	-19.4	H	A	
15.960	3.0	35.8	37.6	12.7	-33.9	0.0	0.7	53.0	74.0	-21.0	H	P	
15.960	3.0	22.8	37.6	12.7	-33.9	0.0	0.7	39.9	54.0	-14.1	H	A	
10.640	3.0	34.6	38.3	9.7	-35.7	0.0	0.8	47.6	74.0	-26.4	V	P	
10.640	3.0	21.6	38.3	9.7	-35.7	0.0	0.8	34.6	54.0	-19.4	V	A	
15.960	3.0	35.7	37.6	12.7	-33.9	0.0	0.7	52.9	74.0	-21.1	V	P	
15.960	3.0	22.6	37.6	12.7	-33.9	0.0	0.7	39.8	54.0	-14.2	V	A	

Rev. 4.1.2.7

Note: No other emissions were detected above the system noise floor.

**9.2.6. TX ABOVE 1 GHz 802.11n HT40 MODE IN THE 5.3 GHz BAND**

**RESTRICTED BANEDGE (HIGH CHANNEL)**

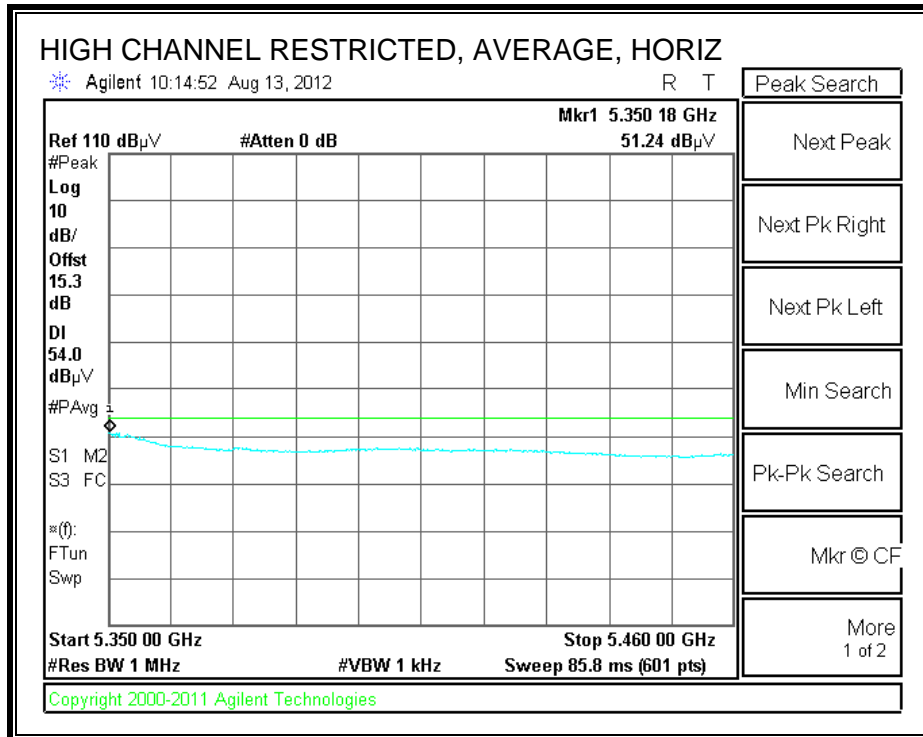
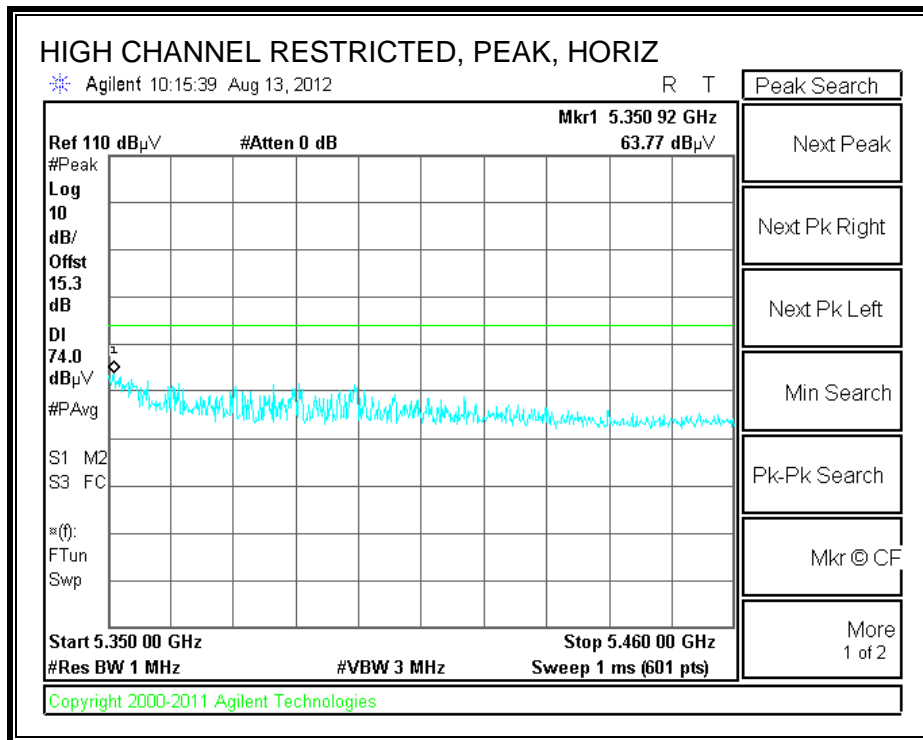



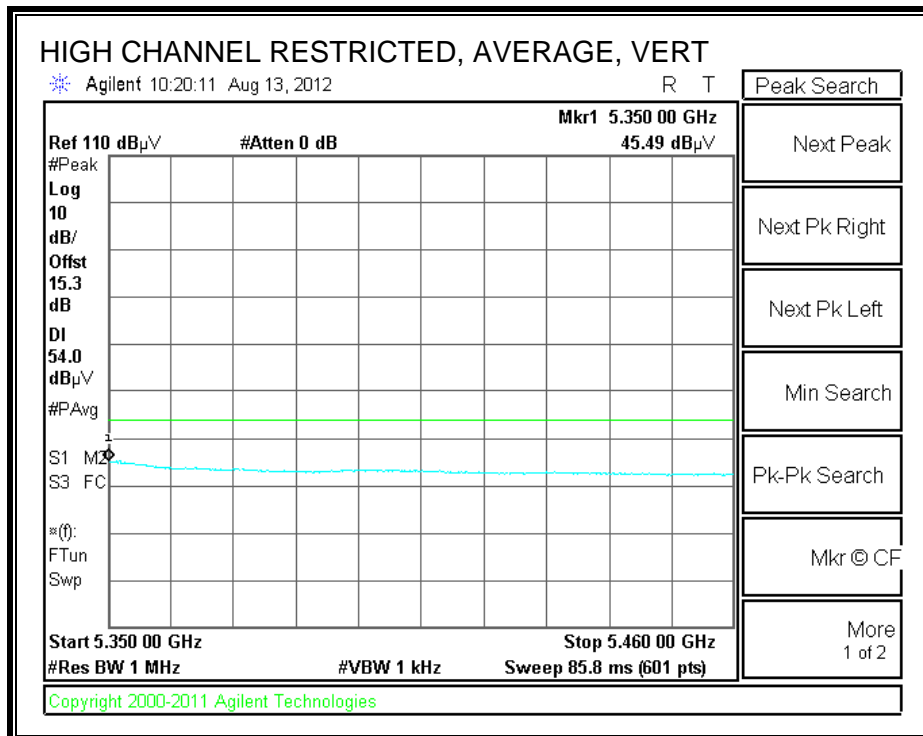
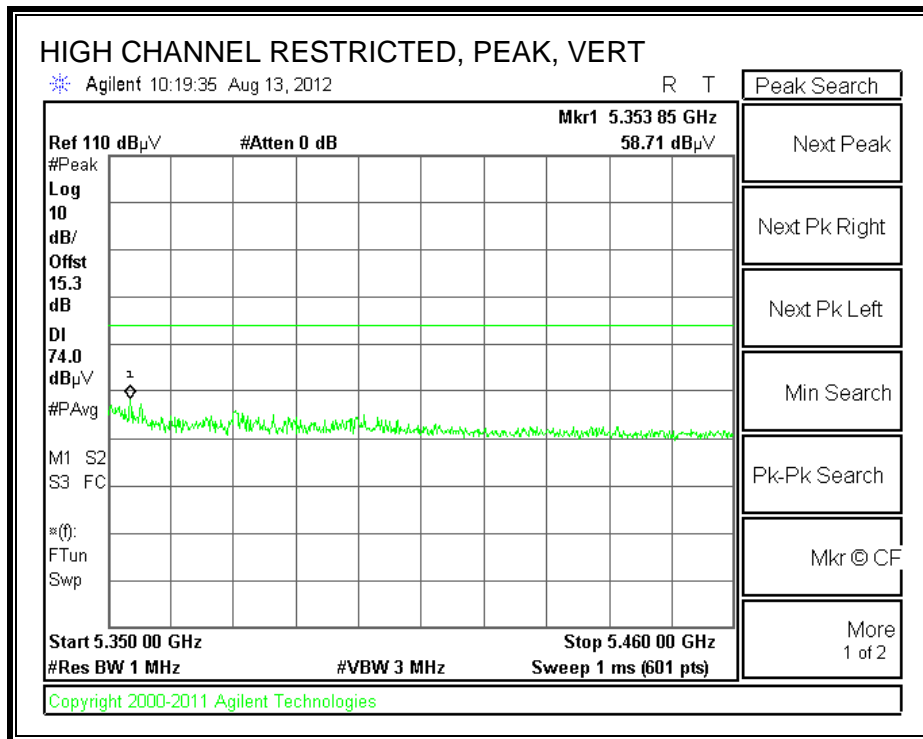

**HARMONICS AND SPURIOUS EMISSIONS**

**High Frequency Measurement**  
 Compliance Certification Services, Fremont 5m Chamber

Test Engr: Chin Pang  
 Date: 08/06/12  
 Project #: 12U14507  
 Company: Apple  
 Test Target: FCC 15.407  
 Mode Oper: HT40, 5.3GHz

f Measurement Frequency Amp Preamp Gain Average Field Strength Limit  
 Dist Distance to Antenna D Corr Distance Correct to 3 meters Peak Field Strength Limit  
 Read Analyzer Reading Avg Average Field Strength @ 3 m Margin vs. Average Limit  
 AF Antenna Factor Peak Calculated Peak Field Strength Margin vs. Peak Limit  
 CL Cable Loss HPF High Pass Filter

f GHz	Dist (m)	Read dBuV	AF dB/m	CL dB	Amp dB	D Corr dB	Filtr dB	Corr. dB	Limit dBuV/m	Margin dB	Ant. Pol. V/H	Det. P/A/QP	Notes
<b>Low Ch. 5270MHz</b>													
15.810	3.0	35.2	38.1	12.6	-33.9	0.0	0.7	52.7	74.0	-21.3	V	P	
15.810	3.0	22.7	38.1	12.6	-33.9	0.0	0.7	40.2	54.0	-13.8	V	A	
15.810	3.0	35.0	38.1	12.6	-33.9	0.0	0.7	52.5	74.0	-21.5	H	P	
15.810	3.0	22.7	38.1	12.6	-33.9	0.0	0.7	40.2	54.0	-13.8	H	A	
<b>High Ch. 5310MHz</b>													
10.620	3.0	34.7	38.3	9.7	-35.7	0.0	0.8	47.6	74.0	-26.4	V	P	
10.620	3.0	21.7	38.3	9.7	-35.7	0.0	0.8	34.6	54.0	-19.4	V	A	
15.930	3.0	36.2	37.7	12.7	-33.9	0.0	0.7	53.4	74.0	-20.6	V	P	
15.930	3.0	22.7	37.7	12.7	-33.9	0.0	0.7	39.9	54.0	-14.1	V	A	
10.620	3.0	34.5	38.3	9.7	-35.7	0.0	0.8	47.4	74.0	-26.6	H	P	
10.620	3.0	21.7	38.3	9.7	-35.7	0.0	0.8	34.6	54.0	-19.4	H	A	
15.930	3.0	35.7	37.7	12.7	-33.9	0.0	0.7	52.9	74.0	-21.1	H	P	
15.930	3.0	22.7	37.7	12.7	-33.9	0.0	0.7	39.9	54.0	-14.1	H	A	

Rev. 4.1.2.7

Note: No other emissions were detected above the system noise floor.

**9.2.7. TX ABOVE 1 GHz 802.11a MODE IN THE 5.6 GHz BAND**

**RESTRICTED & AUTHORIZED BANDEDGE (LOW CHANNEL)**

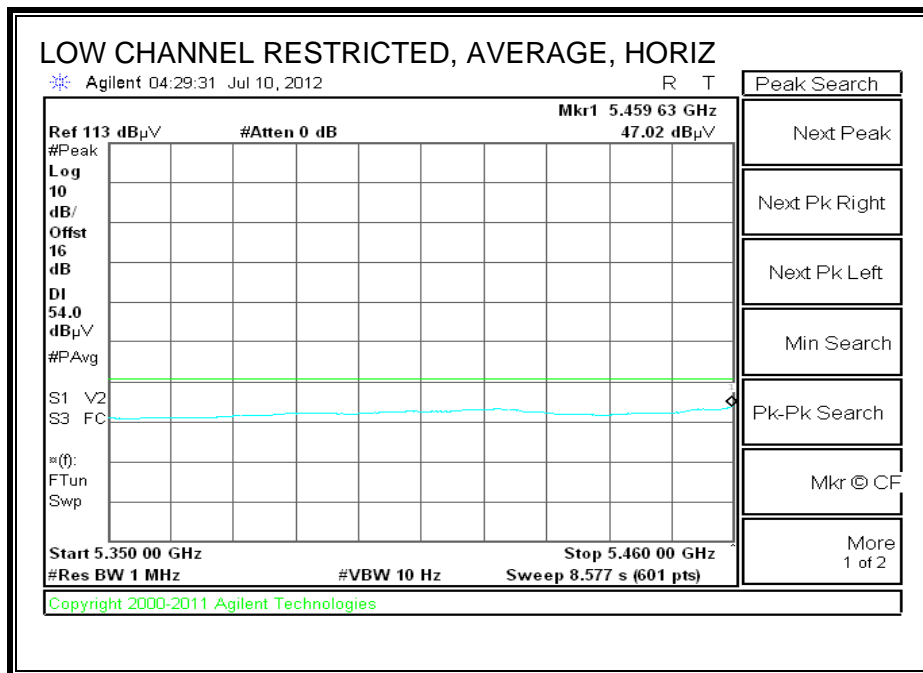
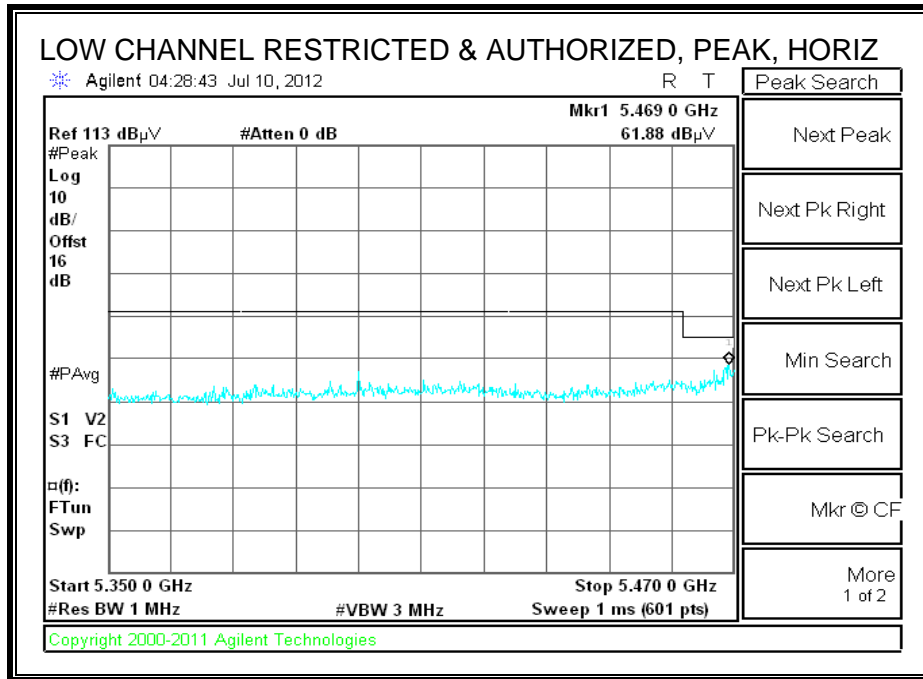

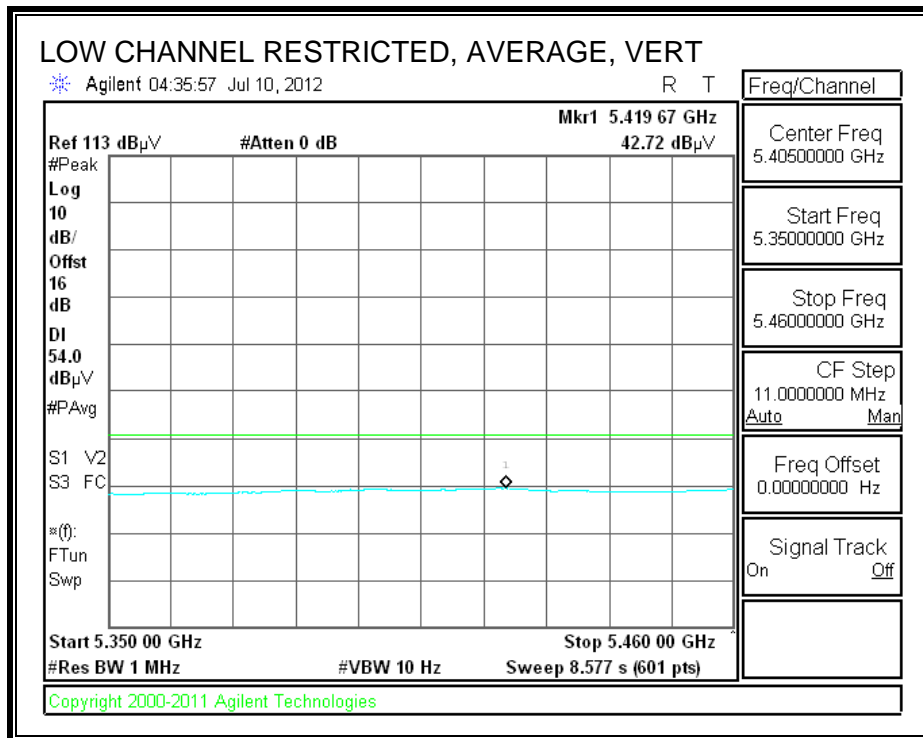
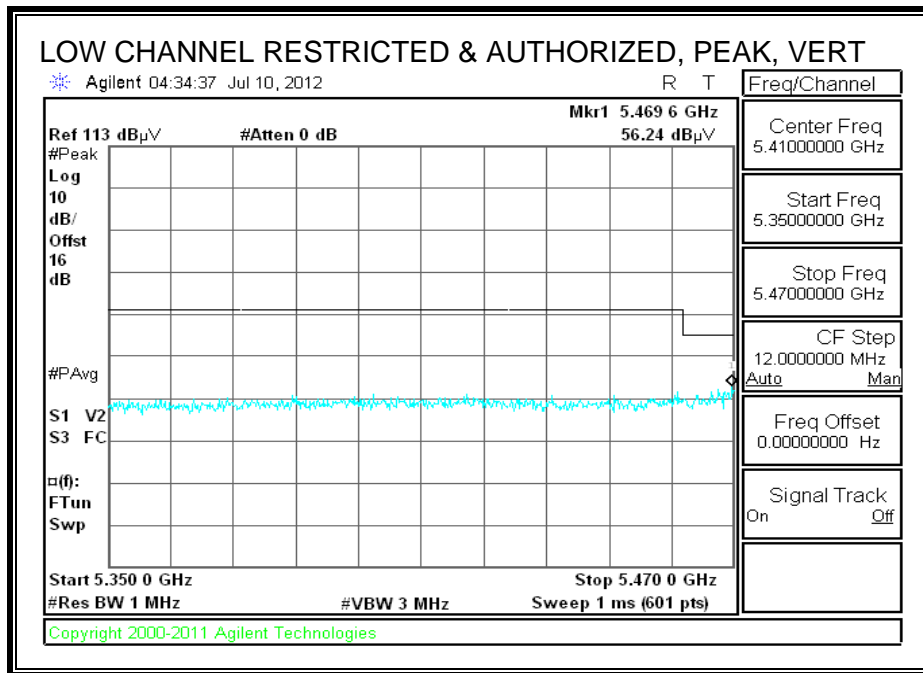

**AUTHORIZED BANDEDGE (HIGH CHANNEL)**

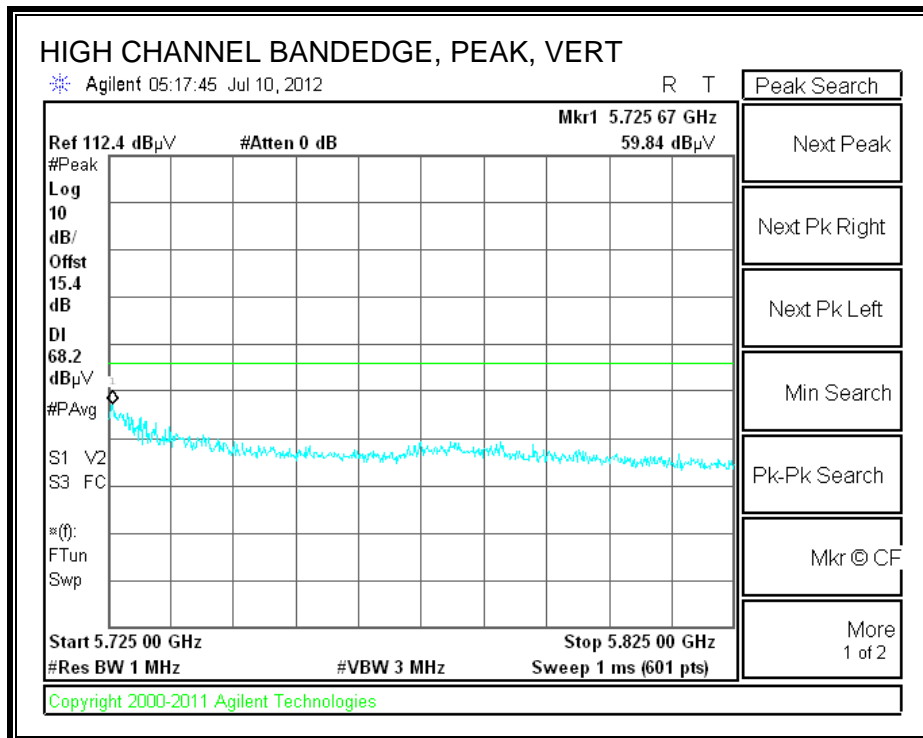
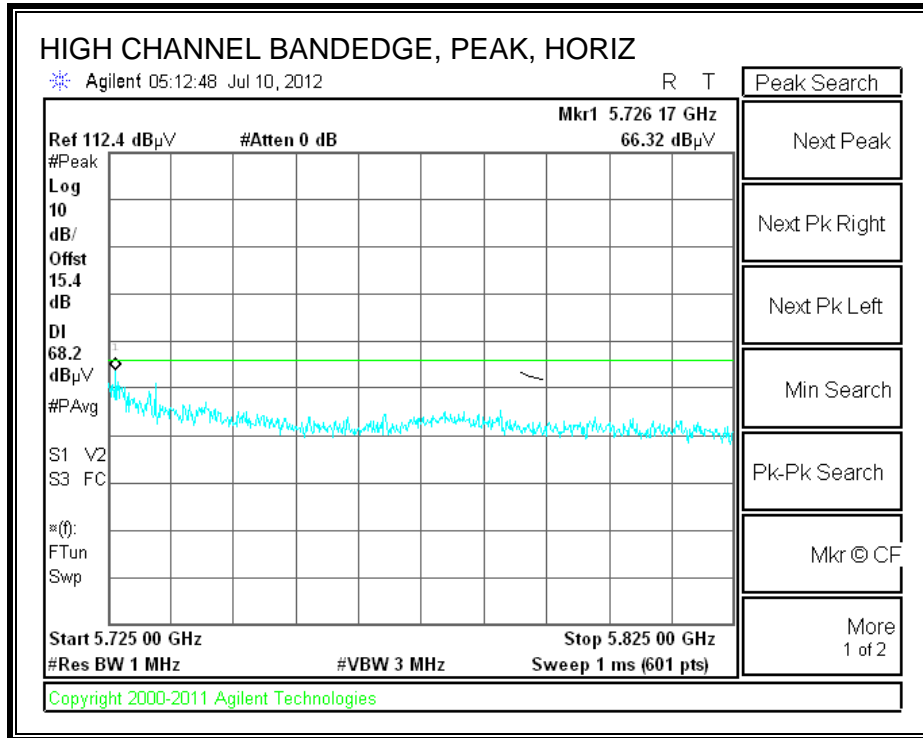

**HARMONICS AND SPURIOUS EMISSIONS**

**High Frequency Measurement  
 Compliance Certification Services, Fremont 5m Chamber**

Test Engr: Chin Pang  
 Date: 08/07/12  
 Project #: 12U14507  
 Company: Apple  
 Test Target: FCC 15.407  
 Mode Oper: a mode, 5.6GHz

f Measurement Frequency Amp Preamp Gain Average Field Strength Limit  
 Dist Distance to Antenna D Corr Distance Correct to 3 meters Peak Field Strength Limit  
 Read Analyzer Reading Avg Average Field Strength @ 3 m Margin vs. Average Limit  
 AF Antenna Factor Peak Calculated Peak Field Strength Margin vs. Peak Limit  
 CL Cable Loss HPF High Pass Filter

f GHz	Dist (m)	Read dBuV	AF dB/m	CL dB	Amp dB	D Corr dB	Filtr dB	Corr. dBuV/m	Limit dBuV/m	Margin dB	Ant. Pol. V/H	Det. P/A/QP	Notes
<b>Low Ch. 5500MHz</b>													
11.000	3.0	34.1	38.4	10.1	-35.6	0.0	0.7	47.6	74.0	-26.4	V	P	
11.000	3.0	23.6	38.4	10.1	-35.6	0.0	0.7	37.1	54.0	-16.9	V	A	
11.000	3.0	34.4	38.4	10.1	-35.6	0.0	0.7	47.9	74.0	-26.1	H	P	
11.000	3.0	23.6	38.4	10.1	-35.6	0.0	0.7	37.1	54.0	-16.9	H	A	
<b>Mid Ch. 5580MHz</b>													
11.160	3.0	35.2	38.5	10.2	-35.6	0.0	0.7	49.1	74.0	-24.9	V	P	
11.160	3.0	24.5	38.5	10.2	-35.6	0.0	0.7	38.4	54.0	-15.6	V	A	
11.160	3.0	34.8	38.5	10.2	-35.6	0.0	0.7	48.7	74.0	-25.3	H	P	
11.160	3.0	24.4	38.5	10.2	-35.6	0.0	0.7	38.3	54.0	-15.7	H	A	
<b>High Ch. 5700MHz</b>													
11.400	3.0	34.9	38.7	10.4	-35.6	0.0	0.7	49.3	74.0	-24.7	V	P	
11.400	3.0	24.3	38.7	10.4	-35.6	0.0	0.7	38.6	54.0	-15.4	V	A	
11.400	3.0	35.4	38.7	10.4	-35.6	0.0	0.7	49.7	74.0	-24.3	H	P	
11.400	3.0	24.2	38.7	10.4	-35.6	0.0	0.7	38.6	54.0	-15.4	H	A	

Rev. 4.1.2.7

Note: No other emissions were detected above the system noise floor.

**9.2.8. TX ABOVE 1 GHz 802.11n HT20 MODE IN THE 5.6 GHz BAND**

**RESTRICTED & AUTHORIZED BANDEDGE (LOW CHANNEL)**

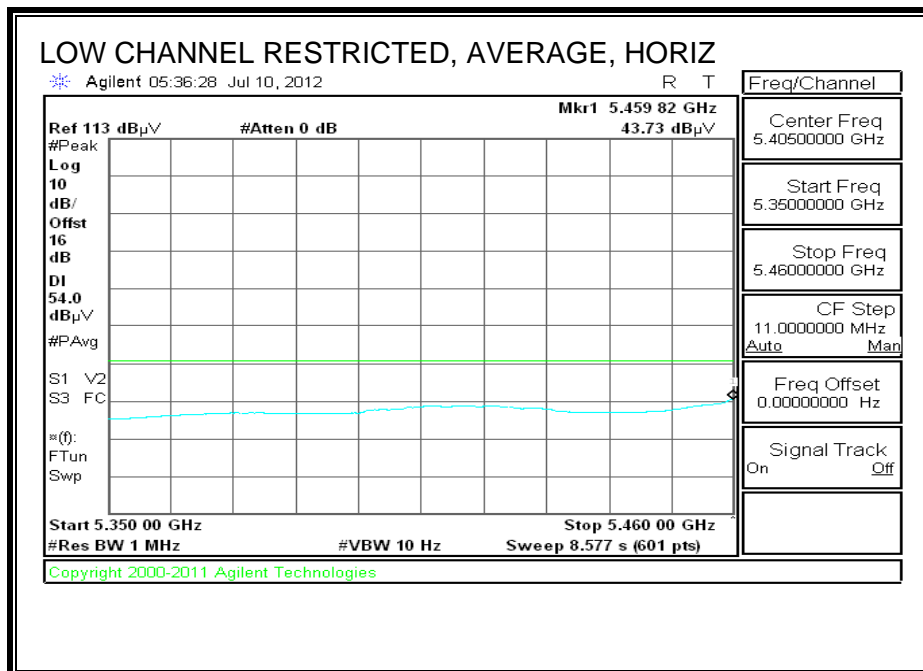
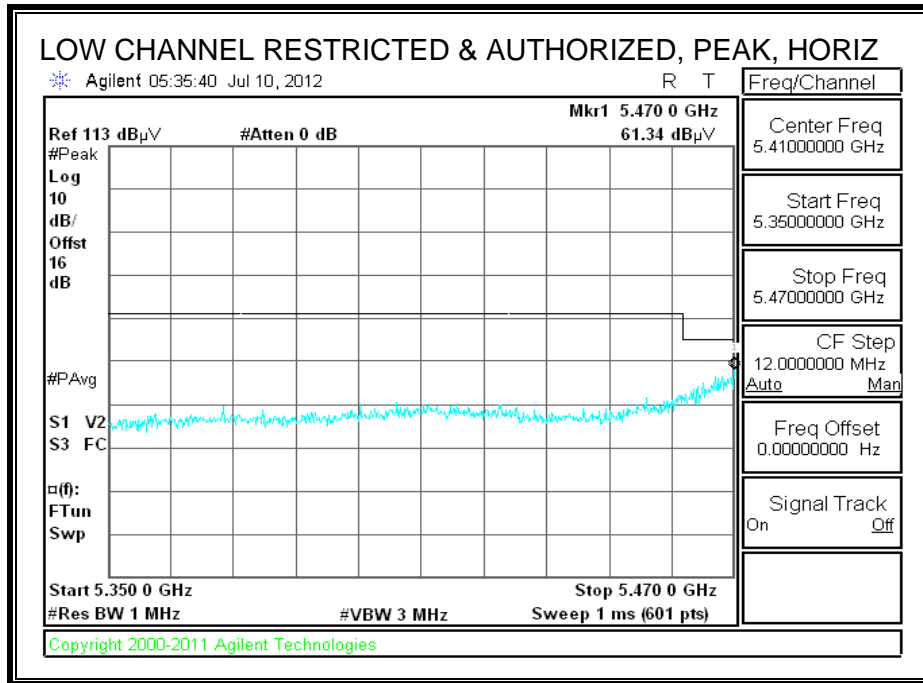

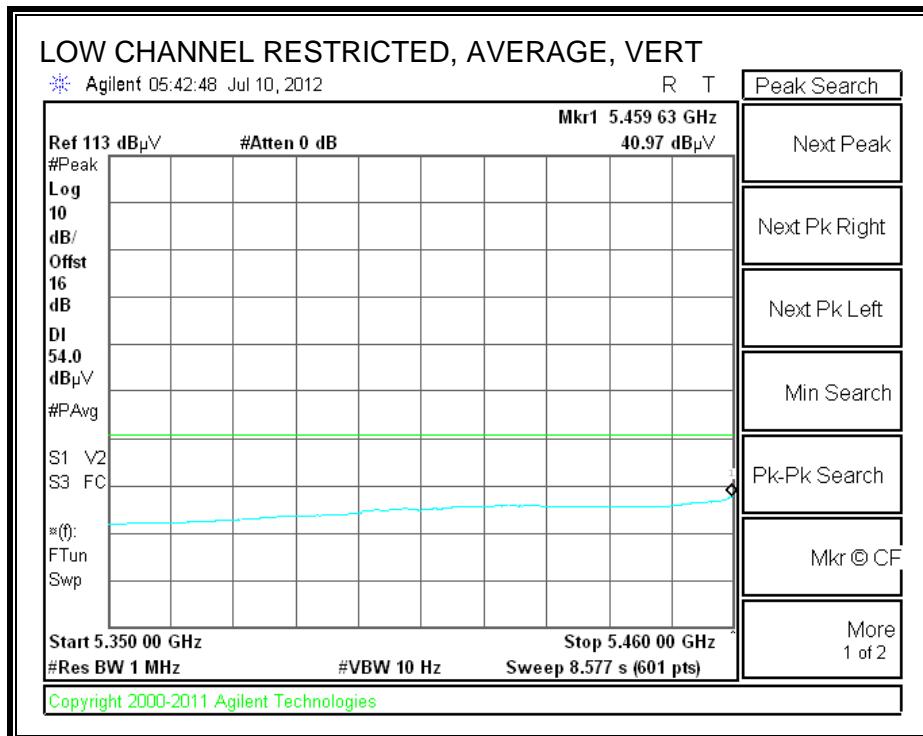
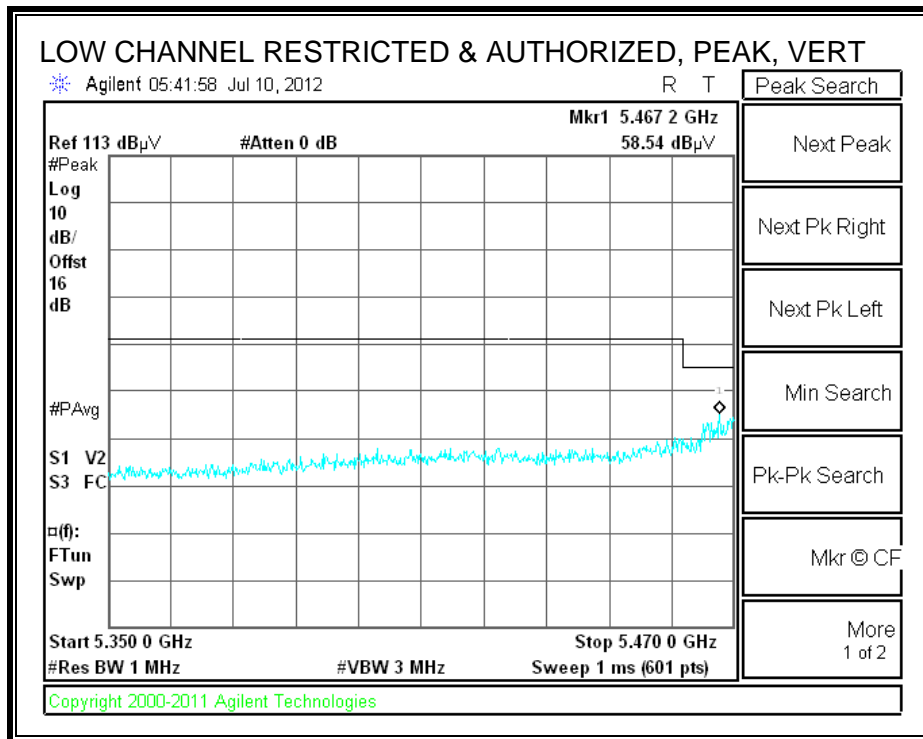



**AUTHORIZED BANDEGE (HIGH CHANNEL)**

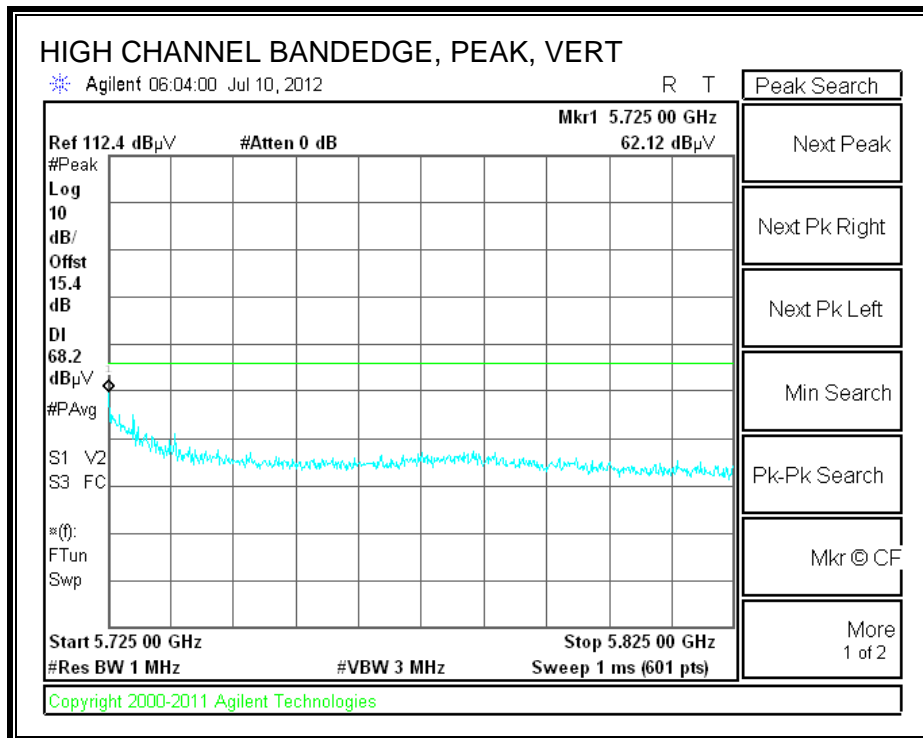
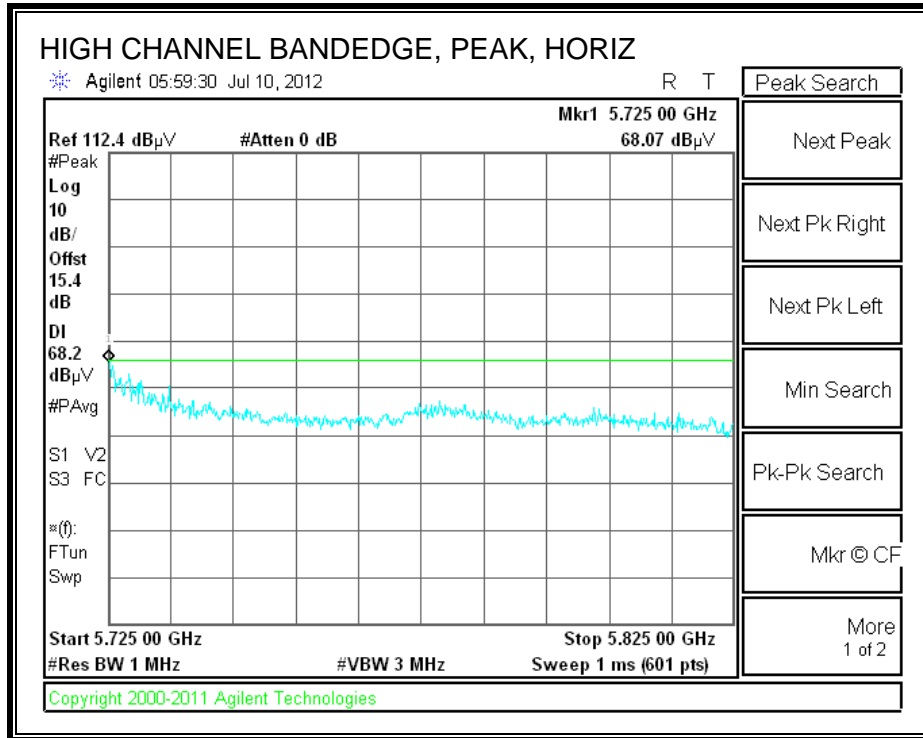

**HARMONICS AND SPURIOUS EMISSIONS**

**High Frequency Measurement**  
 Compliance Certification Services, Fremont 5m Chamber

Test Engr: Chin Pang  
 Date: 08/07/12  
 Project #: 12U14507  
 Company: Apple  
 Test Target: FCC 15.407  
 Mode Oper: HT20, 5.6GHz

f Measurement Frequency Amp Preamp Gain Average Field Strength Limit  
 Dist Distance to Antenna D Corr Distance Correct to 3 meters Peak Field Strength Limit  
 Read Analyzer Reading Avg Average Field Strength @ 3 m Margin vs. Average Limit  
 AF Antenna Factor Peak Calculated Peak Field Strength Margin vs. Peak Limit  
 CL Cable Loss HPF High Pass Filter

f GHz	Dist (m)	Read dBuV	AF dB/m	CL dB	Amp dB	D Corr dB	Filtr dB	Corr. dB	Limit dBuV/m	Margin dB	Ant. Pol. V/H	Det. P/A/QP	Notes
<b>Low Ch. 5500MHz</b>													
11.000	3.0	34.0	38.4	10.1	-35.6	0.0	0.7	47.5	74.0	-26.5	V	P	
11.000	3.0	23.5	38.4	10.1	-35.6	0.0	0.7	37.0	54.0	-17.0	V	A	
11.000	3.0	33.7	38.4	10.1	-35.6	0.0	0.7	47.2	74.0	-26.8	H	P	
11.000	3.0	23.4	38.4	10.1	-35.6	0.0	0.7	36.9	54.0	-17.1	H	A	
<b>Mid Ch. 5580MHz</b>													
11.160	3.0	34.6	38.5	10.2	-35.6	0.0	0.7	48.5	74.0	-25.5	V	P	
11.160	3.0	24.3	38.5	10.2	-35.6	0.0	0.7	38.2	54.0	-15.8	V	A	
11.160	3.0	35.0	38.5	10.2	-35.6	0.0	0.7	48.9	74.0	-25.1	H	P	
11.160	3.0	24.3	38.5	10.2	-35.6	0.0	0.7	38.2	54.0	-15.8	H	A	
<b>High Ch. 5700MHz</b>													
11.400	3.0	35.7	38.7	10.4	-35.6	0.0	0.7	50.0	74.0	-24.0	V	P	
11.400	3.0	24.2	38.7	10.4	-35.6	0.0	0.7	38.5	54.0	-15.5	V	A	
11.400	3.0	34.6	38.7	10.4	-35.6	0.0	0.7	48.9	74.0	-25.1	H	P	
11.400	3.0	24.2	38.7	10.4	-35.6	0.0	0.7	38.5	54.0	-15.5	H	A	

Rev. 4.1.2.7

Note: No other emissions were detected above the system noise floor.

**9.2.9. TX ABOVE 1 GHz 802.11n HT40 MODE IN THE 5.6 GHz BAND**

**RESTRICTED & AUTHORIZED BANDEDGE (LOW CHANNEL)**

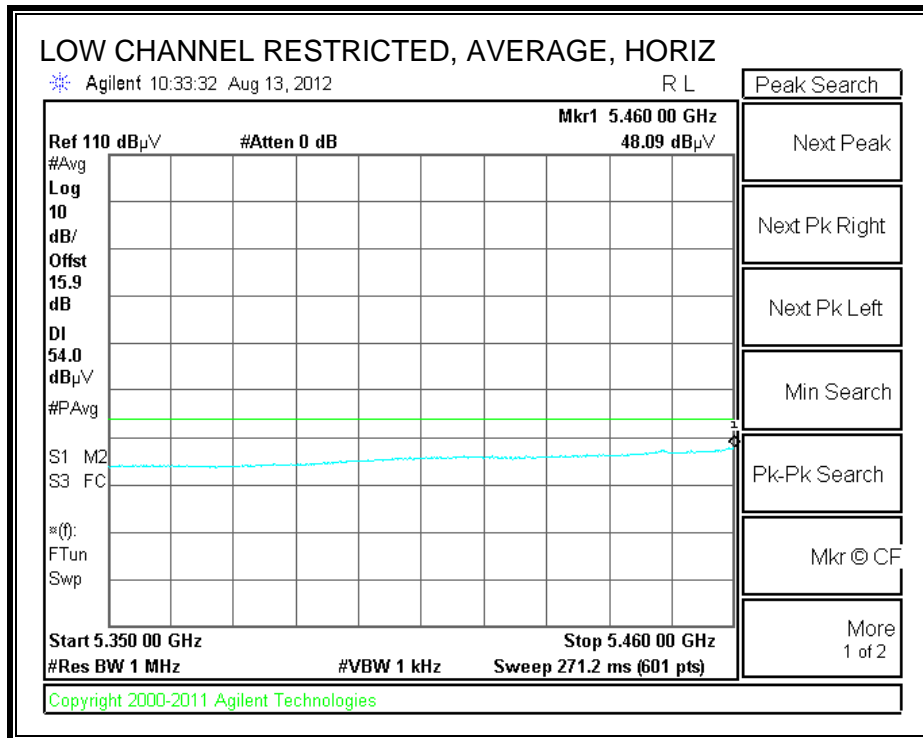
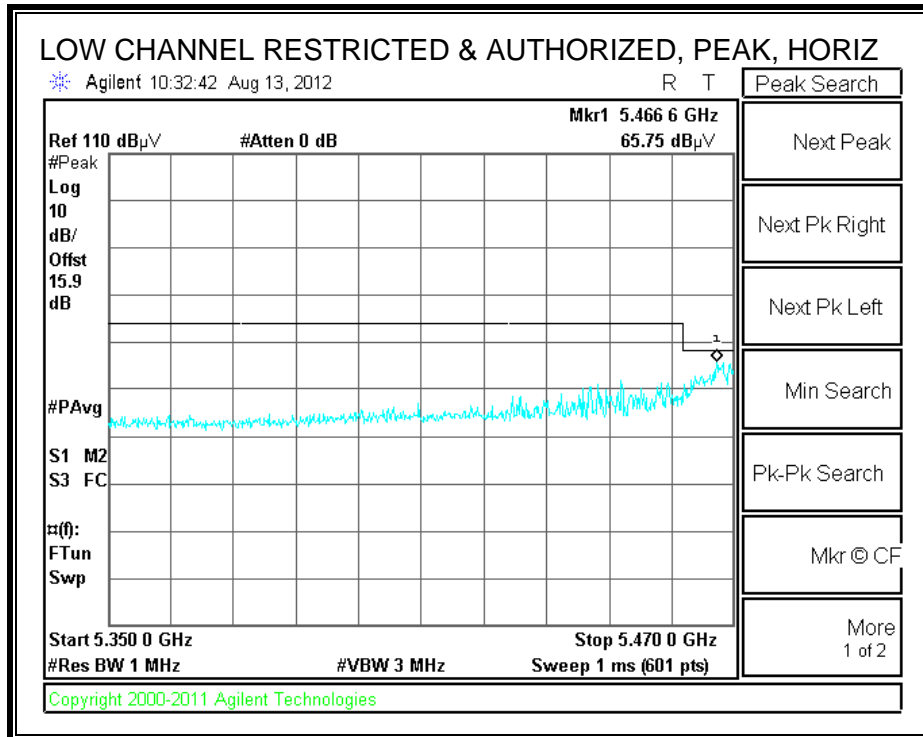

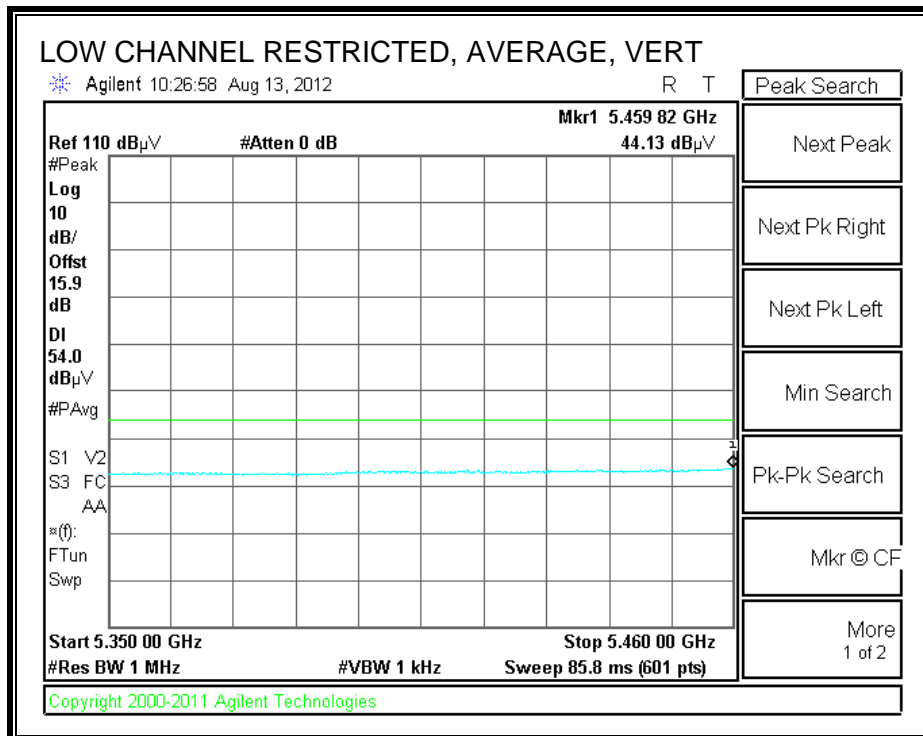
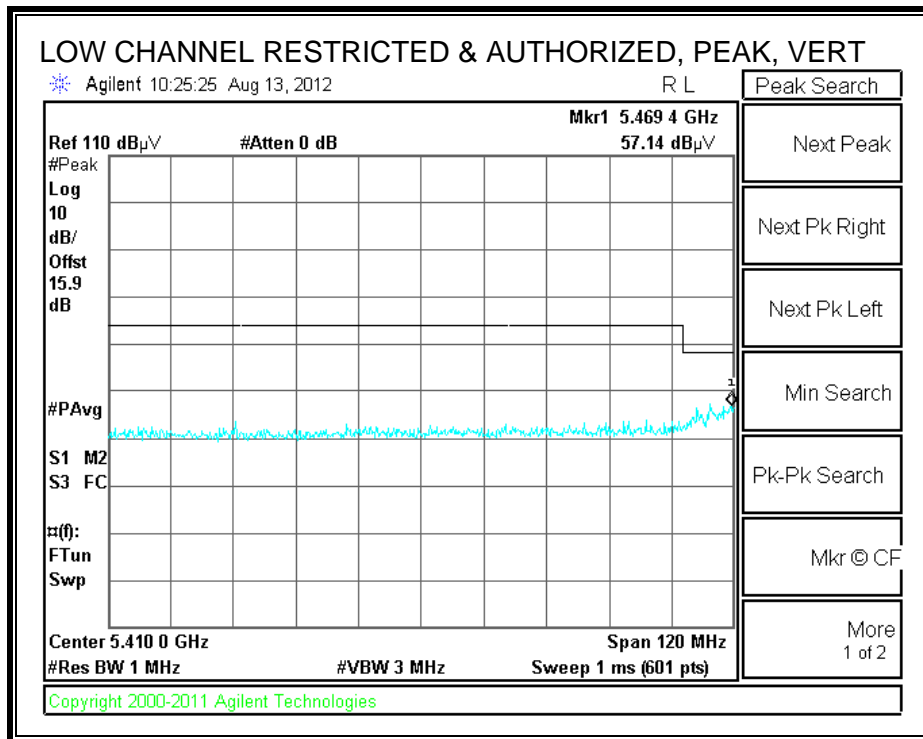

**AUTHORIZED BANDEDGE (HIGH CHANNEL)**

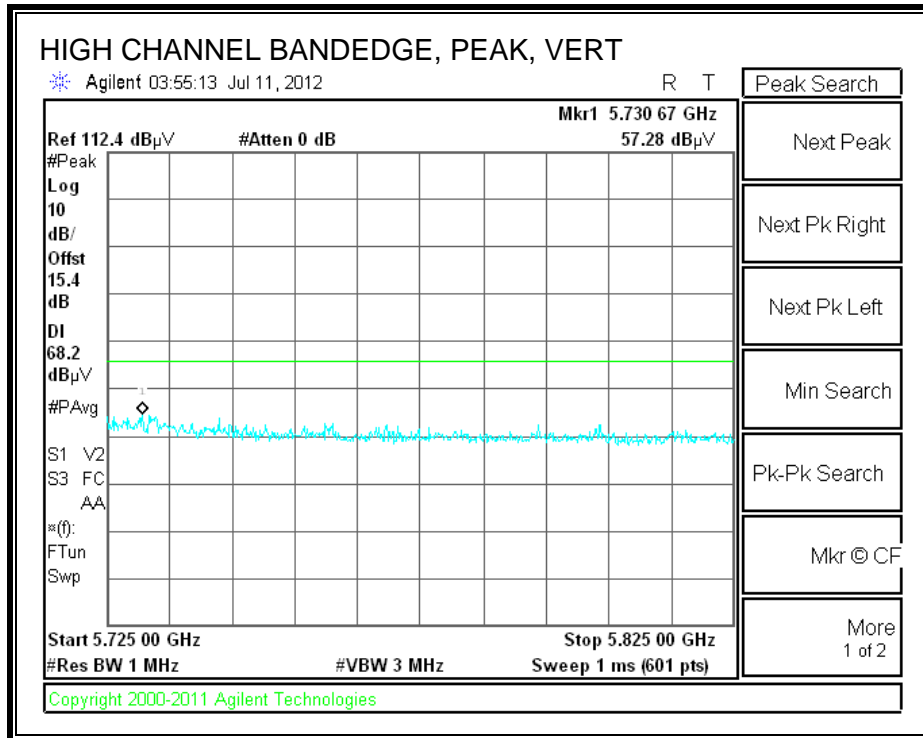
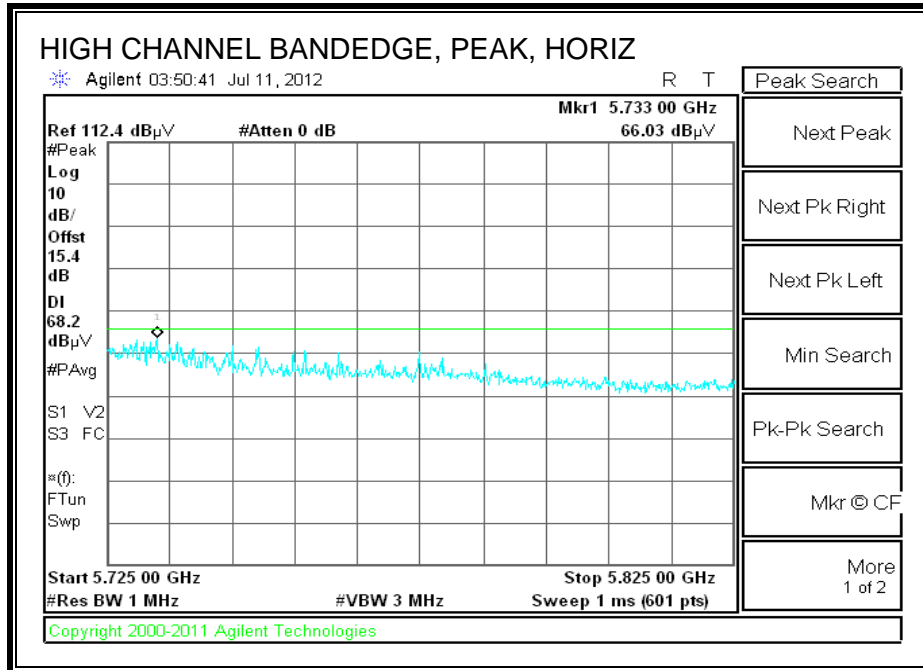

**HARMONICS AND SPURIOUS EMISSIONS**

**High Frequency Measurement**  
 Compliance Certification Services, Fremont 5m Chamber

Test Engr: Chin Pang  
 Date: 08/07/12  
 Project #: 12U14507  
 Company: Apple  
 Test Target: FCC 15.407  
 Mode Oper: HT40, 5.6GHz, TX

f Measurement Frequency Amp Preamp Gain Average Field Strength Limit  
 Dist Distance to Antenna D Corr Distance Correct to 3 meters Peak Field Strength Limit  
 Read Analyzer Reading Avg Average Field Strength @ 3 m Margin vs. Average Limit  
 AF Antenna Factor Peak Calculated Peak Field Strength Margin vs. Peak Limit  
 CL Cable Loss HPF High Pass Filter

f GHz	Dist (m)	Read dBuV	AF dB/m	CL dB	Amp dB	D Corr dB	Filtr dB	Corr. dB	Limit dBuV/m	Margin dB	Ant. Pol. V/H	Det. P/A/QP	Notes
<b>Low Ch. 5510MHz</b>													
11.020	3.0	33.1	38.4	10.1	-35.6	0.0	0.7	46.7	74.0	-27.3	V	P	
11.020	3.0	23.5	38.4	10.1	-35.6	0.0	0.7	37.0	54.0	-17.0	V	A	
11.020	3.0	33.1	38.4	10.1	-35.6	0.0	0.7	46.6	74.0	-27.4	H	P	
11.020	3.0	23.4	38.4	10.1	-35.6	0.0	0.7	37.0	54.0	-17.0	H	A	
<b>Mid Ch. 5550MHz</b>													
11.100	3.0	34.5	38.7	10.4	-35.6	0.0	0.7	48.7	74.0	-25.3	H	P	
11.100	3.0	24.6	38.7	10.4	-35.6	0.0	0.7	38.8	54.0	-15.2	H	A	
11.100	3.0	35.0	38.7	10.4	-35.6	0.0	0.7	49.2	74.0	-24.8	V	P	
11.100	3.0	24.4	38.7	10.4	-35.6	0.0	0.7	38.6	54.0	-15.4	V	A	
<b>High Ch. 5670MHz</b>													
11.340	3.0	34.3	38.7	10.4	-35.6	0.0	0.7	48.5	74.0	-25.5	H	P	
11.340	3.0	24.2	38.7	10.4	-35.6	0.0	0.7	38.4	54.0	-15.6	H	A	
11.340	3.0	34.5	38.7	10.4	-35.6	0.0	0.7	48.7	74.0	-25.3	V	P	
11.340	3.0	24.2	38.7	10.4	-35.6	0.0	0.7	38.4	54.0	-15.6	V	A	

Rev. 4.1.2.7

Note: No other emissions were detected above the system noise floor.

### 9.2.1. 2.4GHZ AND 5GHZ BAND CO-LOCATION

#### BANDEDGE (CHANNEL 36 and Bluetooth High CHANNEL)

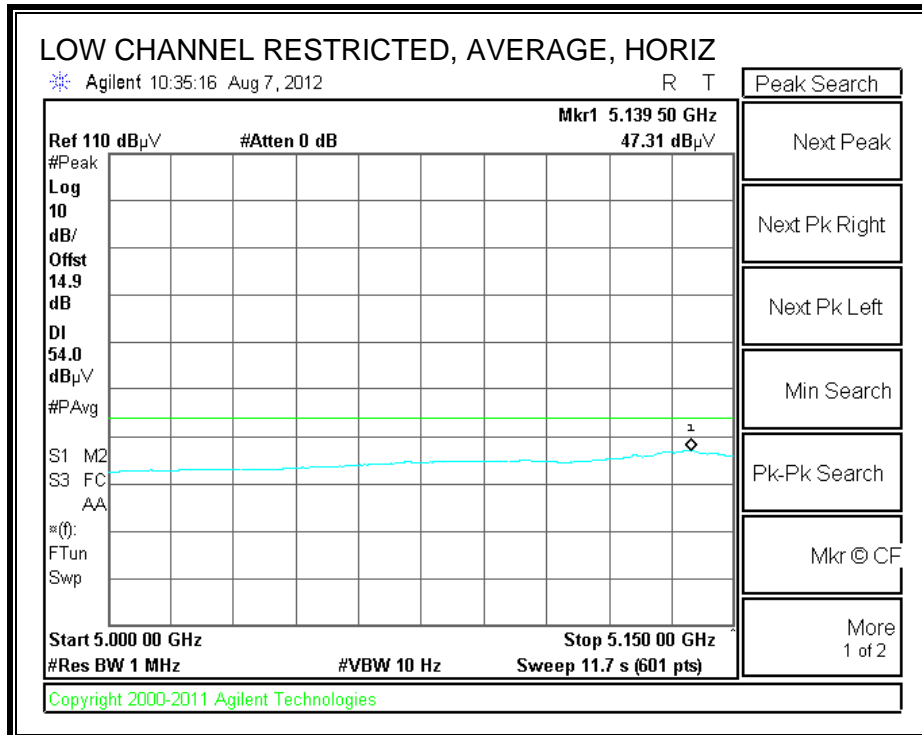
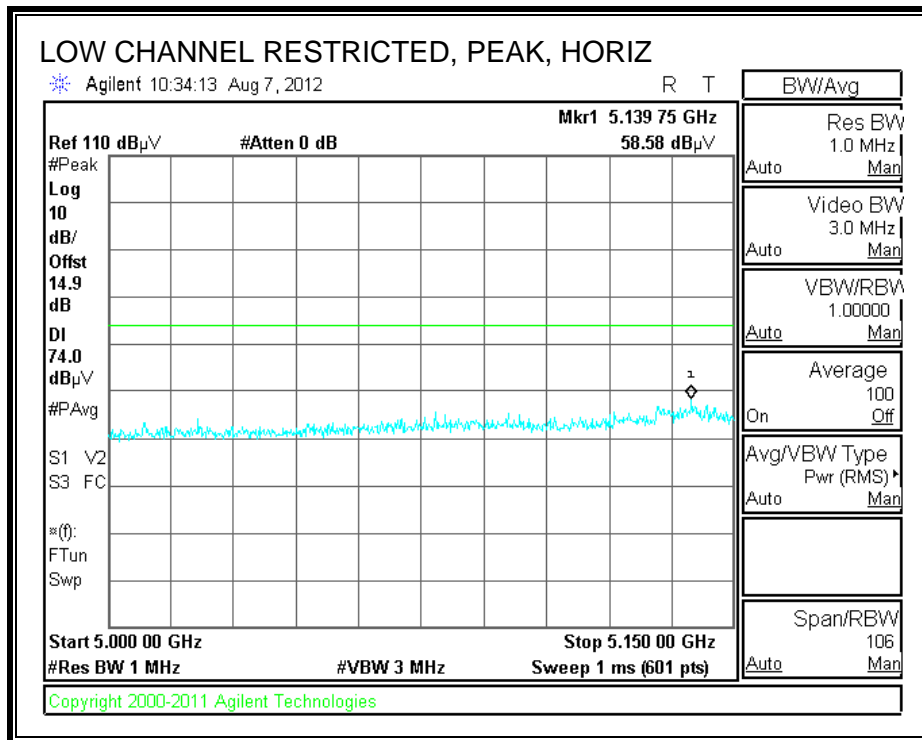

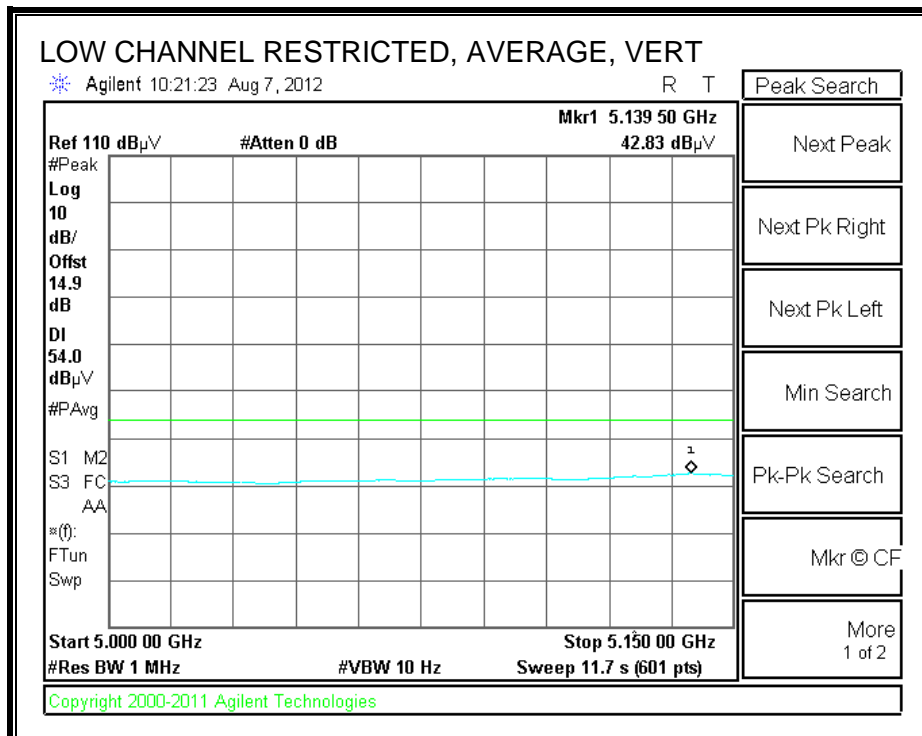
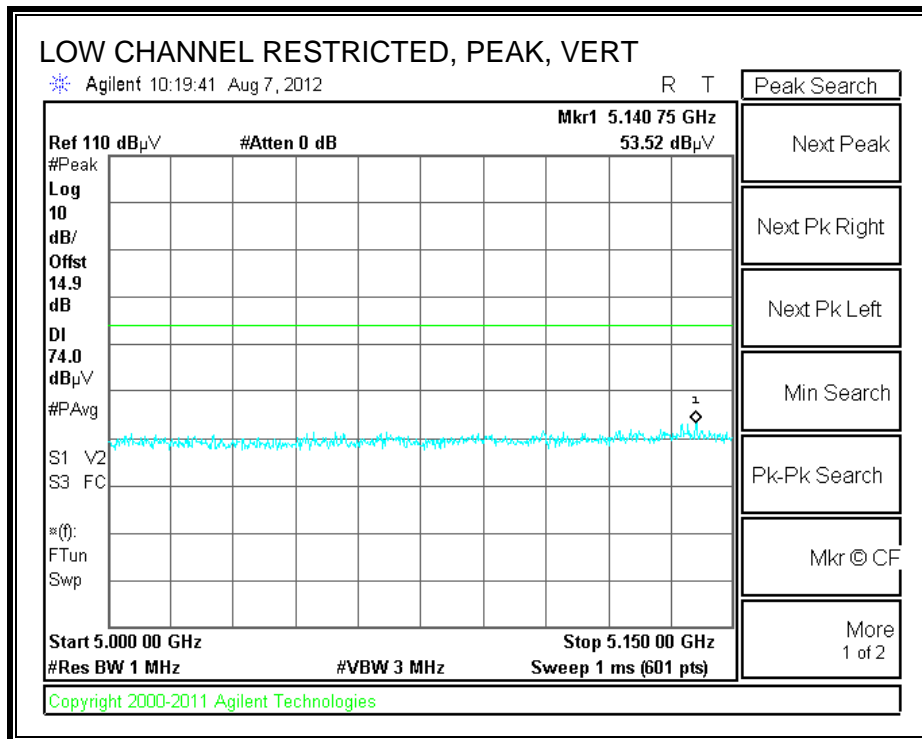



**HARMONICS AND SPURIOUS EMISSIONS**

**High Frequency Measurement**  
 Compliance Certification Services, Fremont 5m Chamber

Test Engr: Chin Pang  
 Date: 08/14/12  
 Project #: 12U14507  
 Company: Apple  
 Test Target: FCC 15.407  
 Mode Oper: Co-location, 5GHz and BTHigh Ch, TX

f Measurement Frequency Amp Preamp Gain Average Field Strength Limit  
 Dist Distance to Antenna D Corr Distance Correct to 3 meters Peak Field Strength Limit  
 Read Analyzer Reading Avg Average Field Strength @ 3 m Margin vs. Average Limit  
 AF Antenna Factor Peak Calculated Peak Field Strength Margin vs. Peak Limit  
 CL Cable Loss HPF High Pass Filter

f GHz	Dist (m)	Read dBuV	AF dB/m	CL dB	Amp dB	D Corr dB	Fltr dB	Corr. dBuV/m	Limit dBuV/m	Margin dB	Ant. Pol. V/H	Det. P/A/QP	Notes
10.360	3.0	35.5	38.2	9.4	-35.8	0.0	0.0	47.4	74.0	-26.6	V	P	
10.360	3.0	22.5	38.2	9.4	-35.8	0.0	0.0	34.3	54.0	-19.7	V	A	
15.540	3.0	35.3	39.0	12.5	-34.0	0.0	0.0	52.8	74.0	-21.2	V	P	
15.540	3.0	22.3	39.0	12.5	-34.0	0.0	0.0	39.8	54.0	-14.2	V	A	
10.360	3.0	35.3	38.2	9.4	-35.8	0.0	0.0	47.1	74.0	-26.9	H	P	
10.360	3.0	22.5	38.2	9.4	-35.8	0.0	0.0	34.3	54.0	-19.7	H	A	
15.540	3.0	36.0	39.0	12.5	-34.0	0.0	0.0	53.5	74.0	-20.5	H	P	
15.540	3.0	22.3	39.0	12.5	-34.0	0.0	0.0	39.8	54.0	-14.2	H	A	

Rev. 4.1.2.7

Note: No other emissions were detected above the system noise floor.

### 9.3. WORST-CASE BELOW 1 GHz

#### SPURIOUS EMISSIONS 30 TO 1000 MHz (WORST-CASE CONFIGURATION, HORIZONTAL)

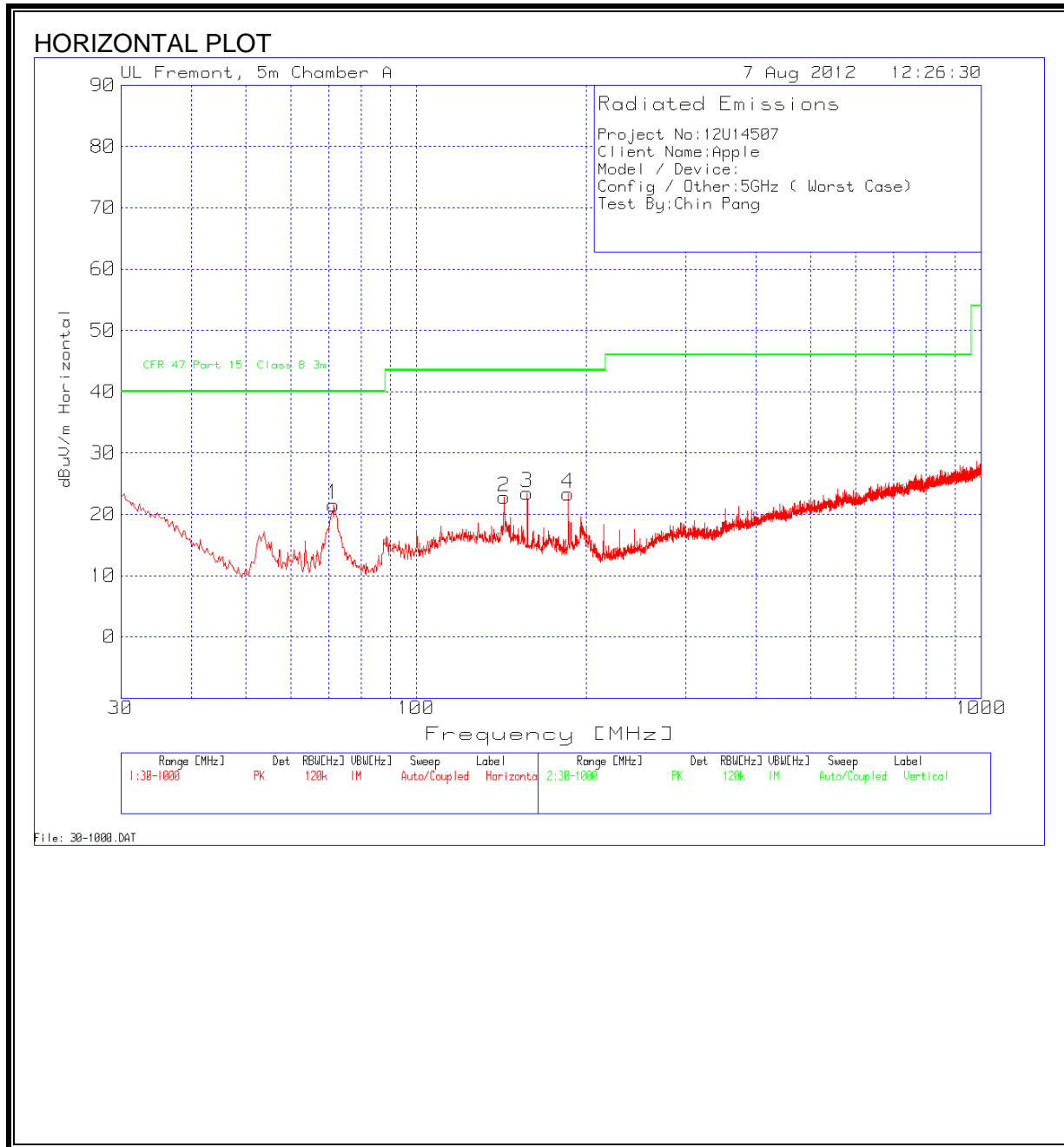

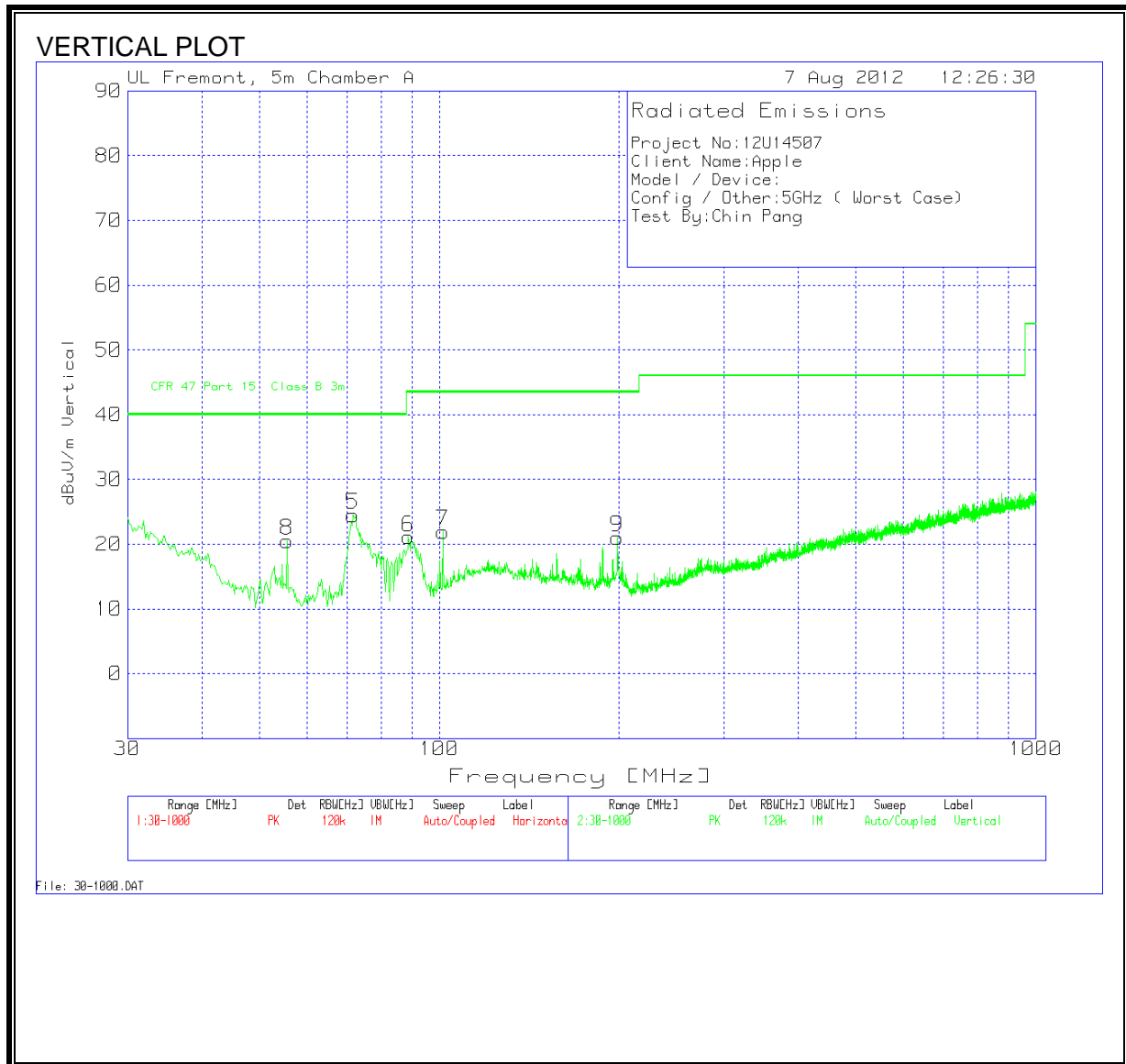

DATA

Project No:12U14507								
Client Name:Apple								
Model / Device:								
Config / Other:5GHz ( Worst Case)								
Test By:Chin Pang								
Horizontal 30 - 1000MHz								
Frequency	Reading	Detector	25MHz-1GHz	T243 Sunol	dBuV/m	CFR 47 Part 15B	Margin	Polarity
71.4828	40.6	PK	-27.1	8.1	21.6	40	-18.4	Horz
143.0116	36.77	PK	-26.6	12.6	22.77	43.5	-20.73	Horz
157.3561	37.94	PK	-26.5	12	23.44	43.5	-20.06	Horz
186.0452	38.52	PK	-26.4	11.2	23.32	43.5	-20.18	Horz
Vertical 30 - 1000MHz								
Frequency	Reading	Detector	25MHz-1GHz	T243 Sunol	dBuV/m	CFR 47 Part 15B	Margin	Polarity
71.6767	43.46	PK	-27.1	8.1	24.46	40	-15.54	Vert
88.735	40.59	PK	-27	7.5	21.09	43.5	-22.41	Vert
101.3349	38.26	PK	-26.9	10.6	21.96	43.5	-21.54	Vert
55.5875	40.69	PK	-27.3	7.1	20.49	40	-19.51	Vert
199.0328	35.02	PK	-26.2	12.2	21.02	43.5	-22.48	Vert

## 10. AC POWER LINE CONDUCTED EMISSIONS

### LIMITS

FCC §15.207 (a)

RSS-Gen 7.2.2

Frequency of Emission (MHz)	Conducted Limit (dBuV)	
	Quasi-peak	Average
0.15-0.5	66 to 56	56 to 46
0.5-5	56	46
5-30	60	50

\*Decreases with the logarithm of the frequency.

### TEST PROCEDURE

The EUT is placed on a non-conducting table 40 cm from the vertical ground plane and 80 cm above the horizontal ground plane. The EUT is configured in accordance with ANSI C63.4.

The receiver is set to a resolution bandwidth of 9 kHz. Peak detection is used unless otherwise noted as quasi-peak or average.

Line conducted data is recorded for both NEUTRAL and HOT lines.

**RESULTS**

**6 WORST EMISSIONS**

Project No:12U14507									
Client Name:Apple									
Model/Device:iPad, 5GHz Band									
Test Volt/Freq:115VAC 60Hz									
Test By:Chin Pang									
Line-L1 .15 - 30MHz									
Frequency	Reading	Detector	T24 IL L1	LC Cables	dB(uVolts	CISPR Class B Q-p	Margin	CISPR Class B Avg	Margin
0.267	40.79	PK	0.1	0	40.89	61.2	-20.31	-	-
0.267	21.31	Av	0.1	0	21.41	-	-	51.2	-29.79
0.42	37.74	PK	0.1	0	37.84	57.4	-19.56	-	-
0.42	23.55	Av	0.1	0	23.65	-	-	47.4	-23.75
0.8475	36.85	PK	0.1	0	36.95	56	-19.05	-	-
0.8475	25.42	Av	0.1	0	25.52	-	-	46	-20.48
Line-L2 .15 - 30MHz									
Frequency	Reading	Detector	T24 IL L1	LC Cables	dB(uVolts	CISPR Class B Q-p	Margin	CISPR Class B Avg	Margin
0.2805	40.38	PK	0.1	0	40.48	60.8	-20.32	-	-
0.2805	22.02	Av	0.1	0	22.12	-	-	50.8	-28.68
0.4155	37.71	PK	0.1	0	37.81	57.5	-19.69	-	-
0.4155	22.82	Av	0.1	0	22.92	-	-	47.5	-24.58
0.843	34.31	PK	0.1	0.1	34.51	56	-21.49	-	-
0.843	23.34	Av	0.1	0.1	23.54	-	-	46	-22.46

**LINE 1 RESULTS**

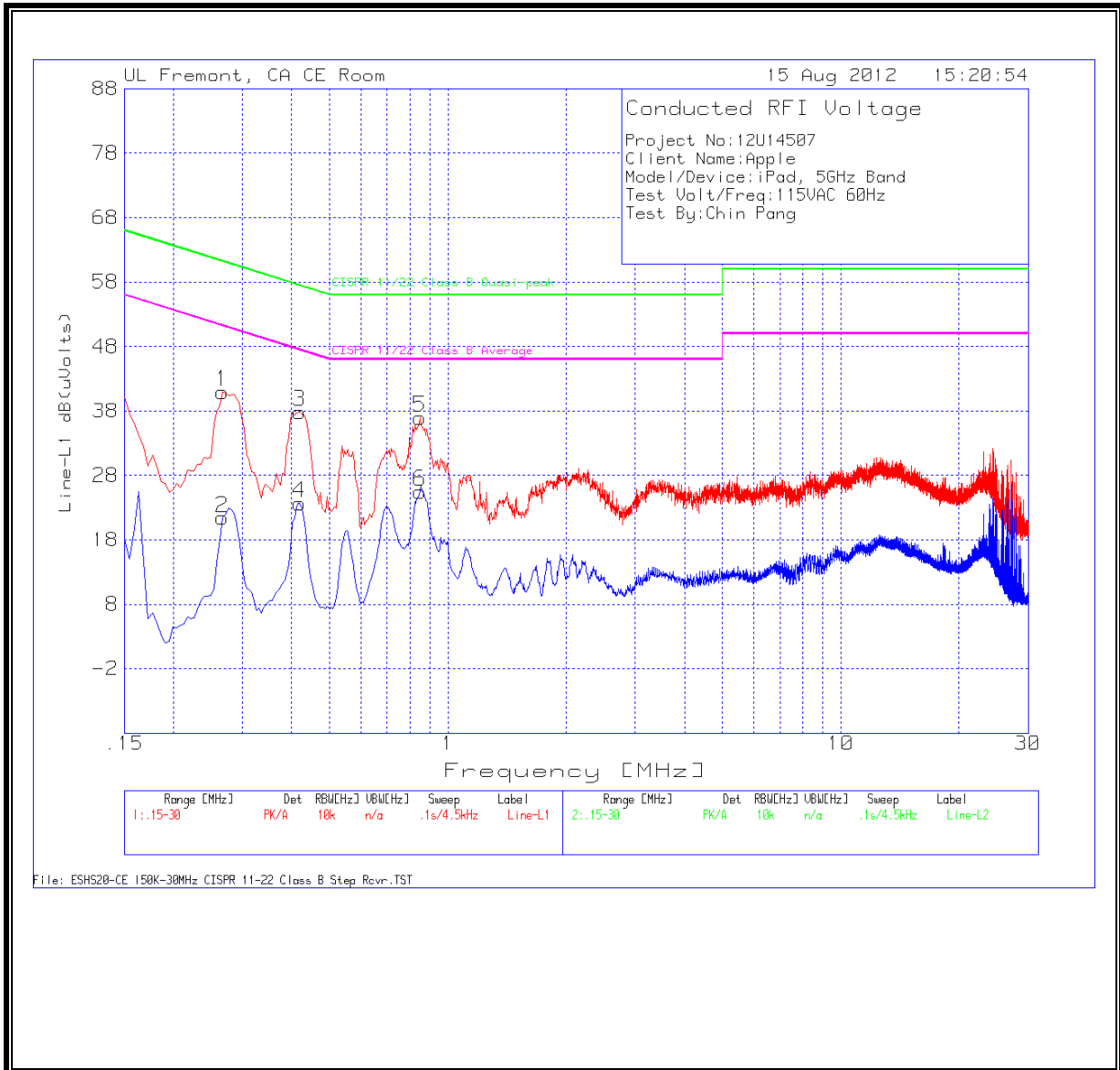

**LINE 2 RESULTS**

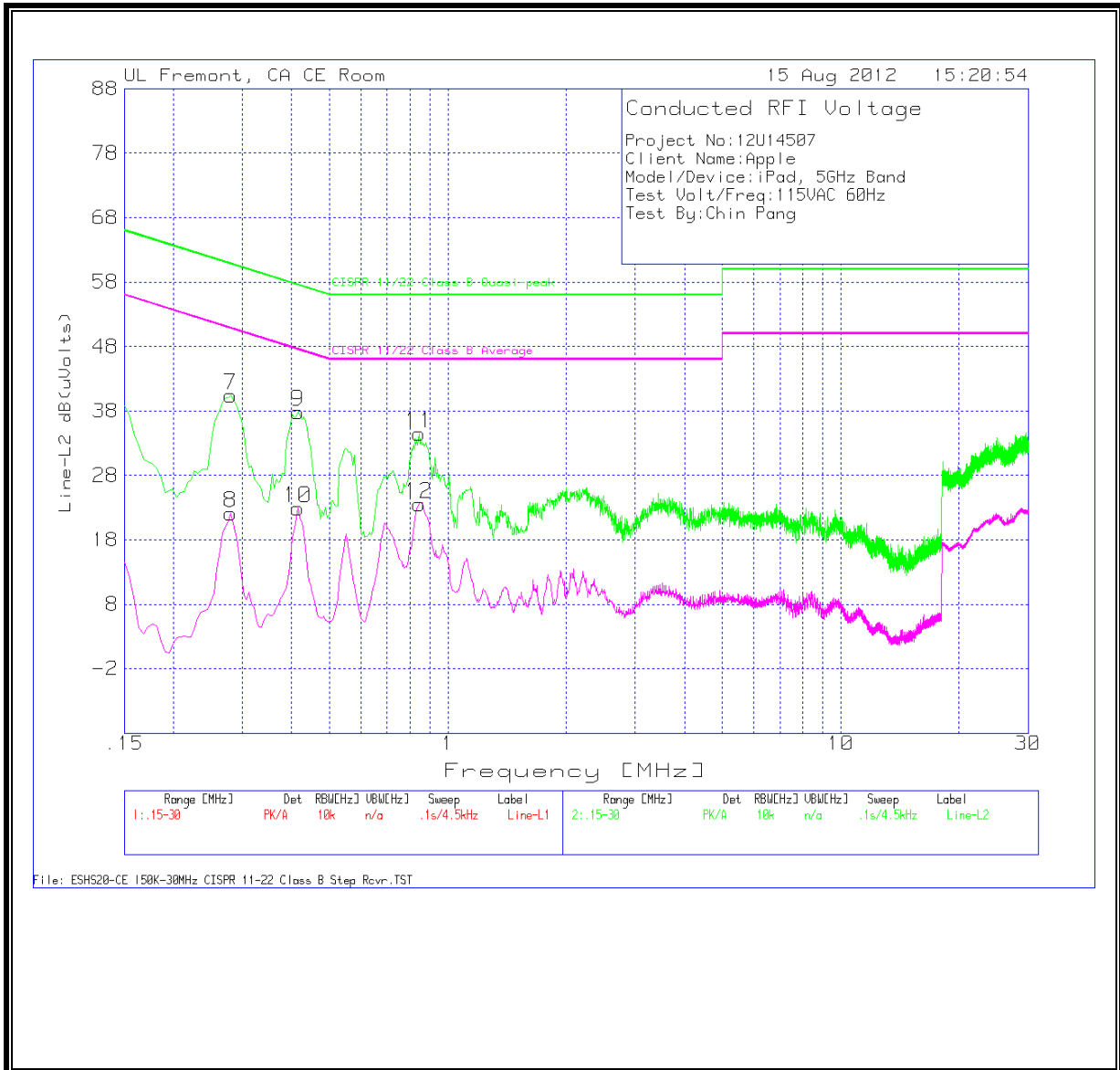



## 11. DYNAMIC FREQUENCY SELECTION

### 11.1. OVERVIEW

#### 11.1.1. LIMITS

##### INDUSTRY CANADA

IC RSS-210 is closely harmonized with FCC Part 15 DFS rules. The deviations are as follows:

RSS-210 Issue 7 A9.4 (b) (ii) **Channel Availability Check Time:** ...

**Additional requirements for the band 5600-5650 MHz:** Until further notice, devices subject to this Section shall not be capable of transmitting in the band 5600-5650 MHz, so that Environment Canada weather radars operating in this band are protected.

RSS-210 Issue 7 A9.4 (b) (iv) **Channel closing time:** the maximum channel closing time is 260 ms.

##### FCC

§15.407 (h) and FCC 06-96 APPENDIX "COMPLIANCE MEASUREMENT PROCEDURES FOR UNLICENSED-NATIONAL INFORMATION INFRASTRUCTURE DEVCIES OPERATING IN THE 5250-5350 MHz AND 5470-5725 MHz BANDS INCORPORATING DYNAMIC FREQUENCY SELECTION".

Testing was also conducted per KDB 365942.

**Table 1: Applicability of DFS requirements prior to use of a channel**

Requirement	Operational Mode		
	Master	Client (without radar detection)	Client (with radar detection)
Non-Occupancy Period	Yes	Not required	Yes
DFS Detection Threshold	Yes	Not required	Yes
Channel Availability Check Time	Yes	Not required	Not required
Uniform Spreading	Yes	Not required	Not required

**Table 2: Applicability of DFS requirements during normal operation**

Requirement	Operational Mode		
	Master	Client (without DFS)	Client (with DFS)
DFS Detection Threshold	Yes	Not required	Yes
Channel Closing Transmission Time	Yes	Yes	Yes
Channel Move Time	Yes	Yes	Yes

**Table 3: Interference Threshold values, Master or Client incorporating In-Service Monitoring**

Maximum Transmit Power	Value (see note)
≥ 200 milliwatt	-64 dBm
< 200 milliwatt	-62 dBm

Note 1: This is the level at the input of the receiver assuming a 0 dBi receive antenna  
 Note 2: Throughout these test procedures an additional 1 dB has been added to the amplitude of the test transmission waveforms to account for variations in measurement equipment. This will ensure that the test signal is at or above the detection threshold level to trigger a DFS response.

**Table 4: DFS Response requirement values**

Parameter	Value
<i>Non-occupancy period</i>	30 minutes
<i>Channel Availability Check Time</i>	60 seconds
<i>Channel Move Time</i>	10 seconds
<i>Channel Closing Transmission Time</i>	200 milliseconds + approx. 60 milliseconds over remaining 10 second period
<p>The instant that the <i>Channel Move Time</i> and the <i>Channel Closing Transmission Time</i> begins is as follows:            For the Short pulse radar Test Signals this instant is the end of the <i>Burst</i>.            For the Frequency Hopping radar Test Signal, this instant is the end of the last radar burst generated.            For the Long Pulse radar Test Signal this instant is the end of the 12 second period defining the radar transmission.            The Channel Closing Transmission Time is comprised of 200 milliseconds starting at the beginning of the Channel Move Time plus any additional intermittent control signals required to facilitate channel changes (an aggregate of approximately 60 milliseconds) during the remainder of the 10 second period. The aggregate duration of control signals will not count quiet periods in between transmissions.</p>	

**Table 5 – Short Pulse Radar Test Waveforms**

Radar Type	Pulse Width (Microseconds)	PRI (Microseconds)	Pulses	Minimum Percentage of Successful Detection	Minimum Trials
1	1	1428	18	60%	30
2	1-5	150-230	23-29	60%	30
3	6-10	200-500	16-18	60%	30
4	11-20	200-500	12-16	60%	30
Aggregate (Radar Types 1-4)				80%	120

**Table 6 – Long Pulse Radar Test Signal**

Radar Waveform	Bursts	Pulses per Burst	Pulse Width (µsec)	Chirp Width (MHz)	PRI (µsec)	Minimum Percentage of Successful Detection	Minimum Trials
5	8-20	1-3	50-100	5-20	1000-2000	80%	30

**Table 7 – Frequency Hopping Radar Test Signal**

Radar Waveform	Pulse Width (µsec)	PRI (µsec)	Burst Length (ms)	Pulses per Hop	Hopping Rate (kHz)	Minimum Percentage of Successful Detection	Minimum Trials
6	1	333	300	9	.333	70%	30

### 11.1.2. TEST AND MEASUREMENT SYSTEM

#### RADIATED METHOD SYSTEM BLOCK DIAGRAM

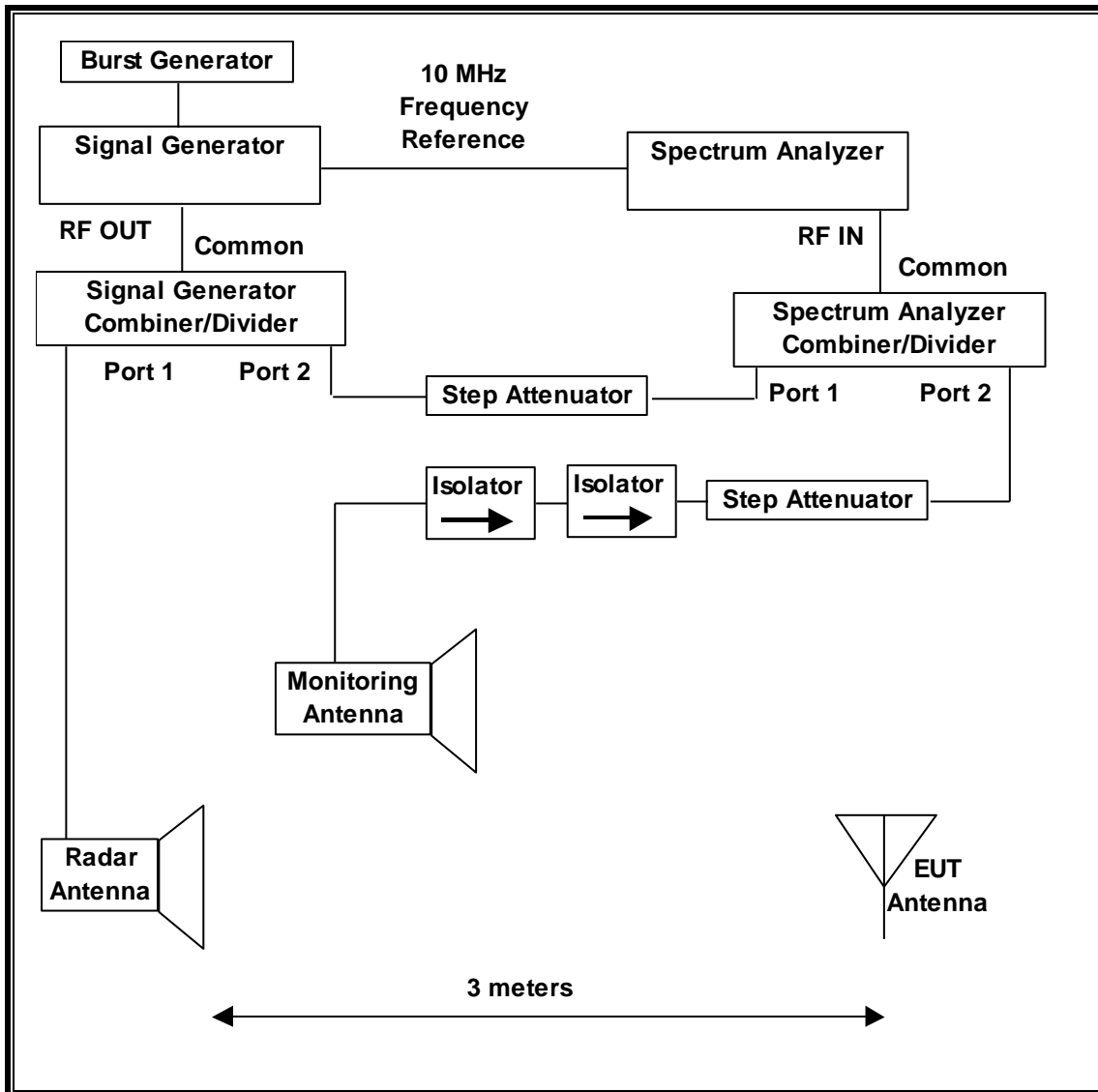

## **SYSTEM OVERVIEW**

The short pulse and long pulse signal generating system utilizes the NTIA software. The Vector Signal Generator has been validated by the NTIA. The hopping signal generating system utilizes the CCS simulated hopping method and system, which has been validated by the DoD, FCC and NTIA. The software selects waveform parameters from within the bounds of the signal type on a random basis using uniform distribution.

The short pulse types 2, 3 and 4, and the long pulse type 5 parameters are randomized at run-time.

The hopping type 6 pulse parameters are fixed while the hopping sequence is based on the August 2005 NTIA Hopping Frequency List. The initial starting point randomized at run-time and each subsequent starting point is incremented by 475. Each frequency in the 100-length segment is compared to the boundaries of the EUT Detection Bandwidth and the software creates a hopping burst pattern in accordance with Section 7.4.1.3 Method #2 Simulated Frequency Hopping Radar Waveform Generating Subsystem of FCC 06-96 APPENDIX. The frequency of the signal generator is incremented in 1 MHz steps from  $F_L$  to  $F_H$  for each successive trial. This incremental sequence is repeated as required to generate a minimum of 30 total trials and to maintain a uniform frequency distribution over the entire Detection Bandwidth.

The signal monitoring equipment consists of a spectrum analyzer. The aggregate ON time is calculated by multiplying the number of bins above a threshold during a particular observation period by the dwell time per bin, with the analyzer set to peak detection and max hold.

## **SYSTEM CALIBRATION**

A 50-ohm load is connected in place of the spectrum analyzer, and the spectrum analyzer is connected to a horn antenna via a coaxial cable, with the reference level offset set to (horn antenna gain – coaxial cable loss). The signal generator is set to CW mode. The amplitude of the signal generator is adjusted to yield a level of –64 dBm as measured on the spectrum analyzer.

Without changing any of the instrument settings, the spectrum analyzer is reconnected to the Common port of the Spectrum Analyzer Combiner/Divider. The Reference Level Offset of the spectrum analyzer is adjusted so that the displayed amplitude of the signal is –64 dBm.

The spectrum analyzer displays the level of the signal generator as received at the antenna ports of the Master Device. The interference detection threshold may be varied from the calibrated value of –64 dBm and the spectrum analyzer will still indicate the level as received by the Master Device.

**ADJUSTMENT OF DISPLAYED TRAFFIC LEVEL**

A link is established between the Master and Slave and the distance between the units is adjusted as needed to provide a suitable received level at the Master and Slave devices. The video test file is streamed to generate WLAN traffic. The monitoring antenna is adjusted so that the WLAN traffic level, as displayed on the spectrum analyzer, is at lower amplitude than the radar detection threshold.

**TEST AND MEASUREMENT EQUIPMENT**

The following test and measurement equipment was utilized for the DFS tests documented in this report:

<b>TEST EQUIPMENT LIST</b>				
<b>Description</b>	<b>Manufacturer</b>	<b>Model</b>	<b>Asset Number</b>	<b>Cal Due</b>
Spectrum Analyzer, 26.5 GHz	Agilent / HP	E4440A	C01178	08/15/12
Vector Signal Generator, 20GHz	Agilent / HP	E8267C	C01066	11/17/12

**11.1.3. SETUP OF EUT**

**CLIENT MODE:**

**RADIATED METHOD EUT TEST SETUP**

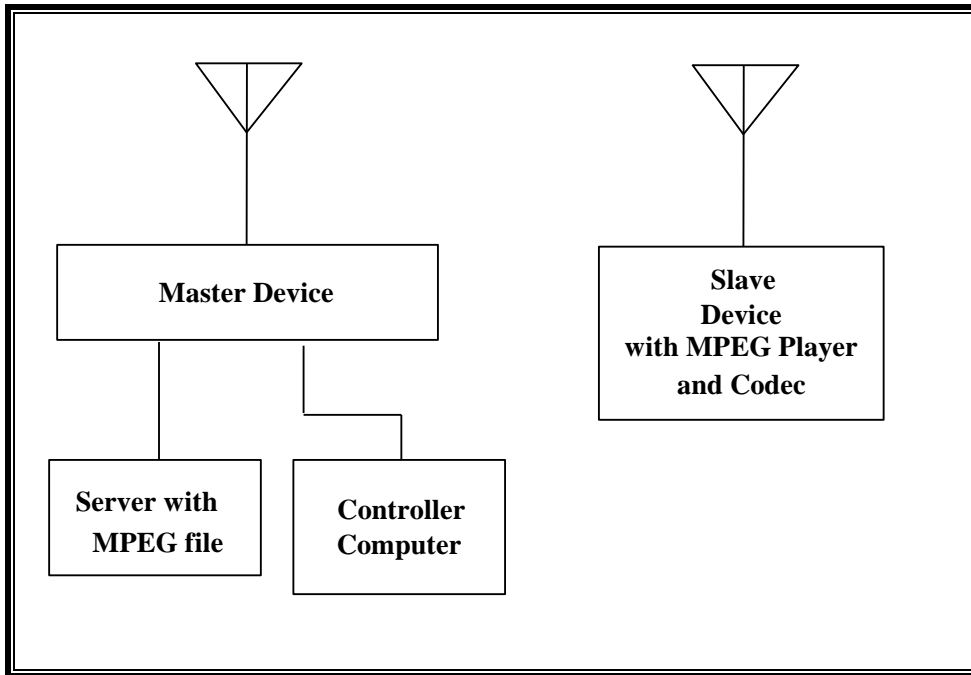

**SUPPORT EQUIPMENT**

The following support equipment was utilized for the DFS tests documented in this report:

PERIPHERAL SUPPORT EQUIPMENT LIST				
Description	Manufacturer	Model	Serial Number	FCC ID
Wireless Access Point (Master Device)	Cisco	AIR-AP1252AG-A-K9	FTX130390D9	LDK102061
AC Adapter (AP)	Delta Electronics	EADP-45BB B	DTH1049902N	DoC
Notebook PC (Server)	Apple	MacBook Pro A1150	AOU257941	DoC
AC Adapter (Server)	Delta Electronics	A1344	MV05104CNAL1A	DoC
Notebook PC (Controller)	Dell	PP18L	10657517725	DoC
AC Adapter (Controller PC)	Dell	LA65SN0-00	CN-ODF263-71615-6AU-1019	DoC

**CLIENT-TO-CLIENT COMMUNICATIONS MODE:**

**RADIATED METHOD EUT TEST SETUP**

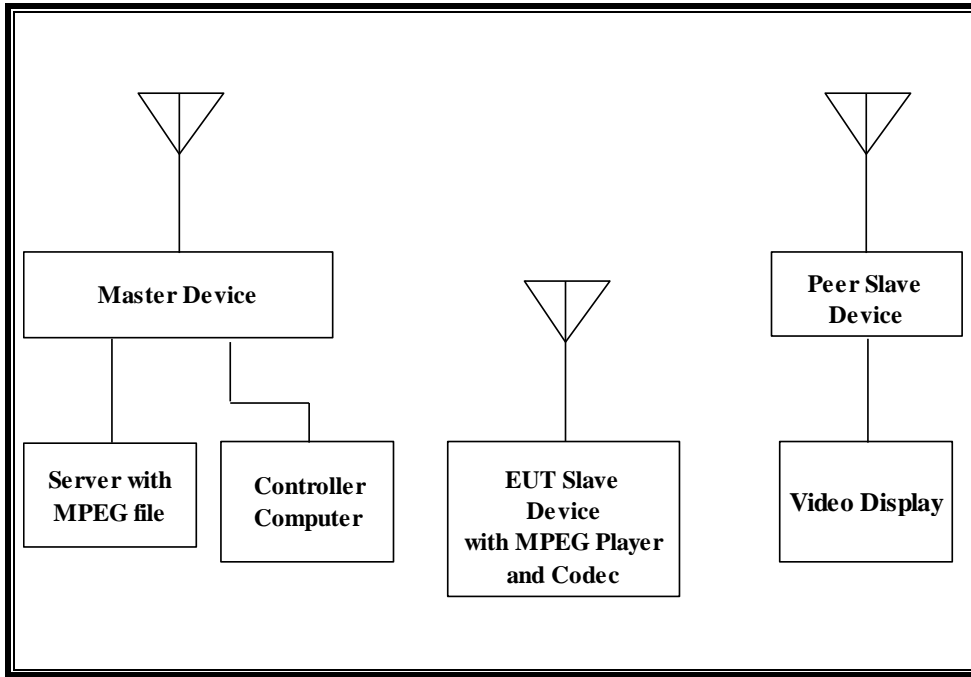

**SUPPORT EQUIPMENT**

The following support equipment was utilized for the DFS tests documented in this report:

PERIPHERAL SUPPORT EQUIPMENT LIST				
Description	Manufacturer	Model	Serial Number	FCC ID
Wireless Access Point (Master Device)	Cisco	AIR-AP1252AG-A-K9	FTX130390D9	LDK102061
AC Adapter (AP)	Delta Electronics	EADP-45BB B	DTH1049902N	DoC
Notebook PC (Server)	Apple	MacBook Pro A1150	AOU257941	DoC
AC Adapter (Server)	Delta Electronics	A1344	MV05104CNAL1A	DoC
Notebook PC (Controller)	Dell	PP18L	10657517725	DoC
AC Adapter (Controller PC)	Dell	LA65SN0-00	CN-ODF263-71615-6AU-1019	DoC
Apple TV (Peer Slave Device)	Apple	A1427	C07GY040F14P	BCGA1427
LCD Monitor	Dell	Prototype	6279	N/A



#### **11.1.4. DESCRIPTION OF EUT**

The EUT operates over the 5250-5350 MHz and 5470-5725 MHz ranges.

The EUT is a Slave Device without Radar Detection.

The highest power level within these bands is 22.45 dBm EIRP in the 5250-5350 MHz band and 23.17 dBm EIRP in the 5470-5725 MHz band.

The only antenna assembly utilized with the EUT has a gain of 4.25 dBi in the 5250-5350 MHz band and 4.51 dBi in the 5470-5725 MHz band.

The rated output power of the Master unit is > 23dBm (EIRP). Therefore the required interference threshold level is -64 dBm. After correction for procedural adjustments, the required radiated threshold at the antenna port is  $-64 + 1 = -63$  dBm.

The calibrated radiated DFS Detection Threshold level is set to -64 dBm. The tested level is lower than the required level hence it provides margin to the limit.

The EUT uses one transmitter/receiver chain connected to an antenna to perform radiated tests.

In the client mode, WLAN traffic is generated by streaming the video file TestFile.mp2 "6 ½ Magic Hours" from the Master to the Slave in full motion video mode using Safari web browser. In the Client-to-Client Communications mode, WLAN traffic is generated by streaming the video file TestFile.mp2 "6 ½ Magic Hours" from the Master, to the Slave, and mirror to the peer slave device in full motion video mode using Safari web browser.

TPC is not required since the maximum EIRP is less than 500 mW (27 dBm).

The EUT utilizes the 802.11a/n architecture. Two nominal channel bandwidths of 20 MHz and 40 MHz are implemented in standard client mode.

One nominal channel bandwidth of 20 MHz is implemented in Client-to-Client Communications mode.

The software installed in the EUT is IOS (Build 10A371).

#### **UNIFORM CHANNEL SPREADING**

This requirement is not applicable to Slave radio devices.

**OVERVIEW OF MASTER DEVICE WITH RESPECT TO §15.407 (h) REQUIREMENTS**

The Master Device is a Cisco Access Point, FCC ID: LDK102061. The minimum antenna gain for the Master Device is 3.5 dBi.

The rated output power of the Master unit is  $> 23\text{dBm}$  (EIRP). Therefore the required interference threshold level is  $-64\text{ dBm}$ . After correction for procedural adjustments, the required radiated threshold at the antenna port is  $-64 + 1 = -63\text{ dBm}$ .

The calibrated radiated DFS Detection Threshold level is set to  $-64\text{ dBm}$ . The tested level is lower than the required level hence it provides margin to the limit.

## 11.2. CLIENT MODE RESULTS FOR 20 MHz BANDWIDTH

### 11.2.1. TEST CHANNEL

All tests were performed at a channel center frequency of 5300 MHz.

### 11.2.2. RADAR WAVEFORM AND TRAFFIC

#### RADAR WAVEFORM

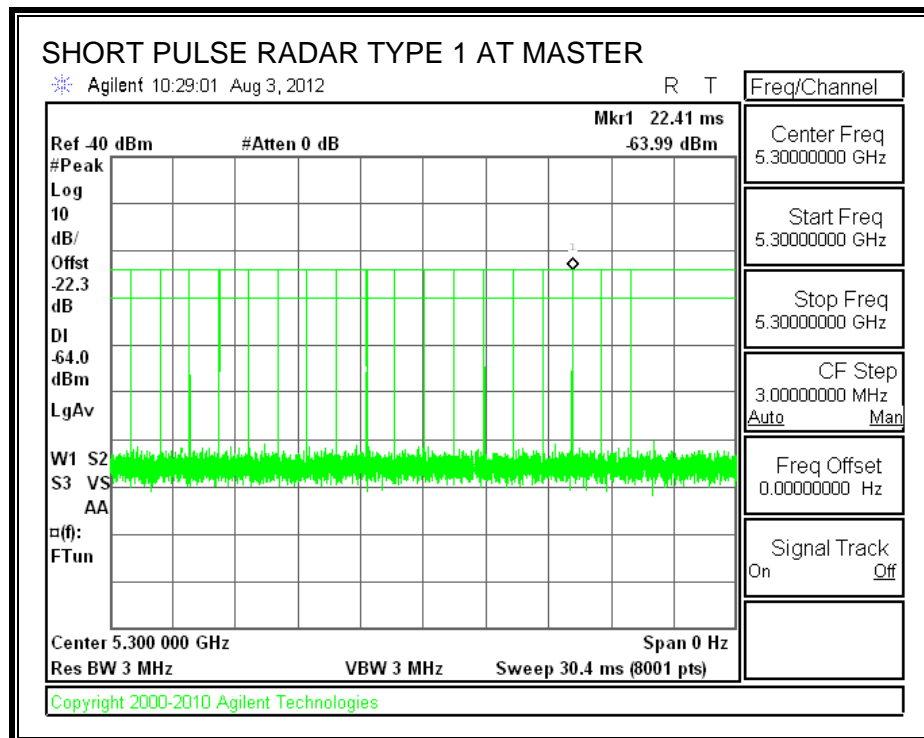

**TRAFFIC**

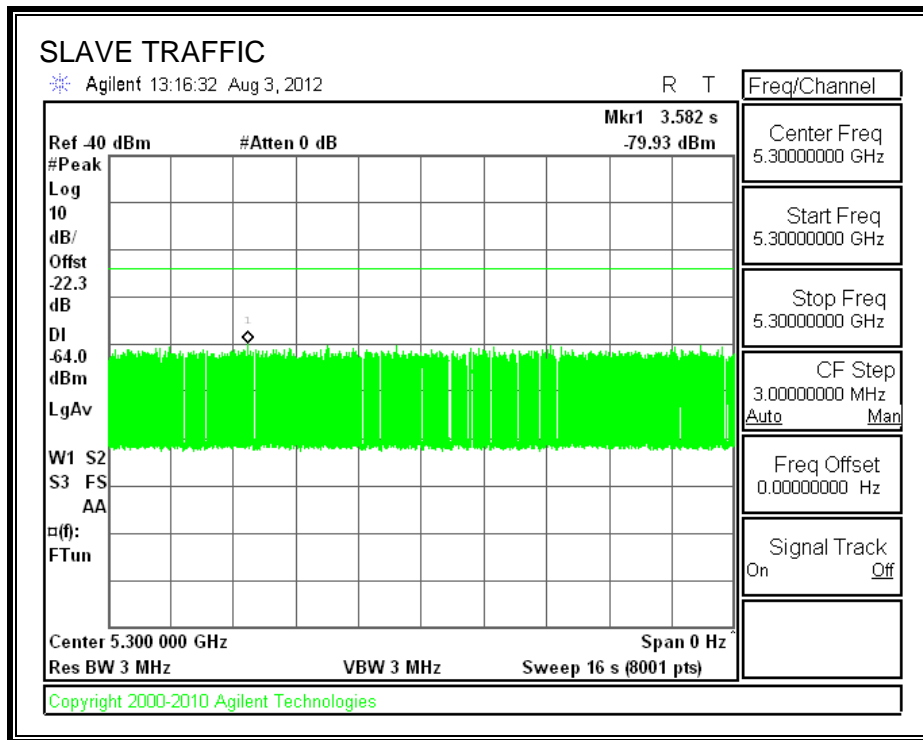

**11.2.3. OVERLAPPING CHANNEL TESTS**

**RESULTS**

These tests are not applicable.

**11.2.4. MOVE AND CLOSING TIME**

**REPORTING NOTES**

The reference marker is set at the end of last radar pulse.

The delta marker is set at the end of the last WLAN transmission following the radar pulse. This delta is the channel move time.

The aggregate channel closing transmission time is calculated as follows:

Aggregate Transmission Time =  
 (Number of analyzer bins showing transmission) \* (dwell time per bin)

The observation period over which the FCC aggregate time is calculated begins at (Reference Marker + 200 msec) and ends no earlier than (Reference Marker + 10 sec).

The observation period over which the IC aggregate time is calculated begins at (Reference Marker) and ends no earlier than (Reference Marker + 10 sec).

**RESULTS**

Agency	Channel Move Time (sec)	Limit (sec)
FCC / IC	0.000	10

Agency	Aggregate Channel Closing Transmission Time (msec)	Limit (msec)
FCC	0.0	60
IC	0.0	260

**MOVE TIME**

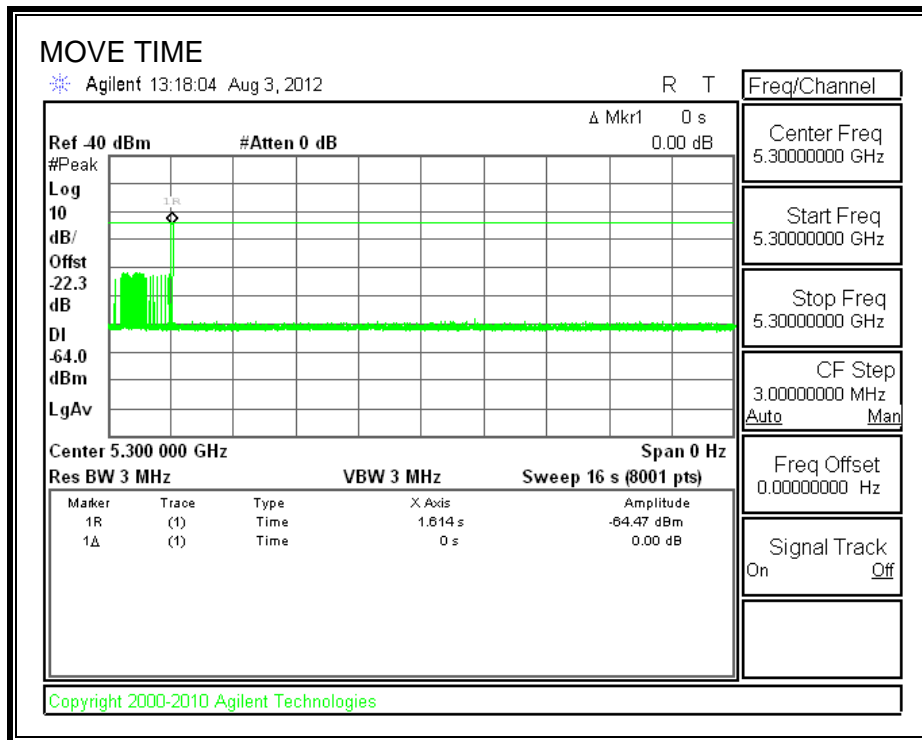

**CHANNEL CLOSING TIME**

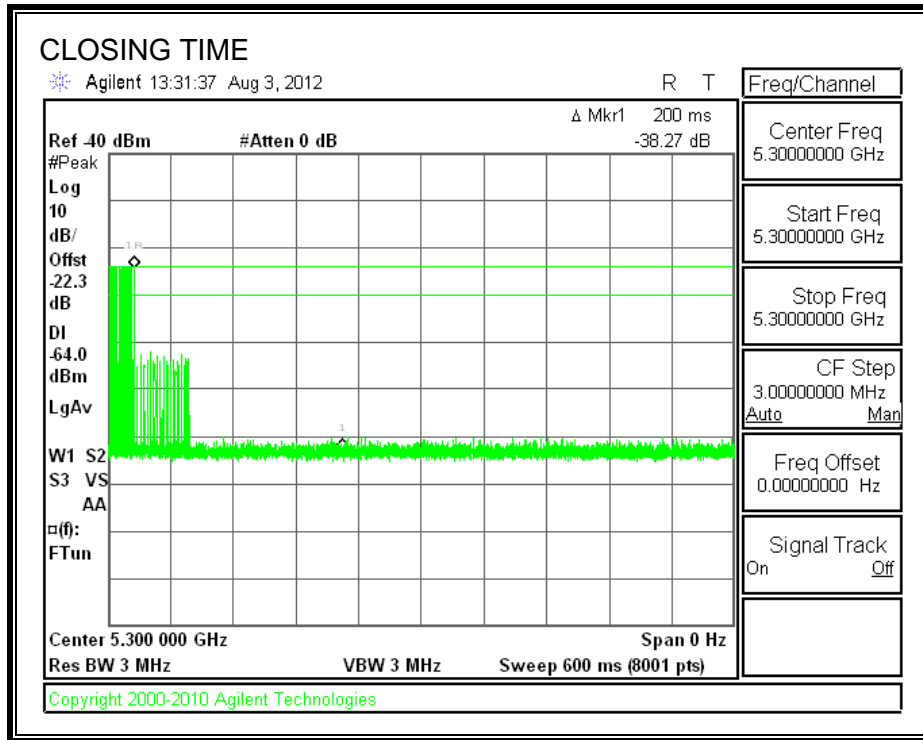

**AGGREGATE CHANNEL CLOSING TRANSMISSION TIME**

No transmissions are observed during the FCC aggregate monitoring period.

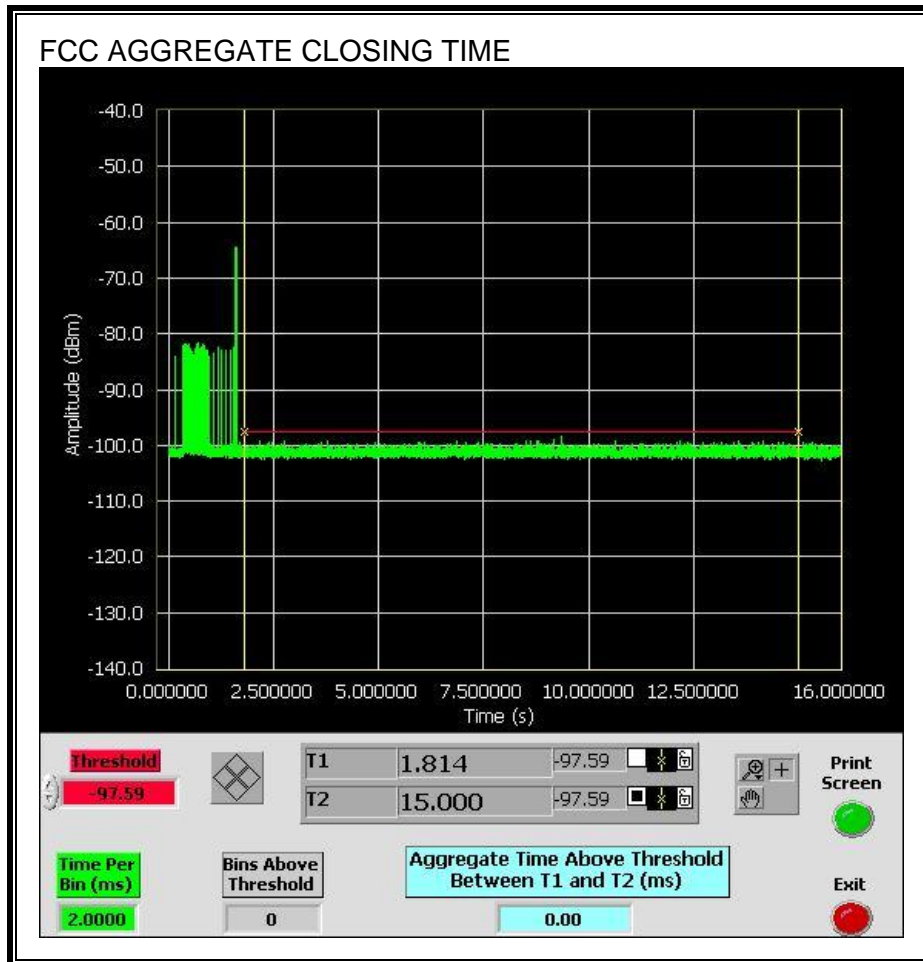



No transmissions are observed during the IC aggregate monitoring period.

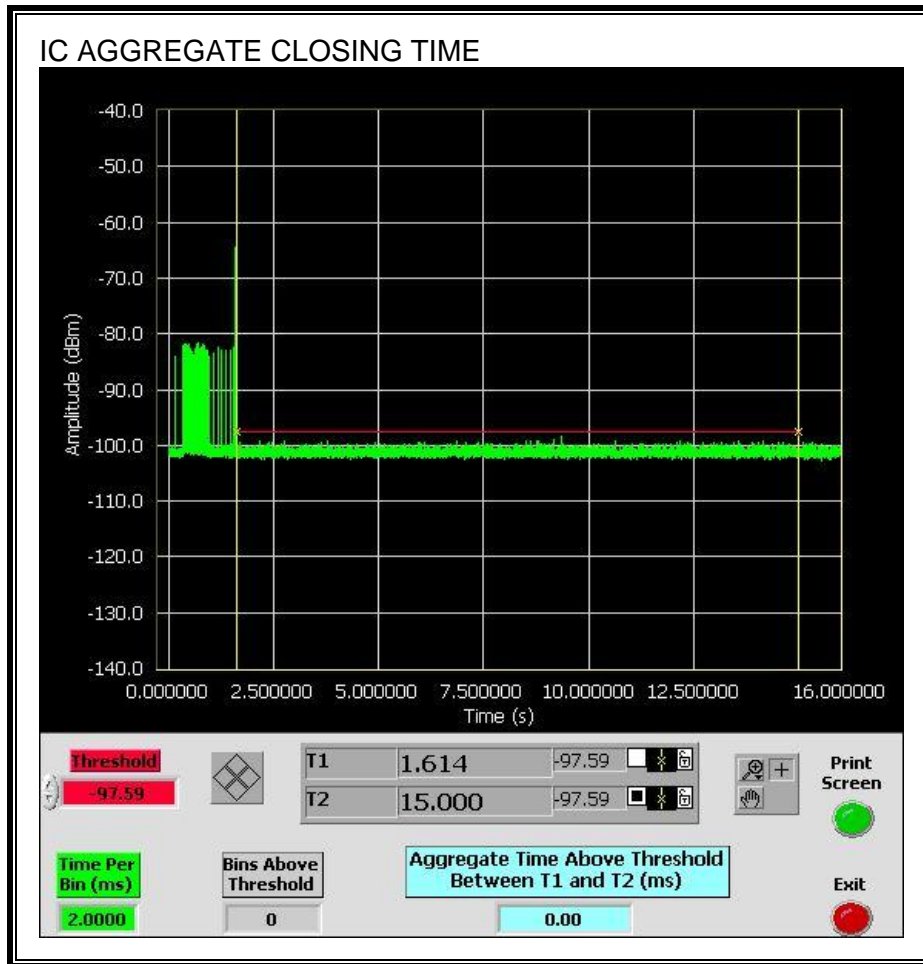

### 11.3. CLIENT MODE RESULTS FOR 40 MHz BANDWIDTH

#### 11.3.1. TEST CHANNEL

All tests were performed at a channel center frequency of 5310 MHz.

#### 11.3.2. RADAR WAVEFORM AND TRAFFIC

##### RADAR WAVEFORM

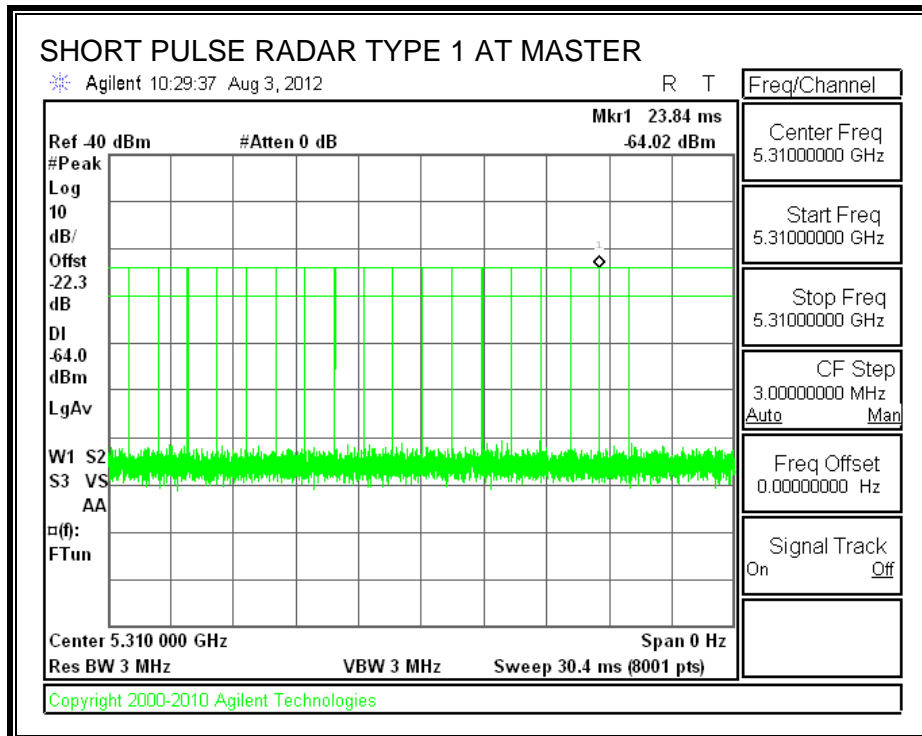

**TRAFFIC**

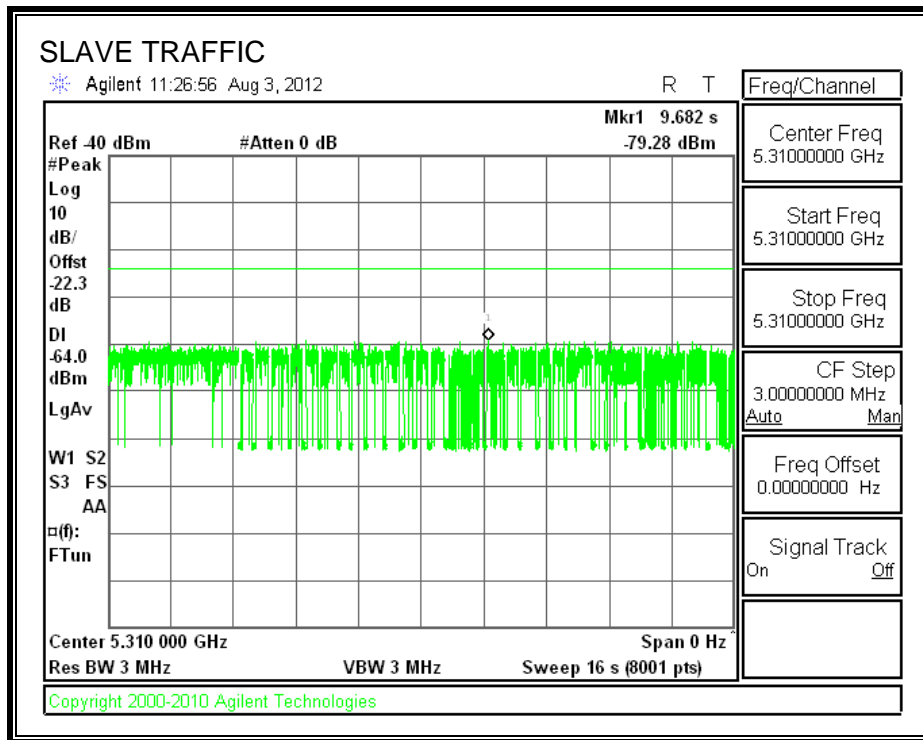

### 11.3.3. OVERLAPPING CHANNEL TESTS

#### RESULTS

These tests are not applicable.

### 11.3.4. MOVE AND CLOSING TIME

#### REPORTING NOTES

The reference marker is set at the end of last radar pulse.

The delta marker is set at the end of the last WLAN transmission following the radar pulse. This delta is the channel move time.

The aggregate channel closing transmission time is calculated as follows:

Aggregate Transmission Time =  
(Number of analyzer bins showing transmission) \* (dwell time per bin)

The observation period over which the FCC aggregate time is calculated begins at (Reference Marker + 200 msec) and ends no earlier than (Reference Marker + 10 sec).

The observation period over which the IC aggregate time is calculated begins at (Reference Marker) and ends no earlier than (Reference Marker + 10 sec).

#### RESULTS

Agency	Channel Move Time (sec)	Limit (sec)
FCC / IC	0.026	10

Agency	Aggregate Channel Closing Transmission Time (msec)	Limit (msec)
FCC	0.0	60
IC	26.0	260

**MOVE TIME**

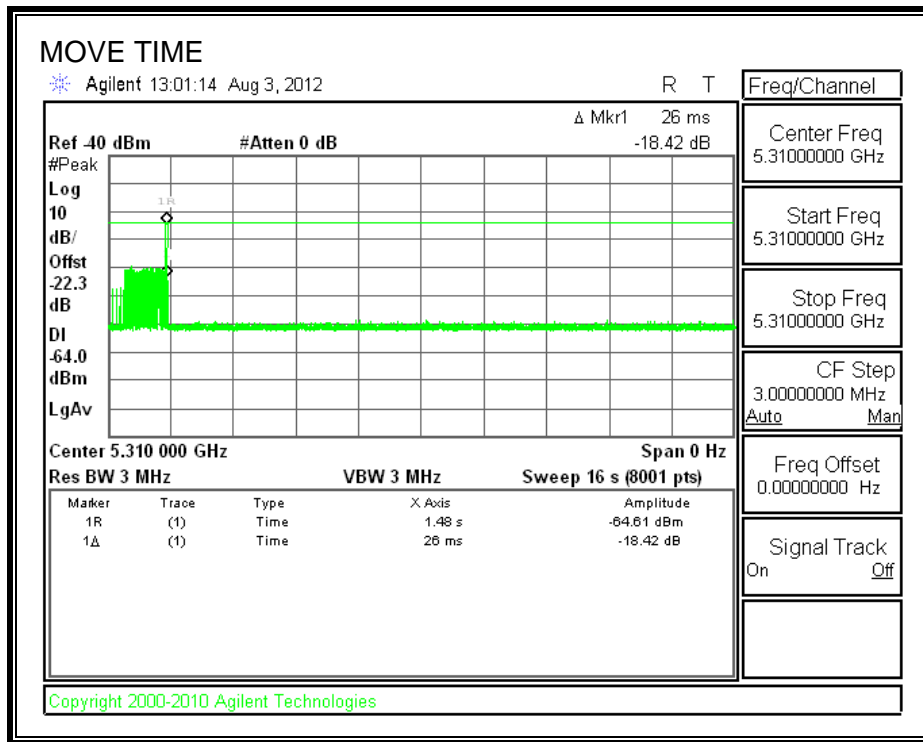

**CHANNEL CLOSING TIME**

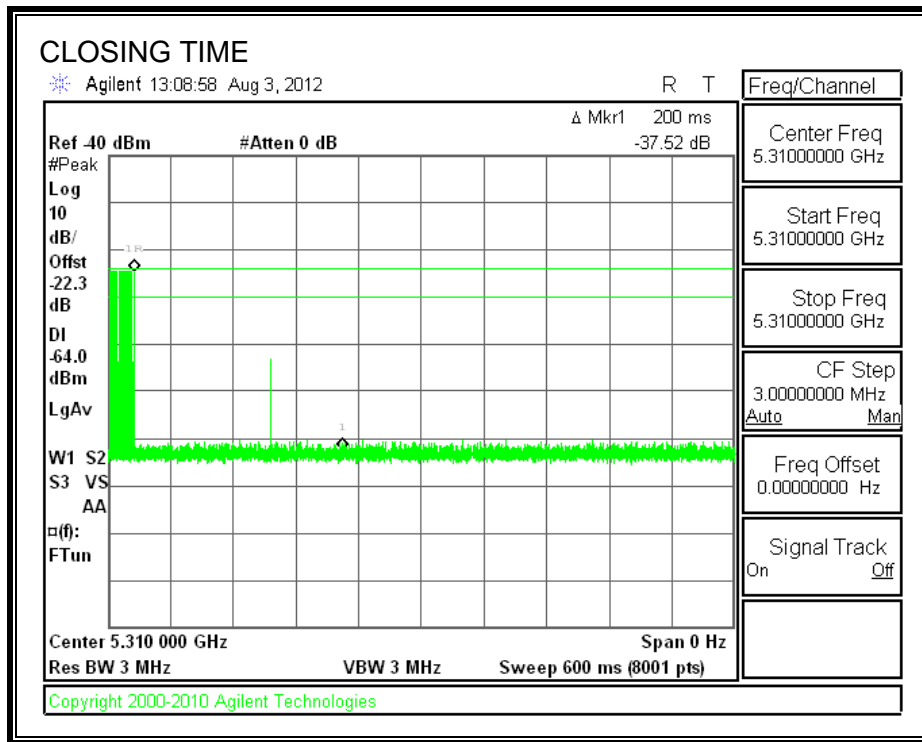

**AGGREGATE CHANNEL CLOSING TRANSMISSION TIME**

No transmissions are observed during the FCC aggregate monitoring period.

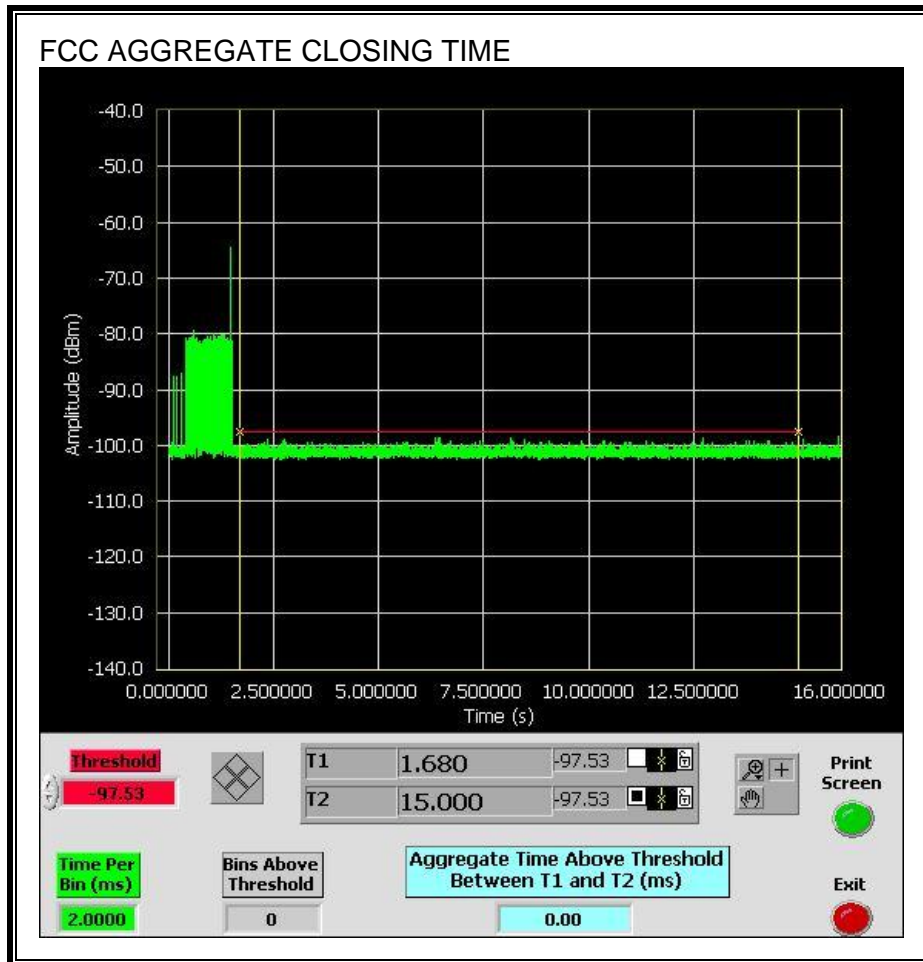

Only intermittent transmissions are observed during the IC aggregate monitoring period.

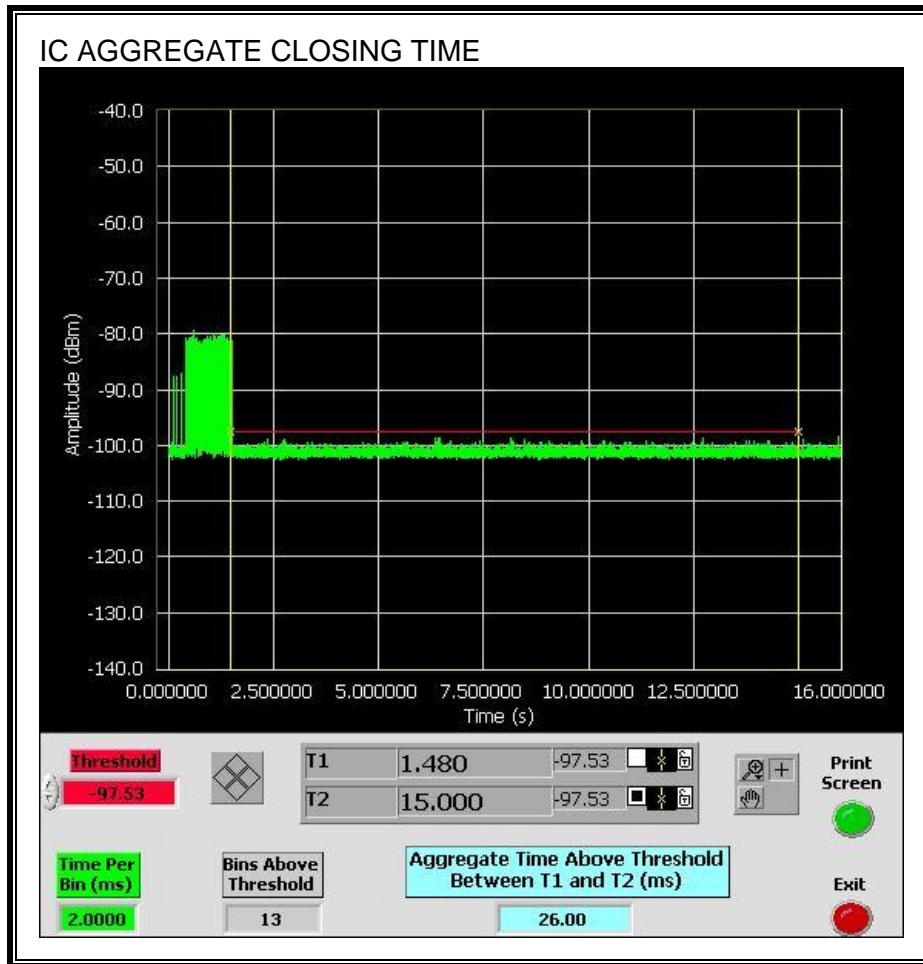



### 11.3.5. NON-OCCUPANCY PERIOD

#### RESULTS

No EUT transmissions were observed on the test channel during the 30-minute observation time.

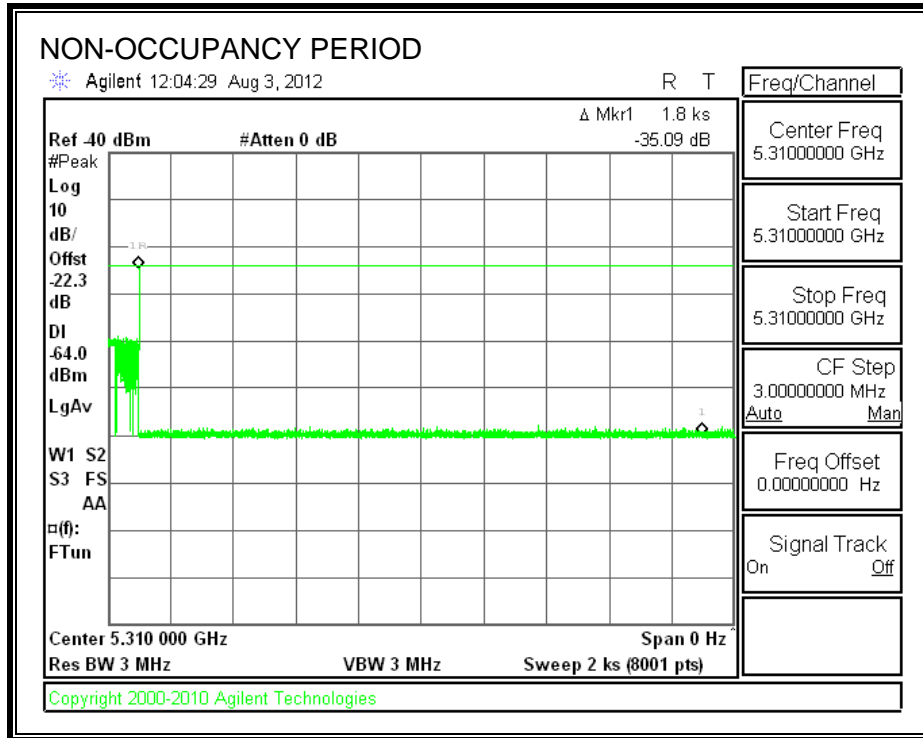

## 11.4. CLIENT-TO-CLIENT COMMUNICATIONS MODE RESULTS FOR 20 MHz BANDWIDTH

### 11.4.1. TEST CHANNEL

All tests were performed at a channel center frequency of 5300 MHz.

### 11.4.2. RADAR WAVEFORM AND TRAFFIC

#### RADAR WAVEFORM

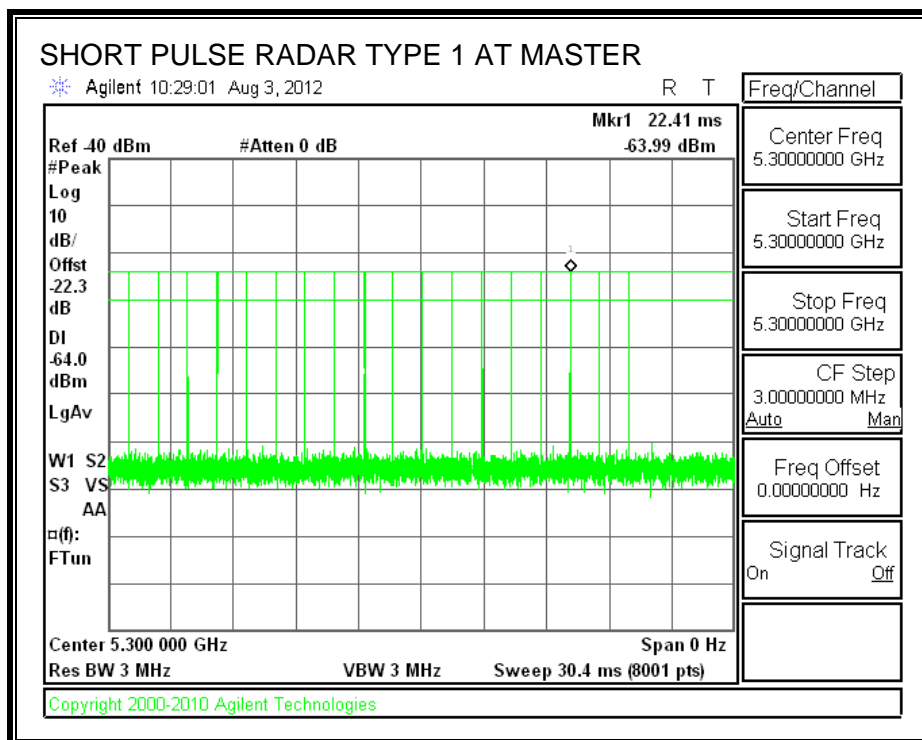

**TRAFFIC**

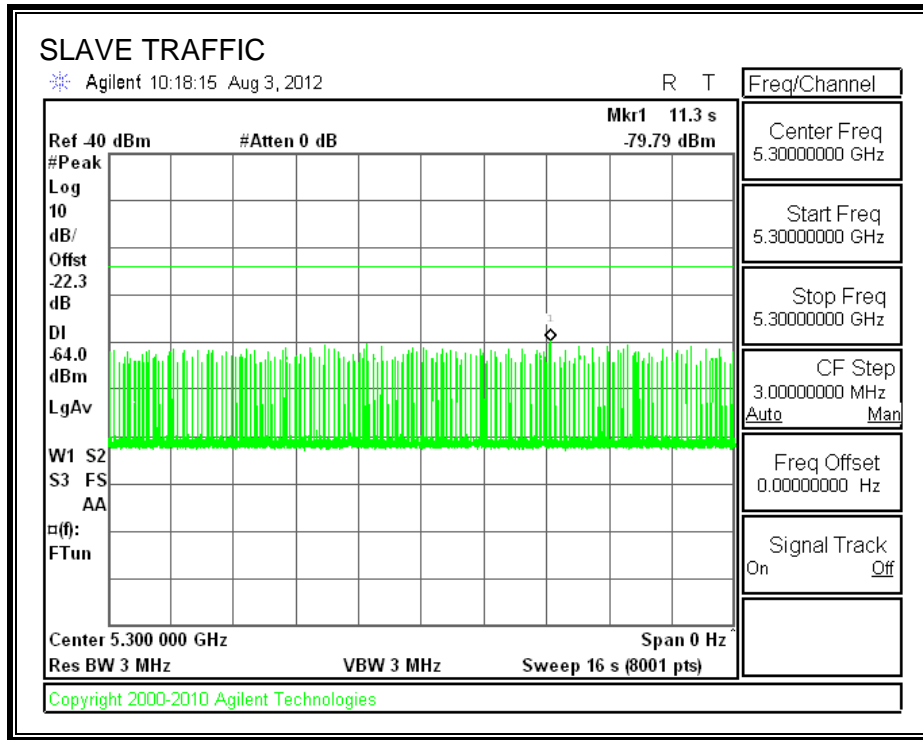

### 11.4.3. OVERLAPPING CHANNEL TESTS

#### RESULTS

These tests are not applicable.

### 11.4.4. MOVE AND CLOSING TIME

#### REPORTING NOTES

The reference marker is set at the end of last radar pulse.

The delta marker is set at the end of the last WLAN transmission following the radar pulse. This delta is the channel move time.

The aggregate channel closing transmission time is calculated as follows:

Aggregate Transmission Time =  
(Number of analyzer bins showing transmission) \* (dwell time per bin)

The observation period over which the FCC aggregate time is calculated begins at (Reference Marker + 200 msec) and ends no earlier than (Reference Marker + 10 sec).

The observation period over which the IC aggregate time is calculated begins at (Reference Marker) and ends no earlier than (Reference Marker + 10 sec).

#### RESULTS

Agency	Channel Move Time (sec)	Limit (sec)
FCC / IC	0.156	10

Agency	Aggregate Channel Closing Transmission Time (msec)	Limit (msec)
FCC	0.0	60
IC	16.0	260

**MOVE TIME**

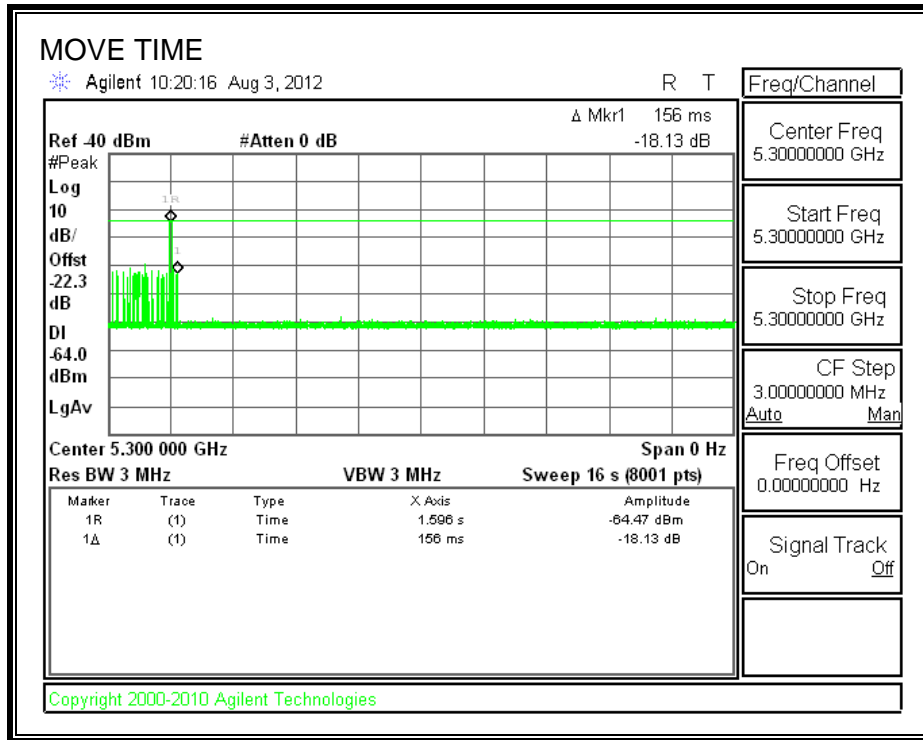

**CHANNEL CLOSING TIME**

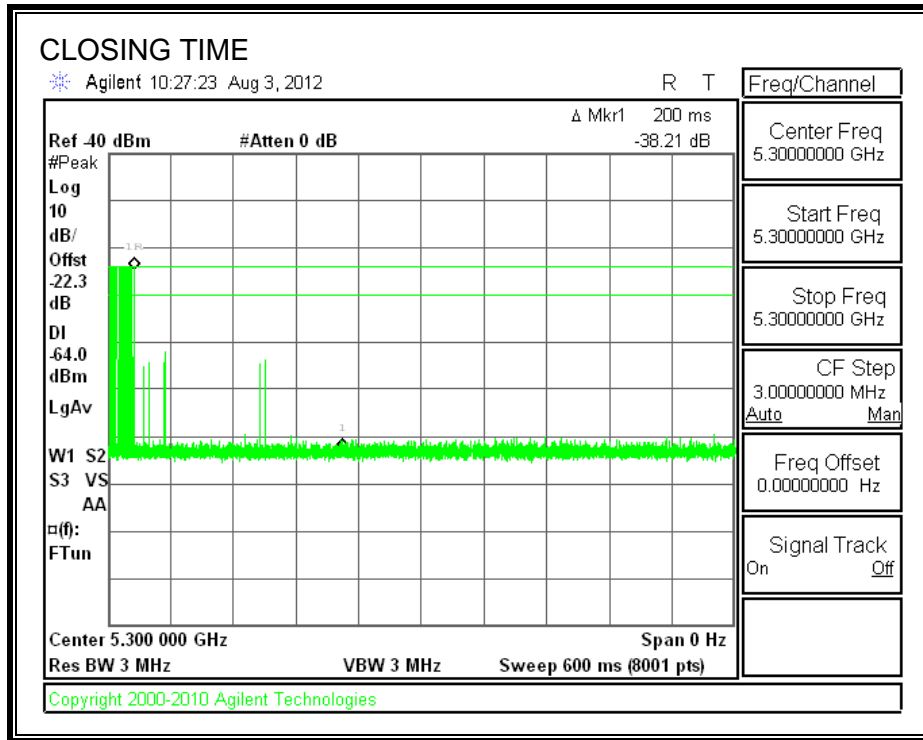

**AGGREGATE CHANNEL CLOSING TRANSMISSION TIME**

No transmissions are observed during the FCC aggregate monitoring period.

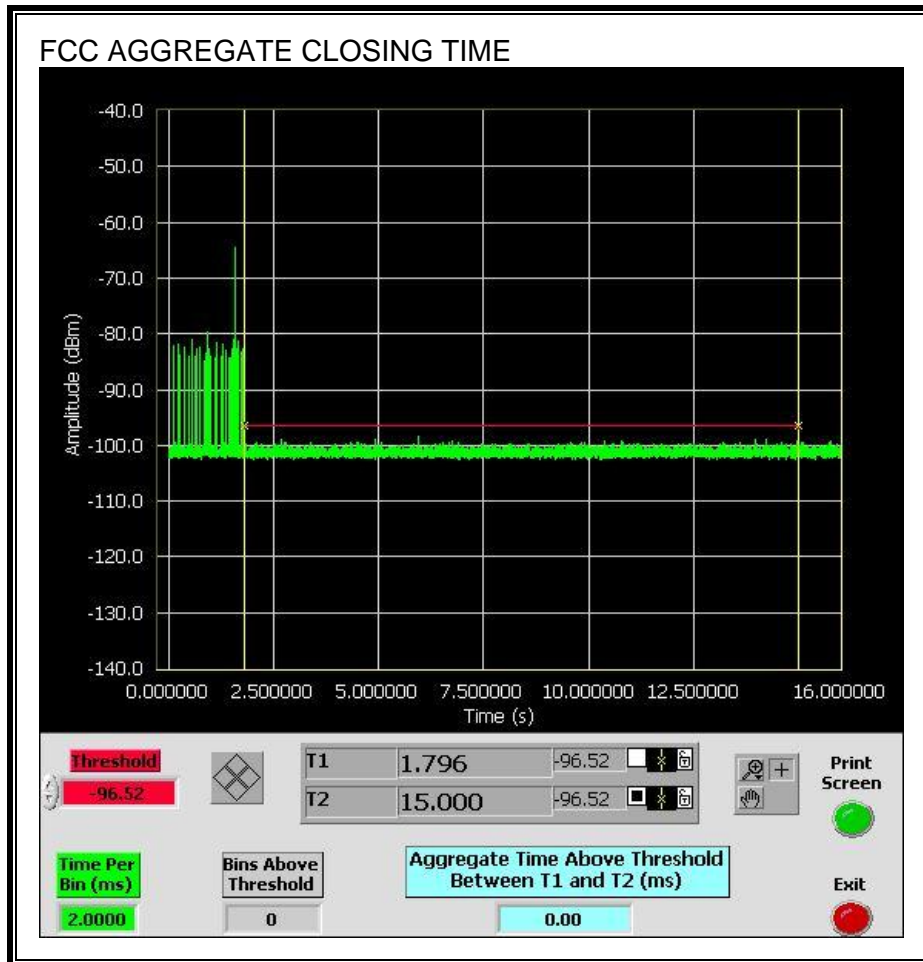

Only intermittent transmissions are observed during the IC aggregate monitoring period.

