



**FCC 47 CFR PART 15 SUBPART E**

**CERTIFICATION TEST REPORT  
CLASS II PERMISSIVE CHANGE**

**FOR**

**TABLET DEVICE**

**MODEL NUMBER: A1458, A1459, A1460\***

**FCC ID: BCGA1458 (A1458)**

**FCC ID: BCGA1459 (A1459)**

**FCC ID: BCGA1460 (A1460)**

**REPORT NUMBER: 15U21850-E13V3**

**ISSUE DATE: DECEMBER 04, 2015**

*Prepared for*

**APPLE, INC.**

**1 INFINITE LOOP**

**CUPERTINO, CA 95014, U.S.A.**

*Prepared by*

**UL VERIFICATION SERVICES INC.**

**47173 BENICIA STREET**

**FREMONT, CA 94538, U.S.A.**

**TEL: (510) 771-1000**

**FAX: (510) 661-0888**

\*Models differences are detailed within the body of this report



NVLAP LAB CODE 200065-0

---

Revision History

<u>Rev.</u>	<u>Issue Date</u>	<u>Revisions</u>	<u>Revised By</u>
V1	11/16/2015	Initial	C. Pang
V2	12/02/2015	Inserting Additional FCC IDs to cover page & header.	M. Mekuria
V3	12/04/2015	Added Remark * on cover page	T. Chu

## TABLE OF CONTENTS

<b>1. ATTESTATION OF TEST RESULTS .....</b>	<b>5</b>
<b>2. TEST METHODOLOGY .....</b>	<b>6</b>
<b>3. FACILITIES AND ACCREDITATION .....</b>	<b>6</b>
<b>4. CALIBRATION AND UNCERTAINTY .....</b>	<b>7</b>
4.1. MEASURING INSTRUMENT CALIBRATION.....	7
4.2. SAMPLE CALCULATION.....	7
4.3. MEASUREMENT UNCERTAINTY .....	7
<b>5. EQUIPMENT UNDER TEST.....</b>	<b>8</b>
5.1. DESCRIPTION OF EUT.....	8
5.2. DESCRIPTION OF CLASS II PERMISSIVE CHANGE.....	8
5.3. DESCRIPTION OF MODELS DIFFERENCES .....	8
5.4. MAXIMUM OUTPUT POWER.....	8
5.5. DESCRIPTION OF AVAILABLE ANTENNAS.....	9
5.6. SOFTWARE AND FIRMWARE .....	9
5.7. WORST-CASE CONFIGURATION AND MODE.....	9
5.8. DESCRIPTION OF TEST SETUP .....	10
<b>6. TEST AND MEASUREMENT EQUIPMENT.....</b>	<b>17</b>
<b>7. ON TIME, DUTY CYCLE AND MEASUREMENT METHODS.....</b>	<b>18</b>
7.1. ON TIME AND DUTY CYCLE.....	18
7.2. MEASUREMENT METHODS.....	21
<b>8. ANTENNA PORT TEST RESULTS.....</b>	<b>22</b>
8.1. 802.11a MODE IN THE 5.8 GHz BAND .....	22
8.1.1. 6 dB BANDWIDTH .....	22
8.1.2. 26 dB BANDWIDTH .....	25
8.1.3. 99% BANDWIDTH.....	28
8.1.4. AVERAGE POWER.....	31
8.1.5. OUTPUT POWER .....	32
8.1.6. PSD.....	34
8.2. 802.11n HT20 MODE IN THE 5.8 GHz BAND.....	37
8.2.1. 6 dB BANDWIDTH .....	37
8.2.2. 26 dB BANDWIDTH .....	40
8.2.3. 99% BANDWIDTH.....	43
8.2.4. AVERAGE POWER.....	46
8.2.5. OUTPUT POWER .....	47
8.2.6. PSD.....	49
8.3. 802.11n HT40 MODE IN THE 5.8 GHz BAND.....	52
8.3.1. 6 dB BANDWIDTH .....	52

---

8.3.2.	26 dB BANDWIDTH .....	54
8.3.3.	99% BANDWIDTH.....	56
8.3.4.	AVERAGE POWER.....	58
8.3.5.	OUTPUT POWER .....	59
8.3.6.	PSD.....	61
<b>9.</b>	<b>RADIATED TEST RESULTS .....</b>	<b>64</b>
9.1.	<i>LIMITS AND PROCEDURE.....</i>	64
9.2.	<i>802.11a MODE IN THE 5.8 GHz BAND .....</i>	65
9.3.	<i>802.11n HT20 MODE IN THE 5.8 GHz BAND.....</i>	75
9.4.	<i>802.11n HT40 MODE IN THE 5.8 GHz BAND.....</i>	85
9.5.	<i>WORST-CASE BELOW 1 GHz .....</i>	93
9.6.	<i>WORST-CASE ABOVE 18 GHz.....</i>	95
<b>10.</b>	<b>AC POWER LINE CONDUCTED EMISSIONS.....</b>	<b>99</b>
10.1.	<i>EUT POWERED BY AC ADAPTER.....</i>	100
10.2.	<i>EUT POWERED BY HOST PC VIA USB CABLE .....</i>	102
<b>11.</b>	<b>SETUP PHOTOS.....</b>	<b>104</b>

# 1. ATTESTATION OF TEST RESULTS

**COMPANY NAME:** APPLE, INC.  
1 INFINITE LOOP  
CUPERTINO, CA 95014, U.S.A.

**EUT DESCRIPTION:** TABLET DEVICE

**MODEL:** A1458, A1459 & A1460

**SERIAL NUMBER:** DLXJ300FF730 (Conducted); DLXJ301KF730 (Radiated)

**DATE TESTED:** OCTOBER 8 – 12, 2015

APPLICABLE STANDARDS	
STANDARD	TEST RESULTS
CFR 47 Part 15 Subpart E	Pass

UL Verification Services Inc. tested the above equipment in accordance with the requirements set forth in the above standards. All indications of Pass/Fail in this report are opinions expressed by UL Verification Services Inc. based on interpretations and/or observations of test results. Measurement Uncertainties were not taken into account and are published for informational purposes only. The test results show that the equipment tested is capable of demonstrating compliance with the requirements as documented in this report.

**Note:** The results documented in this report apply only to the tested sample, under the conditions and modes of operation as described herein. This document may not be altered or revised in any way unless done so by UL Verification Services Inc. and all revisions are duly noted in the revisions section. Any alteration of this document not carried out by UL Verification Services Inc. will constitute fraud and shall nullify the document. This report must not be used by the client to claim product certification, approval, or endorsement by NVLAP, NIST, any agency of the Federal Government, or any agency of any government.

Approved & Released For  
UL Verification Services Inc. By:



CHIN PANG  
SENIOR ENGINEER  
UL VERIFICATION SERVICES INC.

Tested By:



TINA CHU  
EMC LAB ENGINEER  
UL VERIFICATION SERVICES INC.

## 2. TEST METHODOLOGY

The tests documented in this report were performed in accordance with FCC CFR 47 Part 2, FCC CFR 47 Part 15, FCC 14-30, FCC KDB 789033 D02 v01, FCC, ANSI C63.10-2013.

## 3. FACILITIES AND ACCREDITATION

The test sites and measurement facilities used to collect data are located at 47173 and 47266 Benicia Street, Fremont, California, USA. Line conducted emissions are measured only at the 47173 address. The following table identifies which facilities were utilized for radiated emission measurements documented in this report. Specific facilities are also identified in the test results sections.

47173 Benicia Street	47266 Benicia Street
<input type="checkbox"/> Chamber A	<input type="checkbox"/> Chamber D
<input type="checkbox"/> Chamber B	<input type="checkbox"/> Chamber E
<input type="checkbox"/> Chamber C	<input checked="" type="checkbox"/> Chamber F
	<input type="checkbox"/> Chamber G
	<input type="checkbox"/> Chamber H

The above test sites and facilities are covered under FCC Test Firm Registration # 208313. Chambers A through H are covered under Industry Canada company address code 2324B with site numbers 2324B -1 through 2324B-8, respectively.

UL Verification Services Inc. is accredited by NVLAP, Laboratory Code 200065-0. The full scope of accreditation can be viewed at <http://ts.nist.gov/standards/scopes/2000650.htm>.

## 4. CALIBRATION AND UNCERTAINTY

### 4.1. MEASURING INSTRUMENT CALIBRATION

The measuring equipment utilized to perform the tests documented in this report has been calibrated in accordance with the manufacturer's recommendations, and is traceable to recognized national standards.

### 4.2. SAMPLE CALCULATION

Where relevant, the following sample calculation is provided:

$$\begin{aligned} \text{Field Strength (dBuV/m)} &= \text{Measured Voltage (dBuV)} + \text{Antenna Factor (dB/m)} + \text{Cable} \\ &\text{Loss (dB)} - \text{Preamp Gain (dB)} \\ 36.5 \text{ dBuV} + 18.7 \text{ dB/m} + 0.6 \text{ dB} - 26.9 \text{ dB} &= 28.9 \text{ dBuV/m} \end{aligned}$$

### 4.3. MEASUREMENT UNCERTAINTY

Where relevant, the following measurement uncertainty levels have been estimated for tests performed on the apparatus:

PARAMETER	UNCERTAINTY
Conducted Disturbance, 0.15 to 30 MHz	± 3.52 dB
Radiated Disturbance, 30 to 1000 MHz	± 4.94 dB
Radiated Disturbance, 1 to 6 GHz	± 3.86 dB
Radiated Disturbance, 6 to 18 GHz	± 4.23 dB
Radiated Disturbance, 18 to 26 GHz	± 5.30 dB
Radiated Disturbance, 26 to 40 GHz	± 5.23 dB

Uncertainty figures are valid to a confidence level of 95%.

## 5. EQUIPMENT UNDER TEST

### 5.1. DESCRIPTION OF EUT

The EUT is a iPad tablet device with iPod functions (music, application support, and video), 802.11a/b/g/n radio, and Bluetooth radio functions.

### 5.2. DESCRIPTION OF CLASS II PERMISSIVE CHANGE

Upgrade 5.8GHz band to new rule per KDB 789033 D02 v01.

### 5.3. DESCRIPTION OF MODELS DIFFERENCES

FCC ID: BCGA1458  
IC ID: 579C-A1458  
Model #: A1458

Model A1458, is a tablet with multimedia functions (music, application support, and video) IEEE 802.11a/b/g/n radio and Bluetooth radio. The rechargeable battery is not user accessible.

FCC ID: BCGA1459  
IC ID: 579C-A1459  
Model #: A1459

Model A1459, is a tablet with multimedia functions (music, application support, and video), cellular GSM/GPRS/EGPRS/WCDMA/HSPA+/DC-HSDPA/LTE radio, IEEE 802.11a/b/g/n and Bluetooth radio. The rechargeable battery is not user accessible.

FCC ID: BCGA1460  
IC ID: 579C-A1460  
Model #: A1460

Model A1460, is a tablet with multimedia functions (music, application support, and video), cellular GSM/GPRS/EGPRS/WCDMA/HSPA+/DC-HSDPA/CDMA1xRTT/ EV-DO Rev 0, A, B / LTE radio, IEEE 802.11a/b/g/n radio and Bluetooth radio. The rechargeable battery is not user accessible.

### 5.4. MAXIMUM OUTPUT POWER

The transmitter has a maximum conducted output power as follows:

#### 5.8GHz Band

Frequency Range (MHz)	Mode	Output Power (dBm)	Output Power (mW)
5745 - 5825	802.11a	17.45	55.59
5745 - 5825	802.11n HT20 SISO	17.22	52.72
5755 - 5795	802.11n HT40 SISO	14.48	28.05



## 5.5. DESCRIPTION OF AVAILABLE ANTENNAS

Frequency Band (GHz)	Antenna Gain (dBi)
5.725-5.85	4.9

## 5.6. SOFTWARE AND FIRMWARE

The firmware installed in the EUT during testing was 10A378

The EUT driver software installed during testing was Broadcom\_Rel\_6\_10\_56\_172

The test utility software used during testing was WL\_tool.

## 5.7. WORST-CASE CONFIGURATION AND MODE

Radiated emission and power line conducted emission were performed with the EUT set to transmit at the channel with highest output power as worst-case scenario.

The fundamental of the EUT was investigated in three orthogonal orientations X (Flatbed), Y (Landscape), Z (Portrait), it was determined that Y (Landscape) was worst-case orientations. Therefore, all final radiated testing was performed with the EUT in Y (Landscape) orientation.

Worst-case data rates as provided by the client were:

802.11a mode: 6 Mbps

802.11n HT20 mode: MCS0

802.11n HT40 mode: MCS0

The following configurations were investigated on AC line conducted test.

Configuration	Descriptions
1	EUT powered by AC/DC adapter via USB cable
2	EUT powered by host PC via USB cable

## 5.8. DESCRIPTION OF TEST SETUP

### SUPPORT EQUIPMENT

Support Equipment List				
Description	Manufacturer	Model	Serial Number	FCC ID
Laptop AC/DC adapter	Lenovo	92P1160	11S92P1160Z1ZBGH798B12	N/A
Laptop	Lenovo	7659	L3-AL664 08/03	N/A
Earphone	Apple	N/A	N/A	N/A
EUT AC/CD adapter	Apple	A1385	D293062F3WVDHLHCF	N/A

### I/O CABLES (CONDUCTED TEST)

I/O Cable List						
Cable No	Port	# of identical ports	Connector Type	Cable Type	Cable Length (m)	Remarks
1	Antenna	1	SMA	Un-Shielded	0.2	To spectrum Analyzer
2	USB	1	USB	Shielded	1	N/A
3	AC	1	AC	Un-shielded	3	N/A

### I/O CABLES (RADIATED ABOVE 1 GHZ)

I/O Cable List						
Cable No	Port	# of identical ports	Connector Type	Cable Type	Cable Length (m)	Remarks
None Used						

### I/O CABLES (RADAITED BELOW 1 GHZ)

I/O Cable List						
Cable No	Port	# of identical	Connector Type	Cable Type	Cable Length (m)	Remarks
1	Headphones Jack	1	3.5mm Audio	Shielded	0.9	N/A
2	AC	1	AC	Un-shielded	3	N/A

**I/O CABLES (AC LINE CONDUCTED: AC/DC ADAPTER)**

I/O Cable List						
Cable No	Port	# of identical	Connector Type	Cable Type	Cable Length (m)	Remarks
1	Headphones Jack	1	3.5mm Audio	Shielded	0.9	N/A
2	AC	1	AC	Un-shielded	3	N/A

**I/O CABLES (AC LINE CONDUCTED: LAPTOP CONFIGUARTION)**

I/O Cable List						
Cable No	Port	# of identical	Connector Type	Cable Type	Cable Length (m)	Remarks
1	Headphones Jack	1	3.5mm Audio	Shielded	0.9	N/A
2	USB	1	USB	Shielded	1	N/A
3	AC	1	AC	Un-shielded	3	N/A

**TEST SETUP - CONDUCTED TESTS**

The EUT was tested connected to a host Laptop via USB cable adapter and spectrum analyzer to antenna port. Test software exercised the EUT.

**SETUP DIAGRAM**

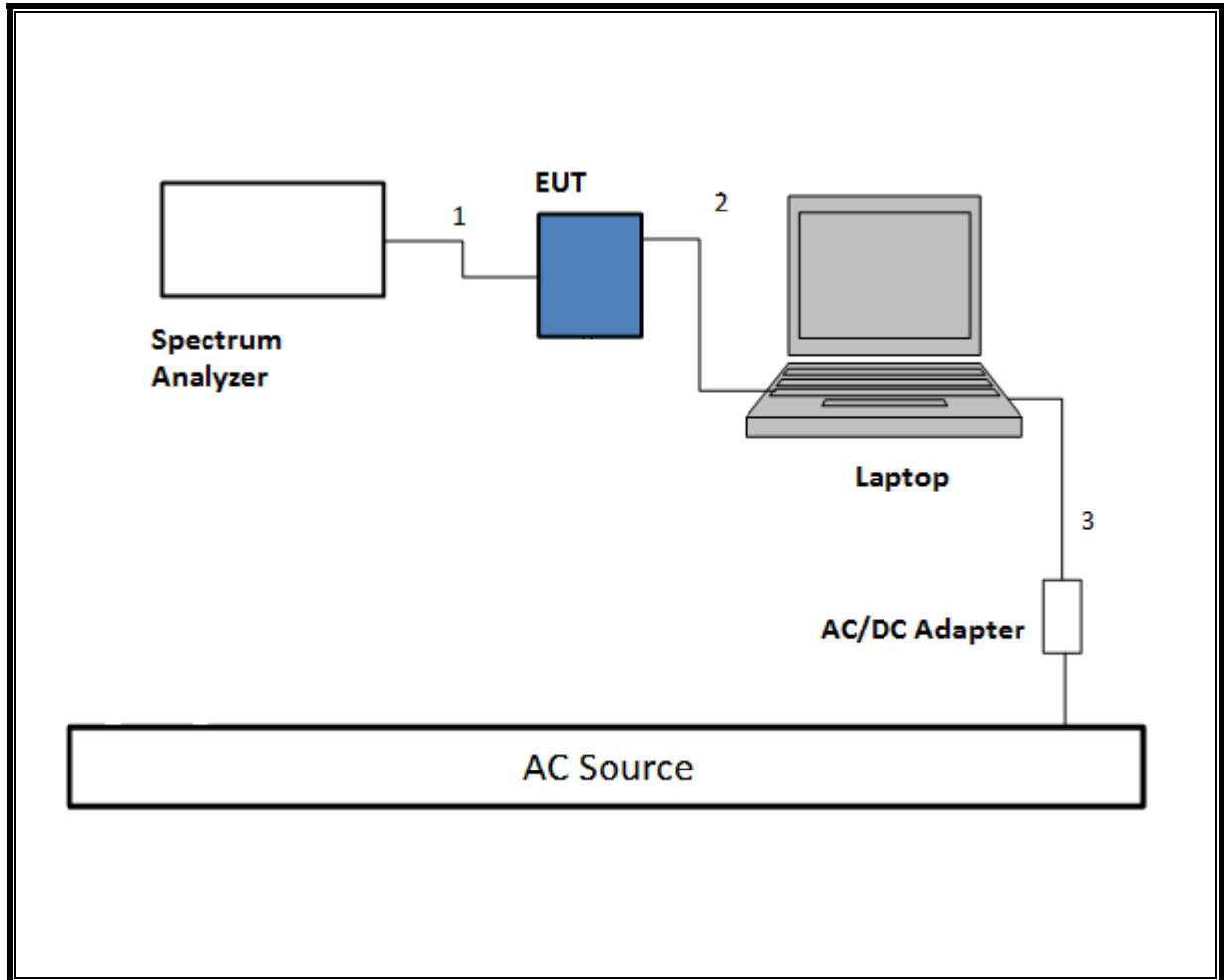

**TEST SETUP- RADIATED-ABOVE 1 GHZ**

The EUT was tested battery powered. Test software exercised the EUT.

**SETUP DIAGRAM**

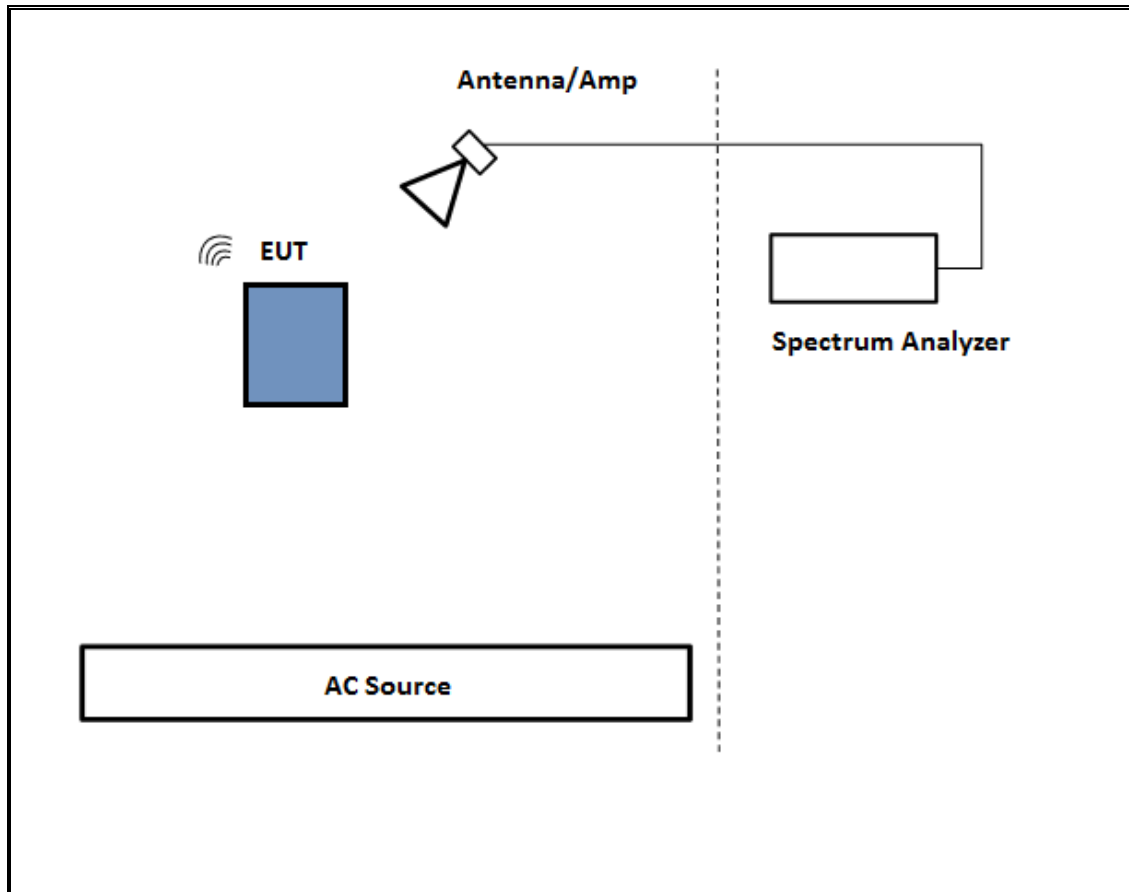

**TEST SETUP- BELOW 1GHz**

The EUT was tested with earphone connected and powered by AC adapter. Test software exercised the EUT.

**SETUP DIAGRAM**

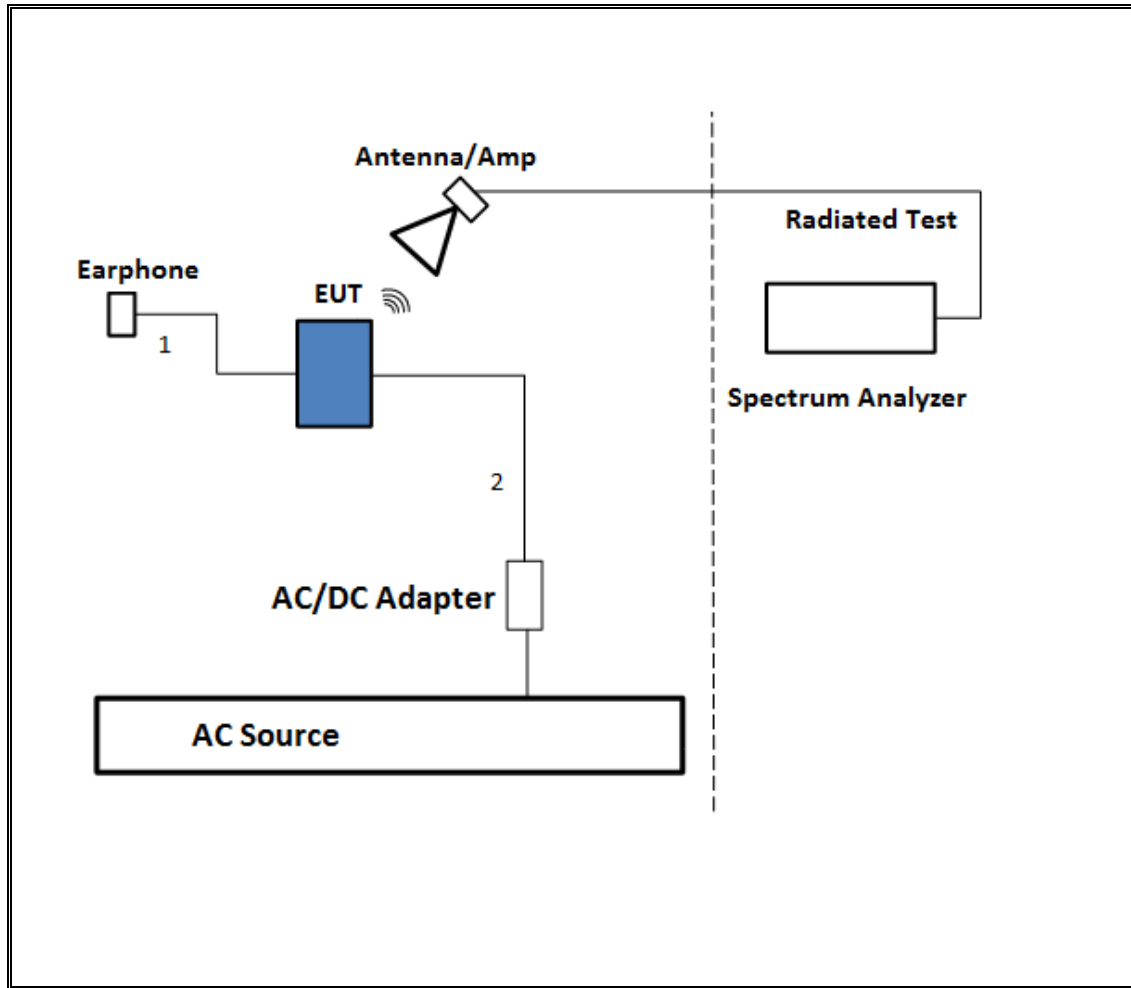

**TEST SETUP- AC LINE CONDUCTED: AC/DC ADAPTER**

The EUT was tested with earphone connected and powered by AC/DC adapter via USB cable. Test software exercised the EUT.

**SETUP DIAGRAM**

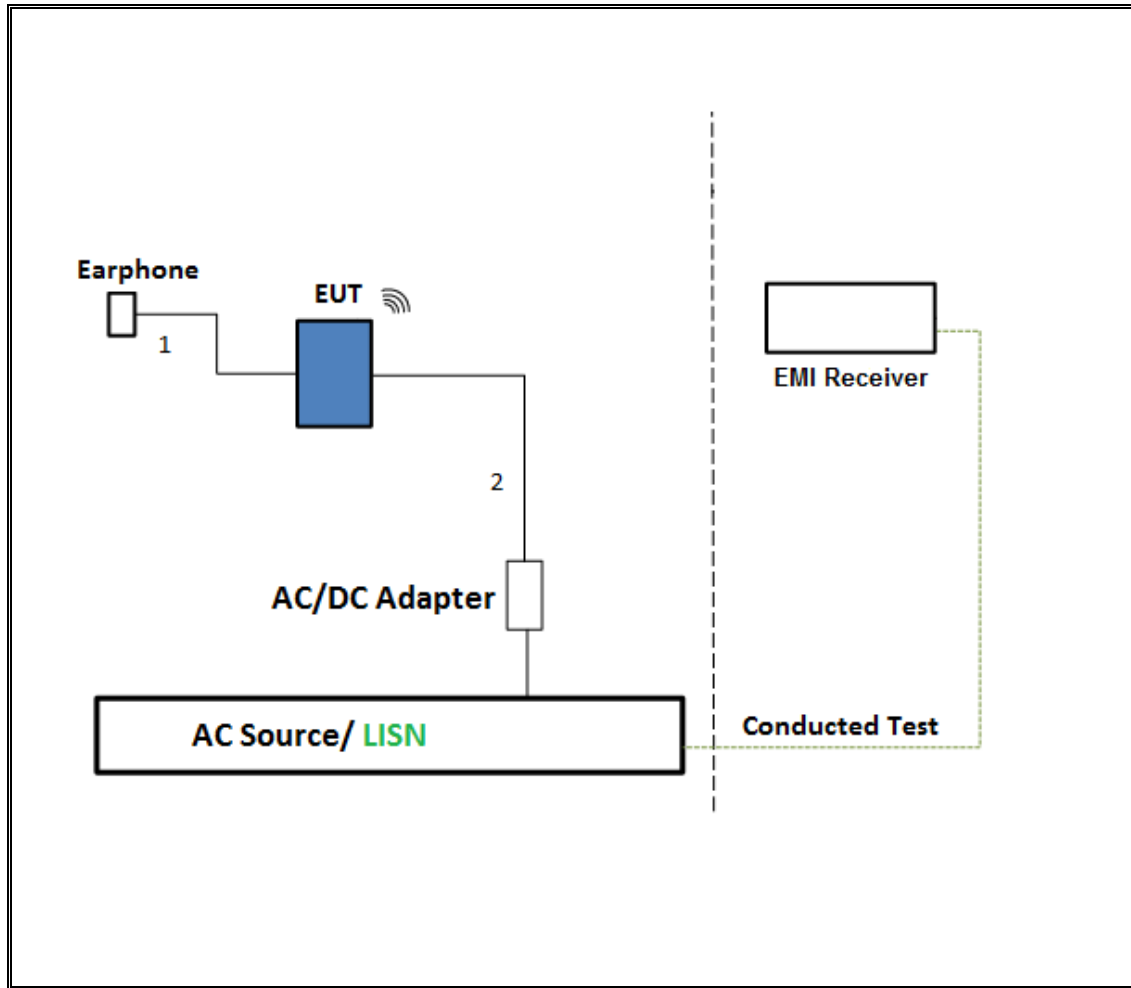

**TEST SETUP- AC LINE CONDUCTED: LAPTOP CONFIGURATION**

The EUT was tested with earphone connected and powered by host PC via USB cable. Test software exercised the EUT.

**SETUP DIAGRAM**

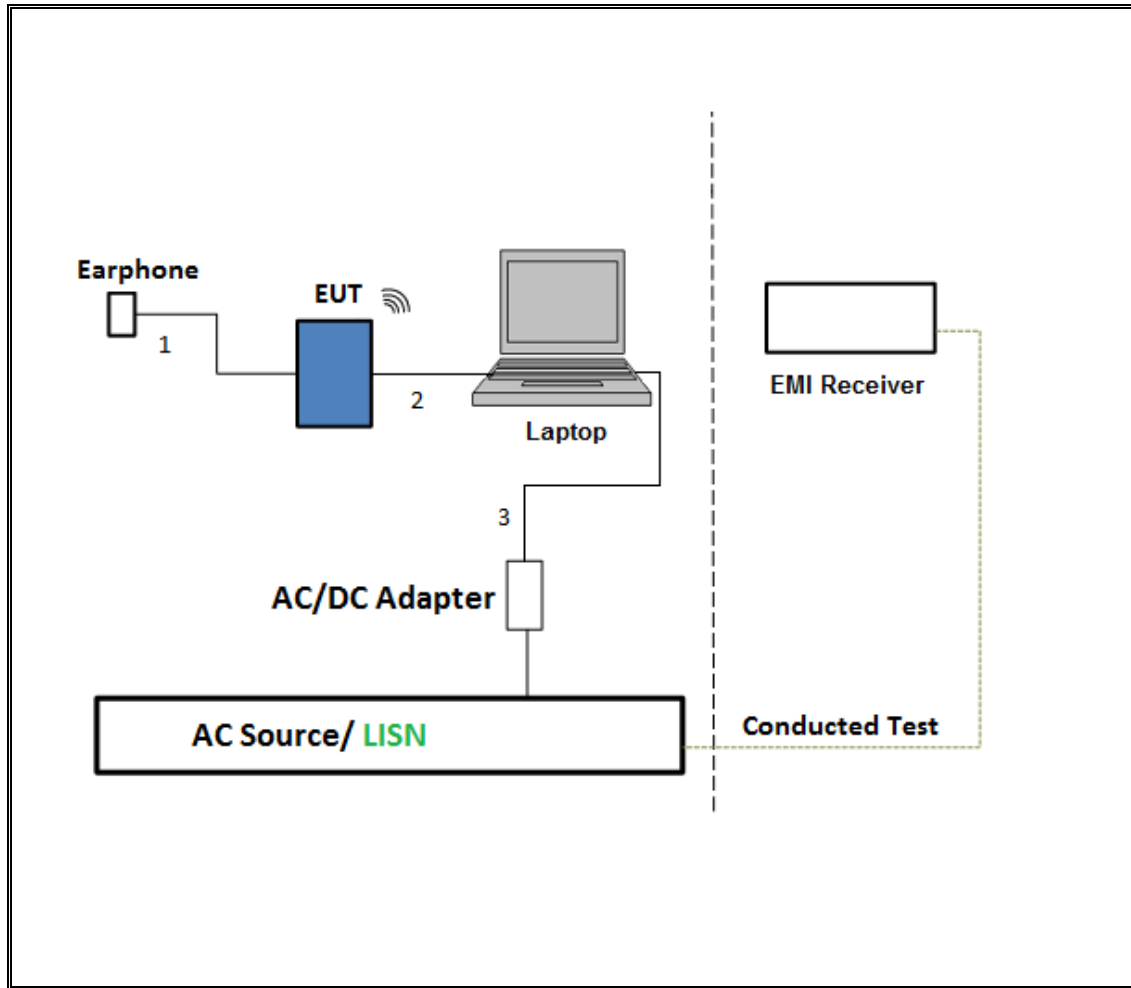



## 6. TEST AND MEASUREMENT EQUIPMENT

The following test and measurement equipment was utilized for the tests documented in this report:

Test Equipment List				
Description	Manufacturer	Model	Asset	Cal Due
Antenna, Horn 1-18GHz	ETS Lindgren	3117	00029310	3/26/2016
Antenna, Broadband Hybrid, 30MHz to 2000MHz	Sunol Sciences	JB1	A121003	2/13/2016
Amplifier, 1 - 18GHz	Miteq	AFS42-00101800-25-S-42	T742	1/31/2016
Amplifier, 10KHz to 1GHz, 32dB	Sonoma	310N	185623	6/9/2016
Spectrum Analyzer, PXA, 3Hz to 44GHz	Keysight	N9030A-544	MY52350176	5/22/2016
Spectrum Analyzer, PXA, 3Hz to 44GHz	Keysight	N9030A	MY54490254	12/10/2015
Power Sensor, P - series, 50MHz to 18GHz, Wideband	Keysight	N1921A	MY55200002	3/6/2016
Power Sensor, P - series, 50MHz to 18GHz, Wideband	Keysight	N1921A	MY55200004	5/6/2016
Antenna, Horn 18 to 26.5GHz	ARA	MWH-1826	1049	12/17/2015
Horn Antenna, 40GHz	ARA	MWH-2640/B	1029	7/28/2016
Spectrum Analyzer, 40 GHz	Agilent	8564E	3943A01643	8/6/2016
Amplifier, 1 to 26.5GHz, 23.5dB Gain minimum	Keysight	8449B	3008A04710	6/29/2016
Amplifier, 26 - 40GHz	Miteq	NSP4000-SP2	924343	4/7/2016
AC Line Conducted				
EMI Test Receiver 9Khz-7GHz	Rohde & Schwarz	ESCI7	100773	8/7/2016
LISN for Conducted Emissions CISPR-16	FCC	50/250-25-2	114	1/16/2016
Power Cable, Line Conducted Emissions ANSI 63.4	UL	PG1	N/A	7/28/2016
UL SOFTWARE				
*Radiated Software	UL	UL EMC	Ver 9.5, July 22, 2014	
*Conducted Software	UL	UL EMC	Ver 2.2, March 31, 2015	
*AC Line Conducted Software	UL	UL EMC	Ver 9.5, April 3, 2015	

Note: \* indicates automation software version used in the compliance certification testing

## 7. ON TIME, DUTY CYCLE AND MEASUREMENT METHODS

### 7.1. ON TIME AND DUTY CYCLE

#### LIMITS

None; for reporting purposes only.

#### PROCEDURE

KDB 789033 Zero-Span Spectrum Analyzer Method.

#### RESULTS

Mode	ON Time B (msec)	Period (msec)	Duty Cycle x (linear)	Duty Cycle (%)	Duty Cycle Correction Factor (dB)	1/B Minimum VBW (kHz)
802.11a 1TX	2.061	2.094	0.984	98.42%	0.00	0.010
802.11n HT20 1TX	1.917	1.947	0.985	98.46%	0.00	0.010
802.11n HT40 1TX	0.944	0.962	0.981	98.13%	0.00	0.010

**DUTY CYCLE PLOTS**

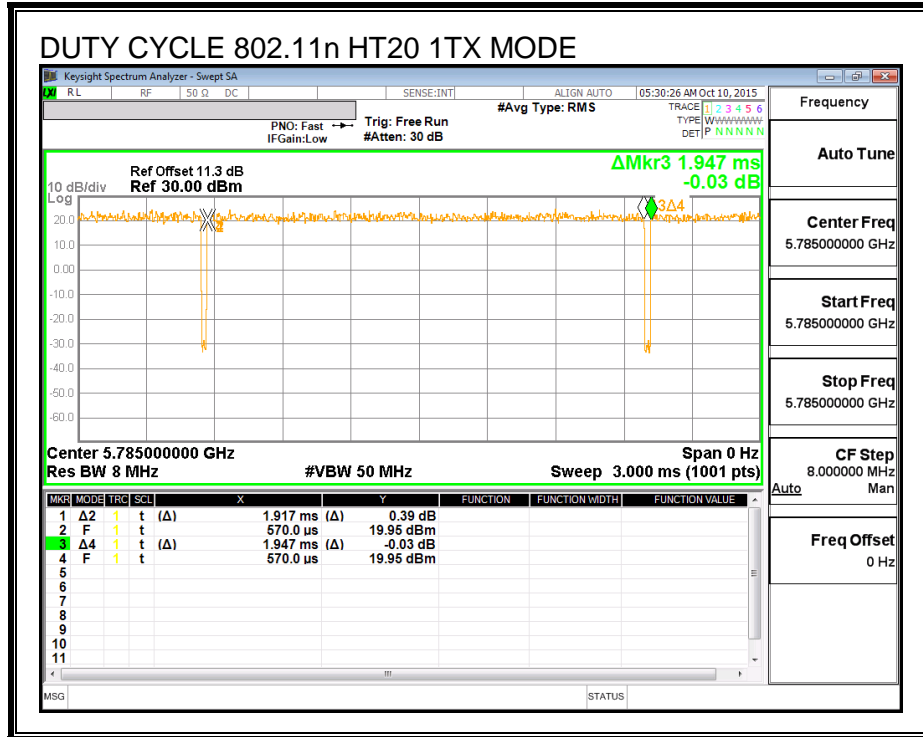
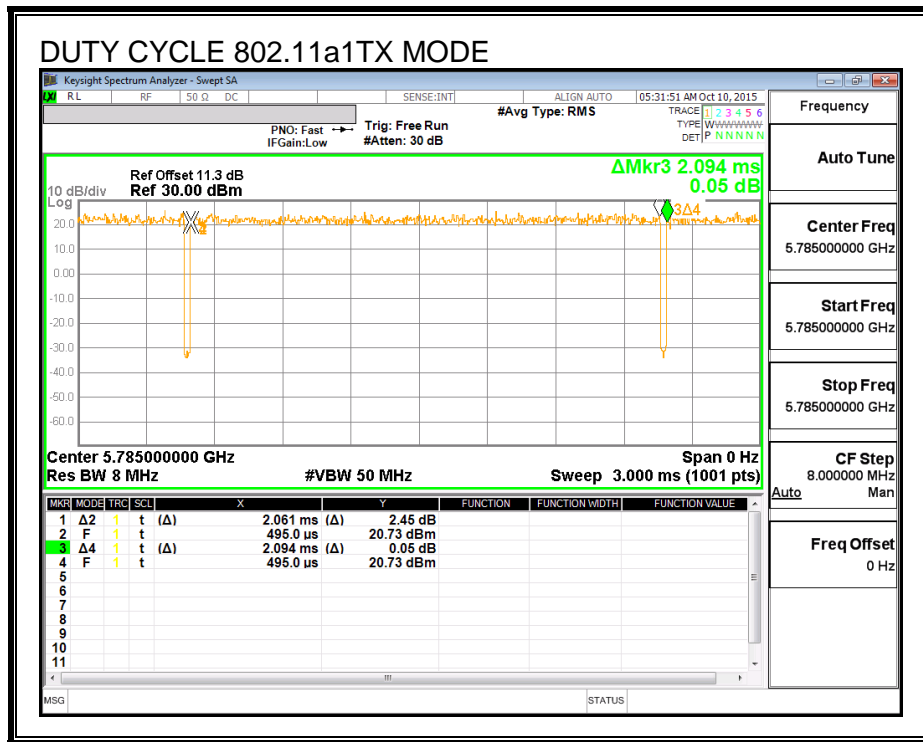

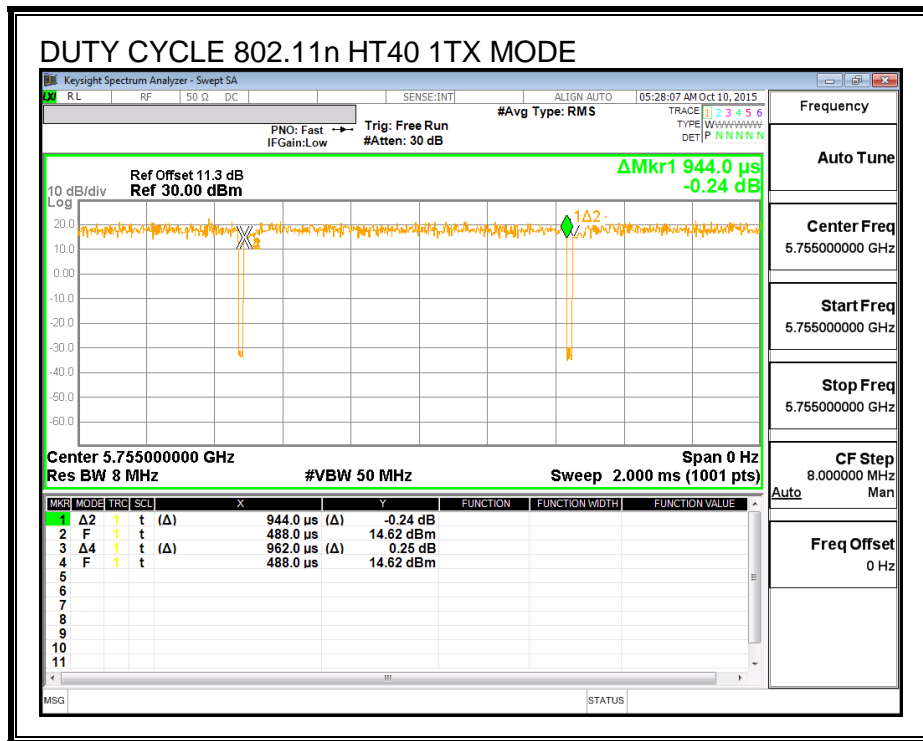

## 7.2. MEASUREMENT METHODS

26 dB Emission BW & 6 dB Emission BW: KDB 789033 D02 v01, Section C.

99% Occupied BW: KDB 789033 D02 v01, Section D.

Conducted Output Power: KDB 789033 D02 v01, Section E.3.b (Method PM-G).

Power Spectral Density: KDB 789033 D02 v01, Section F.

Unwanted emissions in restricted bands: KDB 789033 D02 v01, Sections G.3, G.4, G.5, and G.6.

Unwanted emissions in non-restricted bands: KDB 789033 D02 v01, Sections G.3, G.4, and G.5.

## 8. ANTENNA PORT TEST RESULTS

### 8.1. 802.11a MODE IN THE 5.8 GHz BAND

#### 8.1.1. 6 dB BANDWIDTH

##### LIMITS

FCC §15.407 (e)

The minimum 6 dB bandwidth shall be at least 500 kHz.

##### RESULTS

Channel	Frequency (MHz)	6 dB Bandwidth (MHz)	Minimum Limit (MHz)
Low	5745	16.20	0.5
Mid	5785	16.32	0.5
High	5825	16.35	0.5

**6 dB BANDWIDTH**

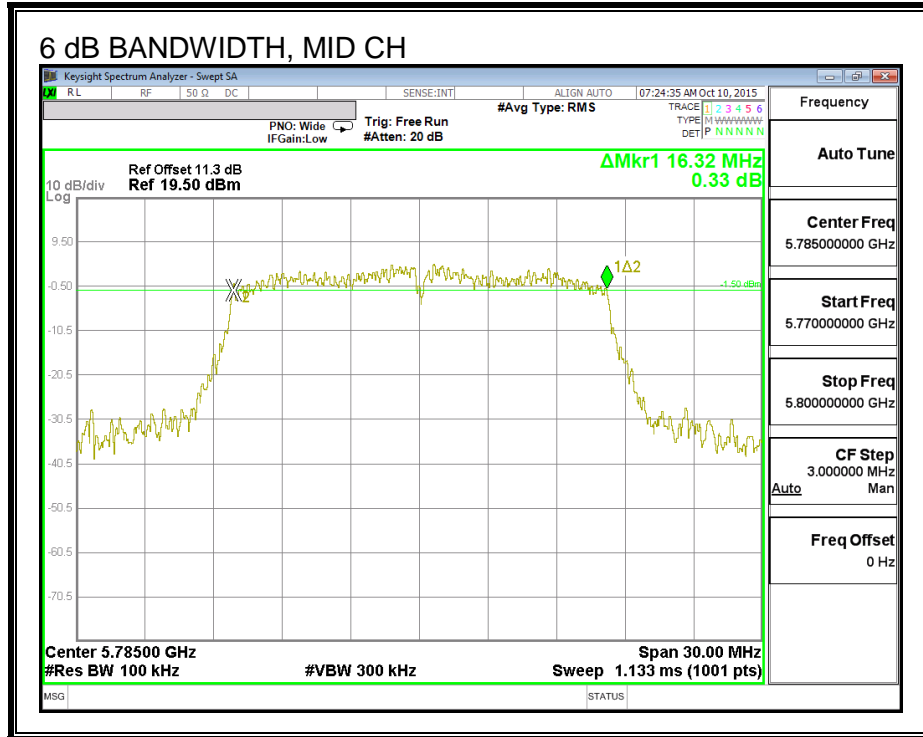
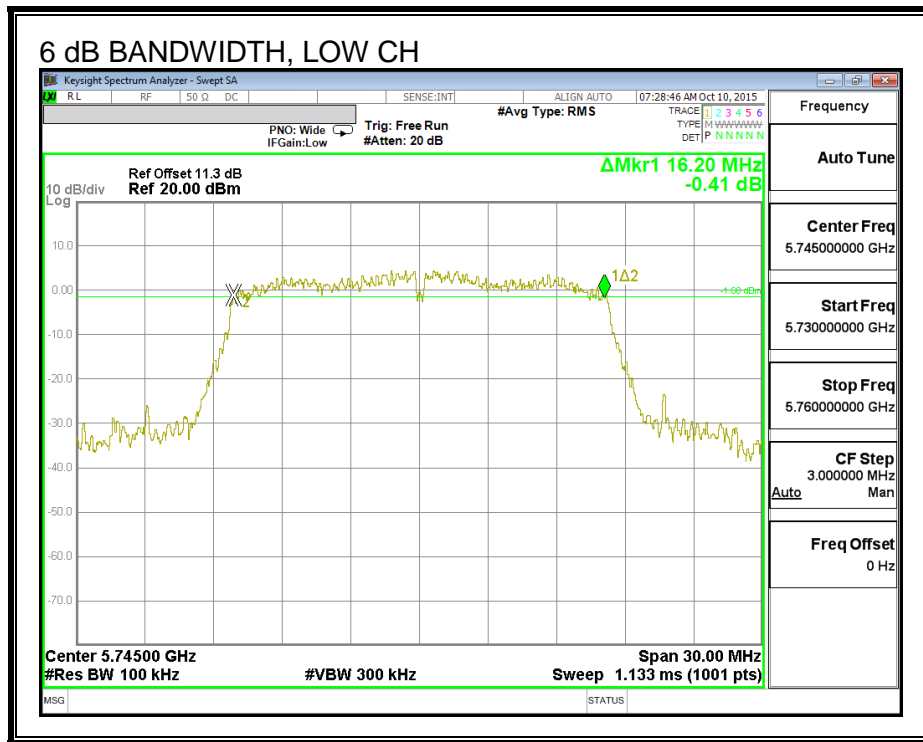

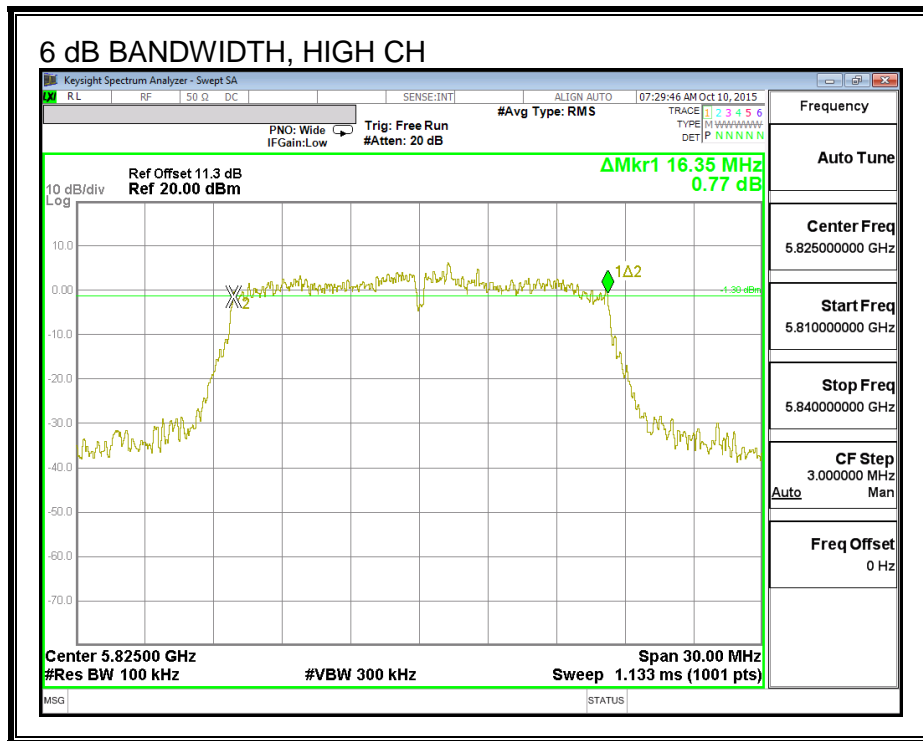



### 8.1.2. 26 dB BANDWIDTH

#### LIMITS

None, for reporting purposes only

#### RESULTS

Channel	Frequency (MHz)	26 dB Bandwidth (MHz)
Low	5745	18.39
Mid	5785	18.45
High	5825	18.81

**26 dB BANDWIDTH**

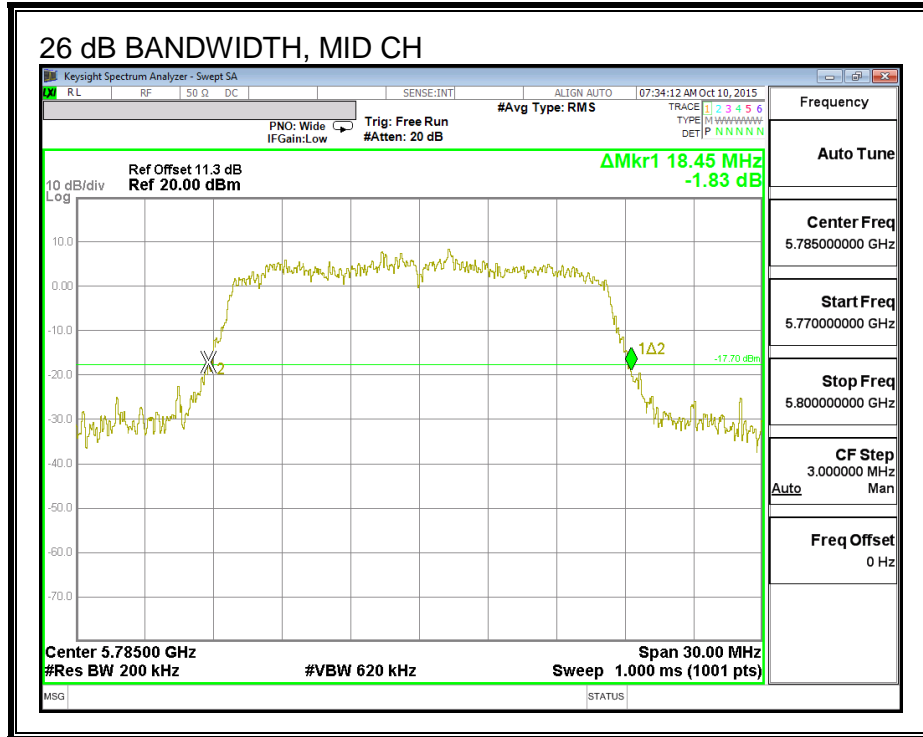
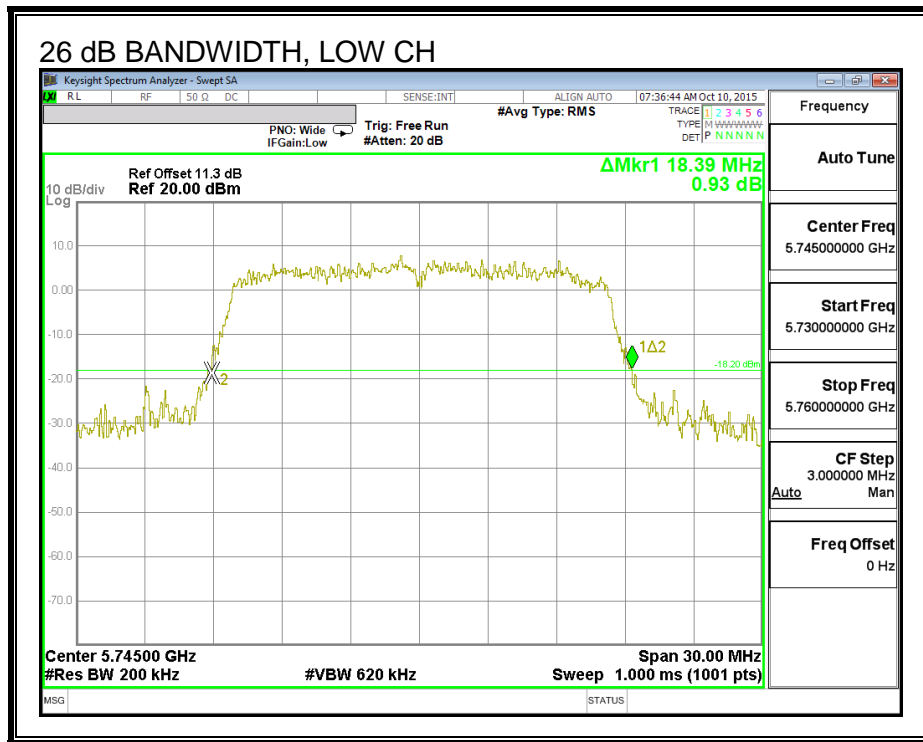

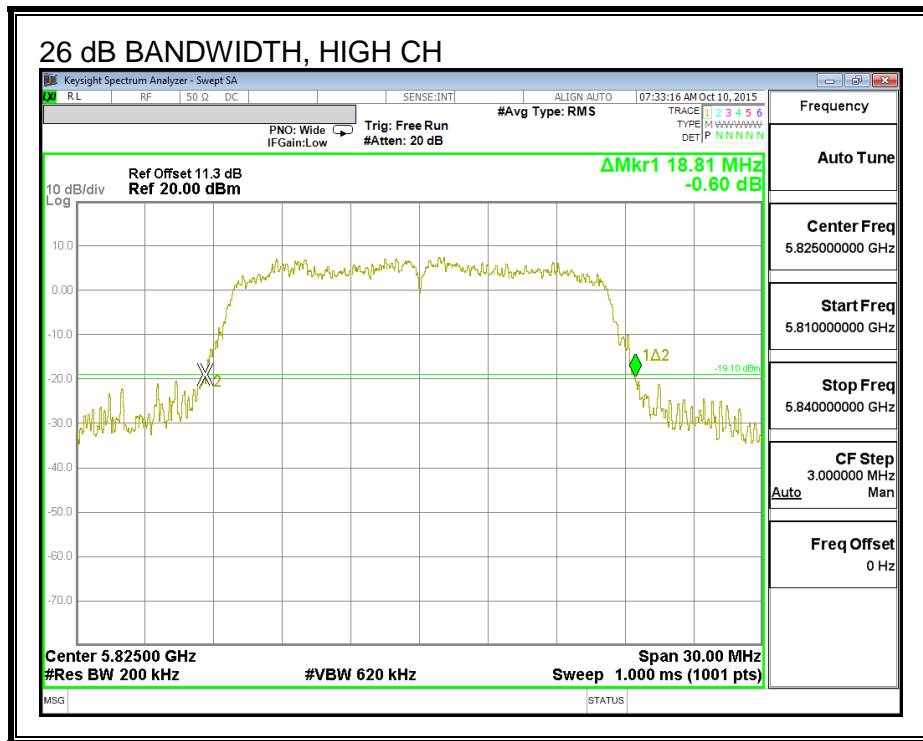

### 8.1.3. 99% BANDWIDTH

#### LIMITS

None; for reporting purposes only.

#### RESULTS

Frequency (MHz)	99% Bandwidth (MHz)
5745	16.310
5785	16.360
5825	16.291

**99% BANDWIDTH**

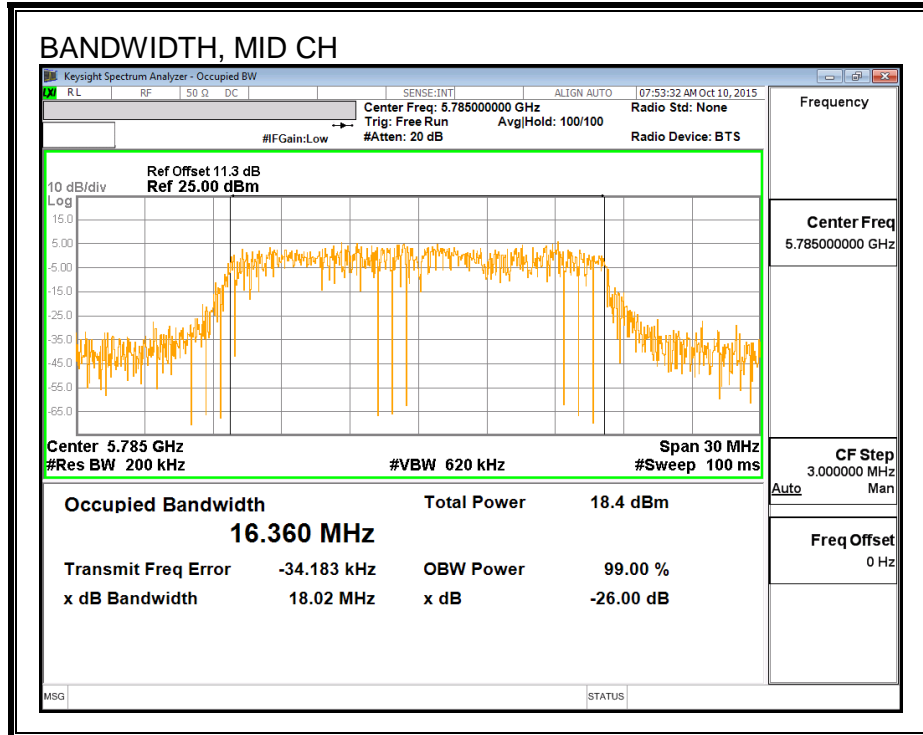
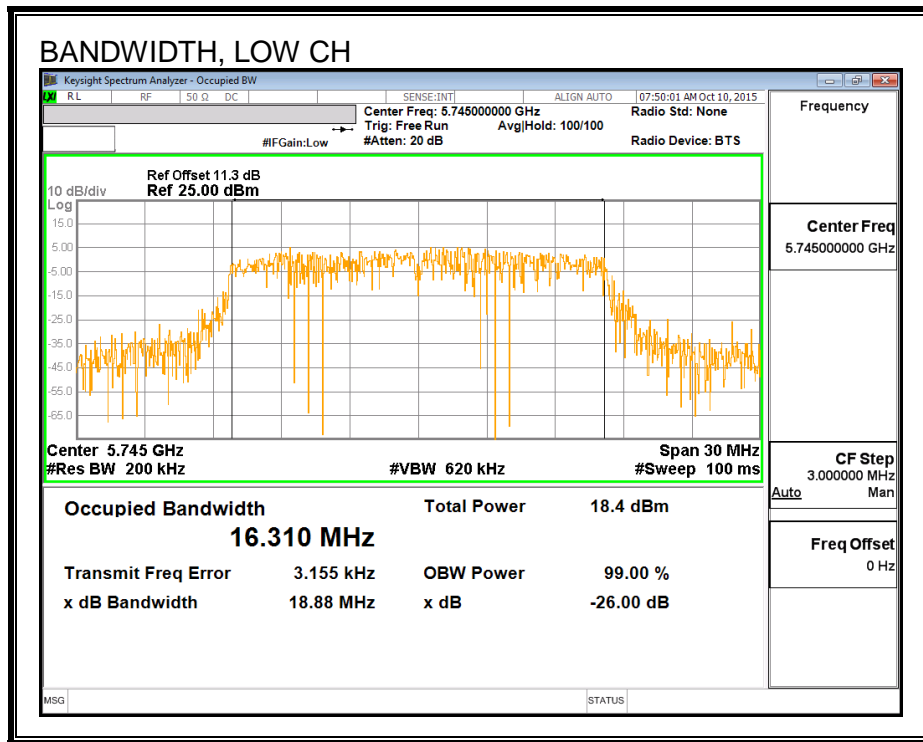

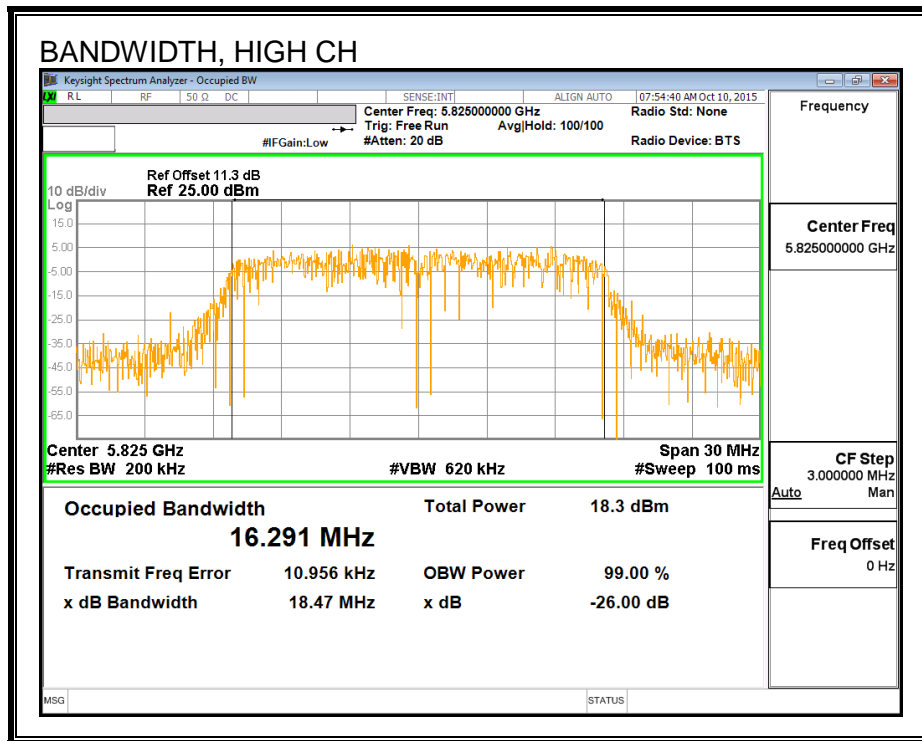

### 8.1.4. AVERAGE POWER

#### LIMITS

None; for reporting purposes only.

#### Test Procedure

Measurements perform using a wideband gated RF power meter.

#### RESULTS

Channel	Frequency (MHz)	Power (dBm)
Low	5745	15.97
Mid	5785	17.35
High	5825	17.45

## 8.1.5. OUTPUT POWER

### LIMITS

FCC §15.407 (a) (3)

For the band 5.725-5.85 GHz, the maximum conducted output power over the frequency band of operation shall not exceed 1 W. In addition, the maximum power spectral density shall not exceed 30 dBm in any 500-kHz band. If transmitting antennas of directional gain greater than 6 dBi are used, both the maximum conducted output power and the maximum power spectral density shall be reduced by the amount in dB that the directional gain of the antenna exceeds 6 dBi.

### Test Procedure

Measurements perform using a wideband gated RF power meter provided that the gate parameters are adjusted such that the power is measured only when the EUT is transmitting at its maximum power control level. Since the measurement is made only during the ON time of the transmitter, no duty cycle correction factor is required.

### DIRECTIONAL ANTENNA GAIN

There is only one transmitter output therefore the directional gain is equal to the antenna gain.



**RESULTS**

**Antenna Gain and Limit**

Channel	Frequency (MHz)	Directional Gain for Power (dBi)	Power Limit (dBm)
Low	5745	4.90	30.00
Mid	5785	4.90	30.00
High	5825	4.90	30.00

**Output Power Results**

Channel	Frequency (MHz)	Meas Power (dBm)	Total Corr'd Power (dBm)	Power Limit (dBm)	Power Margin (dB)
Low	5745	15.97	15.97	30.00	-14.03
Mid	5785	17.35	17.35	30.00	-12.65
High	5825	17.45	17.45	30.00	-12.55

### 8.1.6. PSD

#### LIMITS

FCC §15.407 (a) (3)

For the band 5.725-5.85 GHz, the maximum conducted output power over the frequency band of operation shall not exceed 1 W. In addition, the maximum power spectral density shall not exceed 30 dBm in any 500-kHz band. If transmitting antennas of directional gain greater than 6 dBi are used, both the maximum conducted output power and the maximum power spectral density shall be reduced by the amount in dB that the directional gain of the antenna exceeds 6 dBi.

#### DIRECTIONAL ANTENNA GAIN

There is only one transmitter output therefore the directional gain is equal to the antenna gain.

#### RESULTS

##### Antenna Gain and Limits

Channel	Frequency (MHz)	Directional Gain (dBi)	PSD Limit (dBm)
Low	5745	4.90	30.00
Mid	5785	4.90	30.00
High	5825	4.90	30.00

Duty Cycle CF (dB)	0.00	Included in Calculations of Corr'd PSD
--------------------	------	--

##### PSD Results

Channel	Frequency (MHz)	Meas PSD (dBm)	Total Corr'd PSD (dBm)	PSD Limit (dBm)	PSD Margin (dB)
Low	5745	5.081	5.081	30.00	-24.92
Mid	5785	5.022	5.022	30.00	-24.98
High	5825	5.119	5.119	30.00	-24.88

**PSD,**

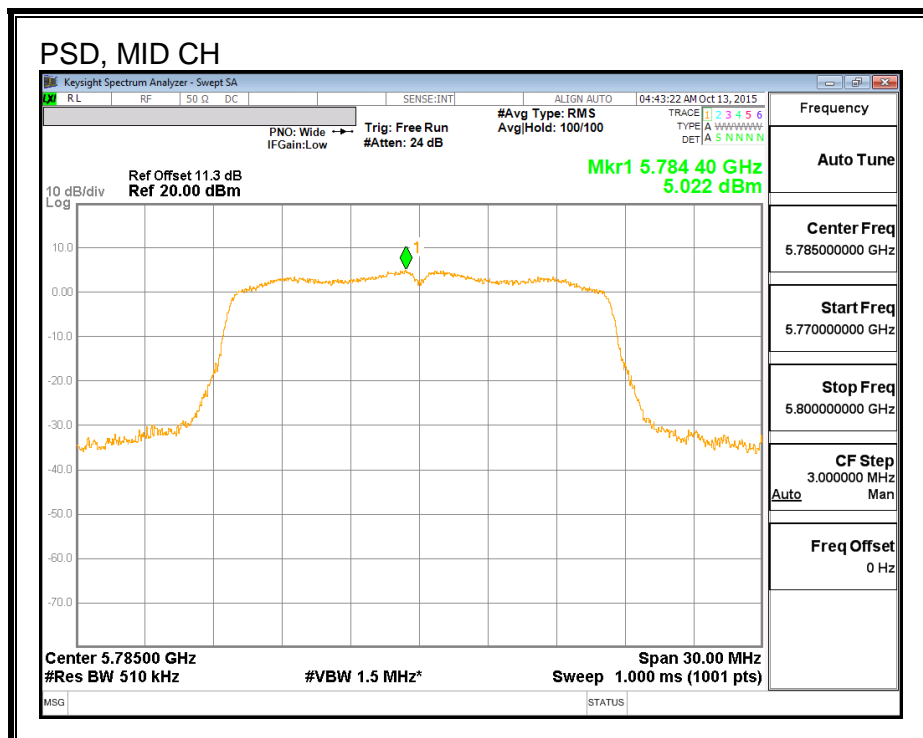
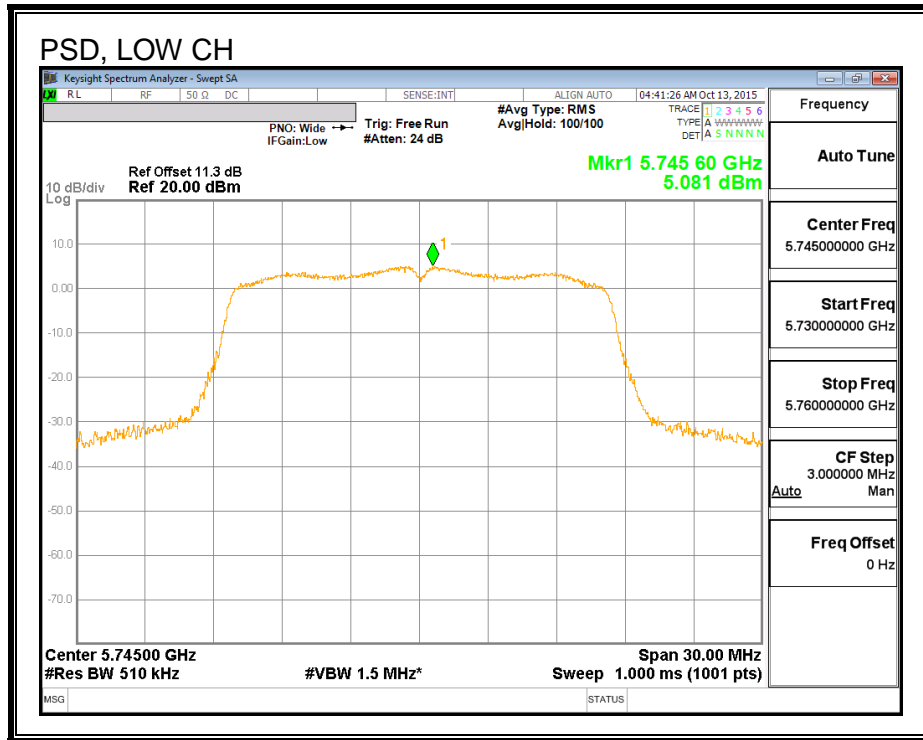

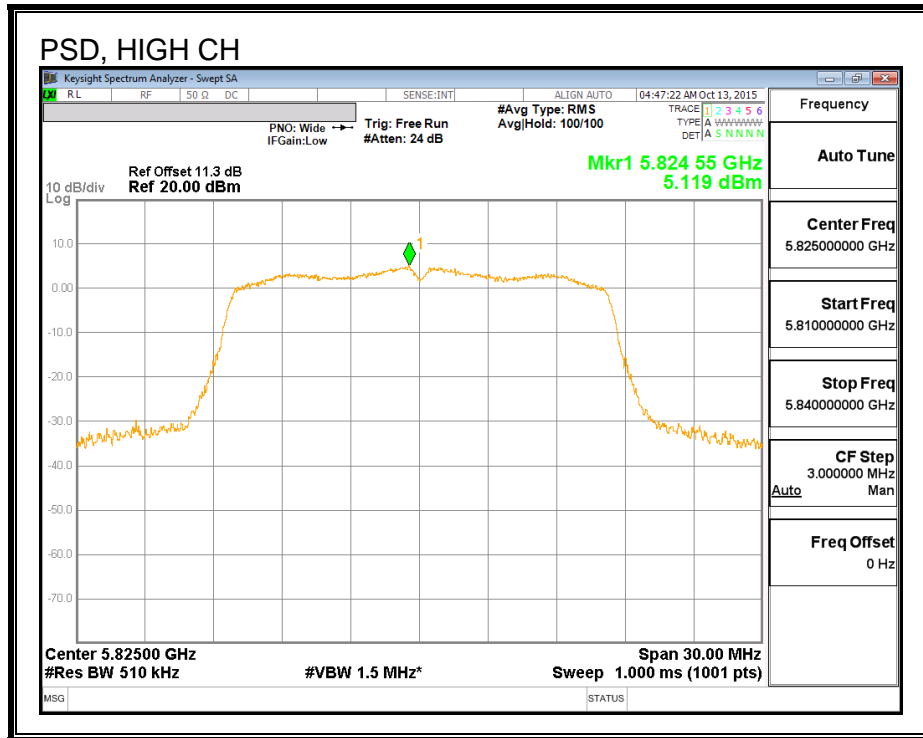

## 8.2. 802.11n HT20 MODE IN THE 5.8 GHz BAND

### 8.2.1. 6 dB BANDWIDTH

#### LIMITS

FCC §15.407 (e)

The minimum 6 dB bandwidth shall be at least 500 kHz.

#### RESULTS

Channel	Frequency (MHz)	6 dB Bandwidth (MHz)	Minimum Limit (MHz)
Low	5745	17.52	0.5
Mid	5785	17.52	0.5
High	5825	17.61	0.5

**6 dB BANDWIDTH**

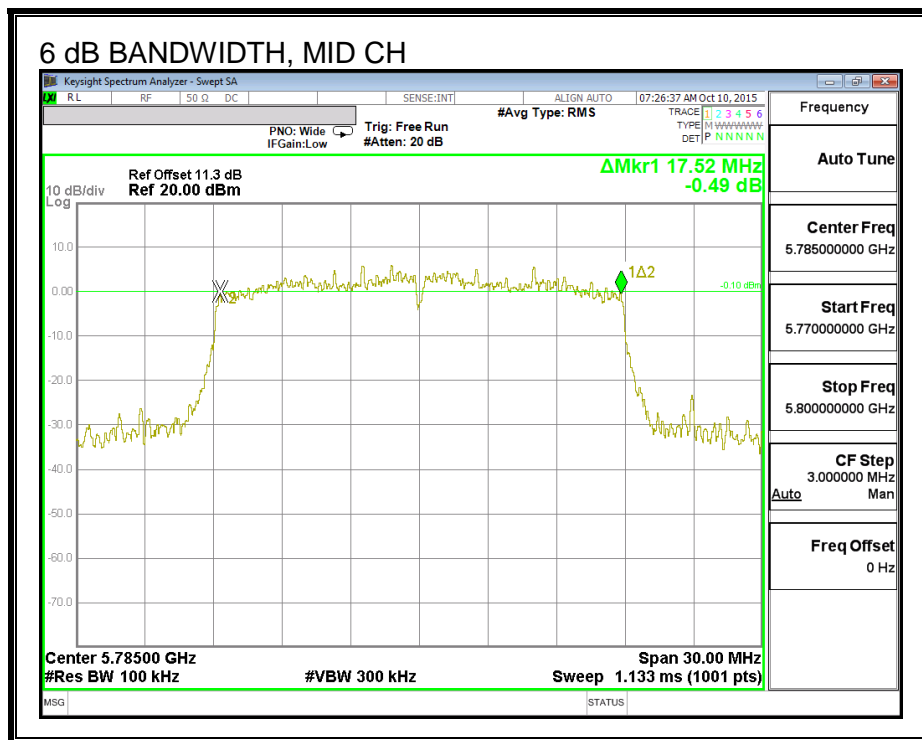
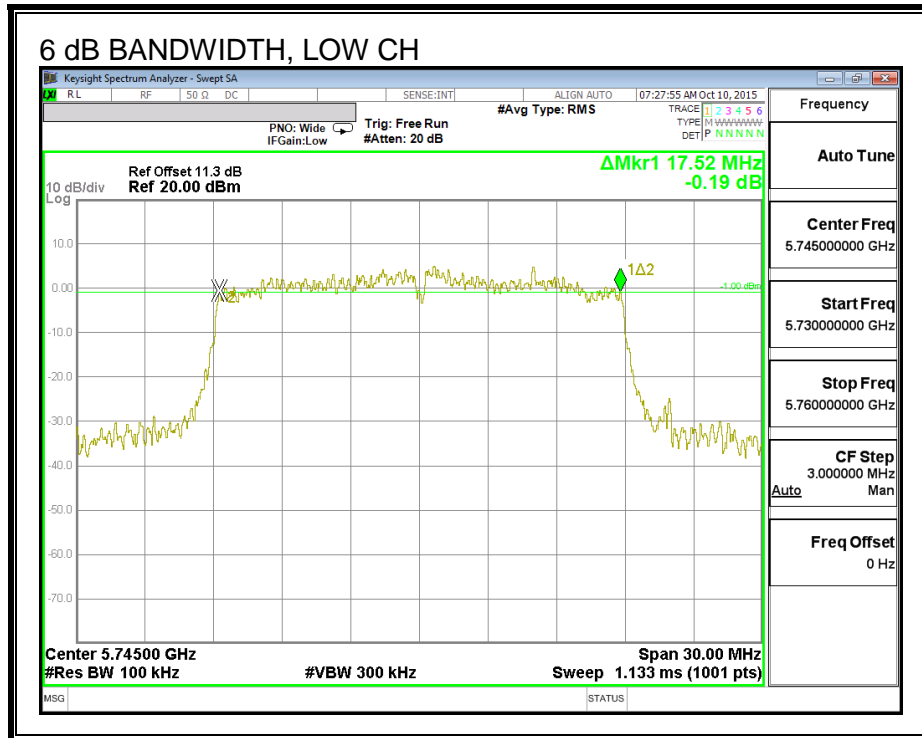

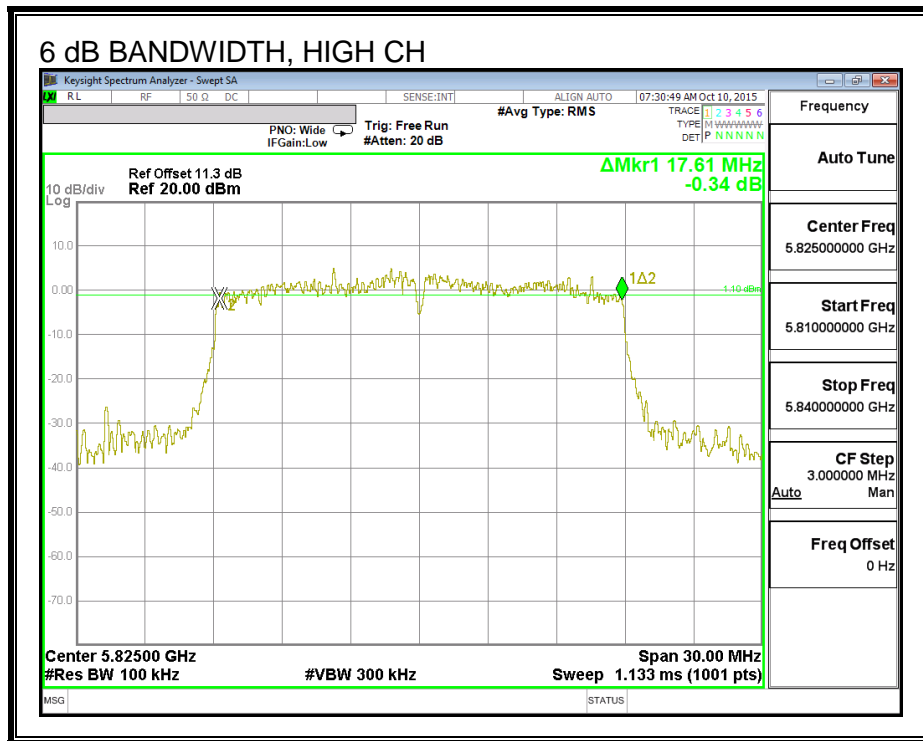

### 8.2.2. 26 dB BANDWIDTH

#### LIMITS

None, for reporting purposes only

#### RESULTS

Channel	Frequency (MHz)	26 dB Bandwidth (MHz)
Low	5745	19.02
Mid	5785	18.99
High	5825	19.26



**26 dB BANDWIDTH**

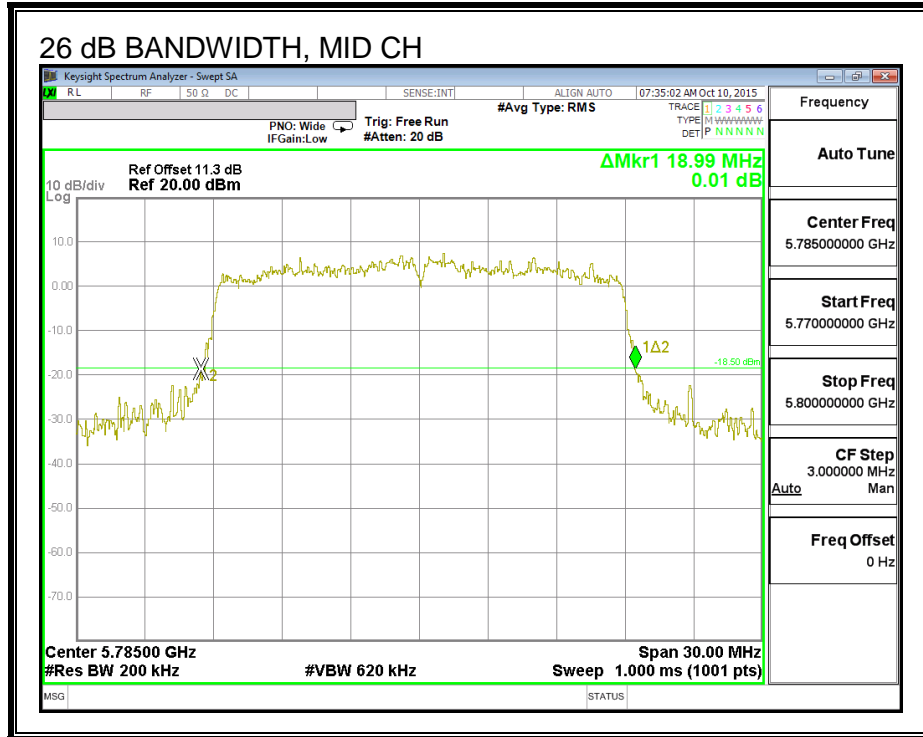
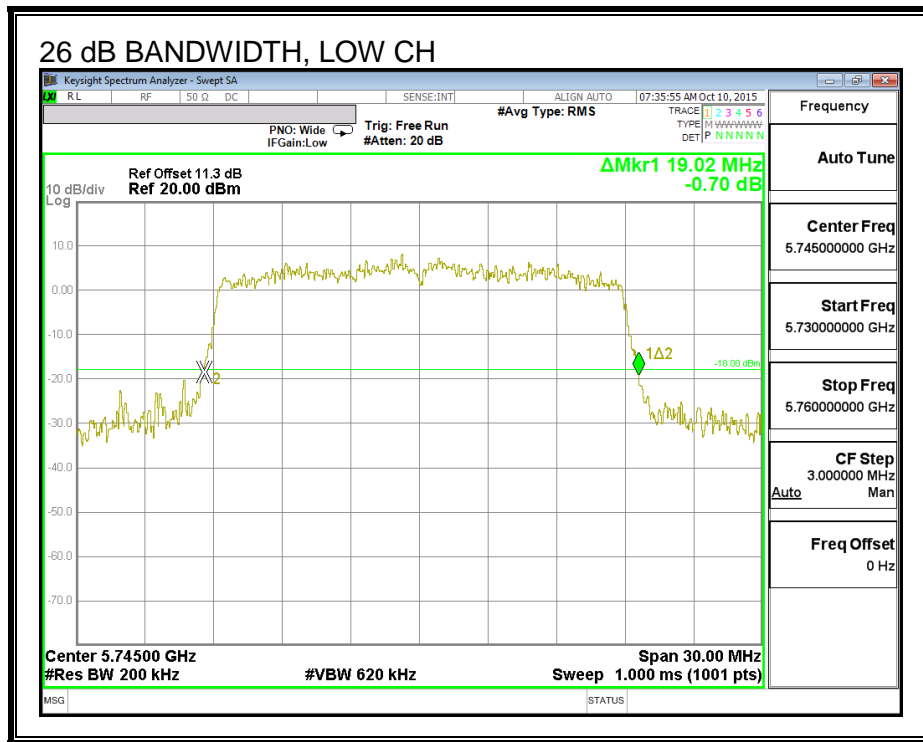

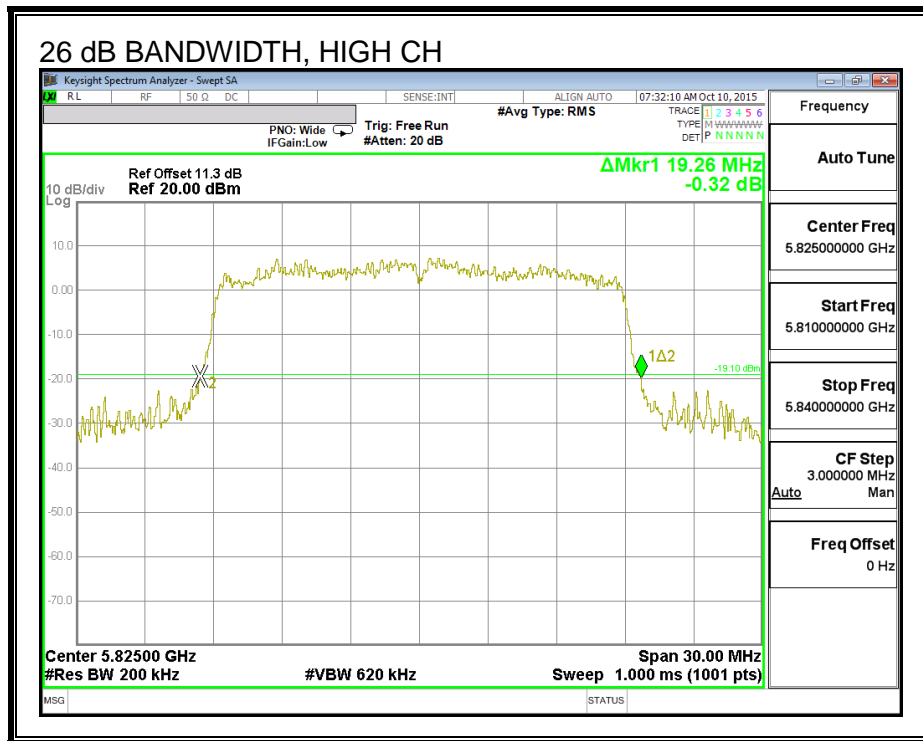

### 8.2.3. 99% BANDWIDTH

#### LIMITS

None; for reporting purposes only.

#### RESULTS

Channel	Frequency (MHz)	99% Bandwidth (MHz)
Low	5745	17.456
Mid	5785	17.602
High	5825	17.547

**99% BANDWIDTH**

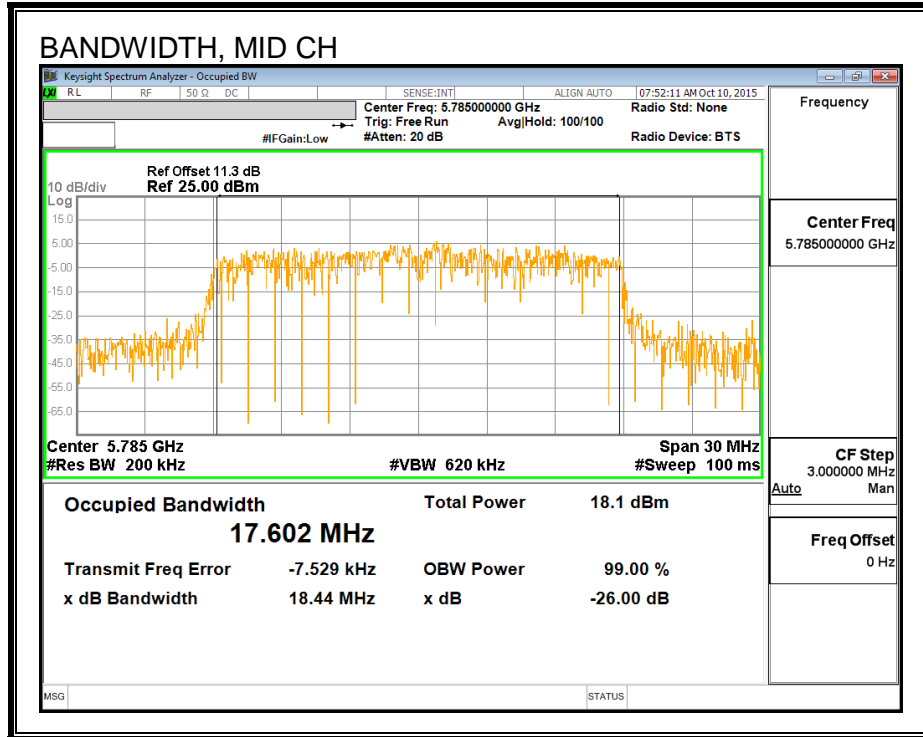
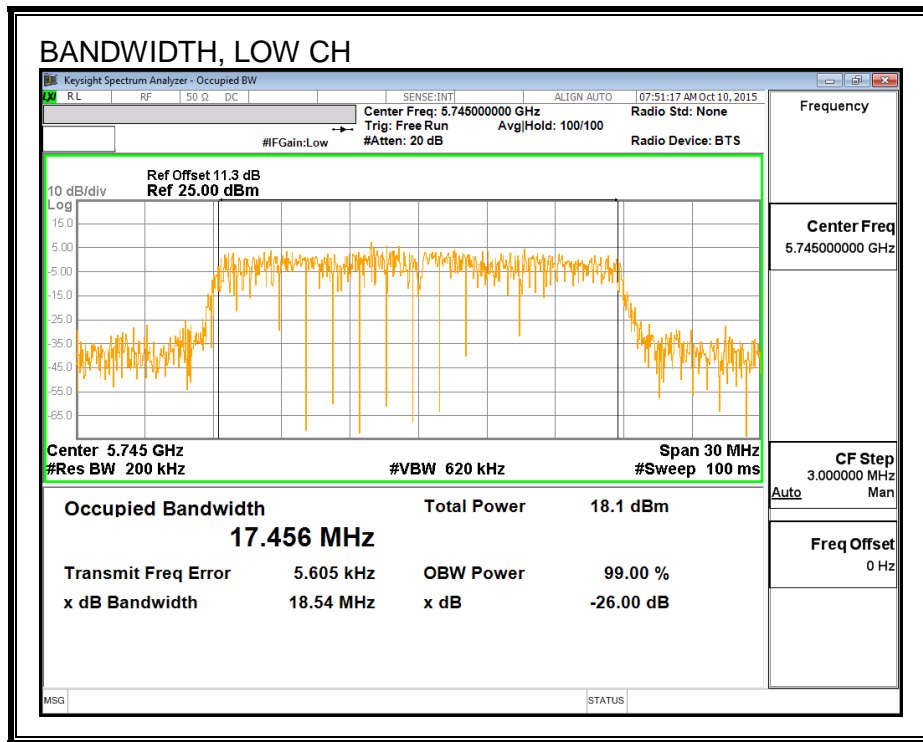

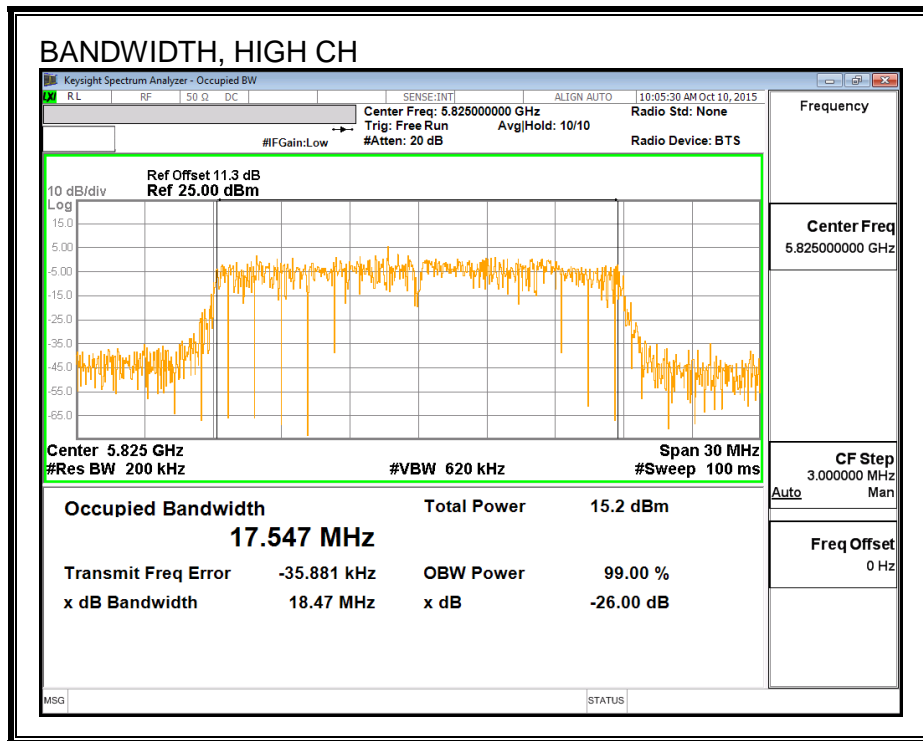

## 8.2.4. AVERAGE POWER

### LIMITS

None; for reporting purposes only.

### Test Procedure

Measurements perform using a wideband gated RF power meter.

### RESULTS

Channel	Frequency (MHz)	Power (dBm)
Low	5745	15.02
Mid	5785	17.22
High	5825	14.94

## 8.2.5. OUTPUT POWER

### LIMITS

FCC §15.407 (a) (3)

For the band 5.725-5.85 GHz, the maximum conducted output power over the frequency band of operation shall not exceed 1 W. In addition, the maximum power spectral density shall not exceed 30 dBm in any 500-kHz band. If transmitting antennas of directional gain greater than 6 dBi are used, both the maximum conducted output power and the maximum power spectral density shall be reduced by the amount in dB that the directional gain of the antenna exceeds 6 dBi.

### Test Procedure

Measurements perform using a wideband gated RF power meter provided that the gate parameters are adjusted such that the power is measured only when the EUT is transmitting at its maximum power control level. Since the measurement is made only during the ON time of the transmitter, no duty cycle correction factor is required.

### DIRECTIONAL ANTENNA GAIN

There is only one transmitter output therefore the directional gain is equal to the antenna gain.

**RESULTS**

**Antenna Gain and Limit**

Channel	Frequency (MHz)	Directional Gain for Power (dBi)	Power Limit (dBm)
Low	5745	4.90	30.00
Mid	5785	4.90	30.00
High	5825	4.90	30.00

**Output Power Results**

Channel	Frequency (MHz)	Meas Power (dBm)	Total Corr'd Power (dBm)	Power Limit (dBm)	Power Margin (dB)
Low	5745	15.02	15.02	30.00	-14.98
Mid	5785	17.22	17.22	30.00	-12.78
High	5825	14.94	14.94	30.00	-15.06



### 8.2.6. PSD

#### LIMITS

FCC §15.407 (a) (3)

For the band 5.725-5.85 GHz, the maximum conducted output power over the frequency band of operation shall not exceed 1 W. In addition, the maximum power spectral density shall not exceed 30 dBm in any 500-kHz band. If transmitting antennas of directional gain greater than 6 dBi are used, both the maximum conducted output power and the maximum power spectral density shall be reduced by the amount in dB that the directional gain of the antenna exceeds 6 dBi.

#### DIRECTIONAL ANTENNA GAIN

There is only one transmitter output therefore the directional gain is equal to the antenna gain.

#### RESULTS

##### Antenna Gain and Limits

Channel	Frequency (MHz)	Directional Gain (dBi)	PSD Limit (dBm)
Low	5745	4.90	30.00
Mid	5785	4.90	30.00
High	5825	4.90	30.00

<b>Duty Cycle CF (dB)</b>	0.00	<b>Included in Calculations of Corr'd PSD</b>
---------------------------	------	---

##### PSD Results

Channel	Frequency (MHz)	Meas PSD (dBm)	Total Corr'd PSD (dBm)	PSD Limit (dBm)	PSD Margin (dB)
Low	5745	4.88	4.88	30.00	-25.12
Mid	5785	4.54	4.54	30.00	-25.47
High	5825	4.41	4.41	30.00	-25.59

**PSD**

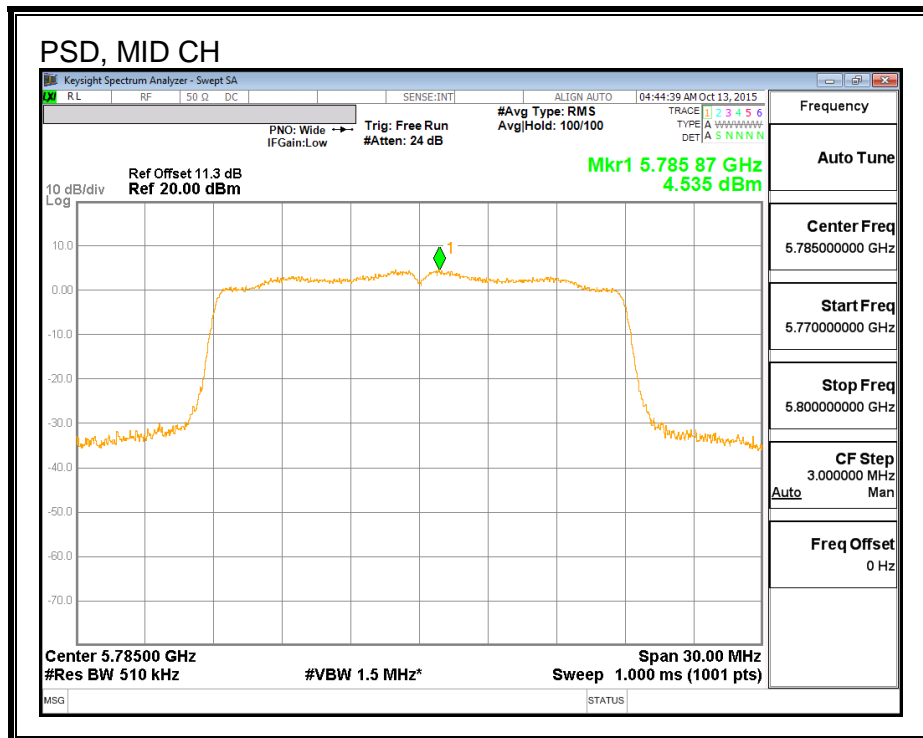
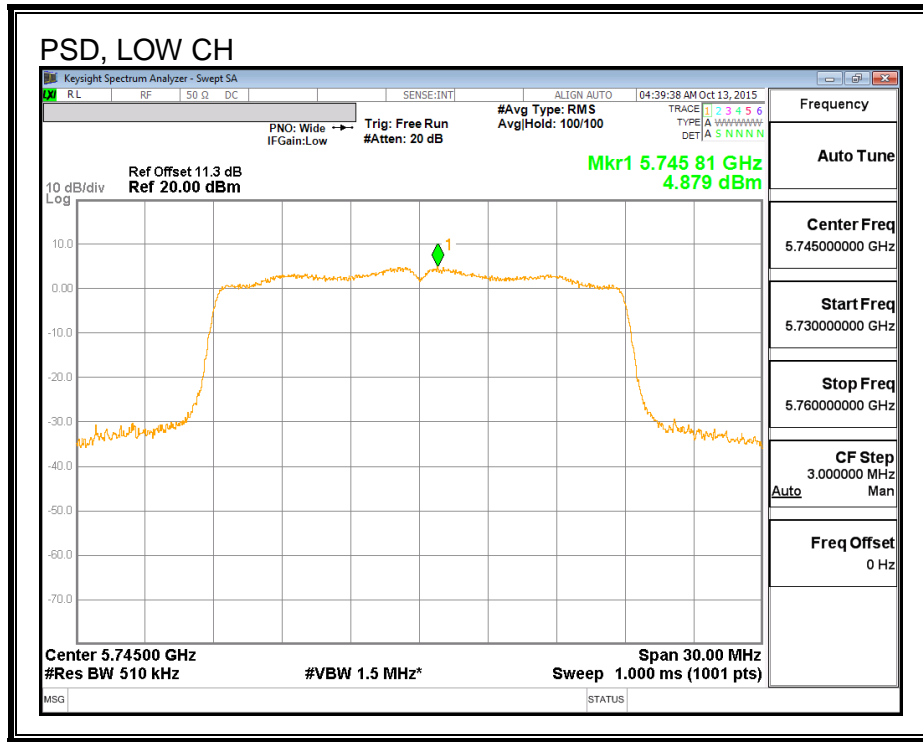

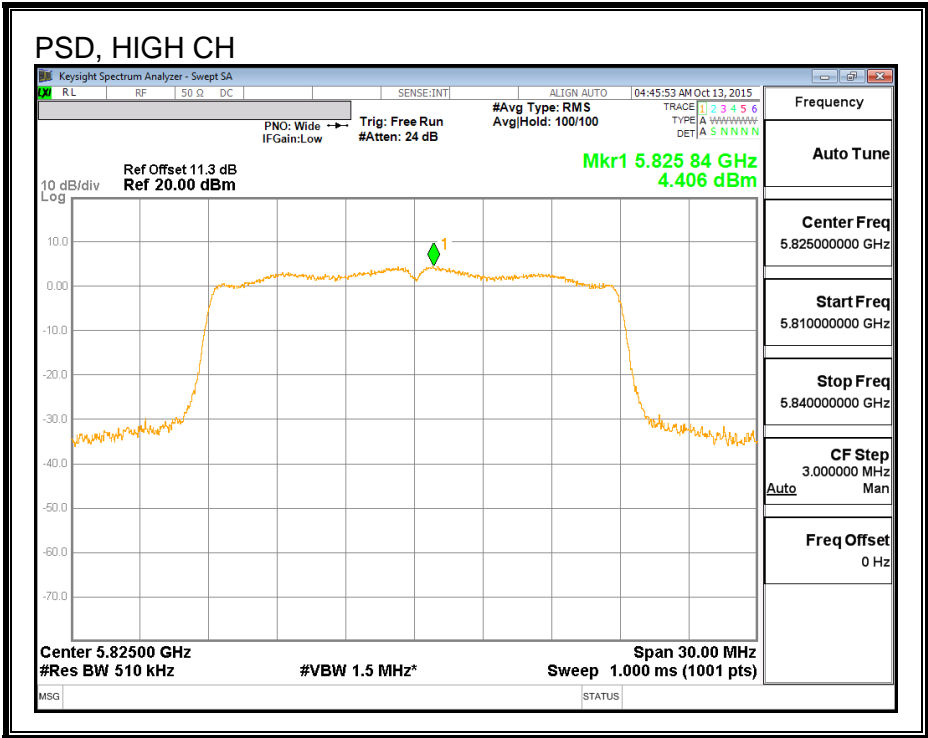

### 8.3. 802.11n HT40 MODE IN THE 5.8 GHz BAND

#### 8.3.1. 6 dB BANDWIDTH

##### LIMITS

FCC §15.407 (e)

The minimum 6 dB bandwidth shall be at least 500 kHz.

##### RESULTS

Channel	Frequency (MHz)	6 dB Bandwidth (MHz)	Minimum Limit (MHz)
Low	5755	35.28	0.5
High	5795	35.34	0.5

**6 dB BANDWIDTH**

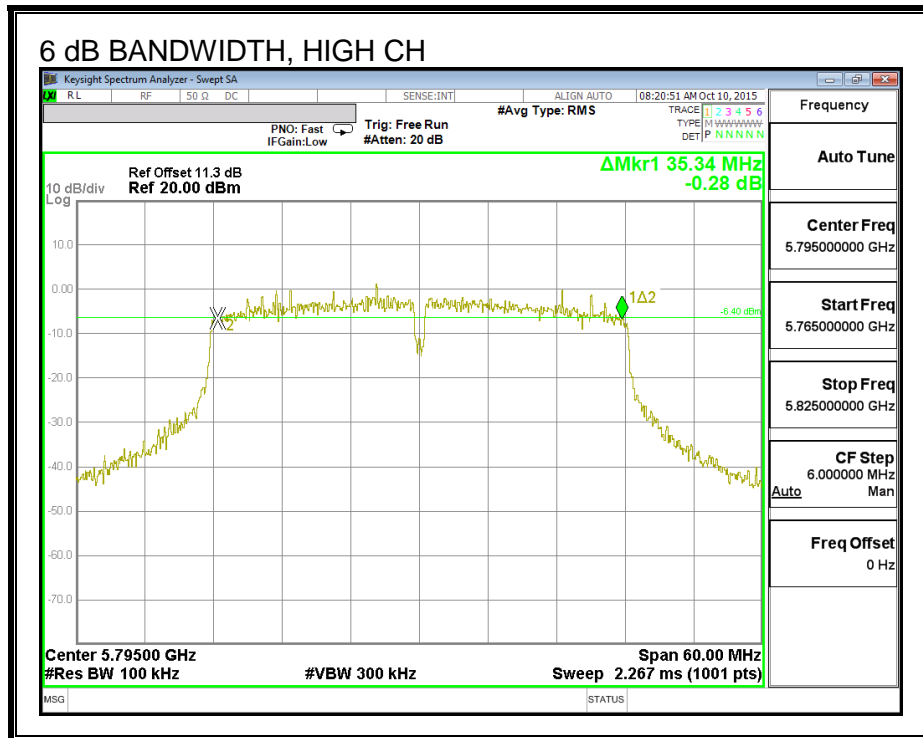
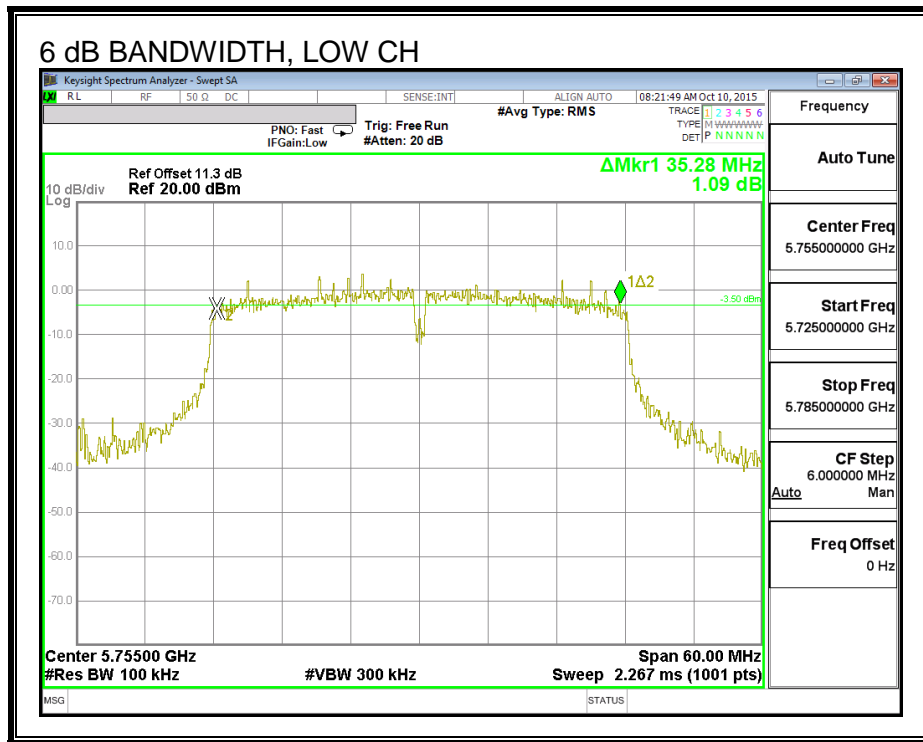

### 8.3.2. 26 dB BANDWIDTH

#### LIMITS

None, for reporting purposes only.

#### RESULTS

Channel	Frequency (MHz)	26 dB Bandwidth (MHz)
Low	5755	42.48
High	5795	42.54

**26 dB BANDWIDTH**

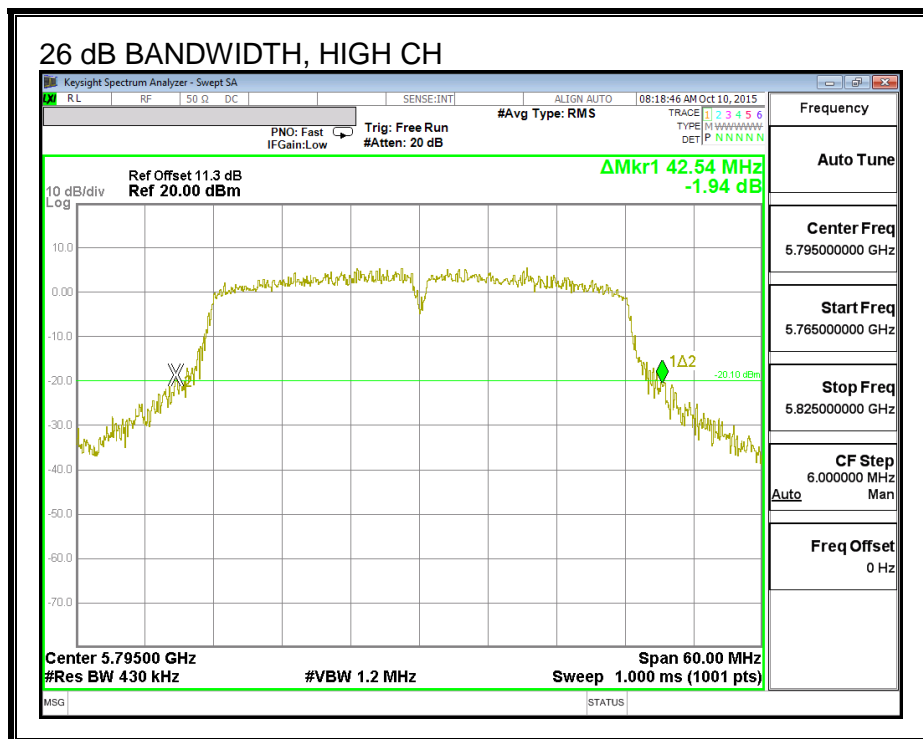
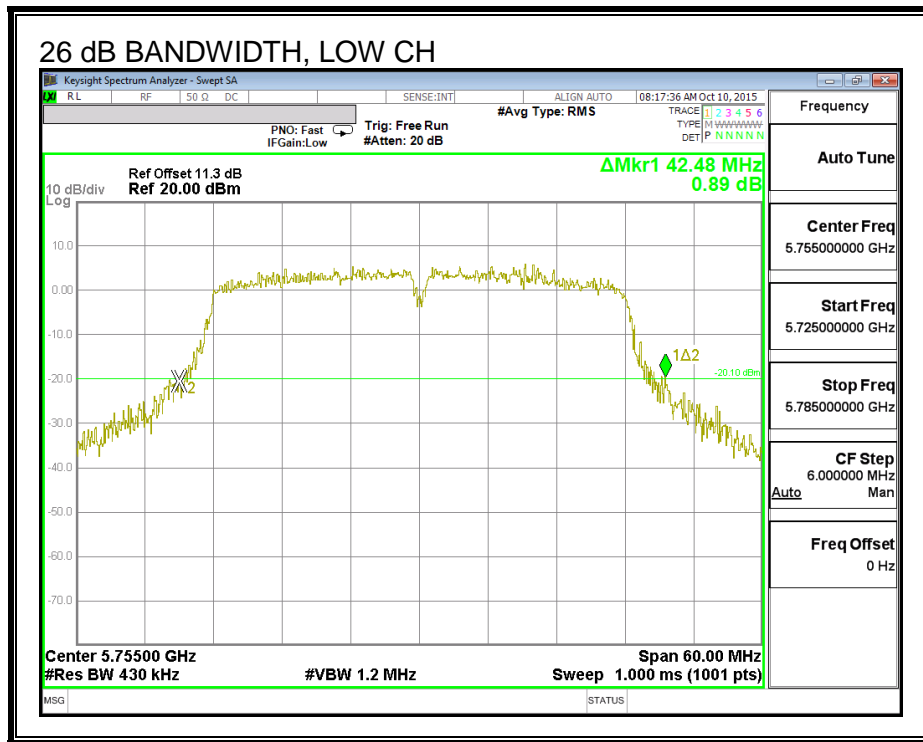

### 8.3.3. 99% BANDWIDTH

#### LIMITS

None; for reporting purposes only.

#### RESULTS

Channel	Frequency (MHz)	99% Bandwidth (MHz)
Low	5755	35.989
High	5795	35.783



**99% BANDWIDTH**

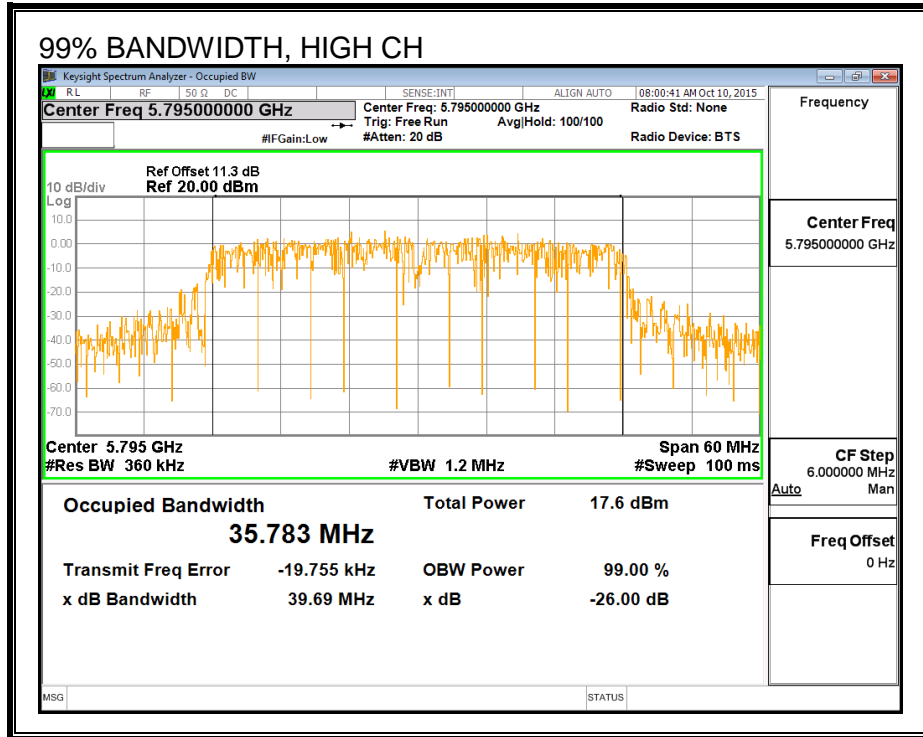
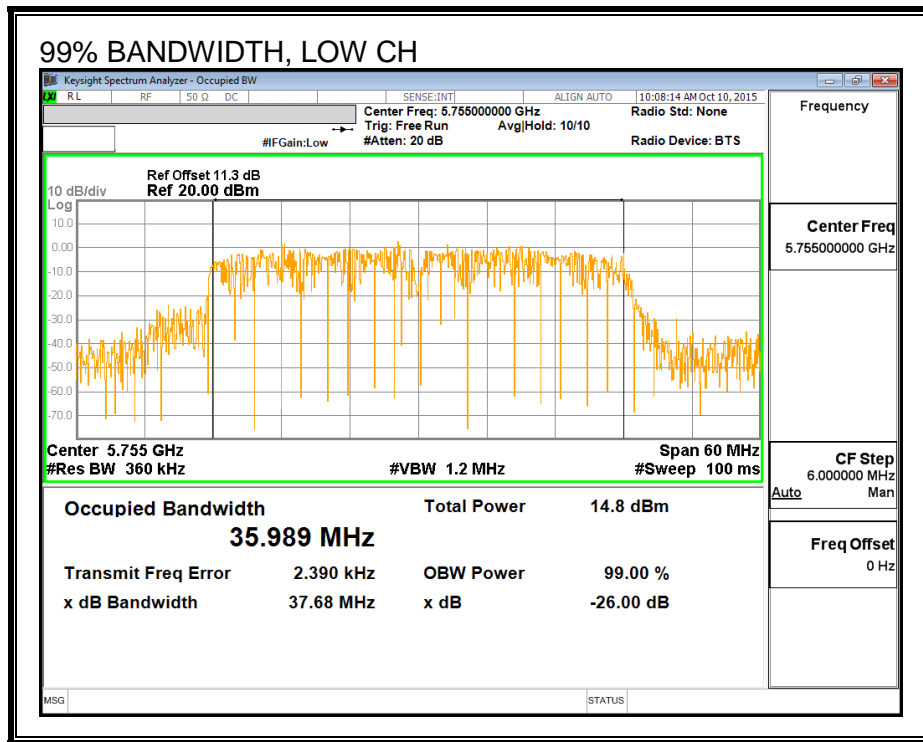

### 8.3.4. AVERAGE POWER

#### LIMITS

None; for reporting purposes only.

#### Test Procedure

Measurements perform using a wideband gated RF power meter.

#### RESULTS

Channel	Frequency (MHz)	Power (dBm)
Low	5755	13.68
High	5795	14.48

### **8.3.5. OUTPUT POWER**

#### **LIMITS**

FCC §15.407 (a) (3)

For the band 5.725-5.85 GHz, the maximum conducted output power over the frequency band of operation shall not exceed 1 W. In addition, the maximum power spectral density shall not exceed 30 dBm in any 500-kHz band. If transmitting antennas of directional gain greater than 6 dBi are used, both the maximum conducted output power and the maximum power spectral density shall be reduced by the amount in dB that the directional gain of the antenna exceeds 6 dBi.

#### **Test Procedure**

Measurements perform using a wideband gated RF power meter provided that the gate parameters are adjusted such that the power is measured only when the EUT is transmitting at its maximum power control level. Since the measurement is made only during the ON time of the transmitter, no duty cycle correction factor is required.

#### **DIRECTIONAL ANTENNA GAIN**

There is only one transmitter output therefore the directional gain is equal to the antenna gain.

**RESULTS**

**Antenna Gain and Limit**

Channel	Frequency (MHz)	Directional Gain (dBi)	Power Limit (dBm)
Low	5755	4.90	30.00
High	5795	4.90	30.00

**Output Power Results**

Channel	Frequency (MHz)	Meas Power (dBm)	Total Corr'd Power (dBm)	Power Limit (dBm)	Power Margin (dB)
Low	5755	13.68	13.68	30.00	-16.32
High	5795	14.48	14.48	30.00	-15.52

### **8.3.6. PSD**

#### **LIMITS**

FCC §15.407 (a) (3)

For the band 5.725-5.85 GHz, the maximum conducted output power over the frequency band of operation shall not exceed 1 W. In addition, the maximum power spectral density shall not exceed 30 dBm in any 500-kHz band. If transmitting antennas of directional gain greater than 6 dBi are used, both the maximum conducted output power and the maximum power spectral density shall be reduced by the amount in dB that the directional gain of the antenna exceeds 6 dBi.

#### **DIRECTIONAL ANTENNA GAIN**

There is only one transmitter output therefore the directional gain is equal to the antenna gain.

**RESULTS**

**Antenna Gain and Limits**

Channel	Frequency (MHz)	Directional Gain (dBi)	PSD Limit (dBm)
Low	5755	4.90	30.00
High	5795	4.90	30.00

<b>Duty Cycle CF (dB)</b>	0.00	<b>Included in Calculations of Corr'd PSD</b>
---------------------------	------	---

**PSD Results**

Channel	Frequency (MHz)	Meas PSD (dBm)	Total Corr'd PSD (dBm)	PSD Limit (dBm)	PSD Margin (dB)
Low	5755	-0.336	-0.336	30.00	-30.34
High	5795	0.733	0.733	30.00	-29.27

**PSD,**

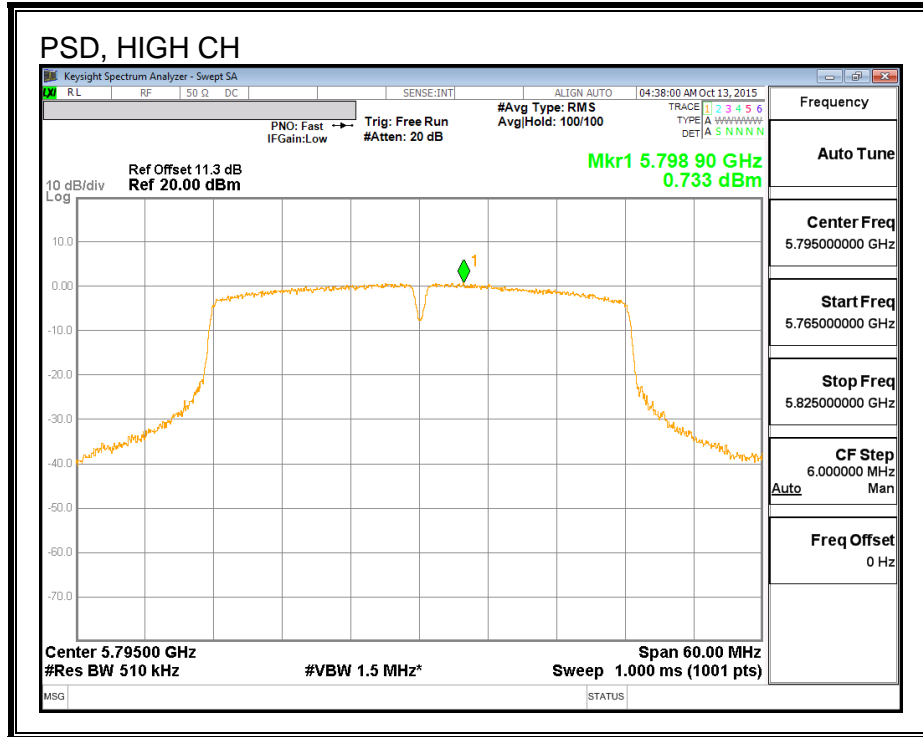
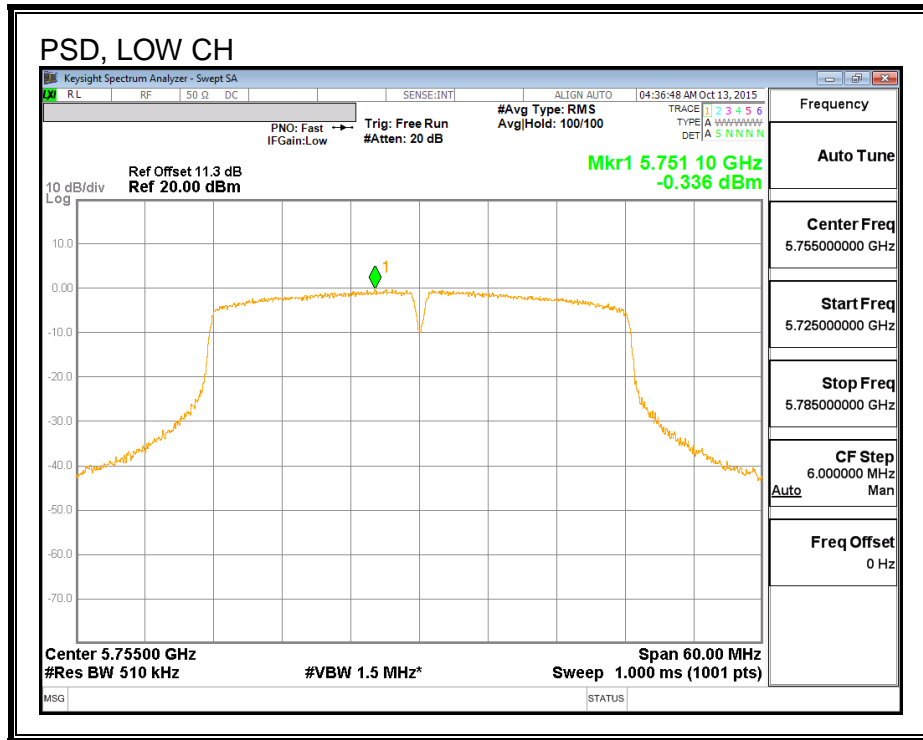

## 9. RADIATED TEST RESULTS

### 9.1. LIMITS AND PROCEDURE

#### LIMITS

FCC §15.205 and §15.209

Frequency Range (MHz)	Field Strength Limit (uV/m) at 3 m	Field Strength Limit (dBuV/m) at 3 m
30 - 88	100	40
88 - 216	150	43.5
216 - 960	200	46
Above 960	500	54

#### TEST PROCEDURE

The EUT is placed on a non-conducting table 80 cm above the ground plane for measurement below 1GHz; 1.5 m above the ground plane for measurement above 1GHz. The antenna to EUT distance is 3 meters. The EUT is configured in accordance with ANSI C63.10. The EUT is set to transmit in a continuous mode.

For measurements below 1 GHz the resolution bandwidth is set to 100 kHz for peak detection measurements or 120 kHz for quasi-peak detection measurements. Peak detection is used unless otherwise noted as quasi-peak.

For measurements above 1 GHz the resolution bandwidth is set to 1 MHz; the video bandwidth is set to 3 MHz for peak measurements and as applicable for average measurements.

The spectrum from 30 MHz to 40 GHz is investigated with the transmitter set to the lowest, middle, and highest channels in each applicable band.

The frequency range of interest is monitored at a fixed antenna height and EUT azimuth. The EUT is rotated through 360 degrees to maximize emissions received. The antenna is scanned from 1 to 4 meters above the ground plane to further maximize the emission. Measurements are made with the antenna polarized in both the vertical and the horizontal positions.

Radiated emission were performed with the EUT set to transmit at the channel with highest output power as worst-case scenario.



## 9.2. 802.11a MODE IN THE 5.8 GHz BAND

### RESTRICTED BANDEDGE (LOW CHANNEL)

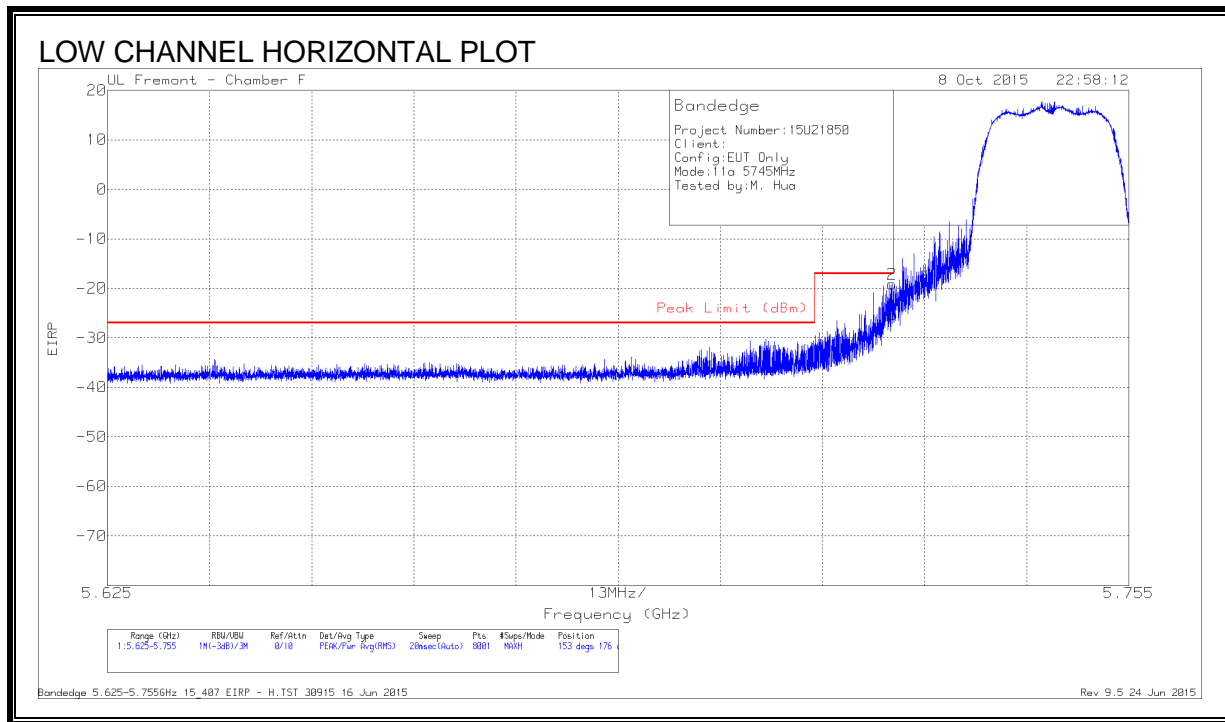

### DATA

Marker	Frequency (GHz)	Meter Reading (dBm)	Det	AF T120 (dB/m)	Amp/Cbl/F ltr/Pad (dB)	Conversion Factor (dB)	Corrected Reading EIRP	Peak Limit (dBm)	PK Margin (dB)	Azimuth (Degs)	Height (cm)	Polarity
1	5.725	-53.62	Pk	34.9	-18.4	11.8	-25.32	-17	-8.32	153	176	H
2	5.725	-47.4	Pk	34.9	-18.4	11.8	-19.1	-17	-2.1	153	176	H

Pk - Peak detector

Bandedge 5.625-5.755GHz 15\_407 EIRP - H.TST 30915 16 Jun 2015

Rev 9.5 24 Jun 2015

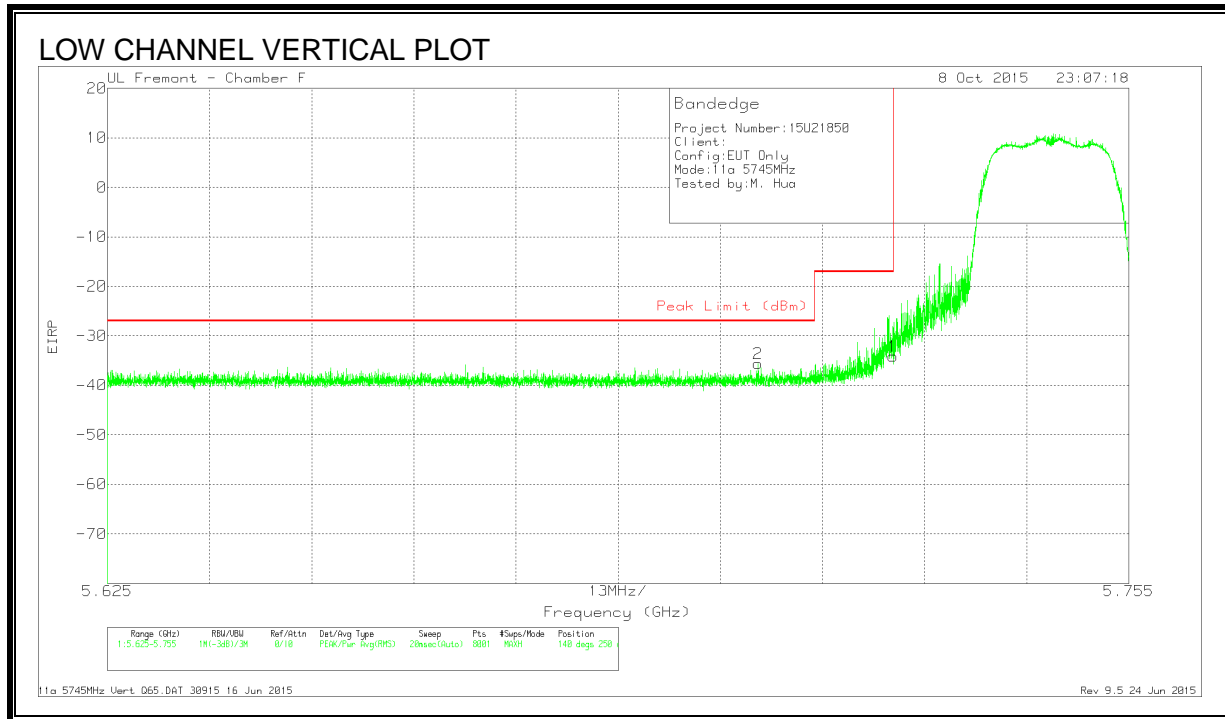

**DATA**

Marker	Frequency (GHz)	Meter Reading (dBm)	Det	AF T120 (dB/m)	Amp/Cbl/F ltr/Pad (dB)	Conversion Factor (dB)	Corrected Reading EIRP	Peak Limit (dBm)	PK Margin (dB)	Azimuth (Degs)	Height (cm)	Polarity
1	5.725	-62.44	Pk	34.9	-18.4	11.8	-34.14	-17	-17.14	140	250	V
2	5.708	-63.95	Pk	34.8	-18.3	11.8	-35.65	-27	-8.65	140	250	V

Pk - Peak detector

11a 5745MHz Vert Q65.DAT 30915 16 Jun 2015

Rev 9.5 24 Jun 2015

**RESTRICTED BANDEDGE (HIGH CHANNEL)**

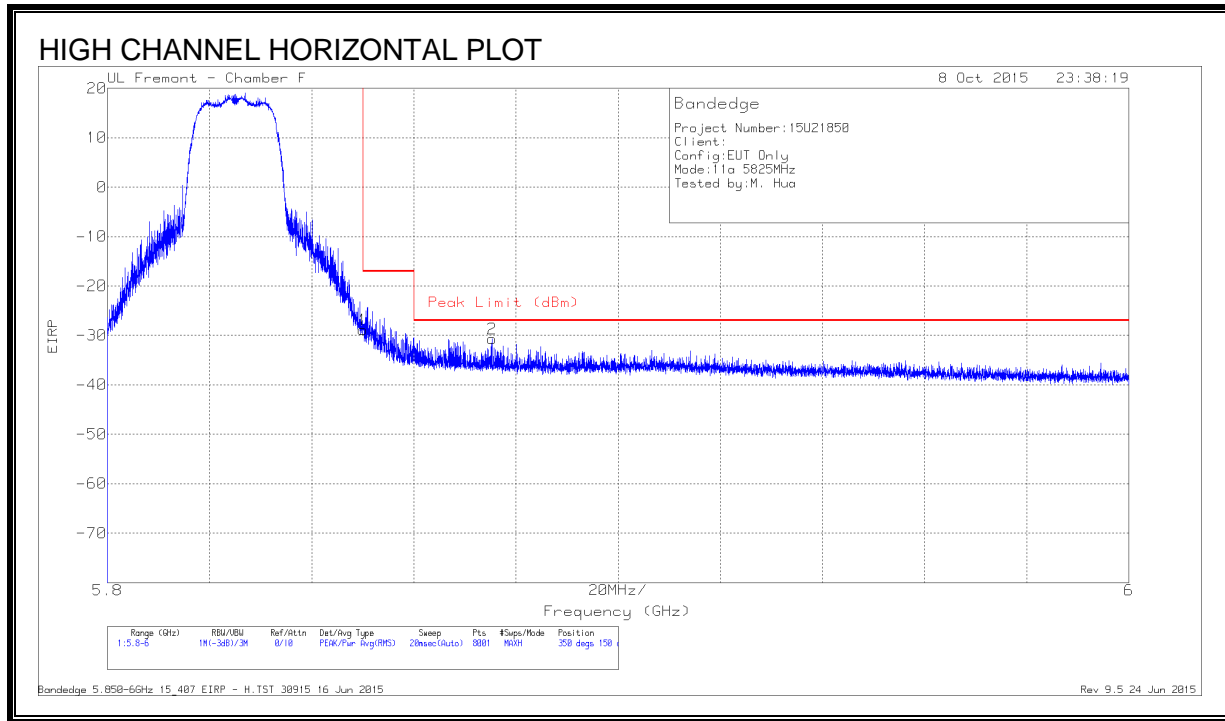

**DATA**

Marker	Frequency (GHz)	Meter Reading (dBm)	Det	AF T120 (dB/m)	Amp/Cbl/F ltr/Pad (dB)	Conversion Factor (dB)	Corrected Reading EIRP	Peak Limit (dBm)	PK Margin (dB)	Azimuth (Degs)	Height (cm)	Polarity
1	5.85	-57.16	Pk	35.1	-18.6	11.8	-28.86	-17	-11.86	350	150	H
2	5.875	-59.02	Pk	35.2	-18.7	11.8	-30.72	-27	-3.72	350	150	H

Pk - Peak detector

Bandedge 5.850-6GHz 15\_407 EIRP - H.TST 30915 16 Jun 2015

Rev 9.5 24 Jun 2015

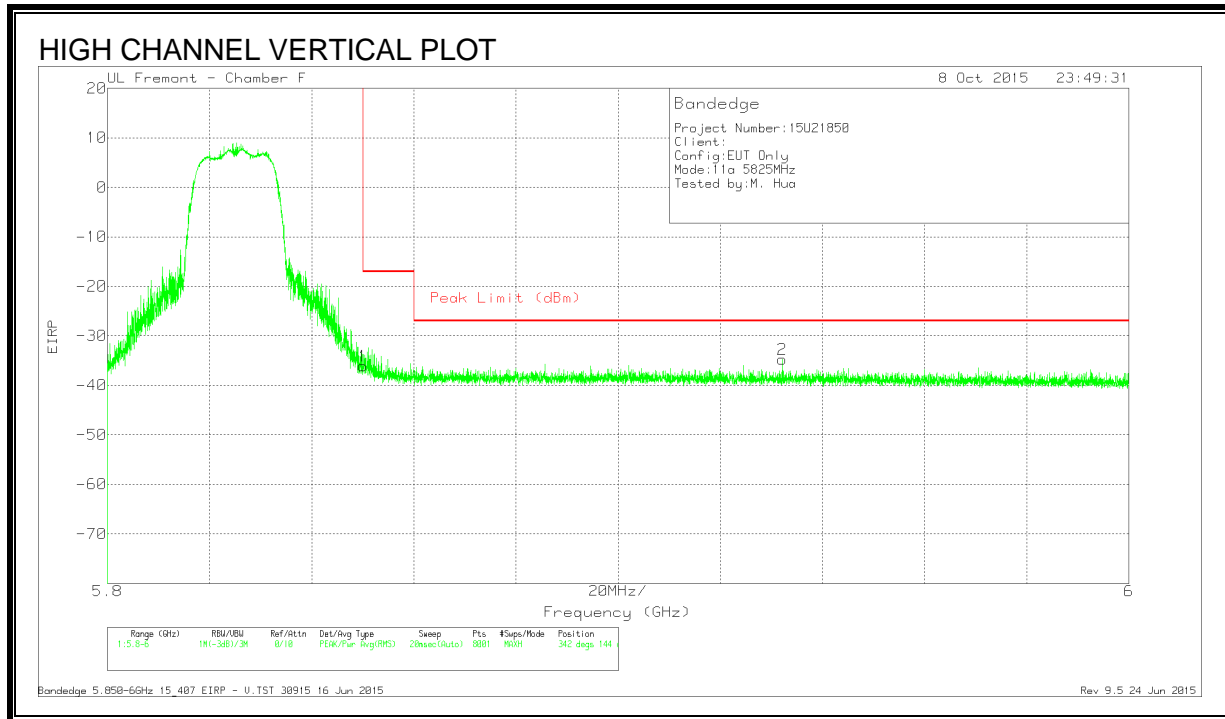

**DATA**

Marker	Frequency (GHz)	Meter Reading (dBm)	Det	AF T120 (dB/m)	Amp/Cbl/F ltr/Pad (dB)	Conversion Factor (dB)	Corrected Reading EIRP	Peak Limit (dBm)	PK Margin (dB)	Azimuth (Degs)	Height (cm)	Polarity
1	5.85	-64.41	Pk	35.1	-18.6	11.8	-36.11	-17	-19.11	342	144	V
2	5.932	-63.25	Pk	35.3	-18.6	11.8	-34.75	-27	-7.75	342	144	V

Pk - Peak detector

Bandedge 5.850-6GHz 15\_407 EIRP - V.TST 30915 16 Jun 2015

Rev 9.5 24 Jun 2015

**LOW CHANNEL HARMONICS AND SPURIOUS EMISSIONS**

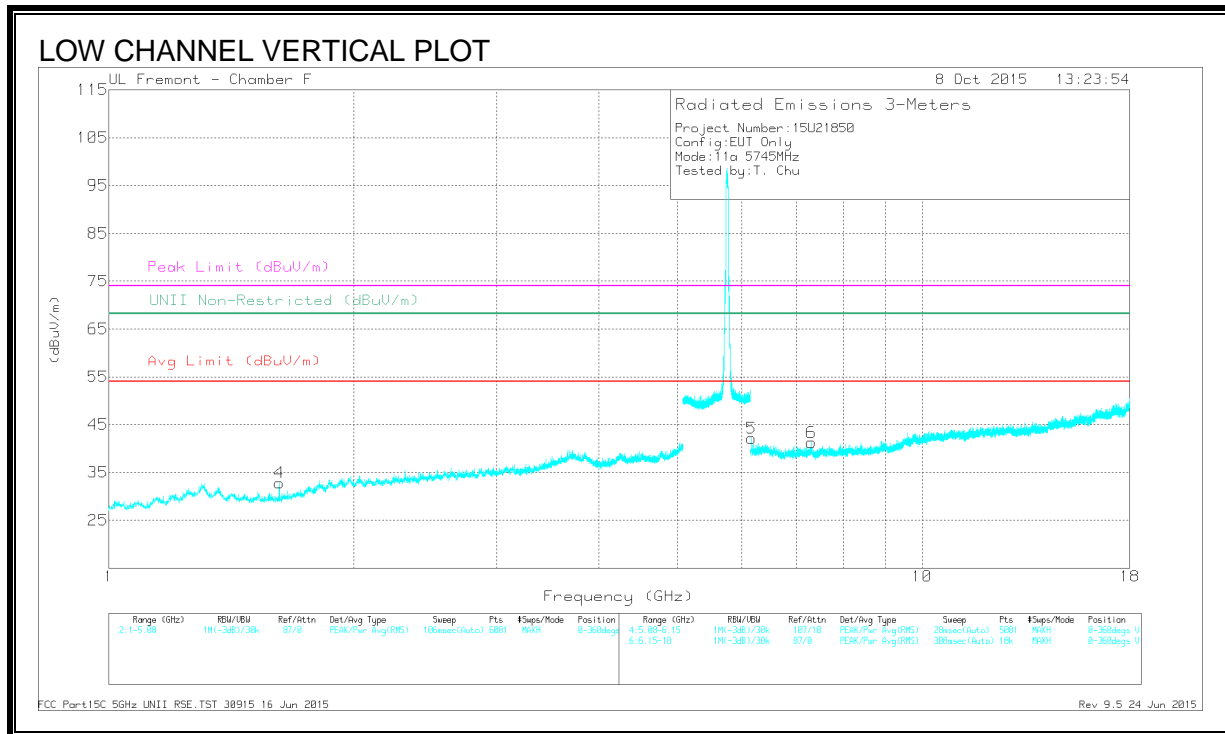
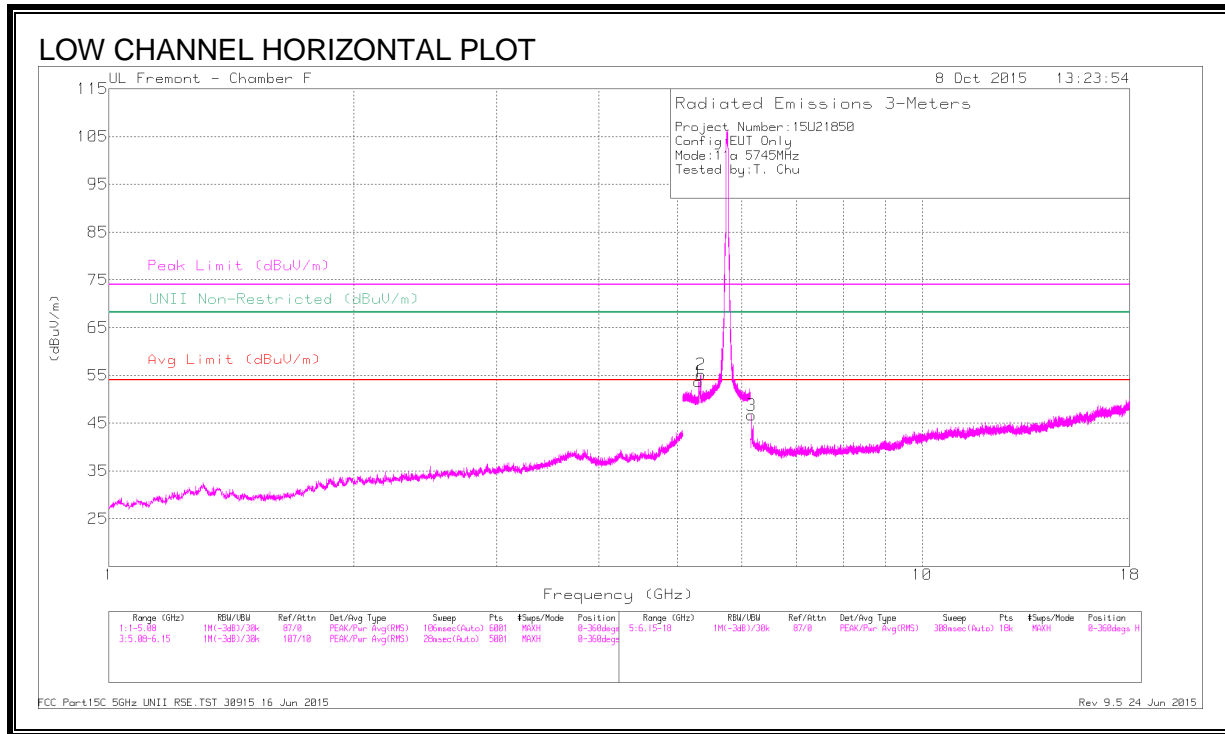

**DATA**

Marker	Frequency (GHz)	Meter Reading (dBuV)	Det	AF T120 (dB/m)	Amp/Cb/Fl tr/Pad (dB)	DC Corr (dB)	Corrected Reading (dBuV/m)	Avg Limit (dBuV/m)	Margin (dB)	Peak Limit (dBuV/m)	PK Margin (dB)	UNII Non-Restricted (dBuV/m)	PK Margin (dB)	Azimuth (Degs)	Height (cm)	Polarity
1	5.314	46.1	PK-U	34.5	-18.9	0	61.70	-	-	-	-	68.2	-6.5	98	180	H
2	5.345	47.15	PK-U	34.6	-18.8	0	62.95	-	-	-	-	68.2	-5.25	104	164	H
3	6.165	45.58	PK-U	35.7	-26.6	0	54.68	-	-	-	-	68.2	-13.52	179	141	H
4	* 1.620	43.35	PK-U	28.3	-31.6	0	40.05	-	-	74	-33.95	-	-	163	106	V
	* 1.620	34.69	ADR	28.3	-31.6	0	31.39	54	-22.61	-	-	-	-	163	106	V
5	6.165	40.65	PK-U	35.7	-26.6	0	49.75	-	-	-	-	68.2	-18.45	161	126	V
6	* 7.309	36.67	PK-U	35.7	-25.3	0	47.07	-	-	74	-26.93	-	-	52	374	V
	* 7.306	25.21	ADR	35.7	-25.3	0	35.61	54	-18.39	-	-	-	-	52	374	V

\* - indicates frequency in CFR15.205/IC8.10 Restricted Band

PK-U - U-NII: Maximum Peak

ADR - U-NII AD primary method, RMS average

FCC Part15C 5GHz UNII RSE.TST 30915 16 Jun 2015

Rev 9.5 24 Jun 2015

**MID CHANNEL HARMONICS AND SPURIOUS EMISSIONS**

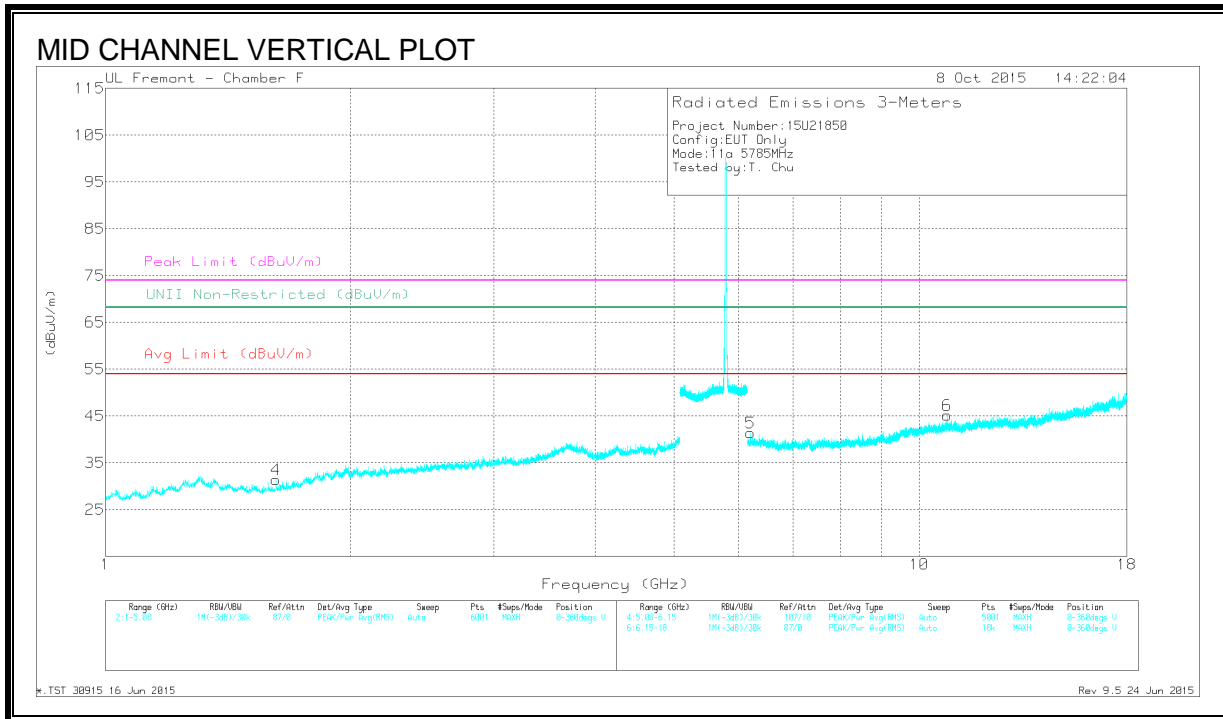
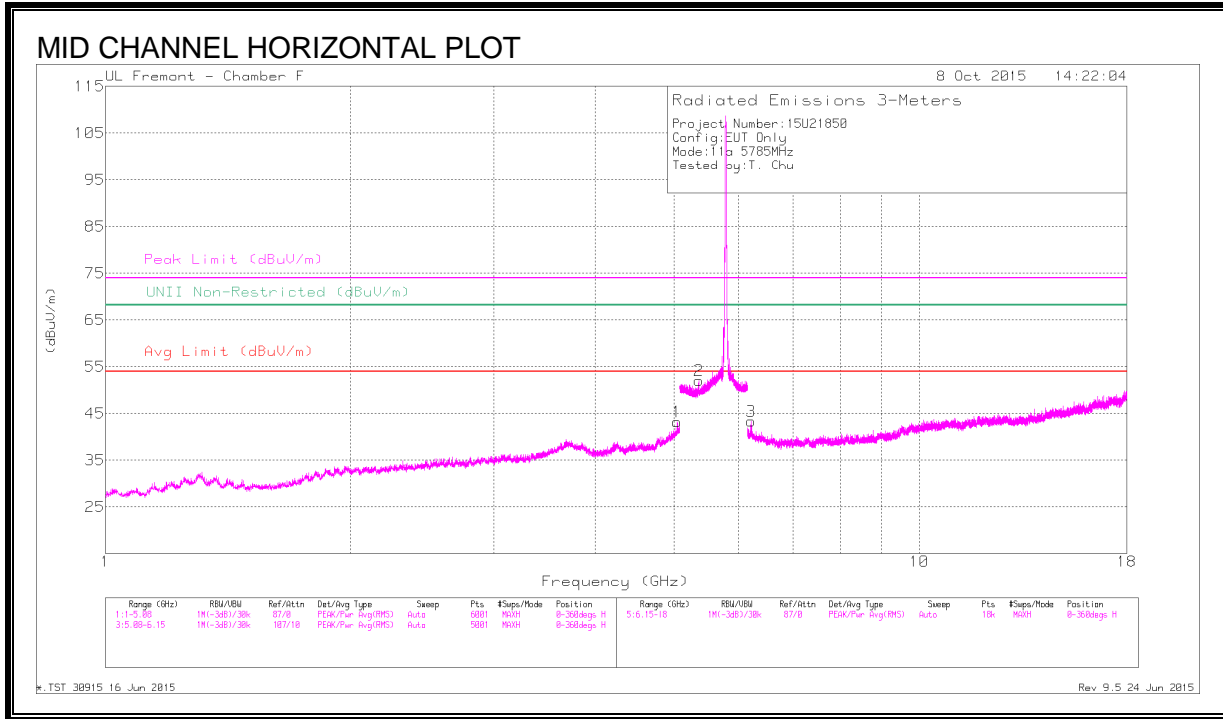

**DATA**

Marker	Frequency (GHz)	Meter Reading (dBuV)	Det	AF T120 (dB/m)	Amp/Cbl/Fi tr/Pad (dB)	DC Corr (dB)	Corrected Reading (dBuV/m)	Avg Limit (dBuV/m)	Margin (dB)	Peak Limit (dBuV/m)	PK Margin (dB)	UNI Non-Restricted (dBuV/m)	PK Margin (dB)	Azimuth (Degs)	Height (cm)	Polarity
1	* 5.046	40.16	PK-U	34.2	-26.5	0	47.86	-	-	74	-26.14	-	-	271	100	H
	* 5.043	28.22	ADR	34.2	-26.4	0	36.02	54	-17.98	-	-	-	-	271	100	H
2	* 5.363	43.11	PK-U	34.6	-18.9	0	58.81	-	-	74	-15.19	-	-	15	229	H
	* 5.363	31.61	ADR	34.6	-18.9	0	47.31	54	-6.69	-	-	-	-	15	229	H
3	6.219	42.12	PK-U	35.7	-26.6	0	51.22	-	-	-	-	68.2	-16.98	356	150	H
4	* 1.620	43.53	PK-U	28.3	-31.6	0	40.23	-	-	74	-33.77	-	-	351	332	V
	* 1.620	33.83	ADR	28.3	-31.6	0	30.53	54	-23.47	-	-	-	-	351	332	V
5	6.205	37.95	PK-U	35.7	-26.7	0	46.95	-	-	-	-	68.2	-21.25	4	211	V
6	* 10.817	33.83	PK-U	38	-21.9	0	49.93	-	-	74	-24.07	-	-	57	213	V
	* 10.819	22.33	ADR	38	-21.9	0	38.43	54	-15.57	-	-	-	-	57	213	V

\* - indicates frequency in CFR15.205/IC8.10 Restricted Band

PK-U - U-NII: Maximum Peak

ADR - U-NII AD primary method, RMS average

\*.TST 30915 16 Jun 2015

Rev 9.5 24 Jun 2015



**HIGH CHANNEL HARMONICS AND SPURIOUS EMISSIONS**

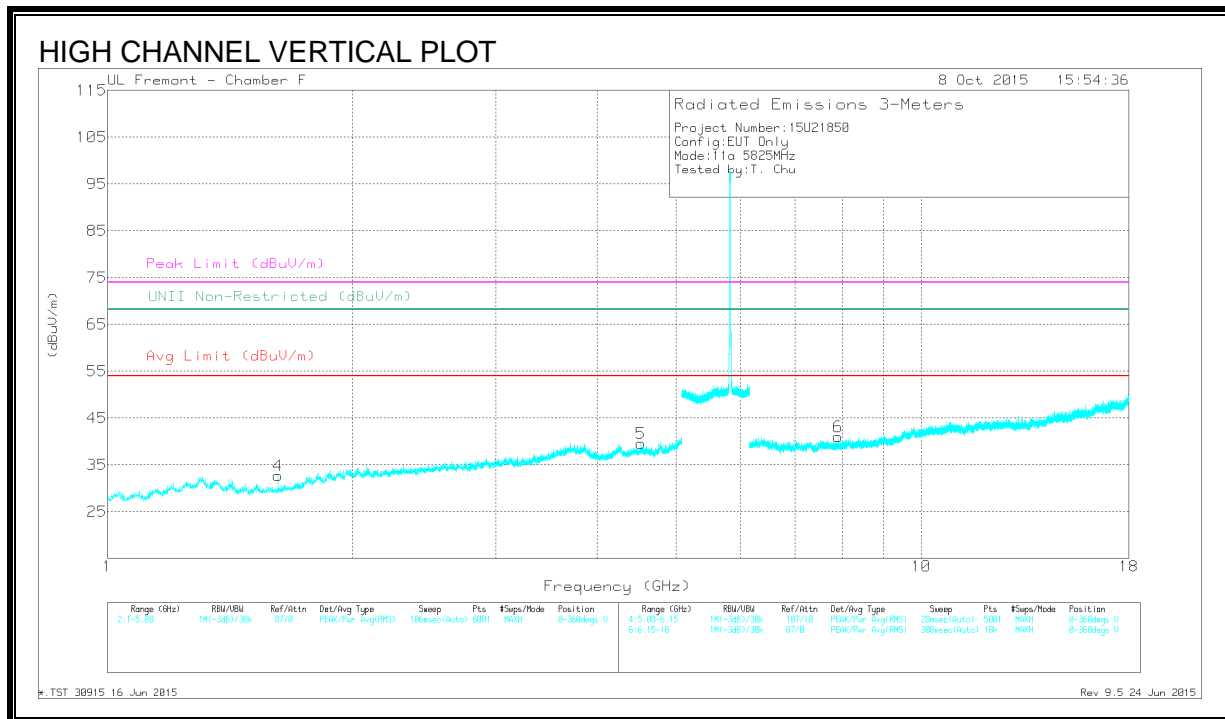
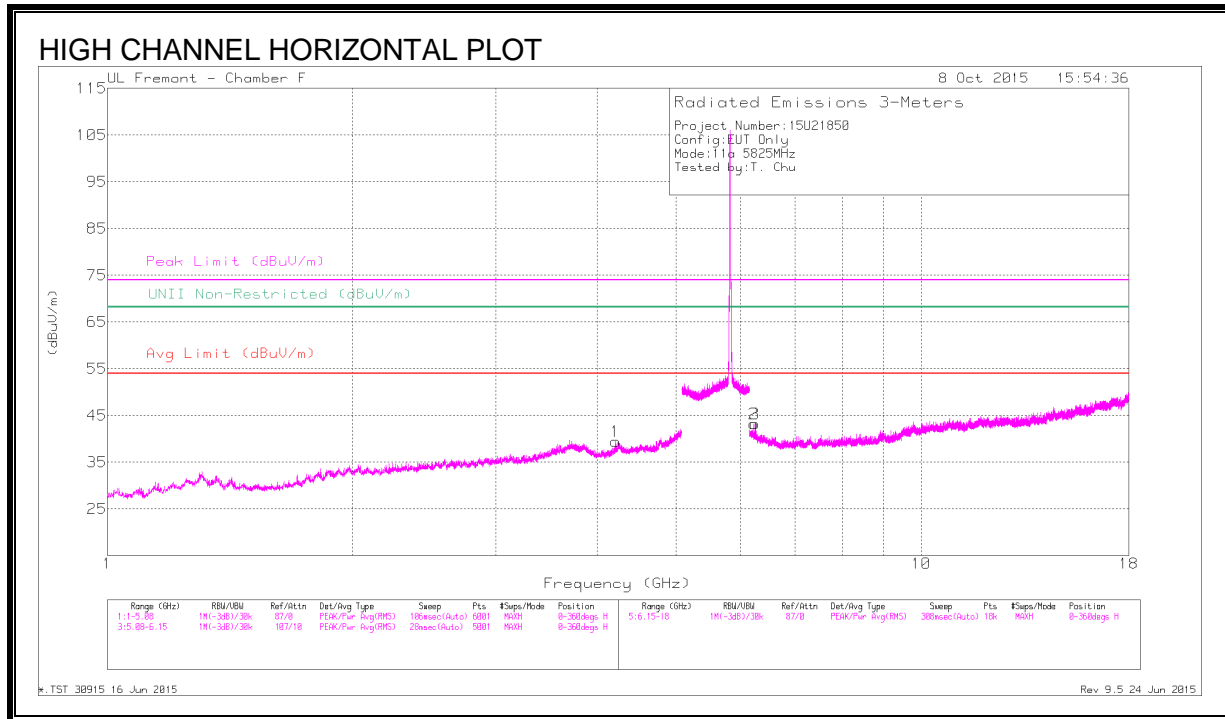

**DATA**

Marker	Frequency (GHz)	Meter Reading (dBuV)	Det	AF T120 (dB/m)	Amp/Cb/FI tr/Pad (dB)	DC Corr (dB)	Corrected Reading (dBuV/m)	Avg Limit (dBuV/m)	Margin (dB)	Peak Limit (dBuV/m)	PK Margin (dB)	UNII Non-Restricted (dBuV/m)	PK Margin (dB)	Azimuth (Degs)	Height (cm)	Polarity
1	* 4.214	38.03	PK-U	33.6	-27.9	0	43.73	-	-	74	-30.27	-	-	265	240	H
	* 4.214	26.55	ADR	33.6	-27.9	0	32.25	54	-21.75	-	-	-	-	265	240	H
2	6.228	37.69	PK-U	35.7	-26.7	0	46.69	-	-	-	-	68.2	-21.51	178	202	H
3	6.250	37.37	PK-U	35.7	-26.8	0	46.27	-	-	-	-	68.2	-21.93	134	180	H
4	* 1.620	42.59	PK-U	28.3	-31.6	0	39.29	-	-	74	-34.71	-	-	335	265	V
	* 1.620	32.71	ADR	28.3	-31.6	0	29.41	54	-24.59	-	-	-	-	335	265	V
5	* 4.525	38.04	PK-U	33.9	-27.6	0	44.34	-	-	74	-29.66	-	-	139	108	V
	* 4.525	26.64	ADR	33.9	-27.6	0	32.94	54	-21.06	-	-	-	-	139	108	V
6	7.912	36.29	PK-U	35.8	-25.3	0	46.79	-	-	-	-	68.2	-21.41	239	102	V

\* - indicates frequency in CFR15.205/IC8.10 Restricted Band

PK-U - U-NII: Maximum Peak

ADR - U-NII AD primary method, RMS average

\*.TST 30915 16 Jun 2015

Rev 9.5 24 Jun 2015

### 9.3. 802.11n HT20 MODE IN THE 5.8 GHz BAND

#### RESTRICTED BANDEDGE (LOW CHANNEL)

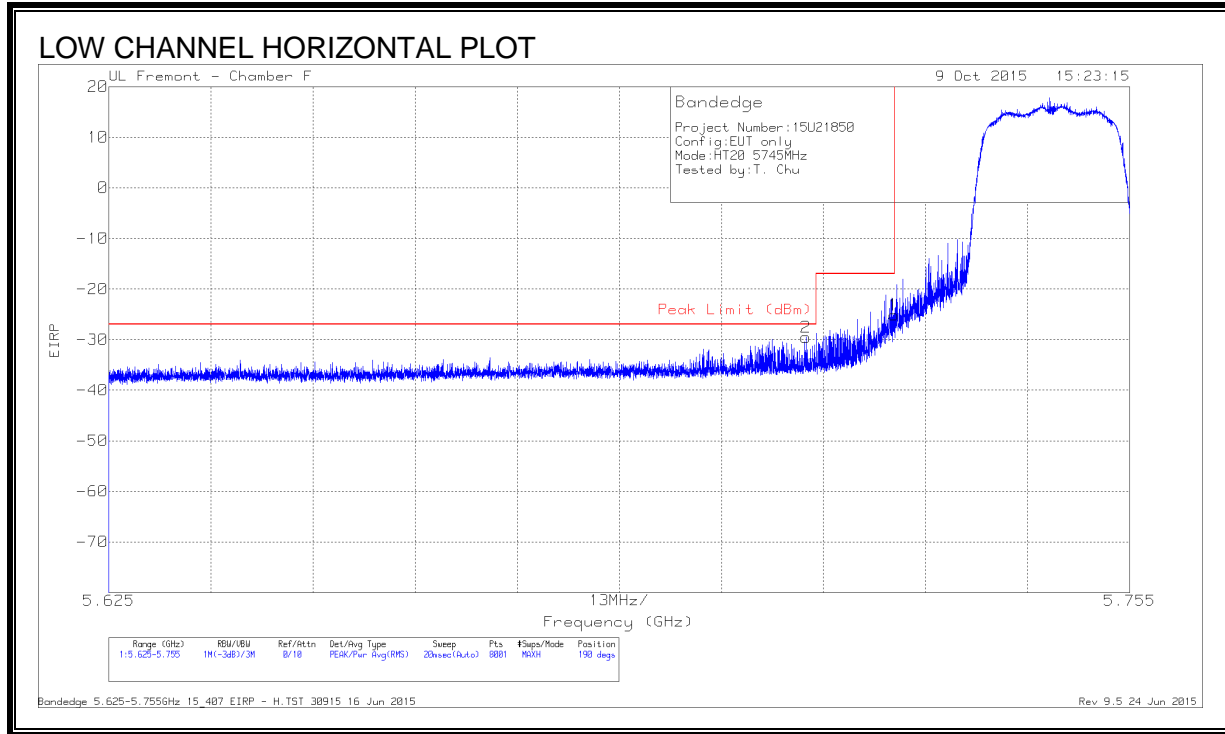

#### DATA

Marker	Frequency (GHz)	Meter Reading (dBm)	Det	AF T120 (dB/m)	Amp/Cbl/Filtr/Pad (dB)	Conversion Factor (dB)	DC Corr (dB)	Corrected Reading EIRP	Peak Limit (dBm)	PK Margin (dB)	Azimuth (Degs)	Height (cm)	Polarity
1	5.725	-53.42	Pk	34.9	-18.4	11.8	0	-25.12	-17	-8.12	190	174	H
2	5.714	-57.82	Pk	34.8	-18.3	11.8	0	-29.52	-27	-2.52	190	174	H

Pk - Peak detector

Bandedge 5.625-5.755GHz 15\_407 EIRP - H.TST 30915 16 Jun 2015

Rev 9.5 24 Jun 2015

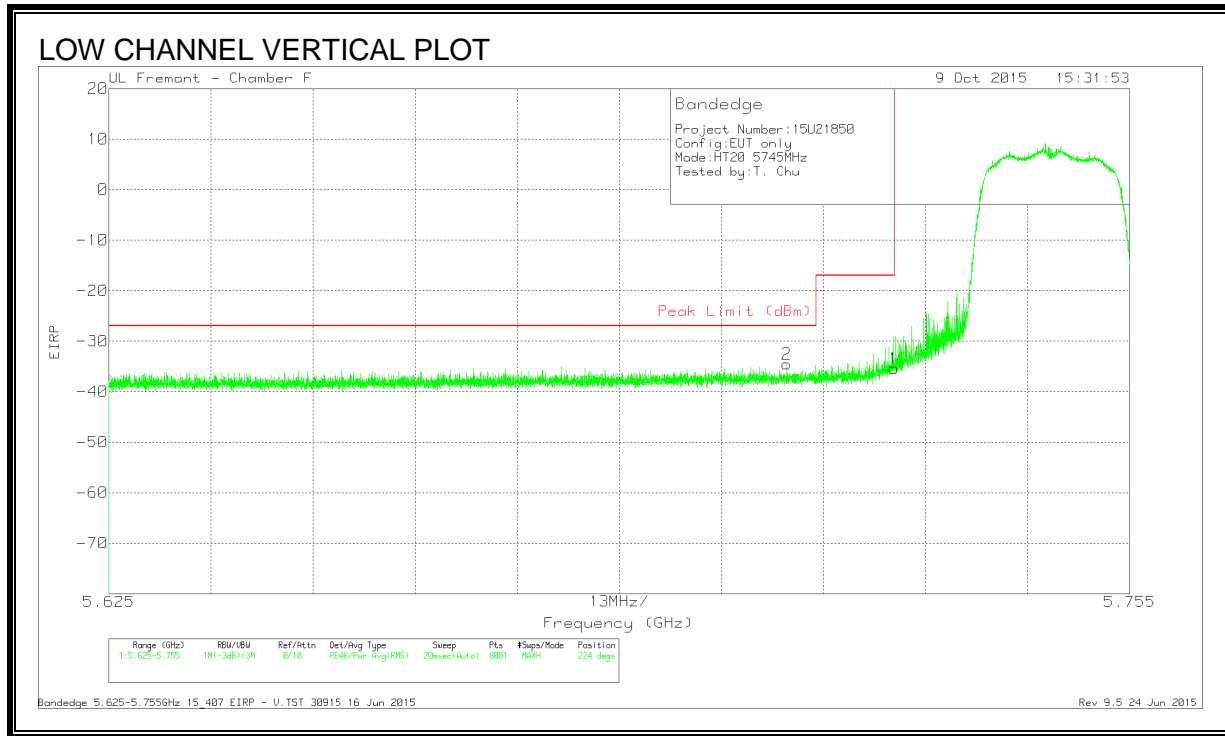

**DATA**

Marker	Frequency (GHz)	Meter Reading (dBm)	Det	AF T120 (dB/m)	Amp/Cbl/Fitr/Pad (dB)	Conversion Factor (dB)	DC Corr (dB)	Corrected Reading EIRP	Peak Limit (dBm)	PK Margin (dB)	Azimuth (Degs)	Height (cm)	Polarity
1	5.725	-63.69	Pk	34.9	-18.4	11.8	0	-35.39	-17	-18.39	224	179	V
2	5.711	-62.72	Pk	34.8	-18.4	11.8	0	-34.52	-27	-7.52	224	179	V

Pk - Peak detector

Bandedge 5.625-5.755GHz 15\_407 EIRP - V.TST 30915 16 Jun 2015

Rev 9.5 24 Jun 2015

**RESTRICTED BANDEDGE (HIGH CHANNEL)**

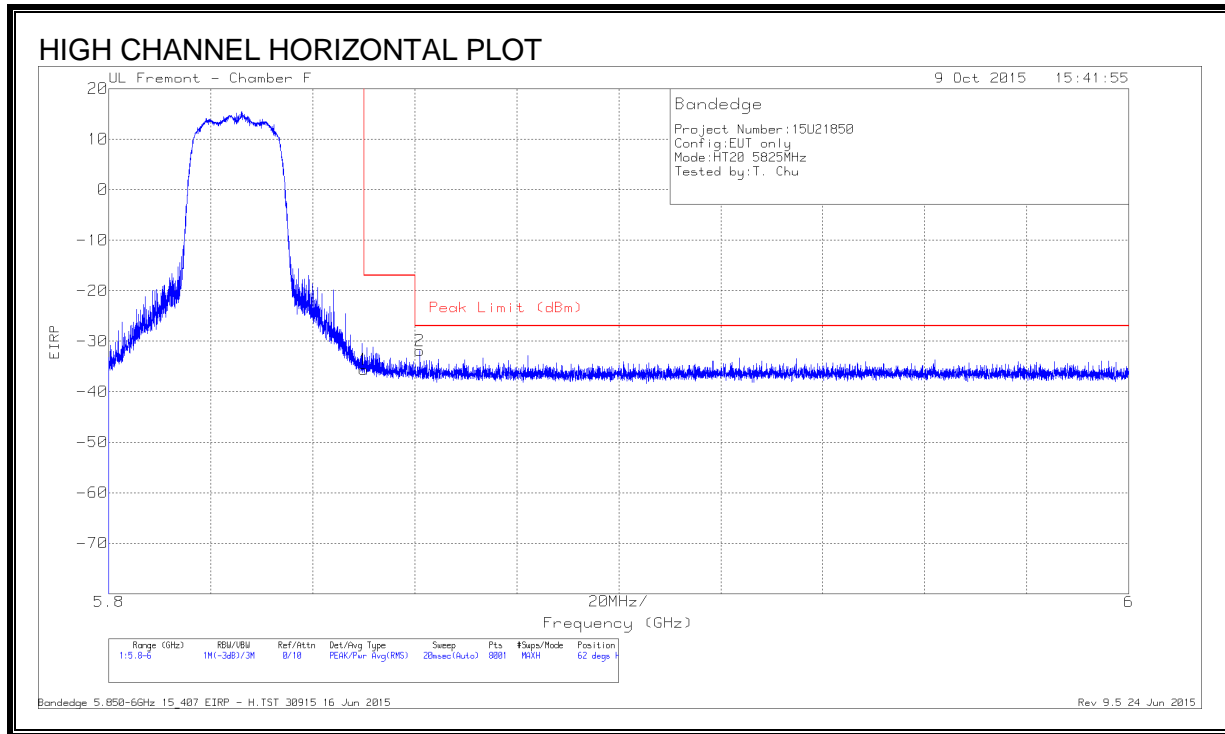

**DATA**

Marker	Frequency (GHz)	Meter Reading (dBm)	Det	AF T120 (dB/m)	Amp/Cbl/Filtr/Pad (dB)	Conversion Factor (dB)	DC Corr (dB)	Corrected Reading EIRP	Peak Limit (dBm)	PK Margin (dB)	Azimuth (Degs)	Height (cm)	Polarity
1	5.850	-63.88	Pk	35.1	-18.6	11.8	0	-35.58	-17	-18.58	62	156	H
2	5.861	-60.05	Pk	35.1	-18.7	11.8	0	-31.85	-27	-4.85	62	156	H

Pk - Peak detector

Bandedge 5.850-6GHz 15\_407 EIRP - H.TST 30915 16 Jun 2015

Rev 9.5 24 Jun 2015

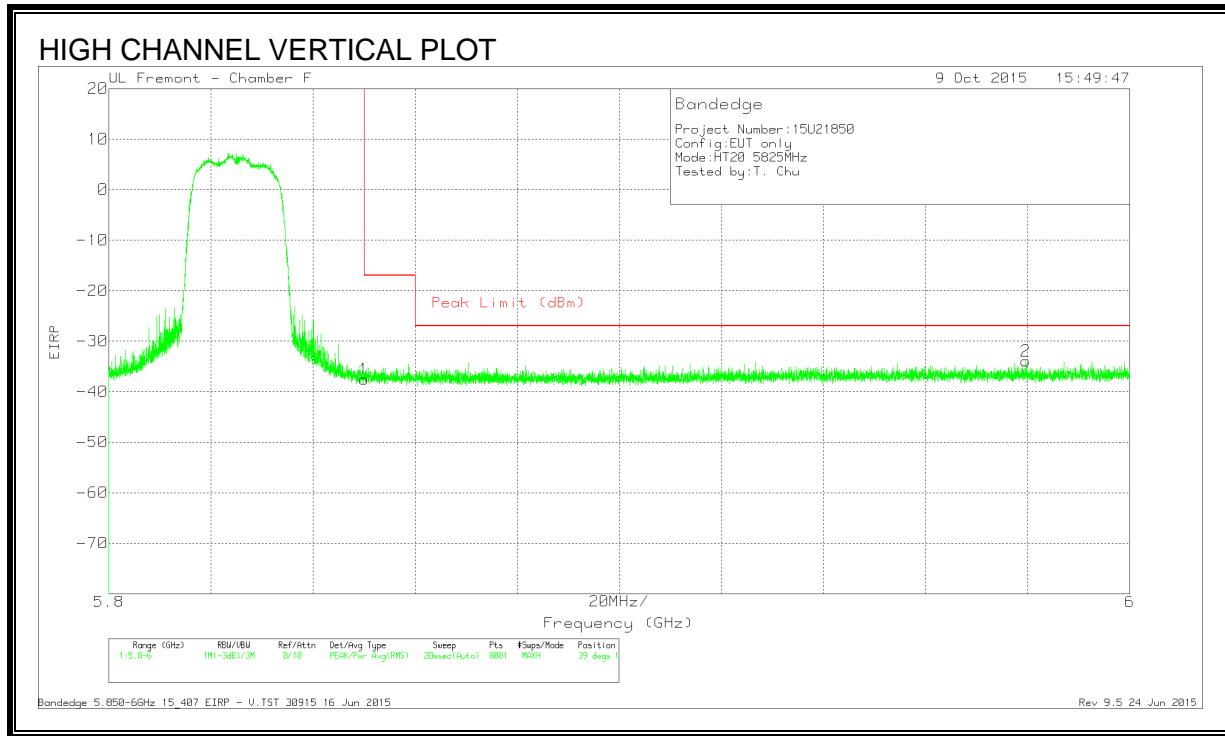

**DATA**

Marker	Frequency (GHz)	Meter Reading (dBm)	Det	AF T120 (dB/m)	Amp/Cbl/Fitr/Pad (dB)	Conversion Factor (dB)	DC Corr (dB)	Corrected Reading EIRP	Peak Limit (dBm)	PK Margin (dB)	Azimuth (Degs)	Height (cm)	Polarity
1	5.85	-65.79	Pk	35.1	-18.6	11.8	0	-37.49	-17	-20.49	39	157	V
2	5.98	-62.43	Pk	35.4	-18.7	11.8	0	-33.93	-27	-6.93	39	157	V

Pk - Peak detector

Bandedge 5.850-6GHz 15\_407 EIRP - V.TST 30915 16 Jun 2015

Rev 9.5 24 Jun 2015

**LOW CHANNEL HARMONICS AND SPURIOUS EMISSIONS**

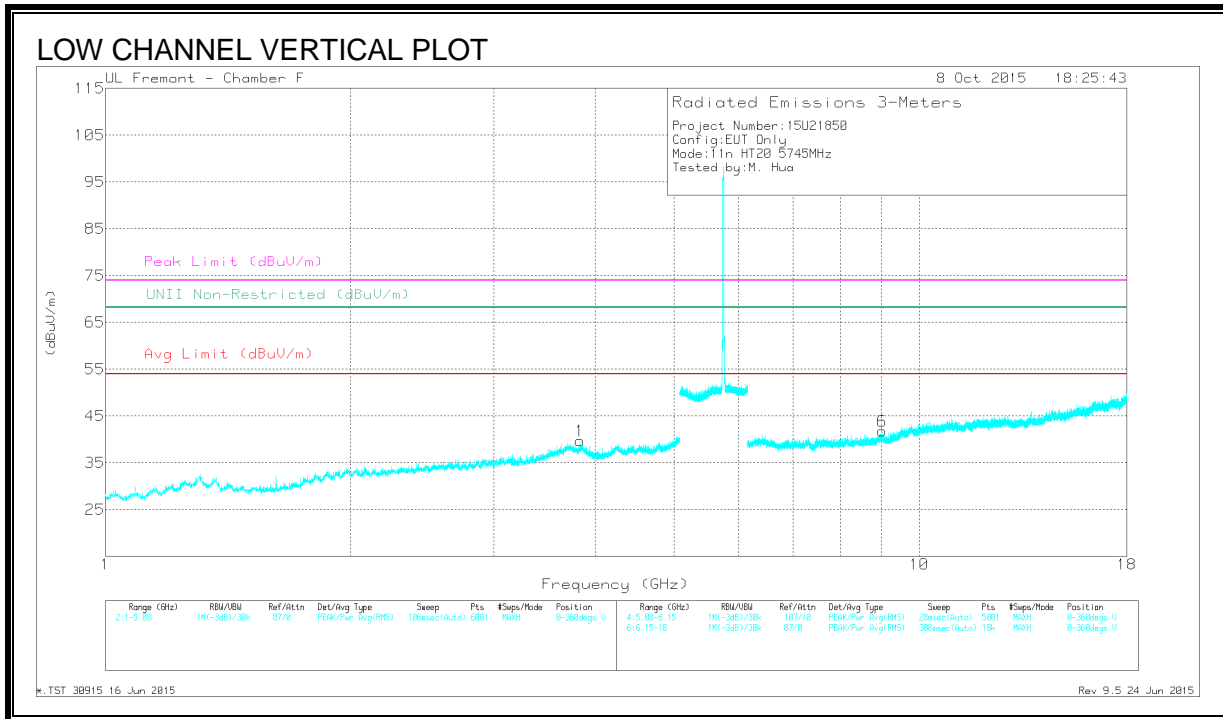
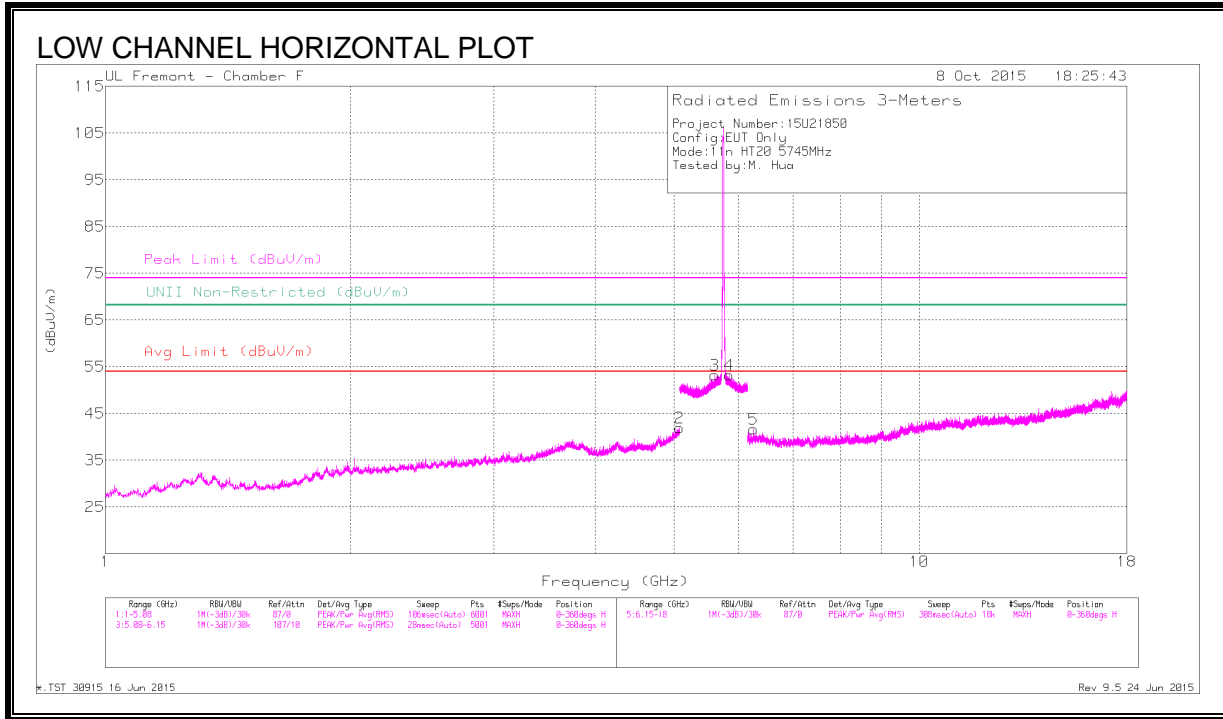

**DATA**

Marker	Frequency (GHz)	Meter Reading (dBuV)	Det	AF T120 (dB/m)	Amp/Cb/FI tr/Pad (dB)	DC Corr (dB)	Corrected Reading (dBuV/m)	Avg Limit (dBuV/m)	Margin (dB)	Peak Limit (dBuV/m)	PK Margin (dB)	UNII Non-Restricted (dBuV/m)	PK Margin (dB)	Azimuth (Degs)	Height (cm)	Polarity
1	* 3.831	39.45	PK-U	34	-28.8	0	44.65	-	-	74	-29.35	-	-	213	221	V
	* 3.830	27.51	ADR	34	-28.8	0	32.71	54	-21.29	-	-	-	-	213	221	V
2	* 5.074	40.82	PK-U	34.2	-26.3	0	48.72	-	-	74	-25.28	-	-	96	189	H
	* 5.074	29.05	ADR	34.2	-26.3	0	36.95	54	-17.05	-	-	-	-	96	189	H
3	5.610	40.8	PK-U	34.8	-18.7	0	56.90	-	-	-	-	68.2	-11.3	176	190	H
4	5.839	41.41	PK-U	35.1	-18.5	0	58.01	-	-	-	-	68.2	-10.19	142	181	H
5	6.257	38.44	PK-U	35.7	-26.8	0	47.34	-	-	-	-	68.2	-20.86	130	207	H
6	* 9.006	35.03	PK-U	36.1	-23.0	0	48.13	-	-	74	-25.87	-	-	116	281	V
	* 9.006	23.25	ADR	36.1	-23.0	0	36.35	54	-17.65	-	-	-	-	116	281	V

\* - indicates frequency in CFR15.205/IC8.10 Restricted Band

PK-U - U-NII: Maximum Peak

ADR - U-NII AD primary method, RMS average

\*.TST 30915 16 Jun 2015

Rev 9.5 24 Jun 2015



**MID CHANNEL HARMONICS AND SPURIOUS EMISSIONS**

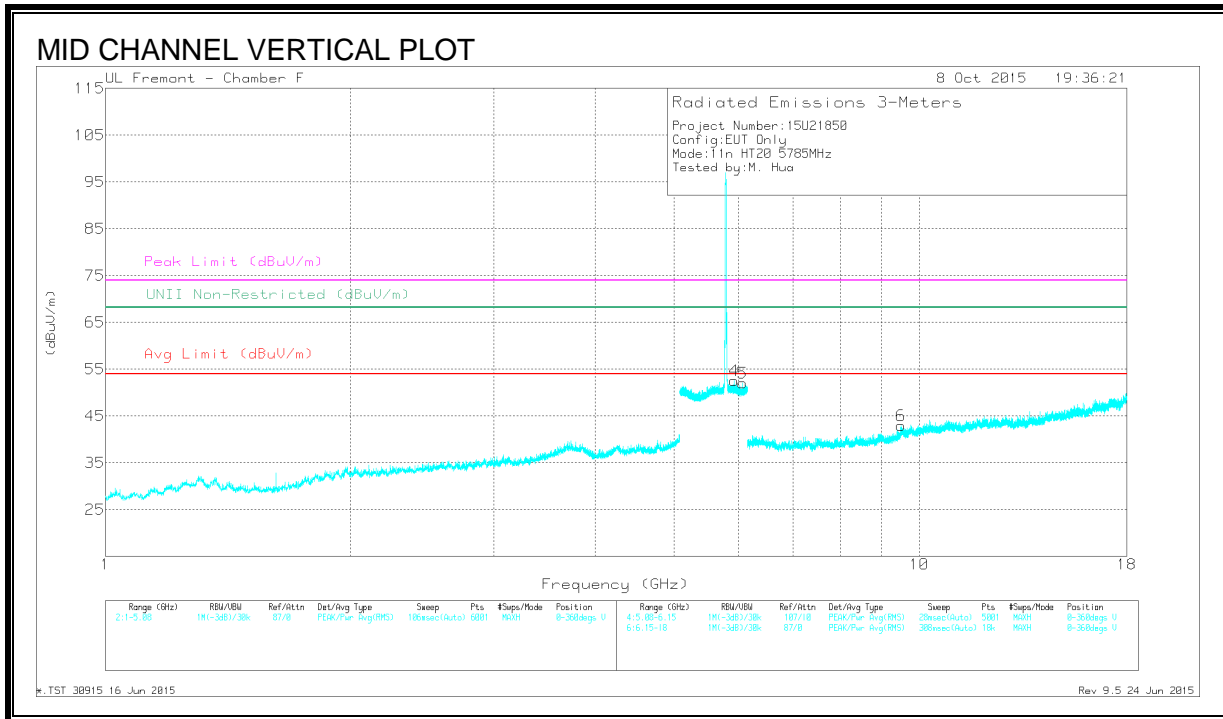
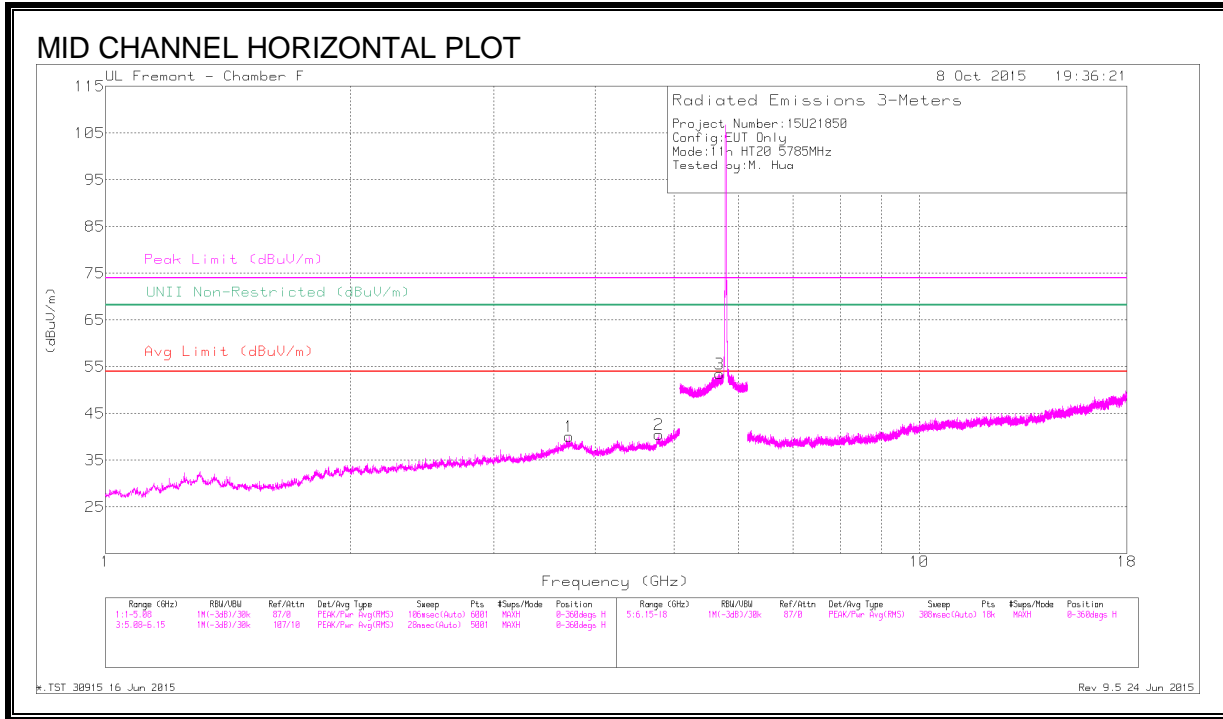

**DATA**

Marker	Frequency (GHz)	Meter Reading (dBuV)	Det	AF T120 (dB/m)	Amp/Cbl/FI tr/Pad (dB)	DC Corr (dB)	Corrected Reading (dBuV/m)	Avg Limit (dBuV/m)	Margin (dB)	Peak Limit (dBuV/m)	PK Margin (dB)	UNII Non-Restricted (dBuV/m)	PK Margin (dB)	Azimuth (Degs)	Height (cm)	Polarity
1	* 3.711	38.50	PK-U	34.6	-29.2	0	43.90	-	-	74	-30.1	-	-	61	139	H
	* 3.711	27.17	ADR	34.6	-29.2	0	32.57	54	-21.43	-	-	-	-	61	139	H
2	* 4.786	39.70	PK-U	34.1	-27.6	0	46.20	-	-	74	-27.8	-	-	136	178	H
	* 4.785	28.08	ADR	34.1	-27.6	0	34.58	54	-19.42	-	-	-	-	136	178	H
3	5.688	42.21	PK-U	34.8	-18.4	0	58.61	-	-	-	-	68.2	-9.59	169	178	H
4	5.924	38.50	PK-U	35.2	-18.7	0	55.00	-	-	-	-	68.2	-13.2	196	142	V
5	6.067	37.50	PK-U	35.5	-18.3	0	54.70	-	-	-	-	68.2	-13.5	303	380	V
6	* 9.495	34.54	PK-U	36.7	-22.1	0	49.14	-	-	74	-24.86	-	-	190	372	V
	* 9.495	22.68	ADR	36.7	-22.1	0	37.28	54	-16.72	-	-	-	-	190	372	V

\* - indicates frequency in CFR15.205/IC8.10 Restricted Band

PK-U - U-NII: Maximum Peak

ADR - U-NII AD primary method, RMS average

\*.TST 30915 16 Jun 2015

Rev 9.5 24 Jun 2015

**HIGH CHANNEL HARMONICS AND SPURIOUS EMISSIONS**

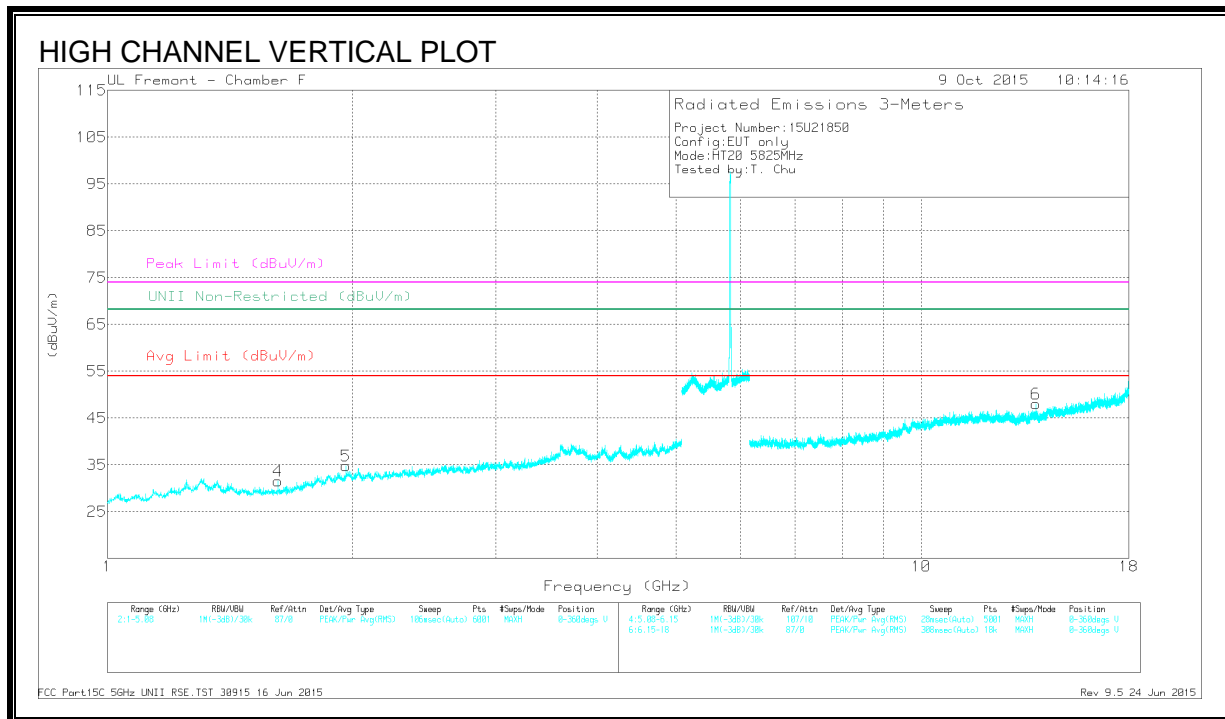
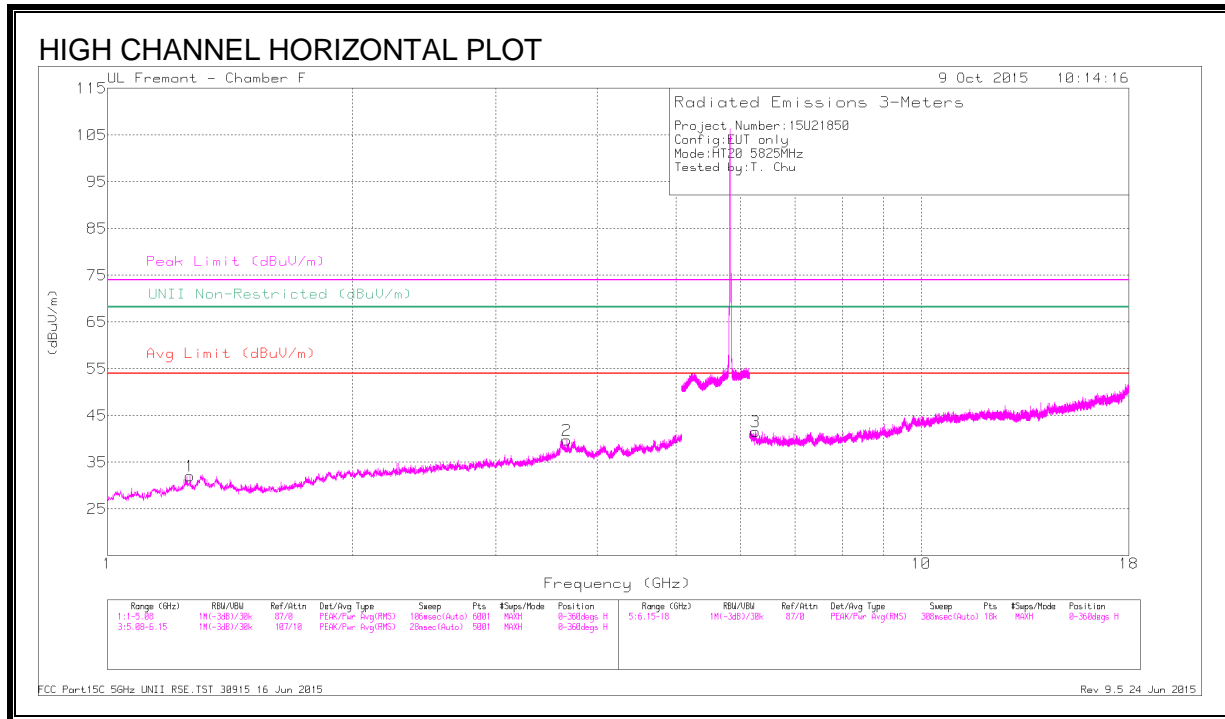

**DATA**

Marker	Frequency (GHz)	Meter Reading (dBuV)	Det	AF T120 (dB/m)	Amp/Cb/FI tr/Pad (dB)	DC Corr (dB)	Corrected Reading (dBuV/m)	Avg Limit (dBuV/m)	Margin (dB)	Peak Limit (dBuV/m)	PK Margin (dB)	UNII Non-Restricted (dBuV/m)	PK Margin (dB)	Azimuth (Degs)	Height (cm)	Polarity
1	* 1.265	40.7	PK-U	29.6	-31.9	0	38.40	-	-	74	-35.6	-	-	277	182	H
	* 1.263	28.65	ADR	29.6	-32	0	26.25	54	-27.75	-	-	-	-	277	182	H
2	* 3.668	40.37	PK-U	34.8	-29	0	46.17	-	-	74	-27.83	-	-	107	269	H
	* 3.669	28.61	ADR	34.8	-29	0	34.41	54	-19.59	-	-	-	-	107	269	H
3	6.262	42.01	PK-U	35.7	-26.8	0	50.91	-	-	-	-	68.2	-17.29	242	154	H
4	* 1.620	42.5	PK-U	28.3	-31.6	0	39.20	-	-	74	-34.8	-	-	254	144	V
	* 1.620	33.54	ADR	28.3	-31.6	0	30.24	54	-23.76	-	-	-	-	254	144	V
5	1.962	40.06	PK-U	31.4	-31.2	0	40.26	-	-	-	-	68.2	-27.94	10	395	V
6	13.843	37.34	PK-U	39	-23.5	0	52.84	-	-	-	-	68.2	-15.36	8	220	V

\* - indicates frequency in CFR15.205/IC8.10 Restricted Band

PK-U - U-NII: Maximum Peak

ADR - U-NII AD primary method, RMS average

FCC Part15C 5GHz UNII RSE.TST 30915 16 Jun 2015

Rev 9.5 24 Jun 2015

### 9.4. 802.11n HT40 MODE IN THE 5.8 GHz BAND

#### RESTRICTED BANDEDGE (LOW CHANNEL)

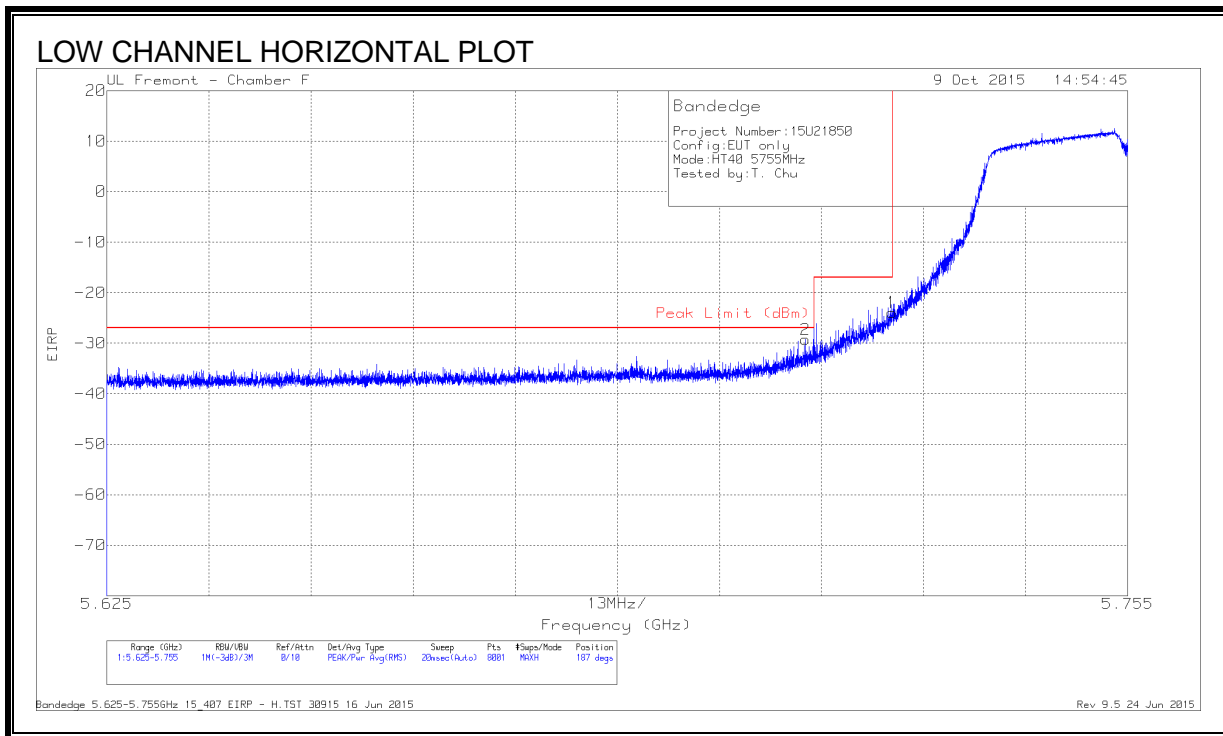

#### DATA

Marker	Frequency (GHz)	Meter Reading (dBm)	Det	AF T120 (dB/m)	Amp/Cbl/F ltr/Pad (dB)	Conversion Factor (dB)	DC Corr (dB)	Corrected Reading EIRP	Peak Limit (dBm)	PK Margin (dB)	Azimuth (Degs)	Height (cm)	Polarity
1	5.725	-52.2	Pk	34.9	-18.4	11.8	0	-23.9	-17	-6.9	187	171	H
2	5.714	-57.54	Pk	34.8	-18.3	11.8	0	-29.24	-27	-2.24	187	171	H

Pk - Peak detector

Bandedge 5.625-5.755GHz 15\_407 EIRP - H.TST 30915 16 Jun 2015

Rev 9.5 24 Jun 2015

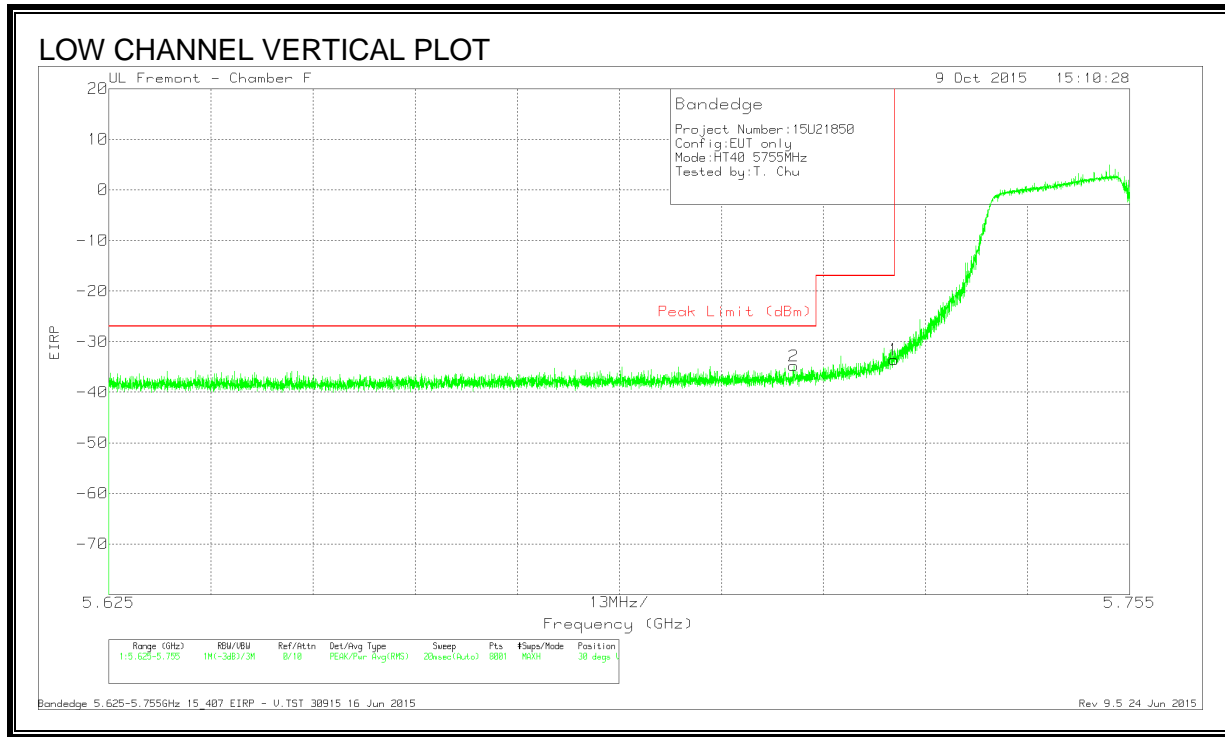

**DATA**

Marker	Frequency (GHz)	Meter Reading (dBm)	Det	AF T120 (dB/m)	Amp/Cbl/Filtr/Pad (dB)	Conversion Factor (dB)	DC Corr (dB)	Corrected Reading EIRP	Peak Limit (dBm)	PK Margin (dB)	Azimuth (Degs)	Height (cm)	Polarity
1	5.725	-61.86	Pk	34.9	-18.4	11.8	0	-33.56	-17	-16.56	30	169	V
2	5.712	-62.99	Pk	34.8	-18.4	11.8	0	-34.79	-27	-7.79	30	169	V

Pk - Peak detector

Bandedge 5.625-5.755GHz 15\_407 EIRP - V.TST 30915 16 Jun 2015

Rev 9.5 24 Jun 2015

**RESTRICTED BANDEDGE (HIGH CHANNEL)**

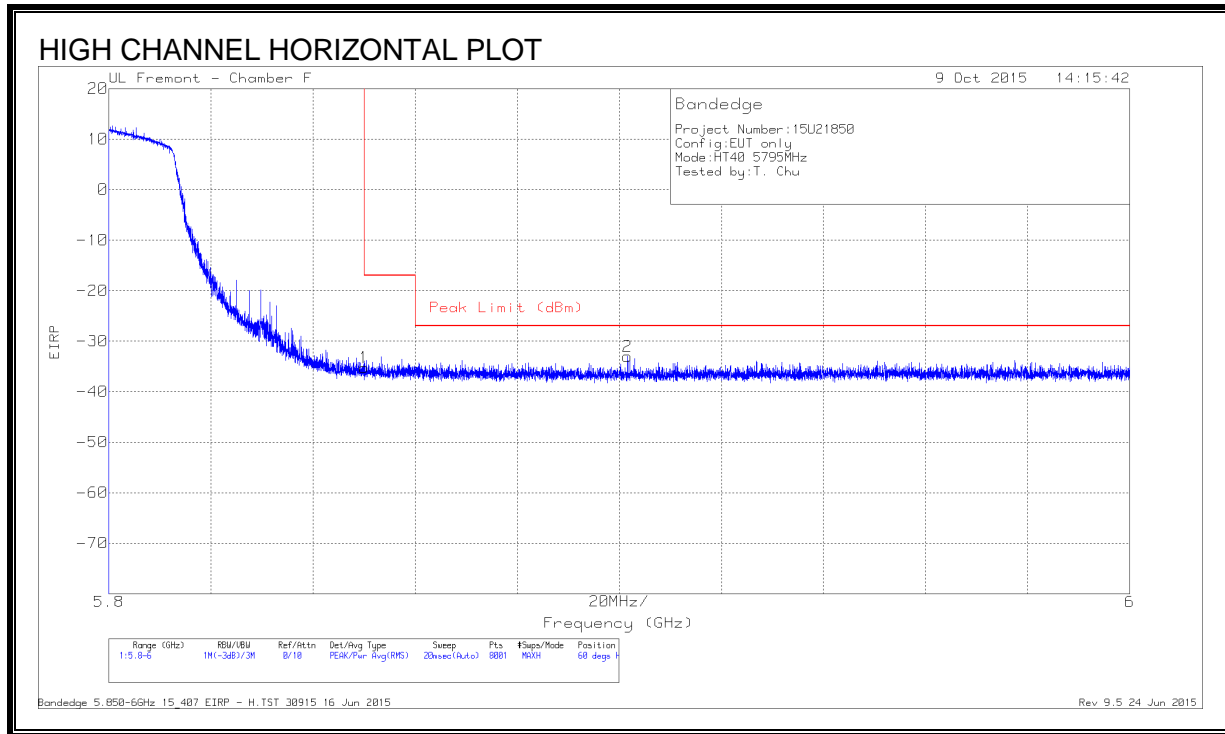

**DATA**

Marker	Frequency (GHz)	Meter Reading (dBm)	Det	AF T120 (dB/m)	Amp/Cbl/Filtr/Pad (dB)	Conversion Factor (dB)	DC Corr (dB)	Corrected Reading EIRP	Peak Limit (dBm)	PK Margin (dB)	Azimuth (Degs)	Height (cm)	Polarity
1	5.85	-63.53	Pk	35.1	-18.6	11.8	0	-35.23	-17	-18.23	60	177	H
2	5.902	-61.31	Pk	35.2	-18.7	11.8	0	-33.01	-27	-6.01	60	177	H

Pk - Peak detector

Bandedge 5.850-6GHz 15\_407 EIRP - H.TST 30915 16 Jun 2015

Rev 9.5 24 Jun 2015

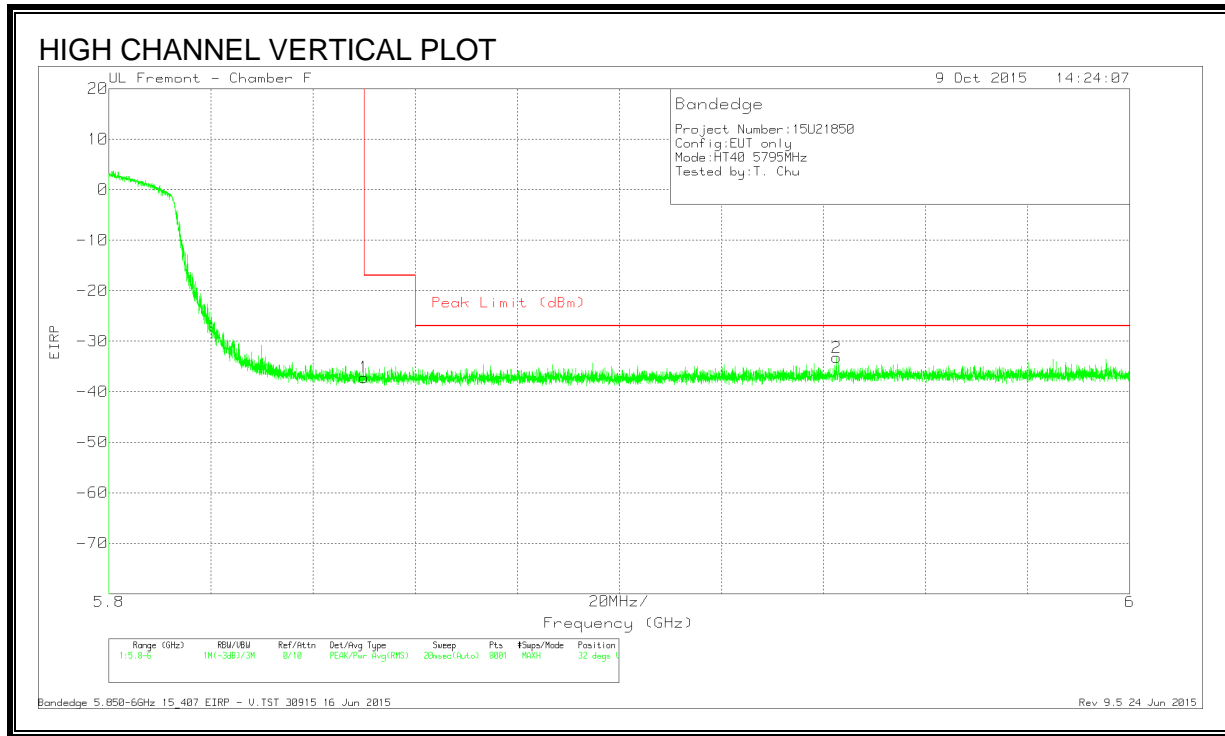

**DATA**

Marker	Frequency (GHz)	Meter Reading (dBm)	Det	AF T120 (dB/m)	Amp/Cb/F ltr/Pad (dB)	Conversion Factor (dB)	DC Corr (dB)	Corrected Reading EIRP	Peak Limit (dBm)	PK Margin (dB)	Azimuth (Degs)	Height (cm)	Polarity
1	5.850	-65.45	Pk	35.1	-18.6	11.8	0	-37.15	-17	-20.15	32	167	V
2	5.943	-61.64	Pk	35.3	-18.7	11.8	0	-33.24	-27	-6.24	32	167	V

Pk - Peak detector

Bandedge 5.850-6GHz 15\_407 EIRP - V.TST 30915 16 Jun 2015

Rev 9.5 24 Jun 2015



**LOW CHANNEL HARMONICS AND SPURIOUS EMISSIONS**

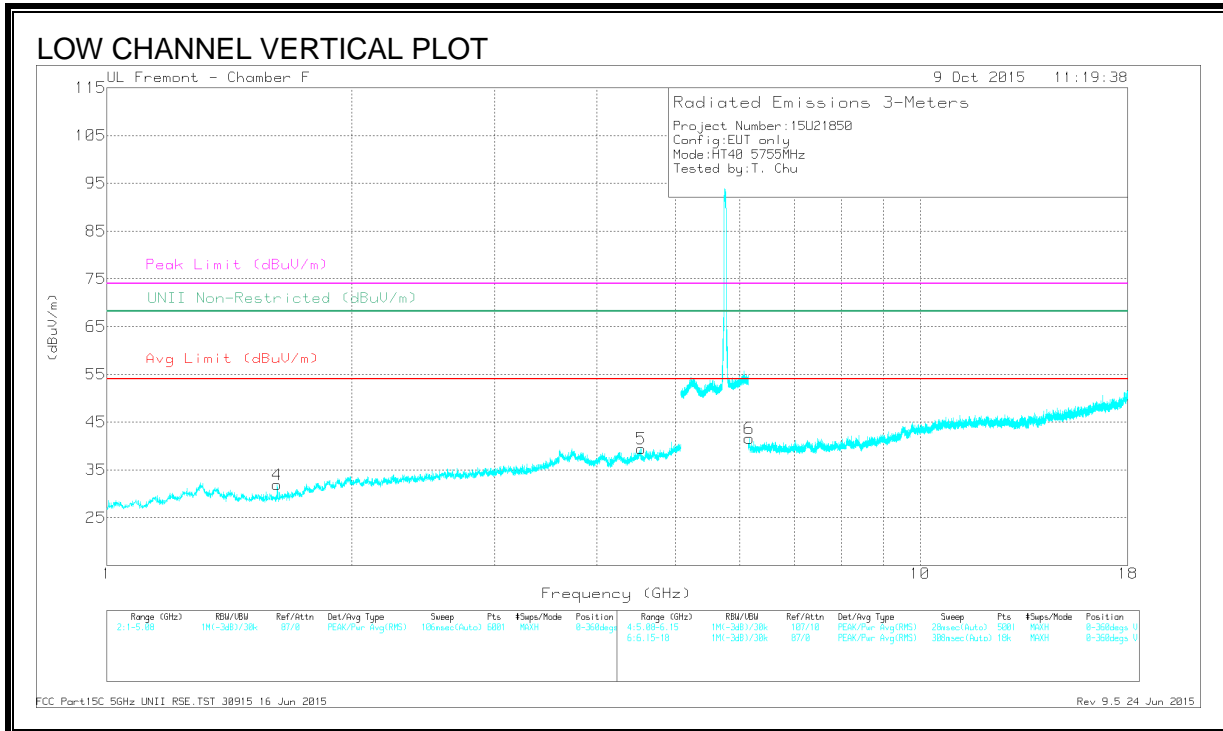
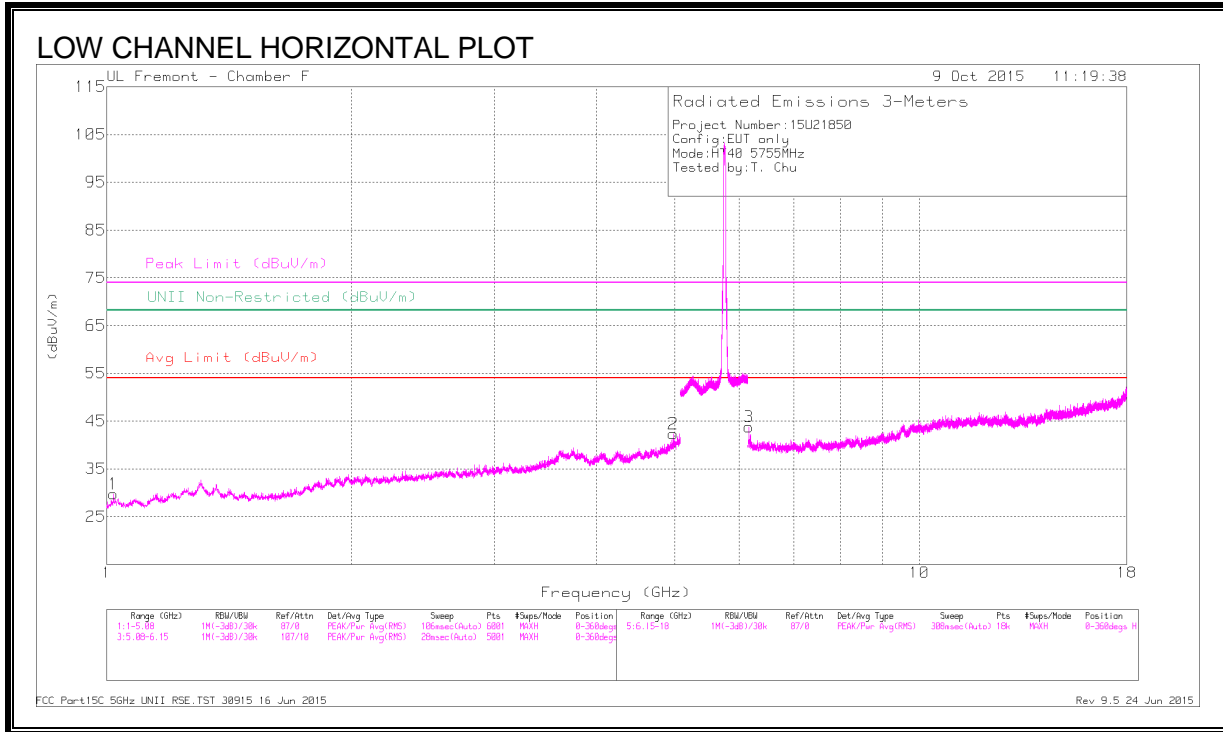

**DATA**

Marker	Frequency (GHz)	Meter Reading (dBuV)	Det	AF T120 (dB/m)	Amp/Cb/Fl tr/Pad (dB)	DC Corr (dB)	Corrected Reading (dBuV/m)	Avg Limit (dBuV/m)	Margin (dB)	Peak Limit (dBuV/m)	PK Margin (dB)	UNII Non-Restricted (dBuV/m)	PK Margin (dB)	Azimuth (Degs)	Height (cm)	Polarity
1	* 1.017	41.41	PK-U	27.3	-32.4	0	36.31	-	-	74	-37.69	-	-	205	169	H
	* 1.021	29.32	ADR	27.3	-32.4	0	24.22	54	-29.78	-	-	-	-	205	169	H
2	* 4.977	41.22	PK-U	34.1	-26.9	0	48.42	-	-	74	-25.58	-	-	209	242	H
	* 4.979	29.48	ADR	34.1	-26.9	0	36.68	54	-17.32	-	-	-	-	209	242	H
3	6.166	43.12	PK-U	35.7	-26.6	0	52.22	-	-	-	-	68.2	-15.98	252	169	H
4	* 1.620	42.7	PK-U	28.3	-31.6	0	39.4	-	-	74	-34.6	-	-	248	105	V
	* 1.620	33.6	ADR	28.3	-31.6	0	30.30	54	-23.7	-	-	-	-	248	105	V
5	* 4.538	40.06	PK-U	33.9	-28.1	0	45.86	-	-	74	-28.14	-	-	122	323	V
	* 4.538	28.63	ADR	33.9	-28.1	0	34.43	54	-19.57	-	-	-	-	122	323	V
6	6.165	41.75	PK-U	35.7	-26.6	0	50.85	-	-	-	-	68.2	-17.35	271	135	V

\* - indicates frequency in CFR15.205/IC8.10 Restricted Band

PK-U - U-NII: Maximum Peak

ADR - U-NII AD primary method, RMS average

FCC Part15C 5GHz UNII RSE.TST 30915 16 Jun 2015

Rev 9.5 24 Jun 2015

**HIGH CHANNEL HARMONICS AND SPURIOUS EMISSIONS**

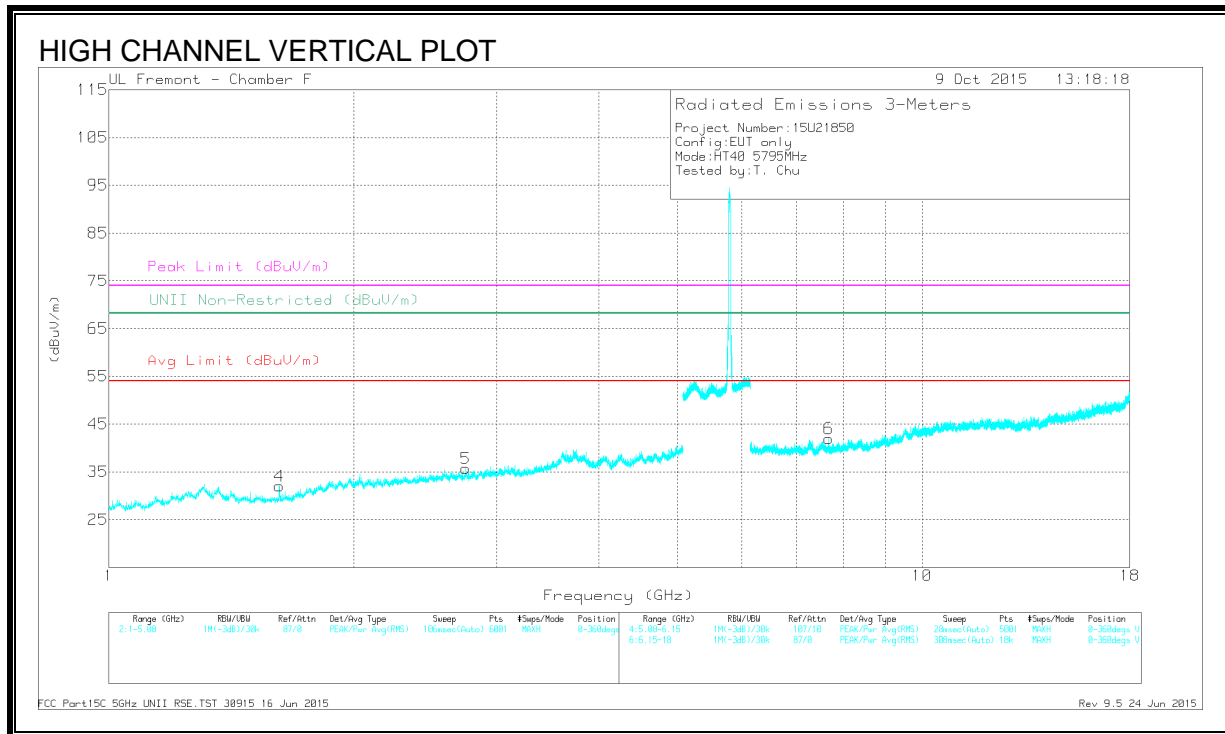
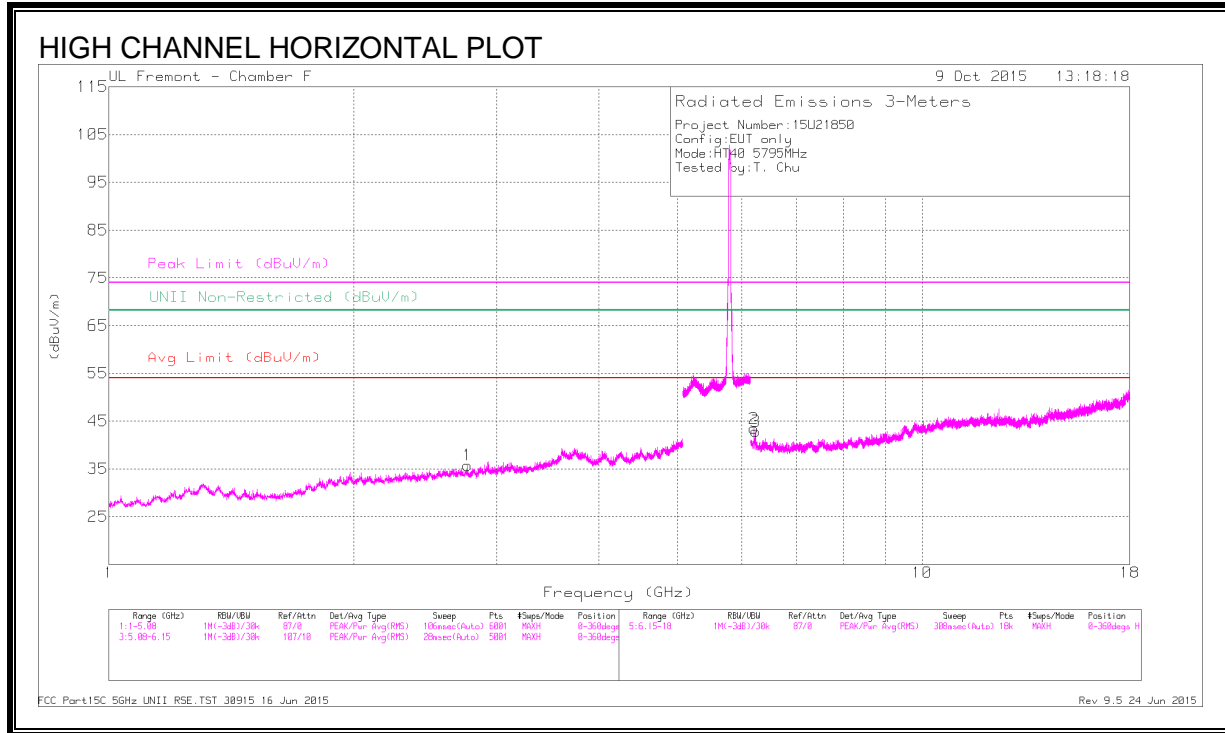

**DATA**

Marker	Frequency (GHz)	Meter Reading (dBuV)	Det	AF T120 (dB/m)	Amp/Cb/Fitr/ Pad (dB)	DC Corr (dB)	Corrected Reading (dBuV/m)	Avg Limit (dBuV/m)	Margin (dB)	Peak Limit (dBuV/m)	PK Margin (dB)	UNII Non-Restricted (dBuV/m)	PK Margin (dB)	Azimuth (Degs)	Height (cm)	Polarity
1	* 2.758	39.63	PK-U	32.7	-30.4	0	41.93	-	-	74	-32.07	-	-	173	133	H
	* 2.759	27.85	ADR	32.7	-30.4	0	30.15	54	-23.85	-	-	-	-	173	133	H
2	6.210	44.42	PK-U	35.7	-26.7	0	53.42	-	-	-	-	68.2	-14.78	78	146	H
	6.237	41.86	PK-U	35.7	-26.6	0	50.96	-	-	-	-	68.2	-17.24	35	169	H
4	* 1.620	42.38	PK-U	28.3	-31.6	0	39.08	-	-	74	-34.92	-	-	64	105	V
	* 1.620	33.16	ADR	28.3	-31.6	0	29.86	54	-24.14	-	-	-	-	64	105	V
5	* 2.747	40.27	PK-U	32.7	-30.5	0	42.47	-	-	74	-31.53	-	-	300	365	V
	* 2.744	27.99	ADR	32.7	-30.5	0	30.19	54	-23.81	-	-	-	-	300	365	V
6	* 7.674	36.68	PK-U	35.8	-25.5	0	46.98	-	-	74	-27.02	-	-	309	137	V
	* 7.675	25.59	ADR	35.8	-25.5	0	35.89	54	-18.11	-	-	-	-	309	137	V

\* - indicates frequency in CFR15.205/IC8.10 Restricted Band

PK-U - U-NII: Maximum Peak

ADR - U-NII AD primary method, RMS average

FCC Part15C 5GHz UNII RSE.TST 30915 16 Jun 2015

Rev 9.5 24 Jun 2015

**9.5. WORST-CASE BELOW 1 GHz**

**SPURIOUS EMISSIONS 30 TO 1000 MHz (WORST-CASE CONFIGURATION, HORIZONTAL & VERTICAL)**

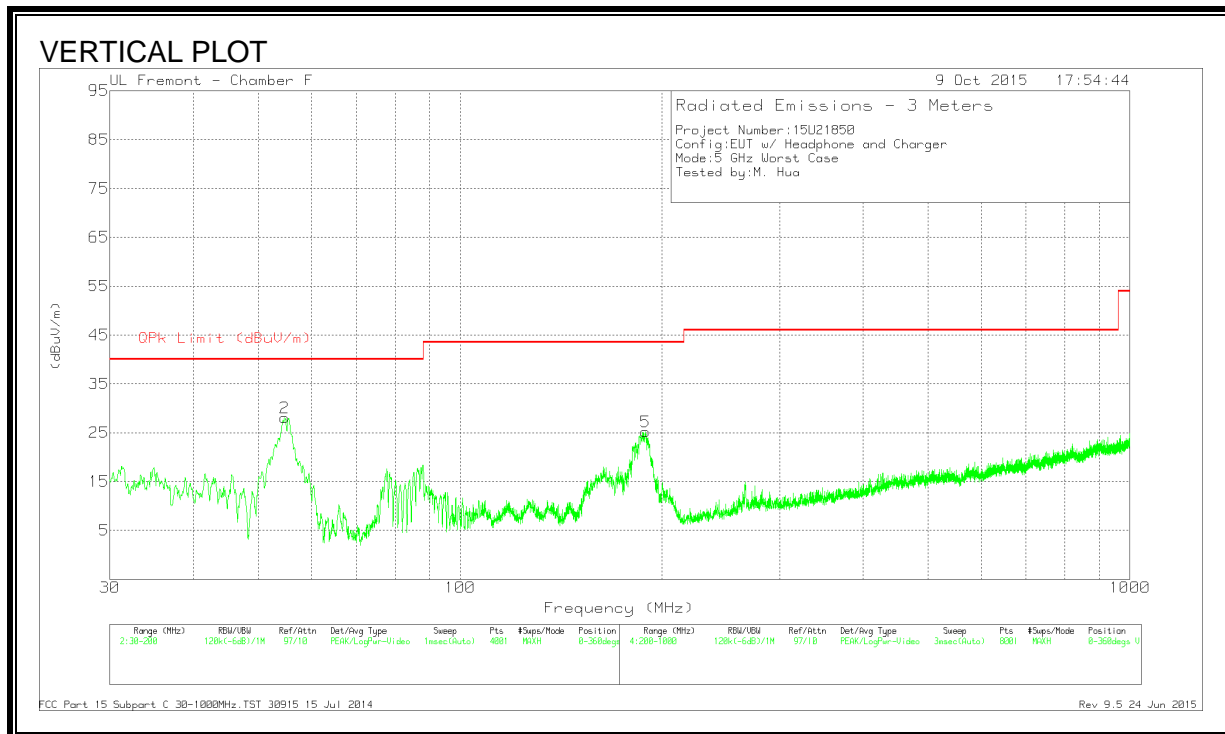
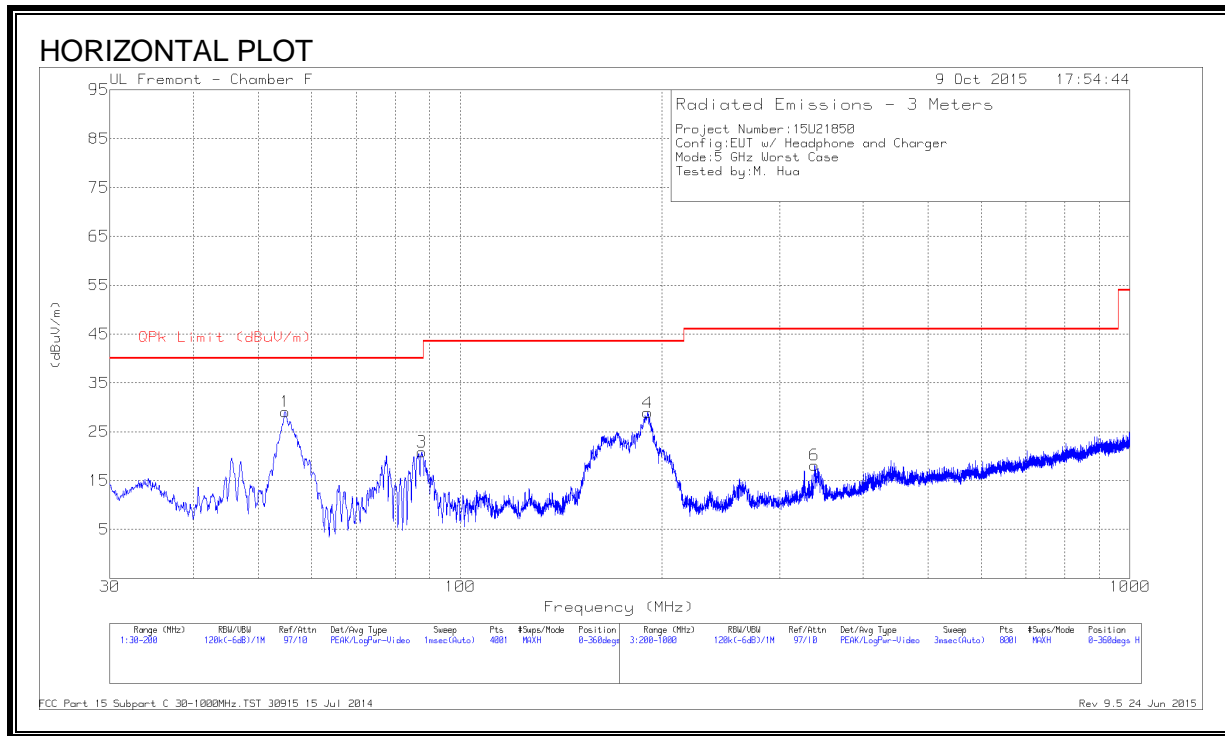

**HORIZONTAL AND VERTICAL DATA**

Marker	Frequency (MHz)	Meter Reading (dBuV)	Det	AF T122 (dB/m)	Amp/Cbl (dB)	DC Corr (dB)	Corrected Reading (dBuV/m)	QPk Limit (dBuV/m)	Margin (dB)	Azimuth (Degs)	Height (cm)	Polarity
1	54.7988	53.31	Pk	7.4	-31.6	0	29.11	40.00	-10.89	0-360	401	H
2	54.7138	52.26	Pk	7.4	-31.6	0	28.06	40.00	-11.94	0-360	100	V
3	87.6725	44.49	Pk	7.7	-31.3	0	20.89	40.00	-19.11	0-360	201	H
4	190.565	48.13	Pk	11.4	-30.6	0	28.93	43.52	-14.59	0-360	103	H
5	189.268	44.58	Pk	11.3	-30.7	0	25.18	43.52	-18.34	0-360	100	V
6	338.400	33.97	Pk	14.1	-29.9	0	18.17	46.02	-27.85	0-360	100	H

Pk - Peak detector

### 9.6. WORST-CASE ABOVE 18 GHz

#### SPURIOUS EMISSIONS 18000 TO 26000 MHz (WORST-CASE CONFIGURATION)

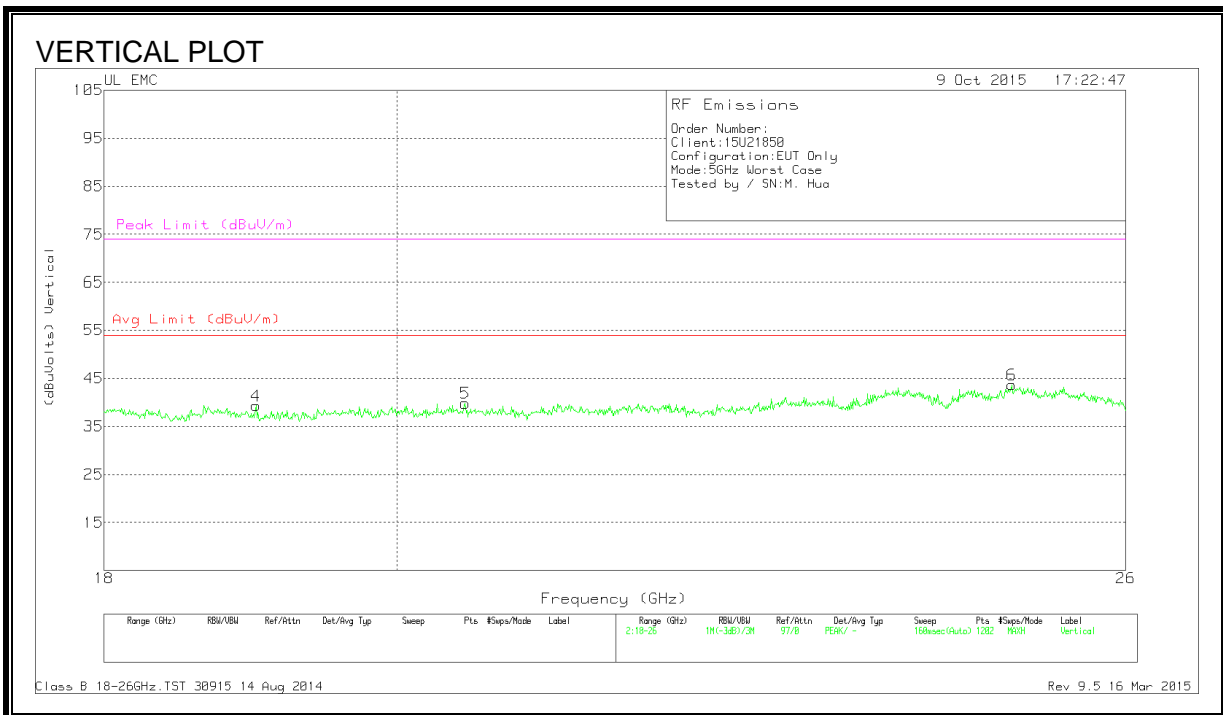
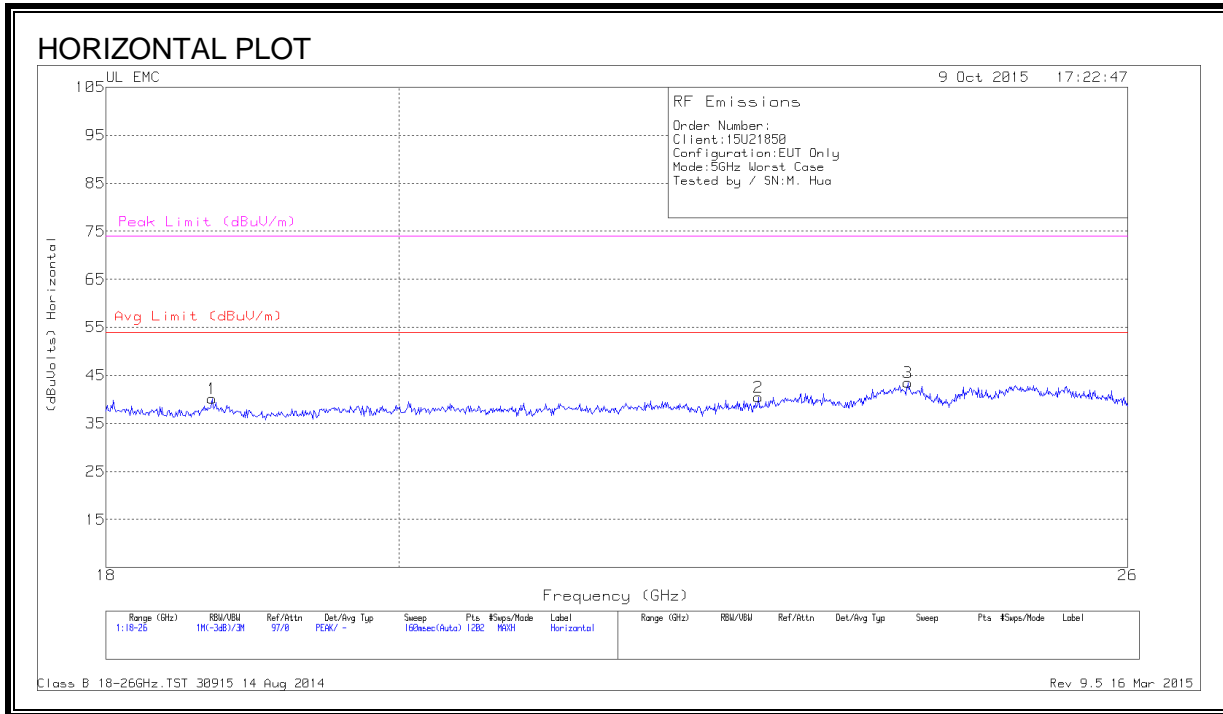

**HORIZONTAL AND VERTICAL DATA**

Marker	Frequency (GHz)	Meter Reading (dBuV)	Det	T89 AF (dB/m)	Amp/Cbl (dB)	Dist Corr (dB)	Corrected Reading (dBuVolts)	Avg Limit (dBuV/m)	Margin (dB)	Peak Limit (dBuV/m)	PK Margin (dB)
1	18.699	41.37	Pk	32.5	-24.2	-9.5	40.16	54	-13.83	74	-33.83
2	22.763	41.50	Pk	33.2	-24.7	-9.5	40.50	54	-13.50	74	-33.50
3	24.022	43.90	Pk	33.3	-24.2	-9.5	43.50	54	-10.50	74	-30.50
4	19.012	41.33	Pk	32.2	-24.7	-9.5	39.33	54	-14.66	74	-34.66
5	20.498	41.73	Pk	32.7	-25.1	-9.5	39.83	54	-14.16	74	-34.16
6	24.954	43.47	Pk	34.1	-24.4	-9.5	43.66	54	-10.33	74	-30.33

Pk - Peak detector



**SPURIOUS EMISSIONS 26000 TO 40000 MHz (WORST-CASE CONFIGURATION)**

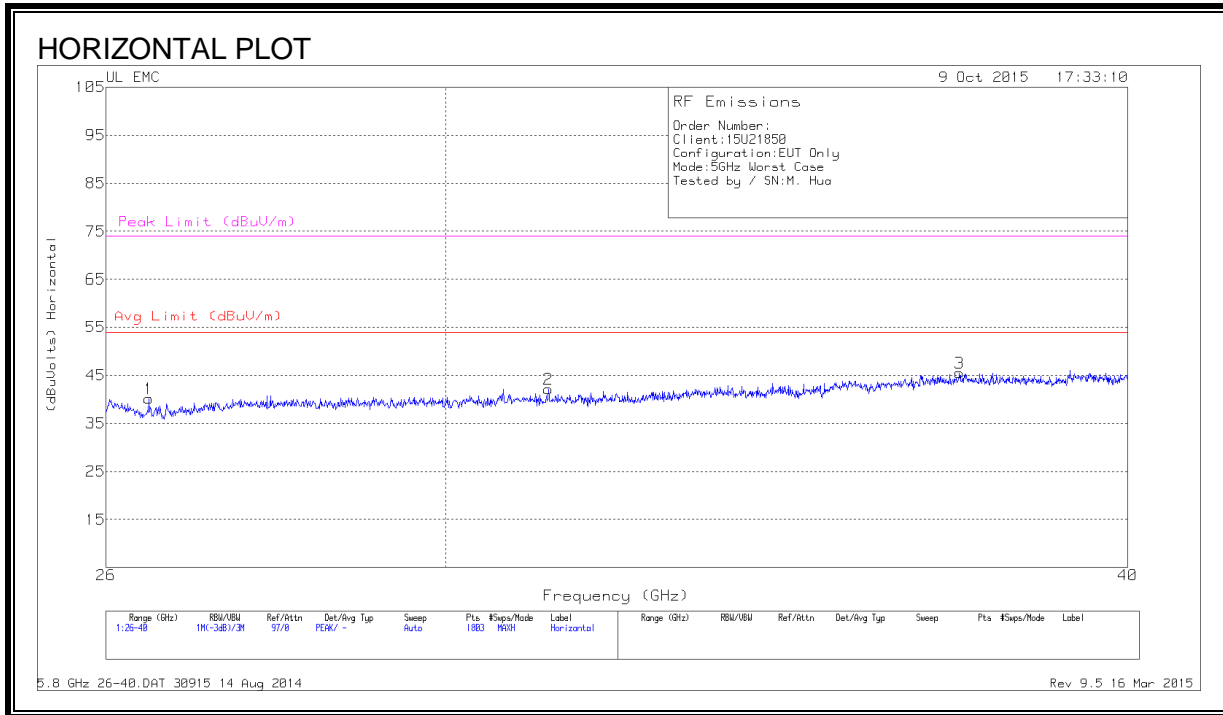

**HORIZONTAL AND VERTICAL DATA**

Marker	Frequency (GHz)	Meter Reading (dBuV)	Det	T90 AF (dB/m)	Amp/Cbl (dB)	Dist Corr (dB)	Corrected Reading (dBuVolts)	Avg Limit (dBuV/m)	Margin (dB)	Peak Limit (dBuV/m)	PK Margin (dB)
1	26.474	44.67	Pk	35.5	-30.5	-9.5	40.16	54	-13.83	74	-33.83
2	31.330	48.37	Pk	36.1	-32.8	-9.5	42.16	54	-11.83	74	-31.83
3	37.257	50.60	Pk	37.3	-32.9	-9.5	45.50	54	-8.50	74	-28.50
4	27.608	45.70	Pk	35.8	-31.5	-9.5	40.50	54	-13.50	74	-33.50
5	31.594	47.80	Pk	36.3	-33.1	-9.5	41.50	54	-12.50	74	-32.50
6	38.143	50.30	Pk	37.2	-32.5	-9.5	45.50	54	-8.50	74	-28.50

Pk - Peak detector

## 10. AC POWER LINE CONDUCTED EMISSIONS

### LIMITS

FCC §15.207 (a)

Frequency of Emission (MHz)	Conducted Limit (dBµV)	
	Quasi-peak	Average
0.15-0.5	66 to 56 *	56 to 46 *
0.5-5	56	46
5-30	60	50

\*Decreases with the logarithm of the frequency.

### TEST PROCEDURE

The EUT is placed on a non-conducting table 40 cm from the vertical ground plane and 80 cm above the horizontal ground plane. The EUT is configured in accordance with ANSI C63.10.

The receiver is set to a resolution bandwidth of 9 kHz. Peak detection is used unless otherwise noted as quasi-peak or average.

Line conducted data is recorded for both NEUTRAL and HOT lines.

### RESULTS

## 10.1. EUT POWERED BY AC ADAPTER

### LINE 1 RESULTS

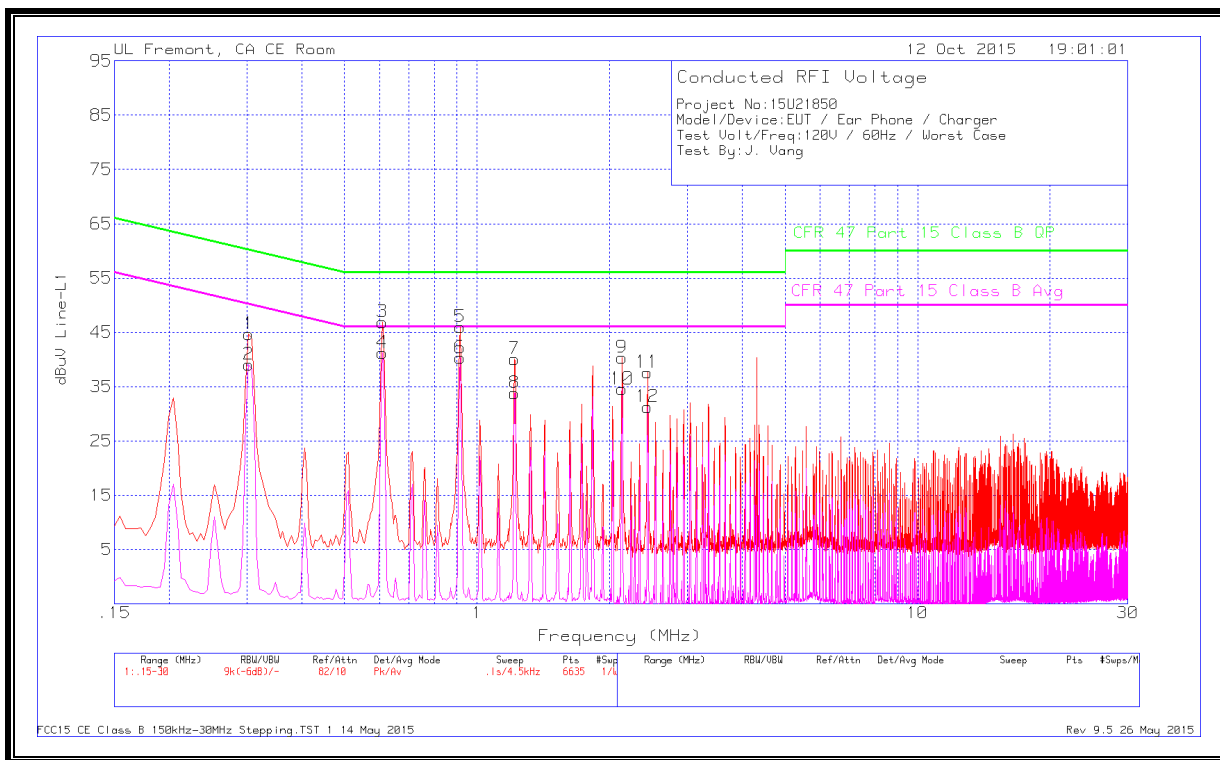

### WORST EMISSIONS

Marker	Frequency (MHz)	Meter Reading (dBuV)	Det	T24 IL L1	LC Cables 1&3	Corrected Reading dBuV	CFR 47 Part 15 Class B QP	Margin (dB)	CFR 47 Part 15 Class B Avg	Margin (dB)
1	.303	44.18	Pk	.5	0	44.68	60.16	-15.48	-	-
2	.303	38.56	Av	.5	0	39.06	-	-	50.16	-11.1
3	.609	46.6	Pk	.3	0	46.9	56	-9.1	-	-
4	.609	40.9	Av	.3	0	41.2	-	-	46	-4.8
5	.915	45.65	Pk	.3	0	45.95	56	-10.05	-	-
6	.915	40.01	Av	.3	0	40.31	-	-	46	-5.69
7	1.2165	39.81	Pk	.2	.1	40.11	56	-15.89	-	-
8	1.2165	33.53	Av	.2	.1	33.83	-	-	46	-12.17
9	2.1345	40.03	Pk	.2	.1	40.33	56	-15.67	-	-
10	2.1345	34.25	Av	.2	.1	34.55	-	-	46	-11.45
11	2.436	37.3	Pk	.2	.1	37.6	56	-18.4	-	-
12	2.436	30.98	Av	.2	.1	31.28	-	-	46	-14.72

Pk - Peak detector  
 Av - Average detection

**LINE 2 RESULTS**

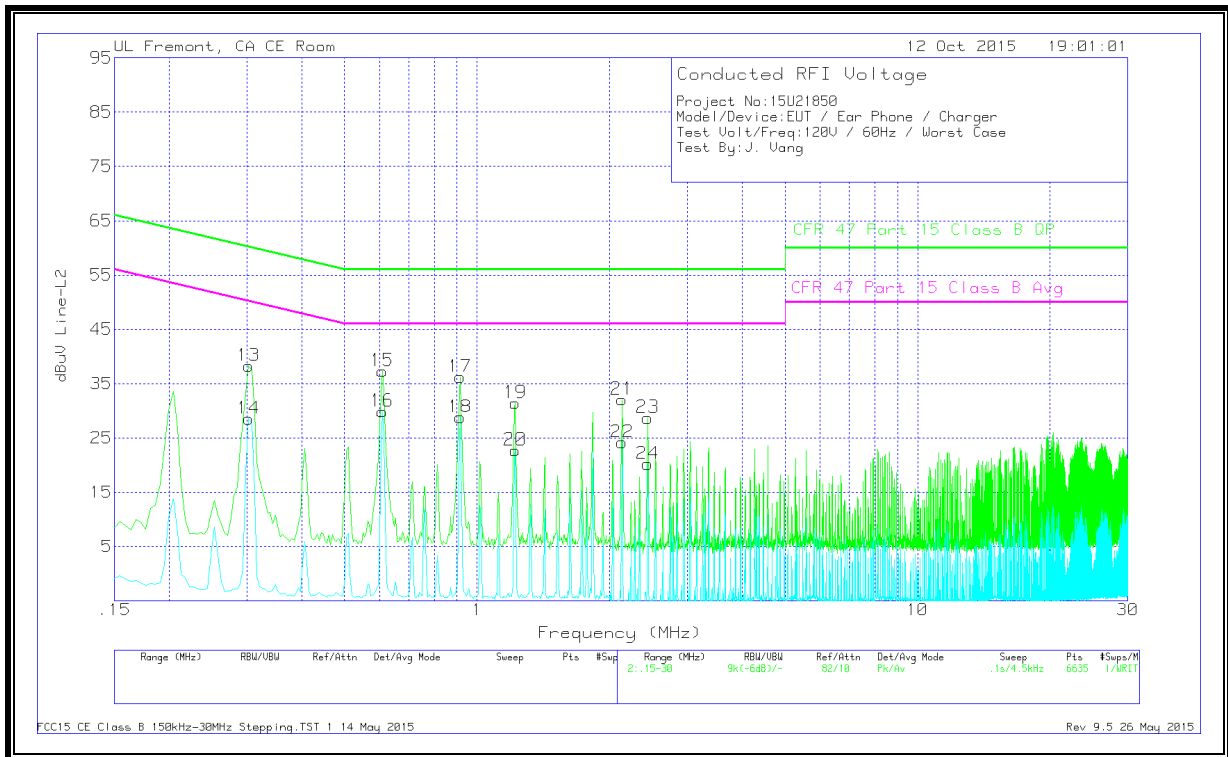

**WORST EMISSIONS**

Marker	Frequency (MHz)	Meter Reading (dBuV)	Det	T24 IL L2	LC Cables 2&3	Corrected Reading dBuV	CFR 47 Part 15 Class B QP	Margin (dB)	CFR 47 Part 15 Class B Avg	Margin (dB)
13	.303	37.7	Pk	.6	0	38.3	60.16	-21.86	-	-
14	.303	27.94	Av	.6	0	28.54	-	-	50.16	-21.62
15	.609	37.02	Pk	.3	0	37.32	56	-18.68	-	-
16	.609	29.59	Av	.3	0	29.89	-	-	46	-16.11
17	.915	35.96	Pk	.3	0	36.26	56	-19.74	-	-
18	.915	28.52	Av	.3	0	28.82	-	-	46	-17.18
19	1.221	31.15	Pk	.2	.1	31.45	56	-24.55	-	-
20	1.221	22.42	Av	.2	.1	22.72	-	-	46	-23.28
21	2.1345	31.79	Pk	.2	.1	32.09	56	-23.91	-	-
22	2.1345	23.88	Av	.2	.1	24.18	-	-	46	-21.82
23	2.4405	28.43	Pk	.2	.1	28.73	56	-27.27	-	-
24	2.4405	19.92	Av	.2	.1	20.22	-	-	46	-25.78

Pk - Peak detector  
 Av - Average detection

## 10.2. EUT POWERED BY HOST PC VIA USB CABLE

### LINE 1 RESULTS

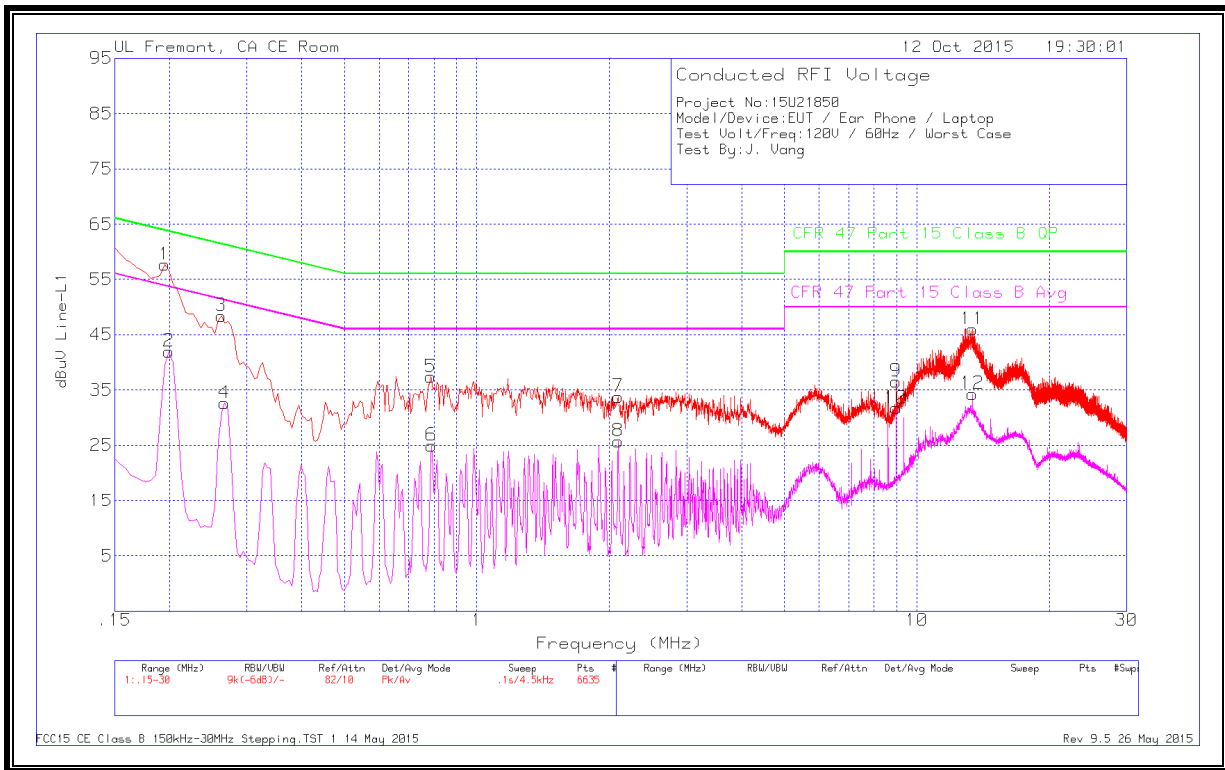

### WORST EMISSIONS

Marker	Frequency (MHz)	Meter Reading (dBuV)	Det	T24 IL L1	LC Cables 1&3	Corrected Reading dBuV	CFR 47 Part 15 Class B QP	Margin (dB)	CFR 47 Part 15 Class B Avg	Margin (dB)
1	.195	56.65	Pk	1	0	57.65	63.82	-6.17	-	-
2	.1995	41.07	Av	.9	0	41.97	-	-	53.63	-11.66
3	.2625	47.71	Pk	.7	0	48.41	61.35	-12.94	-	-
4	.267	32	Av	.6	0	32.6	-	-	51.21	-18.61
5	.7845	37.06	Pk	.3	0	37.36	56	-18.64	-	-
6	.789	24.66	Av	.3	0	24.96	-	-	46	-21.04
7	2.094	33.5	Pk	.2	.1	33.8	56	-22.2	-	-
8	2.094	25.41	Av	.2	.1	25.71	-	-	46	-20.29
9	8.9745	36.28	Pk	.2	.1	36.58	60	-23.42	-	-
10	8.9745	31.39	Av	.2	.1	31.69	-	-	50	-18.31
11	13.3935	45.55	Pk	.2	.2	45.95	60	-14.05	-	-
12	13.3935	33.87	Av	.2	.2	34.27	-	-	50	-15.73

Pk - Peak detector  
 Av - Average detection

**LINE 2 RESULTS**

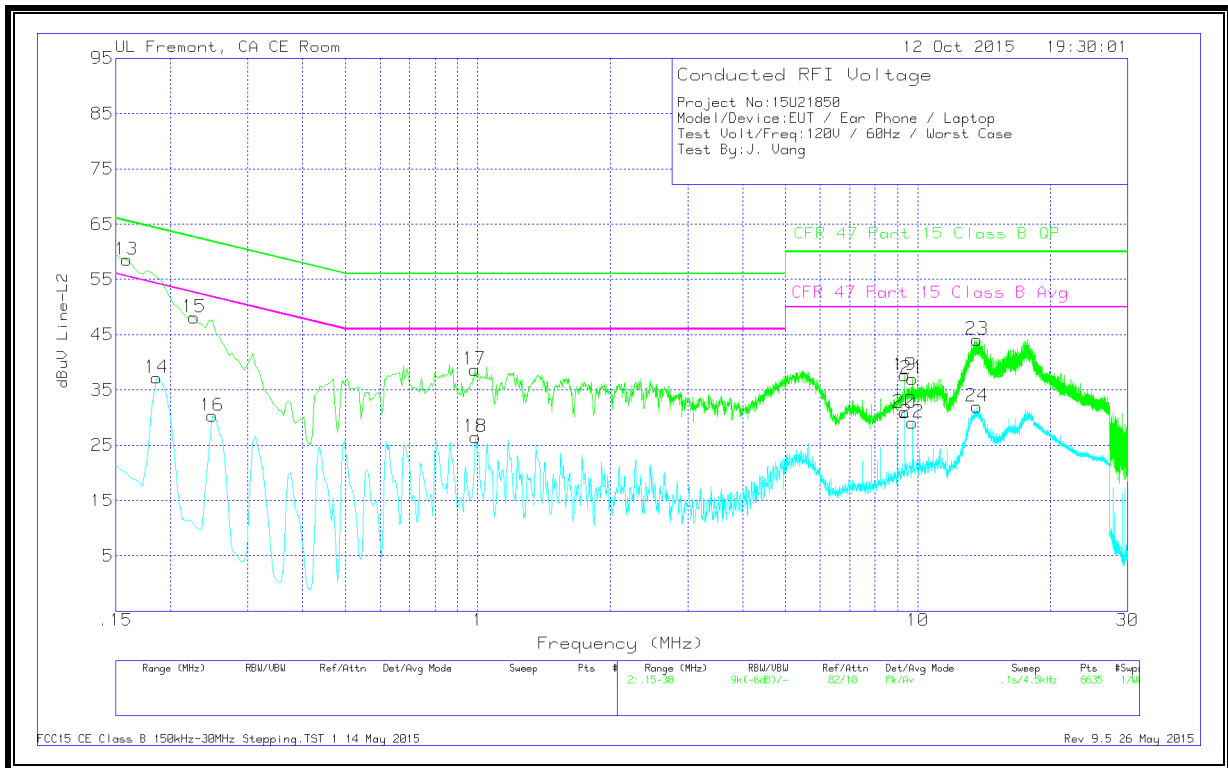

**WORST EMISSIONS**

Marker	Frequency (MHz)	Meter Reading (dBuV)	Det	T24 IL L2	LC Cables 2&3	Corrected Reading dBuV	CFR 47 Part 15 Class B QP	Margin (dB)	CFR 47 Part 15 Class B Avg	Margin (dB)
13	.159	57.13	Pk	1.4	0	58.53	65.52	-6.99	-	-
14	.186	36.12	Av	1.1	0	37.22	-	-	54.21	-16.99
15	.2265	47.26	Pk	.9	0	48.16	62.58	-14.42	-	-
16	.249	29.62	Av	.7	0	30.32	-	-	51.79	-21.47
17	.9825	38.29	Pk	.3	.1	38.69	56	-17.31	-	-
18	.987	26.16	Av	.3	0	26.46	-	-	46	-19.54
19	9.3435	37.34	Pk	.2	.1	37.64	60	-22.36	-	-
20	9.3435	30.64	Av	.2	.1	30.94	-	-	50	-19.06
21	9.717	36.62	Pk	.2	.2	37.02	60	-22.98	-	-
22	9.717	28.73	Av	.2	.2	29.13	-	-	50	-20.87
23	13.6455	43.68	Pk	.2	.2	44.08	60	-15.92	-	-
24	13.6455	31.6	Av	.2	.2	32	-	-	50	-18

Pk - Peak detector  
 Av - Average detection