



**FCC OET BULLETIN 65 SUPPLEMENT C 01-01
IEEE STD 1528:2003**

SAR EVALUATION REPORT

For

The Apple iPad, Model A1397 is a tablet device with iPod functions (music, application support, and video), 802.11a/b/g/n radio, Bluetooth radio functions, and cellular using the CDMA data radio functions

**MODEL: A1397
FCC ID: BCGA1397**

REPORT NUMBER: 10U13600-1B

ISSUE DATE: March 1, 2011

Prepared for

**APPLE INC.
1 INFINITE LOOP, MS 26A
CUPERTINO, CA 95014-2084**

Prepared by

**COMPLIANCE CERTIFICATION SERVICES (UL CCS)
47173 BENICIA STREET
FREMONT, CA 94538, U.S.A.
TEL: (510) 771-1000
FAX: (510) 661-0888**



NVLAP LAB CODE 200065-0

Revision History

<u>Rev.</u>	<u>Issue Date</u>	<u>Revisions</u>	<u>Revised By</u>
--	February 20, 2011	Initial Issue	--
A	February 27, 2011	Revised based upon KDB comments	Sunny Shih
B	March 1, 2011	Updated report per reviewer's comments, including <ol style="list-style-type: none">1. Page 39:<ul style="list-style-type: none">• Removed sections 11.1 and 11.2• Changed text to "FCC pre-TCB testing guidance KDB 335737"2. Pages 41:<ul style="list-style-type: none">• Added Summary table of supplemental results from Cetecom SAR test report.• Removed ambiguous plots and added section 11.4 - Summary Table of Power Reduction dB Levels per Mode and Band.3. Page 66: Corrected typo, changed from "SA" to "SAR".	Sunny Shih

TABLE OF CONTENTS

1. ATTESTATION OF TEST RESULTS	5
2. TEST METHODOLOGY	6
3. FACILITIES AND ACCREDITATION	6
4. CALIBRATION AND UNCERTAINTY	7
4.1. <i>MEASURING INSTRUMENT CALIBRATION</i>	7
4.2. <i>MEASUREMENT UNCERTAINTY</i>	8
5. EQUIPMENT UNDER TEST	9
6. SYSTEM SPECIFICATIONS	10
7. COMPOSITION OF INGREDIENTS FOR TISSUE SIMULATING LIQUIDS	11
8. LIQUID PARAMETERS	12
8.1. <i>LIQUID CHECK RESULTS</i>	13
9. SYSTEM VERIFICATION	19
9.1. <i>SYSTEM CHECK RESULTS</i>	20
10. SAR MEASUREMENT PROCEDURES	39
11. POWER REDUCTION BY SENSING	40
11.1. <i>iPad WIFI Exclusions for SAR Testing</i>	40
11.2. <i>Additional SAR Testing for the Back Surface and Top Edge</i>	40
11.3. <i>Method of SAR Measurement With and Without Back-off Enabled</i>	40
11.4. <i>Summary Table of Power Reduction dB Levels per Mode and Band</i>	41
12. RF OUTPUT POWER VERIFICATION	42
12.1. <i>WWAN</i>	42
12.2. <i>WiFi</i>	45
13. SUMMARY OF SAR TEST RESULTS	47
13.1. <i>WWAN (CDMA2000)</i>	47
13.2. <i>2.4 GHz BAND</i>	53
13.3. <i>5 GHz BANDS</i>	56
14. KDB 447498 SIMULTANEOUS TRANSMISSION SAR EVALUATIONS	65
15. ATTACHMENTS	67
16. ANTENNAS LOCATIONS AND SEPARATION DISTANCES	68
17. WWAN TEST SETUP PHOTOS	69

18. WiFi TEST SETUP PHOTOS	74
19. EXTERNAL PHOTOS.....	77

1. ATTESTATION OF TEST RESULTS

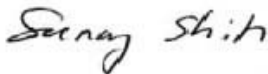
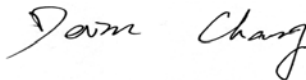
Tested for:	APPLE INC. 1 INFINITE LOOP, MS 26A CUPERTINO, CA 95014-2084		
EUT description:	The Apple iPad, Model A1397 is a tablet device with iPod functions (music, application support, and video), 802.11a/b/g/n radio, Bluetooth radio functions, and cellular using the CDMA data radio functions.		
Model number:	A1397, S/N: DLXDV001DK65 (WiFi), DLXDV00MDK61(CDMA2000)		
Device category:	Portable		
Exposure category:	General Population/Uncontrolled Exposure		
Date tested:	January 10 - 17, 2011 (WiFi); January 25- 26, 2011 (CDMA2000)		
FCC Rule Parts	Freq. Range [MHz]	Highest 1-g SAR (mW/g)	Limit (mW/g)
22H	824 - 849	1.140 (Back Surface)	1.6
	With Special Development Software to disable power back-off	0.565 (Back Surface with 10mm distance)	
24E	1850 - 1910	1.150 (Back Surface)	
	With Special Development Software to disable power back-off	1.4 (Secondary Portrait /Top Edge with 9.5 mm distance)	
15.247	2412 – 2462	1.050 (Primary Portrait)	
15.407	5150 – 5250	0.787 (Primary Portrait)	
	5250 – 5350	0.852 (Primary Portrait)	
	5500 – 5700	0.816 (Primary Portrait)	
15.247	5725 – 5850	0.647 (Primary Portrait)	
Applicable Standards			
FCC OET Bulletin 65 Supplement C 01-01, IEEE STD 1528: 2003 IC RSS 102 Issue 4			Pass
<p>Compliance Certification Services, Inc. (UL CCS) tested the above equipment in accordance with the requirements set forth in the above standards. All indications of Pass/Fail in this report are opinions expressed by UL CCS based on interpretations and/or observations of test results. Measurement Uncertainties were not taken into account and are published for informational purposes only. The test results show that the equipment tested is capable of demonstrating compliance with the requirements as documented in this report.</p> <p>Note: The results documented in this report apply only to the tested sample, under the conditions and modes of operation as described herein. This document may not be altered or revised in any way unless done so by UL CCS and all revisions are duly noted in the revisions section. Any alteration of this document not carried out by UL CCS will constitute fraud and shall nullify the document. This report must not be used by the client to claim product certification, approval, or endorsement by NVLAP, NIST, any agency of the Federal Government, or any agency of any government (NIST Handbook 150, Annex A). This report is written to support regulatory compliance of the applicable standards stated above.</p>			
Approved & Released For UL CCS By:		Tested By:	
			
Sunny Shih Engineering Team Leader Compliance Certification Services (UL CCS)		Devin Chang EMC Engineer Compliance Certification Services (UL CCS)	

2. TEST METHODOLOGY

The tests documented in this report were performed in accordance with FCC OET Bulletin 65 Supplement C 01-01, IEEE STD 1528: 2003, IC RSS 102 Issue 4 and the following specific FCC Test Procedures.

- KDB 248227 D01 SAR Measurement Procedure for 802 11abg v01r02
- KDB 941225 D01 SAR test for 3G devices v02
- KDB 447498 D01 Mobile Portable RF Exposure v04
- KDB 616217 D03 SAR Supp Note and Netbook Laptop v01
- Power Reduction by Sensing (Oct. 2010 TCBC Workshop SAR Updates)

3. FACILITIES AND ACCREDITATION

The test sites and measurement facilities used to collect data are located at 47173 Benicia Street, Fremont, California, USA.

UL CCS is accredited by NVLAP, Laboratory Code 200065-0. The full scope of accreditation can be viewed at <http://www.ccsemc.com>.

4. CALIBRATION AND UNCERTAINTY

4.1. MEASURING INSTRUMENT CALIBRATION

The measuring equipment utilized to perform the tests documented in this report has been calibrated in accordance with the manufacturer's recommendations, and is traceable to recognized national standards.

Name of Equipment	Manufacturer	Type/Model	Serial No.	Cal. Due date		
				MM	DD	Year
Robot - Six Axes	Stäubli	RX90BL	N/A	N/A		
Robot Remote Control	Stäubli	CS7MB	3403-91535	N/A		
DASY4 Measurement Server	SPEAG	SEUMS001BA	1041	N/A		
Data Acquisition Electronics	SPEAG	DAE4	1239	11	11	2011
Data Acquisition Electronics	SPEAG	DAE3	427	7	21	2011
Probe Alignment Unit	SPEAG	LB (V2)	261	N/A		
SAM Phantom (SAM1)	SPEAG	QD000P40CA	1185	N/A		
SAM Phantom (SAM2)	SPEAG	QD000P40CA	1050	N/A		
Oval Flat Phantom (ELI 4.0)	SPEAG	QD OVA001 B	1003	N/A		
Dielectric Probe kit	HP	85070C	N/A	N/A		
ESA Series Network Analyzer	Agilent	E5071B	MY42100131	8	2	2011
Synthesized Signal Generator	HP	83732B	US34490599	7	14	2012
Wireless communication test set	Agilent	E5515C (8960)	GB46160222	6	17	2012
E-Field Probe	SPEAG	EX3DV3	3686	1	24	2012
E-Field Probe	SPEAG	EX3DV4	3749	11	13	2011
Thermometer	ERTCO	639-1S	1718	7	19	2011
System Validation Dipole	SPEAG	* D835V2	4d002	4	22	2011
System Validation Dipole	SPEAG	* D900V2	108	11	23	2011
System Validation Dipole	SPEAG	D1800V2	294	11	24	2011
System Validation Dipole	SPEAG	D1900V2	5d043	11	24	2012
System Validation Dipole	SPEAG	D2450V2	706	4	19	2012
System Validation Dipole	SPEAG	*D5GHzV2	1075	9	3	2011
Power Meter	Giga-tronics	8651A	8651404	3	13	2012
Power Sensor	Giga-tronics	80701A	1834588	3	13	2012
Amplifier	Mini-Circuits	ZHL-42W	D072701-5	N/A		
Simulating Liquid	CCS	M1800	N/A	Within 24 hrs of first test		
Simulating Liquid	SPEAG	M900	N/A	Within 24 hrs of first test		
Simulating Liquid	SPEAG	H2450	N/A	Within 24 hrs of first test		
Simulating Liquid	SPAEG	M5800	N/A	Within 24 hrs of first test		
Simulating Liquid	SPAEG	(5-6GHz) H5800	N/A	Within 24 hrs of first test		

***Note:** Per KDB 450824 D02 requirements for dipole calibration, UL CCS has adopted two years calibration intervals. On annual basis, each measurement dipole has been evaluated and is in compliance with the following criteria:

1. There is no physical damage on the dipole
2. System validation with specific dipole is within 10% of calibrated value.
3. Return-loss is within 20% of calibrated measurement (Appendix 3 , 4 & 6)
4. Impedance is within 5Ω of calibrated measurement (Appendix 3, 4 & 6)

4.2. MEASUREMENT UNCERTAINTY

Measurement uncertainty for 300 MHz to 3 GHz averaged over 1 gram

Component	error, %	Probe Distribution	Divisor	Sensitivity	U (Xi), %
Measurement System					
Probe Calibration (k=1)	5.50	Normal	1	1	5.50
Axial Isotropy	1.15	Rectangular	1.732	0.7071	0.47
Hemispherical Isotropy	2.30	Rectangular	1.732	0.7071	0.94
Boundary Effect	0.90	Rectangular	1.732	1	0.52
Probe Linearity	3.45	Rectangular	1.732	1	1.99
System Detection Limits	1.00	Rectangular	1.732	1	0.58
Readout Electronics	0.30	Normal	1	1	0.30
Response Time	0.80	Rectangular	1.732	1	0.46
Integration Time	2.60	Rectangular	1.732	1	1.50
RF Ambient Conditions - Noise	3.00	Rectangular	1.732	1	1.73
RF Ambient Conditions - Reflections	3.00	Rectangular	1.732	1	1.73
Probe Positioner Mechanical Tolerance	0.40	Rectangular	1.732	1	0.23
Probe Positioning with respect to Phantom	2.90	Rectangular	1.732	1	1.67
Extrapolation, Interpolation and Integration	1.00	Rectangular	1.732	1	0.58
Test Sample Related					
Test Sample Positioning	2.90	Normal	1	1	2.90
Device Holder Uncertainty	3.60	Normal	1	1	3.60
Output Power Variation - SAR Drift	5.00	Rectangular	1.732	1	2.89
Phantom and Tissue Parameters					
Phantom Uncertainty (shape and thickness)	4.00	Rectangular	1.732	1	2.31
Liquid Conductivity - deviation from target	5.00	Rectangular	1.732	0.64	1.85
Liquid Conductivity - measurement (Body 835 MHz)	2.68	Normal	1	0.64	1.72
Liquid Permittivity - deviation from target	5.00	Rectangular	1.732	0.6	1.73
Liquid Permittivity - measurement uncertainty (Body 1900 MHz)	1.13	Normal	1	0.6	0.68
Combined Standard Uncertainty Uc(y) =					9.62
Expanded Uncertainty U, Coverage Factor = 2, > 95 % Confidence =					19.24 %
Expanded Uncertainty U, Coverage Factor = 2, > 95 % Confidence =					1.53 dB

3 to 6 GHz averaged over 1 gram

Component	error, %	Distribution	Divisor	Sensitivity	U (Xi), %
Measurement System					
Probe Calibration (k=1) @ 5GHz	6.55	Normal	1	1	6.55
Axial Isotropy	1.15	Rectangular	1.732	0.7071	0.47
Hemispherical Isotropy	2.30	Rectangular	1.732	0.7071	0.94
Boundary Effect	0.90	Rectangular	1.732	1	0.52
Probe Linearity	3.45	Rectangular	1.732	1	1.99
System Detection Limits	1.00	Rectangular	1.732	1	0.58
Readout Electronics	1.00	Normal	1	1	1.00
Response Time	0.80	Rectangular	1.732	1	0.46
Integration Time	2.60	Rectangular	1.732	1	1.50
RF Ambient Conditions - Noise	3.00	Rectangular	1.732	1	1.73
RF Ambient Conditions - Reflections	3.00	Rectangular	1.732	1	1.73
Probe Positioner Mechanical Tolerance	0.40	Rectangular	1.732	1	0.23
Probe Positioning with respect to Phantom	2.90	Rectangular	1.732	1	1.67
Extrapolation, Interpolation and Integration	3.90	Rectangular	1.732	1	2.25
Test Sample Related					
Test Sample Positioning	1.10	Normal	1	1	1.10
Device Holder Uncertainty	3.60	Normal	1	1	3.60
Output Power Variation - SAR Drift	5.00	Rectangular	1.732	1	2.89
Phantom and Tissue Parameters					
Phantom Uncertainty (shape and thickness)	4.00	Rectangular	1.732	1	2.31
Liquid Conductivity - deviation from target	5.00	Rectangular	1.732	0.64	1.85
Liquid Conductivity - measurement	-4.60	Normal	1	0.64	-2.94
Liquid Permittivity - deviation from target	10.00	Rectangular	1.732	0.6	3.46
Liquid Permittivity - measurement uncertainty	-3.61	Normal	1	0.6	-2.17
Combined Standard Uncertainty Uc(y), %:					11.07
Expanded Uncertainty U, Coverage Factor = 1.96, > 95 % Confidence =					21.70 %
Expanded Uncertainty U, Coverage Factor = 1.96, > 95 % Confidence =					1.71 dB

5. EQUIPMENT UNDER TEST

The Apple iPad, Model A1397 is a tablet device with iPod functions (music, application support, and video), 802.11a/b/g/n radio, Bluetooth radio functions, and cellular using the CDMA data radio functions							
Normal operation:	Tablet bottom face, and Tablet edges - Multiple display orientations supporting both portrait and landscape configurations						
Antenna tested:	<table border="1"> <thead> <tr> <th><u>Antenna</u></th> <th><u>Apple part number</u></th> </tr> </thead> <tbody> <tr> <td>WiFi/BT</td> <td>631-1482 (shared with BT)</td> </tr> <tr> <td>WWAN</td> <td>631-1781</td> </tr> </tbody> </table>	<u>Antenna</u>	<u>Apple part number</u>	WiFi/BT	631-1482 (shared with BT)	WWAN	631-1781
<u>Antenna</u>	<u>Apple part number</u>						
WiFi/BT	631-1482 (shared with BT)						
WWAN	631-1781						
Antenna-to-antenna/user separation distances:	Refer to Sec. 14 for details of antenna locations and separation distances.						
Simultaneous transmission:	<ul style="list-style-type: none"> • WWAN (CDMA) can transmit simultaneously with WiFi/BT • WWAN (CDMA) can transmit simultaneously with Bluetooth • WiFi 2.4 GHz cannot transmit simultaneously with Bluetooth • WiFi 5 GHz bands can transmit simultaneously with Bluetooth 						
Assessment for SAR evaluation for Simultaneous transmission:	Refer to Sec. 12 for details of KDB 447498 Simultaneous Transmission SAR Evaluations.						
Proximity Sensor for Power Reduction	Trigger Distance : 0-10 mm from back surface; 0- 9.5 mm from Top edge / Secondary Portrait of device						

6. SYSTEM SPECIFICATIONS

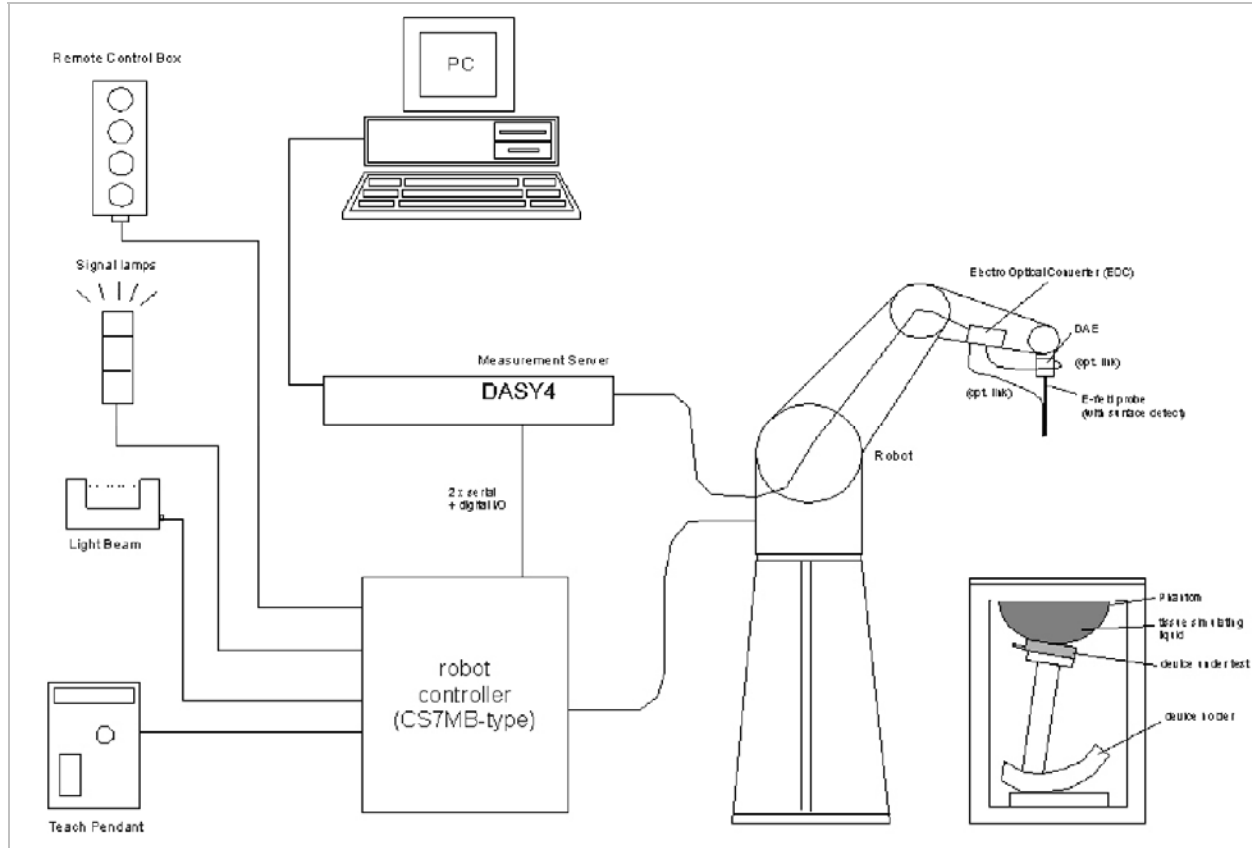

The DASY4 system for performing compliance tests consists of the following items:

- A standard high precision 6-axis robot (Stäubli RX family) with controller, teach pendant and software. An arm extension for accommodating the data acquisition electronics (DAE).
- A dosimetric probe, i.e., an isotropic E-field probe optimized and calibrated for usage in tissue simulating liquid. The probe is equipped with an optical surface detector system.
- A data acquisition electronics (DAE) which performs the signal amplification, signal multiplexing, AD-conversion, offset measurements, mechanical surface detection, collision detection, etc. The unit is battery powered with standard or rechargeable batteries. The signal is optically transmitted to the EOC.
- The function of the measurement server is to perform the time critical tasks such as signal filtering, control of the robot operation and fast movement interrupts.
- A probe alignment unit which improves the (absolute) accuracy of the probe positioning.
- A computer operating Windows 2000 or Windows XP.
- DASY4 software.
- Remote controls with teach pendant and additional circuitry for robot safety such as warning lamps, etc.
- The SAM twin phantom enabling testing left-hand and right-hand usage.
- The device holder for handheld mobile phones.
- Tissue simulating liquid mixed according to the given recipes.
- Validation dipole kits allowing validating the proper functioning of the system.

7. COMPOSITION OF INGREDIENTS FOR TISSUE SIMULATING LIQUIDS

The following tissue formulations are provided for reference only as some of the parameters have not been thoroughly verified. The composition of ingredients may be modified accordingly to achieve the desired target tissue parameters required for routine SAR evaluation.

Ingredients (% by weight)	Frequency (MHz)									
	450		835		915		1900		2450	
Tissue Type	Head	Body	Head	Body	Head	Body	Head	Body	Head	Body
Water	38.56	51.16	41.45	52.4	41.05	56.0	54.9	40.4	62.7	73.2
Salt (NaCl)	3.95	1.49	1.45	1.4	1.35	0.76	0.18	0.5	0.5	0.04
Sugar	56.32	46.78	56.0	45.0	56.5	41.76	0.0	58.0	0.0	0.0
HEC	0.98	0.52	1.0	1.0	1.0	1.21	0.0	1.0	0.0	0.0
Bactericide	0.19	0.05	0.1	0.1	0.1	0.27	0.0	0.1	0.0	0.0
Triton X-100	0.0	0.0	0.0	0.0	0.0	0.0	0.0	0.0	36.8	0.0
DGBE	0.0	0.0	0.0	0.0	0.0	0.0	44.92	0.0	0.0	26.7
Dielectric Constant	43.42	58.0	42.54	56.1	42.0	56.8	39.9	54.0	39.8	52.5
Conductivity (S/m)	0.85	0.83	0.91	0.95	1.0	1.07	1.42	1.45	1.88	1.78

Salt: 99+% Pure Sodium Chloride

Sugar: 98+% Pure Sucrose

Water: De-ionized, 16 MΩ+ resistivity

HEC: Hydroxyethyl Cellulose

DGBE: 99+% Di(ethylene glycol) butyl ether, [2-(2-butoxyethoxy)ethanol]

Triton X-100 (ultra pure): Polyethylene glycol mono [4-(1,1,3,3-tetramethylbutyl)phenyl]ether

Simulating Liquids for 5 GHz, Manufactured by SPEAG

Ingredients	(% by weight)
Water	78
Mineral oil	11
Emulsifiers	9
Additives and Salt	2

8. LIQUID PARAMETERS

The simulating liquids should be checked at the beginning of a series of SAR measurements to determine if the dielectric parameters are within the tolerances of the specified target values. For frequencies in 300 MHz to just under 2 GHz, the measured conductivity and relative permittivity should be within $\pm 5\%$ of the target values. For frequencies in the range of 2–3 GHz and above the measured conductivity should be within $\pm 5\%$ of the target values. The measured relative permittivity tolerance can be relaxed to no more than $\pm 10\%$.

Reference Values of Tissue Dielectric Parameters for Head & Body Phantom

The body tissue parameters that have not been specified in P1528 are derived from the tissue dielectric parameters computed from the 4-Cole-Cole equations and extrapolated according to the head parameters specified in IEEE Standard 1528.

Target Frequency (MHz)	Head		Body	
	ϵ_r	σ (S/m)	ϵ_r	σ (S/m)
150	52.3	0.76	61.9	0.8
300	45.3	0.87	58.2	0.92
450	43.5	0.87	56.7	0.94
835	41.5	0.9	55.2	0.97
900	41.5	0.97	55	1.05
915	41.5	0.98	55	1.06
1450	40.5	1.2	54	1.3
1610	40.3	1.29	53.8	1.4
1800 – 2000	40	1.4	53.3	1.52
2450	39.2	1.8	52.7	1.95
3000	38.5	2.4	52	2.73
5800	35.3	5.27	48.2	6

(ϵ_r = relative permittivity, σ = conductivity and $\rho = 1000 \text{ kg/m}^3$)

Reference Values of Tissue Dielectric Parameters for Body Phantom (for 3000 MHz – 5800 MHz)

In the current guidelines and draft standards for compliance testing of mobile phones (i.e., IEEE P1528, OET 65 Supplement C), the dielectric parameters suggested for head and body tissue simulating liquid are given only at 3.0 GHz and 5.8 GHz. As an intermediate solution, dielectric parameters for the frequencies between 5 to 5.8 GHz were obtained using linear interpolation (see table below).

SPEAG has developed suitable head and body tissue simulating liquids consisting of the following ingredients: de-ionized water, salt and a special composition including mineral oil and an emulgators. Dielectric parameters of these liquids were measured using a HP 8570C Dielectric Probe Kit in conjunction with HP 8753ES Network Analyzer (30 kHz – 6G Hz). The differences with respect to the interpolated values were well within the desired $\pm 5\%$ for the whole 5 to 5.8 GHz range.

f (MHz)	Body Tissue		Reference
	rel. permittivity	conductivity	
3000	52.0	2.73	Standard
5100	49.1	5.18	Interpolated
5200	49.0	5.30	Interpolated
5300	48.9	5.42	Interpolated
5400	48.7	5.53	Interpolated
5500	48.6	5.65	Interpolated
5600	48.5	5.77	Interpolated
5700	48.3	5.88	Interpolated
5800	48.2	6.00	Standard

(ϵ_r = relative permittivity, σ = conductivity and $\rho = 1000 \text{ kg/m}^3$)

8.1. LIQUID CHECK RESULTS

Simulating Liquid Dielectric Parameters for Body 835 MHz

Measured by: Devin Chang

f (MHz)	Liquid Parameters			Measured	Target	Delta (%)	Limit (%)
835	e'	55.01	Relative Permittivity (ϵ_r):	55.008	55.2	-0.35	± 5
	e"	21.44	Conductivity (σ):	0.996	0.97	2.68	± 5

Liquid Check

Ambient temperature: 24 deg. C; Liquid temperature: 23 deg. C; Relative humidity = 41%

January 25, 2011 11:34 AM

Frequency	e'	e"
800000000.	55.3546	21.5511
805000000.	55.2966	21.5380
810000000.	55.2536	21.5263
815000000.	55.2017	21.5279
820000000.	55.1498	21.5044
825000000.	55.1013	21.4905
830000000.	55.0510	21.4700
835000000.	55.0084	21.4404
840000000.	54.9598	21.4162
845000000.	54.9201	21.3850
850000000.	54.8754	21.3490
855000000.	54.8369	21.3217
860000000.	54.7992	21.2801
865000000.	54.7484	21.2478
870000000.	54.7004	21.2208
875000000.	54.6605	21.1867
880000000.	54.6125	21.1594
885000000.	54.5627	21.1407
890000000.	54.5128	21.1225
895000000.	54.4583	21.1067
900000000.	54.4022	21.0928
905000000.	54.3484	21.0887
910000000.	54.2987	21.0832
915000000.	54.2449	21.0789
920000000.	54.1898	21.0756
925000000.	54.1329	21.0659
930000000.	54.0881	21.0642
935000000.	54.0349	21.0539
940000000.	53.9954	21.0435
945000000.	53.9488	21.0268
950000000.	53.9102	21.0107

The conductivity (σ) can be given as:

$$\sigma = \omega \epsilon_0 e'' = 2 \pi f \epsilon_0 e''$$

where $f = \text{target } f * 10^6$

$$\epsilon_0 = 8.854 * 10^{-12}$$

Simulating Liquid Dielectric Parameters for Body 1900 MHz

Measured by: Devin Chang

f (MHz)	Muscle Liquid Parameters		Measured	Target	Delta (%)	Limit (%)	
1900	e'	53.902	Relative Permittivity (ϵ_r):	53.9016	53.3	1.13	± 5
	e''	14.064	Conductivity (σ):	1.48650	1.52	-2.20	± 5

Liquid Check

Ambient temperature: 24 deg. C; Liquid temperature: 23 deg. C; Relative humidity = 42%

January 26, 2011 11:06 PM

Frequency	e'	e''
1710000000.	54.2631	13.4907
1720000000.	54.2785	13.5374
1730000000.	54.3174	13.5821
1740000000.	54.3643	13.6250
1750000000.	54.3950	13.6580
1760000000.	54.3961	13.6843
1770000000.	54.3636	13.7022
1780000000.	54.2992	13.7287
1790000000.	54.2103	13.7487
1800000000.	54.1126	13.7773
1810000000.	54.0271	13.8107
1820000000.	53.9633	13.8516
1830000000.	53.9305	13.8991
1840000000.	53.9265	13.9436
1850000000.	53.9472	13.9843
1860000000.	53.9740	14.0178
1870000000.	53.9904	14.0392
1880000000.	53.9869	14.0533
1890000000.	53.9567	14.0583
1900000000.	53.9016	14.0635
1910000000.	53.8293	14.0766

The conductivity (σ) can be given as:

$$\sigma = \omega \epsilon_0 e'' = 2 \pi f \epsilon_0 e''$$

where $f = \text{target } f * 10^6$

$$\epsilon_0 = 8.854 * 10^{-12}$$

Simulating Liquid Dielectric Parameter Check Result @ Body 2450 MHz

Measured by: Devin Chang

f (MHz)	Liquid Parameters			Measured	Target	Delta (%)	Limit (%)
2450	e'	52.12	Relative Permittivity (ϵ_r):	52.123	52.7	-1.09	± 5
	e''	14.60	Conductivity (σ):	1.990	1.95	2.04	± 5

Liquid Check

Ambient temperature: 24 deg. C; Liquid temperature: 23 deg. C; Relative humidity = 41%

January 17, 2011 10:19 AM

Frequency	e'	e''
2400000000.	52.2326	14.4366
2405000000.	52.2147	14.4597
2410000000.	52.1991	14.4816
2415000000.	52.1855	14.5056
2420000000.	52.1667	14.5284
2425000000.	52.1536	14.5495
2430000000.	52.1393	14.5734
2435000000.	52.1232	14.5986
2440000000.	52.1087	14.6220
2445000000.	52.0897	14.6442
2450000000.	52.0746	14.6668
2455000000.	52.0580	14.6922
2460000000.	52.0413	14.7137
2465000000.	52.0240	14.7365
2470000000.	52.0066	14.7559
2475000000.	51.9900	14.7801
2480000000.	51.9720	14.7994
2485000000.	51.9556	14.8200
2490000000.	51.9384	14.8406
2495000000.	51.9233	14.8596
2500000000.	51.9049	14.8796

The conductivity (σ) can be given as:

$$\sigma = \omega \epsilon_0 e'' = 2 \pi f \epsilon_0 e''$$

where $f = \text{target } f * 10^6$

$$\epsilon_0 = 8.854 * 10^{-12}$$

Simulating Liquid Dielectric Parameter Check Result @ Body 5 GHz

Measured by: David Lee

f (MHz)	Muscle Liquid Parameters			Measured	Target	Delta (%)	Limit (%)
5200	e'	48.7136	Relative Permittivity (ϵ_r):	48.7136	49.0	-0.58	± 10
	e"	17.7246	Conductivity (σ):	5.12742	5.30	-3.26	± 5
5500	e'	48.3858	Relative Permittivity (ϵ_r):	48.3858	48.6	-0.44	± 10
	e"	18.6984	Conductivity (σ):	5.72119	5.65	1.26	± 5
5800	e'	47.1616	Relative Permittivity (ϵ_r):	47.1616	48.2	-2.15	± 10
	e"	18.5549	Conductivity (σ):	5.98695	6.00	-0.22	± 5

Liquid Check

Ambient temperature: 25 deg. C; Liquid temperature: 24 deg. C; Relative humidity = 40%

January 10, 2011 10:02 AM

Frequency	e'	e"
4600000000.	49.9964	16.7112
4650000000.	50.1388	17.2854
4700000000.	49.9642	16.8133
4750000000.	49.7733	17.4304
4800000000.	49.9223	17.1918
4850000000.	49.4924	17.3158
4900000000.	49.6582	17.6773
4950000000.	49.4340	17.2445
5000000000.	49.2491	17.9967
5050000000.	49.4366	17.4994
5100000000.	48.8332	17.9671
5150000000.	49.2039	17.9794
5200000000.	48.7136	17.7246
5250000000.	48.7909	18.4706
5300000000.	48.8218	17.6755
5350000000.	48.2787	18.6161
5400000000.	48.8176	18.0649
5450000000.	47.9861	18.3675
5500000000.	48.3858	18.6984
5550000000.	48.0946	18.0570
5600000000.	47.7267	19.1225
5650000000.	48.2976	18.1278
5700000000.	47.1626	19.0392
5750000000.	48.1469	18.7509
5800000000.	47.1616	18.5549
5850000000.	47.3194	19.4642
5900000000.	47.6455	18.3207
5950000000.	46.4286	19.6760
6000000000.	47.8654	18.7048

The conductivity (σ) can be given as:

$$\sigma = \omega \epsilon_0 e'' = 2 \pi f \epsilon_0 e''$$

where $f = \text{target } f * 10^6$

$$\epsilon_0 = 8.854 * 10^{-12}$$

Simulating Liquid Dielectric Parameter Check Result @ Body 5 GHz

Measured by: David Lee

f (MHz)	Muscle Liquid Parameters			Measured	Target	Delta (%)	Limit (%)
5200	e'	47.721	Relative Permittivity (ϵ_r):	47.7210	49.0	-2.61	± 10
	e"	18.2905	Conductivity (σ):	5.29112	5.30	-0.17	± 5
5500	e'	47.1076	Relative Permittivity (ϵ_r):	47.1076	48.6	-3.07	± 10
	e"	17.6165	Conductivity (σ):	5.39016	5.65	-4.60	± 5
5800	e'	46.4622	Relative Permittivity (ϵ_r):	46.4622	48.2	-3.61	± 10
	e"	19.1959	Conductivity (σ):	6.19378	6.00	3.23	± 5

Liquid Check

Ambient temperature: 25 deg. C; Liquid temperature: 24 deg. C; Relative humidity = 40%

January 11, 2011 07:11 AM

Frequency	e'	e"
4600000000.	48.9605	17.1721
4650000000.	49.0228	16.6388
4700000000.	48.5934	17.1306
4750000000.	48.9218	17.1374
4800000000.	48.3948	16.9383
4850000000.	48.5934	17.6079
4900000000.	48.3747	16.9491
4950000000.	48.1533	17.7381
5000000000.	48.3697	17.3338
5050000000.	47.8348	17.5142
5100000000.	48.1501	17.9113
5150000000.	47.7424	17.2874
5200000000.	47.7210	18.2905
5250000000.	47.7744	17.4219
5300000000.	47.2645	18.1916
5350000000.	47.7141	17.9886
5400000000.	47.0624	17.8217
5450000000.	47.3729	18.5721
5500000000.	47.1076	17.6165
5550000000.	46.8420	18.7476
5600000000.	47.1761	17.9970
5650000000.	46.4814	18.3995
5700000000.	46.9786	18.7034
5750000000.	46.4722	17.9818
5800000000.	46.4622	19.1959
5850000000.	46.6404	17.9547
5900000000.	45.9285	19.0913
5950000000.	46.6394	18.5729
6000000000.	45.7546	18.5346

The conductivity (σ) can be given as:

$$\sigma = \omega \epsilon_0 e'' = 2 \pi f \epsilon_0 e''$$

where $f = \text{target } f * 10^6$

$$\epsilon_0 = 8.854 * 10^{-12}$$

Simulating Liquid Dielectric Parameter Check Result @ Body 5 GHz

Measured by: David Lee

f (MHz)	Muscle Liquid Parameters			Measured	Target	Delta (%)	Limit (%)
5200	e'	49.8309	Relative Permittivity (ϵ_r):	49.8309	49.0	1.70	± 10
	e"	17.6668	Conductivity (σ):	5.11070	5.30	-3.57	± 5
5500	e'	49.3059	Relative Permittivity (ϵ_r):	49.3059	48.6	1.45	± 10
	e"	18.5943	Conductivity (σ):	5.68934	5.65	0.70	± 5
5800	e'	48.4447	Relative Permittivity (ϵ_r):	48.4447	48.2	0.51	± 10
	e"	18.5910	Conductivity (σ):	5.99860	6.00	-0.02	± 5

Liquid Check

Ambient temperature: 25 deg. C; Liquid temperature: 24 deg. C; Relative humidity = 40%

January 14, 2011 08:19 AM

Frequency	e'	e"
4600000000.	51.0668	16.6305
4650000000.	50.9337	16.8486
4700000000.	50.9261	16.8108
4750000000.	50.6895	17.0003
4800000000.	50.7597	17.1063
4850000000.	50.5242	17.0815
4900000000.	50.5395	17.4281
4950000000.	50.3430	17.1591
5000000000.	50.2519	17.6434
5050000000.	50.2001	17.3320
5100000000.	50.0312	17.6791
5150000000.	50.0846	17.7401
5200000000.	49.8309	17.6668
5250000000.	49.7359	18.1132
5300000000.	49.6753	17.7682
5350000000.	49.4087	18.2335
5400000000.	49.5257	18.0992
5450000000.	49.1997	18.1579
5500000000.	49.3059	18.5943
5550000000.	49.1474	18.0706
5600000000.	48.9053	18.8925
5650000000.	49.1268	18.3265
5700000000.	48.5435	18.8295
5750000000.	48.8989	18.8875
5800000000.	48.4447	18.5910
5850000000.	48.4257	19.4993
5900000000.	48.5819	18.5486
5950000000.	47.8553	19.6052
6000000000.	48.5302	19.0647

The conductivity (σ) can be given as:

$$\sigma = \omega \epsilon_0 e'' = 2 \pi f \epsilon_0 e''$$

where $f = \text{target } f * 10^6$

$$\epsilon_0 = 8.854 * 10^{-12}$$

9. SYSTEM VERIFICATION

The system performance check is performed prior to any usage of the system in order to verify SAR system measurement accuracy. The system performance check verifies that the system operates within its specifications of $\pm 10\%$.

System Performance Check Measurement Conditions

- The measurements were performed in the flat section of the SAM twin phantom filled with Head or Body simulating liquid of the following parameters.
- The DASY4 system with an Isotropic E-Field Probe EX3DV3 SN3531 was used for the measurements.
- The dipole was mounted on the small tripod so that the dipole feed point was positioned below the center marking of the flat phantom section and the dipole was oriented parallel to the body axis (the long side of the phantom). The standard measuring distance was 10 mm (above 1 GHz) and 15 mm (below 1 GHz) from dipole center to the simulating liquid surface.
- The coarse grid with a grid spacing of 15 mm was aligned with the dipole.
For 5 GHz band - The coarse grid with a grid spacing of 10 mm was aligned with the dipole.
- Special 7x7x7 fine cube was chosen for cube
- Distance between probe sensors and phantom surface was set to 3 mm.
For 5 GHz band - Distance between probe sensors and phantom surface was set to 2.5 mm
- The dipole input power (forward power) was 100 mW
- The results are normalized to 1 W input power.

Reference SAR Values for HEAD & BODY-tissue from calibration certificate of SPEAG.

System validation dipole	Cal. certificate #	Cal. date	Cal. Freq. (GHz)	SAR Avg (mW/g)		
				Tissue:	Head	Body
D835V2	D835V2-4d002_Apr09	*4/23/2009	0.835	SAR _{1g} :	9.64	9.96
				SAR _{10g} :	6.28	6.56
D1900V2	D1900V2-5d043_Nov09	*11/24/2009	1.9	SAR _{1g} :	39.8	40.4
				SAR _{10g} :	20.7	21.4
D2450V2	D2450V2-706_Apr10	04/19/10	2.4	SAR _{1g} :	51.6	52.4
				SAR _{10g} :	24.4	24.5
D5GHzV2	D5GHzV2-1075_Sep09	*9/3/2009	5.2	SAR _{1g} :		79.0
				SAR _{10g} :		22.0
			5.5	SAR _{1g} :		85.4
				SAR _{10g} :		23.5
			5.8	SAR _{1g} :		73.2
				SAR _{10g} :		20.1

***Note:** Per KDB 450824 D02 requirements for dipole calibration, UL CCS has adopted two years calibration intervals. On annual basis, each measurement dipole has been evaluated and is in compliance with the following criteria:

1. There is no physical damage on the dipole
2. System validation with specific dipole is within 10% of calibrated value.
3. Return-loss is within 20% of calibrated measurement (Appendix 3, 4 & 6)
4. Impedance is within 5Ω of calibrated measurement (Appendix 3, 4 & 6)

9.1. SYSTEM CHECK RESULTS

System validation dipole	Date Tested	Measured (Normalized to 1 W)		Target	Delta (%)	Tolerance (%)
		Tissue:	Body			
D835V2	01/25/11	SAR _{1g} :	9.77	9.96	-1.91	±10
		SAR _{10g} :	6.4	6.56	-2.44	
System validation dipole	Date Tested	Measured (Normalized to 1 W)		Target	Delta (%)	Tolerance (%)
		Tissue:	Body			
D1900V2	01/26/11	SAR _{1g} :	38.2	40.4	-5.45	±10
		SAR _{10g} :	20.2	21.4	-5.61	
System validation dipole	Date Tested	Measured (Normalized to 1 W)		Target	Delta (%)	Tolerance (%)
		Tissue:	Body			
D2450V2	01/17/11	SAR _{1g} :	52.7	52.4	0.57	±10
		SAR _{10g} :	24.1	24.5	-1.63	
System validation dipole	Date Tested	Measured (Normalized to 1 W)		Target	Delta (%)	Tolerance (%)
		Tissue:	Body			
D5GHzV2 (5.2GHz)	01/10/10	SAR _{1g} :	74.2	79.0	-6.08	±10
		SAR _{10g} :	21.4	22.0	-2.73	
D5GHzV2 (5.5GHz)	01/10/10	SAR _{1g} :	83.0	85.4	-2.81	±10
		SAR _{10g} :	23.6	23.5	0.43	
D5GHzV2 (5.8GHz)	01/10/10	SAR _{1g} :	73.7	73.2	0.68	±10
		SAR _{10g} :	21.0	20.1	4.48	
D5GHzV2 (5.2GHz)	01/11/11	SAR _{1g} :	75.0	79.0	-5.06	±10
		SAR _{10g} :	21.7	22.0	-1.36	
D5GHzV2 (5.5GHz)	01/11/11	SAR _{1g} :	80.9	85.4	-5.27	±10
		SAR _{10g} :	23.0	23.5	-2.13	
D5GHzV2 (5.8GHz)	01/11/11	SAR _{1g} :	73.1	73.2	-0.14	±10
		SAR _{10g} :	20.8	20.1	3.48	
D5GHzV2 (5.2GHz)	01/14/11	SAR _{1g} :	75.6	79.0	-4.30	±10
		SAR _{10g} :	22.1	22.0	0.45	
D5GHzV2 (5.5GHz)	01/14/11	SAR _{1g} :	83.2	85.4	-2.58	±10
		SAR _{10g} :	23.8	23.5	1.28	
D5GHzV2 (5.8GHz)	01/14/11	SAR _{1g} :	73.3	73.2	0.14	±10
		SAR _{10g} :	21.0	20.1	4.48	

SYSTEM CHECK PLOT for D835V2

Date/Time: 1/25/2011 2:17:31 PM

Test Laboratory: Compliance Certification Services (UL CCS)

System Performance Check - D835V2

DUT: Dipole 835 MHz; Type: D835V2; Serial: D835V2 - SN:xxx

Communication System: CW 835; Frequency: 835 MHz; Duty Cycle: 1:1
Medium parameters used: $f = 835 \text{ MHz}$; $\sigma = 0.996 \text{ mho/m}$; $\epsilon_r = 55$; $\rho = 1000 \text{ kg/m}^3$
Phantom section: Flat Section

Room Ambient Temperature: 24.0 deg. C; Liquid Temperature: 23.0 deg. C

DASY4 Configuration:

- Area Scan setting - Find Secondary Maximum Within: 2.0 dB and with a peak SAR value greater than 0.0012W/kg
- Probe: EX3DV4 - SN3749; ConvF(8.79, 8.79, 8.79); Calibrated: 12/13/2010
- Sensor-Surface: 3mm (Mechanical Surface Detection)
- Electronics: DAE3 Sn427; Calibrated: 7/21/2010
- Phantom: SAM 2 (Twin); Type: SAM 2; Serial: 1050
- Measurement SW: DASY4, V4.7 Build 80; Postprocessing SW: SEMCAD, V1.8 Build 186

d=15mm, Pin=100 mW/Area Scan (7x9x1): Measurement grid: dx=15mm, dy=15mm
Maximum value of SAR (measured) = 1.14 mW/g

d=15mm, Pin=100 mW/Zoom Scan (7x7x7)/Cube 0: Measurement grid: dx=5mm, dy=5mm, dz=5mm
Reference Value = 34.1 V/m; Power Drift = -0.048 dB
Peak SAR (extrapolated) = 1.47 W/kg
SAR(1 g) = 0.977 mW/g; SAR(10 g) = 0.640 mW/g

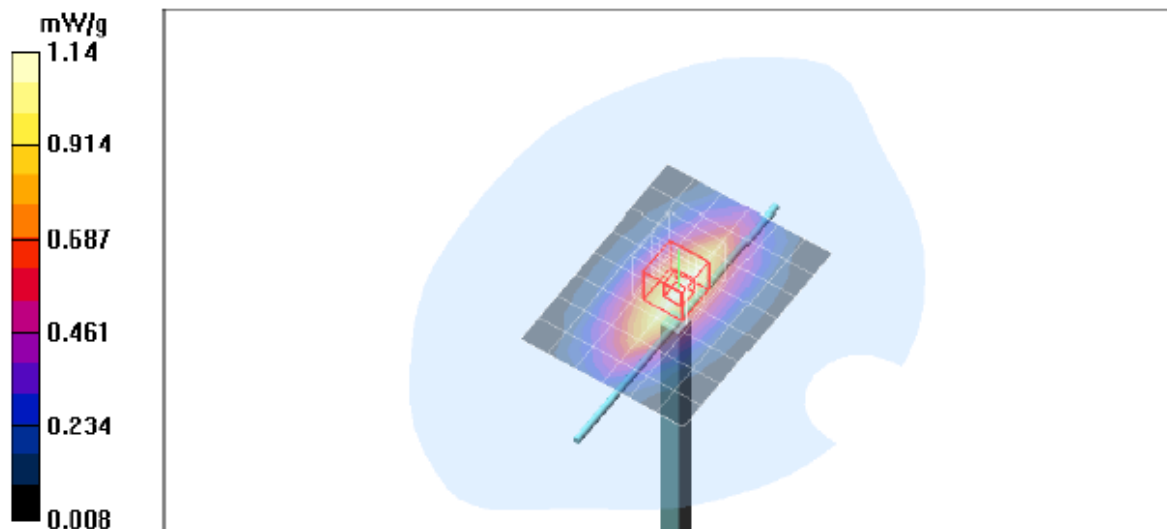

Z-Axis PLOT for D835V2

Date/Time: 1/25/2011 2:34:07 PM

Test Laboratory: Compliance Certification Services (UL CCS)

System Performance Check - D835V2

DUT: Dipole 835 MHz; Type: D835V2; Serial: D835V2 - SN:xxx

Communication System: CW 835; Frequency: 835 MHz; Duty Cycle: 1:1

d=15mm, Pin=100 mW/Z Scan (1x1x34): Measurement grid: dx=20mm, dy=20mm, dz=3mm
Maximum value of SAR (measured) = 1.14 mW/g

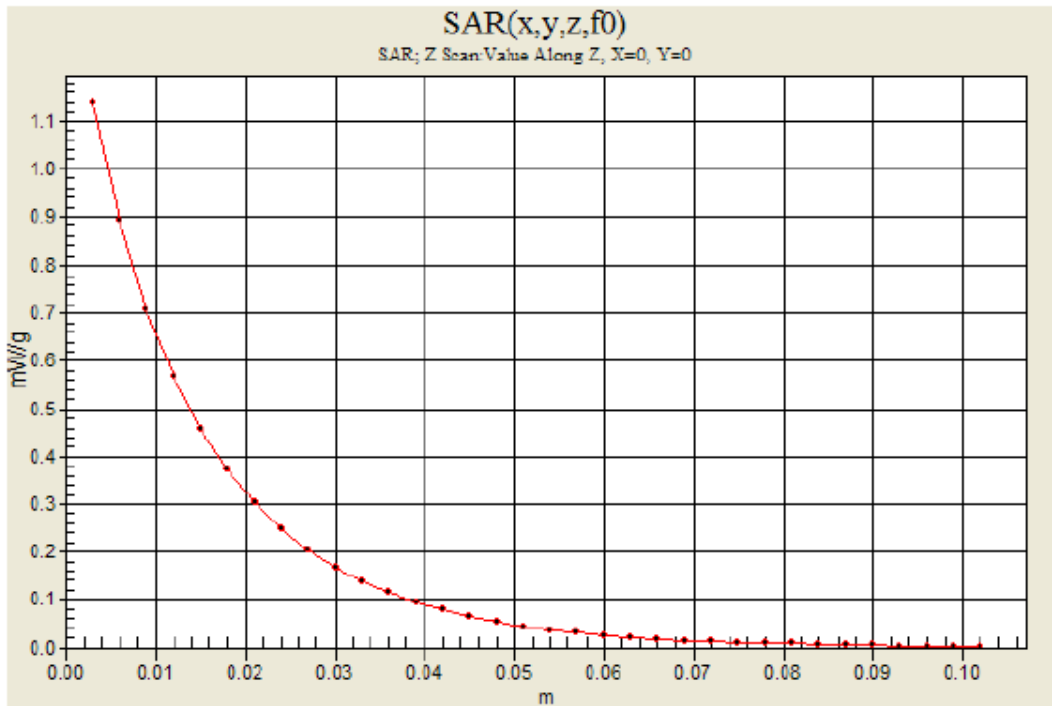

SYSTEM CHECK PLOT for D1900V2

Date/Time: 1/26/2011 11:52:25 PM

Test Laboratory: Compliance Certification Services (UL CCS)

System Performance Check - D1900V2

DUT: Dipole; Type: D1900V2; Serial: 5d043

Communication System: System Check Signal - CW; Frequency: 1900 MHz; Duty Cycle: 1:1
Medium parameters used: $f = 1900$ MHz; $\sigma = 1.49$ mho/m; $\epsilon_r = 53.9$; $\rho = 1000$ kg/m³
Phantom section: Flat Section

Room Ambient Temperature: 24.0 deg. C; Liquid Temperature: 23.0 deg. C

DASY4 Configuration:

- Area Scan setting - Find Secondary Maximum Within: 2.0 dB and with a peak SAR value greater than 0.0012W/kg
- Probe: EX3DV4 - SN3749; ConvF(7.33, 7.33, 7.33); Calibrated: 12/13/2010
- Sensor-Surface: 3mm (Mechanical Surface Detection)
- Electronics: DAE3 Sn427; Calibrated: 7/21/2010
- Phantom: Flat Phantom ELI4.0; Type: QDOVA001BA; Serial: SN:1003
- Measurement SW: DASY4, V4.7 Build 80; Postprocessing SW: SEMCAD, V1.8 Build 186

d=10mm, Pin=100mW/Area Scan (7x7x1): Measurement grid: dx=15mm, dy=15mm
Maximum value of SAR (measured) = 3.29 mW/g

d=10mm, Pin=100mW/Zoom Scan (7x7x7)/Cube 0: Measurement grid: dx=5mm, dy=5mm, dz=5mm
Reference Value = 55.8 V/m; Power Drift = 0.237 dB
Peak SAR (extrapolated) = 6.87 W/kg
SAR(1 g) = 3.82 mW/g; SAR(10 g) = 2.02 mW/g
Maximum value of SAR (measured) = 4.81 mW/g

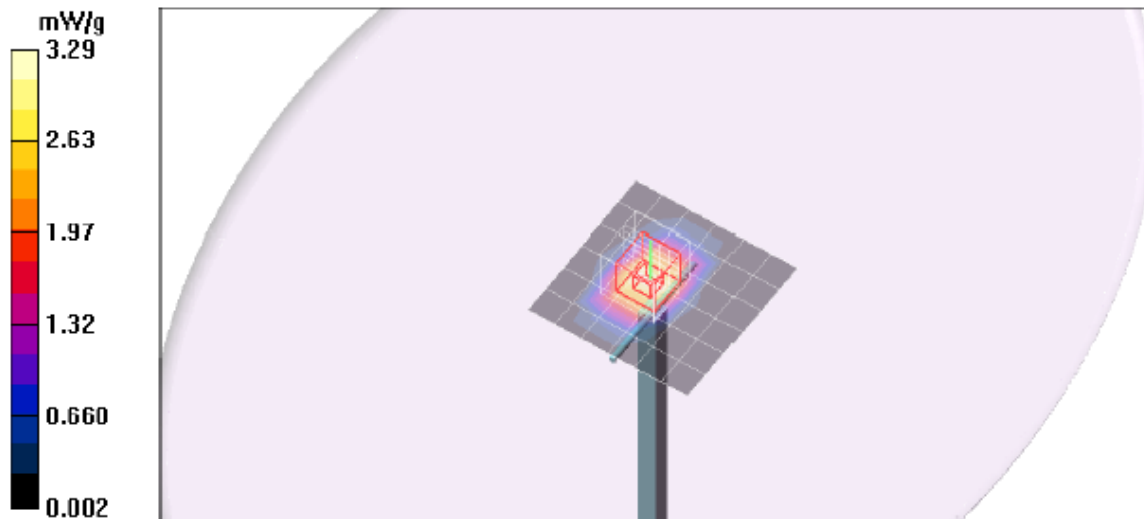

Z-Axis PLOT for D1900V2

Date/Time: 1/27/2011 12:08:28 AM

Test Laboratory: Compliance Certification Services (UL CCS)

System Performance Check - D1900V2

DUT: Dipole; Type: D1900V2; Serial: 5d043

Communication System: System Check Signal - CW; Frequency: 1900 MHz; Duty Cycle: 1:1

d=10mm, Pin=100mW/Z Scan (1x1x34): Measurement grid: dx=20mm, dy=20mm, dz=3mm
Maximum value of SAR (measured) = 4.83 mW/g

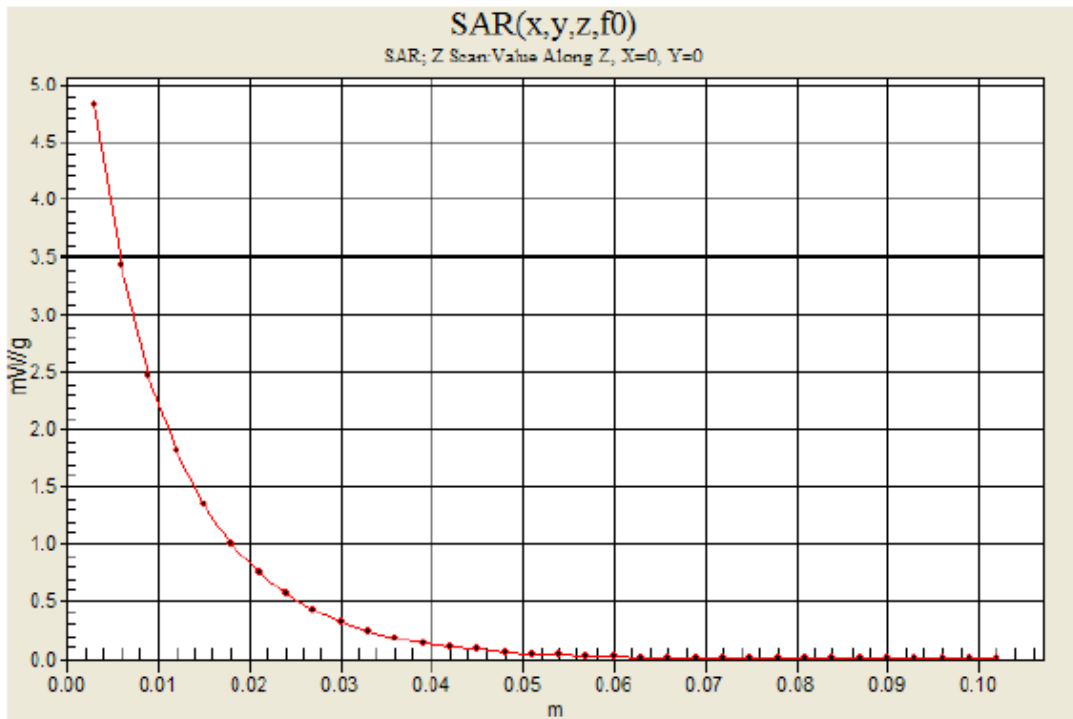

SYSTEM CHECK PLOT for D2450V2

Date/Time: 1/17/2011 11:20:01 AM

Test Laboratory: Compliance Certification Services (UL CCS)

System Performance Check - D2450V2

DUT: Dipole ; Type: D2450V2; Serial: 706

Communication System: System Check Signal - CW; Frequency: 2450 MHz; Duty Cycle: 1:1

Medium parameters used: $f = 2450$ MHz; $\sigma = 2$ mho/m; $\epsilon_r = 52.1$; $\rho = 1000$ kg/m³

Phantom section: Flat Section

Room Ambient Temperature: 24.0 deg. C; Liquid Temperature: 23.0 deg. C

DASY4 Configuration:

- Area Scan setting - Find Secondary Maximum Within: 2.0 dB and with a peak SAR value greater than 0.0012W/kg
- Probe: EX3DV4 - SN3749; ConvF(6.9, 6.9, 6.9); Calibrated: 12/13/2010
- Sensor-Surface: 3mm (Mechanical Surface Detection)
- Electronics: DAE3 Sn427; Calibrated: 7/21/2010
- Phantom: Flat Phantom ELI4.0; Type: QDOVA001BA; Serial: SN:1003
- Measurement SW: DASY4, V4.7 Build 80; Postprocessing SW: SEMCAD, V1.8 Build 186

d=10mm, Pin=100mW/Area Scan (6x6x1): Measurement grid: dx=15mm, dy=15mm

Maximum value of SAR (measured) = 5.58 mW/g

d=10mm, Pin=100mW/Zoom Scan (7x7x7)/Cube 0: Measurement grid: dx=5mm, dy=5mm, dz=5mm

Reference Value = 59.3 V/m; Power Drift = -0.032 dB

Peak SAR (extrapolated) = 11.2 W/kg

SAR(1 g) = 5.27 mW/g; SAR(10 g) = 2.41 mW/g

Maximum value of SAR (measured) = 6.96 mW/g

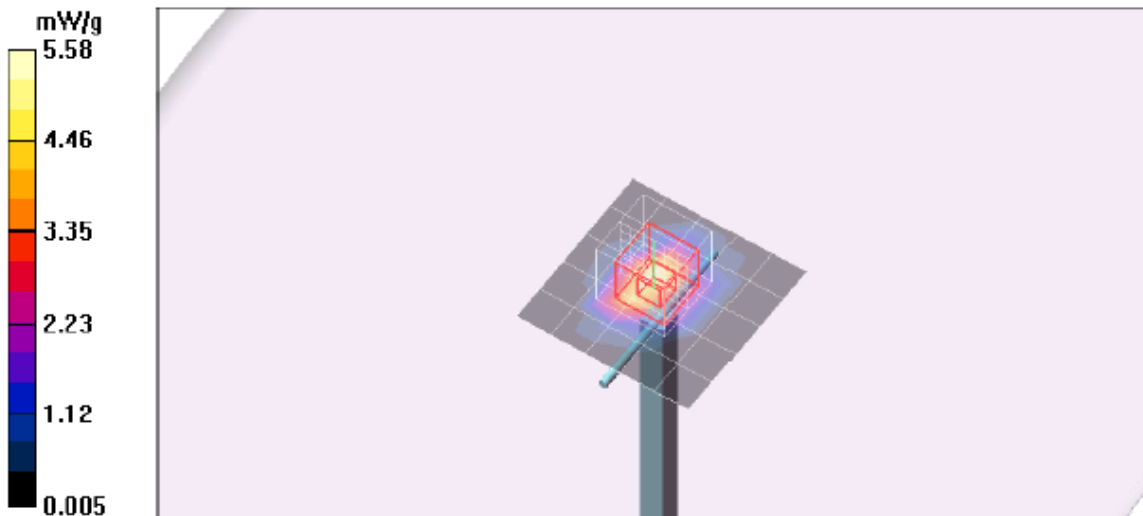

Z-Axis PLOT for D2450V2

Date/Time: 1/17/2011 11:34:38 AM

Test Laboratory: Compliance Certification Services (UL CCS)

System Performance Check - D2450V2

DUT: Dipole ; Type: D2450V2; Serial: 706

Communication System: System Check Signal - CW; Frequency: 2450 MHz; Duty Cycle: 1:1

d=10mm, Pin=100mW/Z Scan (1x1x34): Measurement grid: dx=20mm, dy=20mm, dz=3mm
Maximum value of SAR (measured) = 6.97 mW/g

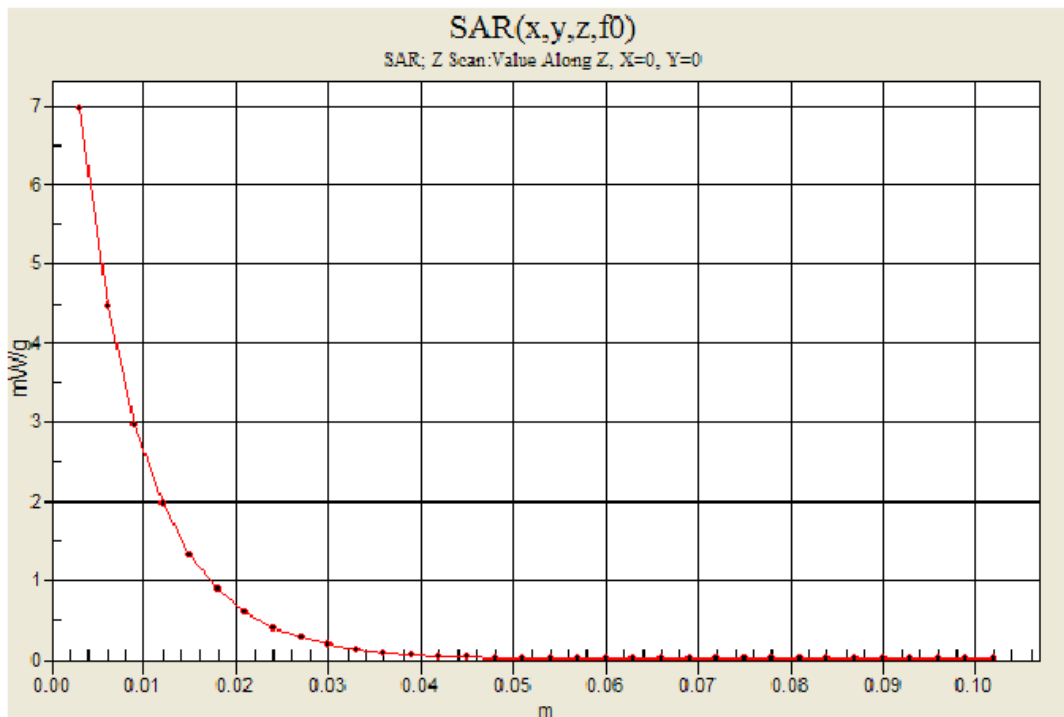

SYSTEM CHECK PLOT for 5.5 GHz band

Date/Time: 1/10/2011 12:10:22 PM

Test Laboratory: Compliance Certification Services (UL CCS)

System Performance Check - D5GHzV2

DUT: Dipole 5200-5800MHz; Type: D5GHzV2; Serial: 1075

Communication System: System Check Signal - CW; Frequency: 5200 MHz; Duty Cycle: 1:1

Medium parameters used: $f = 5200$ MHz; $\sigma = 5.39$ mho/m; $\epsilon_r = 48.4$; $\rho = 1000$ kg/m³

Phantom section: Flat Section

Room Ambient Temperature: 25.0 deg. C; Liquid Temperature: 24.0 deg. C

DASY4 Configuration:

- Area Scan setting - Find Secondary Maximum Within: 2.0 dB and with a peak SAR value greater than 0.0012W/kg

- Probe: EX3DV4 - SN3749; ConvF(4.07, 4.07, 4.07); Calibrated: 12/13/2010

- Sensor-Surface: 2.5mm (Mechanical Surface Detection)

- Electronics: DAE3 Sn427; Calibrated: 7/21/2010

- Phantom: Flat Phantom ELI4.0; Type: QDOVA001BA; Serial: SN:XXXX

- Measurement SW: DASY4, V4.7 Build 80; Postprocessing SW: SEMCAD, V1.8 Build 186

5.2GHz, d=10mm, Pin=100mW/Area Scan (7x7x1): Measurement grid: dx=10mm, dy=10mm

Maximum value of SAR (measured) = 13.6 mW/g

5.2GHz, d=10mm, Pin=100mW/Zoom Scan (8x8x10)/Cube 0: Measurement grid:

dx=4mm, dy=4mm, dz=2.5mm

Reference Value = 54.8 V/m; Power Drift = -0.046 dB

Peak SAR (extrapolated) = 25.0 W/kg

SAR(1 g) = 7.42 mW/g; SAR(10 g) = 2.14 mW/g

Maximum value of SAR (measured) = 13.3 mW/g

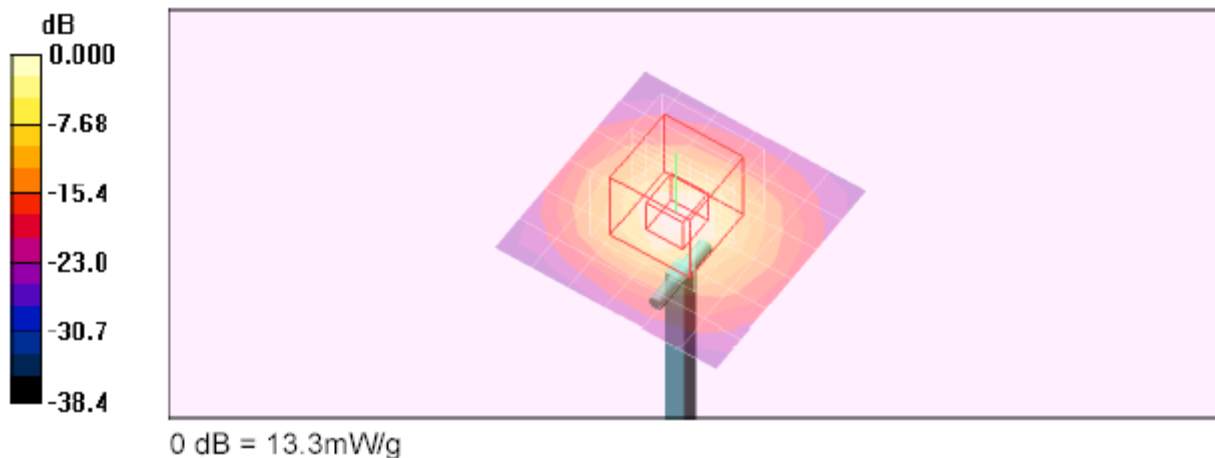

SYSTEM CHECK PLOT for 5.5 GHz band

Date/Time: 1/10/2011 11:06:47 AM

Test Laboratory: Compliance Certification Services (UL CCS)

System Performance Check - D5GHzV2

DUT: Dipole 5200-5800MHz; Type: D5GHzV2; Serial: 1075

Communication System: System Check Signal - CW; Frequency: 5500 MHz; Duty Cycle: 1:1

Medium parameters used: $f = 5500$ MHz; $\sigma = 5.83$ mho/m; $\epsilon_r = 47.8$; $\rho = 1000$ kg/m³

Phantom section: Flat Section

Room Ambient Temperature: 25.0 deg. C; Liquid Temperature: 24.0 deg. C

DASY4 Configuration:

- Area Scan setting - Find Secondary Maximum Within: 2.0 dB and with a peak SAR value greater than 0.0012W/kg
- Probe: EX3DV4 - SN3749; ConvF(3.53, 3.53, 3.53); Calibrated: 12/13/2010
- Sensor-Surface: 2.5mm (Mechanical Surface Detection)
- Electronics: DAE3 Sn427; Calibrated: 7/21/2010
- Phantom: Flat Phantom ELI4.0; Type: QDOVA001BA; Serial: SN:XXXX
- Measurement SW: DASY4, V4.7 Build 80; Postprocessing SW: SEMCAD, V1.8 Build 186

5.5GHz, d=10mm, Pin=100mW/Area Scan (7x7x1): Measurement grid: dx=10mm, dy=10mm
Maximum value of SAR (measured) = 15.2 mW/g

5.5GHz, d=10mm, Pin=100mW/Zoom Scan (8x8x10)/Cube 0: Measurement grid:
dx=4mm, dy=4mm, dz=2.5mm
Reference Value = 55.4 V/m; Power Drift = -0.047 dB
Peak SAR (extrapolated) = 29.1 W/kg
SAR(1 g) = 8.3 mW/g; SAR(10 g) = 2.36 mW/g
Maximum value of SAR (measured) = 14.8 mW/g

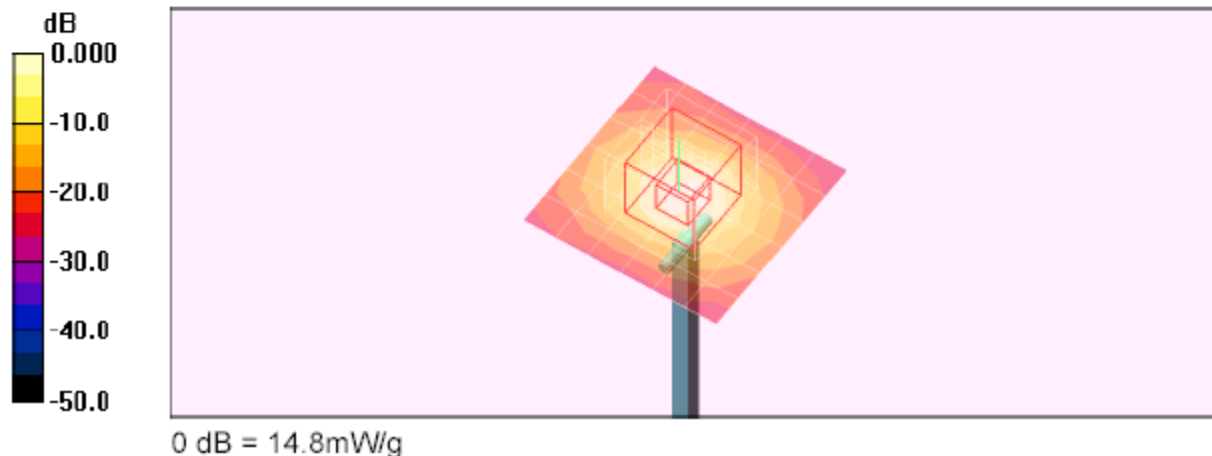

SYSTEM CHECK PLOT for 5.8 GHz band

Date/Time: 1/10/2011 10:36:47 AM

Test Laboratory: Compliance Certification Services (UL CCS)

System Performance Check - D5GHzV2

DUT: Dipole 5200-5800MHz; Type: D5GHzV2; Serial: 1075

Communication System: System Check Signal - CW; Frequency: 5800 MHz; Duty Cycle: 1:1

Medium parameters used: $f = 5800$ MHz; $\sigma = 6.27$ mho/m; $\epsilon_r = 47.2$; $\rho = 1000$ kg/m³

Phantom section: Flat Section

Room Ambient Temperature: 25.0 deg. C; Liquid Temperature: 24.0 deg. C

DASY4 Configuration:

- Area Scan setting - Find Secondary Maximum Within: 2.0 dB and with a peak SAR value greater than 0.0012W/kg
- Probe: EX3DV4 - SN3749; ConvF(3.65, 3.65, 3.65); Calibrated: 12/13/2010
- Sensor-Surface: 2.5mm (Mechanical Surface Detection)
- Electronics: DAE3 Sn427; Calibrated: 7/21/2010
- Phantom: Flat Phantom ELI4.0; Type: QDOVA001BA; Serial: SN:XXXX
- Measurement SW: DASY4, V4.7 Build 80; Postprocessing SW: SEMCAD, V1.8 Build 186

5.8GHz, d=10mm, Pin=100mW/Area Scan (7x7x1): Measurement grid: dx=10mm, dy=10mm
Maximum value of SAR (measured) = 13.3 mW/g

5.8GHz, d=10mm, Pin=100mW/Zoom Scan (8x8x10)/Cube 0: Measurement grid:
dx=4mm, dy=4mm, dz=2.5mm
Reference Value = 50.8 V/m; Power Drift = -0.077 dB
Peak SAR (extrapolated) = 26.8 W/kg
SAR(1 g) = 7.37 mW/g; SAR(10 g) = 2.1 mW/g
Maximum value of SAR (measured) = 13.2 mW/g

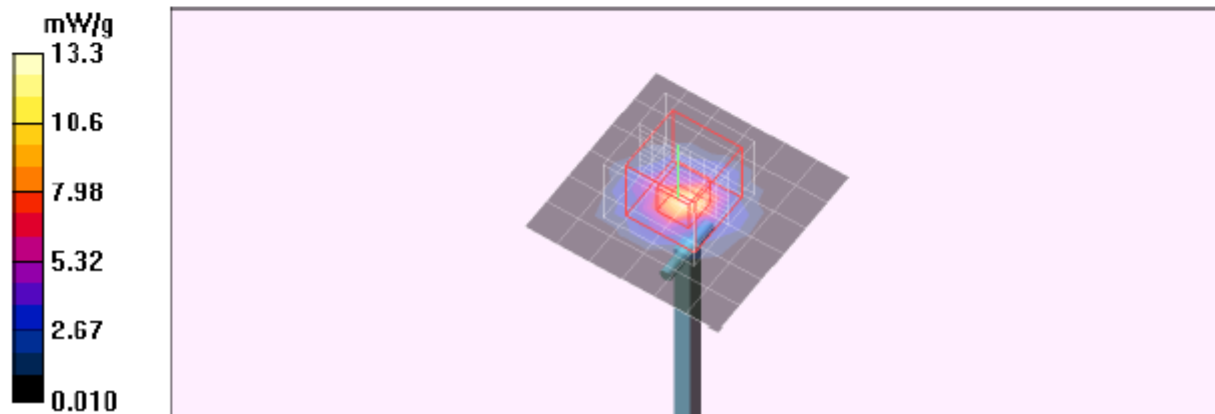

Z-Axis PLOT for 5.8 GHz band

Date/Time: 1/10/2011 11:01:25 AM

Test Laboratory: Compliance Certification Services (UL CCS)

System Performance Check - D5GHzV2

DUT: Dipole 5200-5800MHz; Type: D5GHzV2; Serial: 1075

Communication System: System Check Signal - CW; Frequency: 5800 MHz; Duty Cycle: 1:1

5.8GHz, d=10mm, Pin=100mW/Z Scan (1x1x34): Measurement grid: dx=20mm, dy=20mm, dz=3mm
Maximum value of SAR (measured) = 12.5 mW/g

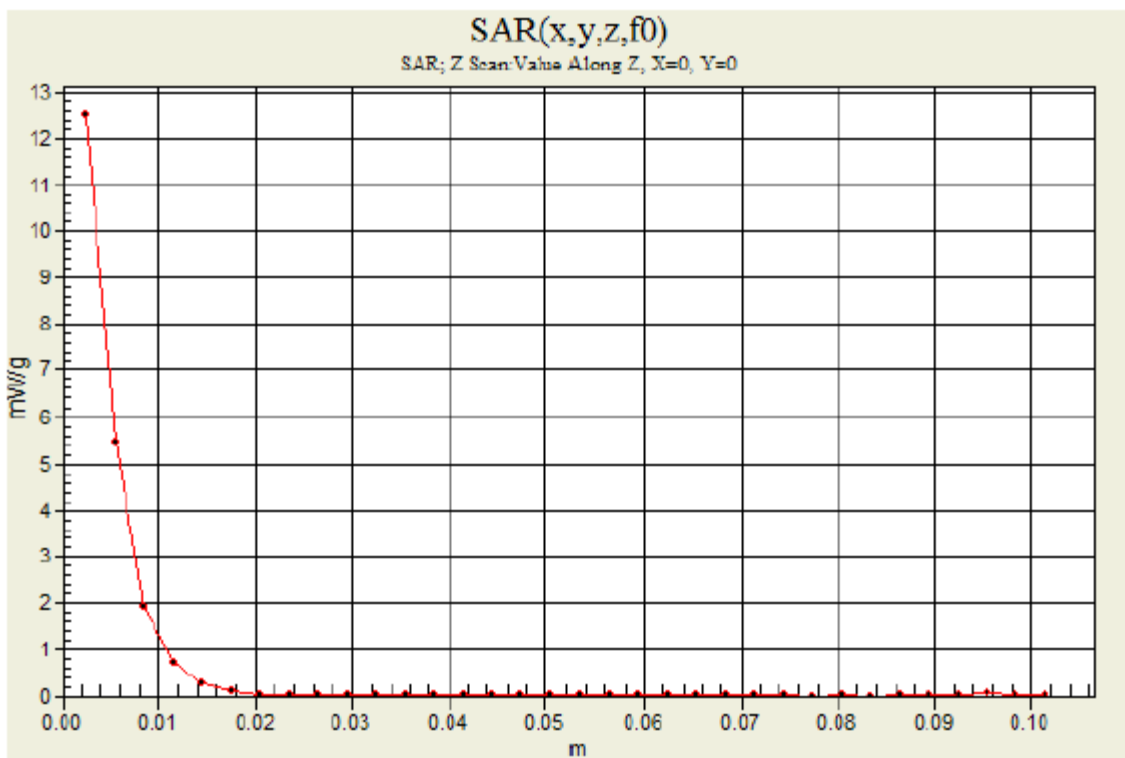

SYSTEM CHECK PLOT for 5.2 GHz band

Date/Time: 1/11/2011 7:55:42 AM

Test Laboratory: Compliance Certification Services (UL CCS)

System Performance Check - D5GHzV2_5 GHz

DUT: D5GHzV2; Type: D5GHzV2; Serial: 1075

Communication System: CW 5GHz; Frequency: 5200 MHz; Duty Cycle: 1:1
Medium parameters used: $f = 5200$ MHz; $\sigma = 5.29$ mho/m; $\epsilon_r = 47.7$; $\rho = 1000$ kg/m³
Phantom section: Flat Section

Room Ambient Temperature: 25.0 deg. C; Liquid Temperature: 24.0 deg. C

DASY4 Configuration:

- Area Scan setting - Find Secondary Maximum Within: 2.0 dB and with a peak SAR value greater than 0.0012W/kg
- Probe: EX3DV4 - SN3749; ConvF(4.07, 4.07, 4.07); Calibrated: 12/13/2010
- Sensor-Surface: 2.5mm (Mechanical Surface Detection)
- Electronics: DAE3 Sn427; Calibrated: 7/21/2010
- Phantom: Flat Phantom ELI4.0; Type: QDOVA001BA; Serial: SN:XXXX
- Measurement SW: DASY4, V4.7 Build 80; Postprocessing SW: SEMCAD, V1.8 Build 186

d=10mm, Pin=100mW, 5.2GHz/Area Scan (7x7x1): Measurement grid: dx=10mm, dy=10mm
Maximum value of SAR (measured) = 13.3 mW/g

d=10mm, Pin=100mW, 5.2GHz/Zoom Scan (8x8x10)/Cube 0: Measurement grid:
dx=4mm, dy=4mm, dz=2.5mm
Reference Value = 55.1 V/m; Power Drift = 0.196 dB
Peak SAR (extrapolated) = 25.4 W/kg
SAR(1 g) = 7.5 mW/g; SAR(10 g) = 2.17 mW/g

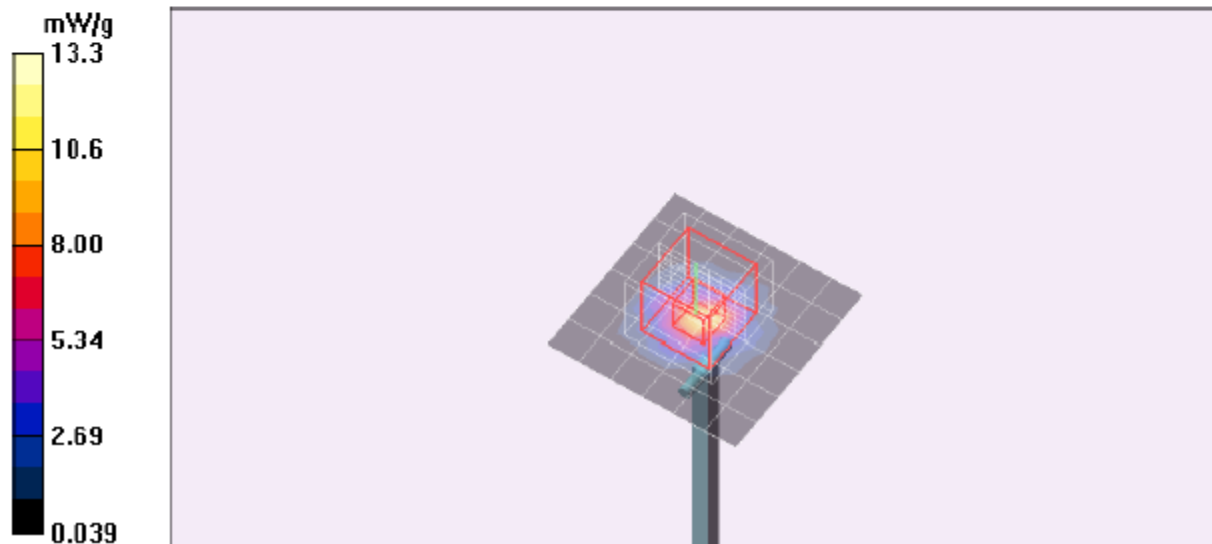

SYSTEM CHECK PLOT for 5.5 GHz band

Date/Time: 1/11/2011 9:01:30 AM

Test Laboratory: Compliance Certification Services (UL CCS)

System Performance Check - D5GHzV2_5 GHz

DUT: D5GHzV2; Type: D5GHzV2; Serial: 1075

Communication System: CW 5GHz; Frequency: 5500 MHz; Duty Cycle: 1:1
Medium parameters used: $f = 5500$ MHz; $\sigma = 5.39$ mho/m; $\epsilon_r = 47.1$; $\rho = 1000$ kg/m³
Phantom section: Flat Section

Room Ambient Temperature: 25.0 deg. C; Liquid Temperature: 24.0 deg. C

DASY4 Configuration:

- Area Scan setting - Find Secondary Maximum Within: 2.0 dB and with a peak SAR value greater than 0.0012W/kg
- Probe: EX3DV4 - SN3749; ConvF(3.53, 3.53, 3.53); Calibrated: 12/13/2010
- Sensor-Surface: 2.5mm (Mechanical Surface Detection)
- Electronics: DAE3 Sn427; Calibrated: 7/21/2010
- Phantom: Flat Phantom ELI4.0; Type: QDOVA001BA; Serial: SN:XXXX
- Measurement SW: DASY4, V4.7 Build 80; Postprocessing SW: SEMCAD, V1.8 Build 186

d=10mm, Pin=100mW, 5.5GHz/Area Scan (7x7x1): Measurement grid: dx=10mm, dy=10mm
Maximum value of SAR (measured) = 14.6 mW/g

d=10mm, Pin=100mW, 5.5GHz/Zoom Scan (8x8x10)/Cube 0: Measurement grid:
dx=4mm, dy=4mm, dz=2.5mm
Reference Value = 56.8 V/m; Power Drift = 0.087 dB
Peak SAR (extrapolated) = 28.2 W/kg
SAR(1 g) = 8.09 mW/g; SAR(10 g) = 2.3 mW/g
Maximum value of SAR (measured) = 14.3 mW/g

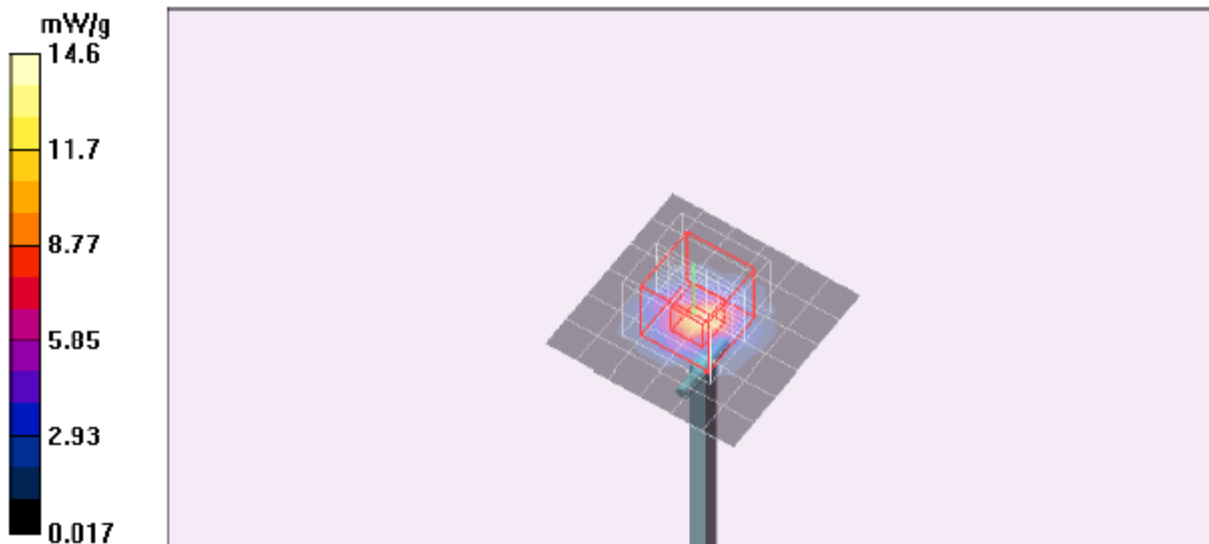

SYSTEM CHECK PLOT for 5.8 GHz band

Date/Time: 1/11/2011 10:03:36 AM

Test Laboratory: Compliance Certification Services (UL CCS)

System Performance Check - D5GHzV2_5 GHz

DUT: D5GHzV2; Type: D5GHzV2; Serial: 1075

Communication System: CW 5GHz; Frequency: 5800 MHz; Duty Cycle: 1:1
Medium parameters used: $f = 5800$ MHz; $\sigma = 6.19$ mho/m; $\epsilon_r = 46.5$; $\rho = 1000$ kg/m³
Phantom section: Flat Section

Room Ambient Temperature: 25.0 deg. C; Liquid Temperature: 24.0 deg. C

DASY4 Configuration:

- Area Scan setting - Find Secondary Maximum Within: 2.0 dB and with a peak SAR value greater than 0.0012W/kg
- Probe: EX3DV4 - SN3749; ConvF(3.65, 3.65, 3.65); Calibrated: 12/13/2010
- Sensor-Surface: 2.5mm (Mechanical Surface Detection)
- Electronics: DAE3 Sn427; Calibrated: 7/21/2010
- Phantom: Flat Phantom ELI4.0; Type: QDOVA001BA; Serial: SN:XXXX
- Measurement SW: DASY4, V4.7 Build 80; Postprocessing SW: SEMCAD, V1.8 Build 186

d=10mm, Pin=100mW, 5.8GHz/Area Scan (7x7x1): Measurement grid: dx=10mm, dy=10mm
Maximum value of SAR (measured) = 13.5 mW/g

d=10mm, Pin=100mW, 5.8GHz/Zoom Scan (8x8x10)/Cube 0: Measurement grid:
dx=4mm, dy=4mm, dz=2.5mm
Reference Value = 51.0 V/m; Power Drift = 0.119 dB
Peak SAR (extrapolated) = 27.6 W/kg
SAR(1 g) = 7.31 mW/g; SAR(10 g) = 2.08 mW/g
Maximum value of SAR (measured) = 13.3 mW/g

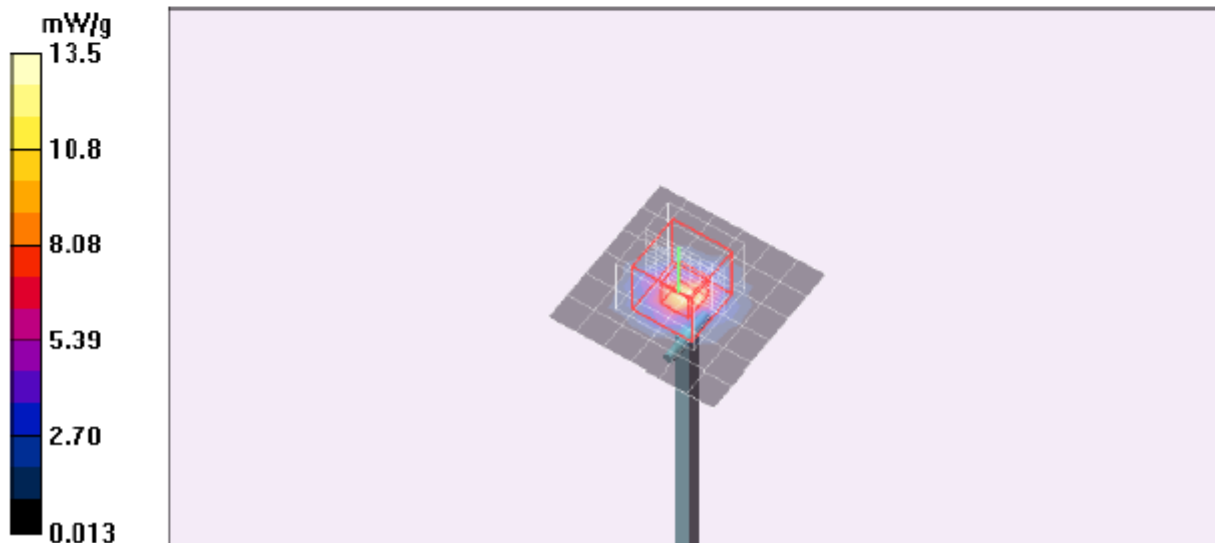

Z-Axis PLOT for 5.8 GHz band

Date/Time: 1/11/2011 10:28:03 AM

Test Laboratory: Compliance Certification Services (UL CCS)

System Performance Check - D5GHzV2_5 GHz

DUT: D5GHzV2; Type: D5GHzV2; Serial: 1075

Communication System: CW 5GHz; Frequency: 5800 MHz; Duty Cycle: 1:1

d=10mm, Pin=100mW, 5.8GHz/Z Scan (1x1x34): Measurement grid: dx=20mm, dy=20mm, dz=3mm

Maximum value of SAR (measured) = 13.3 mW/g

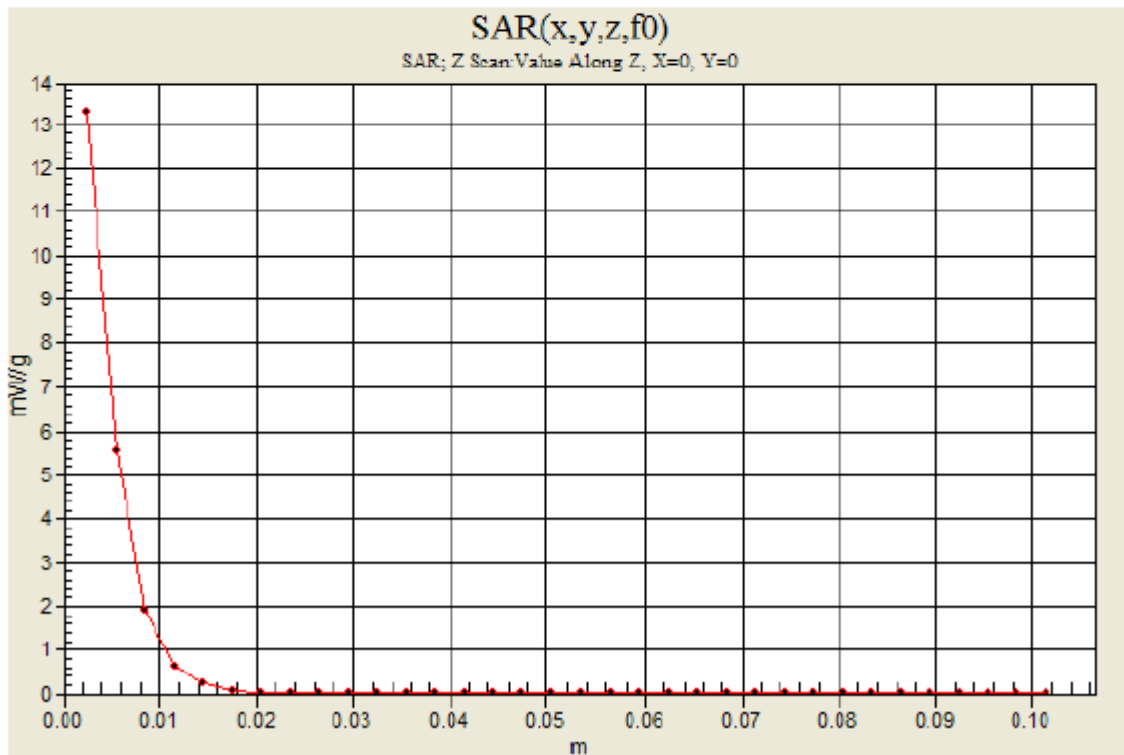

SYSTEM CHECK PLOT for 5.2 GHz band

Date/Time: 1/14/2011 9:09:44 AM

Test Laboratory: Compliance Certification Services (UL CCS)

System Performance Check - D5GHzV2

DUT: Dipole 5200-5800MHz; Type: D5GHzV2; Serial: 1075

Communication System: System Check Signal - CW; Frequency: 5200 MHz; Duty Cycle: 1:1

Medium parameters used: $f = 5200$ MHz; $\sigma = 5.11$ mho/m; $\epsilon_r = 49.8$; $\rho = 1000$ kg/m³

Phantom section: Flat Section

Room Ambient Temperature: 25.0 deg. C; Liquid Temperature: 24.0 deg. C

DASY4 Configuration:

- Area Scan setting - Find Secondary Maximum Within: 2.0 dB and with a peak SAR value greater than 0.0012W/kg
- Probe: EX3DV4 - SN3749; ConvF(4.07, 4.07, 4.07); Calibrated: 12/13/2010
- Sensor-Surface: 2.5mm (Mechanical Surface Detection)
- Electronics: DAE3 Sn427; Calibrated: 7/21/2010
- Phantom: Flat Phantom ELI4.0; Type: QDOVA001BA; Serial: SN:XXXX
- Measurement SW: DASY4, V4.7 Build 80; Postprocessing SW: SEMCAD, V1.8 Build 186

5.2GHz, d=10mm, Pin=100mW/Area Scan (7x7x1): Measurement grid: dx=10mm, dy=10mm

Maximum value of SAR (measured) = 13.1 mW/g

5.2GHz, d=10mm, Pin=100mW/Zoom Scan (8x8x10)/Cube 0: Measurement grid: dx=4mm,

dy=4mm, dz=2.5mm

Reference Value = 56.0 V/m; Power Drift = 0.065 dB

Peak SAR (extrapolated) = 23.8 W/kg

SAR(1 g) = 7.56 mW/g; SAR(10 g) = 2.21 mW/g

Maximum value of SAR (measured) = 13.2 mW/g



SYSTEM CHECK PLOT for 5.5 GHz band

Date/Time: 1/14/2011 9:38:08 AM

Test Laboratory: Compliance Certification Services (UL CCS)

System Performance Check - D5GHzV2

DUT: Dipole 5200-5800MHz; Type: D5GHzV2; Serial: 1075

Communication System: System Check Signal - CW; Frequency: 5500 MHz; Duty Cycle: 1:1
Medium parameters used: $f = 5500$ MHz; $\sigma = 5.69$ mho/m; $\epsilon_r = 49.3$; $\rho = 1000$ kg/m³
Phantom section: Flat Section

Room Ambient Temperature: 25.0 deg. C; Liquid Temperature: 24.0 deg. C

DASY4 Configuration:

- Area Scan setting - Find Secondary Maximum Within: 2.0 dB and with a peak SAR value greater than 0.0012W/kg
- Probe: EX3DV4 - SN3749; ConvF(3.53, 3.53, 3.53); Calibrated: 12/13/2010
- Sensor-Surface: 2.5mm (Mechanical Surface Detection)
- Electronics: DAE3 Sn427; Calibrated: 7/21/2010
- Phantom: Flat Phantom ELI4.0; Type: QDOVA001BA; Serial: SN:XXXX
- Measurement SW: DASY4, V4.7 Build 80; Postprocessing SW: SEMCAD, V1.8 Build 186

5.5GHz, d=10mm, Pin=100mW/Area Scan (7x7x1): Measurement grid: dx=10mm, dy=10mm
Maximum value of SAR (measured) = 15.4 mW/g

5.5GHz, d=10mm, Pin=100mW/Zoom Scan (8x8x10)/Cube 0: Measurement grid: dx=4mm, dy=4mm, dz=2.5mm
Reference Value = 56.8 V/m; Power Drift = 0.005 dB
Peak SAR (extrapolated) = 27.3 W/kg
SAR(1 g) = 8.32 mW/g; SAR(10 g) = 2.38 mW/g
Maximum value of SAR (measured) = 15.1 mW/g

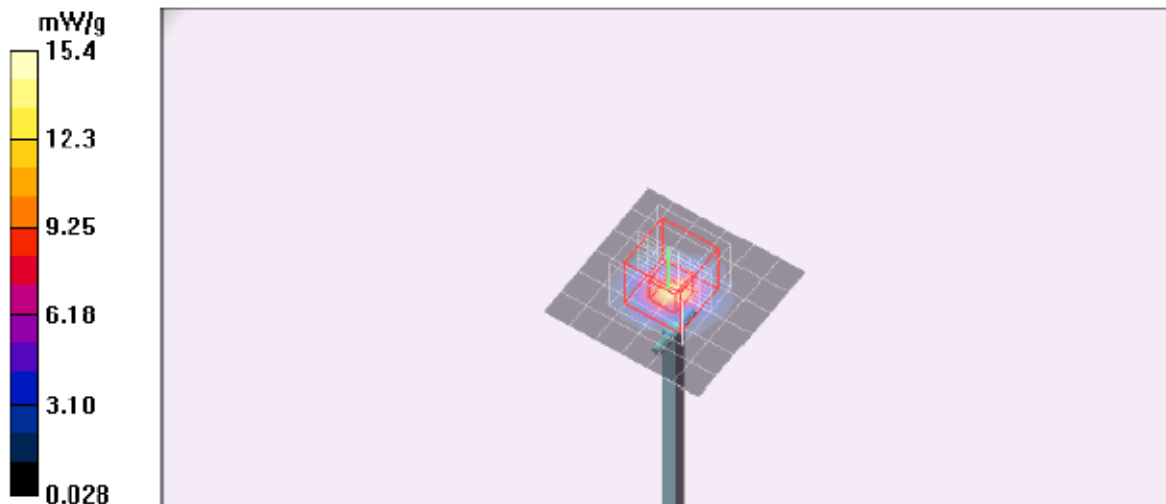

SYSTEM CHECK PLOT for 5.8 GHz band

Date/Time: 1/14/2011 10:04:26 AM

Test Laboratory: Compliance Certification Services (UL CCS)

System Performance Check - D5GHzV2

DUT: Dipole 5200-5800MHz; Type: D5GHzV2; Serial: 1075

Communication System: System Check Signal - CW; Frequency: 5800 MHz; Duty Cycle: 1:1
Medium parameters used: $f = 5800$ MHz; $\sigma = 6$ mho/m; $\epsilon_r = 48.4$; $\rho = 1000$ kg/m³
Phantom section: Flat Section

Room Ambient Temperature: 25.0 deg. C; Liquid Temperature: 24.0 deg. C

DASY4 Configuration:

- Area Scan setting - Find Secondary Maximum Within: 2.0 dB and with a peak SAR value greater than 0.0012W/kg
- Probe: EX3DV4 - SN3749; ConvF(3.65, 3.65, 3.65); Calibrated: 12/13/2010
- Sensor-Surface: 2.5mm (Mechanical Surface Detection)
- Electronics: DAE3 Sn427; Calibrated: 7/21/2010
- Phantom: Flat Phantom ELI4.0; Type: QDOVA001BA; Serial: SN:XXXX
- Measurement SW: DASY4, V4.7 Build 80; Postprocessing SW: SEMCAD, V1.8 Build 186

5.8GHz, d=10mm, Pin=100mW/Area Scan (7x7x1): Measurement grid: dx=10mm, dy=10mm
Maximum value of SAR (measured) = 13.5 mW/g

5.8GHz, d=10mm, Pin=100mW/Zoom Scan (8x8x10)/Cube 0: Measurement grid: dx=4mm, dy=4mm, dz=2.5mm
Reference Value = 52.0 V/m; Power Drift = -0.049 dB
Peak SAR (extrapolated) = 26.5 W/kg
SAR(1 g) = 7.33 mW/g; SAR(10 g) = 2.1 mW/g
Maximum value of SAR (measured) = 13.4 mW/g

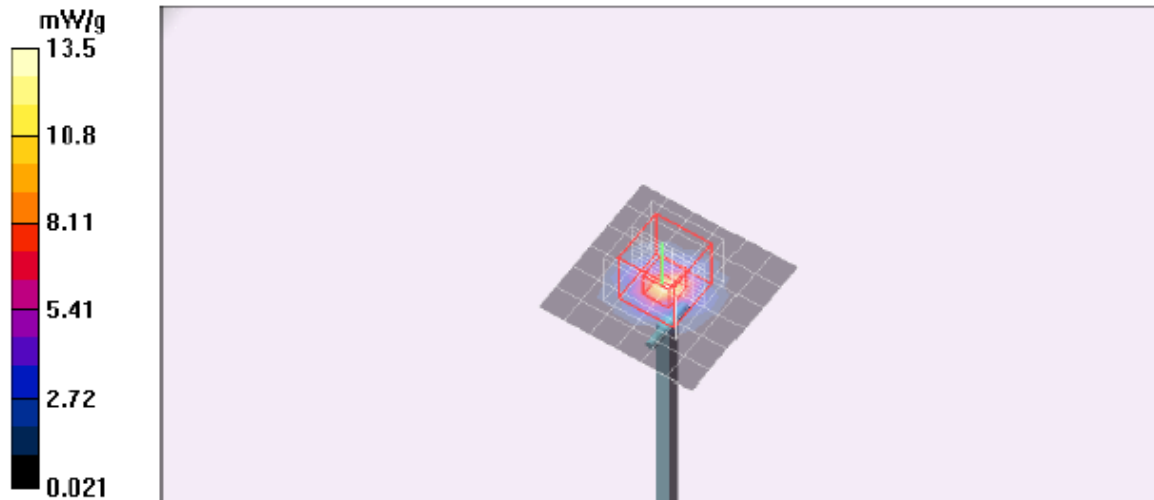

Z-Axis PLOT for 5.8 GHz band

Date/Time: 1/14/2011 10:28:56 AM

Test Laboratory: Compliance Certification Services (UL CCS)

System Performance Check - D5GHzV2

DUT: Dipole 5200-5800MHz; Type: D5GHzV2; Serial: 1075

Communication System: System Check Signal - CW; Frequency: 5800 MHz; Duty Cycle: 1:1

5.8GHz, d=10mm, Pin=100mW/Z Scan (1x1x34): Measurement grid: dx=20mm, dy=20mm, dz=3mm
Maximum value of SAR (measured) = 13.4 mW/g

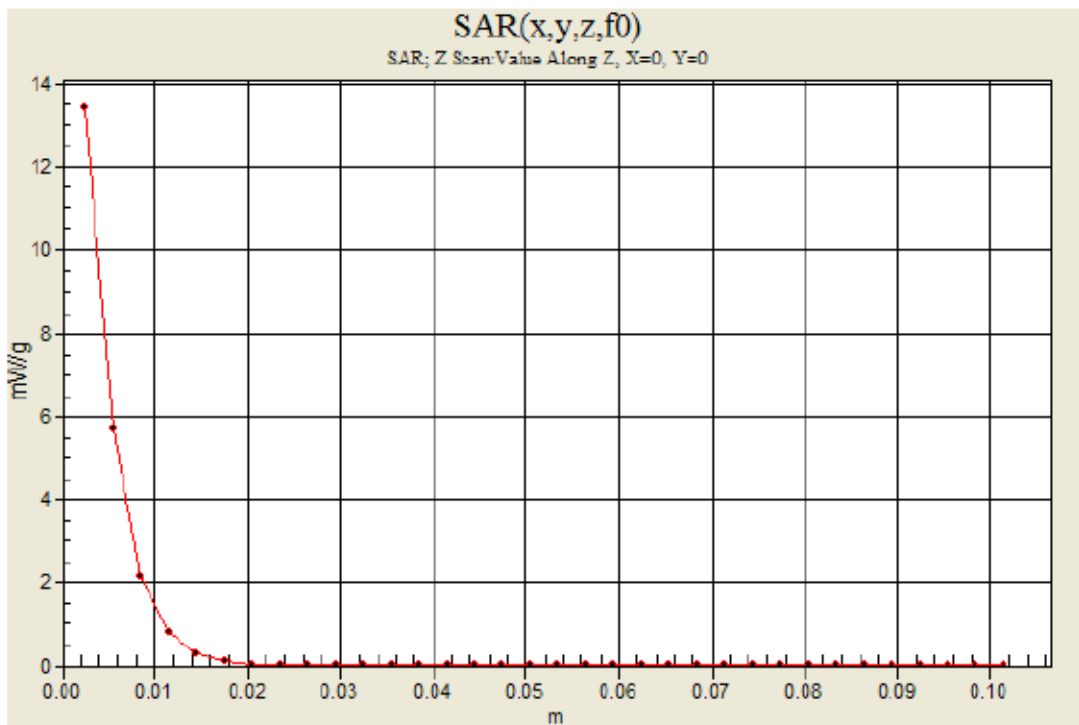

10. SAR MEASUREMENT PROCEDURES

Step 1: Power Reference Measurement

The Power Reference Measurement and Power Drift Measurements are for monitoring the power drift of the device under test in the batch process. The Minimum distance of probe sensors to surface determines the closest measurement point to phantom surface. The minimum distance of probe sensors to surface is 2.1 mm. This distance cannot be smaller than the Distance of sensor calibration points to probe tip as defined in the probe properties (for example, 1.2 mm for an EX3DV3 probe type).

Step 2: Area Scan

The Area Scan is used as a fast scan in two dimensions to find the area of high field values, before doing a fine measurement around the hot spot. The sophisticated interpolation routines implemented in DASY4 software can find the maximum locations even in relatively coarse grids. When an Area Scan has measured all reachable points, it computes the field maximal found in the scanned area, within a range of the global maximum. The range (in dB) is specified in the standards for compliance testing. For example, a 2 dB range is required in IEEE Standard 1528, EN 50361 and IEC 62209 standards, whereby 3 dB is a requirement when compliance is assessed in accordance with the ARIB standard (Japan). If only one Zoom Scan follows the Area Scan, then only the absolute maximum will be taken as reference. For cases where multiple maximums are detected, the number of Zoom Scans has to be increased accordingly.

Step 3: Zoom Scan

Zoom Scans are used to assess the peak spatial SAR values within a cubic averaging volume containing 1 g and 10 g of simulated tissue. The Zoom Scan measures $\geq 7 \times 7 \times 9$ points within a cube whose base faces are centered on the maxima found in a preceding area scan job within the same procedure. When the measurement is done, the Zoom Scan evaluates the averaged SAR for 1 g and 10 g and displays these values next to the job's label.

Step 4: Power drift measurement

The Power Drift Measurement measures the field at the same location as the most recent power reference measurement within the same procedure, and with the same settings. The Power Drift Measurement gives the field difference in dB from the reading conducted within the last Power Reference Measurement. This allows a user to monitor the power drift of the device under test within a batch process. The measurement procedure is the same as Step 1.

Step 5: Z-Scan

The Z Scan measures points along a vertical straight line. The line runs along the Z-axis of a one-dimensional grid. In order to get a reasonable extrapolation, the extrapolated distance should not be larger than the step size in Z-direction.

11. POWER REDUCTION BY SENSING

SAR Testing Considerations & FCC pre-TCB testing guidance KDB 335737

11.1. iPad WIFI Exclusions for SAR Testing

The iPad does not have proximity sensors or back-off capabilities on WiFi.

11.2. Additional SAR Testing for the Back Surface and Top Edge

Based on discussions with the FCC it was determined that additional SAR testing is required. The additional testing required testing at a conservative distance from the iPad with the power back-off disabled via special development software. Details about the proximity sensor operation, and special development software are included in a separate document titled "Operational Description".

Proximity Sensor Status Table – Back Surface In Conservative Proximity Sensor Operation

Distance to Back Surface of iPad (mm)	8.0	9.0	10.0	11.0	12.0	13.0	14.0	15.0
Proximity Sensor Status	ON	ON	ON	OFF	OFF	OFF	OFF	OFF

Proximity Sensor Status Table –Top Edge Secondary Portrait In Conservative Proximity Sensor Operation

Distance to Top Edge of iPad (mm)	8.5	9.5	10.5	11.5	12.5	13.5	14.5	15.5
Proximity Sensor Status	ON	ON	OFF	OFF	OFF	OFF	OFF	OFF

11.3. Method of SAR Measurement With and Without Back-off Enabled

Based on the above proximity sensor activation vs. distance results, the iPad was tested at zero spacing, back-off enabled and additionally at a conservative test distance of 9.5 mm on the top edge and 10 mm on back surface with back-off disabled (maximum power).

To test SAR with back-off enabled at zero spacing, the iPad was placed in maximum power transmit mode (with back-off enabled) with a base station simulator. The device was then positioned under the tissue equivalent liquid-filled flat phantom at zero distance.

To test SAR with back-off disabled at 9.5 mm, the iPad utilized special development software. The ability to disable the back-off is not available in the production release of software. The device was placed in maximum power transmit mode with a base station simulator. The iPad was then positioned under the tissue equivalent liquid-filled flat phantom at a distance of 9.5mm when in the "Top Edge – Secondary Portrait" orientation and at 10mm when in "Tablet Mode-Back surface" and tested with the back-off disabled.

(Please refer to Cetecom SAR Test Report No: SAR_APPLE_070_FCC for SAR evaluation at Back Surface with 10 mm distance and Top Edge/ Secondary Portrait with 9.5 mm with special development software to disable power back-off)

Summary table of the test results form Cetecom SAR Test Report

8.4. SAR results

Position	Band	Operation Mode	Channel	Frequency (MHz)	SAR 1g (W/kg)	Area Scan (Appendix A)	Positioning Photo (Appendix B)
Back surface (10mm)	Cell	1xRTT	384	836.52	0.564	Plot 1	Photo 1
		EV-DO Release 0	384	836.52	0.522	Plot 2	Photo 1
	PCS	1xRTT	600	1880	0.577	Plot 3	Photo 1
		EV-DO Release 0	600	1880	0.639	Plot 4	Photo 1
Top Edge (9.5mm)	Cell	1xRTT	384	836.52	0.383	Plot 5	Photo 2
		EV-DO Release 0	384	836.52	0.353	Plot 6	Photo 2
	PCS	1xRTT	25	1851.25	1.04	Plot 7	Photo 2
			60	1880	1.19	Plot 8	Photo 2
			1175	1908.75	1.4	Plot 9	Photo 2
	PCS	EV-DO Release 0	25	1851.25	1.04	Plot 10	Photo 2
			60	1880	1.18	Plot 11	Photo 2
			1175	1908.75	1.42	Plot 12	Photo 2

11.4. Summary Table of Power Reduction dB Levels per Mode and Band

A1397 Sensor, Back Surface																	
Distance in mm	0	1	2	3	4	5	6	7	8	9	10	11	12	13	14	15	16
Proximity sensor with reduced power activation	ON	ON	ON	ON	ON	ON	ON	ON	ON	ON	ON	OFF	OFF	OFF	OFF	OFF	OFF
1xRTT / Cellular Band /dBm (by 4 dB)	20.50	20.50	20.50	20.50	20.50	20.50	20.50	20.50	20.50	20.50	20.50	24.5	24.5	24.5	24.5	24.5	24.5
EVDO Rev. 0 / Cellular Band /dBm (by 4 dB)	20.3	20.3	20.3	20.3	20.3	20.3	20.3	20.3	20.3	20.3	20.3	24.3	24.3	24.3	24.3	24.3	24.3
EVDO Rev. A / Cellular Band / dBm (by 4 dB)	20.3	20.3	20.3	20.3	20.3	20.3	20.3	20.3	20.3	20.3	20.3	24.2	24.2	24.2	24.2	24.2	24.2
1xRTT / PCS Band / dBm (by 7 dB)	16.4	16.4	16.4	16.4	16.4	16.4	16.4	16.4	16.4	16.4	16.4	23.4	23.4	23.4	23.4	23.4	23.4
EVDO Rev. 0 / PCS Band /dBm (by 6.5 dB)	16.5	16.5	16.5	16.5	16.5	16.5	16.5	16.5	16.5	16.5	16.5	23	23	23	23	23	23
EVDO Rev. A / PCS Band / dbm (by 6.8 dB)	16.2	16.2	16.2	16.2	16.2	16.2	16.2	16.2	16.2	16.2	16.2	23	23	23	23	23	23

A1397 Sensor, Top Edge / Secondary Portrait																	
Distance in mm	0	0.5	1.5	2.5	3.5	4.5	5.5	6.5	7.5	8.5	9.5	10.5	11.5	12.5	13.5	14.5	15.5
Proximity sensor with reduced power activation	ON	ON	ON	ON	ON	ON	ON	ON	ON	ON	ON	OFF	OFF	OFF	OFF	OFF	OFF
1xRTT / Cellular Band /dBm (by 4 dB)	20.50	20.50	20.50	20.50	20.50	20.50	20.50	20.50	20.50	20.50	20.50	24.5	24.5	24.5	24.5	24.5	24.5
EVDO Rev. 0 / Cellular Band /dBm (by 4 dB)	20.3	20.3	20.3	20.3	20.3	20.3	20.3	20.3	20.3	20.3	20.3	24.3	24.3	24.3	24.3	24.3	24.3
EVDO Rev. A / Cellular Band / dBm (by 4 dB)	20.3	20.3	20.3	20.3	20.3	20.3	20.3	20.3	20.3	20.3	20.3	24.2	24.2	24.2	24.2	24.2	24.2
1xRTT / PCS Band / dBm (by 7 dB)	16.4	16.4	16.4	16.4	16.4	16.4	16.4	16.4	16.4	16.4	16.4	23.4	23.4	23.4	23.4	23.4	23.4
EVDO Rev. 0 / PCS Band /dBm (by 6.5 dB)	16.5	16.5	16.5	16.5	16.5	16.5	16.5	16.5	16.5	16.5	16.5	23	23	23	23	23	23
EVDO Rev. A / PCS Band / dbm (by 6.8 dB)	16.2	16.2	16.2	16.2	16.2	16.2	16.2	16.2	16.2	16.2	16.2	23	23	23	23	23	23

12. RF OUTPUT POWER VERIFICATION

Maximum output power is verified on the Low, Middle and High channels according to procedures in section 4.4.5.2 of 3GPP2 C.S0011/TIA-98-E for 1xRTT, section 3.1.2.3.4 of 3GPP2 C.S0033-0/TIA-866 for Rel. 0 and section 4.3.4 of 3GPP2 C.S0033-A for Rev. A

12.1. WWAN

CDMA2000 1xRTT

This procedure assumes the Agilent 8960 Test Set has the following applications installed and with valid license.

Application Rev. License
CDMA2000 Mobile Test B.13.08, L

- Protocol Rev > 6 (IS-2000-0)
- System ID: 28 (Cell) & 18 (PCS); NID: 65535 (Cell & PCS); Reg. Ch. #: 384 (Cell) & 600 (PCS)
- Radio Config (RC) > Please see following table for details
- FCH Service Option (SO) Setup > Please see following table or details
- Traffic Data Rate > Full
- TDSO SCH Info > F-SCH Parameters > F-SCH Data Rate > 153.6 kbps
> R-SCH Parameters > R-SCH Data Rate > 153.6 kbps
- Rvs Power Ctrl > All Up bits (Maximum TxPout)

RF Output Power for Cellular Band

Radio Configuration (RC)	Service Option (SO)	Conducted Output Power (dBm)		
		Ch. 1013/824.7 MHz	Ch. 384/836.52 MHz	Ch. 777/848.31 MHz
		Average	Average	Average
RC1	55 (Loopback)	24.5	24.5	24.5
RC3	55 (Loopback)	24.6	24.5	24.6
	32 (+ F-SCH)	24.5	24.5	24.6
With proximity sensor activated with power back-off				
RC1	55 (Loopback)	20.5	20.5	20.4
RC3	55 (Loopback)	20.4	20.5	20.4
	32 (+ F-SCH)	20.5	20.6	20.4

RF Output Power for PCS Band

Radio Configuration (RC)	Service Option (SO)	Conducted Output Power (dBm)		
		Ch. 25/1851.25 MHz	Ch. 600/1880 MHz	Ch. 1175/1908.75 MHz
		Average	Average	Average
RC1	55 (Loopback)	23.3	23.3	23.3
RC3	55 (Loopback)	23.4	23.4	23.5
	32 (+ F-SCH)	23.4	23.4	23.5
With proximity sensor activated with power back-off				
RC1	55 (Loopback)	16.4	16.4	16.5
RC3	55 (Loopback)	16.5	16.4	16.5
	32 (+ F-SCH)	16.5	16.5	16.6

1xEV-Do - Release 0 (Rel. 0)

This procedure assumes the Agilent 8960 Test Set has the following applications installed and with valid license.

EVDO Release 0 - RTAP

- Call Setup > Shift & Preset
- Call Control:
 - Access Network Info > Cell Parameters > Sector ID > 00000000 : 00000000 : 00000000 : 00000000 > Subnet Mask > 0
 - Generator Info > Termination Parameters > Max Forward Packet Duration > 16 Slots
- Call Parm:
 - Cell Power > -105.5 dBm/1.23 MHz
 - Cell Band > (Select US Cellular or US PCS)
 - Channel > (Enter channel number)
 - Application Config > Enhanced Test Application Protocol > RTAP
 - RTAP Rate > 153.6 kbps
 - Rvs Power Ctrl > Active bits
 - Protocol Rel > 0 (1xEV-DO)
- Press “Start Data Connection” when “Session Open” appear in “Active Cell”
- Rvs Power Ctrl > All Up bits (Maximum TxPout)

EVDO Release 0 - FTAP

- Call Setup > Shift & Preset
- Call Control:
 - Access Network Info > Cell Parameters > Sector ID > 00000000 : 00000000 : 00000000 : 00000000 > Subnet Mask > 0
 - Generator Info > Termination Parameters > Max Forward Packet Duration > 16 Slots
- Call Parm:
 - Cell Power > -105.5 dBm/1.23 MHz
 - Cell Band > (Select US Cellular or US PCS)
 - Channel > (Enter channel number)
 - Application Config > Enhanced Test Application Protocol > FTAP (default)
 - FTAP Rate > 307.2 kbps (2 Slot, QPSK)
 - Rvs Power Ctrl > Active bits
 - Protocol Rel > 0 (1xEV-DO)
- Press “Start Data Connection” when “Session Open” appear in “Active Cell”
- Rvs Power Ctrl > All Up bits (Maximum TxPout)

RF Power Output for EV-DO Rel 0

Band	FTAP Rate	RTAP Rate	Channel	f (MHz)	Tx Conducted Power (dBm)	
					Avg Pwr	with proximity sensor power Back-off
Cellular	307.2 kbps (2 slot, QPSK)	153.6 kbps	1013	824.70	24.1	20.3
			384	836.52	24.1	20.3
			777	848.31	24.3	20.4
PCS	307.2 kbps (2 slot, QPSK)	153.6 kbps	25	1851.25	23.0	16.5
			600	1880.00	23.0	16.5
			1175	1908.75	23.1	16.6

1xEV-Do - Revision A (Rev. A)

This procedure assumes the Agilent 8960 Test Set has the following applications installed and with valid license.

<u>Application</u>	<u>Rev, License</u>
1xEV-DO Terminal Test	A.09.13

EVDO Rev. A – RETAP

- Call Setup > Shift & Preset
- Cell Power > -60 dBm/1.23 MHz
- Protocol Rev > A (1xEV-DO-A)
- Application Config > Enhanced Test Application Protocol > RETAP
- R-Data Pkt Size > 4096
- Protocol Subtype Config > Release A Physical Layer Subtype > Subtype 2
- > PL Subtype 2 Access Channel MAC Subtype > Default (Subtype 0)
- Access Network Info > Cell Parameters > Sector ID > 00000000: 00000000: 00000000: 00000000
> Subnet Mask > 0
- Generator Info > Termination Parameters > Max Forward Packet Duration >16 Slots
> ACK R-Data After > Subpacket 0 (All ACK)
- Rvs Power Ctrl > All Up bits (to get the maximum power)

EVDO Rev. A - FETAP

- Call Setup > Shift & Preset
- Cell Power > -60 dBm/1.23 MHz
- Protocol Rev > A (1xEV-DO-A)
- Application Config > Enhanced Test Application Protocol > FETAP
- F-Traffic Format > 4 (1024, 2,128) Canonical (307.2k, QPSK)
- Protocol Subtype Config > Release A Physical Layer Subtype > Subtype 2
- > PL Subtype 2 Access Channel MAC Subtype > Default (Subtype 0)
- Access Network Info > Cell Parameters > Sector ID > 00000000: 00000000: 00000000: 00000000
> Subnet Mask > 0
- Generator Info > Termination Parameters > Max Forward Packet Duration >16 Slots
> ACK R-Data After > Subpacket 0 (All ACK)
- Rvs Power Ctrl > All Up bits (to get the maximum power)

Band	FETAP Traffic Format	RETAP Data Payload Size	Channel	f (MHz)	Tx Conducted Power (dBm)	
					Avg Pwr	with proximity sensor power Back-off
Cellular	307.2k, QPSK/ ACK channel is transmitted at all the slots	4096	1013	824.70	24.2	20.3
			384	836.52	24.1	20.3
			777	848.31	24.2	20.3
PCS	307.2k, QPSK/ ACK channel is transmitted at all the slots	4096	25	1851.25	22.9	16.4
			600	1880.00	22.9	16.5
			1175	1908.75	23.0	16.5

12.2. WiFi

The following procedures had been used to prepare the EUT for the SAR test. The client provided a special driver and program, wl_tools, which enable then engineer to control the frequency and output power of the module. Such program is not accessible by the end user.

802.11bg mode (2.4 GHz band)

Mode	Channel	Freq. (MHz)	Avg Pwr (dBm)
802.11b	1	2412	15.5
	6	2437	15.8
	11	2462	15.6
802.11g	1	2412	14.0
	6	2437	15.7
	11	2462	15.0
802.11n (HT20)	1	2412	13.0
	6	2437	15.5
	11	2462	14.0

Note: KDB 248227 - SAR is not required for 802.11g /HT20 channels when the maximum average output power is less than 1/4 dB higher than that measured on the corresponding 802.11b channels.

802.11a mode

Band	Mode	Channel	Freq. (MHz)	Avg Pwr (dBm)
5.2 GHz	802.11a	36	5180	15.5
		40	5200	15.7
		48	5240	15.7
5.3 GHz	802.11a	52	5260	15.6
		60	5300	15.6
		64	5320	15.7
5.6 GHz	802.11a	100	5500	15.6
		120	5600	15.7
		140	5700	15.6
5.8 GHz	802.11a	149	5745	17.0
		157	5785	17.1
		165	5825	17.0

802.11n HT20

Band	Mode	Channel	Freq. (MHz)	Avg Pwr (dBm)
5.2 GHz	802.11n HT20	36	5180	14.0
		40	5200	14.0
		48	5240	14.0
5.3 GHz	802.11n HT20	52	5260	15.5
		60	5300	15.5
		64	5320	15.5
5.6 GHz	802.11n HT20	100	5500	15.5
		120	5600	15.5
		140	5700	15.5
5.8 GHz	802.11n HT20	149	5745	17.0
		157	5785	17.0
		165	5825	17.0

13. SUMMARY OF SAR TEST RESULTS

13.1. WWAN (CDMA2000)

Back Surface - With Proximity sensor activated with power back-off

Direct contact / 0 cm distance between EUT and Flat Phantom (WWAN Main antenna-to-user distance: 8 mm).

Band	Mode	Ch No.	f (MHz)	Avg Pwr	SAR (mW/g)	
				(dBm)	1-g	10-g
Cellular	1x RTT (RC3, SO32)	1013	824.70	20.5	0.938	0.511
		384	836.52	20.6	1.100	0.602
		777	848.31	20.4	1.100	0.602
	1x EV-DO Release 0	1013	824.70	20.3	0.960	0.523
		384	836.52	20.3	1.090	0.594
		777	848.31	20.4	1.140	0.622
Band	Mode	Ch No.	f (MHz)	Avg Pwr	SAR (mW/g)	
				(dBm)	1-g	10-g
PCS	1x RTT (RC3, SO32)	25	1851.25	16.5		
		600	1880.00	16.5	0.786	0.370
		1175	1908.75	16.6		
	1x EV-DO Release 0	25	1851.25	16.5	0.639	0.304
		600	1880.00	16.5	0.924	0.437
		1175	1908.75	16.6	1.150	0.541

Primary Landscape

Direct Contact / 0 cm distance between EUT and Flat Phantom (WWAN Main antenna-to-user distance: 35.3 mm).

Band	Mode	Ch No.	f (MHz)	Avg Pwr	SAR (mW/g)	
				(dBm)	1-g	10-g
Cellular	1x RTT (RC3, SO32)	384	836.52	24.5	0.111	0.062
	1x EV-DO Release 0	384	836.52	24.1	0.135	0.075
Band	Mode	Ch No.	f (MHz)	Avg Pwr	SAR (mW/g)	
				(dBm)	1-g	10-g
PCS	1x RTT (RC3, SO32)	600	1880.00	23.4	0.033	0.016
	1x EV-DO Release 0	600	1880.00	23.0	0.030	0.014

Secondary Landscape

Direct contact / 0 cm distance between EUT and Flat Phantom. (WWAN Main antenna-to-user distance: 100 mm).

Band	Mode	Ch No.	f (MHz)	Avg Pwr	SAR (mW/g)	
				(dBm)	1-g	10-g
Cellular	1x RTT (RC3, SO32)	384	836.52	24.5	0.028	0.015
	1x EV-DO Release 0	384	836.52	24.1	0.026	0.014
Band	Mode	Ch No.	f (MHz)	Avg Pwr	SAR (mW/g)	
				(dBm)	1-g	10-g
PCS	1x RTT (RC3, SO32)	600	1880.00	23.4	0.091	0.048
	1x EV-DO Release 0	600	1880.00	23.0	0.070	0.037

Primary Portrait (No SAR)

With 227 mm separation distance from WWAN Main antenna-to-user.

Note: This is not the most conservative antenna-to-user distance at edge mode. According to KDB 447498 4) b) ii) (2), SAR is required only for the edge with the most conservative exposure conditions.

Secondary Portrait / Top Edge - With Proximity sensor activated with power back-off

Direct Contact / 0 cm distance between EUT and Flat Phantom (WWAN Main antenna-to-user distance: 3.68 mm).

Band	Mode	Ch No.	f (MHz)	Avg Pwr	SAR (mW/g)	
				(dBm)	1-g	10-g
Cellular	1x RTT (RC3, SO32)	1013	824.70	20.5	0.765	0.402
		384	836.52	20.6	0.873	0.441
		777	848.31	20.4	1.020	0.529
	1x EV-DO Release 0	1013	824.70	20.3	0.741	0.390
		384	836.52	20.3	0.846	0.423
		777	848.31	20.4	1.020	0.533
Band	Mode	Ch No.	f (MHz)	Avg Pwr	SAR (mW/g)	
				(dBm)	1-g	10-g
PCS	1x RTT (RC3, SO32)	25	1851.25	16.5		
		600	1880.00	16.5	0.697	0.340
		1175	1908.75	16.6		
	1x EV-DO Release 0	25	1851.25	16.5		
		600	1880.00	16.5	0.584	0.286
		1175	1908.75	16.6		

Worst-case SAR Test Plots for Cellular Band (Part 22)

Date/Time: 1/26/2011 7:00:43 AM

Test Laboratory: Compliance Certification Services (UL CCS)

Bottom face_Cell band

DUT: Apple; Type: NA; Serial: NA

Communication System: CDMA Cell Band; Frequency: 848.31 MHz; Duty Cycle: 1:1
Medium parameters used (interpolated): $f = 848.31$ MHz; $\sigma = 1.01$ mho/m; $\epsilon_r = 54.9$; $\rho = 1000$ kg/m³
Phantom section: Flat Section

Room Ambient Temperature: 24.0 deg. C; Liquid Temperature: 23.0 deg. C

DASY4 Configuration:

- Area Scan setting - Find Secondary Maximum Within: 2.0 dB and with a peak SAR value greater than 0.0012W/kg
- Probe: EX3DV4 - SN3749; ConvF(8.79, 8.79, 8.79); Calibrated: 12/13/2010
- Sensor-Surface: 3mm (Mechanical Surface Detection)
- Electronics: DAE3 Sn427; Calibrated: 7/21/2010
- Phantom: SAM 2 (Twin); Type: SAM 2; Serial: 1050
- Measurement SW: DASY4, V4.7 Build 80; Postprocessing SW: SEMCAD, V1.8 Build 186

EV-DO Rel. 0_H ch/Area Scan (8x5x1): Measurement grid: dx=15mm, dy=15mm

[Info: Interpolated medium parameters used for SAR evaluation.](#)

Maximum value of SAR (measured) = 1.28 mW/g

EV-DO Rel. 0_H ch/Zoom Scan (7x7x9)/Cube 0: Measurement grid: dx=5mm, dy=5mm, dz=3mm

Reference Value = 35.8 V/m; Power Drift = -0.118 dB

Peak SAR (extrapolated) = 2.21 W/kg

SAR(1 g) = 1.14 mW/g; SAR(10 g) = 0.622 mW/g

[Info: Interpolated medium parameters used for SAR evaluation.](#)

Maximum value of SAR (measured) = 1.44 mW/g

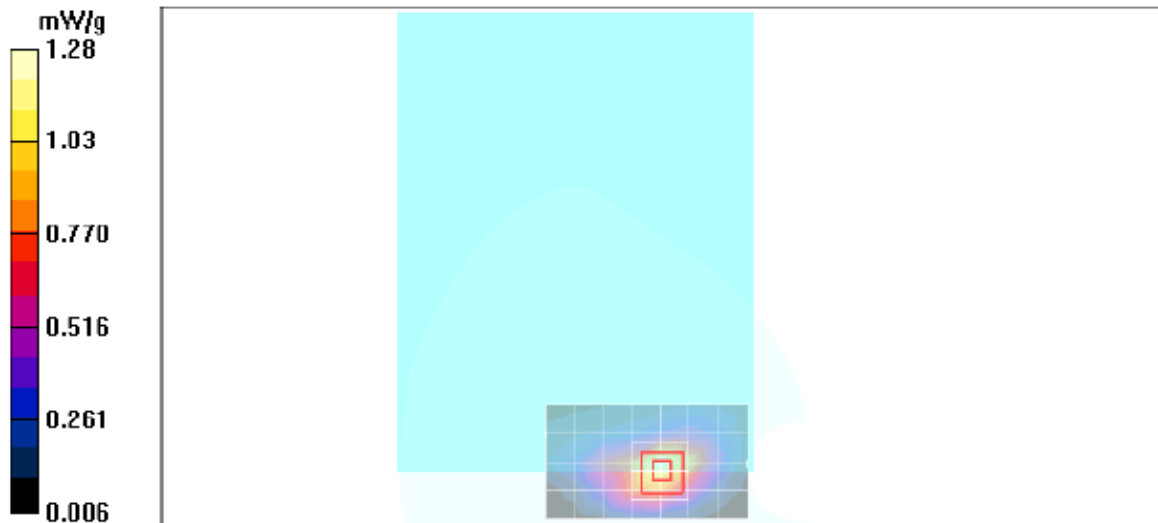

Date/Time: 1/26/2011 7:18:21 AM

Test Laboratory: Compliance Certification Services (UL CCS)

Bottom face_Cell band

DUT: Apple; Type: NA; Serial: NA

Communication System: CDMA Cell Band; Frequency: 848.31 MHz; Duty Cycle: 1:1

EV-DO Rel. 0_H ch/Z Scan (1x1x29): Measurement grid: dx=20mm, dy=20mm, dz=3.5mm

[Info: Interpolated medium parameters used for SAR evaluation.](#)

Maximum value of SAR (measured) = 1.44 mW/g

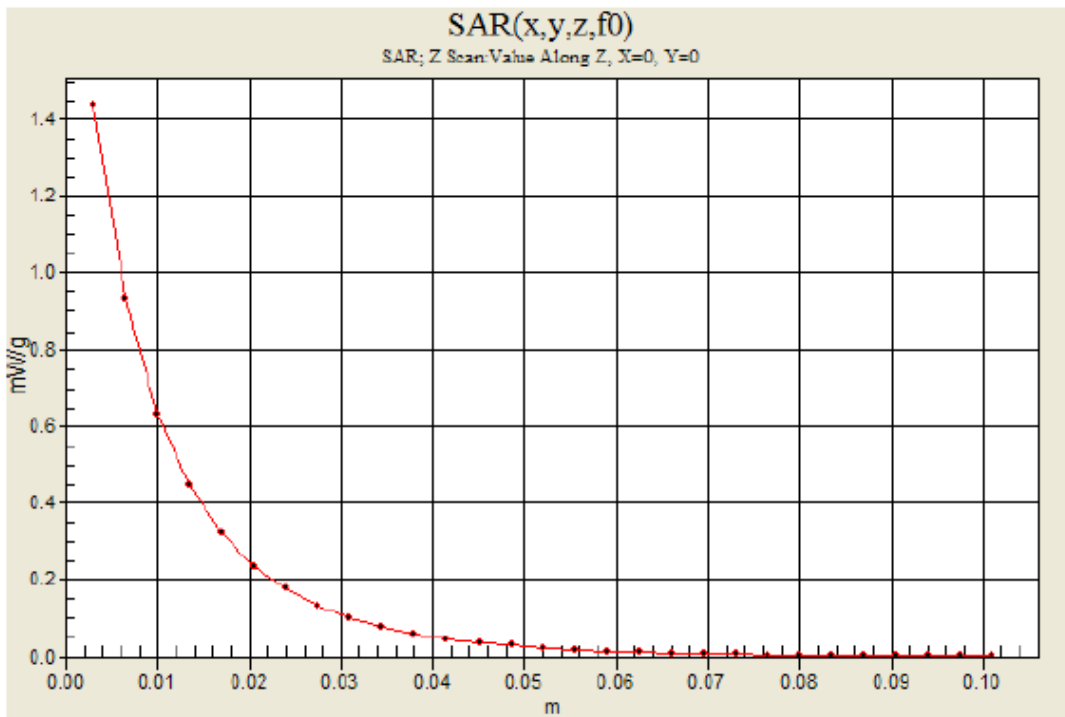

Worst-case SAR Test Plots for PCS Band (Part 24)

Date/Time: 1/27/2011 12:41:36 AM

Test Laboratory: Compliance Certification Services (UL CCS)

Bottom face_PCS band

DUT: Apple; Type: NA; Serial: NA

Communication System: CDMA PCS Band; Frequency: 1908.75 MHz; Duty Cycle: 1:1
Medium parameters used (interpolated): $f = 1908.75$ MHz; $\sigma = 1.49$ mho/m; $\epsilon_r = 53.8$; $\rho = 1000$ kg/m³
Phantom section: Flat Section

Room Ambient Temperature: 24.0 deg. C; Liquid Temperature: 23.0 deg. C

DASY4 Configuration:

- Area Scan setting - Find Secondary Maximum Within: 2.0 dB and with a peak SAR value greater than 0.0012W/kg
- Probe: EX3DV4 - SN3749; ConvF(7.33, 7.33, 7.33); Calibrated: 12/13/2010
- Sensor-Surface: 3mm (Mechanical Surface Detection)
- Electronics: DAE3 Sn427; Calibrated: 7/21/2010
- Phantom: Flat Phantom ELI4.0; Type: QDOVA001BA; Serial: SN:1003
- Measurement SW: DASY4, V4.7 Build 80; Postprocessing SW: SEMCAD, V1.8 Build 186

EV-DO Rel. 0_H ch/Area Scan (8x5x1): Measurement grid: dx=15mm, dy=15mm

[Info: Interpolated medium parameters used for SAR evaluation.](#)

Maximum value of SAR (measured) = 1.35 mW/g

EV-DO Rel. 0_H ch/Zoom Scan (7x7x9)/Cube 0: Measurement grid: dx=5mm, dy=5mm, dz=3mm

Reference Value = 30.4 V/m; Power Drift = -0.188 dB

Peak SAR (extrapolated) = 2.46 W/kg

SAR(1 g) = 1.15 mW/g; SAR(10 g) = 0.541 mW/g

[Info: Interpolated medium parameters used for SAR evaluation.](#)

Maximum value of SAR (measured) = 1.53 mW/g

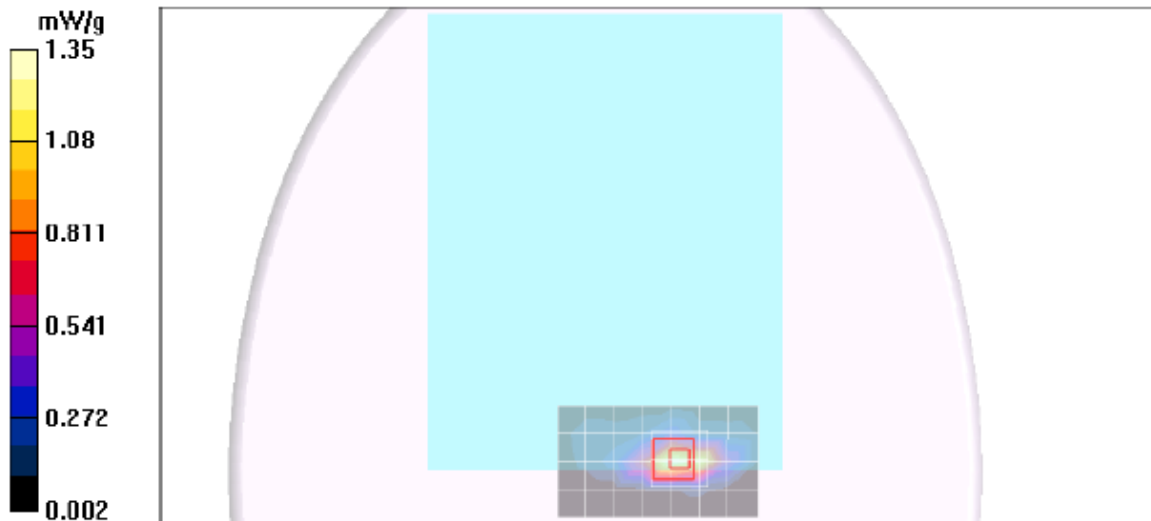

Date/Time: 1/27/2011 12:59:29 AM

Test Laboratory: Compliance Certification Services (UL CCS)

Bottom face_PCS band

DUT: Apple; Type: NA; Serial: NA

Communication System: CDMA PCS Band; Frequency: 1908.75 MHz; Duty Cycle: 1:1

EV-DO Rel. 0_H ch/Z Scan (1x1x29): Measurement grid: dx=20mm, dy=20mm, dz=3.5mm

Info: [Interpolated medium parameters used for SAR evaluation.](#)

Maximum value of SAR (measured) = 1.54 mW/g

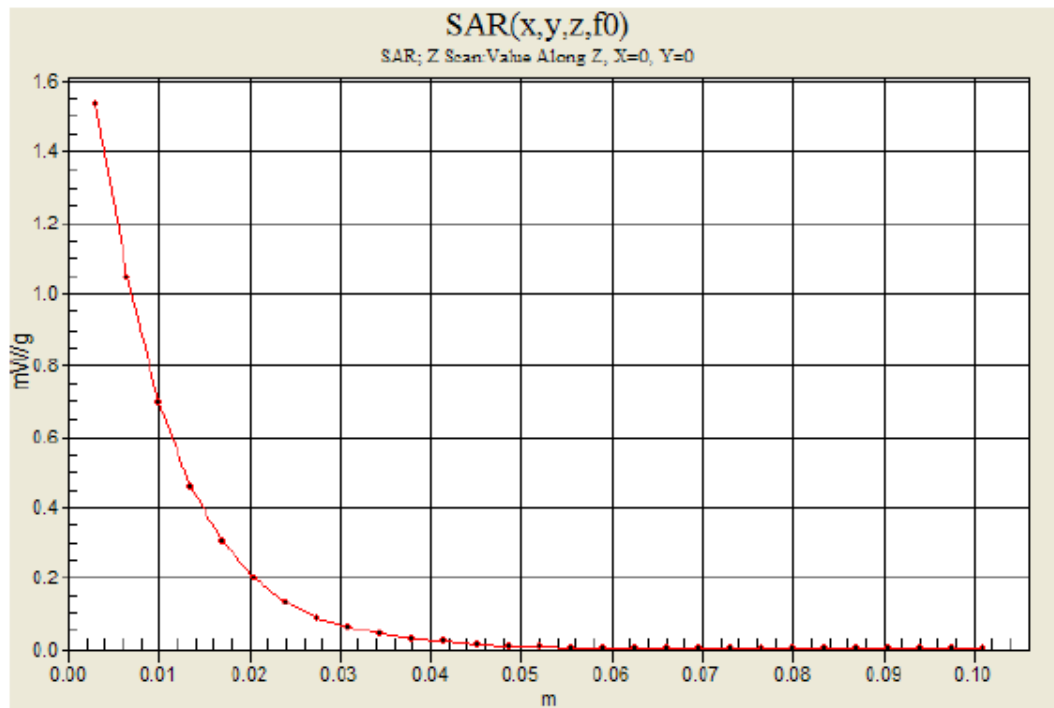

13.2. 2.4 GHz BAND

Back Surface

Direct Contact / 0 cm distance between EUT and Flat Phantom (WiFi/BT antenna-to-user distance : 8 mm).

Mode	Channel	f (MHz)	Avg Pwr	Results (mW/g)	
			(dBm)	1g-SAR	10g-SAR
802.11b	6	2437	15.7	0.072	0.035

Primary Landscape

Direct Contact / 0 cm distance between EUT and Flat Phantom (WiFi/BT antenna-to-user distance: 44.6 mm).

Mode	Channel	f (MHz)	Avg Pwr	Results (mW/g)	
			(dBm)	1g-SAR	10g-SAR
802.11b	6	2437	15.7	0.042	0.020

Secondary Landscape (No SAR)

With 112 mm separation distance from WiFi/BT antenna-to-user.

Note: This is not the most conservative antenna-to-user distance at edge mode. According to KDB 447498 4) b) ii) (2), SAR is required only for the edge with the most conservative exposure conditions.

Primary Portrait

Direct Contact / 0 cm distance between EUT and Flat Phantom(WiFi/BT antenna-to-user distance: 3.75 mm).

Mode	Channel	f (MHz)	Avg Pwr	Results (mW/g)	
			(dBm)	1g-SAR	10g-SAR
802.11b	1	2412	15.5	1.040	0.352
	6	2437	15.7	1.050	0.353
	11	2462	15.6	0.909	0.306

Secondary Portrait / Top Edge (No SAR)

Separation distance: 227 mm from WiFi/BT antenna-to-phantom

Note: This is not the most conservative antenna-to-user distance at edge mode. According to KDB 447498 4) b) ii) (2), SAR is required only for the edge with the most conservative exposure conditions.

Worst-case SAR Test Plots for 2.4 GHz

Date/Time: 1/17/2011 3:51:02 PM

Test Laboratory: Compliance Certification Services (UL CCS)

11b_Primary portrait

DUT: Apple; Type: NA; Serial: NA

Communication System: 802.11bgn; Frequency: 2437 MHz; Duty Cycle: 1:1
Medium parameters used (interpolated): $f = 2437$ MHz; $\sigma = 1.98$ mho/m; $\epsilon_r = 52.1$; $\rho = 1000$ kg/m³
Phantom section: Flat Section
Room Ambient Temperature: 24.0 deg. C; Liquid Temperature: 23.0 deg. C

DASY4 Configuration:

- Area Scan setting - Find Secondary Maximum Within: 2.0 dB and with a peak SAR value greater than 0.0012W/kg
- Probe: EX3DV4 - SN3749; ConvF(6.9, 6.9, 6.9); Calibrated: 12/13/2010
- Sensor-Surface: 3mm (Mechanical Surface Detection)
- Electronics: DAE3 Sn427; Calibrated: 7/21/2010
- Phantom: Flat Phantom ELI4.0; Type: QDOVA001BA; Serial: SN:1003
- Measurement SW: DASY4, V4.7 Build 80; Postprocessing SW: SEMCAD, V1.8 Build 186

802.11b M-ch/Area Scan (5x6x1): Measurement grid: dx=15mm, dy=15mm

Info: [Interpolated medium parameters used for SAR evaluation.](#)

Maximum value of SAR (measured) = 0.970 mW/g

802.11b M-ch/Zoom Scan (7x7x9)/Cube 0: Measurement grid: dx=5mm, dy=5mm, dz=3mm

Reference Value = 22.7 V/m; Power Drift = -0.144 dB

Peak SAR (extrapolated) = 3.37 W/kg

SAR(1 g) = 1.05 mW/g; SAR(10 g) = 0.353 mW/g

Info: [Interpolated medium parameters used for SAR evaluation.](#)

Maximum value of SAR (measured) = 1.65 mW/g

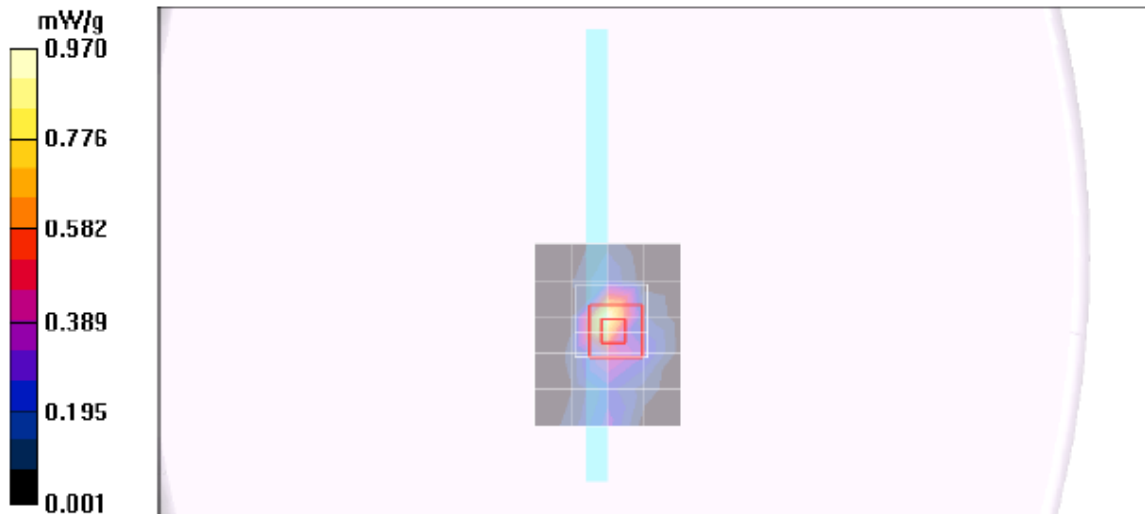

Date/Time: 1/17/2011 4:08:21 PM

Test Laboratory: Compliance Certification Services (UL CCS)

11b_Primary portrait

DUT: Apple; Type: NA; Serial: NA

Communication System: 802.11bgn; Frequency: 2437 MHz; Duty Cycle: 1:1

802.11b M-ch/Z Scan (1x1x29): Measurement grid: dx=20mm, dy=20mm, dz=3.5mm

Info: Interpolated medium parameters used for SAR evaluation.

Maximum value of SAR (measured) = 1.65 mW/g

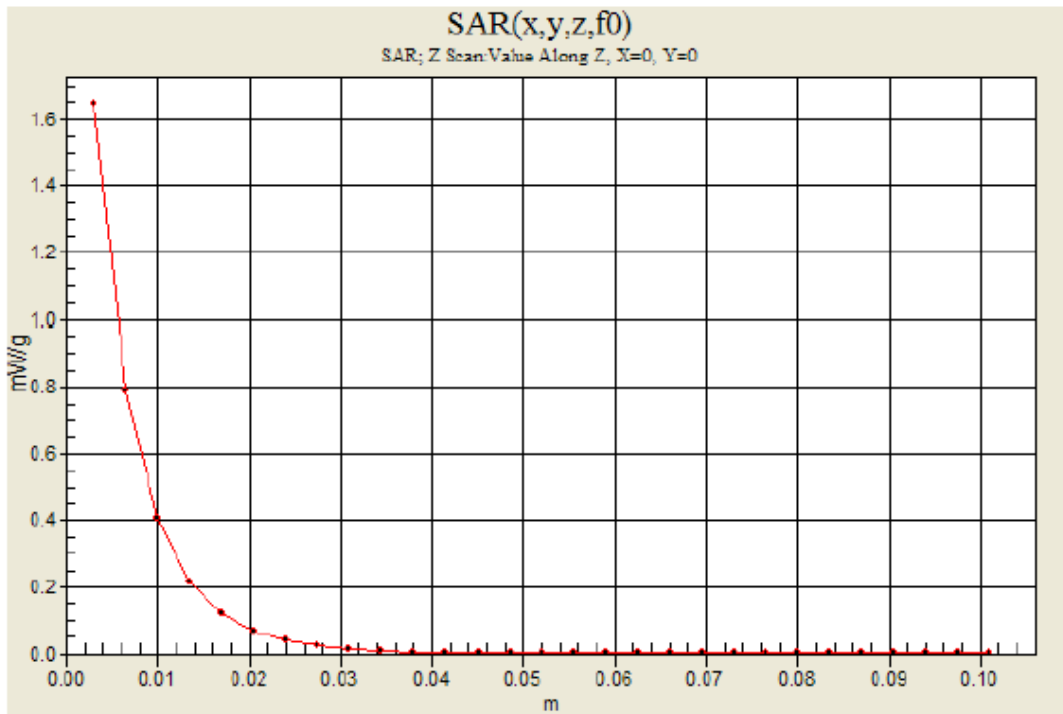

13.3. 5 GHz BANDS

Back Surface

Direct Contact / 0 cm distance between EUT and Flat Phantom (WiFi/BT antenna-to-user distance 8 mm).

Band	Mode	Channel	f (MHz)	Avg Pwr	Results (mW/g)	
				(dBm)	1g-SAR	10g-SAR
5.2 GHz	802.11a Legacy	40	5200	15.7	0.055	0.023
5.3 GHz	802.11a Legacy	60	5300	15.6	0.053	0.022
5.6 GHz	802.11a Legacy	120	5600	15.7	0.088	0.032
5.8 GHz	802.11a Legacy	157	5785	17.1	0.061	0.027

Primary Landscape

Direct Contact / 0 cm distance between EUT and Flat Phantom (WiFi/BT antenna-to-user distance: 44.6 mm).

Band	Mode	Channel	f (MHz)	Avg Pwr	Results (mW/g)	
				(dBm)	1g-SAR	10g-SAR
5.2 GHz	802.11a Legacy	40	5200	15.7	0.014	0.00763
5.3 GHz	802.11a Legacy	60	5300	15.6	0.012	0.00575
5.6 GHz	802.11a Legacy	120	5600	15.7	0.032	0.012
5.8 GHz	802.11a Legacy	157	5785	17.1	0.052	0.017

Secondary Landscape (No SAR)

With 112 mm separation distance from WiFi/BT antenna-to-user.

Note: This is not the most conservative antenna-to-user distance at edge mode. According to KDB 447498 4) b) ii) (2), SAR is required only for the edge with the most conservative exposure conditions.

Primary Portrait

Direct Contact / 0 cm distance between EUT and Flat Phantom(WiFi/BT antenna-to-user distance: 3.75 mm).

Band	Mode	Channel	f (MHz)	Avg Pwr	Results (mW/g)	
				(dBm)	1g-SAR	10g-SAR
5.2 GHz	802.11a Legacy	40	5200	15.7	0.787	0.276
		52	5260	15.6	0.828	0.291
5.3 GHz	802.11a Legacy	60	5300	15.6	0.852	0.302
		64	5320	15.7	0.825	0.294
5.6 GHz	802.11a Legacy	100	5500	15.6	0.628	0.220
		120	5600	15.7	0.816	0.295
		140	5700	15.6	0.597	0.201
5.8 GHz	802.11a Legacy	157	5785	17.1	0.647	0.226

Secondary Portrait / Top Edge (No SAR)

Separation distance: 227 mm from WiFi/BT antenna-to-phantom

Note: This is not the most conservative antenna-to-user distance at edge mode. According to KDB 447498 4) b) ii) (2), SAR is required only for the edge with the most conservative exposure conditions.

Worst-case SAR Test Plots for 5GHz bands

5.2 GHz Band

Date/Time: 1/11/2011 12:38:53 PM

Test Laboratory: Compliance Certification Services (UL CCS)

5.2GHz_Primary portrait

DUT: Apple; Type: NA; Serial: NA

Communication System: 802.11abgn; Frequency: 5200 MHz; Duty Cycle: 1:1
Medium parameters used: $f = 5200 \text{ MHz}$; $\sigma = 5.29 \text{ mho/m}$; $\epsilon_r = 47.7$; $\rho = 1000 \text{ kg/m}^3$
Phantom section: Flat Section

Room Ambient Temperature: 25.0 deg. C; Liquid Temperature: 24.0 deg. C

DASY4 Configuration:

- Area Scan setting - Find Secondary Maximum Within: 2.0 dB and with a peak SAR value greater than 0.0012W/kg
- Probe: EX3DV4 - SN3749; ConvF(4.07, 4.07, 4.07); Calibrated: 12/13/2010
- Sensor-Surface: 2.5mm (Mechanical Surface Detection)
- Electronics: DAE3 Sn427; Calibrated: 7/21/2010
- Phantom: Flat Phantom ELI4.0; Type: QDOVA001BA; Serial: SN:1003
- Measurement SW: DASY4, V4.7 Build 80; Postprocessing SW: SEMCAD, V1.8 Build 186

802.11a_ch 40/Area Scan (6x7x1): Measurement grid: dx=10mm, dy=10mm
Maximum value of SAR (measured) = 1.02 mW/g

802.11a_ch 40/Zoom Scan (7x7x9)/Cube 0: Measurement grid: dx=4mm, dy=4mm, dz=2.5mm
Reference Value = 15.0 V/m; Power Drift = -0.145 dB
Peak SAR (extrapolated) = 2.43 W/kg
SAR(1 g) = 0.787 mW/g; SAR(10 g) = 0.276 mW/g
Maximum value of SAR (measured) = 1.33 mW/g

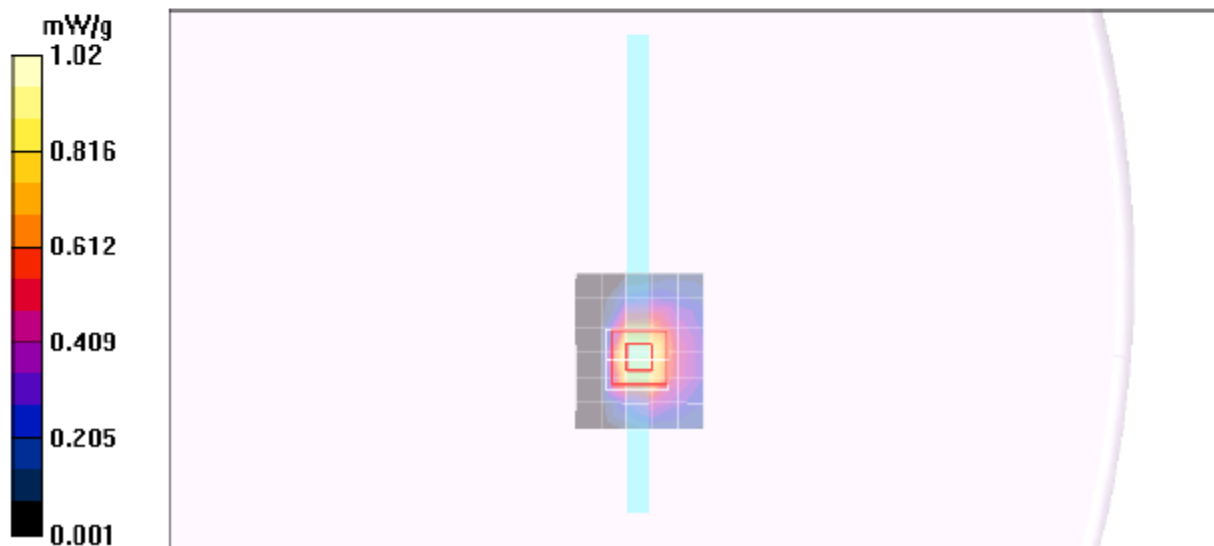

5.2 GHz Band - Z-axis Plot

Date/Time: 1/11/2011 12:56:53 PM

Test Laboratory: Compliance Certification Services (UL CCS)

5.2GHz_Primary portrait

DUT: Apple; Type: NA; Serial: NA

Communication System: 802.11abgn; Frequency: 5200 MHz; Duty Cycle: 1:1

802.11a_ch 40/Z Scan (1x1x21): Measurement grid: dx=20mm, dy=20mm, dz=5mm
Maximum value of SAR (measured) = 1.37 mW/g

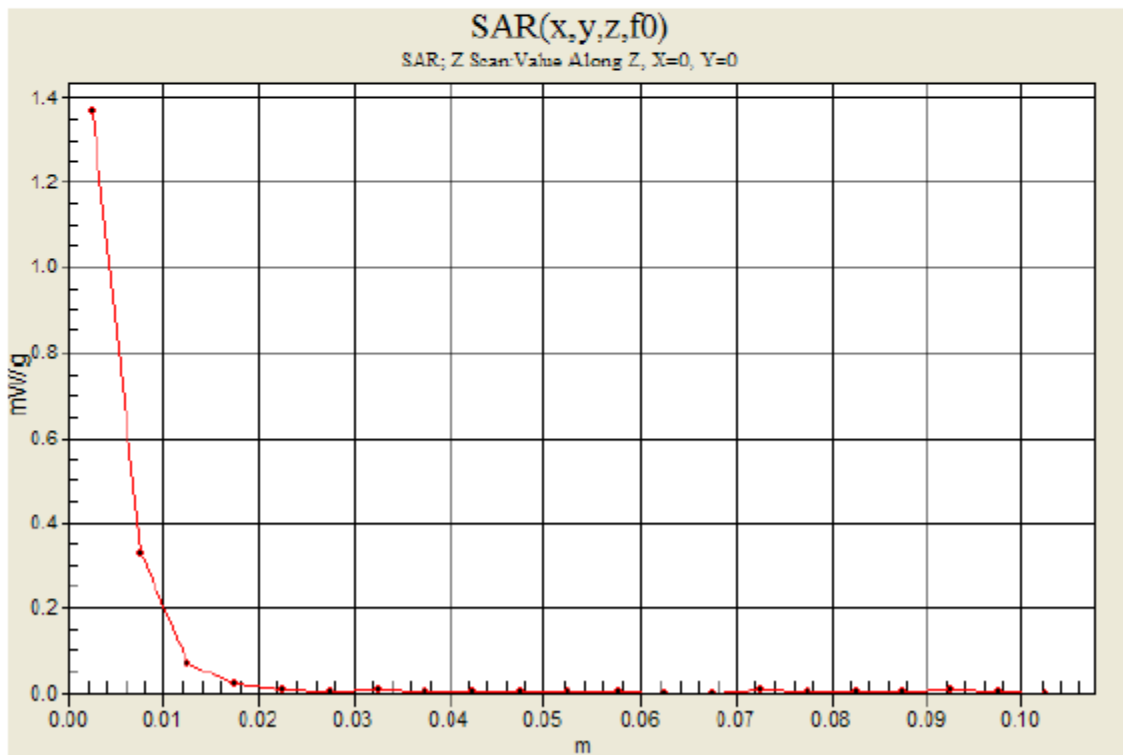

5.3 GHz Band

Date/Time: 1/11/2011 1:50:05 PM

Test Laboratory: Compliance Certification Services (UL CCS)

5.3GHz_Primary portrait

DUT: Apple; Type: NA; Serial: NA

Communication System: 802.11abgn; Frequency: 5300 MHz; Duty Cycle: 1:1
Medium parameters used: $f = 5300$ MHz; $\sigma = 5.36$ mho/m; $\epsilon_r = 47.3$; $\rho = 1000$ kg/m³
Phantom section: Flat Section

Room Ambient Temperature: 25.0 deg. C; Liquid Temperature: 24.0 deg. C

DASY4 Configuration:

- Area Scan setting - Find Secondary Maximum Within: 2.0 dB and with a peak SAR value greater than 0.0012W/kg
- Probe: EX3DV4 - SN3749; ConvF(3.88, 3.88, 3.88); Calibrated: 12/13/2010
- Sensor-Surface: 2.5mm (Mechanical Surface Detection)
- Electronics: DAE3 Sn427; Calibrated: 7/21/2010
- Phantom: Flat Phantom ELI4.0; Type: QDOVA001BA; Serial: SN:1003
- Measurement SW: DASY4, V4.7 Build 80; Postprocessing SW: SEMCAD, V1.8 Build 186

802.11a_ch 60/Area Scan (6x7x1): Measurement grid: dx=10mm, dy=10mm
Maximum value of SAR (measured) = 1.09 mW/g

802.11a_ch 60/Zoom Scan (7x7x9)/Cube 0: Measurement grid: dx=4mm, dy=4mm, dz=2.5mm
Reference Value = 15.4 V/m; Power Drift = 0.157 dB
Peak SAR (extrapolated) = 2.61 W/kg
SAR(1 g) = 0.852 mW/g; SAR(10 g) = 0.302 mW/g
Maximum value of SAR (measured) = 1.43 mW/g

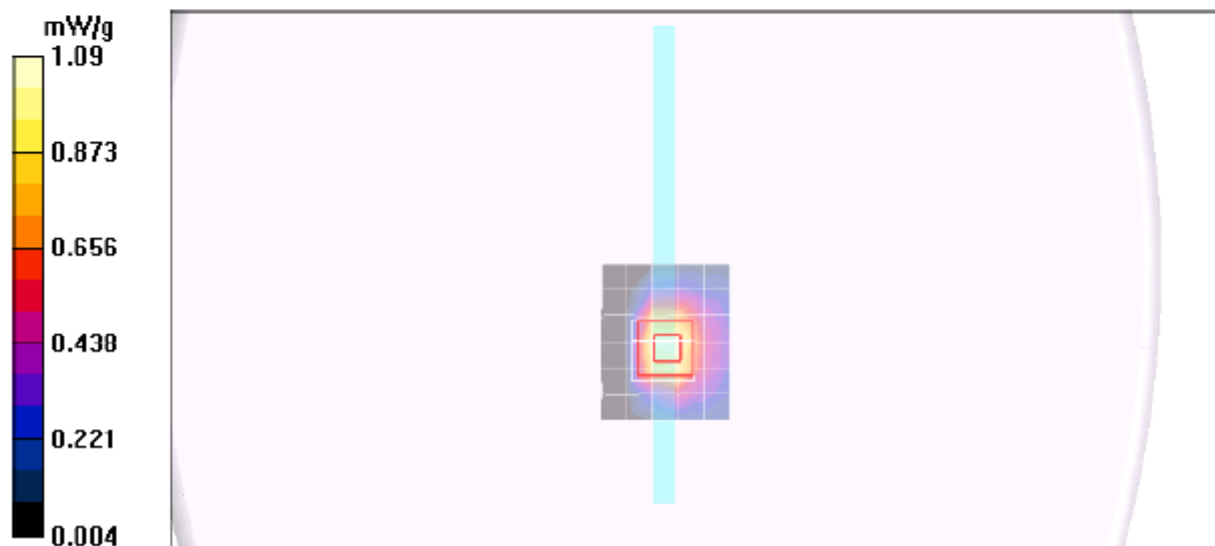

5.3 GHz Band - Z-axis Plot

Date/Time: 1/11/2011 2:08:09 PM

Test Laboratory: Compliance Certification Services (UL CCS)

5.3GHz_Primary portrait

DUT: Apple; Type: NA; Serial: NA

Communication System: 802.11abgn; Frequency: 5300 MHz; Duty Cycle: 1:1

802.11a_ch 60/Z Scan (1x1x21): Measurement grid: dx=20mm, dy=20mm, dz=5mm
Maximum value of SAR (measured) = 1.49 mW/g

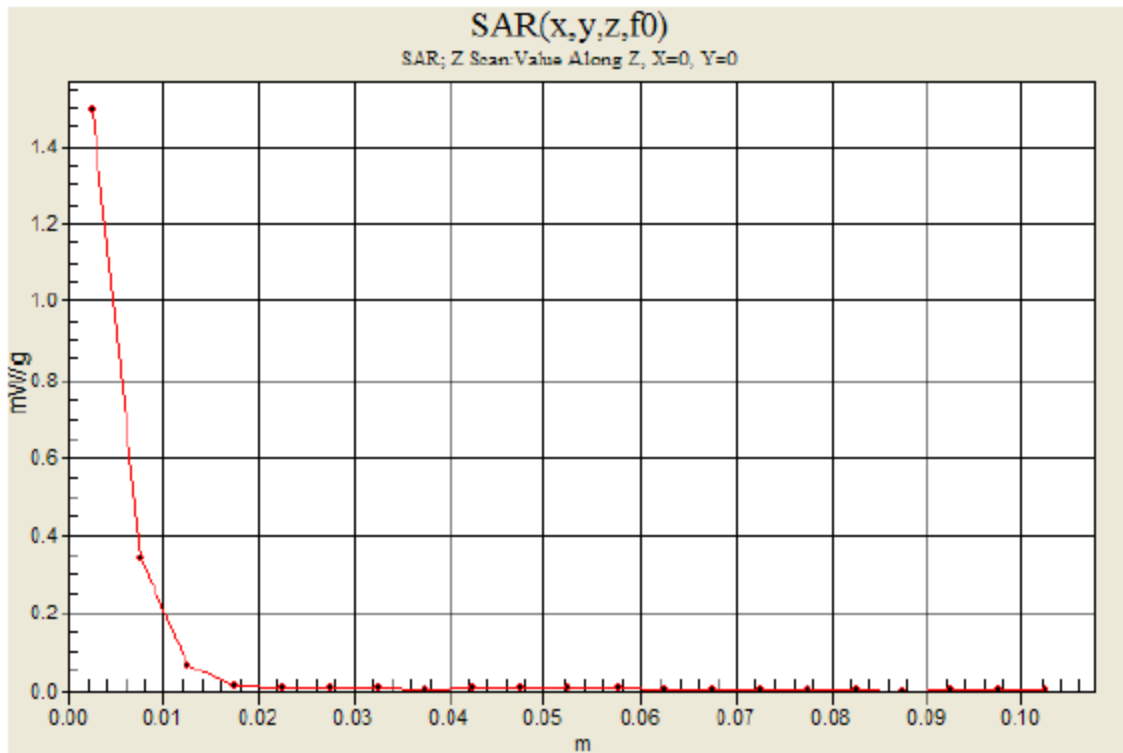

5.6 GHz Band

Date/Time: 1/11/2011 4:20:20 PM

Test Laboratory: Compliance Certification Services (UL CCS)

5.6GHz_Primary portrait

DUT: Apple; Type: NA; Serial: NA

Communication System: 802.11abgn; Frequency: 5600 MHz; Duty Cycle: 1:1
Medium parameters used: $f = 5600$ MHz; $\sigma = 5.61$ mho/m; $\epsilon_r = 47.2$; $\rho = 1000$ kg/m³
Phantom section: Flat Section

Room Ambient Temperature: 25.0 deg. C; Liquid Temperature: 24.0 deg. C

DASY4 Configuration:

- Area Scan setting - Find Secondary Maximum Within: 2.0 dB and with a peak SAR value greater than 0.0012W/kg
- Probe: EX3DV4 - SN3749; ConvF(3.36, 3.36, 3.36); Calibrated: 12/13/2010
- Sensor-Surface: 2.5mm (Mechanical Surface Detection)
- Electronics: DAE3 Sn427; Calibrated: 7/21/2010
- Phantom: Flat Phantom ELI4.0; Type: QDOVA001BA; Serial: SN:1003
- Measurement SW: DASY4, V4.7 Build 80; Postprocessing SW: SEMCAD, V1.8 Build 186

802.11a_ch 120/Area Scan (6x7x1): Measurement grid: dx=10mm, dy=10mm
Maximum value of SAR (measured) = 1.24 mW/g

802.11a_ch 120/Zoom Scan (7x7x9)/Cube 0: Measurement grid: dx=4mm, dy=4mm, dz=2.5mm
Reference Value = 16.6 V/m; Power Drift = -0.135 dB
Peak SAR (extrapolated) = 2.62 W/kg
SAR(1 g) = 0.816 mW/g; SAR(10 g) = 0.295 mW/g
Maximum value of SAR (measured) = 1.44 mW/g

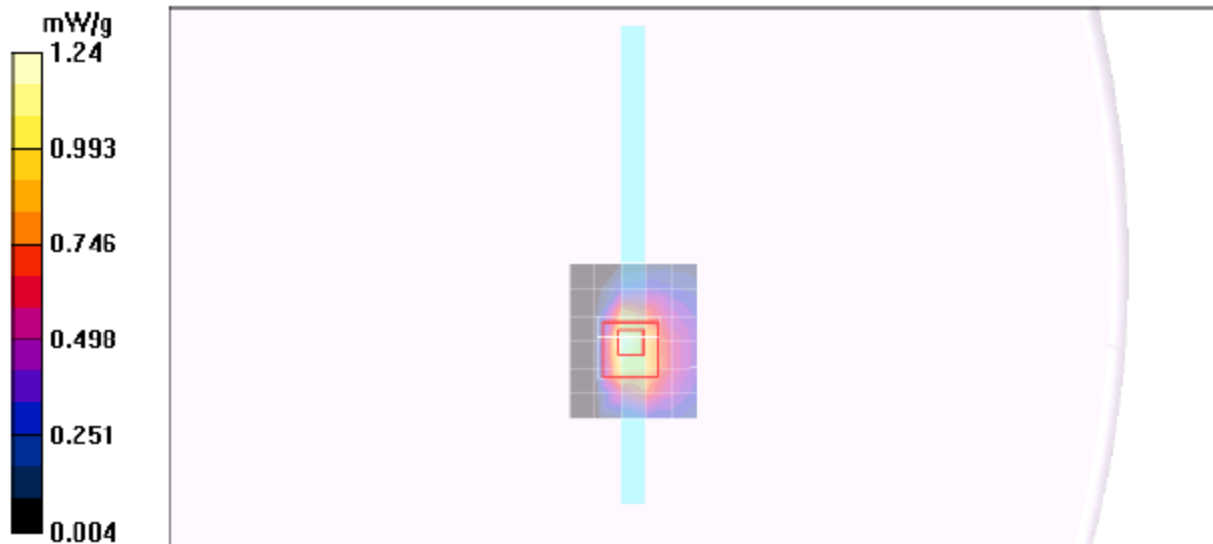

5.6 GHz Band - Z-axis Plot

Date/Time: 1/11/2011 4:38:32 PM

Test Laboratory: Compliance Certification Services (UL CCS)

5.6GHz_Primary portrait

DUT: Apple; Type: NA; Serial: NA

Communication System: 802.11abgn; Frequency: 5600 MHz; Duty Cycle: 1:1

802.11a_ch 120/Z Scan (1x1x21): Measurement grid: dx=20mm, dy=20mm, dz=5mm
Maximum value of SAR (measured) = 1.51 mW/g

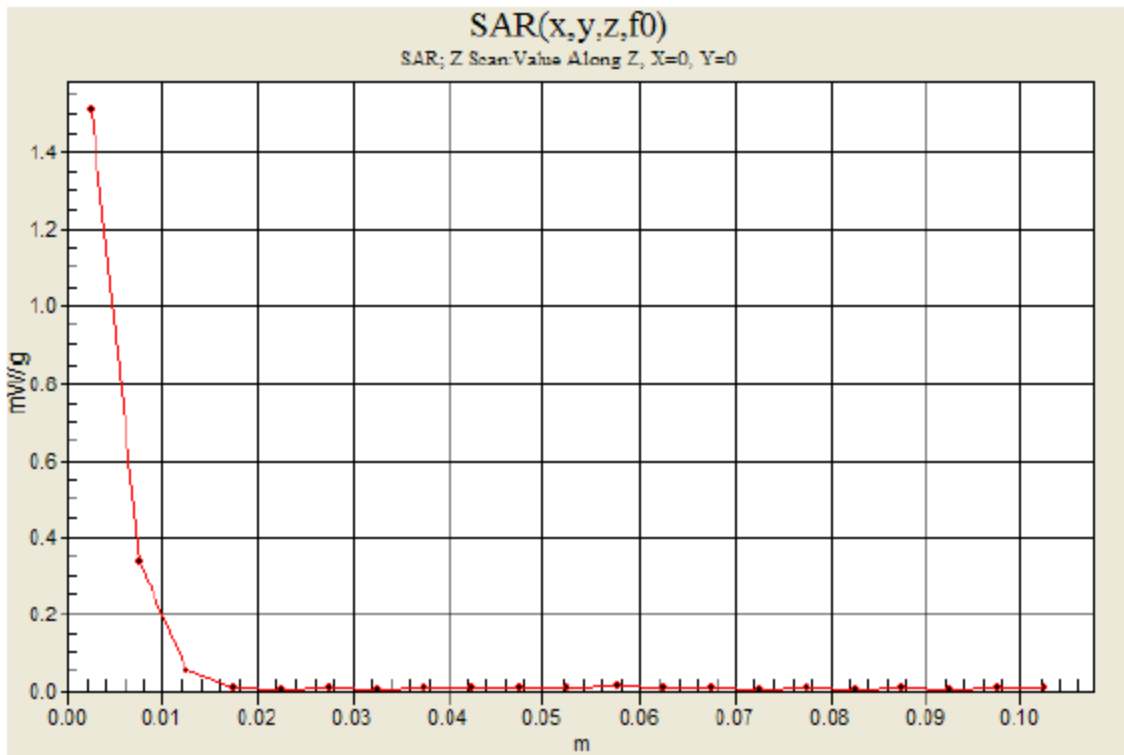

5.8 GHz Band

Date/Time: 1/11/2011 5:10:42 PM

Test Laboratory: Compliance Certification Services (UL CCS)

5.8GHz_Primary portrait

DUT: Apple; Type: NA; Serial: NA

Communication System: 802.11abgn; Frequency: 5785 MHz; Duty Cycle: 1:1

Medium parameters used (interpolated): $f = 5785 \text{ MHz}$; $\sigma = 6.06 \text{ mho/m}$; $\epsilon_r = 46.5$; $\rho = 1000 \text{ kg/m}^3$

Phantom section: Flat Section

Room Ambient Temperature: 25.0 deg. C; Liquid Temperature: 24.0 deg. C

DASY4 Configuration:

- Area Scan setting - Find Secondary Maximum Within: 2.0 dB and with a peak SAR value greater than 0.0012W/kg

- Probe: EX3DV4 - SN3749; ConvF(3.65, 3.65, 3.65); Calibrated: 12/13/2010

- Sensor-Surface: 2.5mm (Mechanical Surface Detection)

- Electronics: DAE3 Sn427; Calibrated: 7/21/2010

- Phantom: Flat Phantom ELI4.0; Type: QDOVA001BA; Serial: SN:1003

- Measurement SW: DASY4, V4.7 Build 80; Postprocessing SW: SEMCAD, V1.8 Build 186

802.11a_ch 157/Area Scan (6x7x1): Measurement grid: dx=10mm, dy=10mm

Info: [Interpolated medium parameters used for SAR evaluation.](#)

Maximum value of SAR (measured) = 1.00 mW/g

802.11a_ch 157/Zoom Scan (7x7x9)/Cube 0: Measurement grid: dx=4mm, dy=4mm, dz=2.5mm

Reference Value = 14.4 V/m; Power Drift = -0.225 dB

Peak SAR (extrapolated) = 2.23 W/kg

SAR(1 g) = 0.647 mW/g; SAR(10 g) = 0.226 mW/g

Info: [Interpolated medium parameters used for SAR evaluation.](#)

Maximum value of SAR (measured) = 1.12 mW/g

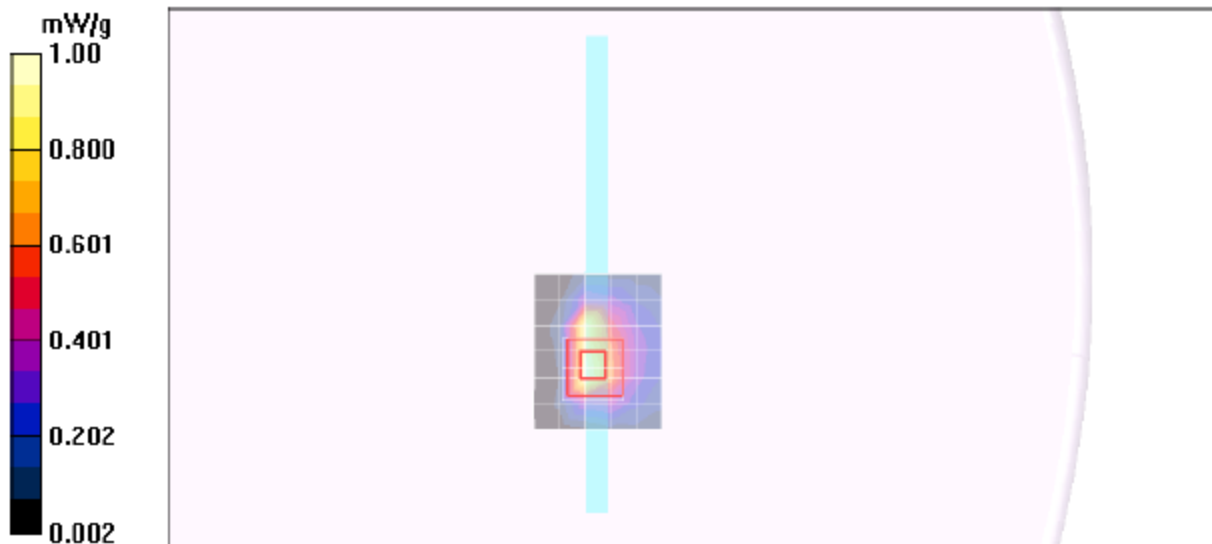

5.8 GHz Band - Z-axis Plot

Date/Time: 1/11/2011 5:28:55 PM

Test Laboratory: Compliance Certification Services (UL CCS)

5.8GHz_Primary portrait

DUT: Apple; Type: NA; Serial: NA

Communication System: 802.11abgn; Frequency: 5785 MHz; Duty Cycle: 1:1

802.11a_ch 157/Z Scan (1x1x21): Measurement grid: dx=20mm, dy=20mm, dz=5mm

Info: [Interpolated medium parameters used for SAR evaluation.](#)

Maximum value of SAR (measured) = 1.11 mW/g

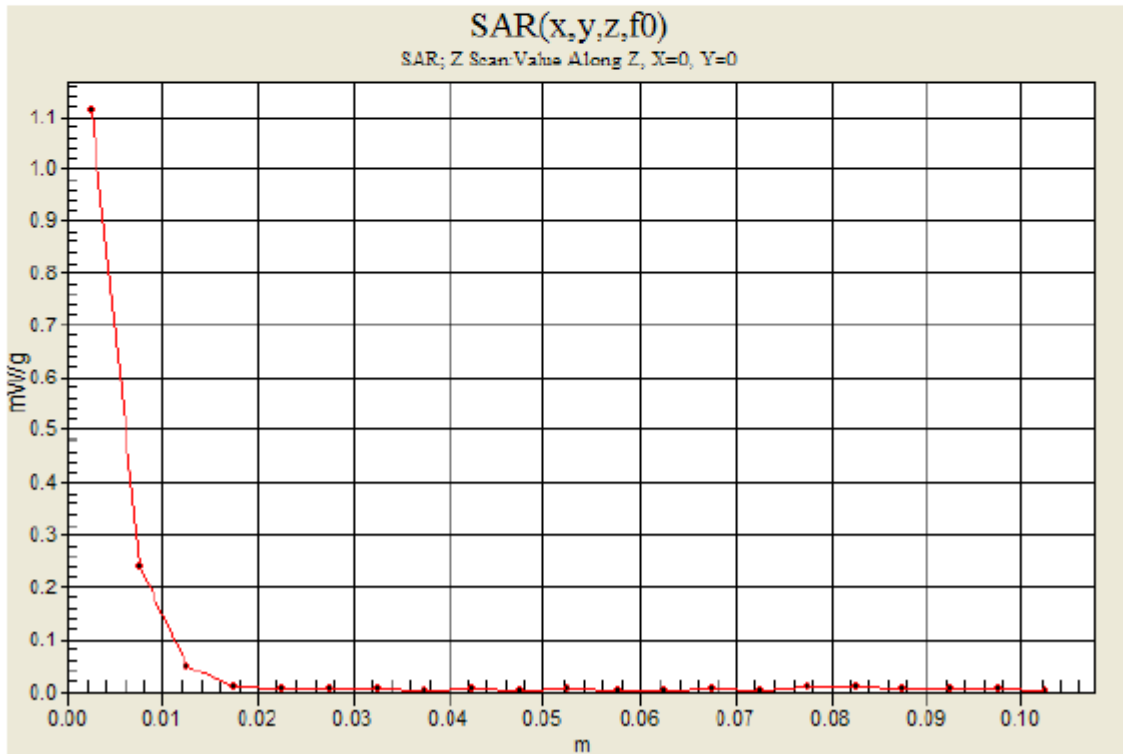

14. KDB 447498 SIMULTANEOUS TRANSMISSION SAR EVALUATIONS

Acc. to KDB 447498 3) b) ii)
 (1) for the antennas that are located < 5 cm from the persons

Finding: When the EUT is positioned at the bottom face configuration, WWAN (CDMA) and WiFi antennas are located < 5 cm from persons.

The sum of the stand-alone SAR and the SAR to peak location separation ratios

WWAN (CDMA) and WiFi (2.4 & 5 GHz bands)						
Test position	Highest 1-g SAR (W/kg)		Σ 1g SAR (W/kg)	SAR to peak location		
	WWAN	WiFi 2.4G		Separation (cm)	Ratio	
Back Surface / W Power Back-off	CDMA Cell	1.140	0.072	1.212	n/a	n/a
	CDMA PCS	1.150		1.222	n/a	n/a
	Highest 1-g SAR (W/kg)		Σ 1g SAR (W/kg)	SAR to peak location		
	WWAN	WiFi 5G		Separation (cm)	Ratio	
	CDMA Cell	1.140	0.088	1.228	n/a	n/a
	CDMA PCS	1.150		1.238	n/a	n/a
Test position	Highest 1-g SAR (W/kg)		Σ 1g SAR (W/kg)	SAR to peak location		
	WWAN	WiFi 2.4G		Separation (cm)	Ratio	
Secondary Portrait / top Edge w/ Power Back-off	CDMA Cell	1.020	*N/A	1.020	n/a	n/a
	CDMA PCS	0.697		0.697	n/a	n/a
	Highest 1-g SAR (W/kg)		Σ 1g SAR (W/kg)	SAR to peak location		
	WWAN	WiFi 5G		Separation (cm)	Ratio	
	CDMA Cell	1.020	*N/A	1.020	n/a	n/a
	CDMA PCS	0.697		0.697	n/a	n/a
Test position	Highest 1-g SAR (W/kg)		Σ 1g SAR (W/kg)	SAR to peak location		
	WWAN	WiFi 2.4G		Separation (cm)	Ratio	
Back Surface with special development software at 10 mm without power back-off	CDMA Cell	0.565	0.072	0.637	n/a	n/a
	CDMA PCS	0.639		0.711	n/a	n/a
	Highest 1-g SAR (W/kg)		Σ 1g SAR (W/kg)	SAR to peak location		
	WWAN	WiFi 5G		Separation (cm)	Ratio	
	CDMA Cell	0.565	0.088	0.653	n/a	n/a
	CDMA PCS	0.639		0.727	n/a	n/a
Test position	Highest 1-g SAR (W/kg)		Σ 1g SAR (W/kg)	SAR to peak location		
	WWAN	WiFi 2.4G		Separation (cm)	Ratio	
Secondary Portrait / Top Edge with special development software at 9.5	CDMA Cell	0.383	*N/A	0.383	n/a	n/a
	CDMA PCS	1.400		1.400	n/a	n/a
	Highest 1-g SAR (W/kg)		Σ 1g SAR (W/kg)	SAR to peak location		
	WWAN	WiFi 5G		Separation (cm)	Ratio	
	CDMA Cell	0.383	*N/A	0.383	n/a	n/a
	CDMA PCS	1.400		1.400	n/a	n/a

WiFi (2.4 & 5 GHz bands) and WWAN (CDMA)						
Test position	Highest 1-g SAR (W/kg)		Σ 1g SAR (W/kg)	SAR to peak location		
	WWAN	WiFi 2.4G		Separation (cm)	Ratio	
Primary portrait	CDMA Cell	n/a*	1.05	1.050	n/a	n/a
	CDMA PCS	n/a*		1.050	n/a	n/a
	Highest 1-g SAR (W/kg)		Σ 1g SAR (W/kg)	SAR to peak location		
	WWAN	WiFi 5G		Separation (cm)	Ratio	
	CDMA Cell	n/a*	0.852	0.852	n/a	n/a
	CDMA PCS	n/a*		0.852	n/a	n/a

***Note:** WWAN antenna is located at Top edge (Secondary portrait); antenna-to-bottom edge distance is more than 20 cm. Therefore primary portrait is excluded from SAR evaluation for WWAN. At the secondary Portrait / Top Edge mode, WiFi is more than 20 cm to the flat phantom which are excluded from SAR evaluation. Back Surface and Secondary Portrait/Top with special development software with 10 mm / 9.5 mm WWAN test data are obtained from Cetecom SAR test report submitted separately.

CONCLUSIONS:

WWAN (CDMA) and WiFi (2.4 GHz & 5 GHz bands):

Simultaneous transmission is SAR not required for WWAN (CDMA) & WiFi because the sum of the 1-g SAR is < 1.6 W/kg.

WWAN (CDMA) and Bluetooth:

Simultaneous transmission is SAR not required for WWAN (CDMA) & Bluetooth because stand alone SAR is not required for Bluetooth (output power is $\leq 60/f(\text{GHz})$ mW).

WiFi 5GHz bands and Bluetooth:

Simultaneous transmission is SAR not required for WiFi 5GHz bands & Bluetooth because stand alone SAR is not required for Bluetooth (output power is $\leq 60/f(\text{GHz})$ mW).

15. ATTACHMENTS

<u>No.</u>	<u>Contents</u>	<u>No. of page (s)</u>
1-1	SAR Test Plots for CDMA2000 Cellular Band	17
1-2	SAR Test Plots for CDMA2000 PCS Band	11
1-3	SAR Test Plots for 2.4 GHz	6
1-4	SAR Test Plots for 5 GHz	20
2	Certificate of E-Field Probe - EX3DV4 SN 3749	11
3	Certificate of System Validation Dipole - D835V2 SN:4d002	11
4	Certificate of System Validation Dipole - D1900V2 SN:5d043	11
5	Certificate of System Validation Dipole - D2450 SN:706	9
6	Certificate of System Validation Dipole - D5GHzV2 SN:1075	11