



**CONTENTION BASED PROTOCOL PORTION of FCC 47 CFR PART 15 SUBPART E,
KDB 987594**

CONTENTION BASED PROTOCOL PORTION of RSS-248, ISSUE 2

CERTIFICATION TEST REPORT

FOR

SMARTPHONE

**MODEL NUMBER: A3083 (PARENT MODEL)
A3292, A3293, A3294
(VARIANT MODELS)**

**FCC ID: BCG-E8666A (PARENT MODEL)
BCG-E8667A, BCG-E8668A
BCG-E8683A (VARIANT MODELS)**

**ISED ID: 579C-E8666A (PARENT MODEL)
579C-E8667A, 579C-E8668A,
579C-E8683A (VARIANT MODELS)**

REPORT NUMBER: 14982436-E27V5

ISSUE DATE: 2024-09-04

Prepared for
APPLE, INC.
1 APPLE PARK WAY
CUPERTINO CA 95014, U.S.A

Prepared by
UL VERIFICATION SERVICES INC.
47173 BENICIA STREET
FREMONT, CA 94538, U.S.A.
TEL: (510) 319-4000
FAX: (510) 661-0888



Cert. #0751.05

Revision History

Rev.	Issue Date	Revisions	Revised By
V1	2024-07-03	Initial Issue	--
V2	2024-07-09	Revised RSS-248 Issue 3 to Issue 2 Updated the versions of the referenced KDBs Removed the version of the referenced RF reports Removed device models not covered by this report Changed the word DFS to CBP Removed bands UNII 1-3 and DSRC in section 8.1.2 Updated the diagram for equipment classes Added 802.11be to EUT description Updated the references to test procedure of KDB 987594 Added MU table	F. Ibrahim
V3	2024-07-15	Added the following statement in the EUT description section: The manufacturer declares that the device supports channel puncturing and does not support channel bandwidth reduction	F. Ibrahim
V4	2024-08-14	Updated channel puncturing statement in section "DESCRIPTION OF EUT"	F. Ibrahim
V5	2024-09-04	Updated Sections 8.1.3 and 8.2.5	F. Ibrahim

TABLE OF CONTENTS

1. ATTESTATION OF TEST RESULTS	5
2. TEST METHODOLOGY	6
3. SUMMARY OF TEST RESULTS.....	6
4. REFERENCE DOCUMENTS	6
5. FACILITIES AND ACCREDITATION	6
6. DECISION RULES AND MEASUREMENT UNCERTAINTY	7
6.1. METROLOGICAL TRACEABILITY.....	7
6.2. DECISION RULES	7
6.3. MEASUREMENT UNCERTAINTY.....	7
7. MODEL DIFFERENCES.....	8
8. CONTENTION BASED PROTOCOL.....	9
8.1. OVERVIEW.....	9
8.1.1. LIMITS.....	9
8.1.2. FREQUENCY BANDS AND GOVERNING RULES	10
8.1.3. EQUIPMENT CLASSIFICATIONS.....	11
8.2. DESCRIPTION OF TEST SETUP	12
8.2.1. TEST AND MEASUREMENT SYSTEM.....	12
8.2.2. TEST AND MEASUREMENT SOFTWARE.....	14
8.2.3. TEST ROOM ENVIRONMENT	14
8.2.4. SETUP OF EUT.....	15
8.2.5. DESCRIPTION OF EUT	16
9. CONTENTION BASED PROTOCOL.....	17
9.1. LIMITS AND PROCEDURES	17
9.2. U-NII 5 BAND TEST CONDITION 1 RESULTS	18
9.3. U-NII 5 BAND TEST CONDITION 2 RESULTS	18
9.3.1. TEST CHANNEL.....	18
9.3.2. INCUMBENT SIGNAL PLOTS.....	18
9.3.3. EUT TRANSMISSION PLOTS.....	21
9.3.4. TABULATED TEST RESULTS	24
9.3.5. Tx OPERATIONAL STATUS TEST RESULTS	26
9.4. U-NII 5 BAND TEST CONDITION 3 RESULTS	27
9.5. U-NII 5 BAND TEST CONDITION 4 RESULTS	27
9.5.1. TEST CHANNEL.....	27
9.5.2. INCUMBENT SIGNAL PLOTS.....	27
9.5.3. EUT TRANSMISSION PLOTS.....	34
9.5.4. TABULATED TEST RESULTS	41
9.5.5. Tx OPERATIONAL STATUS TEST RESULTS	43
9.6. U-NII 6 BAND TEST CONDITION 1 RESULTS	44

9.7.	<i>U-NII 6 BAND TEST CONDITION 2 RESULTS</i>	44
9.7.1.	TEST CHANNEL	44
9.7.2.	INCUMBENT SIGNAL PLOTS	44
9.7.3.	EUT TRANSMISSION PLOTS	47
9.7.4.	TABULATED TEST RESULTS	50
9.7.5.	Tx OPERATIONAL STATUS TEST RESULTS	52
9.8.	<i>U-NII 6 BAND TEST CONDITION 3 RESULTS</i>	53
9.9.	<i>U-NII 6 BAND TEST CONDITION 4 RESULTS</i>	53
9.9.1.	TEST CHANNEL	53
9.9.2.	INCUMBENT SIGNAL PLOTS	53
9.9.3.	EUT TRANSMISSION PLOTS	60
9.9.4.	TABULATED TEST RESULTS	67
9.9.5.	Tx OPERATIONAL STATUS TEST RESULTS	69
9.10.	<i>U-NII 7 BAND TEST CONDITION 1 RESULTS</i>	70
9.11.	<i>U-NII 7 BAND TEST CONDITION 2 RESULTS</i>	70
9.11.1.	TEST CHANNEL	70
9.11.2.	INCUMBENT SIGNAL PLOTS	70
9.11.3.	EUT TRANSMISSION PLOTS	73
9.11.4.	TABULATED TEST RESULTS	76
9.11.5.	Tx OPERATIONAL STATUS TEST RESULTS	78
9.12.	<i>U-NII 7 BAND TEST CONDITION 3 RESULTS</i>	79
9.13.	<i>U-NII 7 BAND TEST CONDITION 4 RESULTS</i>	79
9.13.1.	TEST CHANNEL	79
9.13.2.	INCUMBENT SIGNAL PLOTS	79
9.13.3.	EUT TRANSMISSION PLOTS	86
9.13.4.	TABULATED TEST RESULTS	93
9.13.5.	Tx OPERATIONAL STATUS TEST RESULTS	95
9.14.	<i>U-NII 8 BAND TEST CONDITION 1 RESULTS</i>	96
9.15.	<i>U-NII 8 BAND TEST CONDITION 2 RESULTS</i>	96
9.15.1.	TEST CHANNEL	96
9.15.2.	INCUMBENT SIGNAL PLOTS	96
9.15.3.	EUT TRANSMISSION PLOTS	99
9.15.4.	TABULATED TEST RESULTS	102
9.15.5.	Tx OPERATIONAL STATUS TEST RESULTS	104
9.16.	<i>U-NII 8 BAND TEST CONDITION 3 RESULTS</i>	105
9.17.	<i>U-NII 8 BAND TEST CONDITION 4 RESULTS</i>	105
9.17.1.	TEST CHANNEL	105
9.17.2.	INCUMBENT SIGNAL PLOTS	105
9.17.3.	EUT TRANSMISSION PLOTS	112
9.17.4.	TABULATED TEST RESULTS	119
9.17.5.	Tx OPERATIONAL STATUS TEST RESULTS	121
10.	SETUP PHOTOS	122

1. ATTESTATION OF TEST RESULTS

COMPANY NAME: APPLE, INC.
1 APPLE PARK WAY
CUPERTINO, CA 95014, U.S.A.

EUT DESCRIPTION: SMARTPHONE

MODEL NUMBER: A3083 (PARENT MODEL)
A3292, A3293, A3294 (VARIANT MODELS)

MODEL TESTED: A3083

SERIAL NUMBER: FQRWW7X0D0

DATE TESTED: 2024-05-01 to 03 and 13

APPLICABLE STANDARDS	
STANDARD	TEST RESULTS
Contention Based Protocol Portion of 47 CFR Part 15 Subpart E, KDB 987594	Complies
Contention Based Protocol Portion of RSS-248, Issue 2	Complies

UL Verification Services Inc. tested the above equipment in accordance with the requirements set forth in the above standards. The test results show that the equipment tested is capable of demonstrating compliance with the requirements as documented in this report.

The results documented in this report apply only to the tested sample, under the conditions and modes of operation as described herein. It is the manufacturer's responsibility to assure that additional production units of this model are manufactured with identical electrical and mechanical components. All samples tested were in good operating condition throughout the entire test program. Measurement Uncertainties are published for informational purposes only and were not taken into account unless noted otherwise.

This document may not be altered or revised in any way unless done so by UL Verification Services Inc. and all revisions are duly noted in the revisions section. Any alteration of this document not carried out by UL Verification Services Inc. will constitute fraud and shall nullify the document.

Approved & Released For
UL Verification Services Inc. By:



Frank Ibrahim
Staff Engineer
CONSUMER TECHNOLOGY DIVISION
UL Verification Services Inc.

Prepared By:



Doug Anderson
Test Engineer
CONSUMER TECHNOLOGY DIVISION
UL Verification Services Inc.

2. TEST METHODOLOGY

The tests documented in this report were performed in accordance with the following standards/rules/KDBs:

- FCC KDB 987594 D01 U-NII 6GHz General Requirements v02r02
- FCC KDB 987594 D02 U-NII 6 GHz EMC Measurement v02r01
- FCC KDB 987594 D03 U-NII 6 GHz QA v02
- FCC KDB 987594 D04 UN6GHZ Pre-Approval Guidance Checklist v02
- RSS-248, ISSUE 2

3. SUMMARY OF TEST RESULTS

Requirement Description	Result	Remarks
Contention Based Protocol Portion of FCC 47 CFR PART 15 SUBPART E, KDB 987594	Complies	
Contention Based Protocol Portion of RSS-248, Issue 2	Complies	

4. REFERENCE DOCUMENTS

Measurements of transmitter parameters as referenced in this report and all other manufacturer's declarations relevant to the RF test requirements are documented in UL Verification Services report number 14982436-E10 & E11 FCC_IC WIFI 7 Conducted Report".

This report contains data provided by the customer which can impact the validity of results. UL Verification Services Inc. is only responsible for the validity of results after the integration of the data provided by the customer.

5. FACILITIES AND ACCREDITATION

UL LLC is accredited by A2LA, certification #0751.05, for all testing performed within the scope of this report. Testing was performed at the locations noted below.

	Address	ISED CABID	ISED Company Number	FCC Registration
<input checked="" type="checkbox"/>	Building 1: 47173 Benicia Street, Fremont, California, USA	US0104	2324A	550739

6. DECISION RULES AND MEASUREMENT UNCERTAINTY

6.1. METROLOGICAL TRACEABILITY

All test and measuring equipment utilized to perform the tests documented in this report are calibrated on a regular basis, with a maximum time between calibrations of one year or the manufacturers' recommendation, whichever is less, and where applicable is traceable to recognized national standards.

6.2. DECISION RULES

The Decision Rule is based on Simple Acceptance in accordance with ISO Guide 98-4:2012 Clause 8.2. (Measurement uncertainty is not taken into account when stating conformity with a specified requirement).

6.3. MEASUREMENT UNCERTAINTY

The following measurement uncertainty levels have been estimated for tests performed on the apparatus:

PARAMETER	U _{LAB}
Radio Frequency	±0.0003 %
RF power, conducted	±1.30 dB
RF power, radiated	±3.23 dB
Generated signal levels, conducted	±1.00 dB
Generated signal levels, radiated	±1.00 dB
Spurious emissions, conducted	±1.94 dB
Spurious emissions, radiated	±3.23 dB
Humidity	±6.79 % RH
Temperature	±2.26 deg C
Time	±3.39 %

Uncertainty figures are valid to a confidence level of 95%.

7. MODEL DIFFERENCES

The manufacturer hereby declares that:

- All models use the same system, cellular and connectivity radio electrical schematics.
- Removal of FR2 and LTE bands on models not supporting them is done by de-population of related components. Electrically there is no difference among the models.
- Models A3083, A3292, A3293, A3294 use external GNSS Chipset BCM 47774.
- All models use the same Wi-Fi/BT chipset and radio module.
- All models use the same Applications Processor and PMU.
- All Models use the same UICC hardware/software interface.
- All models run the same Baseband firmware and iOS software.

The characteristics listed above do not have any influence upon the CBP performance of the models covered by this report and therefore the CBP test results documented for Parent Model A3083 for may be applied as representative to Variant Models A3292, A3293 and A3294.

Additional spot check testing was also performed to confirm that the data presented in the report for Parent Model A3083 is representative for all the Variant Models A3292, A3293 and A3294 within the scope of this report.

8. CONTENTION BASED PROTOCOL

8.1. OVERVIEW

8.1.1. LIMITS

FCC

FCC Part 15 Subpart E, FCC KDB 987594 “U-NII 6 GHz devices operating in the 5.925-7.125 GHz band”; Section I.

INNOVATION, SCIENCE and ECONOMIC DEVELOPMENT CANADA (ISED)

Per Section 4.8.1 of RSS-248, Issue 2:

“The Federal Communications Commission’s accepted KDB procedure KDB 987594 D02 shall be used to demonstrate the compliance of a device with the contention-based protocol requirements set out in this section:

8.1.2. FREQUENCY BANDS AND GOVERNING RULES

Band	Frequency (GHz)	Rules	Notes	KDB/Publication
U-NII 5	5.925-6.425	15.407(a)(4) – (8)	Low Power Indoor AP, Subordinates, Indoor Clients Standard Power AP, Fixed & Standard Clients	789033 (U-NII) 987594 (6 GHz Band)
U-NII 6	6.425-6.525	15.407(a)(5), (6), (8)	Low Power Indoor AP, Subordinates, Indoor Clients	
U-NII 7	6.525-6.875	15.407(a)(4) – (8)	Low Power Indoor AP, Subordinates, Indoor Clients Standard Power AP, Fixed & Standard Clients	
U-NII 8	6.875 -7.125	15.407(a)(5), (6), (8)	Low Power Indoor AP, Subordinates, Indoor Clients	
* Transition period ended March 2, 2020 for marketing DTS in the 5 GHz Band, as stated in 15.408(b)(4)(ii)				

Table 1: Overview of U-NII Rules

8.1.3. EQUIPMENT CLASSIFICATIONS

There are eight applicable equipment classes for U-NII 6 GHz device certifications, as illustrated in Figure 1. Multiple equipment classes can apply to one FCC ID. Equipment classes categorize the certification record by the different technical rules that apply.

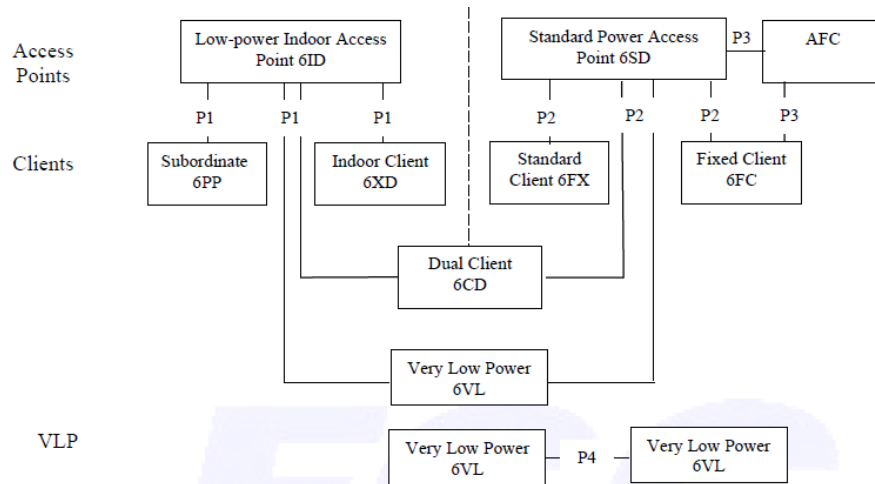

- P1 Client, subordinate, and VLP devices under the control of low-power indoor access points.
- P2 Client and VLP devices under the control of standard access points.
- P3 Standard Power Access Point and Fixed Client devices managed by the AFC.
- P4 VLP devices communicating with other VLP devices are not controlled by either a standard or a low-power indoor access point.

Figure 1 – Part 15 Subpart E Equipment Classes

DEFINITION OF EQUIPMENT CLASSES

1. 6ID: 15E 6 GHz Low power indoor access point.
2. 6PP: 15E 6 GHz Subordinate indoor device. These devices are under control of a Low power indoor access point (P1).
3. 6XD: 15E 6 GHz Low power Indoor client. These devices are under control of a low power indoor access point (P1).
4. 6SD: 15E 6 GHz Standard power access point. These devices are managed by the Automatic Frequency Coordination (AFC) system.
5. 6CD: 15E 6 GHz Dual client. These devices are under control of either a low power indoor access point (6ID) (P1) or Standard power access point (P2).
6. 6FX: 15E 6 GHz Standard client. These devices are under control of a Standard power access point (P2).
7. 6FC: 15E 6 GHz Fixed client. These devices are associated with a standard power access point (P3).
8. 6VL: 15E 6 GHz VLP device operating in U-NII bands 5 & 7

8.2. DESCRIPTION OF TEST SETUP

8.2.1. TEST AND MEASUREMENT SYSTEM

These tests were performed using a Conducted instrument configuration.

CONDUCTED TEST CONFIGURATION

NOTE: This is a comprehensive setup diagram of the receiver performance test and measurement system. Not all of the devices shown below are used for every applicable receiver test. Also, coupler port designations “IN” and “OUT” refer to labeling on the coupler, not the RF signal flow.

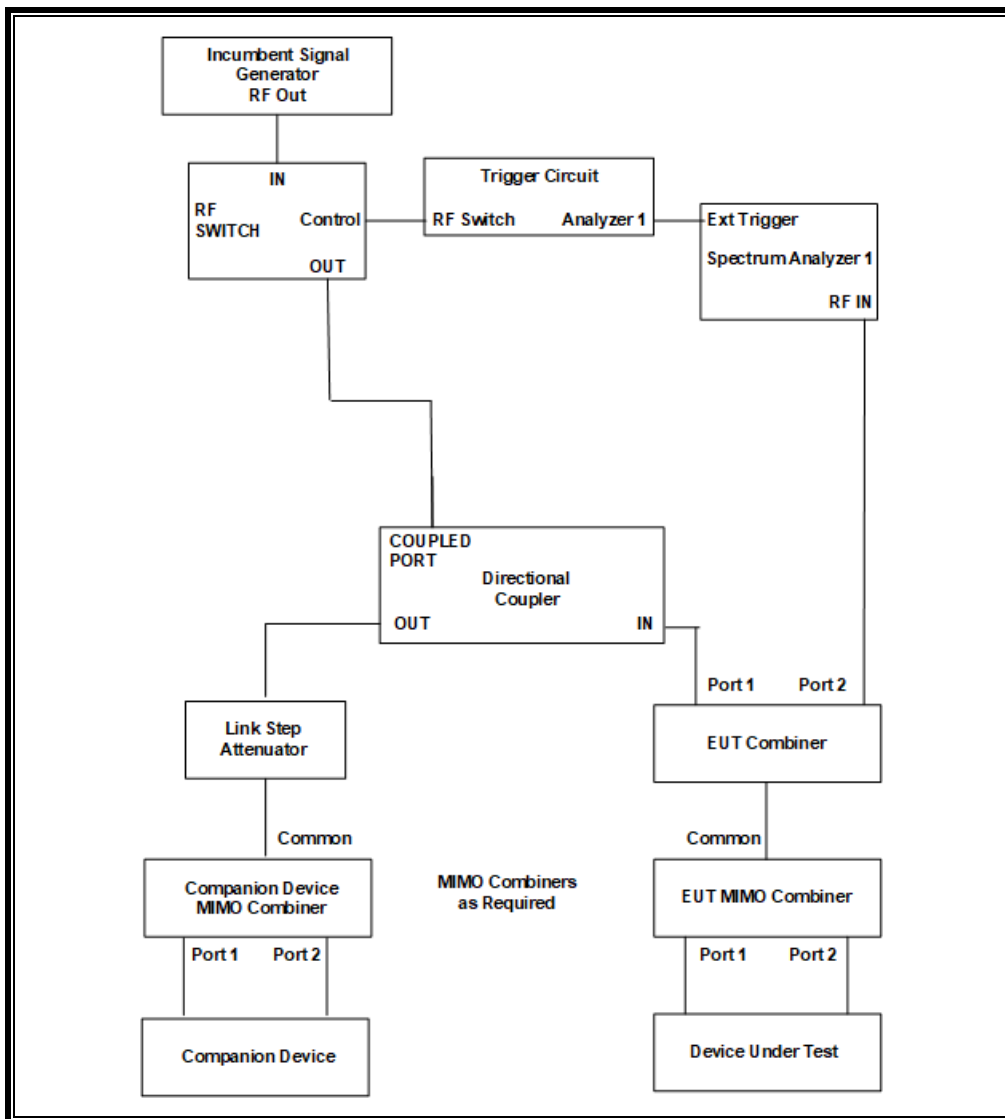

SYSTEM OVERVIEW

Should multiple RF ports be utilized for the EUT and/or Companion devices (for example, for diversity or MIMO implementations), combiner/dividers are inserted between the EUT MIMO Combiner/Divider and the attenuator connected to the EUT (and/or between the Companion MIMO Combiner/Divider and the attenuator connected to the Companion Device). Additional attenuators may be utilized such that there is one attenuator at each RF port on each device.

SYSTEM CALIBRATION

The monitoring cable is disconnected from the spectrum analyzer and a 50-ohm load is connected to the end of the monitoring cable in place of the spectrum analyzer. The cable connected to the EUT is then attached to the spectrum analyzer in place of the monitoring cable. A signal generator is then set to produce a modulated AWGN Incumbent Signal that has a 99% occupied power bandwidth of 10 MHz. The output amplitude of the signal generator is adjusted to yield the allowable maximum AWGN Incumbent Signal level as measured on the spectrum analyzer. The EUT and monitoring cables are then returned to their original configurations to perform the test.

TEST AND MEASUREMENT EQUIPMENT

The following test and measurement equipment was utilized for the tests documented in this report:

TEST EQUIPMENT LIST				
Description	Manufacturer	Model	ID No.	Cal Due
Spectrum Analyzer, PXA, 3Hz to 8.4GHz	Keysight	N9030A	150667	01/31/25
Signal Generator, MXG X-Series RF Vector	Keysight	N5182B	215999	01/31/25
Frequency Extender	Keysight	N5182BX	213906	01/31/25

Note: An MXG series Signal Generator and separate external Frequency Extender module are shown in the preceding test system block diagram as a stand-alone Incumbent Signal Generator.

8.2.2. TEST AND MEASUREMENT SOFTWARE

The following test and measurement software was utilized for the tests documented in this report:

TEST SOFTWARE LIST		
Name	Version	Test / Function
PXA Read	3.1	Signal Generator Screen Capture

8.2.3. TEST ROOM ENVIRONMENT

The test room temperature and humidity shall be maintained within normal temperature of 15~35 °C and normal humidity 20~75% (relative humidity).

ENVIRONMENT CONDITION

Parameter	Value
Temperature	23.3, 23.4, 23.7 and 21.9 °C
Humidity	42, 40, 45 and 50 %

8.2.4. SETUP OF EUT

CONDUCTED METHOD EUT TEST SETUP

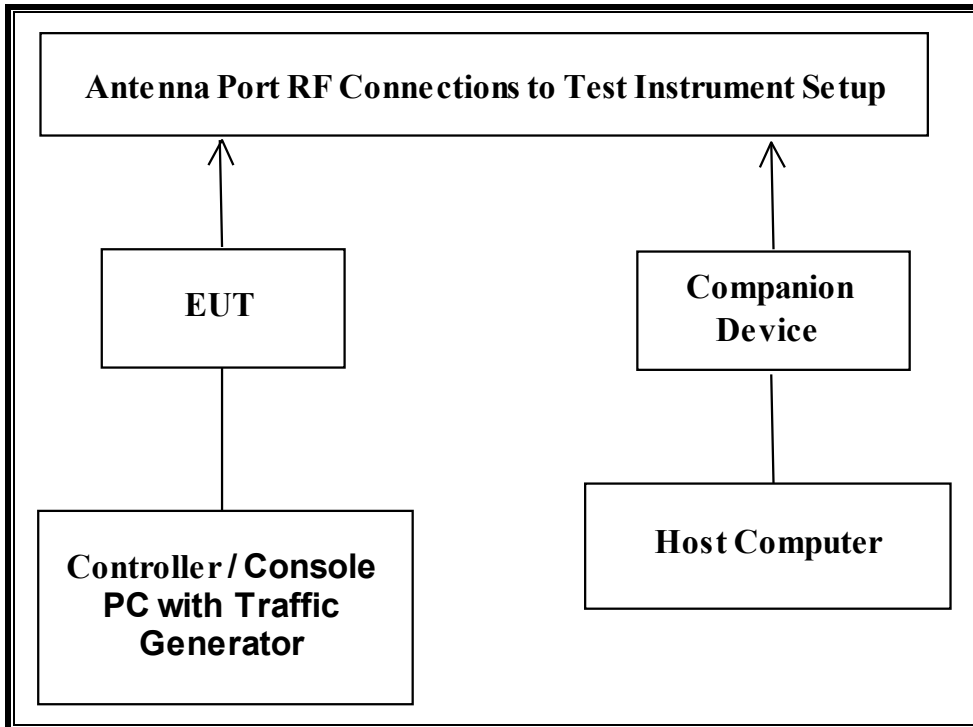

SUPPORT EQUIPMENT

The following support equipment was utilized for the tests documented in this report:

PERIPHERAL SUPPORT EQUIPMENT LIST				
Description	Manufacturer	Model	Serial Number	FCC ID
BE19000 Nighthawk WiFi 7 Tri-Band Router (Companion)	Netgear	RS700	7DC1387FD0080	PY323100 586
AC Adapter (Companion)	Netgear	2AEC060K	No Serial Number	DoC
Notebook PC (Companion Host)	Lenovo	Type 20B7-S0A200	PF-02JN9J 14/06	DoC
AC Adapter (Companion Host)	Lenovo	ADLX65NLC2A	11S45N0259Z1ZS97 4594A9	DoC
Notebook PC (EUT Console)	Apple	A1708	C02VT5DTHV22	DoC

8.2.5. DESCRIPTION OF EUT

The EUT operates in the following band / bands: U-NII 5 (5925 MHz-6425 MHz), U-NII 6 (6425 MHz-6525 MHz), U-NII 7 (6525 MHz-6875 MHz) and U-NII 8 (6875 MHz-7125 MHz).

The EUT is classified as a 6 GHz Dual Client.

The manufacturer has declared that the lowest gain antenna assembly utilized with the EUT has a gain of -2.9 dBi in the U-NII 5 band, -3.7 dBi in the U-NII 6 band, -5.8 dBi in the U-NII 7 band and -4.2 dBi in the U-NII 8 band.

Two antennas are utilized to meet the diversity and MIMO operational requirements.

The maximum allowable conducted AWGN Incumbent Detection Threshold level is -62 dBm/MHz. After correction for antenna gain the conducted AWGN Incumbent Detection Threshold at the antenna port is -62 + antenna gain. This results in a maximum allowable AWGN Incumbent Detection Threshold of -64.9 dBm in the U-NII 5 band, -65.7 dBm in the U-NII 6 band, -67.8 dBm in the U-NII 7 band and -66.2 dBm in the U-NII 8 band.

The EUT uses two transmitter/receiver chains, each connected to a 50-ohm coaxial antenna port. All antenna ports are connected to the test system via a power divider to perform conducted tests.

WLAN traffic was generated by transferring a data stream from the EUT to the Companion Device using iPerf version 3 software package.

The EUT utilizes the 802.11ax and 802.11be architecture. Four nominal channel bandwidths are implemented: 20 MHz, 40 MHz, 80 MHz and 160 MHz.

The manufacturer declares that Channel Puncturing is supported but is used only for network optimization and is not used for the purposes of avoiding incumbents.

The EUT does not support Channel Bandwidth Reduction.

The software installed in the EUT is version 18.0.

The firmware installed in the Companion Device is version V1.0.7.56_2.0.65.

The manufacturer declares that the CBP function is independent of operating power level and operates when the device is connected to Standard-Power, LPI or VLP networks.

TEST SETUP

The EUT is attached to a USB port of a host notebook PC during testing. The EUT is linked to a companion 802.11 wireless radio device. A commercial traffic generation program (iPERF) was utilized to generate traffic from the EUT to the companion radio device.

9. CONTENTION BASED PROTOCOL

9.1. LIMITS AND PROCEDURES

LIMITS

FCC Part 15 Subpart E, FCC KDB 987594 “U-NII 6 GHz devices operating in the 5.925-7.125 GHz band”; Section I.

AWGN INCUMBENT SIGNAL DETECTION THRESHOLD

FCC Part 15 Subpart E, FCC KDB 987594 “U-NII 6 GHz devices operating in the 5.925-7.125 GHz band”; Section I.

Unlicensed low-power indoor devices must detect co-channel radio frequency power that is at least -62 dBm or lower. Upon detection of energy in the band, unlicensed low power indoor devices must vacate the channel (in which incumbent signal is transmitted) and stay off the incumbent channel as long as detected radio frequency power is equal to or greater than the threshold (-62 dBm)¹. The -62 dBm (or lower) threshold is referenced to a 0 dBi antenna gain.

Band	Frequency Range (MHz)	Antenna Gain (dBi)	T _L at Radio Port (dBm/MHz)
U-NII 5	5925 to 6425	-2.9	-64.9
U-NII 6	6425 to 6525	-3.7	-65.7
U-NII 7	6525 to 6875	-5.8	-67.8
U-NII 8	6875 to 7125	-4.2	-66.2

TEST PROCEDURE

FCC Part 15 Subpart E, FCC KDB 987594 “U-NII 6 GHz devices operating in the 5.925-7.125 GHz band”; Section I.

9.2. U-NII 5 BAND TEST CONDITION 1 RESULTS

TEST CONDITION 1 CRITERIA

$$99\% BW_{EUT} \leq 99\% BW_{INC}$$

The lowest and highest supported channel bandwidths do not meet the criteria for this test condition therefore this test was not performed.

9.3. U-NII 5 BAND TEST CONDITION 2 RESULTS

TEST CONDITION 2 CRITERIA

$$99\% BW_{INC} < 99\% BW_{EUT} \leq 2 \times 99\% BW_{INC}$$

9.3.1. TEST CHANNEL

All tests were performed with the EUT set to a channel center frequency of 6215 MHz and a nominal channel bandwidth of 20 MHz.

Only the lowest and highest supported channel bandwidths are required to be tested.

9.3.2. INCUMBENT SIGNAL PLOTS

All tests were performed with the Incumbent Signal frequency set to the test channel center frequency and a nominal 99% Occupied Power Bandwidth of 10 MHz.

INCUMBENT SIGNAL 99% OCCUPIED POWER BANDWIDTH

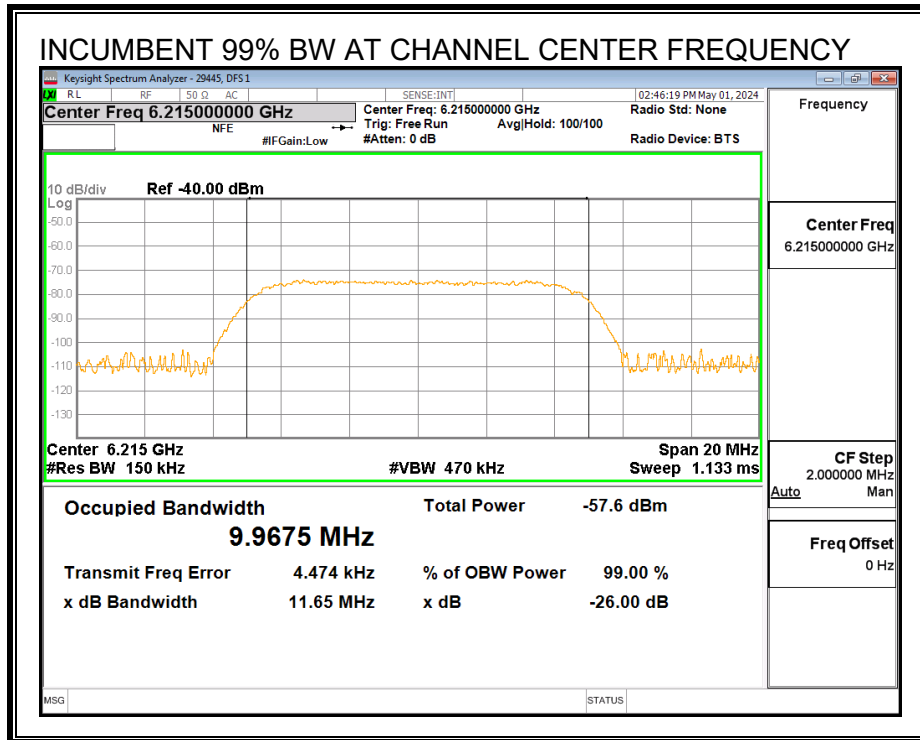

MINIMUM PASSING INCUMBENT SIGNAL POWER

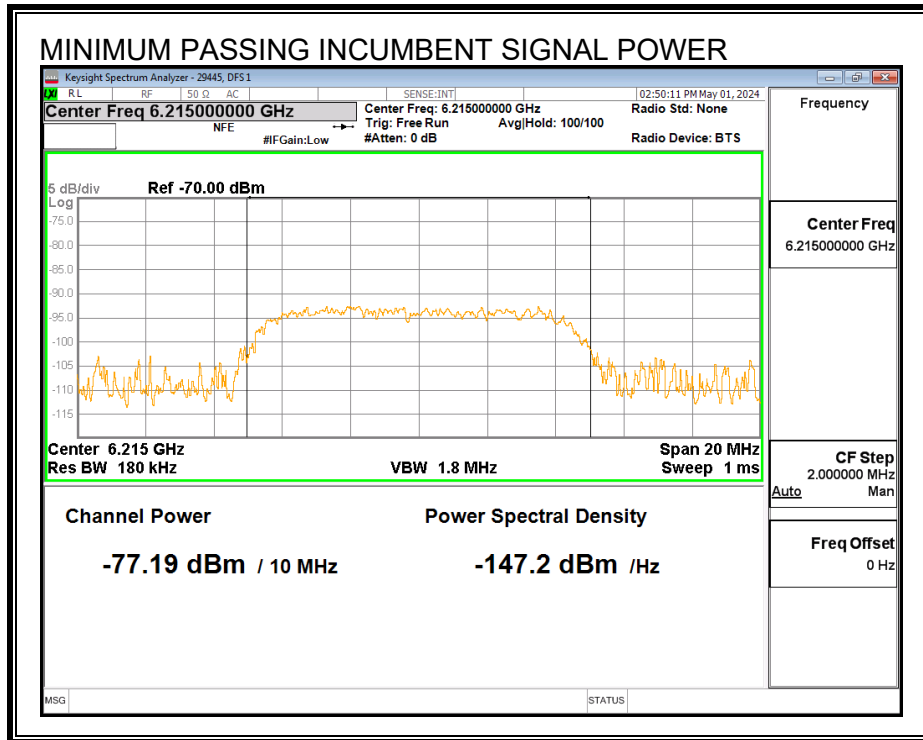

9.3.3. EUT TRANSMISSION PLOTS

EUT 99% OCCUPIED POWER BANDWIDTH

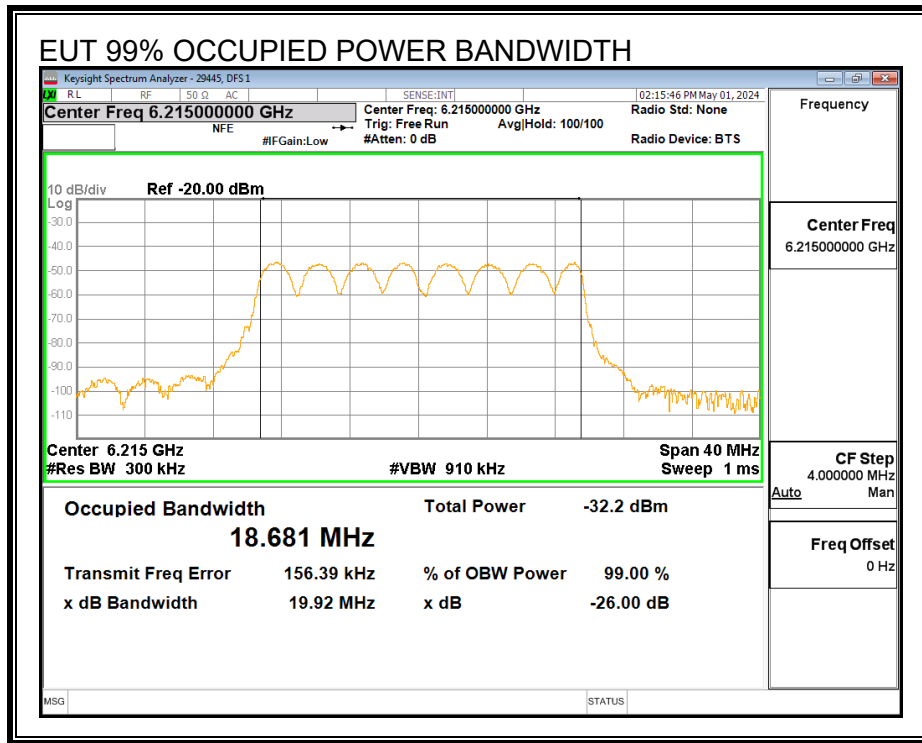

TRAFFIC WITHOUT THE INCUMBENT SIGNAL PRESENT

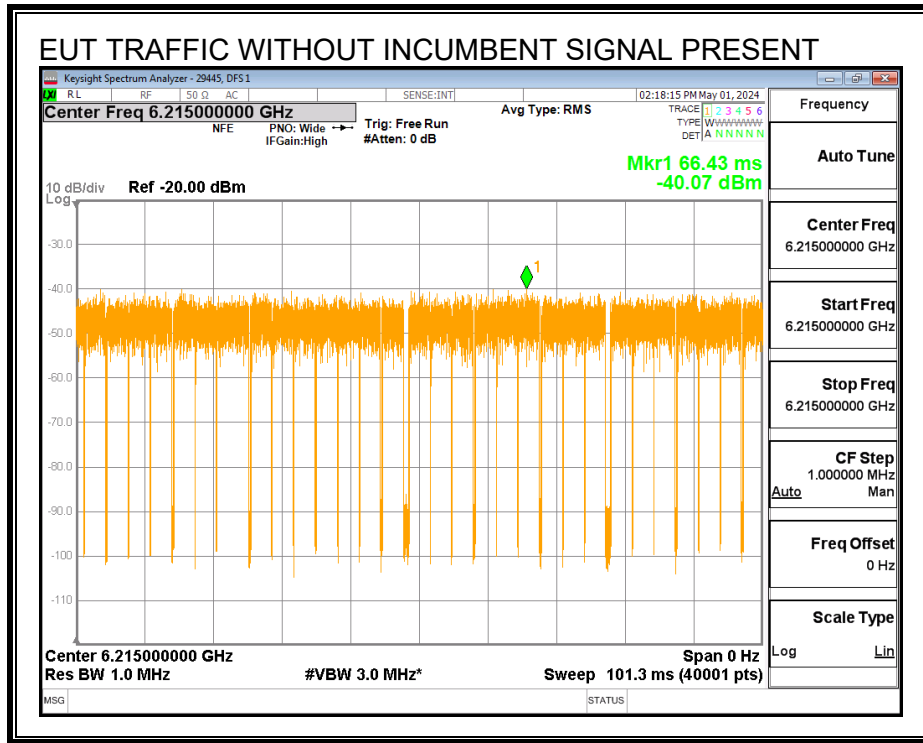

EUT RESPONSE TO THE APPLIED INCUMBENT SIGNAL

A link between the EUT and the Companion Device was established on the test channel. Traffic flowing from the EUT to the Companion Device was then initiated. A sweep was started, and the incumbent signal was continuously applied at approximately 5 seconds after the start of the sweep for a duration of 30 seconds and removed after the end of the observation period. Markers are placed at the beginning and end of the observation period.

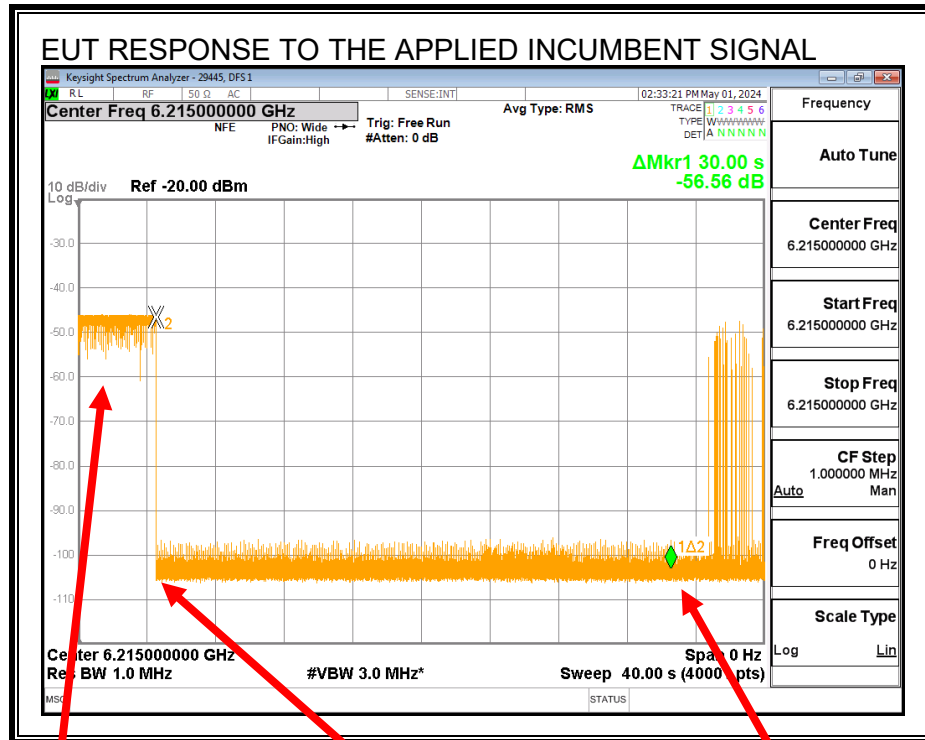

Normal Traffic

Application of Incumbent
Transmissions Ceased

Incumbent Removed
Transmissions Resume

Transmissions cease while the Incumbent AWGN Signal is present and resume after it is removed.

9.3.4. TABULATED TEST RESULTS

INCUMBENT SIGNAL DETECTION RESULTS

EUT Channel Center Frequency, f_{c1} (MHz)	6215
EUT Nominal Channel Bandwidth (MHz)	20
99% Occupied Bandwidth of the EUT (MHz)	18.681
EUT 99% OBW Lower Edge, F_L (MHz)	6205.66
EUT 99% OBW Upper Edge, F_H (MHz)	6224.34
Test Frequency of Incumbent Signal (MHz)	6215
Maximum Allowed Incumbent Amplitude at Antenna (dBm)	-62
Minimum Antenna Gain (dBi)	-2.9
Maximum Allowed Incumbent Amplitude at Radio Port (dBm)	-64.9
Lowest Passing Measured Incumbent Signal Amplitude (dBm)	
	-80.87
Margin (dBm)	-15.97
Result (PASS / FAIL)	PASS

Test Date: 05/01/24

Tested by: 29445

Test location: DFS 1

INCUMBENT SIGNAL DETECTION CERTAINTY RATE

AWGN Detected (Yes / No)	
Trial	Incumbent AWGN at f_{c1}
1	Yes
2	Yes
3	Yes
4	Yes
5	Yes
6	Yes
7	Yes
8	Yes
9	Yes
10	Yes
Test Result	PASS

Test Date: 05/01/24
Tested by: 29445
Test location: DFS 1

A minimum detection rate of 90% is required for the EUT to be compliant.

9.3.5. Tx OPERATIONAL STATUS TEST RESULTS

Test Condition 2: $99\% BW_{INC} < 99\% BW_{EUT} \leq 2 \times 99\% BW_{INC}$

Incumbent AWGN at f_{c1} :

Measured Incumbent Power at the EUT Test Fixture Connector (dBm)	Test Fixture Cable Path Loss (dB)	Adjusted Incumbent Power at the Radio Port (dBm)	Antenna Gain (dBi)	Adjusted Incumbent Power at the Antenna (dBm)	Detection Limit (dBm)	EUT Tx Status
-77.19	3.68	-80.87	-2.9	-77.97	-62	Ceased
-79.94	3.68	-83.62	-2.9	-80.72	-62	Minimal
-81.90	3.68	-85.58	-2.9	-82.68	-62	Normal

Test Date: 05/01/24

Tested by: 29445

Test location: DFS 1

9.4. U-NII 5 BAND TEST CONDITION 3 RESULTS

TEST CONDITION 3 CRITERIA

$$2 \times 99\% BW_{INC} < 99\% BW_{EUT} \leq 4 \times 99\% BW_{INC}$$

The lowest and highest supported channel bandwidths do not meet the criteria for this test condition therefore this test was not performed.

9.5. U-NII 5 BAND TEST CONDITION 4 RESULTS

TEST CONDITION 4 CRITERIA

$$99\% BW_{EUT} > 4 \times 99\% BW_{INC}$$

9.5.1. TEST CHANNEL

All tests were performed with the EUT set to a channel center frequency of 6185 MHz and a nominal channel bandwidth of 160 MHz.

Only the lowest and highest supported channel bandwidths are required to be tested.

9.5.2. INCUMBENT SIGNAL PLOTS

All tests were performed with the Incumbent Signal frequency set to the test channel center frequency and a nominal 99% Occupied Power Bandwidth of 10 MHz.

INCUMBENT SIGNAL 99% OCCUPIED POWER BANDWIDTH

Lower Edge Incumbent Signal f_{c2} :

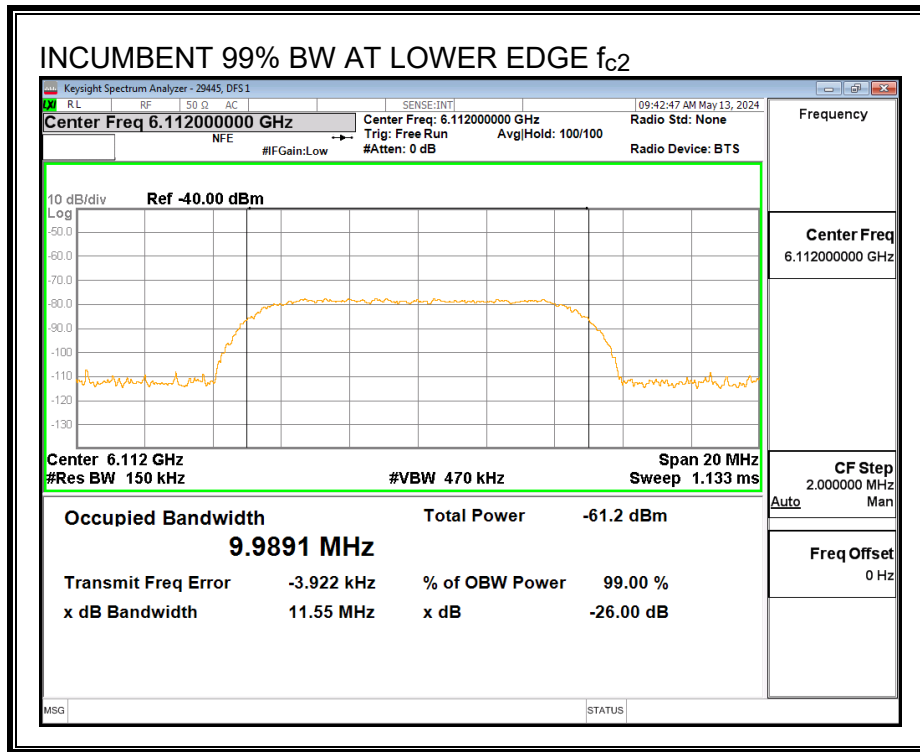

Center Frequency Incumbent Signal f_{c1} :

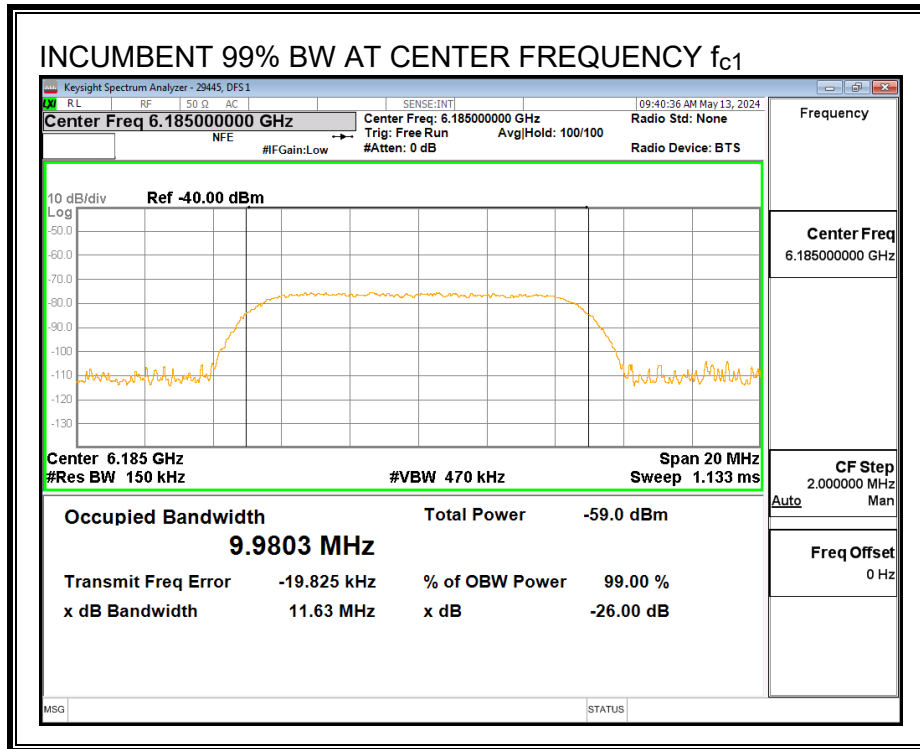

Upper Edge Incumbent Signal f_{c3} :

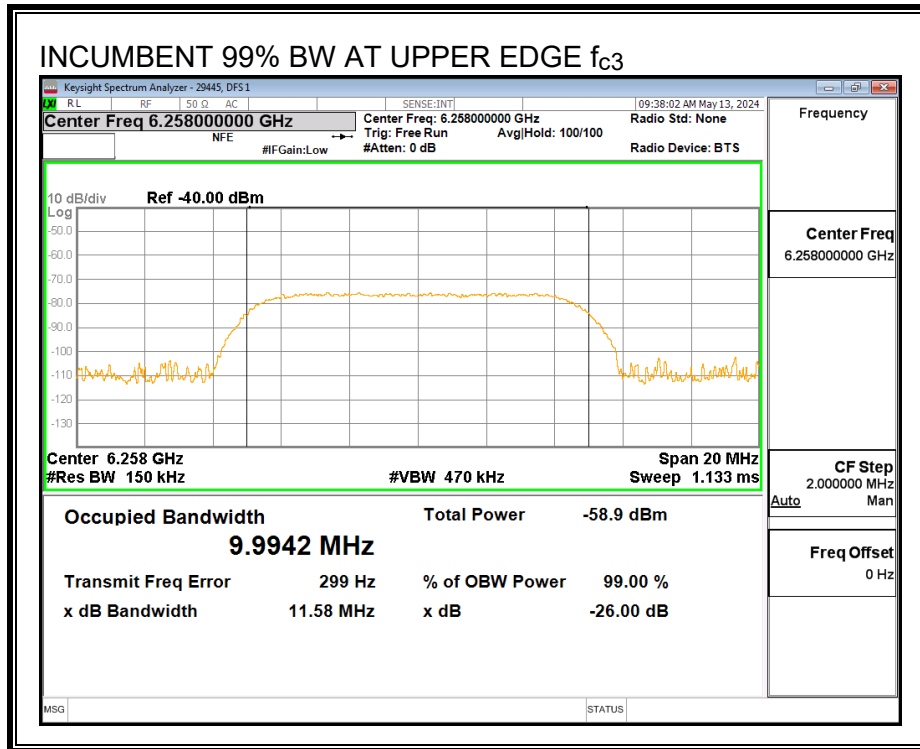

MINIMUM PASSING INCUMBENT SIGNAL POWER

Lower Edge Incumbent Signal f_{c2} :

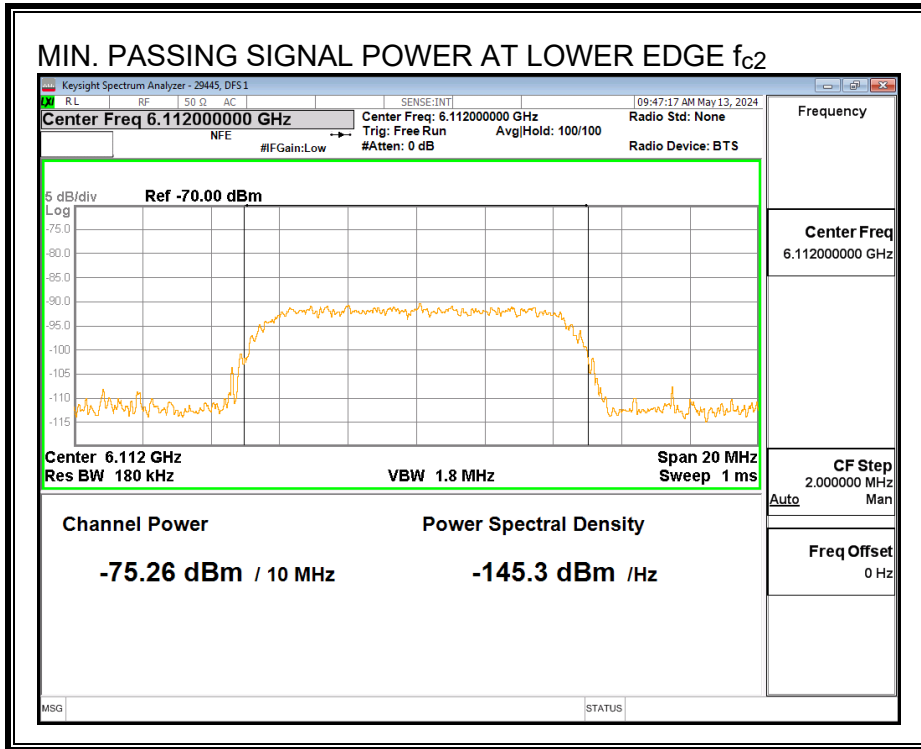

Center Frequency Incumbent Signal f_{c1} :

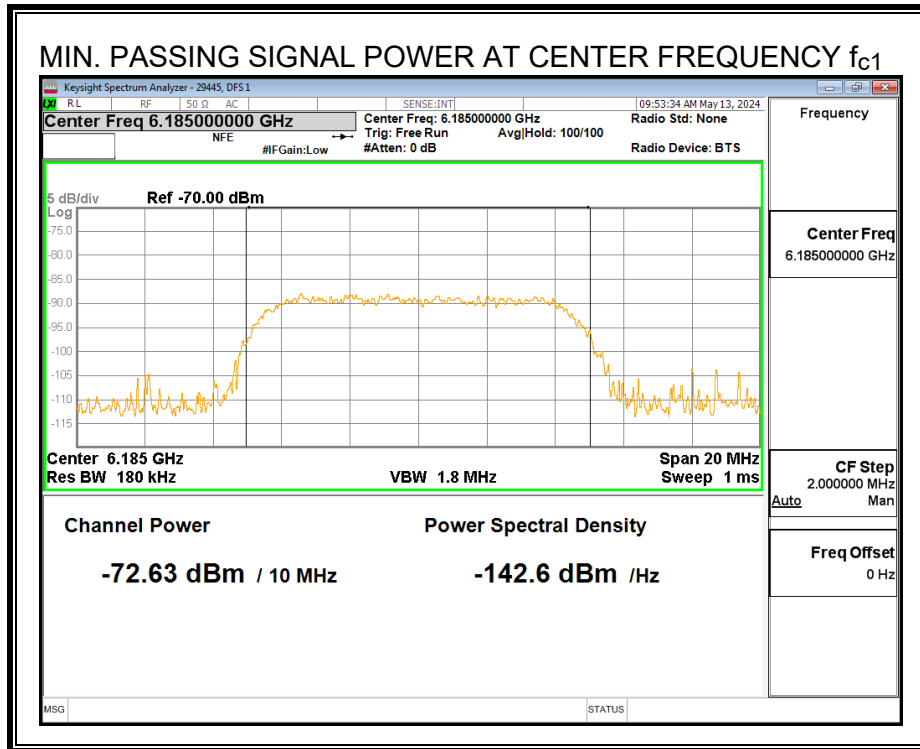

Upper Edge Incumbent Signal f_{c3} :

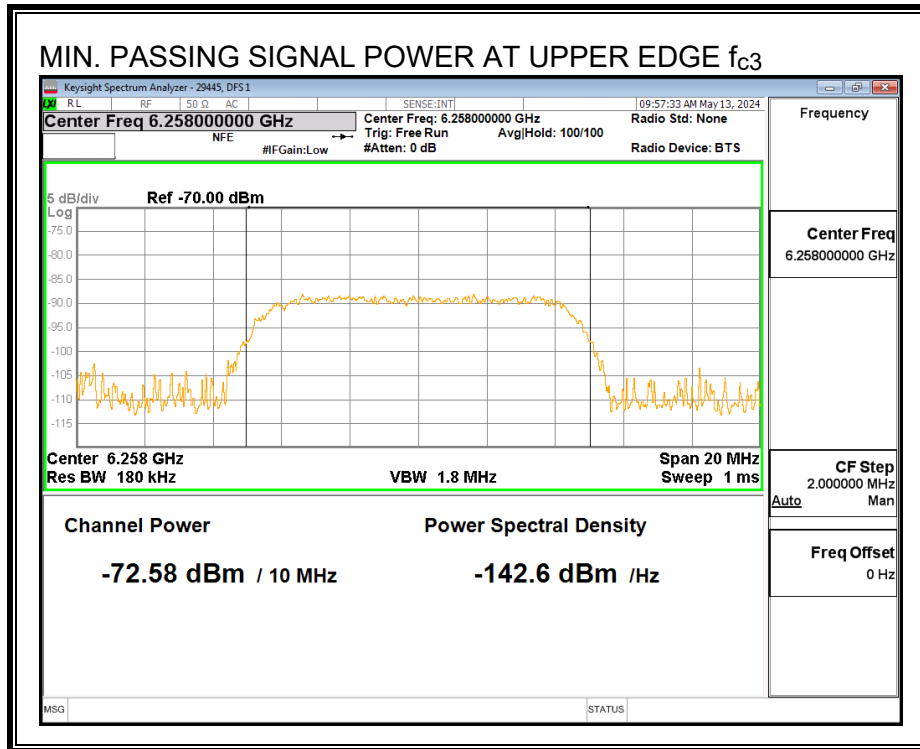

9.5.3. EUT TRANSMISSION PLOTS

EUT 99% OCCUPIED POWER BANDWIDTH

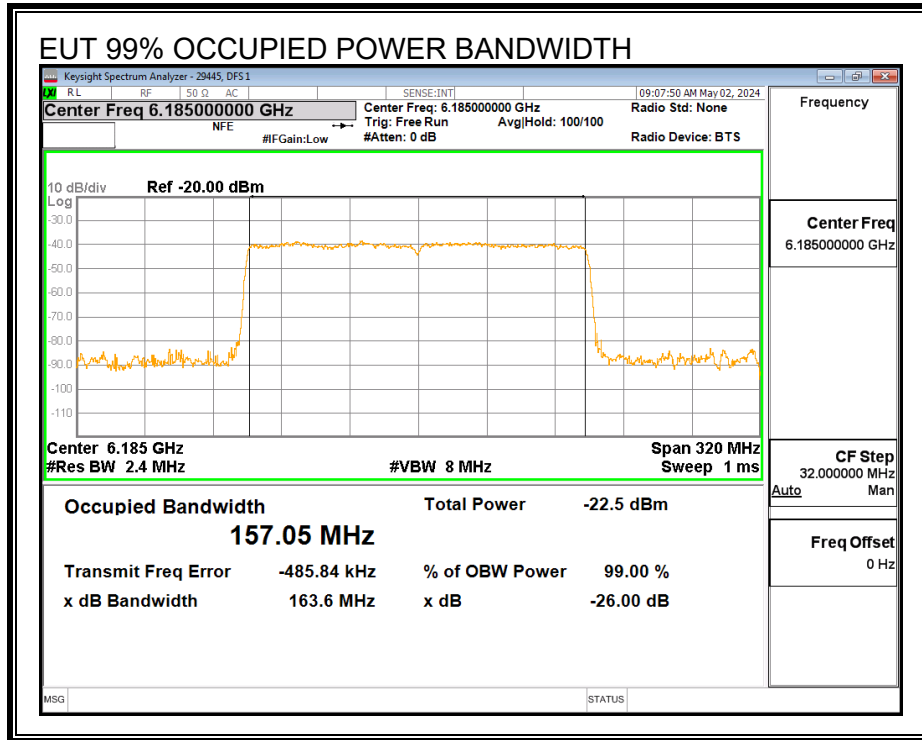

TRAFFIC WITHOUT THE INCUMBENT SIGNAL PRESENT

Lower Edge f_{c2}:

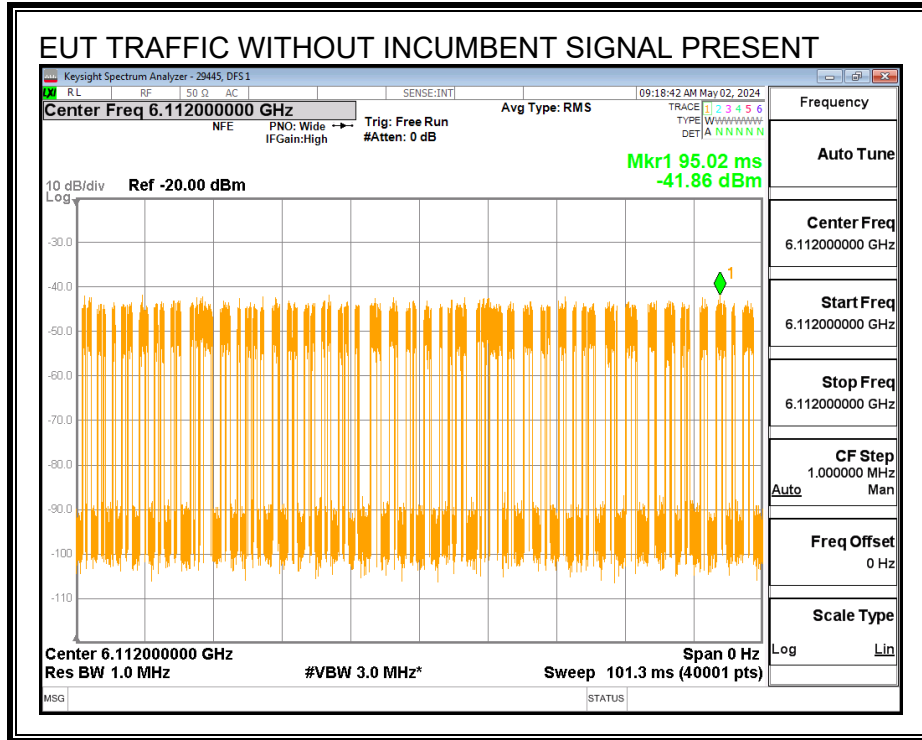

Center Frequency f_{c1} :

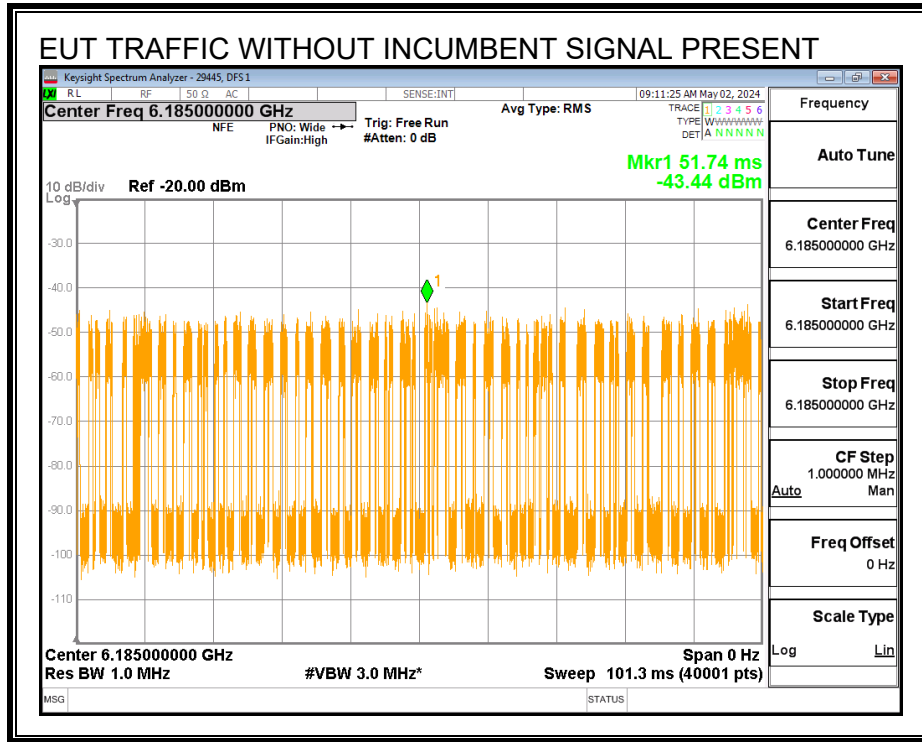

Upper Edge fc3:

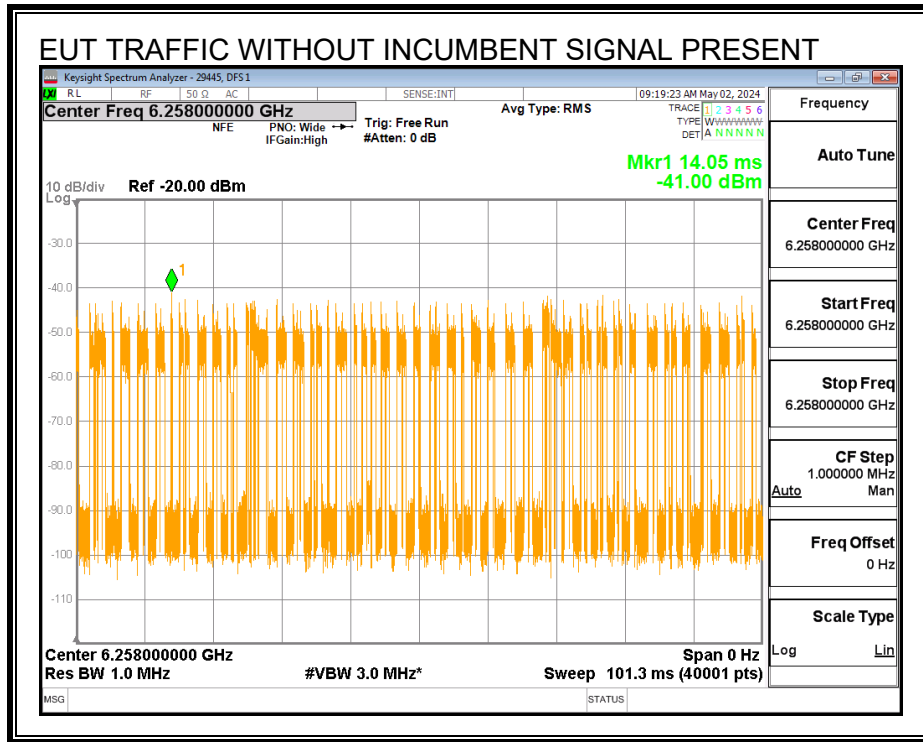

EUT RESPONSE TO THE APPLIED INCUMBENT SIGNAL

A link between the EUT and the Companion Device was established on the test channel. Traffic flowing from the EUT to the Companion Device was then initiated. A sweep was started, and the incumbent signal was continuously applied at approximately 5 seconds after the start of the sweep for a duration of 30 seconds and removed after the end of the observation period. Markers are placed at the beginning and end of the observation period.

Lower Edge Incumbent Signal f_{c2} :

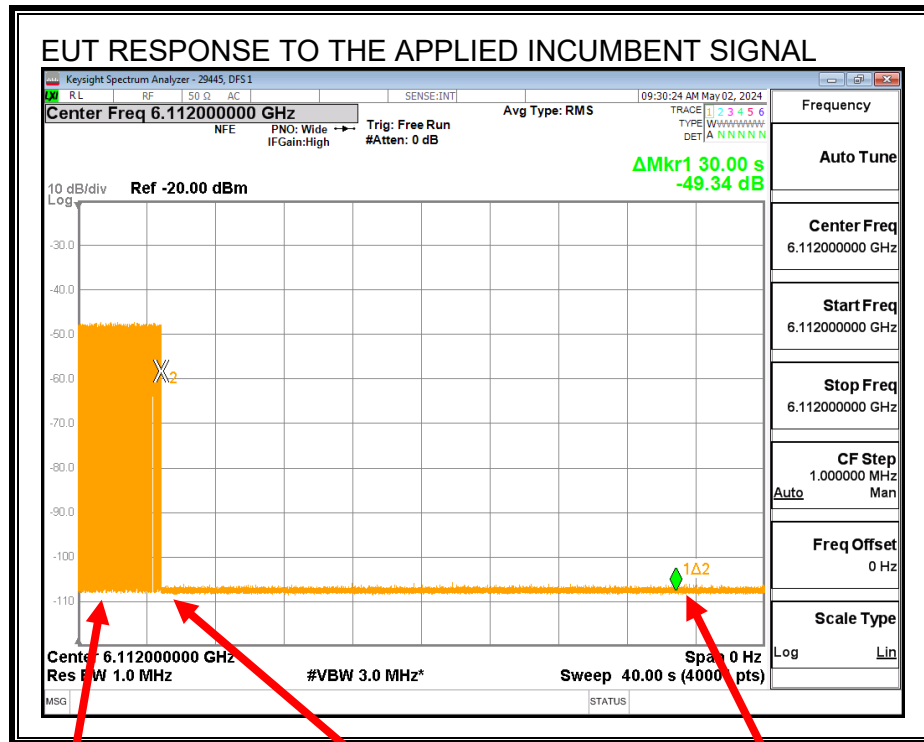

Normal Traffic

Application of Incumbent
Transmissions Ceased

Incumbent Removed
Association to Companion Lost

Transmissions cease while the Incumbent AWGN Signal is present and do not resume after it is removed due to the loss of the association to the Companion Device.

Center Frequency Incumbent Signal f_{c1} :

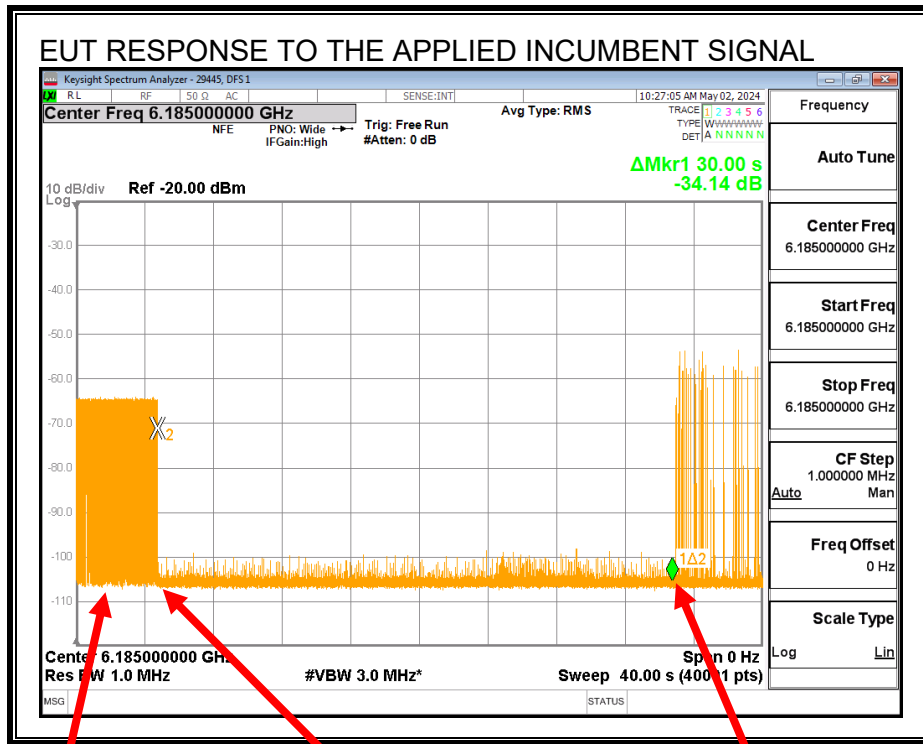

Normal Traffic

Application of Incumbent
Transmissions Ceased

Incumbent Removed
Transmissions Resume

Transmissions cease while the Incumbent AWGN Signal is present and resume after it is removed.

Upper Edge Incumbent Signal f_{c3}:

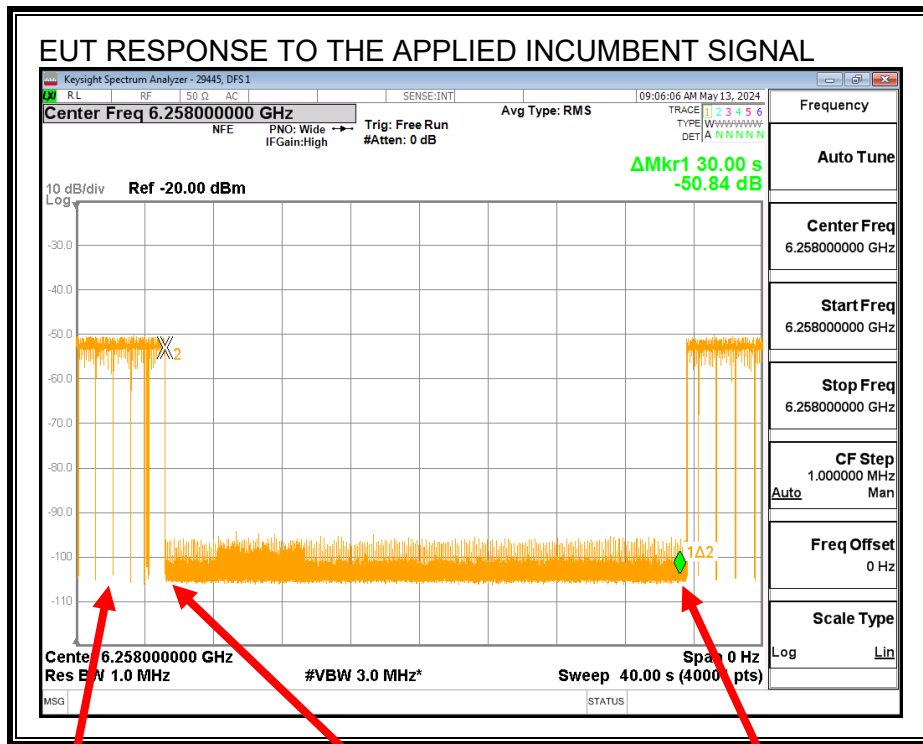

Normal Traffic

Application of Incumbent
Transmissions Ceased

Incumbent Removed
Transmissions Resume

Transmissions cease while the Incumbent AWGN Signal is present and resume after it is removed.

9.5.4. TABULATED TEST RESULTS

INCUMBENT SIGNAL DETECTION RESULTS

EUT Channel Center Frequency, f_{c1} (MHz)	6185
EUT Nominal Channel Bandwidth (MHz)	160
99% Occupied Bandwidth of the EUT (MHz)	157.05
EUT 99% OBW Lower Edge, F_L (MHz)	6106.48
EUT 99% OBW Upper Edge, F_H (MHz)	6263.53
99% Occupied Bandwidth of the Incumbent Signal (MHz)	9.9803
Test Frequency of Incumbent Signal (f_{c2}) Near EUT F_L (MHz)	6112
Test Frequency of Incumbent Signal at f_{c1} (MHz)	6185
Test Frequency of Incumbent Signal (f_{c3}) Near EUT F_H (MHz)	6258
Maximum Allowed Incumbent Amplitude at Antenna (dBm)	-62
Minimum Antenna Gain (dBi)	-2.9
Maximum Allowed Incumbent Amplitude at Radio Port (dBm)	-64.90
Lowest Passing Measured Incumbent Signal Amplitude at f_{c2} (dBm)	
	-78.93
Margin (dBm)	-14.03
Result (PASS / FAIL)	PASS
Lowest Passing Measured Incumbent Signal Amplitude at f_{c1} (dBm)	
	-76.30
Margin (dBm)	-11.40
Result (PASS / FAIL)	PASS
Lowest Passing Measured Incumbent Signal Amplitude at f_{c3} (dBm)	
	-76.25
Margin (dBm)	-11.35
Result (PASS / FAIL)	PASS

Test Date: 05/02 and 13/24

Tested by: 29445

Test location: DFS 1

INCUMBENT SIGNAL DETECTION CERTAINTY RATE

Trial	AWGN Detected (Yes / No)		
	Incumbent AWGN at f_{c2}	Incumbent AWGN at f_{c1}	Incumbent AWGN at f_{c3}
1	Yes	Yes	Yes
2	Yes	Yes	Yes
3	Yes	Yes	Yes
4	Yes	Yes	Yes
5	Yes	Yes	Yes
6	Yes	Yes	Yes
7	Yes	Yes	Yes
8	Yes	Yes	Yes
9	Yes	Yes	Yes
10	Yes	Yes	Yes
Test Result	PASS	PASS	PASS

Test Date: 05/13/24

Tested by: 29445

Test location: DFS 1

A minimum detection rate of 90% is required for the EUT to be compliant.

9.5.5. Tx OPERATIONAL STATUS TEST RESULTS

Test Condition 4: 99% BW_{EUT} > 4 x 99% BW_{INC}

Incumbent AWGN at f_{c2}:

Measured Incumbent Power at the EUT Test Fixture Connector (dBm)	Test Fixture Cable Path Loss (dB)	Adjusted Incumbent Power at the Radio Port (dBm)	Antenna Gain (dBi)	Adjusted Incumbent Power at the Antenna (dBm)	Detection Limit (dBm)	EUT Tx Status
-75.26	3.67	-78.93	-2.9	-76.03	-62	Ceased
-82.46	3.67	-86.13	-2.9	-83.23	-62	Minimal
-84.58	3.67	-88.25	-2.9	-85.35	-62	Normal

Incumbent AWGN at f_{c1}:

Measured Incumbent Power at the EUT Test Fixture Connector (dBm)	Test Fixture Cable Path Loss (dB)	Adjusted Incumbent Power at the Radio Port (dBm)	Antenna Gain (dBi)	Adjusted Incumbent Power at the Antenna (dBm)	Detection Limit (dBm)	EUT Tx Status
-72.63	3.67	-76.30	-2.9	-73.4	-62	Ceased
-76.56	3.67	-80.23	-2.9	-77.33	-62	Minimal
-79.62	3.67	-83.29	-2.9	-80.39	-62	Normal

Incumbent AWGN at f_{c3}:

Measured Incumbent Power at the EUT Test Fixture Connector (dBm)	Test Fixture Cable Path Loss (dB)	Adjusted Incumbent Power at the Radio Port (dBm)	Antenna Gain (dBi)	Adjusted Incumbent Power at the Antenna (dBm)	Detection Limit (dBm)	EUT Tx Status
-72.58	3.67	-76.25	-2.9	-73.35	-62	Ceased
-79.58	3.67	-83.25	-2.9	-80.35	-62	Minimal
-85.35	3.67	-89.02	-2.9	-86.12	-62	Normal

Test Date: 05/02 and 13/24

Tested by: 29445

Test location: DFS 1

9.6. U-NII 6 BAND TEST CONDITION 1 RESULTS

TEST CONDITION 1 CRITERIA

$$99\% BW_{EUT} \leq 99\% BW_{INC}$$

The lowest and highest supported channel bandwidths do not meet the criteria for this test condition therefore this test was not performed.

9.7. U-NII 6 BAND TEST CONDITION 2 RESULTS

TEST CONDITION 2 CRITERIA

$$99\% BW_{INC} < 99\% BW_{EUT} \leq 2 \times 99\% BW_{INC}$$

9.7.1. TEST CHANNEL

All tests were performed with the EUT set to a channel center frequency of 6455 MHz and a nominal channel bandwidth of 20 MHz.

Only the lowest and highest supported channel bandwidths are required to be tested.

9.7.2. INCUMBENT SIGNAL PLOTS

All tests were performed with the Incumbent Signal frequency set to the test channel center frequency and a nominal 99% Occupied Power Bandwidth of 10 MHz.

INCUMBENT SIGNAL 99% OCCUPIED POWER BANDWIDTH

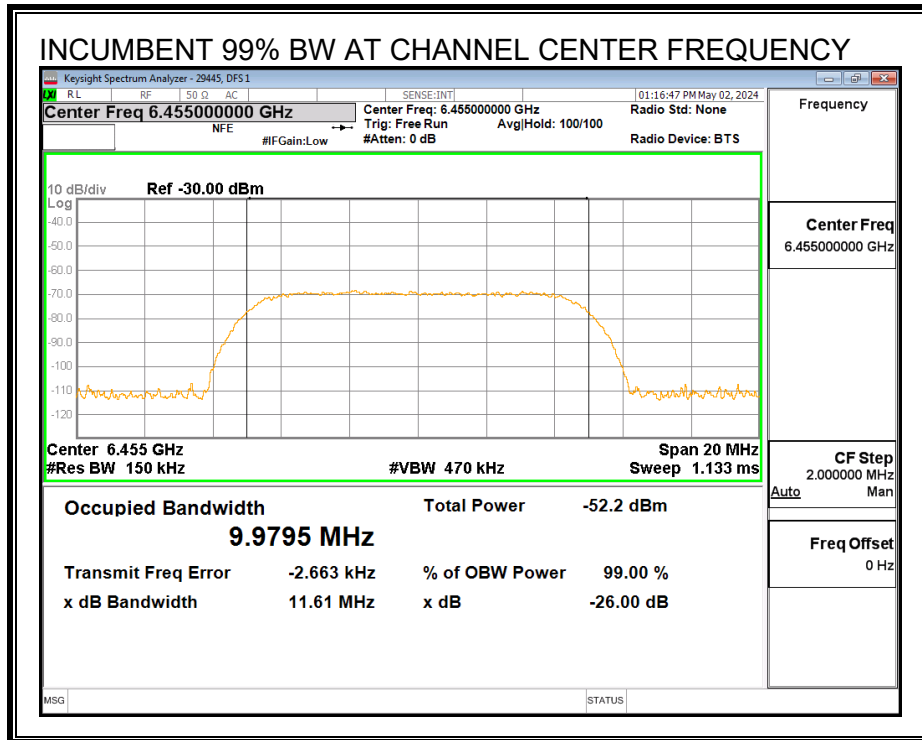

MINIMUM PASSING INCUMBENT SIGNAL POWER

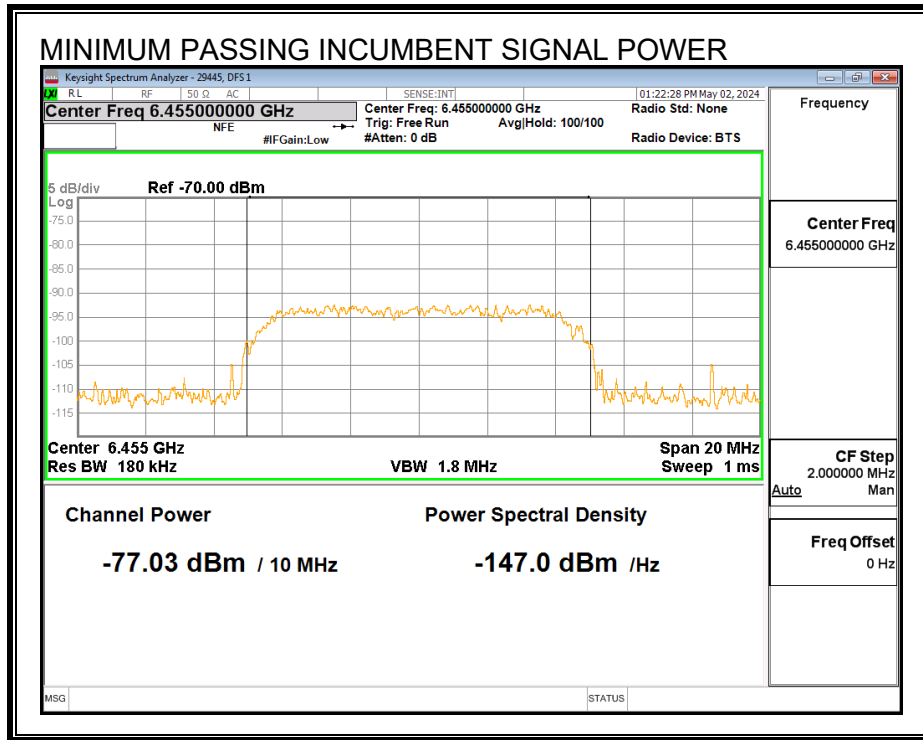

9.7.3. EUT TRANSMISSION PLOTS

EUT 99% OCCUPIED POWER BANDWIDTH

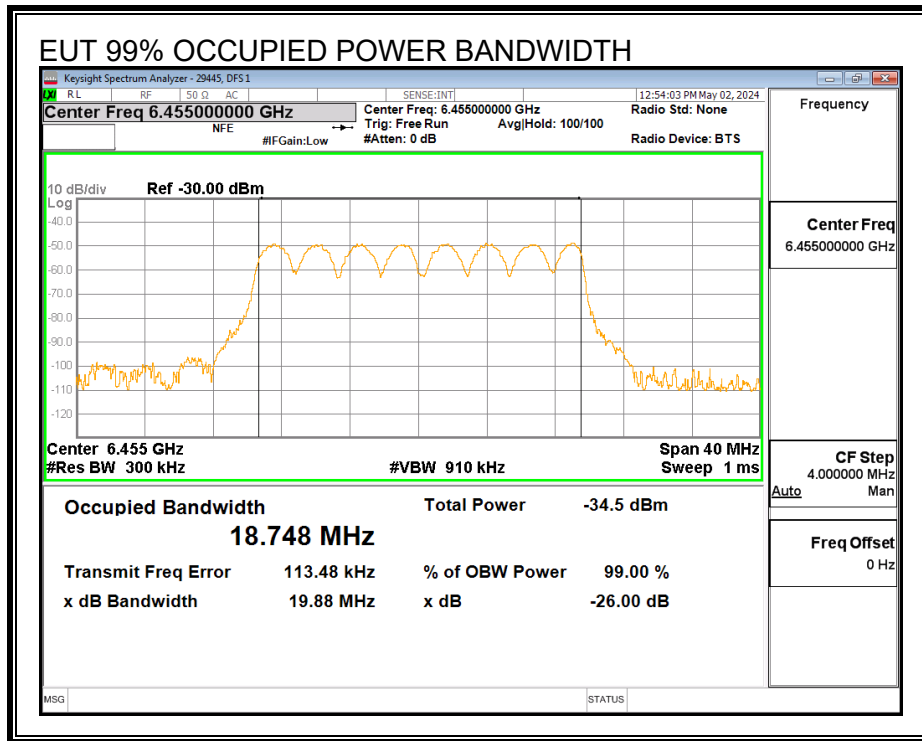

TRAFFIC WITHOUT THE INCUMBENT SIGNAL PRESENT

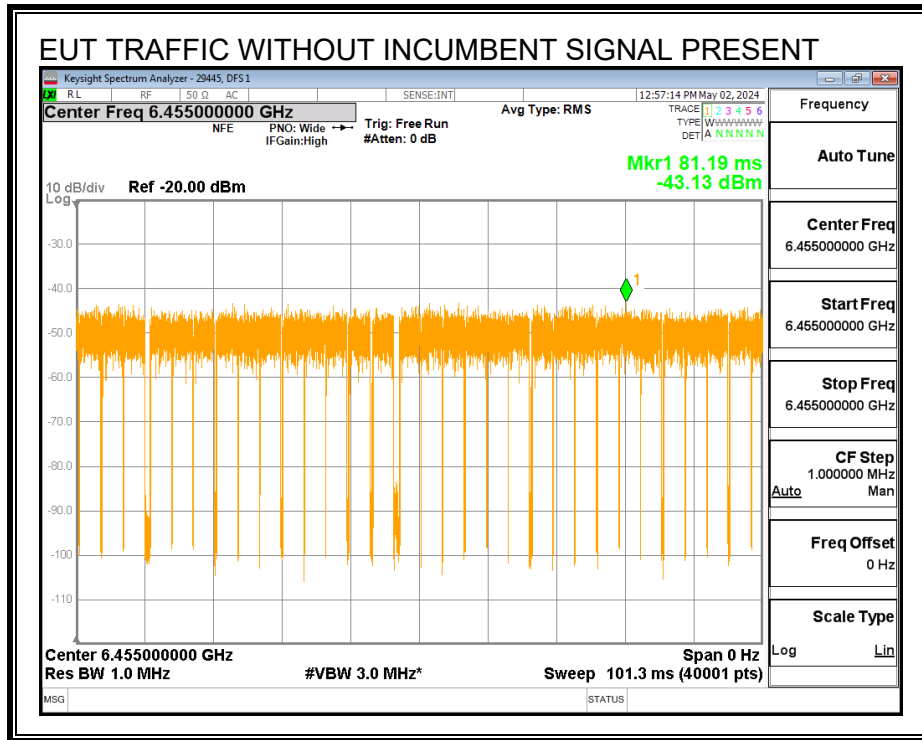

EUT RESPONSE TO THE APPLIED INCUMBENT SIGNAL

A link between the EUT and the Companion Device was established on the test channel. Traffic flowing from the EUT to the Companion Device was then initiated. A sweep was started, and the incumbent signal was continuously applied at approximately 5 seconds after the start of the sweep for a duration of 30 seconds and removed after the end of the observation period. Markers are placed at the beginning and end of the observation period.

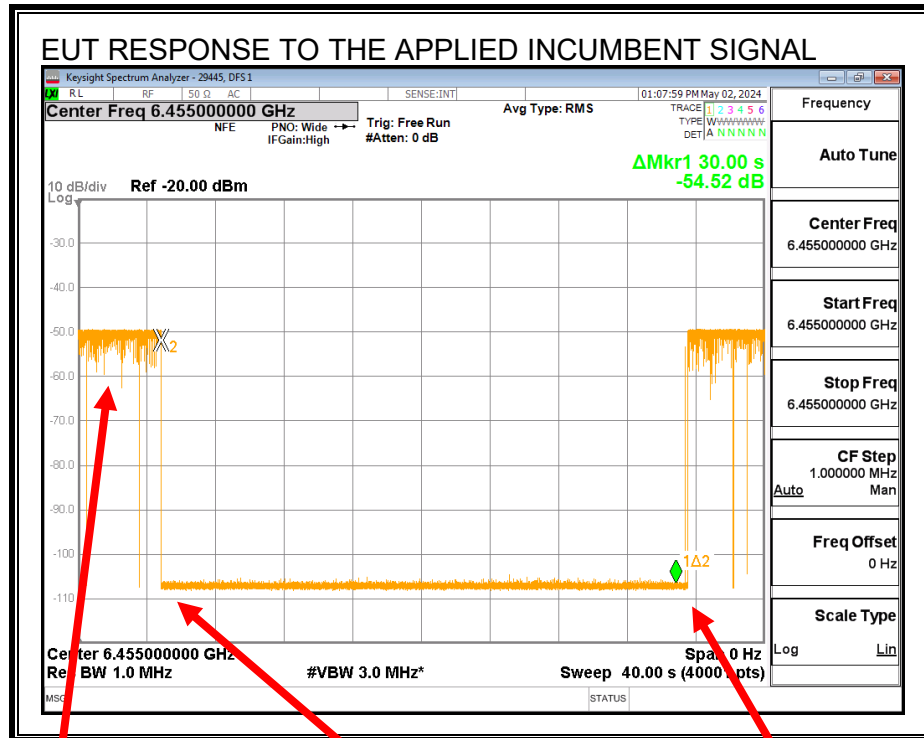

Normal Traffic

Application of Incumbent
Transmissions Ceased

Incumbent Removed
Transmissions Resume

Transmissions cease while the Incumbent AWGN Signal is present and resume after it is removed.

9.7.4. TABULATED TEST RESULTS

INCUMBENT SIGNAL DETECTION RESULTS

EUT Channel Center Frequency, f_{c1} (MHz)	6455
EUT Nominal Channel Bandwidth (MHz)	20
99% Occupied Bandwidth of the EUT (MHz)	18.748
EUT 99% OBW Lower Edge, F_L (MHz)	6445.63
EUT 99% OBW Upper Edge, F_H (MHz)	6464.37
Test Frequency of Incumbent Signal (MHz)	6455
Maximum Allowed Incumbent Amplitude at Antenna (dBm)	-62
Minimum Antenna Gain (dBi)	-3.70
Maximum Allowed Incumbent Amplitude at Radio Port (dBm)	-65.7
Lowest Passing Measured Incumbent Signal Amplitude (dBm)	-80.79
Margin (dBm)	-15.09
Result (PASS / FAIL)	PASS

Test Date: 05/02/24

Tested by: 29445

Test location: DFS 1

INCUMBENT SIGNAL DETECTION CERTAINTY RATE

AWGN Detected (Yes / No)	
Trial	Incumbent AWGN at f_{c1}
1	Yes
2	Yes
3	Yes
4	Yes
5	Yes
6	Yes
7	Yes
8	Yes
9	Yes
10	Yes
Test Result	PASS

Test Date: 05/02/24
Tested by: 29445
Test location: DFS 1

A minimum detection rate of 90% is required for the EUT to be compliant.

9.7.5. Tx OPERATIONAL STATUS TEST RESULTS

Test Condition 2: $99\% BW_{INC} < 99\% BW_{EUT} \leq 2 \times 99\% BW_{INC}$

Incumbent AWGN at f_{c1} :

Measured Incumbent Power at the EUT Test Fixture Connector (dBm)	Test Fixture Cable Path Loss (dB)	Adjusted Incumbent Power at the Radio Port (dBm)	Antenna Gain (dBi)	Adjusted Incumbent Power at the Antenna (dBm)	Detection Limit (dBm)	EUT Tx Status
-77.03	3.76	-80.79	-3.7	-77.09	-62	Ceased
-82.84	3.76	-86.60	-3.7	-82.90	-62	Minimal
-84.85	3.76	-88.61	-3.7	-84.91	-62	Normal

Test Date: 05/02/24

Tested by: 29445

Test location: DFS 1

9.8. U-NII 6 BAND TEST CONDITION 3 RESULTS

TEST CONDITION 3 CRITERIA

$$2 \times 99\% BW_{INC} < 99\% BW_{EUT} \leq 4 \times 99\% BW_{INC}$$

The lowest and highest supported channel bandwidths do not meet the criteria for this test condition therefore this test was not performed.

9.9. U-NII 6 BAND TEST CONDITION 4 RESULTS

TEST CONDITION 4 CRITERIA

$$99\% BW_{EUT} > 4 \times 99\% BW_{INC}$$

9.9.1. TEST CHANNEL

All tests were performed with the EUT set to a channel center frequency of 6505 MHz and a nominal channel bandwidth of 160 MHz.

Only the lowest and highest supported channel bandwidths are required to be tested.

9.9.2. INCUMBENT SIGNAL PLOTS

All tests were performed with the Incumbent Signal frequency set to the test channel center frequency and a nominal 99% Occupied Power Bandwidth of 10 MHz.

INCUMBENT SIGNAL 99% OCCUPIED POWER BANDWIDTH

Lower Edge Incumbent Signal f_{c2} :

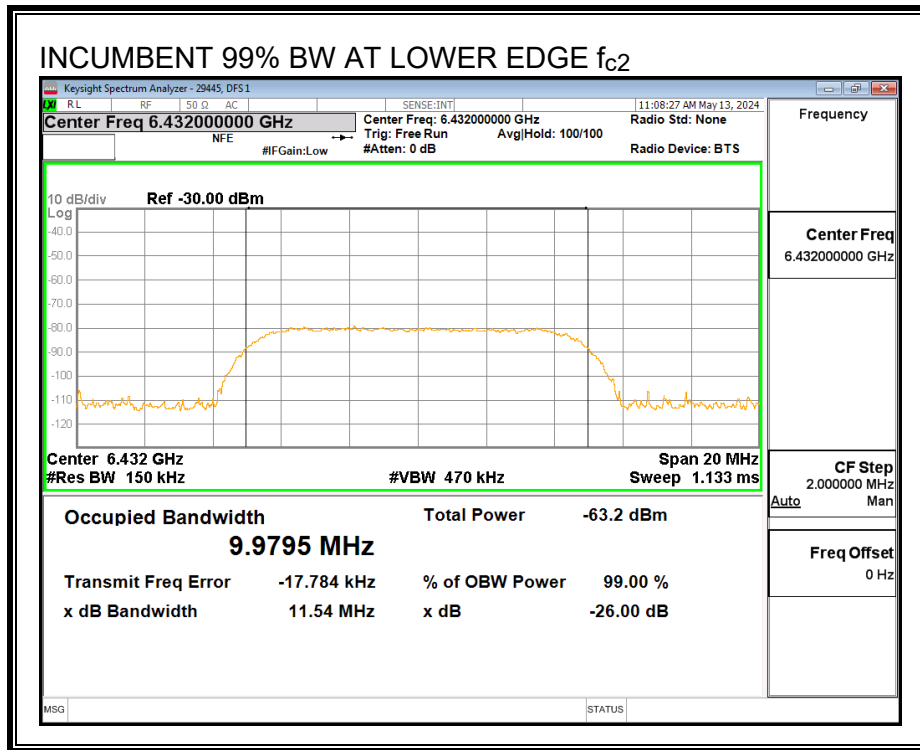

Center Frequency Incumbent Signal f_{c1} :

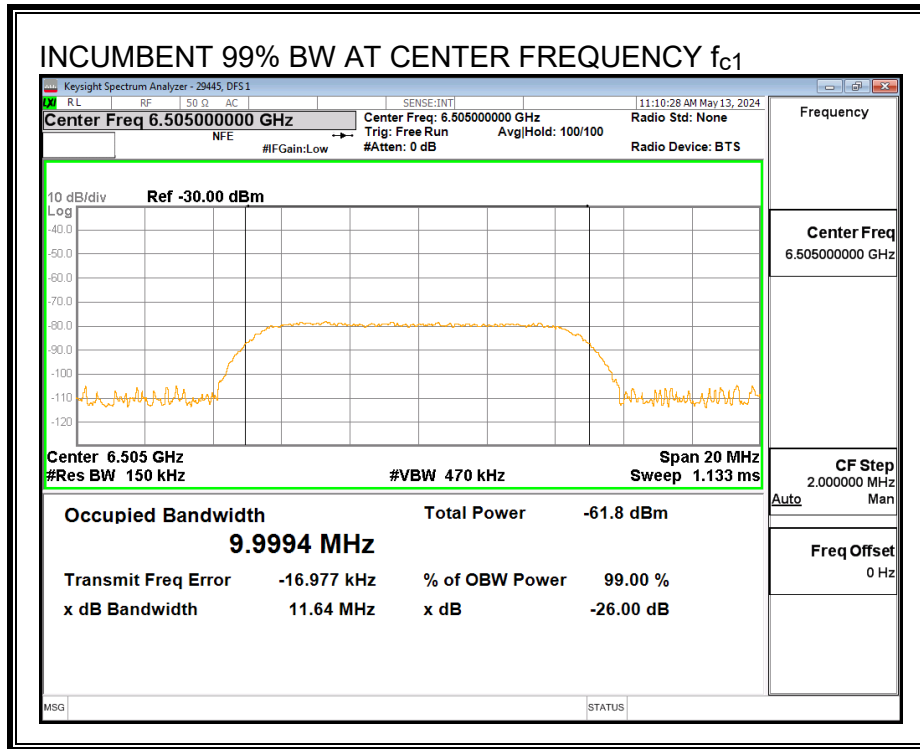

Upper Edge Incumbent Signal f_{c3} :

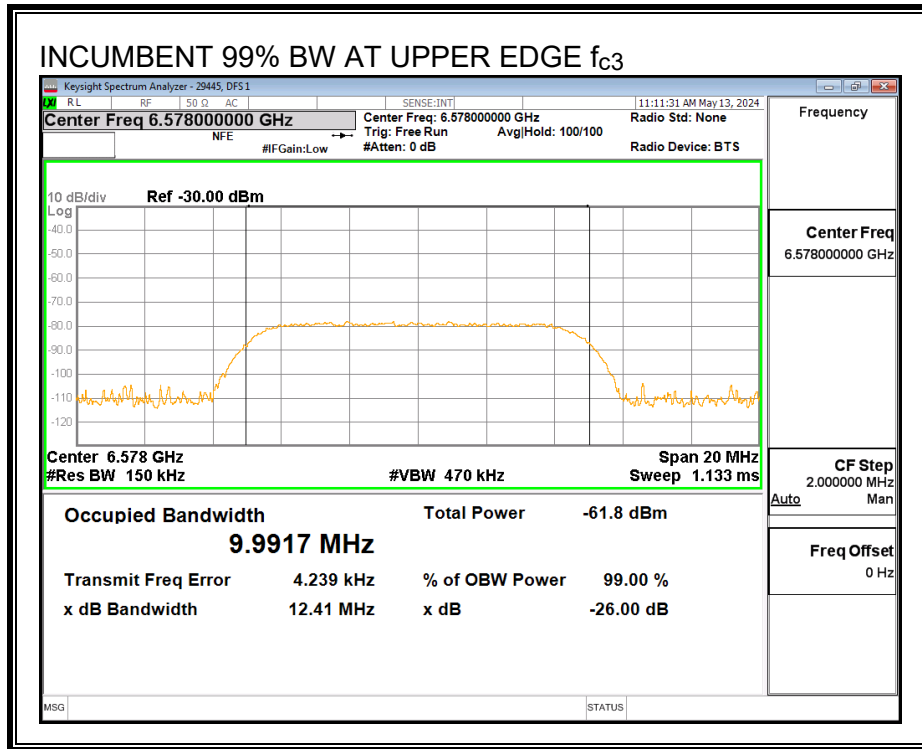

MINIMUM PASSING INCUMBENT SIGNAL POWER

Lower Edge Incumbent Signal f_{c2} :

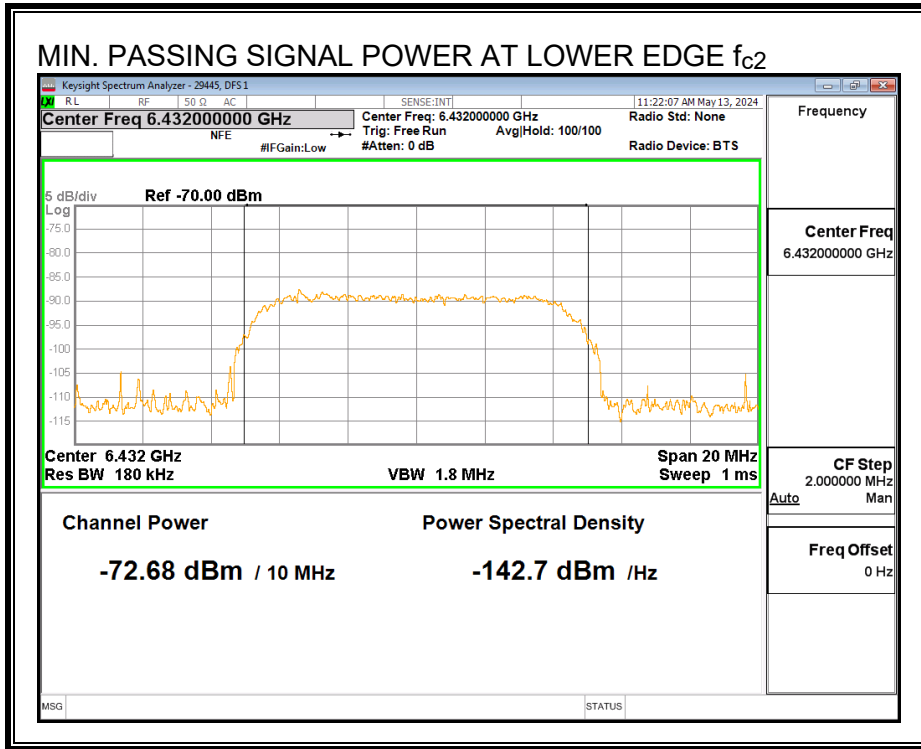

Center Frequency Incumbent Signal f_{c1} :

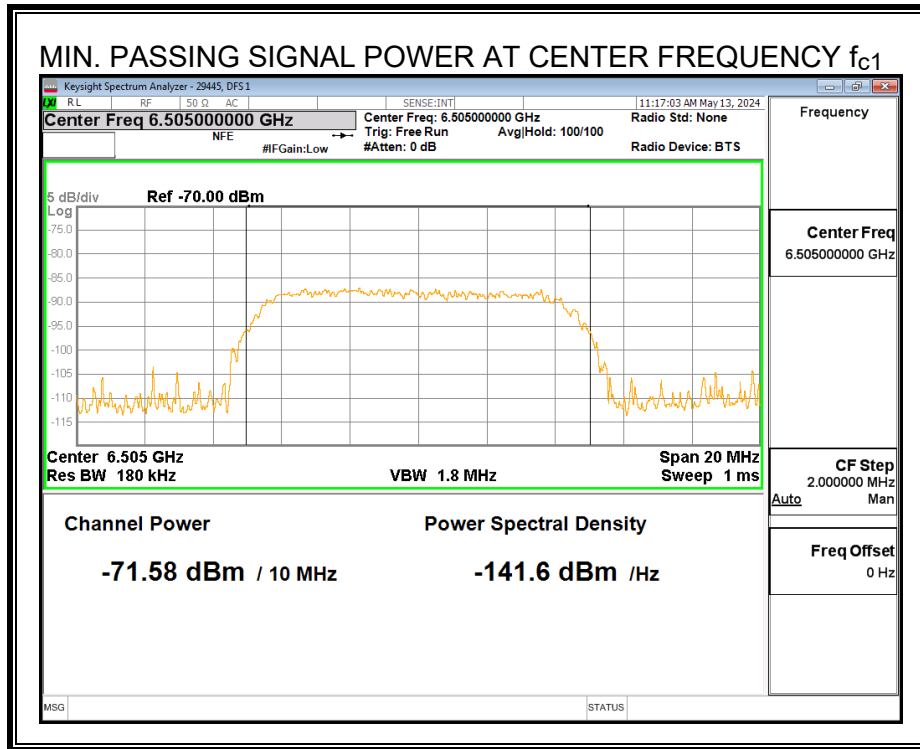

Upper Edge Incumbent Signal f_{c3} :

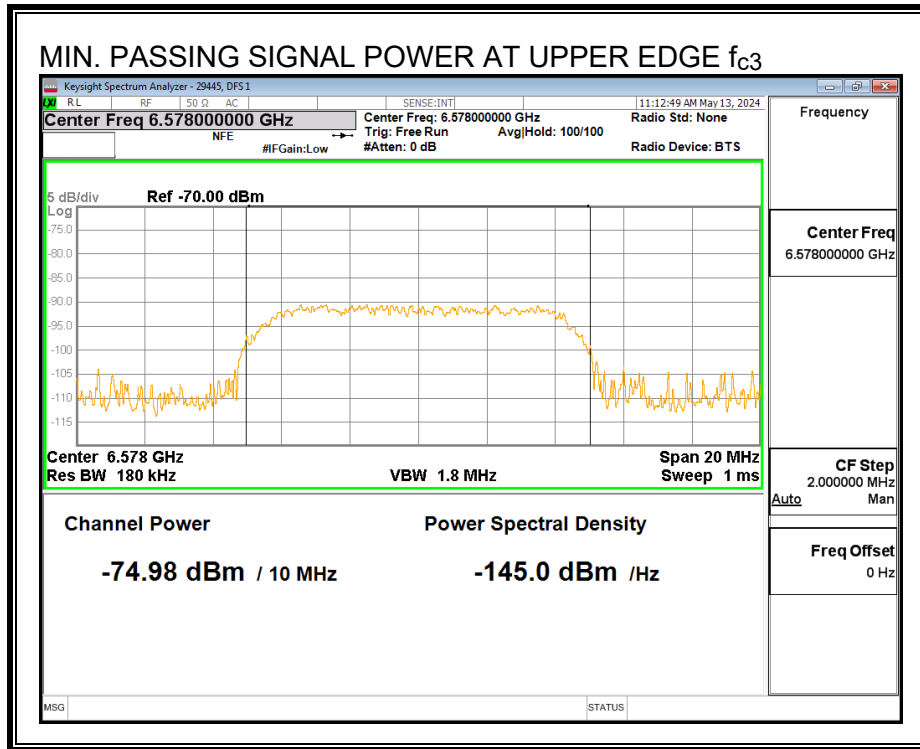

9.9.3. EUT TRANSMISSION PLOTS

EUT 99% OCCUPIED POWER BANDWIDTH

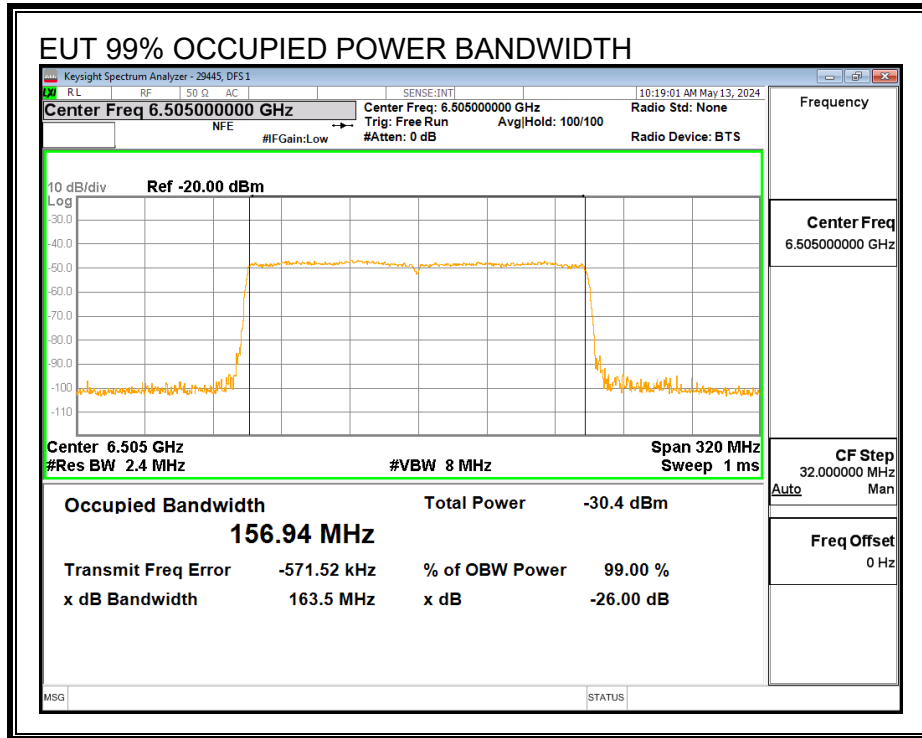

TRAFFIC WITHOUT THE INCUMBENT SIGNAL PRESENT

Lower Edge f_{c2} :

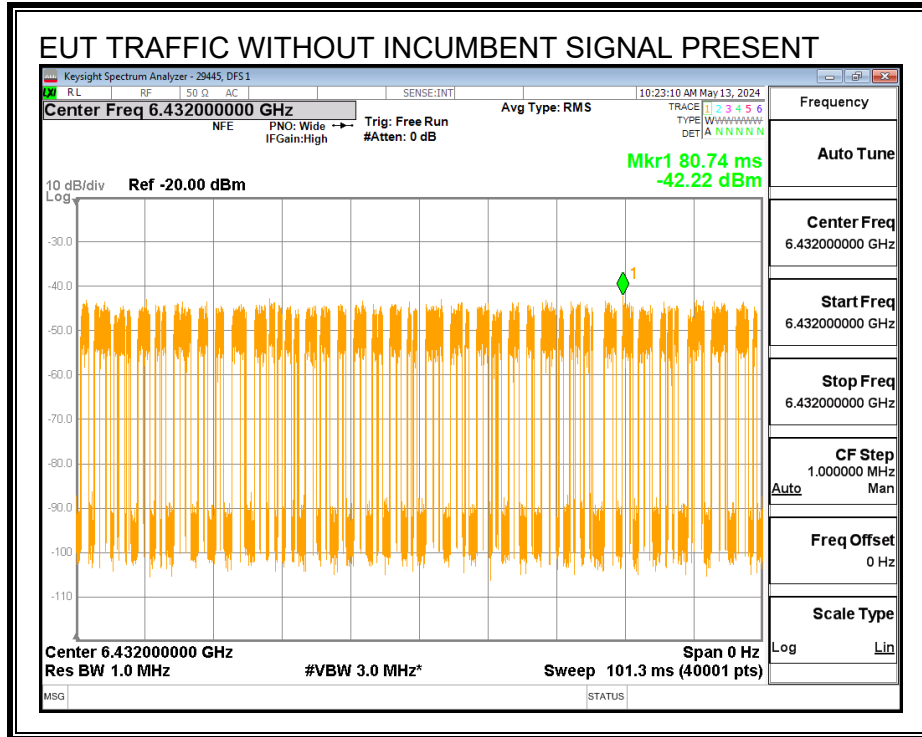

Center Frequency f_{c1} :

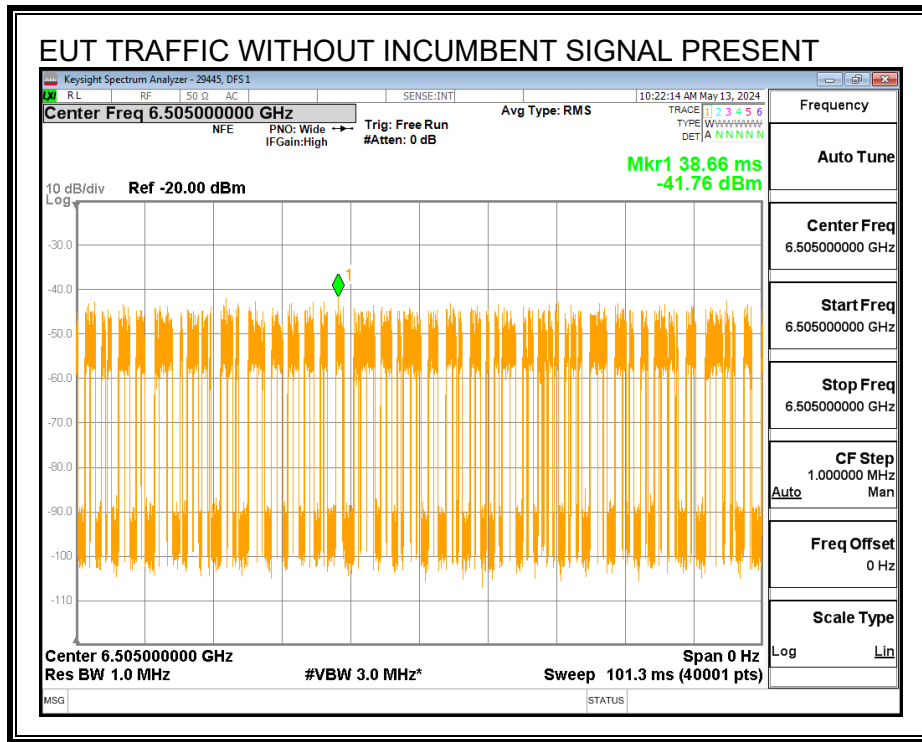

Upper Edge fc3:

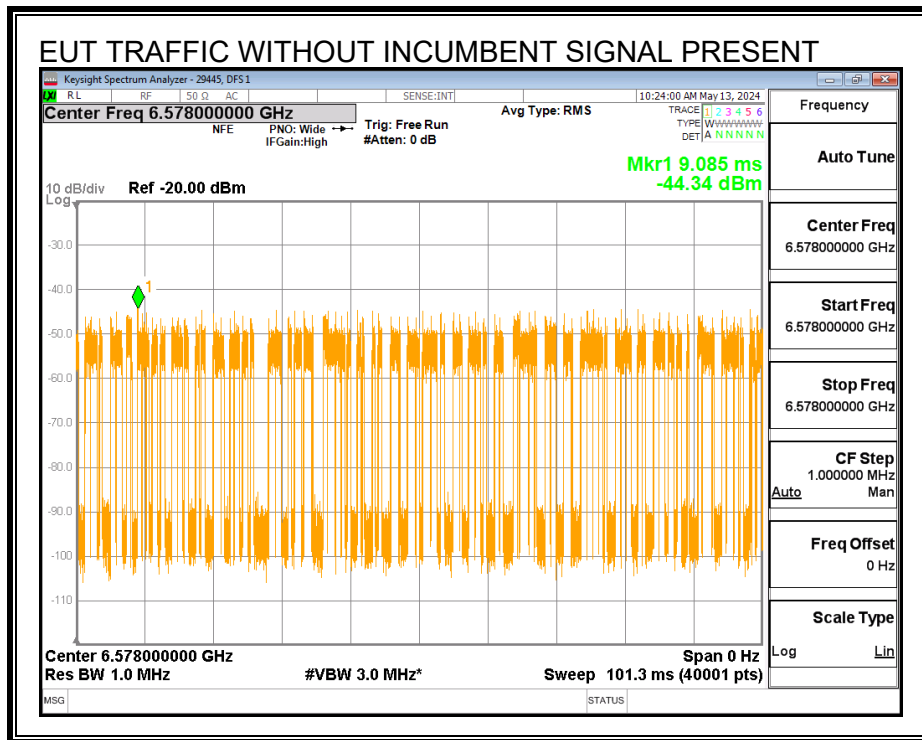

EUT RESPONSE TO THE APPLIED INCUMBENT SIGNAL

A link between the EUT and the Companion Device was established on the test channel. Traffic flowing from the EUT to the Companion Device was then initiated. A sweep was started, and the incumbent signal was continuously applied at approximately 5 seconds after the start of the sweep for a duration of 30 seconds and removed after the end of the observation period. Markers are placed at the beginning and end of the observation period.

Lower Edge Incumbent Signal f_{c2} :

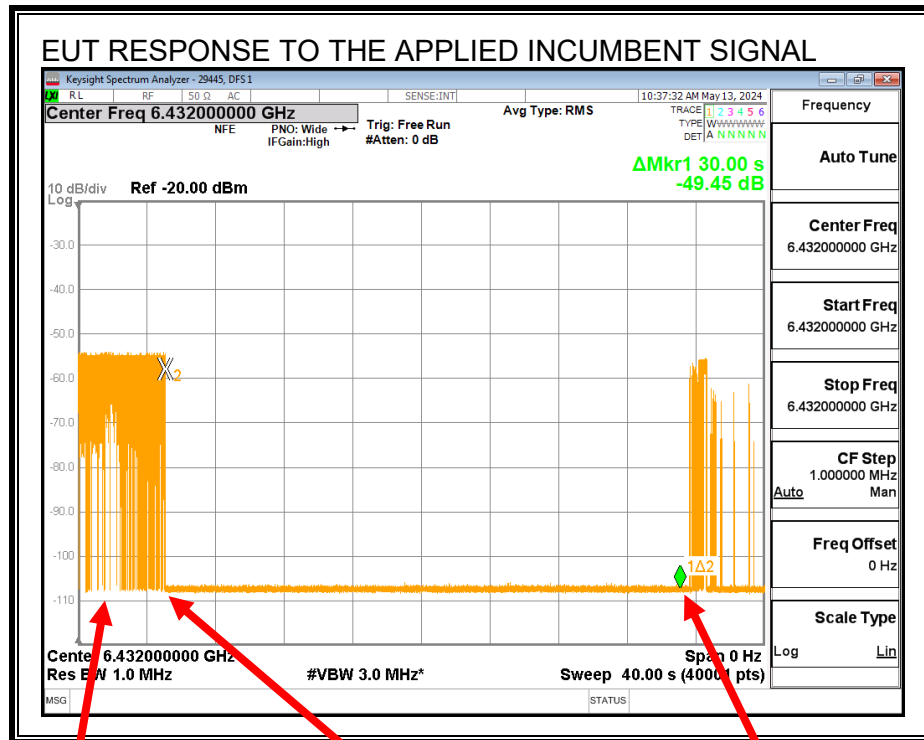

Normal Traffic

Application of Incumbent
Transmissions Ceased

Incumbent Removed
Transmissions Resume

Transmissions cease while the Incumbent AWGN Signal is present and resume after it is removed.

Center Frequency Incumbent Signal f_{c1} :

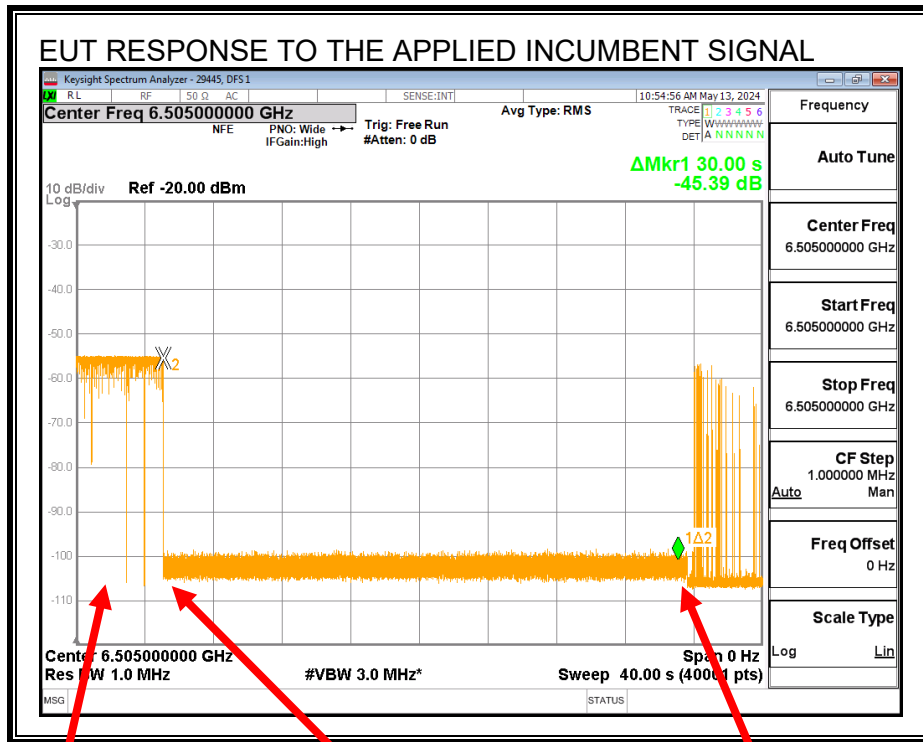

Normal Traffic

Application of Incumbent
Transmissions Ceased

Incumbent Removed
Transmissions Resume

Transmissions cease while the Incumbent AWGN Signal is present and resume after it is removed.

Upper Edge Incumbent Signal f_{c3}:

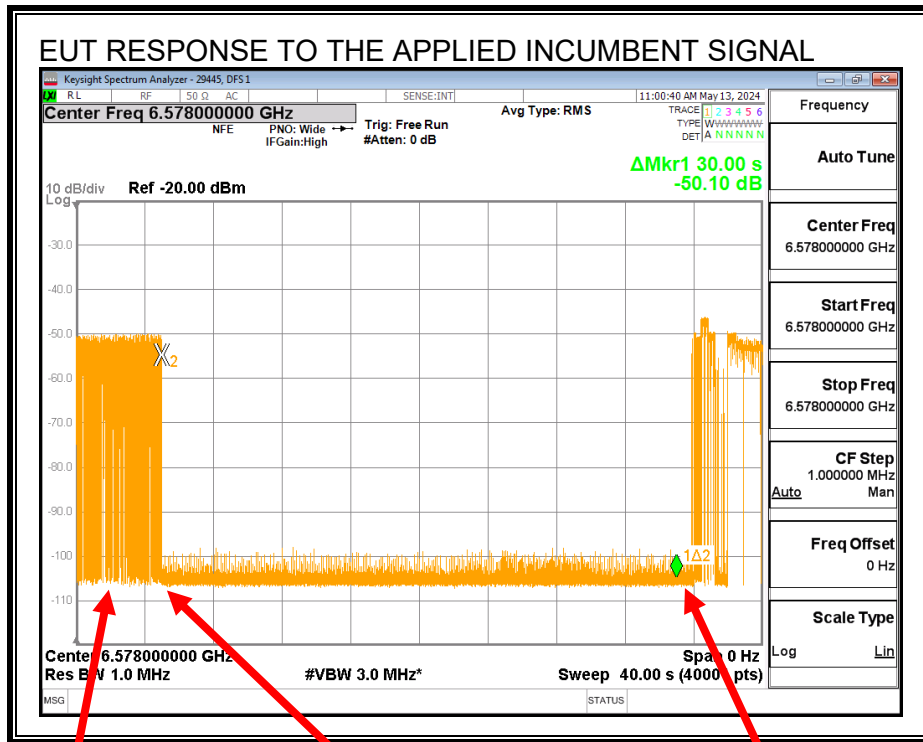

Normal Traffic

Application of Incumbent
Transmissions Ceased

Incumbent Removed
Transmissions Resume

Transmissions cease while the Incumbent AWGN Signal is present and resume after it is removed.

9.9.4. TABULATED TEST RESULTS

INCUMBENT SIGNAL DETECTION RESULTS

EUT Channel Center Frequency, f_{c1} (MHz)	6505
EUT Nominal Channel Bandwidth (MHz)	160
99% Occupied Bandwidth of the EUT (MHz)	156.94
EUT 99% OBW Lower Edge, F_L (MHz)	6426.53
EUT 99% OBW Upper Edge, F_H (MHz)	6583.47
99% Occupied Bandwidth of the Incumbent Signal (MHz)	9.9994
Test Frequency of Incumbent Signal (f_{c2}) Near EUT F_L (MHz)	6432
Test Frequency of Incumbent Signal at f_{c1} (MHz)	6505
Test Frequency of Incumbent Signal (f_{c3}) Near EUT F_H (MHz)	6578
Maximum Allowed Incumbent Amplitude at Antenna (dBm)	-62
Minimum Antenna Gain (dBi)	-3.70
Maximum Allowed Incumbent Amplitude at Radio Port (dBm)	-65.70
Lowest Passing Measured Incumbent Signal Amplitude at f_{c2} (dBm)	
	-76.55
Margin (dBm)	-10.85
Result (PASS / FAIL)	PASS
Lowest Passing Measured Incumbent Signal Amplitude at f_{c1} (dBm)	
	-75.45
Margin (dBm)	-9.75
Result (PASS / FAIL)	PASS
Lowest Passing Measured Incumbent Signal Amplitude at f_{c3} (dBm)	
	-78.85
Margin (dBm)	-13.15
Result (PASS / FAIL)	PASS

Test Date: 05/13/24
Tested by: 29445
Test location: DFS 1

INCUMBENT SIGNAL DETECTION CERTAINTY RATE

Trial	AWGN Detected (Yes / No)		
	Incumbent AWGN at f_{c2}	Incumbent AWGN at f_{c1}	Incumbent AWGN at f_{c3}
1	Yes	Yes	Yes
2	Yes	Yes	Yes
3	Yes	Yes	Yes
4	Yes	Yes	Yes
5	Yes	Yes	Yes
6	Yes	Yes	Yes
7	Yes	Yes	Yes
8	Yes	Yes	Yes
9	Yes	Yes	Yes
10	Yes	Yes	Yes
Test Result	PASS	PASS	PASS

Test Date: 05/13/24

Tested by: 29445

Test location: DFS 1

A minimum detection rate of 90% is required for the EUT to be compliant.

9.9.5. Tx OPERATIONAL STATUS TEST RESULTS

Test Condition 4: 99% BW_{EUT} > 4 x 99% BW_{INC}

Incumbent AWGN at f_{c2}:

Measured Incumbent Power at the EUT Test Fixture Connector (dBm)	Test Fixture Cable Path Loss (dB)	Adjusted Incumbent Power at the Radio Port (dBm)	Antenna Gain (dBi)	Adjusted Incumbent Power at the Antenna (dBm)	Detection Limit (dBm)	EUT Tx Status
-72.68	3.87	-76.55	-3.7	-72.85	-62	Ceased
-78.87	3.87	-82.74	-3.7	-79.04	-62	Minimal
-82.36	3.87	-86.23	-3.7	-82.53	-62	Normal

Incumbent AWGN at f_{c1}:

Measured Incumbent Power at the EUT Test Fixture Connector (dBm)	Test Fixture Cable Path Loss (dB)	Adjusted Incumbent Power at the Radio Port (dBm)	Antenna Gain (dBi)	Adjusted Incumbent Power at the Antenna (dBm)	Detection Limit (dBm)	EUT Tx Status
-71.58	3.87	-75.45	-3.7	-71.75	-62	Ceased
-77.52	3.87	-81.39	-3.7	-77.69	-62	Minimal
-80.49	3.87	-84.36	-3.7	-80.66	-62	Normal

Incumbent AWGN at f_{c3}:

Measured Incumbent Power at the EUT Test Fixture Connector (dBm)	Test Fixture Cable Path Loss (dB)	Adjusted Incumbent Power at the Radio Port (dBm)	Antenna Gain (dBi)	Adjusted Incumbent Power at the Antenna (dBm)	Detection Limit (dBm)	EUT Tx Status
-74.98	3.87	-78.85	-3.7	-75.15	-62	Ceased
-78.90	3.87	-82.77	-3.7	-79.07	-62	Minimal
-81.87	3.87	-85.74	-3.7	-82.04	-62	Normal

Test Date: 05/13/24

Tested by: 29445

Test location: DFS 1

9.10. U-NII 7 BAND TEST CONDITION 1 RESULTS

TEST CONDITION 1 CRITERIA

$$99\% BW_{EUT} \leq 99\% BW_{INC}$$

The lowest and highest supported channel bandwidths do not meet the criteria for this test condition therefore this test was not performed.

9.11. U-NII 7 BAND TEST CONDITION 2 RESULTS

TEST CONDITION 2 CRITERIA

$$99\% BW_{INC} < 99\% BW_{EUT} \leq 2 \times 99\% BW_{INC}$$

9.11.1. TEST CHANNEL

All tests were performed with the EUT set to a channel center frequency of 6695 MHz and a nominal channel bandwidth of 20 MHz.

Only the lowest and highest supported channel bandwidths are required to be tested.

9.11.2. INCUMBENT SIGNAL PLOTS

All tests were performed with the Incumbent Signal frequency set to the test channel center frequency and a nominal 99% Occupied Power Bandwidth of 10 MHz.

INCUMBENT SIGNAL 99% OCCUPIED POWER BANDWIDTH

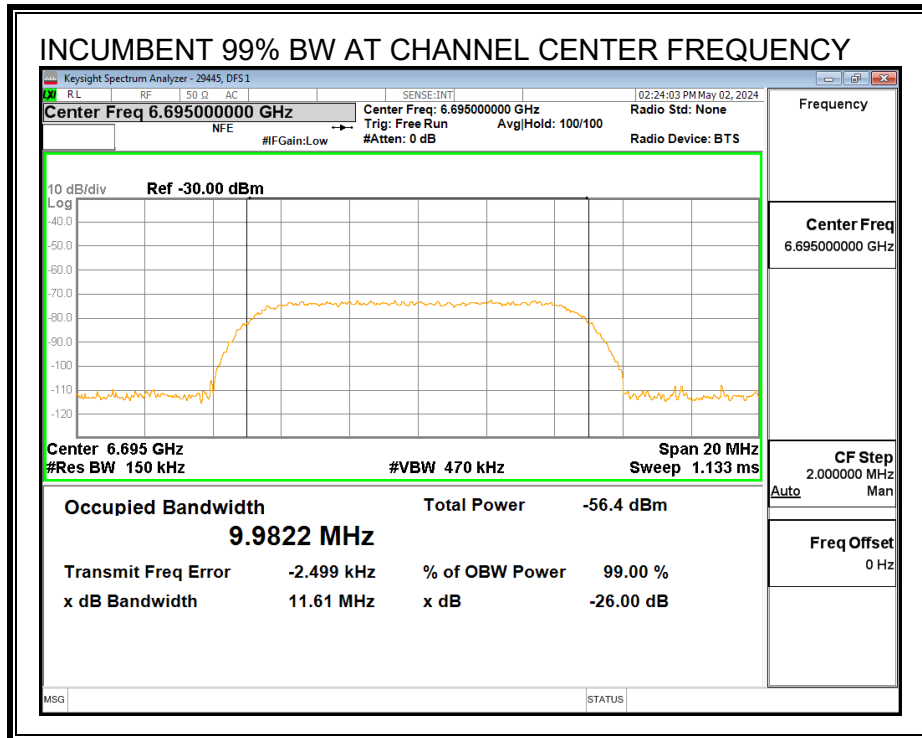

MINIMUM PASSING INCUMBENT SIGNAL POWER

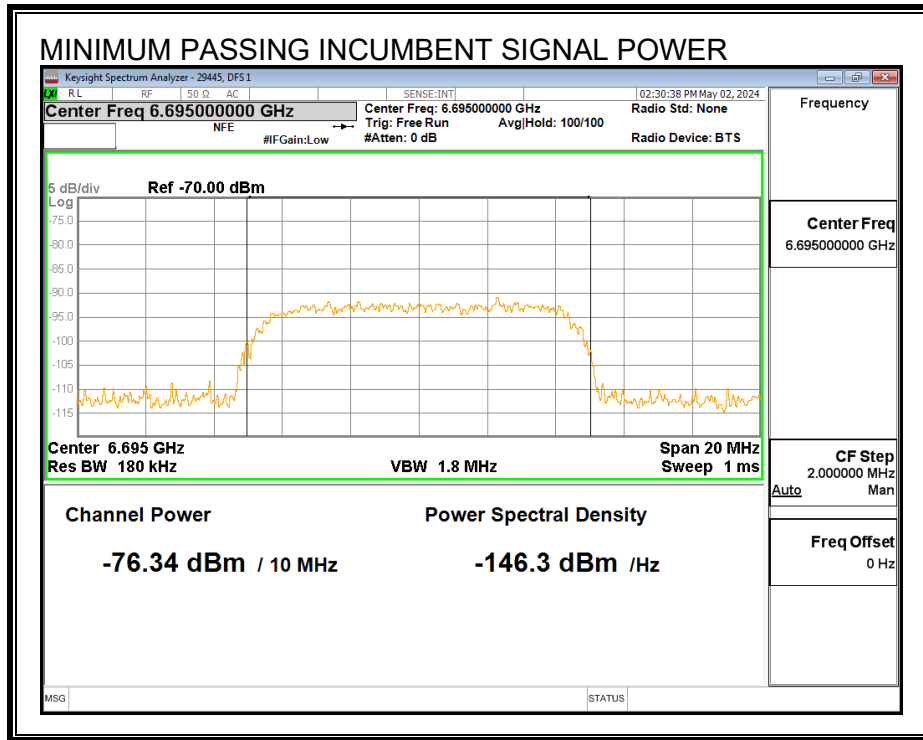

9.11.3. EUT TRANSMISSION PLOTS

EUT 99% OCCUPIED POWER BANDWIDTH

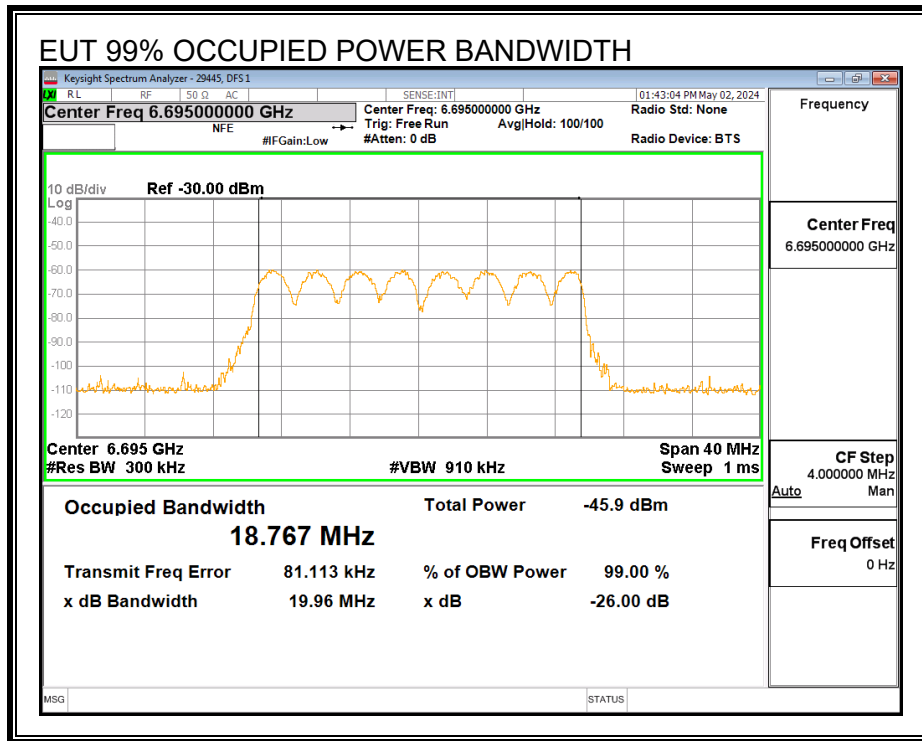

TRAFFIC WITHOUT THE INCUMBENT SIGNAL PRESENT

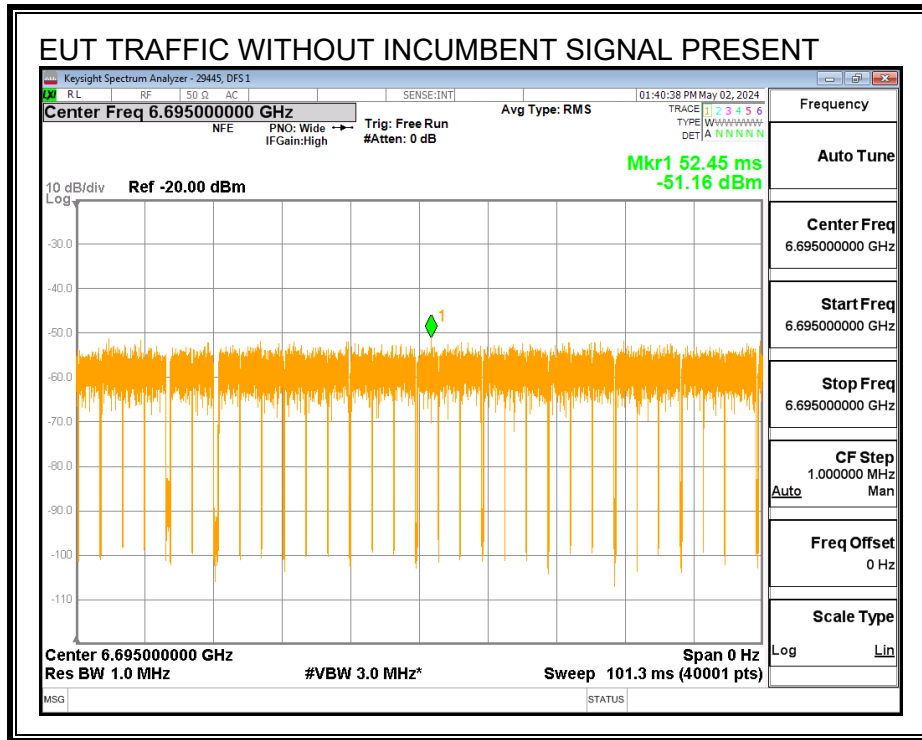

EUT RESPONSE TO THE APPLIED INCUMBENT SIGNAL

A link between the EUT and the Companion Device was established on the test channel. Traffic flowing from the EUT to the Companion Device was then initiated. A sweep was started, and the incumbent signal was continuously applied at approximately 5 seconds after the start of the sweep for a duration of 30 seconds and removed after the end of the observation period. Markers are placed at the beginning and end of the observation period.

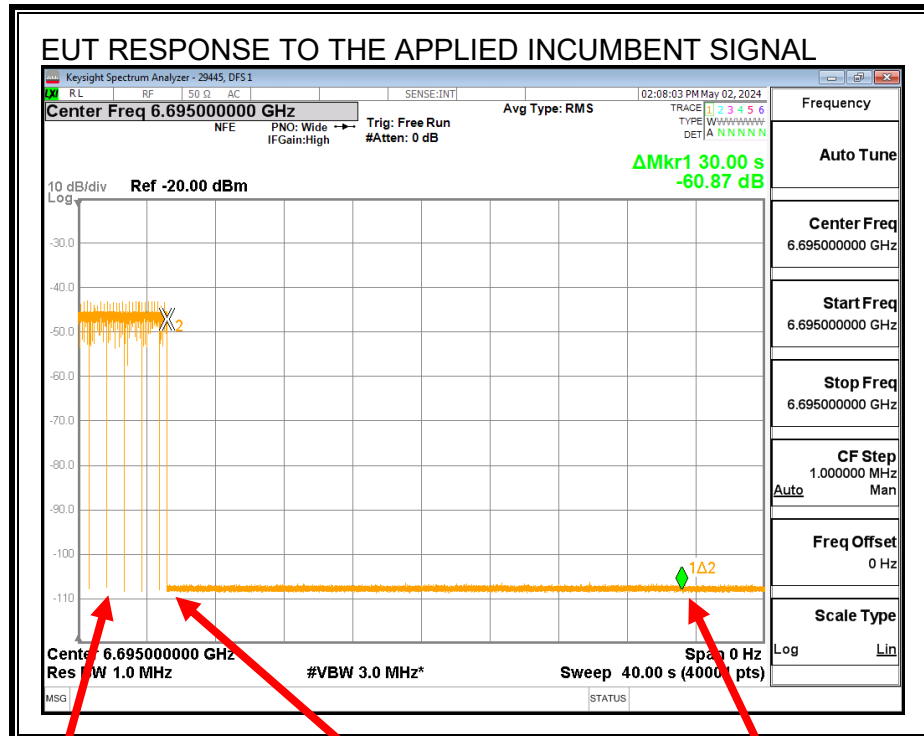

Normal Traffic

Application of Incumbent
Transmissions Ceased

Incumbent Removed
Association to Companion Lost

Transmissions cease while the Incumbent AWGN Signal is present and do not resume after it is removed due to the loss of the association to the Companion Device.

9.11.4. TABULATED TEST RESULTS

INCUMBENT SIGNAL DETECTION RESULTS

EUT Channel Center Frequency, f_{c1} (MHz)	6695
EUT Nominal Channel Bandwidth (MHz)	20
99% Occupied Bandwidth of the EUT (MHz)	18.767
EUT 99% OBW Lower Edge, F_L (MHz)	6685.62
EUT 99% OBW Upper Edge, F_H (MHz)	6704.38
Test Frequency of Incumbent Signal (MHz)	6695
Maximum Allowed Incumbent Amplitude at Antenna (dBm)	-62
Minimum Antenna Gain (dBi)	-5.8
Maximum Allowed Incumbent Amplitude at Radio Port (dBm)	-67.8
<hr/>	
Lowest Passing Measured Incumbent Signal Amplitude (dBm)	-80.22
Margin (dBm)	-12.42
Result (PASS / FAIL)	PASS

Test Date: 05/02/24

Tested by: 29445

Test location: DFS 1

INCUMBENT SIGNAL DETECTION CERTAINTY RATE

	AWGN Detected (Yes / No)
Trial	Incumbent AWGN at f_{c1}
1	Yes
2	Yes
3	Yes
4	Yes
5	Yes
6	Yes
7	Yes
8	Yes
9	Yes
10	Yes
Test Result	PASS

Test Date: 05/02/24
Tested by: 29445
Test location: DFS 1

A minimum detection rate of 90% is required for the EUT to be compliant.

9.11.5. Tx OPERATIONAL STATUS TEST RESULTS

Test Condition 2: $99\% BW_{INC} < 99\% BW_{EUT} \leq 2 \times 99\% BW_{INC}$

Incumbent AWGN at f_{c1} :

Measured Incumbent Power at the EUT Test Fixture Connector (dBm)	Test Fixture Cable Path Loss (dB)	Adjusted Incumbent Power at the Radio Port (dBm)	Antenna Gain (dBi)	Adjusted Incumbent Power at the Antenna (dBm)	Detection Limit (dBm)	EUT Tx Status
-76.34	3.88	-80.22	-5.8	-74.42	-62	Ceased
-81.97	3.88	-85.85	-5.8	-80.05	-62	Minimal
-86.21	3.88	-90.09	-5.8	-84.29	-62	Normal

Test Date: 05/02/24

Tested by: 29445

Test location: DFS 1

9.12. U-NII 7 BAND TEST CONDITION 3 RESULTS

TEST CONDITION 3 CRITERIA

$$2 \times 99\% BW_{INC} < 99\% BW_{EUT} \leq 4 \times 99\% BW_{INC}$$

The lowest and highest supported channel bandwidths do not meet the criteria for this test condition therefore this test was not performed.

9.13. U-NII 7 BAND TEST CONDITION 4 RESULTS

TEST CONDITION 4 CRITERIA

$$99\% BW_{EUT} > 4 \times 99\% BW_{INC}$$

9.13.1. TEST CHANNEL

All tests were performed with the EUT set to a channel center frequency of 6665 MHz and a nominal channel bandwidth of 160 MHz.

Only the lowest and highest supported channel bandwidths are required to be tested.

9.13.2. INCUMBENT SIGNAL PLOTS

All tests were performed with the Incumbent Signal frequency set to the test channel center frequency and a nominal 99% Occupied Power Bandwidth of 10 MHz.

INCUMBENT SIGNAL 99% OCCUPIED POWER BANDWIDTH

Lower Edge Incumbent Signal f_{c2} :

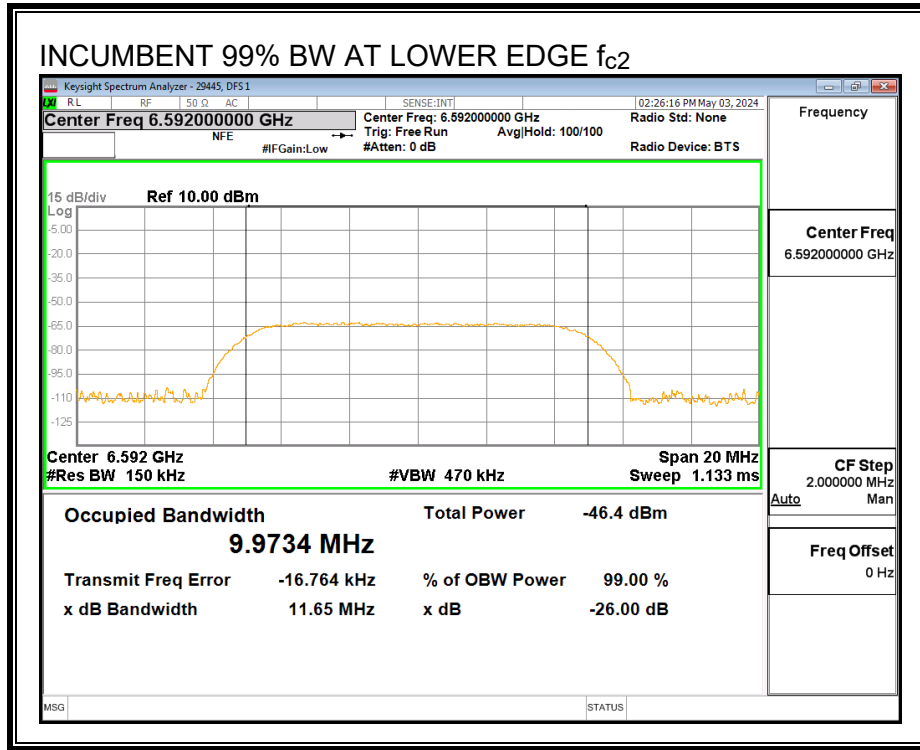

Center Frequency Incumbent Signal f_{c1} :

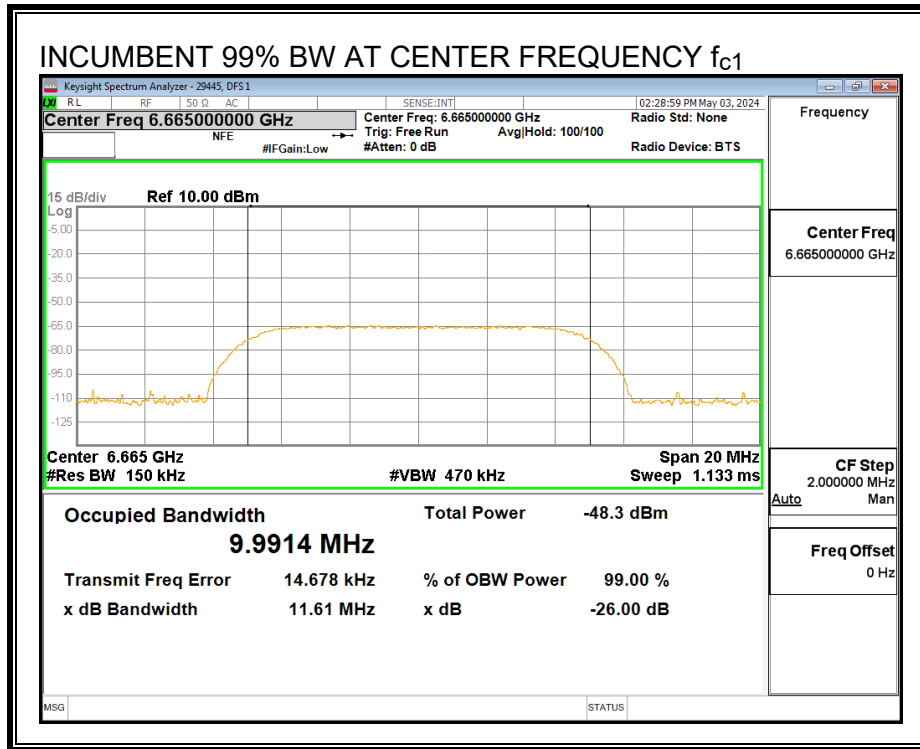

Upper Edge Incumbent Signal f_{c3} :

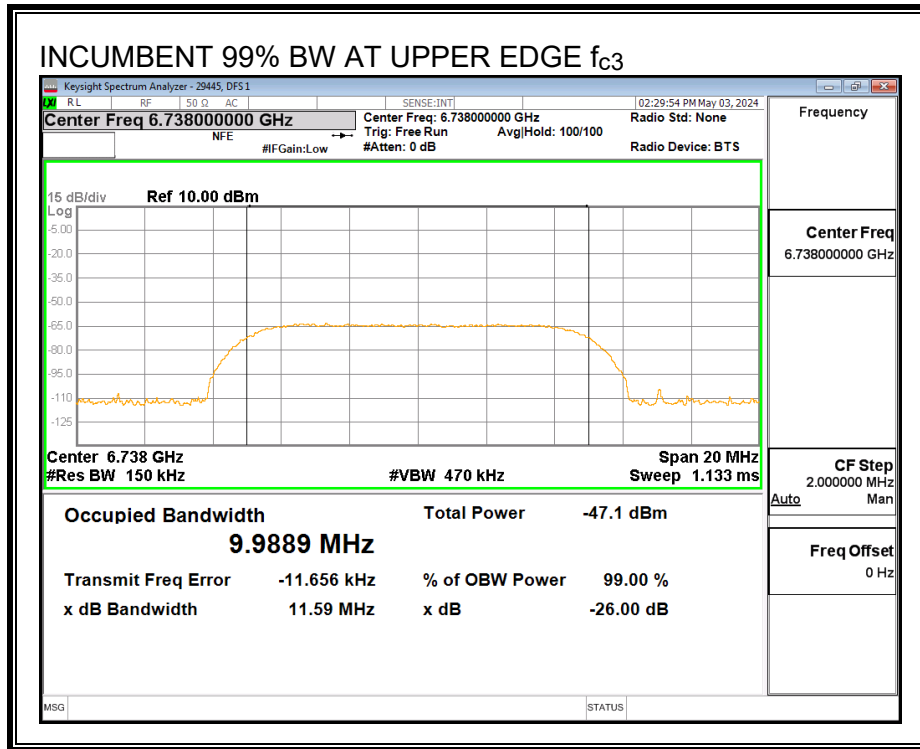

MINIMUM PASSING INCUMBENT SIGNAL POWER

Lower Edge Incumbent Signal f_{c2} :

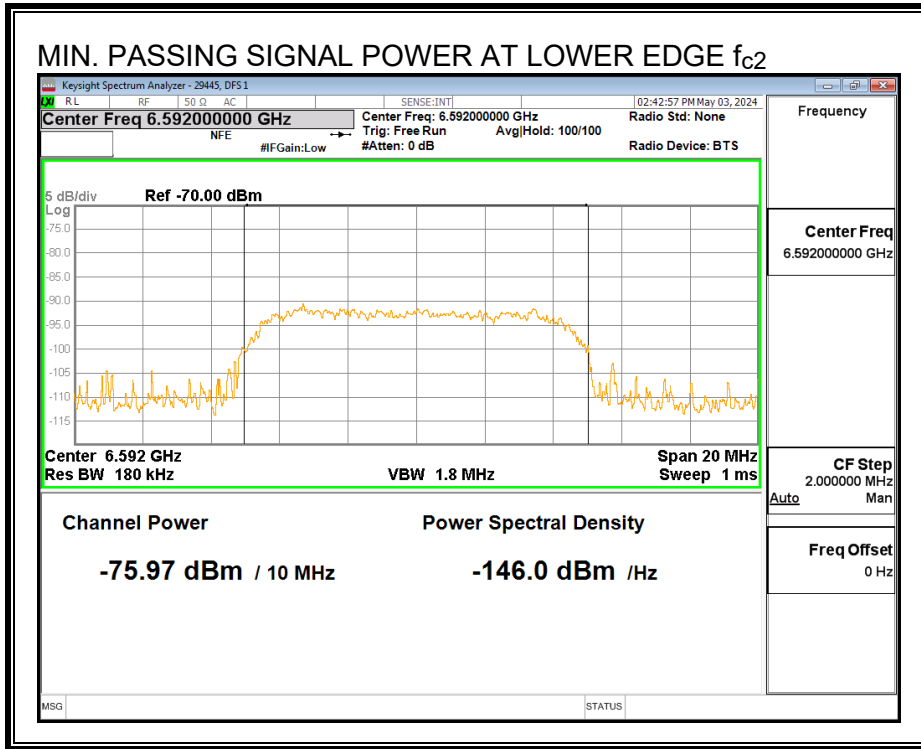

Center Frequency Incumbent Signal f_{c1} :

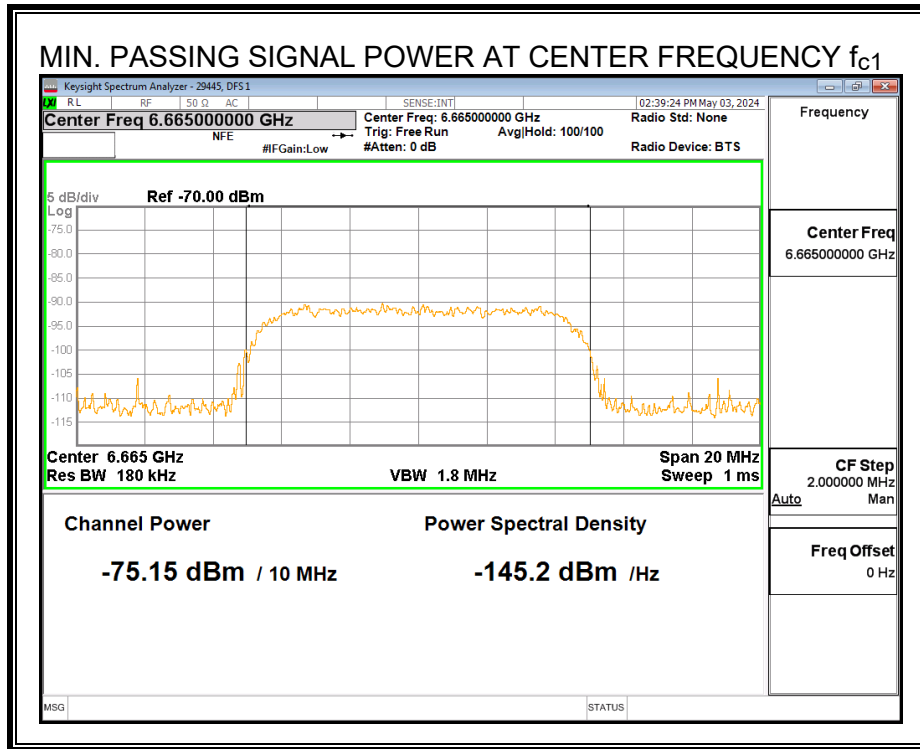

Upper Edge Incumbent Signal f_{c3} :

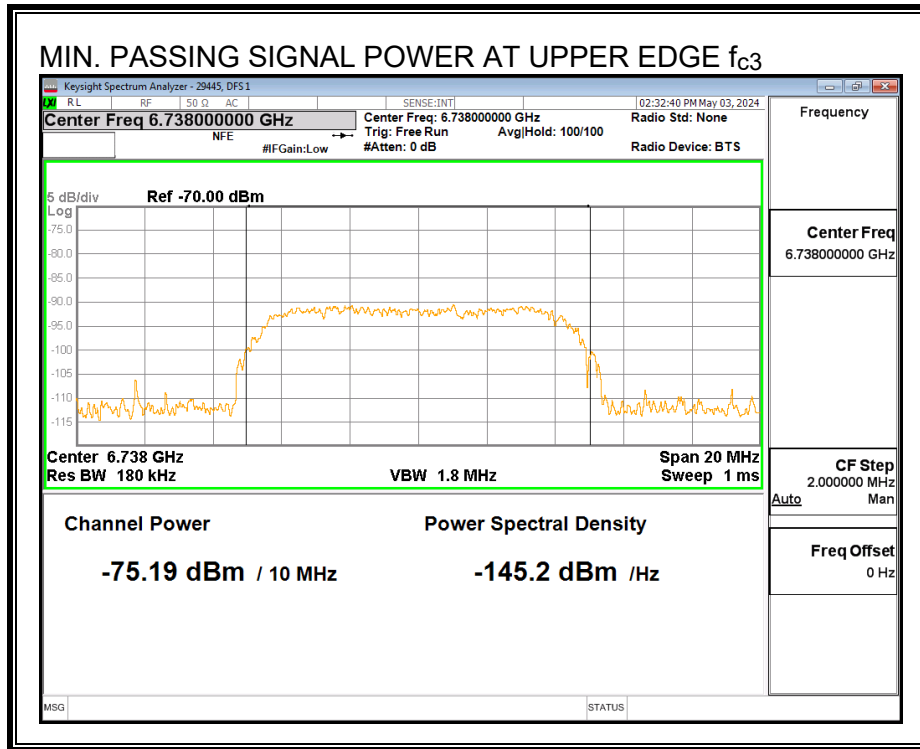

9.13.3. EUT TRANSMISSION PLOTS

EUT 99% OCCUPIED POWER BANDWIDTH

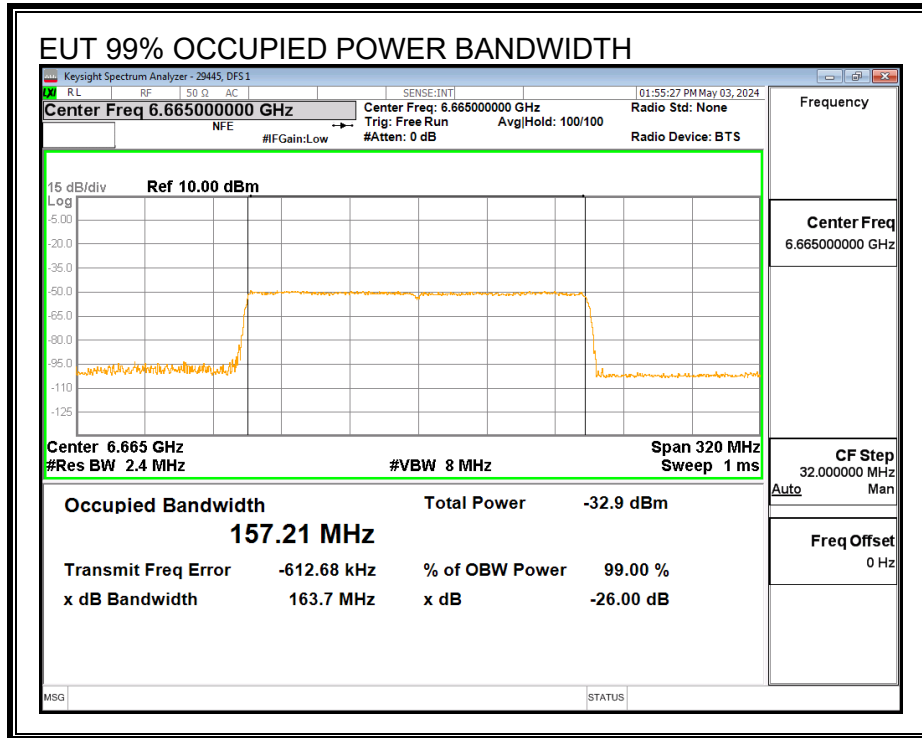

TRAFFIC WITHOUT THE INCUMBENT SIGNAL PRESENT

Lower Edge f_{c2} :

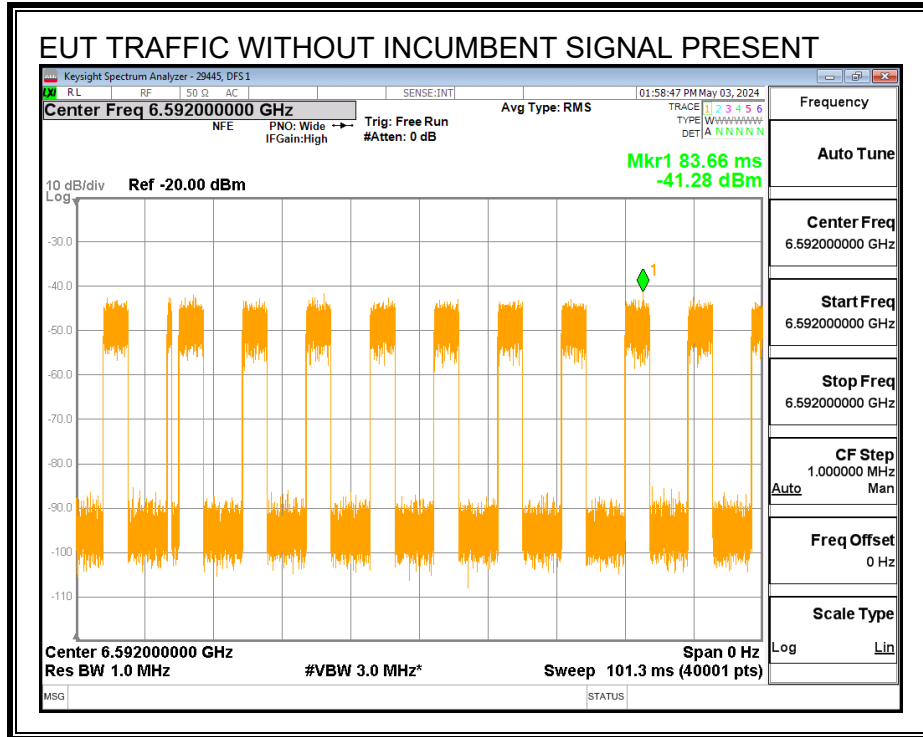

Center Frequency f_{c1} :

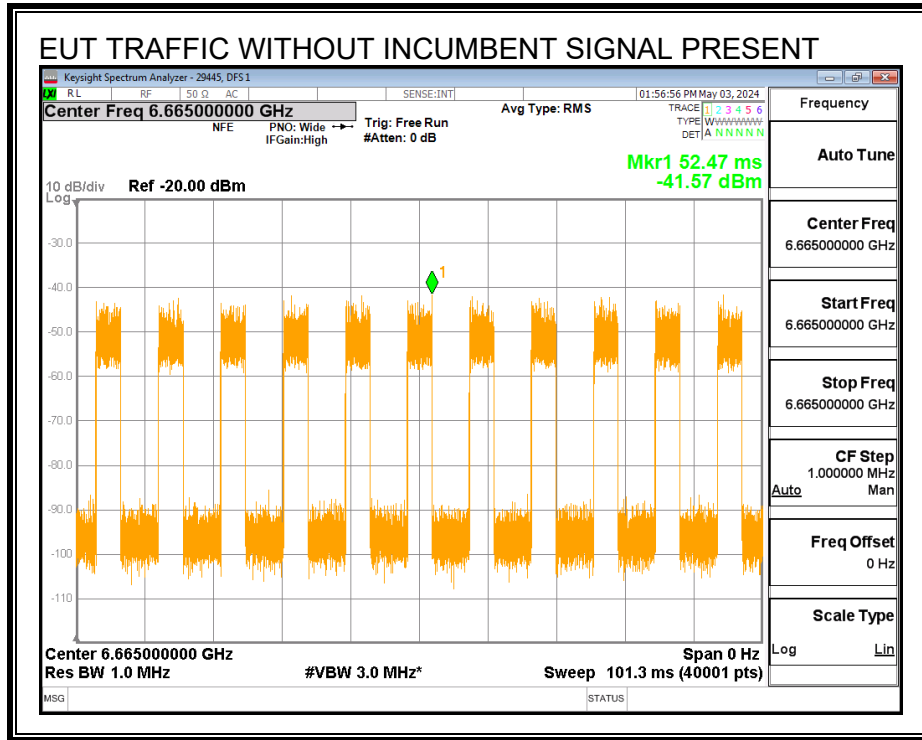

Upper Edge fc3:

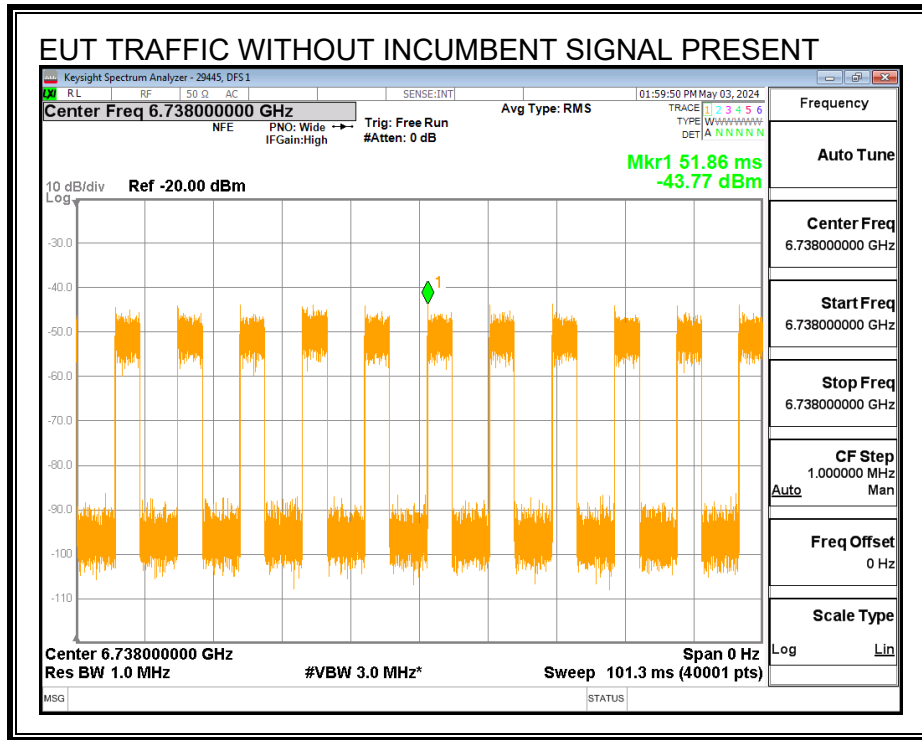

EUT RESPONSE TO THE APPLIED INCUMBENT SIGNAL

A link between the EUT and the Companion Device was established on the test channel. Traffic flowing from the EUT to the Companion Device was then initiated. A sweep was started, and the incumbent signal was continuously applied at approximately 5 seconds after the start of the sweep for a duration of 30 seconds and removed after the end of the observation period. Markers are placed at the beginning and end of the observation period.

Lower Edge Incumbent Signal f_{c2} :

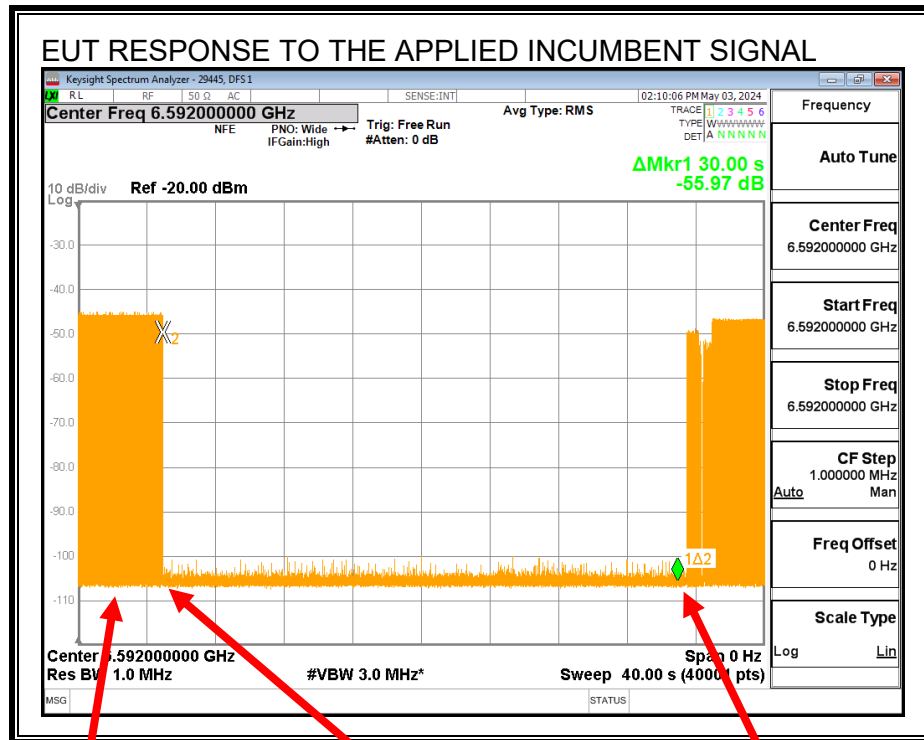

Normal Traffic

Application of Incumbent
Transmissions Ceased

Incumbent Removed
Transmissions Resume

Transmissions cease while the Incumbent AWGN Signal is present and resume after it is removed.

Center Frequency Incumbent Signal f_{c1} :

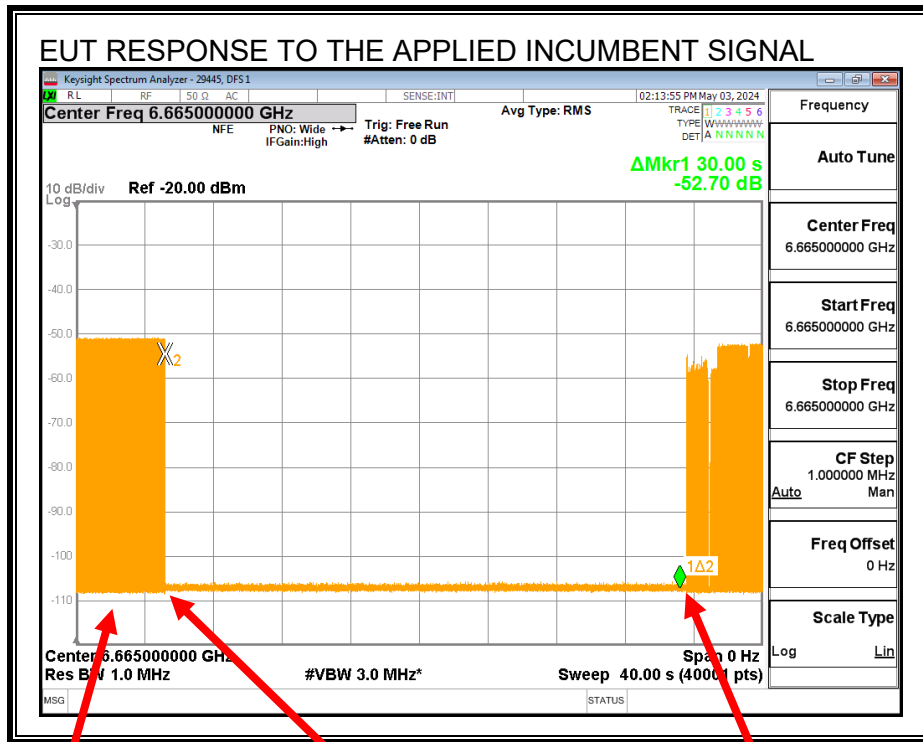

Normal Traffic

Application of Incumbent
Transmissions Ceased

Incumbent Removed
Transmissions Resume

Transmissions cease while the Incumbent AWGN Signal is present and resume after it is removed.

Upper Edge Incumbent Signal f_{c3}:

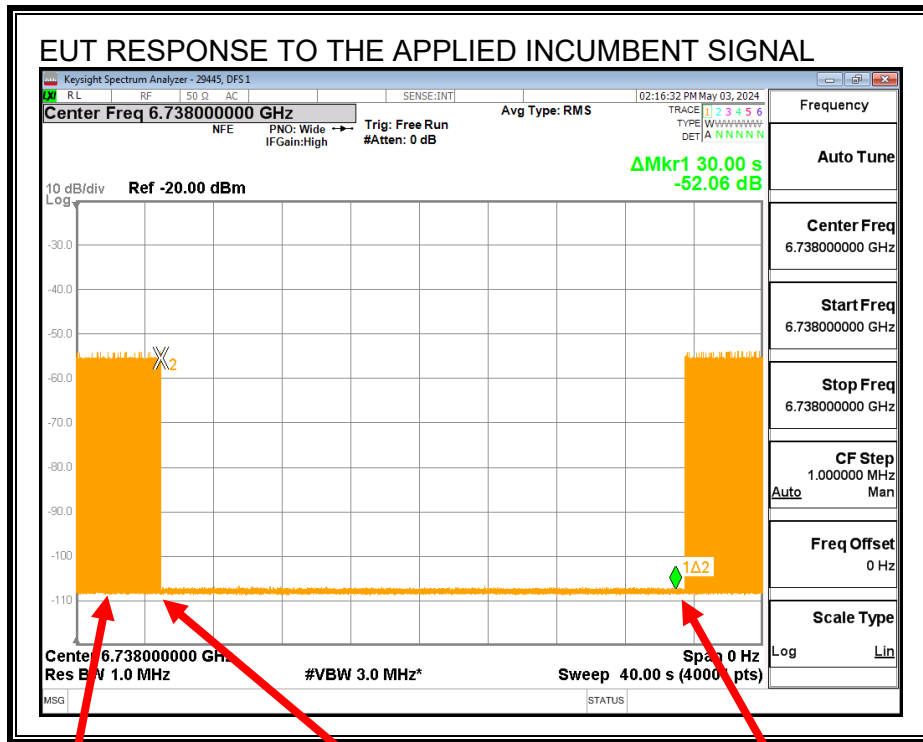

Normal Traffic

Application of Incumbent
Transmissions Ceased

Incumbent Removed
Transmissions Resume

Transmissions cease while the Incumbent AWGN Signal is present and resume after it is removed.

9.13.4. TABULATED TEST RESULTS

INCUMBENT SIGNAL DETECTION RESULTS

EUT Channel Center Frequency, f_{c1} (MHz)	6665
EUT Nominal Channel Bandwidth (MHz)	160
99% Occupied Bandwidth of the EUT (MHz)	157.21
EUT 99% OBW Lower Edge, F_L (MHz)	6586.40
EUT 99% OBW Upper Edge, F_H (MHz)	6743.61
99% Occupied Bandwidth of the Incumbent Signal (MHz)	9.9914
Test Frequency of Incumbent Signal (f_{c2}) Near EUT F_L (MHz)	6592
Test Frequency of Incumbent Signal at f_{c1} (MHz)	6665
Test Frequency of Incumbent Signal (f_{c3}) Near EUT F_H (MHz)	6738
Maximum Allowed Incumbent Amplitude at Antenna (dBm)	-62
Minimum Antenna Gain (dBi)	-5.8
Maximum Allowed Incumbent Amplitude at Radio Port (dBm)	-67.80
Lowest Passing Measured Incumbent Signal Amplitude at f_{c2} (dBm)	
	-79.89
Margin (dBm)	-12.09
Result (PASS / FAIL)	PASS
Lowest Passing Measured Incumbent Signal Amplitude at f_{c1} (dBm)	
	-79.07
Margin (dBm)	-11.27
Result (PASS / FAIL)	PASS
Lowest Passing Measured Incumbent Signal Amplitude at f_{c3} (dBm)	
	-79.11
Margin (dBm)	-11.31
Result (PASS / FAIL)	PASS

Test Date: 05/03/24
Tested by: 29445
Test location: DFS 1

INCUMBENT SIGNAL DETECTION CERTAINTY RATE

Trial	AWGN Detected (Yes / No)		
	Incumbent AWGN at f_{c2}	Incumbent AWGN at f_{c1}	Incumbent AWGN at f_{c3}
1	Yes	Yes	Yes
2	Yes	Yes	Yes
3	Yes	Yes	Yes
4	Yes	Yes	Yes
5	Yes	Yes	Yes
6	Yes	Yes	Yes
7	Yes	Yes	Yes
8	Yes	Yes	Yes
9	Yes	Yes	Yes
10	Yes	Yes	Yes
Test Result	PASS	PASS	PASS

Test Date: 05/03/24

Tested by: 29445

Test location: DFS 1

A minimum detection rate of 90% is required for the EUT to be compliant.

9.13.5. Tx OPERATIONAL STATUS TEST RESULTS

Test Condition 4: 99% BW_{EUT} > 4 x 99% BW_{INC}

Incumbent AWGN at f_{c2}:

Measured Incumbent Power at the EUT Test Fixture Connector (dBm)	Test Fixture Cable Path Loss (dB)	Adjusted Incumbent Power at the Radio Port (dBm)	Antenna Gain (dBi)	Adjusted Incumbent Power at the Antenna (dBm)	Detection Limit (dBm)	EUT Tx Status
-75.97	3.92	-79.89	-5.8	-74.09	-62	Ceased
-80.93	3.92	-84.85	-5.8	-79.05	-62	Minimal
-81.97	3.92	-85.89	-5.8	-80.09	-62	Normal

Incumbent AWGN at f_{c1}:

Measured Incumbent Power at the EUT Test Fixture Connector (dBm)	Test Fixture Cable Path Loss (dB)	Adjusted Incumbent Power at the Radio Port (dBm)	Antenna Gain (dBi)	Adjusted Incumbent Power at the Antenna (dBm)	Detection Limit (dBm)	EUT Tx Status
-75.15	3.92	-79.07	-5.8	-73.27	-62	Ceased
-79.25	3.92	-83.17	-5.8	-77.37	-62	Minimal
-80.93	3.92	-84.85	-5.8	-79.05	-62	Normal

Incumbent AWGN at f_{c3}:

Measured Incumbent Power at the EUT Test Fixture Connector (dBm)	Test Fixture Cable Path Loss (dB)	Adjusted Incumbent Power at the Radio Port (dBm)	Antenna Gain (dBi)	Adjusted Incumbent Power at the Antenna (dBm)	Detection Limit (dBm)	EUT Tx Status
-75.19	3.92	-79.11	-5.8	-73.31	-62	Ceased
-80.59	3.92	-84.51	-5.8	-78.71	-62	Minimal
-81.47	3.92	-85.39	-5.8	-79.59	-62	Normal

Test Date: 05/03/24

Tested by: 29445

Test location: DFS 1

9.14. U-NII 8 BAND TEST CONDITION 1 RESULTS

TEST CONDITION 1 CRITERIA

$$99\% BW_{EUT} \leq 99\% BW_{INC}$$

The lowest and highest supported channel bandwidths do not meet the criteria for this test condition therefore this test was not performed.

9.15. U-NII 8 BAND TEST CONDITION 2 RESULTS

TEST CONDITION 2 CRITERIA

$$99\% BW_{INC} < 99\% BW_{EUT} \leq 2 \times 99\% BW_{INC}$$

9.15.1. TEST CHANNEL

All tests were performed with the EUT set to a channel center frequency of 6935 MHz and a nominal channel bandwidth of 20 MHz.

Only the lowest and highest supported channel bandwidths are required to be tested.

9.15.2. INCUMBENT SIGNAL PLOTS

All tests were performed with the Incumbent Signal frequency set to the test channel center frequency and a nominal 99% Occupied Power Bandwidth of 10 MHz.

INCUMBENT SIGNAL 99% OCCUPIED POWER BANDWIDTH

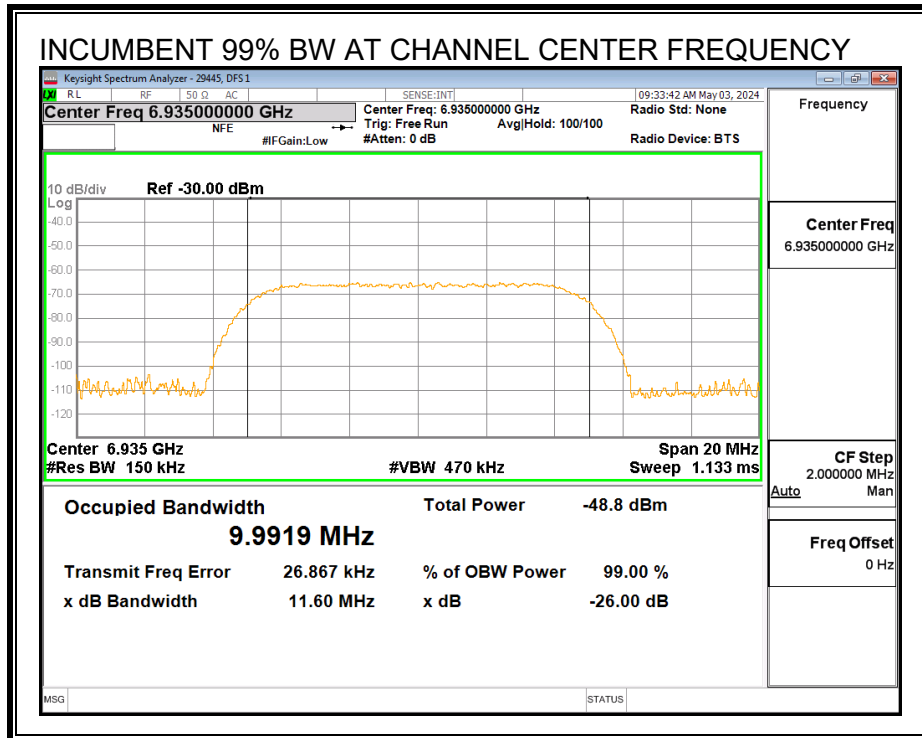

MINIMUM PASSING INCUMBENT SIGNAL POWER

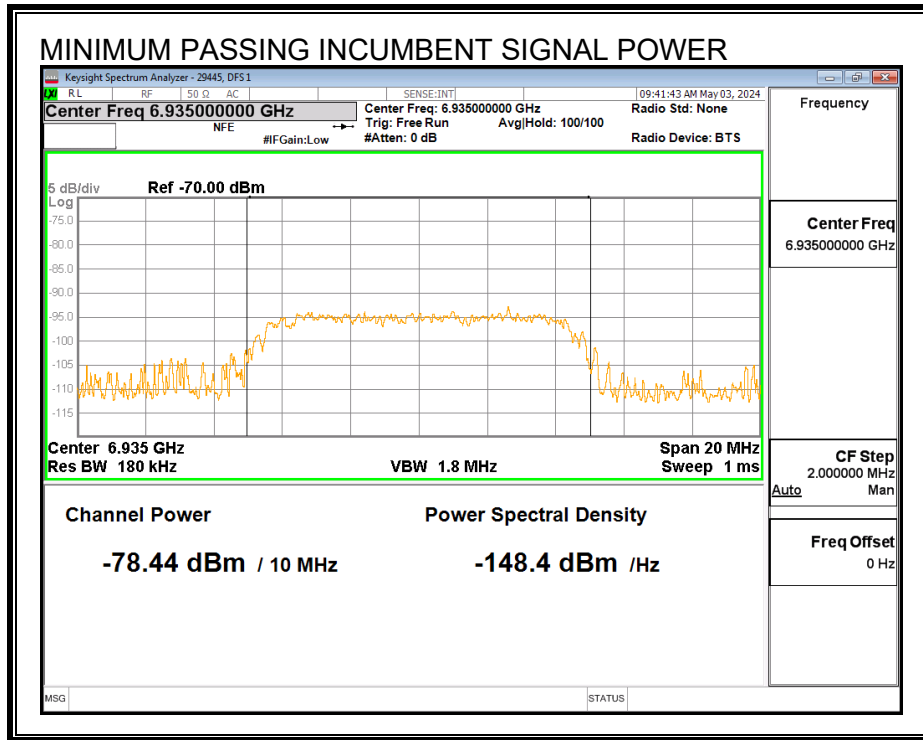

9.15.3. EUT TRANSMISSION PLOTS

EUT 99% OCCUPIED POWER BANDWIDTH

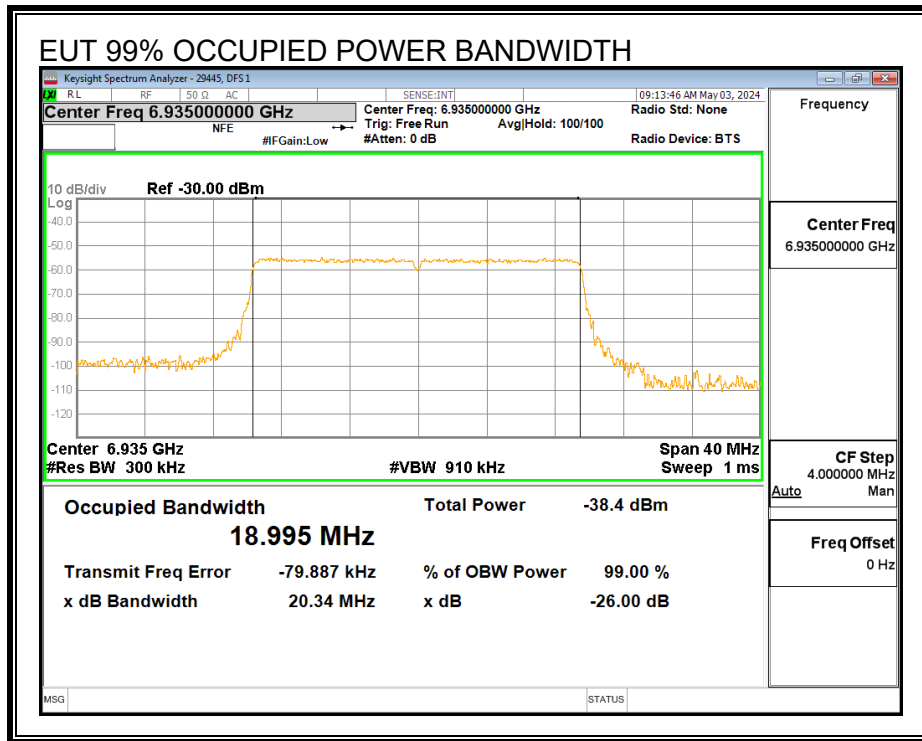

TRAFFIC WITHOUT THE INCUMBENT SIGNAL PRESENT

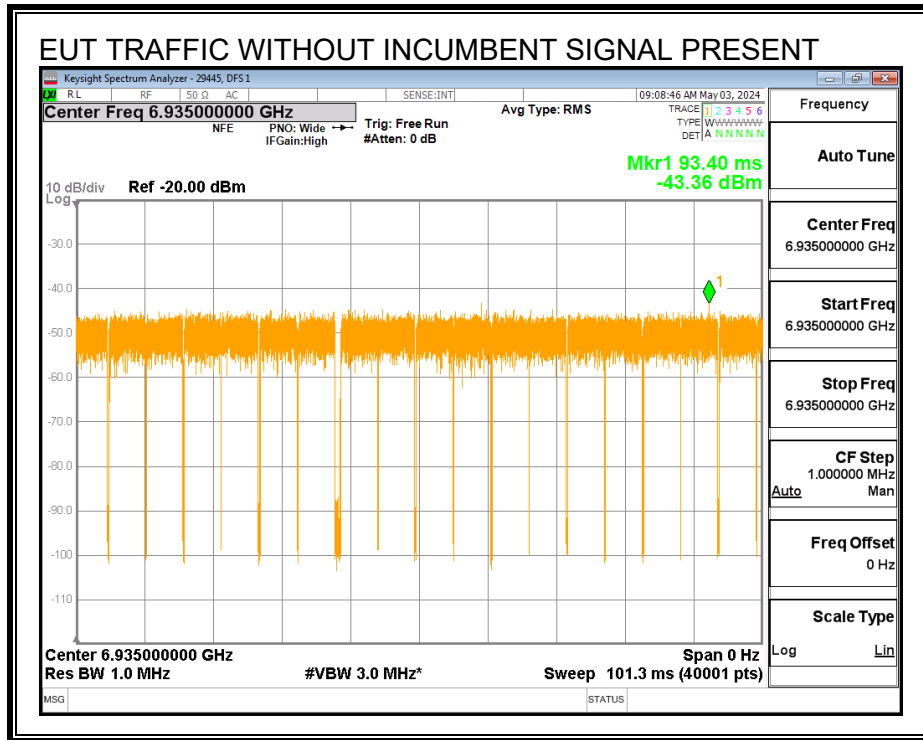

EUT RESPONSE TO THE APPLIED INCUMBENT SIGNAL

A link between the EUT and the Companion Device was established on the test channel. Traffic flowing from the EUT to the Companion Device was then initiated. A sweep was started, and the incumbent signal was continuously applied at approximately 5 seconds after the start of the sweep for a duration of 30 seconds and removed after the end of the observation period. Markers are placed at the beginning and end of the observation period.

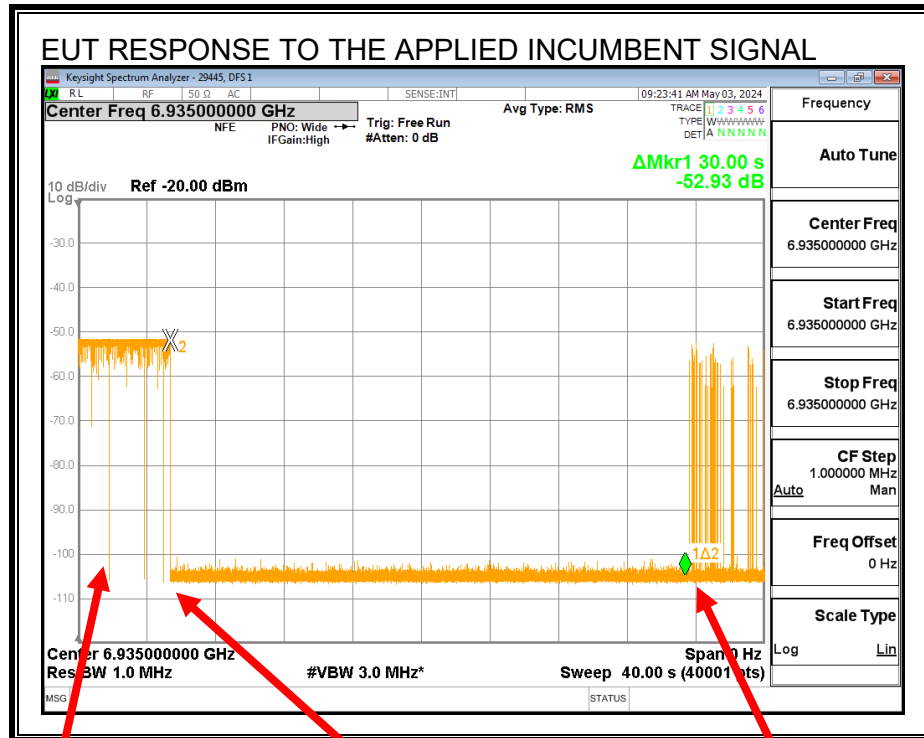

Normal Traffic

Application of Incumbent
Transmissions Ceased

Incumbent Removed
Transmissions Resume

Transmissions cease while the Incumbent AWGN Signal is present and resume after it is removed.

9.15.4. TABULATED TEST RESULTS

INCUMBENT SIGNAL DETECTION RESULTS

EUT Channel Center Frequency, f_{c1} (MHz)	6935
EUT Nominal Channel Bandwidth (MHz)	20
99% Occupied Bandwidth of the EUT (MHz)	18.995
EUT 99% OBW Lower Edge, F_L (MHz)	6925.50
EUT 99% OBW Upper Edge, F_H (MHz)	6944.50
Test Frequency of Incumbent Signal (MHz)	6935
Maximum Allowed Incumbent Amplitude at Antenna (dBm)	-62
Minimum Antenna Gain (dBi)	-4.20
Maximum Allowed Incumbent Amplitude at Radio Port (dBm)	-66.20
Lowest Passing Measured Incumbent Signal Amplitude (dBm)	-82.36
Margin (dBm)	-16.16
Result (PASS / FAIL)	PASS

Test Date: 05/03/24

Tested by: 29445

Test location: DFS 1

INCUMBENT SIGNAL DETECTION CERTAINTY RATE

AWGN Detected (Yes / No)	
Trial	Incumbent AWGN at f_{c1}
1	Yes
2	Yes
3	Yes
4	Yes
5	Yes
6	Yes
7	Yes
8	Yes
9	Yes
10	Yes
Test Result	PASS

Test Date: 05/03/24
Tested by: 29445
Test location: DFS 1

A minimum detection rate of 90% is required for the EUT to be compliant.

9.15.5. Tx OPERATIONAL STATUS TEST RESULTS

Test Condition 2: $99\% BW_{INC} < 99\% BW_{EUT} \leq 2 \times 99\% BW_{INC}$

Incumbent AWGN at f_{c1} :

Measured Incumbent Power at the EUT Test Fixture Connector (dBm)	Test Fixture Cable Path Loss (dB)	Adjusted Incumbent Power at the Radio Port (dBm)	Antenna Gain (dBi)	Adjusted Incumbent Power at the Antenna (dBm)	Detection Limit (dBm)	EUT Tx Status
-78.44	3.92	-82.36	-4.2	-78.16	-62	Ceased
-82.00	3.92	-85.92	-4.2	-81.72	-62	Minimal
-84.67	3.92	-88.59	-4.2	-84.39	-62	Normal

Test Date: 05/03/24

Tested by: 29445

Test location: DFS 1

9.16. U-NII 8 BAND TEST CONDITION 3 RESULTS

TEST CONDITION 3 CRITERIA

$$2 \times 99\% BW_{INC} < 99\% BW_{EUT} \leq 4 \times 99\% BW_{INC}$$

The lowest and highest supported channel bandwidths do not meet the criteria for this test condition therefore this test was not performed.

9.17. U-NII 8 BAND TEST CONDITION 4 RESULTS

TEST CONDITION 4 CRITERIA

$$99\% BW_{EUT} > 4 \times 99\% BW_{INC}$$

9.17.1. TEST CHANNEL

All tests were performed with the EUT set to a channel center frequency of 6985 MHz and a nominal channel bandwidth of 160 MHz.

Only the lowest and highest supported channel bandwidths are required to be tested.

9.17.2. INCUMBENT SIGNAL PLOTS

All tests were performed with the Incumbent Signal frequency set to the test channel center frequency and a nominal 99% Occupied Power Bandwidth of 10 MHz.

INCUMBENT SIGNAL 99% OCCUPIED POWER BANDWIDTH

Lower Edge Incumbent Signal f_{c2} :

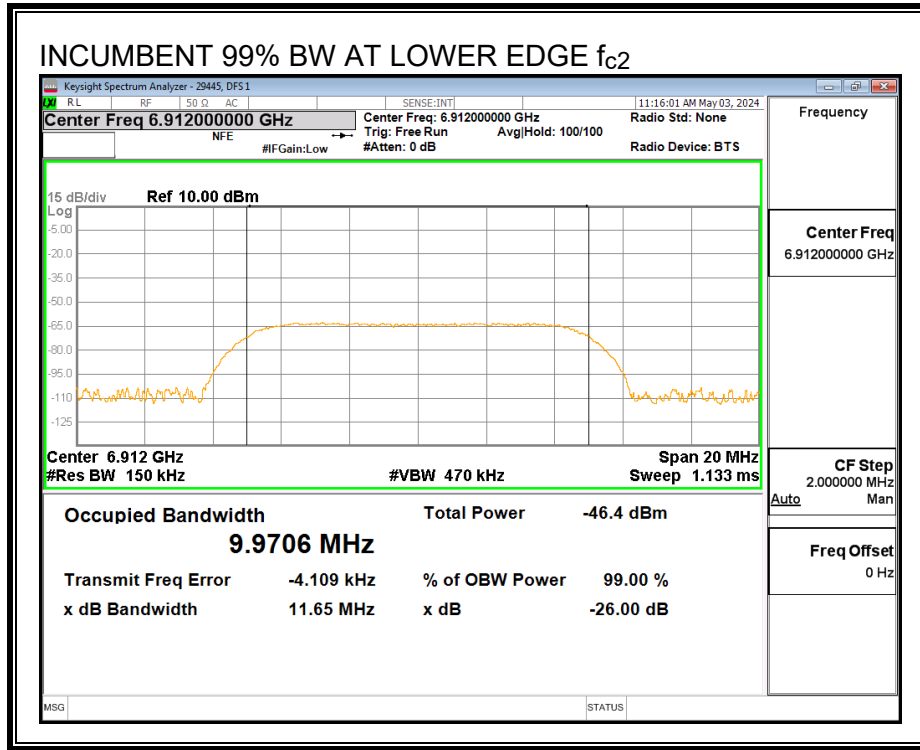

Center Frequency Incumbent Signal f_{c1} :

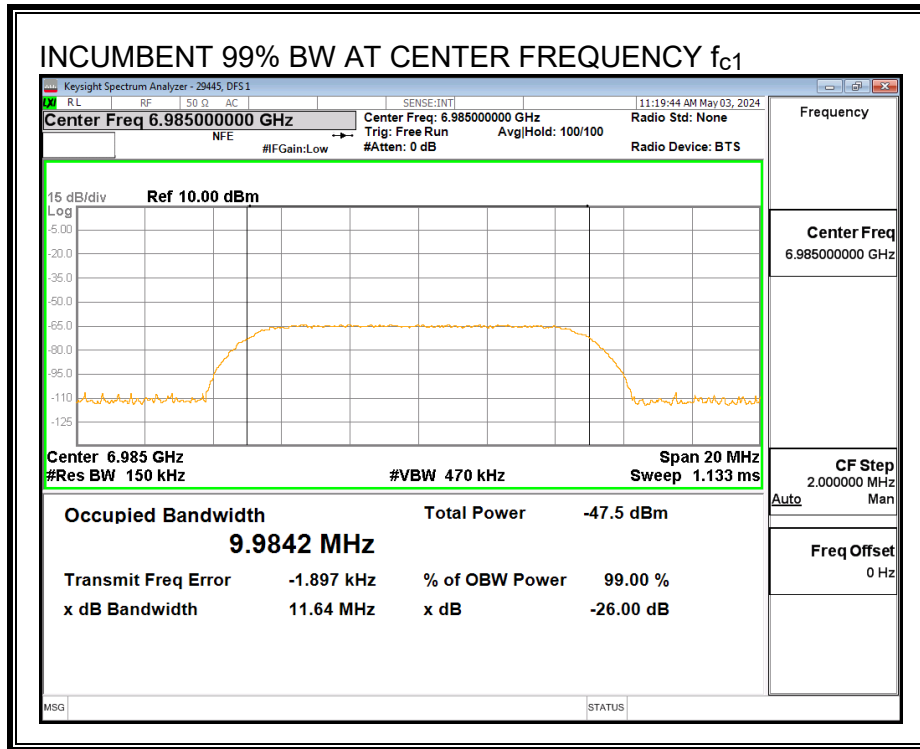

Upper Edge Incumbent Signal f_{c3} :

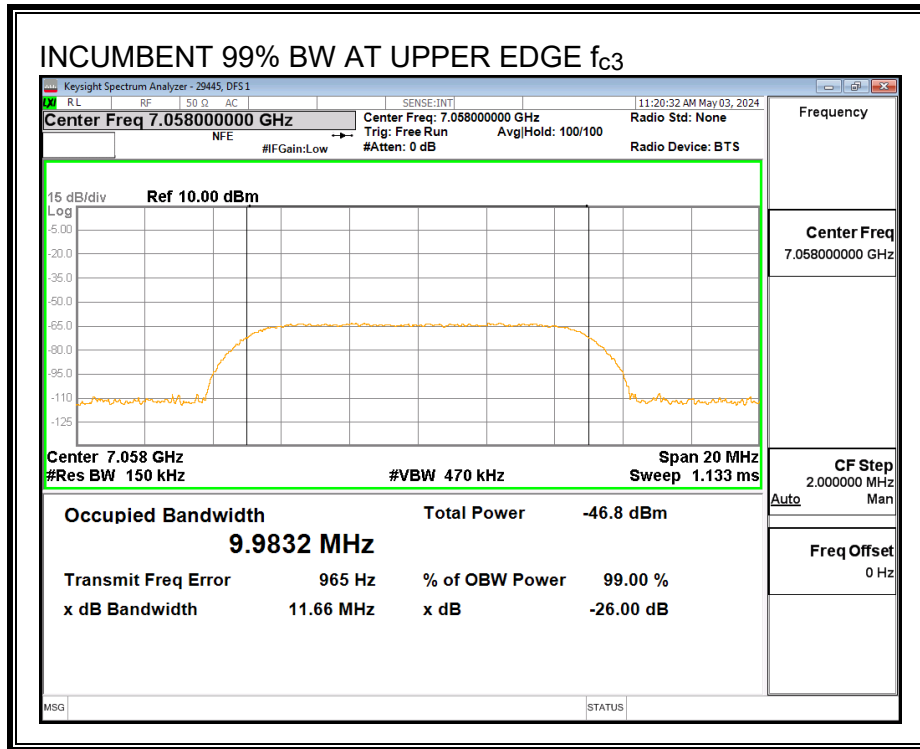

MINIMUM PASSING INCUMBENT SIGNAL POWER

Lower Edge Incumbent Signal f_{c2} :

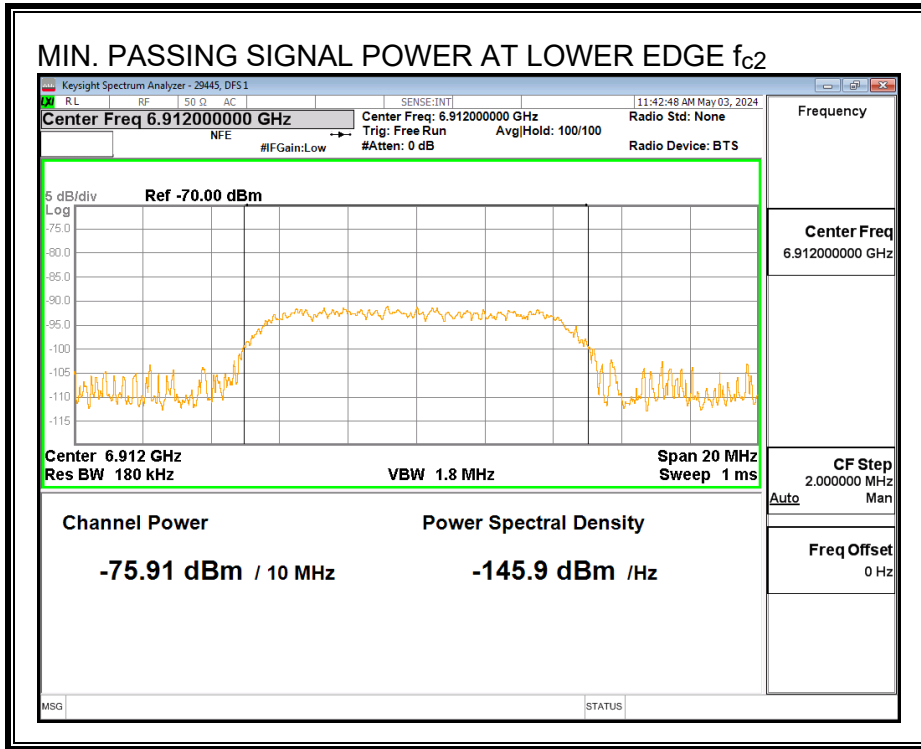

Center Frequency Incumbent Signal f_{c1} :

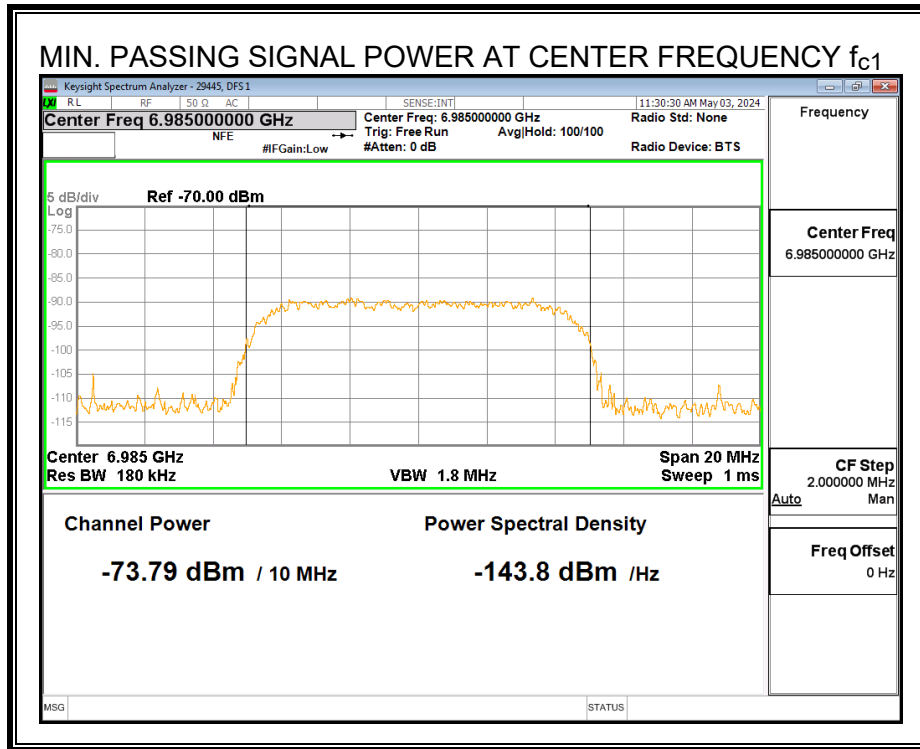

Upper Edge Incumbent Signal f_{c3} :

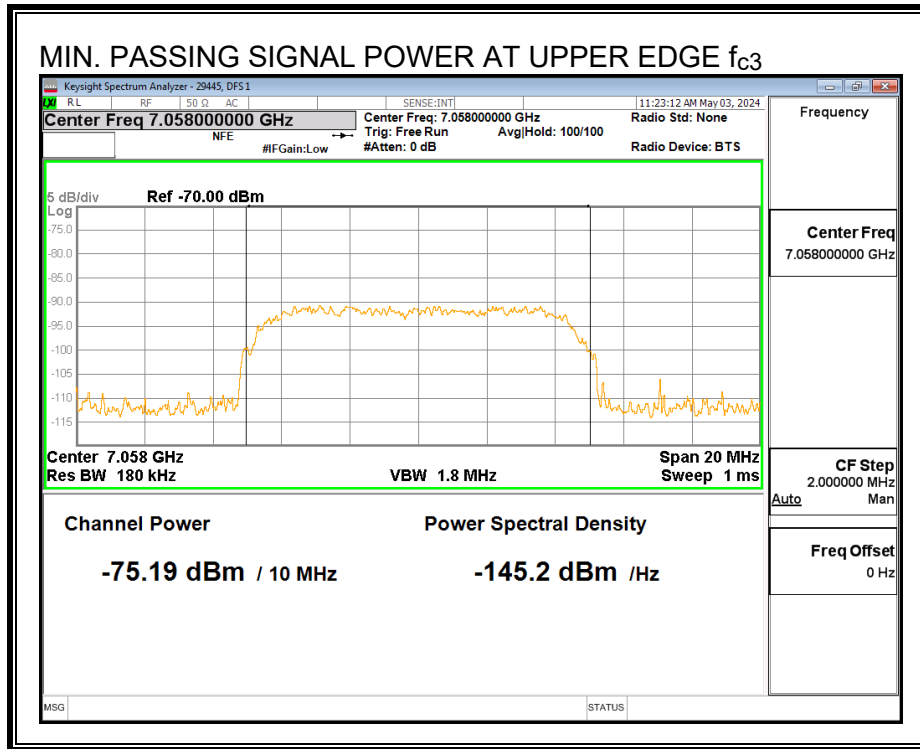

9.17.3. EUT TRANSMISSION PLOTS

EUT 99% OCCUPIED POWER BANDWIDTH

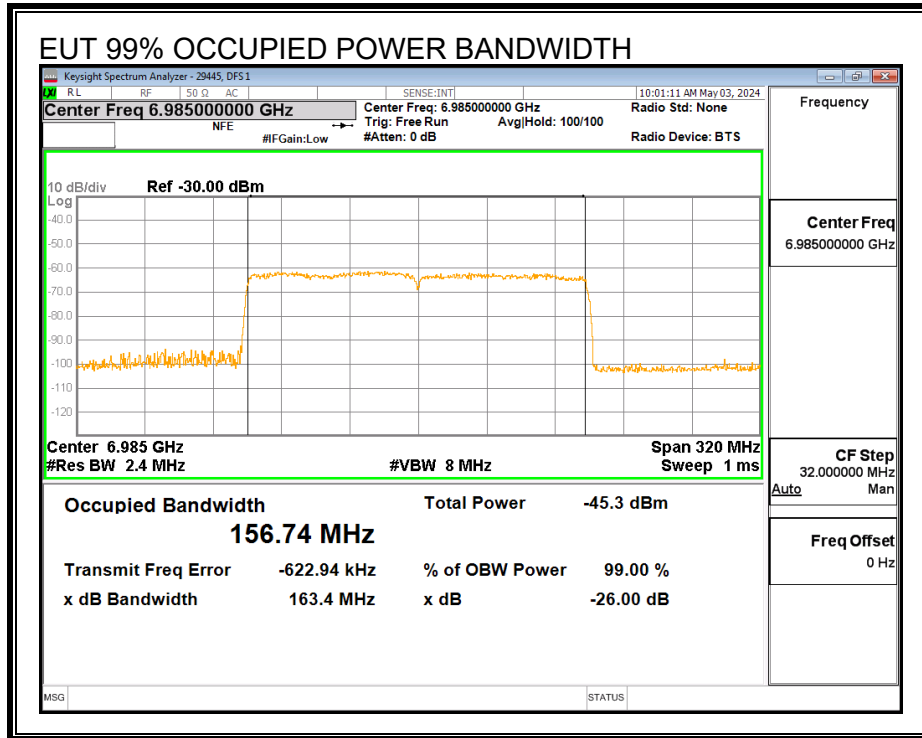

TRAFFIC WITHOUT THE INCUMBENT SIGNAL PRESENT

Lower Edge f_{c2} :

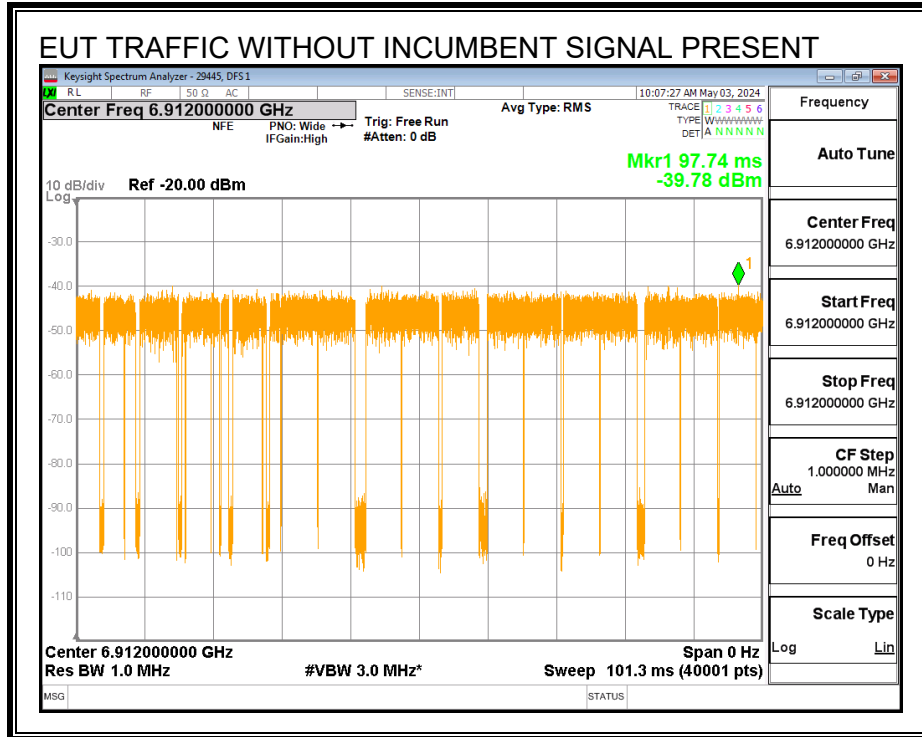

Center Frequency f_{c1} :

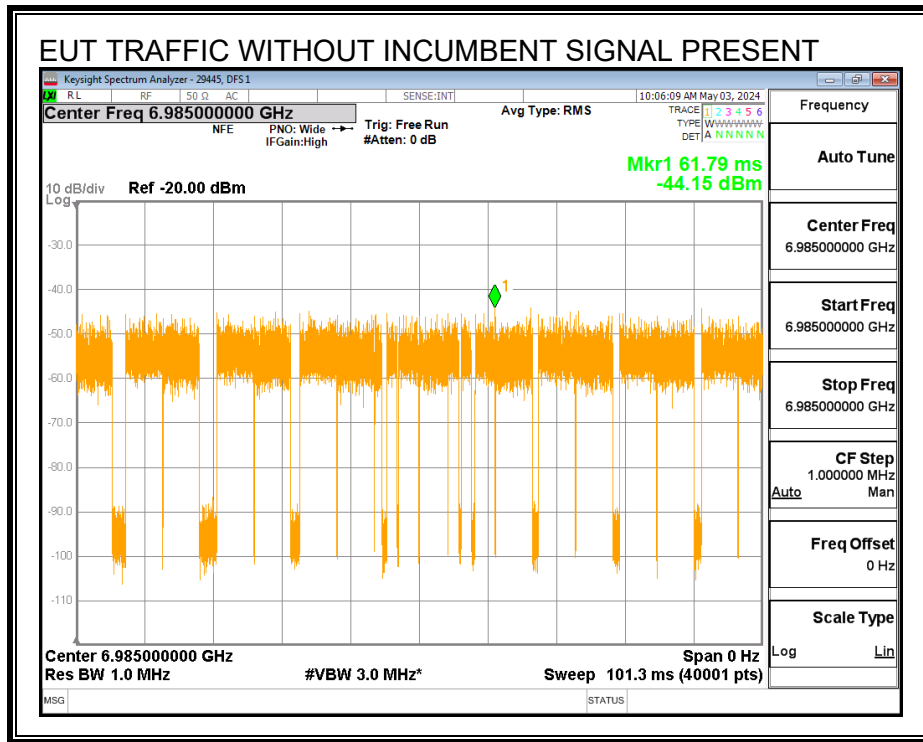

Upper Edge fc3:

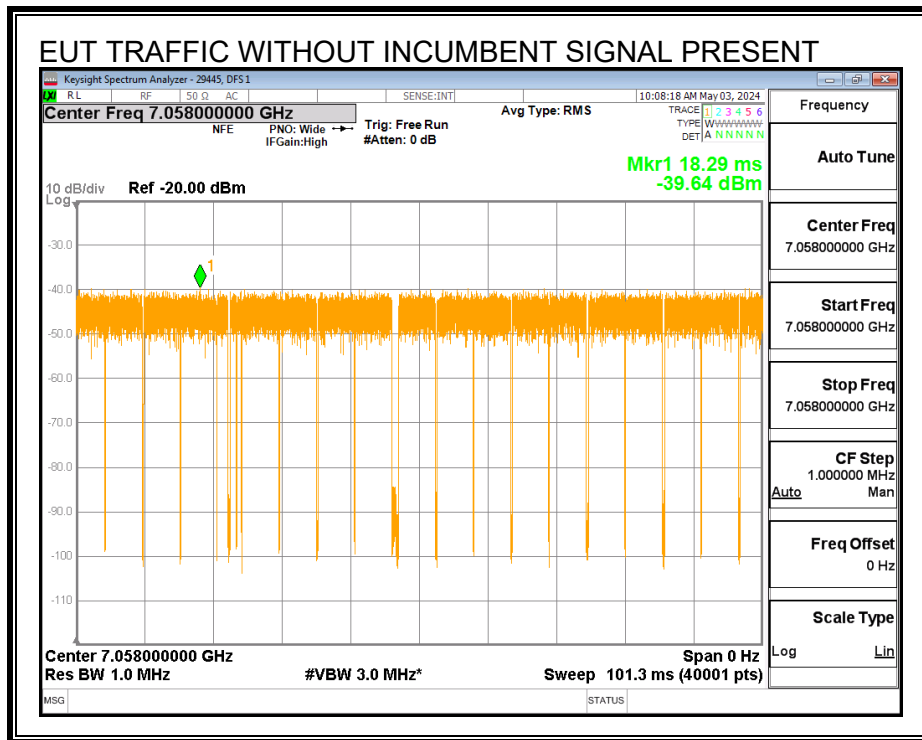

EUT RESPONSE TO THE APPLIED INCUMBENT SIGNAL

A link between the EUT and the Companion Device was established on the test channel. Traffic flowing from the EUT to the Companion Device was then initiated. A sweep was started, and the incumbent signal was continuously applied at approximately 5 seconds after the start of the sweep for a duration of 30 seconds and removed after the end of the observation period. Markers are placed at the beginning and end of the observation period.

Lower Edge Incumbent Signal f_{c2} :

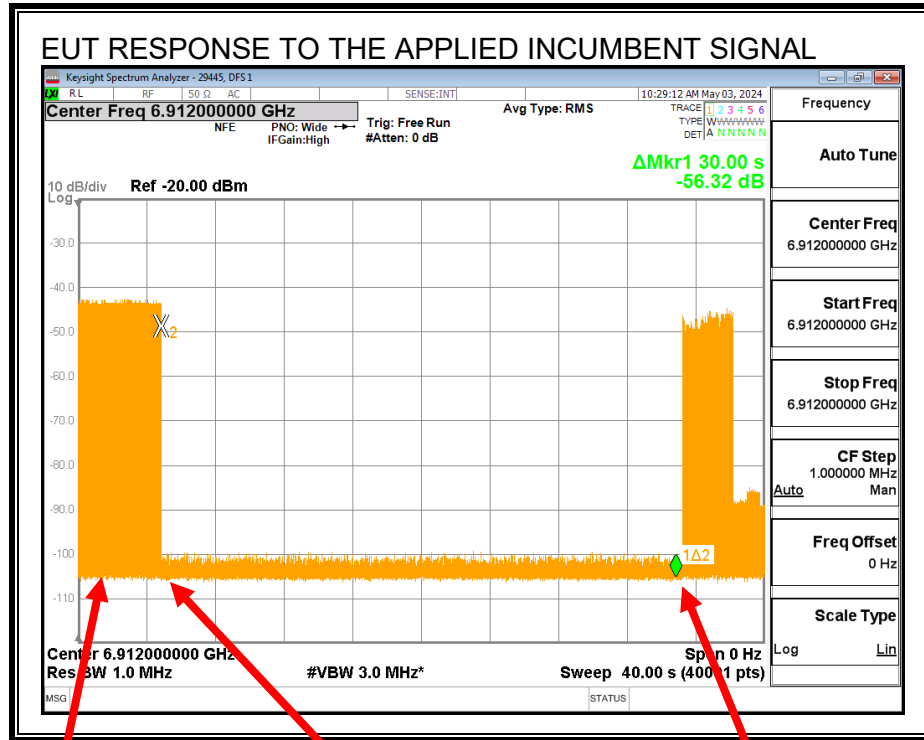

Normal Traffic

Application of Incumbent
Transmissions Ceased

Incumbent Removed
Transmissions Resume

Transmissions cease while the Incumbent AWGN Signal is present and resume after it is removed.

Center Frequency Incumbent Signal f_{c1} :

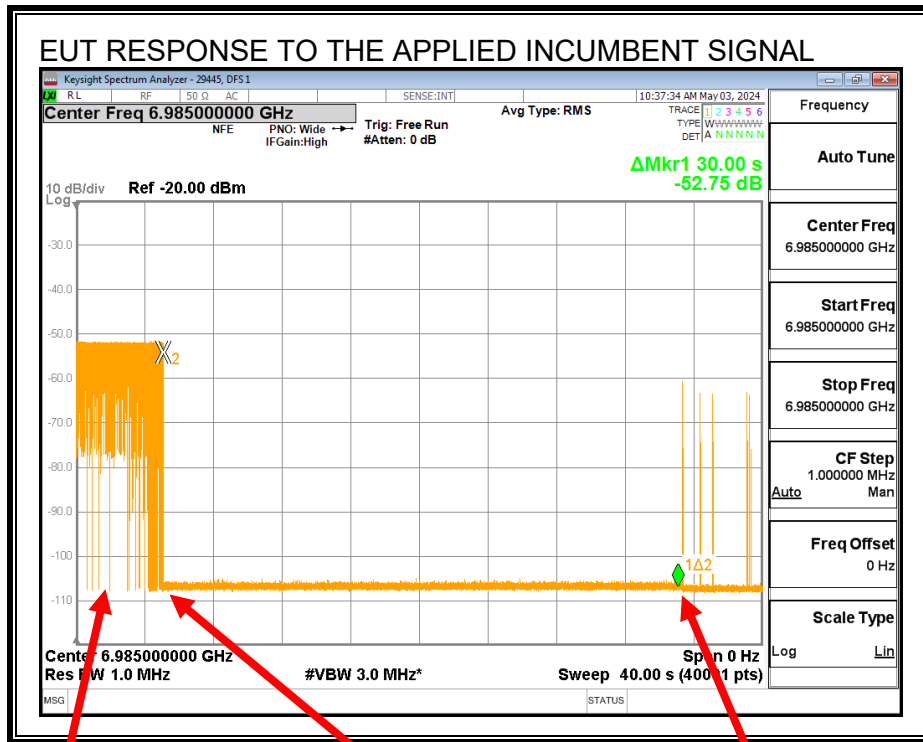

Normal Traffic

Application of Incumbent
Transmissions Ceased

Incumbent Removed
Transmissions Resume

Transmissions cease while the Incumbent AWGN Signal is present and resume after it is removed.

Upper Edge Incumbent Signal f_{c3}:

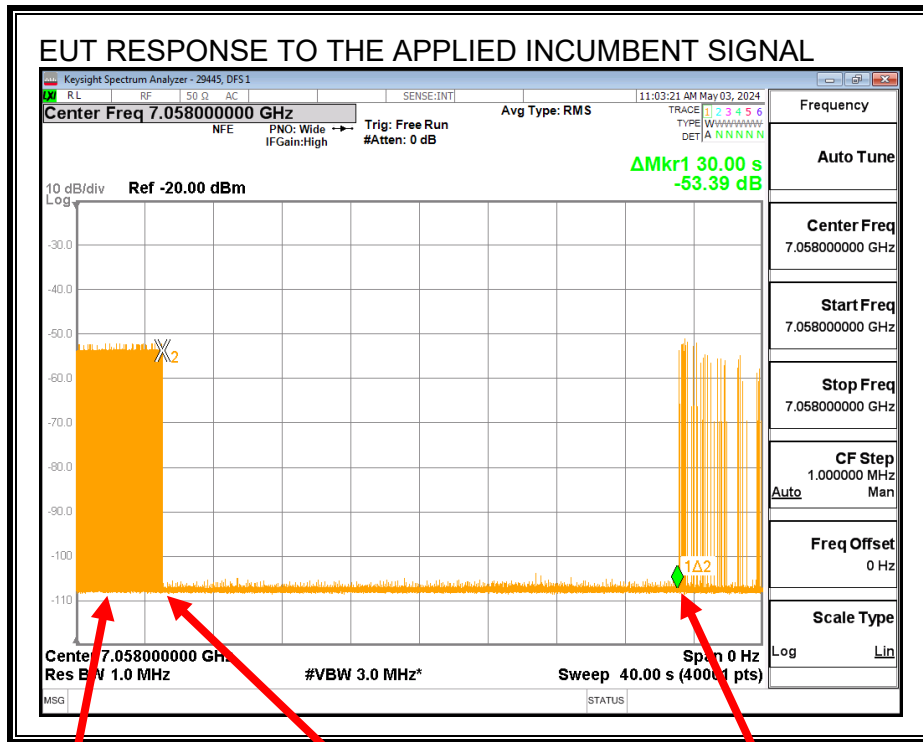

Normal Traffic

Application of Incumbent
Transmissions Ceased

Incumbent Removed
Transmissions Resume

Transmissions cease while the Incumbent AWGN Signal is present and resume after it is removed.

9.17.4. TABULATED TEST RESULTS

INCUMBENT SIGNAL DETECTION RESULTS

EUT Channel Center Frequency, f_{c1} (MHz)	6985
EUT Nominal Channel Bandwidth (MHz)	160
99% Occupied Bandwidth of the EUT (MHz)	156.74
EUT 99% OBW Lower Edge, F_L (MHz)	6906.63
EUT 99% OBW Upper Edge, F_H (MHz)	7063.37
99% Occupied Bandwidth of the Incumbent Signal (MHz)	9.9842
Test Frequency of Incumbent Signal (f_{c2}) Near EUT F_L (MHz)	6912
Test Frequency of Incumbent Signal at f_{c1} (MHz)	6985
Test Frequency of Incumbent Signal (f_{c3}) Near EUT F_H (MHz)	7058
Maximum Allowed Incumbent Amplitude at Antenna (dBm)	-62
Minimum Antenna Gain (dBi)	-4.2
Maximum Allowed Incumbent Amplitude at Radio Port (dBm)	-66.20
Lowest Passing Measured Incumbent Signal Amplitude at f_{c2} (dBm)	
	-79.86
Margin (dBm)	-13.66
Result (PASS / FAIL)	PASS
Lowest Passing Measured Incumbent Signal Amplitude at f_{c1} (dBm)	
	-77.74
Margin (dBm)	-11.54
Result (PASS / FAIL)	PASS
Lowest Passing Measured Incumbent Signal Amplitude at f_{c3} (dBm)	
	-79.14
Margin (dBm)	-12.94
Result (PASS / FAIL)	PASS

Test Date: 05/03/24

Tested by: 29445

Test location: DFS 1

INCUMBENT SIGNAL DETECTION CERTAINTY RATE

Trial	AWGN Detected (Yes / No)		
	Incumbent AWGN at f_{c2}	Incumbent AWGN at f_{c1}	Incumbent AWGN at f_{c3}
1	Yes	Yes	Yes
2	Yes	Yes	Yes
3	Yes	Yes	Yes
4	Yes	Yes	Yes
5	Yes	Yes	Yes
6	Yes	Yes	Yes
7	Yes	Yes	Yes
8	Yes	Yes	Yes
9	Yes	Yes	Yes
10	Yes	Yes	Yes
Test Result	PASS	PASS	PASS

Test Date: 05/03/24

Tested by: 29445

Test location: DFS 1

A minimum detection rate of 90% is required for the EUT to be compliant.

9.17.5. Tx OPERATIONAL STATUS TEST RESULTS

Test Condition 4: 99% BW_{EUT} > 4 x 99% BW_{INC}

Incumbent AWGN at f_{c2}:

Measured Incumbent Power at the EUT Test Fixture Connector (dBm)	Test Fixture Cable Path Loss (dB)	Adjusted Incumbent Power at the Radio Port (dBm)	Antenna Gain (dBi)	Adjusted Incumbent Power at the Antenna (dBm)	Detection Limit (dBm)	EUT Tx Status
-75.91	3.95	-79.86	-4.2	-75.66	-62	Ceased
-79.23	3.95	-83.18	-4.2	-78.98	-62	Minimal
-80.72	3.95	-84.67	-4.2	-80.47	-62	Normal

Incumbent AWGN at f_{c1}:

Measured Incumbent Power at the EUT Test Fixture Connector (dBm)	Test Fixture Cable Path Loss (dB)	Adjusted Incumbent Power at the Radio Port (dBm)	Antenna Gain (dBi)	Adjusted Incumbent Power at the Antenna (dBm)	Detection Limit (dBm)	EUT Tx Status
-73.79	3.95	-77.74	-4.2	-73.54	-62	Ceased
-78.04	3.95	-81.99	-4.2	-77.79	-62	Minimal
-79.60	3.95	-83.55	-4.2	-79.35	-62	Normal

Incumbent AWGN at f_{c3}:

Measured Incumbent Power at the EUT Test Fixture Connector (dBm)	Test Fixture Cable Path Loss (dB)	Adjusted Incumbent Power at the Radio Port (dBm)	Antenna Gain (dBi)	Adjusted Incumbent Power at the Antenna (dBm)	Detection Limit (dBm)	EUT Tx Status
-75.19	3.95	-79.14	-4.2	-74.94	-62	Ceased
-78.88	3.95	-82.83	-4.2	-78.63	-62	Minimal
-80.02	3.95	-83.97	-4.2	-79.77	-62	Normal

Test Date: 05/03/24

Tested by: 29445

Test location: DFS 1

10. SETUP PHOTOS

Please refer to 14982436-EP1V1 for setup photos

END OF REPORT