

# **CERTIFICATION TEST REPORT**

**Report Number. :** 14523772-E13V2

**Applicant :** APPLE, INC.  
ONE APPLE PARK WAY  
CUPERTINO, CA 95014, U.S.A.

**Model :** A3105 (Full Test Model)  
A3106, A3108 (Variant Models)

**FCC ID :** BCG-E8440A (Full Test Model)  
BCG-E8441A, BCG-E8442A (Variant Model)

**IC :** 579C-E8440A (Full Test Model)  
579C-E8441A, 579C-E8442A (Variant Model)

**EUT Description :** Smartphone

**Test Standard(s) :** FCC 47 CFR PART 15 SUBPART C  
ISED RSS-216 ISSUE 2  
ISED RSS-GEN ISSUE 5 + A1 + A2

**Date of Issue:**  
August 09, 2023

**Prepared by:**  
UL Verification Services Inc.  
47173 Benicia Street  
Fremont, CA 94538 U.S.A.  
TEL: (510) 319-4000  
FAX: (510) 661-0888



Revision History

Rev.	Issue Date	Revisions	Revised By
V1	8/3/2023	Initial Issue	Chin Pang
V2	8/9/2023	Address page 4 and 8	Chin Pang

## TABLE OF CONTENTS

<b>1. ATTESTATION OF TEST RESULTS .....</b>	<b>4</b>
<b>2. TEST METHODOLOGY .....</b>	<b>6</b>
<b>3. FACILITIES AND ACCREDITATION .....</b>	<b>6</b>
<b>4. DECISION RULES AND MEASUREMENT UNCERTAINTY .....</b>	<b>7</b>
4.1. METROLOGICAL TRACEABILITY .....	7
4.2. DECISION RULES.....	7
4.3. MEASUREMENT UNCERTAINTY.....	7
<b>5. EQUIPMENT UNDER TEST .....</b>	<b>8</b>
5.1. DESCRIPTION OF EUT .....	8
5.2. MAXIMUM E-FIELD and H-FIELD .....	8
5.3. WORST-CASE CONFIGURATION AND MODE.....	8
5.4. DESCRIPTION OF TEST SETUP.....	10
<b>6. TEST AND MEASUREMENT EQUIPMENT .....</b>	<b>11</b>
<b>7. OCCUPIED BANDWIDTH .....</b>	<b>12</b>
<b>8. RADIATED EMISSION TEST RESULTS.....</b>	<b>13</b>
8.1. LIMITS AND PROCEDURE.....	13
8.2. Standby .....	14
8.2.1. FCC TX FUNDAMENTAL & SPURIOUS EMISSIONS (9 kHz - 30 MHz) .....	14
8.2.2. IC/ ICES-001 TX FUNDAMENTAL & SPURIOUS EMISSIONS (9 kHz - 30 MHz).....	15
8.2.3. FCC TX SPURIOUS EMISSION (30 - 1000 MHz) .....	16
8.2.4. IC/ ICES-001 TX SPURIOUS EMISSION (30 - 1000 MHz).....	18
8.3. EUT With Load .....	20
8.3.1. FCC TX FUNDAMENTAL & SPURIOUS EMISSIONS (9 kHz - 30 MHz) .....	20
8.3.2. IC/ ICES-001 TX FUNDAMENTAL & SPURIOUS EMISSIONS (9 kHz - 30 MHz).....	21
8.3.3. FCC TX SPURIOUS EMISSION (30 - 1000 MHz) .....	22
8.3.4. IC/ ICES-001 TX SPURIOUS EMISSION (30 - 1000 MHz).....	24
<b>9. AC POWER LINE CONDUCTED EMISSIONS.....</b>	<b>26</b>
9.1. Standby .....	27
9.1.1. STANDBY MODE POWERED BY AC/DC ADAPTER.....	27
9.2. EUT With Load .....	29
9.2.1. OPERATING MODE WITH LOAD POWERED BY AC/DC ADAPTER.....	29
<b>SETUP PHOTOS.....</b>	<b>31</b>

# 1. ATTESTATION OF TEST RESULTS

**COMPANY NAME:** APPLE, INC.  
ONE APPLE PARK WAY  
CUPERTINO, CA 95014,

**EUT DESCRIPTION:** Smartphone

**MODEL:** A3105 (Parent Model)  
A3106, A3108 (Variant Model)

**BRAND:** APPLE

**FCC ID:** BCG-E8440A (Full Test Model)  
BCG-E8441A, BCG-E8442A (Variant Model)

**IC ID:** 579C-E8440A (Full Test Model)  
579C-E8441A, 579C-E8442A (Variant Model)

**SERIAL NUMBER:** DDWQKX0W39

**SAMPLE RECEIPT DATE:** JUNE 27, 2023

**DATE TESTED:** JULY 1-6, 2023.

APPLICABLE STANDARDS	
STANDARD	TEST RESULTS
FCC PART 15 SUBPART C	Complies
ISED RSS-216 Issue 2	Complies
ISED RSS-GEN Issue 5 + A1 + A2	Complies

UL Verification Services Inc. tested the above equipment in accordance with the requirements set forth in the above standards. The test results show that the equipment tested is capable of demonstrating compliance with the requirements as documented in this report.

The results documented in this report apply only to the tested sample, under the conditions and modes of operation as described herein. It is the manufacturer's responsibility to assure that additional production units of this model are manufactured with identical electrical and mechanical components. All samples tested were in good operating condition throughout the entire test program. Measurement Uncertainties are published for informational purposes only and were not taken into account unless noted otherwise.

This document may not be altered or revised in any way unless done so by UL Verification Services Inc. and all revisions are duly noted in the revisions section. Any alteration of this document not carried out by UL Verification Services Inc. will constitute fraud and shall nullify the document. This report must not be used by the client to claim product certification, approval, or endorsement by A2LA, NIST, any agency of the Federal Government, or any agency of the U.S. government.

Approved & Released For  
UL Verification Services Inc. By:

Prepared By:



---

Chin Pang  
Senior Lab Engineer  
Consumer Technology Division  
UL Vérification Services Inc.

---

Francisco Guarnero  
Senior Test Engineer  
Consumer Technology Division  
UL Vérification Services Inc

## 2. TEST METHODOLOGY

The tests documented in this report were performed in accordance with:

- FCC CFR 47 Part 2
- FCC CFR 47 Part 15
- ANSI C63.10-2013
- KDB 414788 D01 Radiated Test Site v01r01
- RSS-GEN Issue 5 + A1 + A2
- RSS-216 Issue 2

## 3. FACILITIES AND ACCREDITATION

UL Verification Services Inc. is accredited by A2LA, certification #0751.05, for all testing performed within the scope of this report. Testing was performed at the locations noted below.

	Address	ISED CABID	ISED Company Number	FCC Registration
<input type="checkbox"/>	Building 1: 47173 Benicia Street, Fremont, CA 94538, USA	US0104	2324A	550739
<input checked="" type="checkbox"/>	Building 2: 47266 Benicia Street, Fremont, CA 94538, USA			
<input type="checkbox"/>	Building 3: 843 Auburn Court, Fremont, CA 94538 USA			
<input type="checkbox"/>	Building 4: 47658 Kato Rd, Fremont, CA 94538 USA			
<input type="checkbox"/>	Building 5: 47670 Kato Rd, Fremont, CA 94538 USA			

## 4. DECISION RULES AND MEASUREMENT UNCERTAINTY

### 4.1. METROLOGICAL TRACEABILITY

All test and measuring equipment utilized to perform the tests documented in this report are calibrated on a regular basis, with a maximum time between calibrations of one year or the manufacturers' recommendation, whichever is less, and where applicable is traceable to recognized national standards.

### 4.2. DECISION RULES

The Decision Rule is based on Simple Acceptance in accordance with ISO Guide 98-4:2012 Clause 8.2. (Measurement uncertainty is not taken into account when stating conformity with a specified requirement).

### 4.3. MEASUREMENT UNCERTAINTY

Where relevant, the following measurement uncertainty levels have been estimated for tests performed on the apparatus:

PARAMETER	UNCERTAINTY
Occupied Bandwidth	1.2%
Worst Case Conducted Disturbance, 9KHz to 0.15 MHz	3.78 dB
Worst Case Conducted Disturbance, 0.15 to 30 MHz	3.40 dB
Worst Case Radiated Disturbance, 9KHz to 30 MHz	2.87 dB
Worst Case Radiated Disturbance, 30 to 1000 MHz	6.01 dB

Uncertainty figures are valid to a confidence level of 95%.

## 5. EQUIPMENT UNDER TEST

### 5.1. DESCRIPTION OF EUT

The Apple iPhone is a smartphone with multimedia functions (music, application support, and video), cellular GSM, GPRS, EGPRS, UMTS, LTE, 5G, IEEE 802.11a/b/g/n/ac/ax, Bluetooth, Ultra-Wideband, GPS, NFC, NB UNII, 802.15.4, 802.15.4ab-NB and MSS technologies. The rechargeable battery is not user accessible.

The Model and FCC/ISED ID covered by this report includes:

Full Test Model: A3105, FCC ID: BCG-E8440A, IC ID: 579C-E8440A

Variant Models: A3106, FCC ID: BCG-E8441A, IC ID: 579C-8441A  
A3108, FCC ID: BCG-E8442A, IC ID: 579C-8442A

### 5.2. MAXIMUM E-FIELD and H-FIELD

The transmitter has maximum peak radiated electric and magnetic field strength as follows:

Fundamental Frequency (KHz)	Mode	E field (300m distance) FCC (dBuV/m)	H field (3m distance) IC (dBuA/m)
360	Standby	-44.32	-11.58
	Operating	-29.96	2.61

### 5.3. WORST-CASE CONFIGURATION AND MODE

The EUT is a smartphone which connected to the AC/DC adapter via USB-C cable, and the inductive charging coil to charge WPT accessories (Load). For the entire radiated emissions test, the EUT was investigated on the following configuration during the test: 1. At its natural orientation with EUT set at center location on Load, 2. At its natural orientation with EUT including a case set at center location on load. The worst case was natural orientation with EUT including a case set at center location on load.

Mode	Descriptions
Standby	EUT alone with USB-C to USB-C cable powered by AC/DC Adapter.
Operating	EUT with USB-C to USB-C cable powered by AC/DC Adapter & Wireless Charging to Battery Case



For below 30MHz & 1GHz tests EUT was connected to AC power adapter as the worst case, For AC line conducted emission, test was investigated with AC power adapter.

The EUT was tested on standby and operation modes. During operational mode, EUT was tested with load.

For below 30MHz testing, investigation was done on three antenna orientations: RX antenna Face-on, Face-off and horizontal (parallel to ground). The worst-case configurations were determined on RX antenna Face-on and Face-off; therefore, all final tests were performed using these two orientations.

Although these tests were performed other than open area test site, adequate comparison measurements were confirmed against 300 m open area test site. Therefore, sufficient tests were made to demonstrate that the alternative site produces results that correlate with the ones of tests made in an open field based on KDB 414788 D01.

## 5.4. DESCRIPTION OF TEST SETUP

### SUPPORT EQUIPMENT & PERIPHERALS

SUPPORT EQUIPMENT & PERIPHERALS LIST				
Description	Manufacturer	Model	Serial Number	FCC ID
AC/DC adapter	Apple	A2305	C4H0313063ZPF4FAZ	DoC
Charging Cable	Apple	A2795	FTL851300CQ26GV13	NA
WPT Accessory (Load)	Apple	A2384	DND351202Y50NJM1S	BCGA2384
WPT Accessory	Apple	Clear Case	L12222PR1MA01QA1746	DoC

### I/O CABLES

I/O CABLE LIST						
Cable No.	Port	# of Identical Ports	Connector Type	Cable Type	Cable Length (m)	Remarks
1	DC	1	USBC	Un-shielded	1	None

### TEST SETUP

#### OPERATING MODE PHONE WITH LOAD

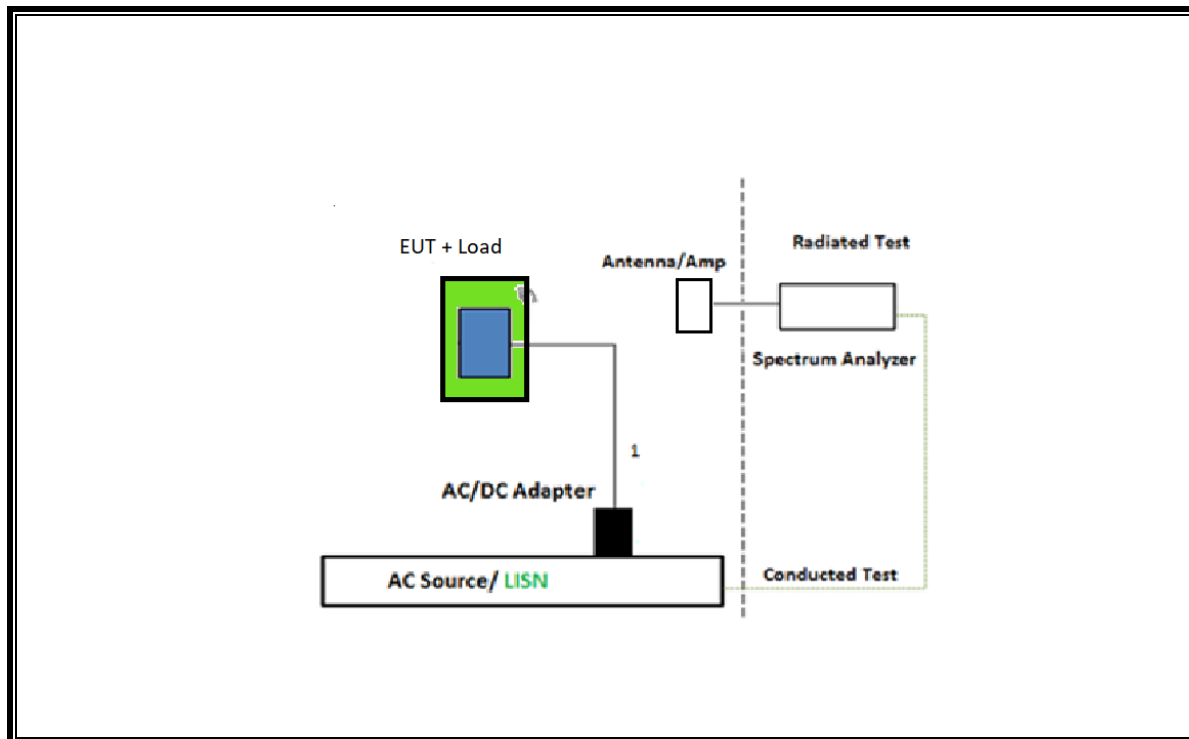

## 6. TEST AND MEASUREMENT EQUIPMENT

The following test and measurement equipment were utilized for the tests documented in this report:

TEST EQUIPMENT LIST					
Description	Manufacturer	Model	ID Num	Cal Due	Last Cal
*Antenna, Passive Loop 100KHz to 30MHz	ETS-Lindgren	EM-6872	170015	07/28/2023	07/28/2022
*Antenna, Passive Loop 30Hz to 1MHz	Electro-Metrics	EM-6871	170013	07/28/2023	07/28/2022
Antenna, Broadband Hybrid, 30MHz to 2000MHz w/4dB	Sunol Sciences Crop.	JB3	204044	02/29/2024	02/29/2023
Amplifier, 9kHz to 1GHz, 32dB	Sonoma Instrument	310N	222362	08/15/2023	08/15/2022
Sniffer Probes	Electro Metrics	EM-6992	N/A	N/A	N/A
Spectrum Analyzer, PXA, 3Hz to 44GHz	Agilent (Keysight) Technologies	N9030A-544	85213	01/31/2024	01/31/2023

AC Line Conducted					
Description	Manufacturer	Model	ID Num	Cal Due	Last Cal
EMI Test Receiver 9kHz-7GHz	Rohde & Schwarz	ESR	171646	02/29/2024	02/29/2023
LISN for Conducted Emissions	Fischer Custom Communications, Inc	FCC-LISN- 50/250-25-2-01- 480V	175765	01/24/2024	01/24/2023
*Transient Limiter	TE	TBFL1	207996	07/15/2023	07/15/2022
UL AUTOMATION SOFTWARE					
Radiated Software	UL	UL EMC	Ver 9.5, 01 May 2022		
Conducted Software	UL	UL EMC	2022.8.16		
AC Line Conducted Software	UL	UL EMC	Ver 9.5, 03 Mar 2022		

\*Testing is completed before equipment expiration date.

## 7. OCCUPIED BANDWIDTH

### TEST PROCEDURE

The transmitter output is connected to the spectrum analyzer. The RBW is set to 300Hz. The VBW is set to 3 times the RBW. The sweep time is coupled. The spectrum analyzer internal 99% bandwidth function is utilized.

Note: Because the measured signal is CW-like, adjusting the RBW per C63.10 would not be practical since measured bandwidth will always follow the RBW and the result will be approximately twice the RBW.

### RESULTS

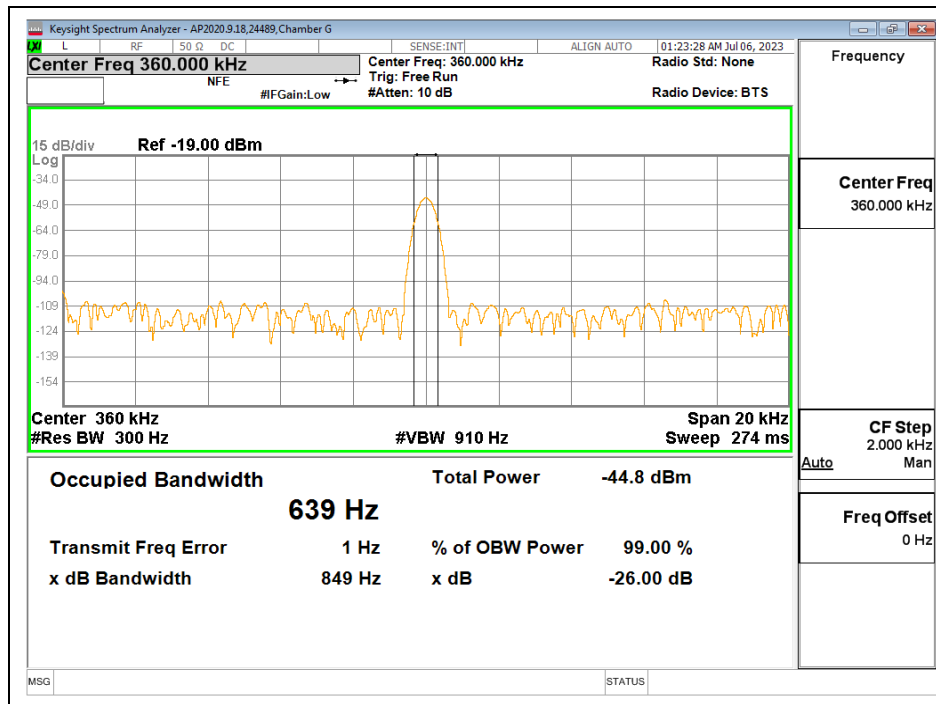

## 8. RADIATED EMISSION TEST RESULTS

### 8.1. LIMITS AND PROCEDURE

#### LIMITS

FCC §15.209 (a)

ICES-001 Section 3.3.4, IC RSS-216 6.2.2, and IC RSS-GEN Sections 8.9 and 8.10.

Frequency (MHz)	Field Strength (microvolts/meter)	Measurement Distance (m)
0.009–0.490	2400/F(kHz)	300
0.490–1.705	24000/F(kHz)	30
1.705–30.0	30	30
30–88	100	3
88 to 216	150	3
216 to 960	200	3
Above 960 MHz	500	3

Note: The lower limit shall apply at the transition frequency.

ICES-001 Issue 5 Table 2 & Table 4:

**Table 2: Magnetic field strength radiated emission limits for induction cooking appliances**

Frequency range (MHz)	Quasi-peak, at 3 m distance (dB $\mu$ A/m)
0.009 – 0.07	69
0.07 – 0.15	69 to 39 *
0.15 – 30	39 to 7 *

\* The limit level in dB $\mu$ A/m decreases linearly with the logarithm of frequency.

**Table 4: Electric field strength radiated emission limits for induction cooking appliances**

Frequency range (MHz)	OATS or SAC *		FAR *
	10 m measurement distance Quasi-peak (dB $\mu$ V/m)	3 m measurement distance Quasi-peak (dB $\mu$ V/m)	3 m measurement distance Quasi-peak (dB $\mu$ V/m)
30 – 230	30	40	42 to 35**
230 – 1000	37	47	42

**Note:** The more stringent limit applies at the transition frequency.  
 \* OATS = open-area test site, SAC = semi-anechoic chamber, FAR = fully-anechoic room (see CSA CISPR 11:19).  
 \*\* The limit level in dB $\mu$ V/m decreases linearly with the logarithm of frequency.

## RESULTS

## 8.2. Standby

### 8.2.1. FCC TX FUNDAMENTAL & SPURIOUS EMISSIONS (9 kHz - 30 MHz)

#### Standby

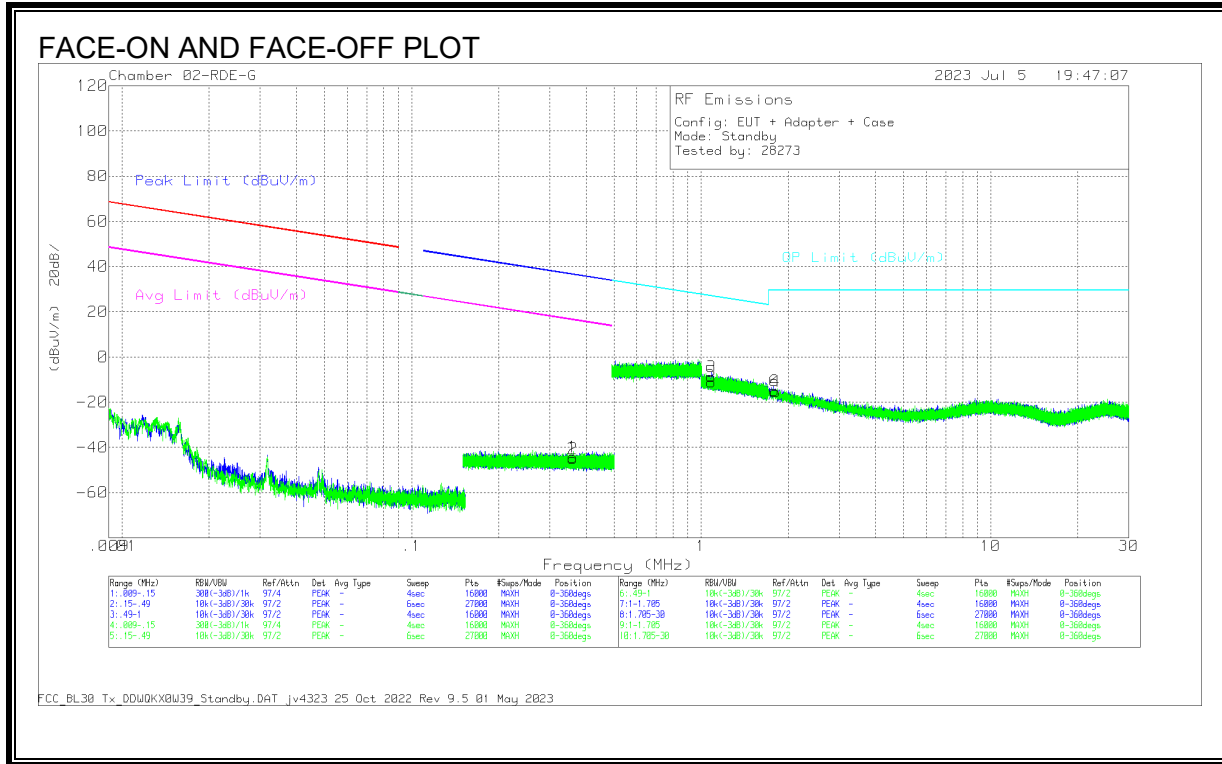

#### DATA

Marker	Frequency (MHz)	Meter Reading (dBuV)	Det	Loop Antenna E (ACF) dB/m	Cables/Amp (dB)	Dist Corr 300m dB	Corrected Reading (dBuV/m)	Peak Limit (dBuV/m)	Margin (dB)	Avg Limit (dBuV/m)	Margin (dB)	Azimuth (Degs)	Polarity
1	.3606	11.68	Pk	56	-32	-80	-44.32	36.47	-80.79	16.47	-60.79	0-360	Face-On
2	.3606	11.01	Pk	56	-32	-80	-44.99	36.47	-81.46	16.47	-61.46	0-360	Face-Off

Marker	Frequency (MHz)	Meter Reading (dBuV)	Det	Loop Antenna E (ACF) dB/m	Cables/Amp (dB)	Dist Corr 30m dB	Corrected Reading (dBuV/m)	QP Limit (dBuV/m)	Margin (dB)	Azimuth (Degs)	Polarity
3	1.0843	16.98	Pk	46.3	-32	-40	-8.72	26.92	-35.64	0-360	Face-On
5	1.0849	14.73	Pk	46.3	-32	-40	-10.97	26.92	-37.89	0-360	Face-Off
6	1.7951	14.4	Pk	42.6	-31.9	-40	-14.9	29.5	-44.4	0-360	Face-On
4	1.8067	14.1	Pk	42.5	-31.9	-40	-15.3	29.5	-44.8	0-360	Face-Off

Pk - Peak detector

## 8.2.2. IC/ ICES-001 TX FUNDAMENTAL & SPURIOUS EMISSIONS (9 kHz - 30 MHz)

### Standby

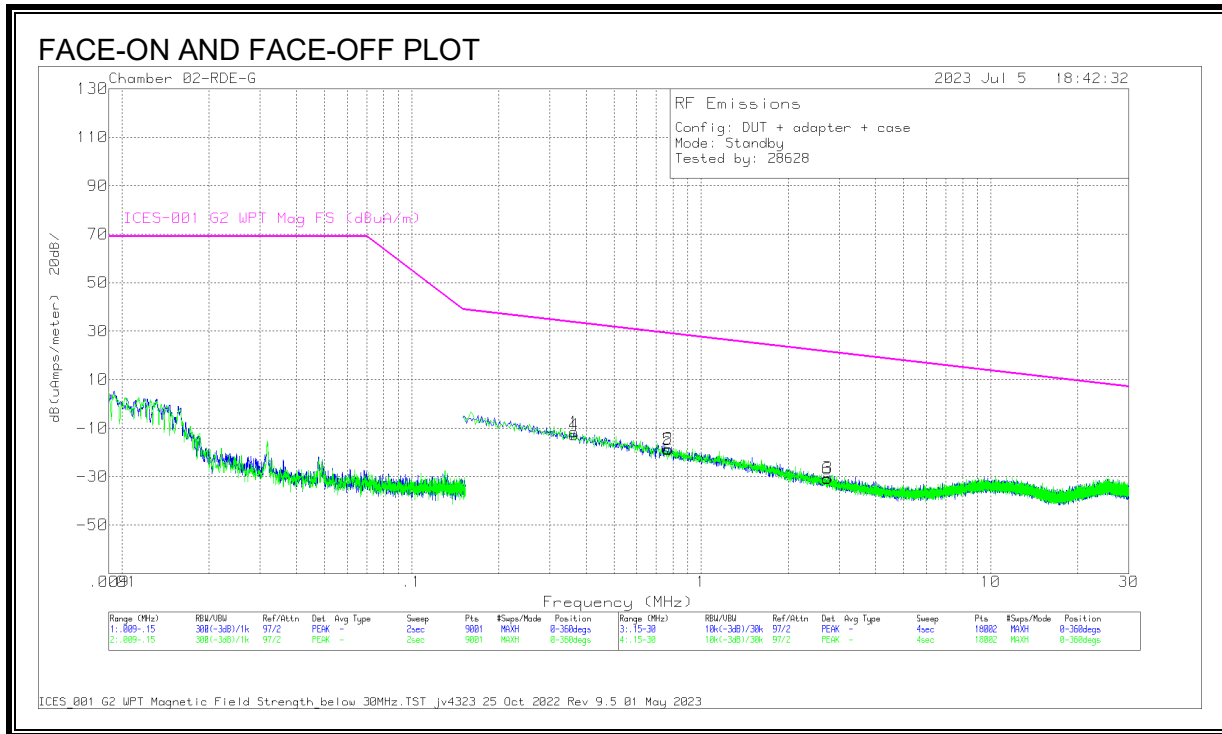

### DATA

Marker	Frequency (MHz)	Meter Reading (dBuV)	Det	Loop Antenna H(ACF) dB/m	Cables/Amp (dB)	Corrected Reading dB(uAmps/meter)	ICES-001 G2 WPT Mag FS (dBuA/m)	Margin (dB)	Azimuth (Degs)	Polarity
1	.3639	17.12	Pk	3.3	-32	-11.58	33.65	-45.23	0-360	Face-On
4	.3639	15.88	Pk	3.3	-32	-12.82	33.65	-46.47	0-360	Face-Off
2	.7684	16.21	Pk	-2.8	-32	-18.59	29.13	-47.72	0-360	Face-On
5	.7701	16.03	Pk	-2.8	-32	-18.77	29.12	-47.89	0-360	Face-Off
6	2.7265	13.09	Pk	-12	-31.9	-30.81	21.48	-52.29	0-360	Face-Off
3	2.7365	13.46	Pk	-12.1	-31.9	-30.54	21.46	-52	0-360	Face-On

Pk - Peak detector

### 8.2.3. FCC TX SPURIOUS EMISSION (30 - 1000 MHz)

#### Standby

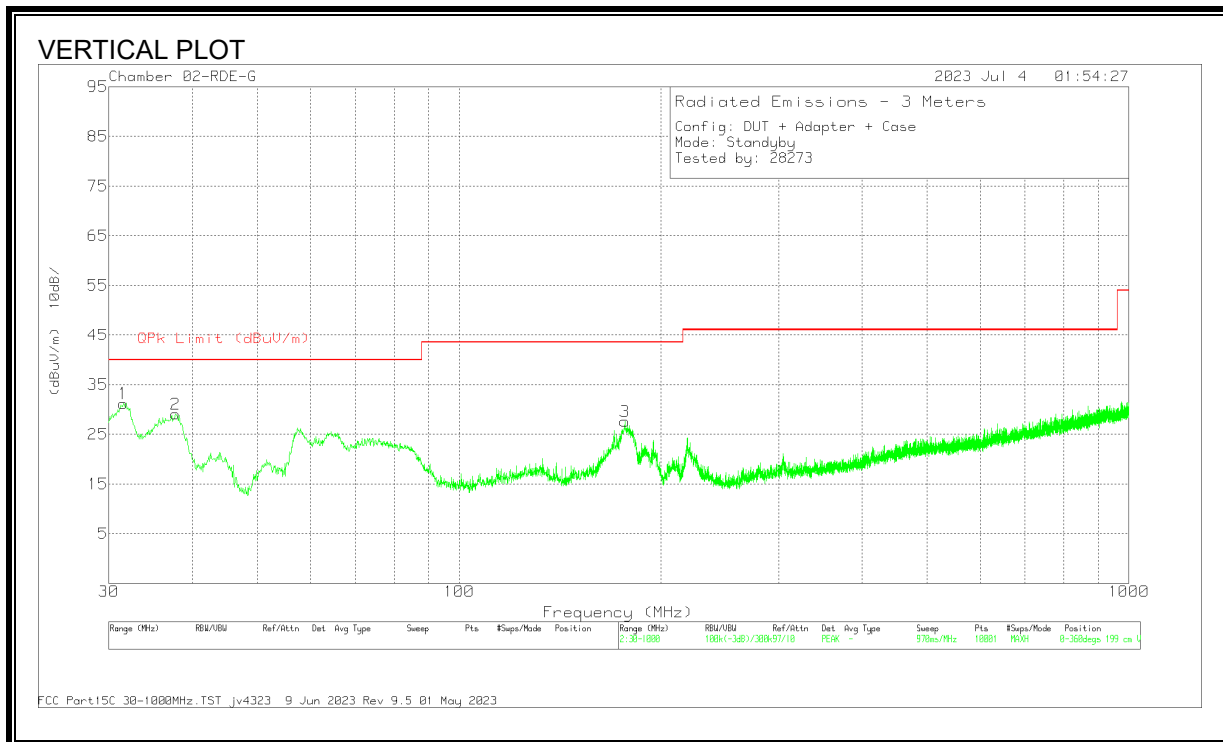
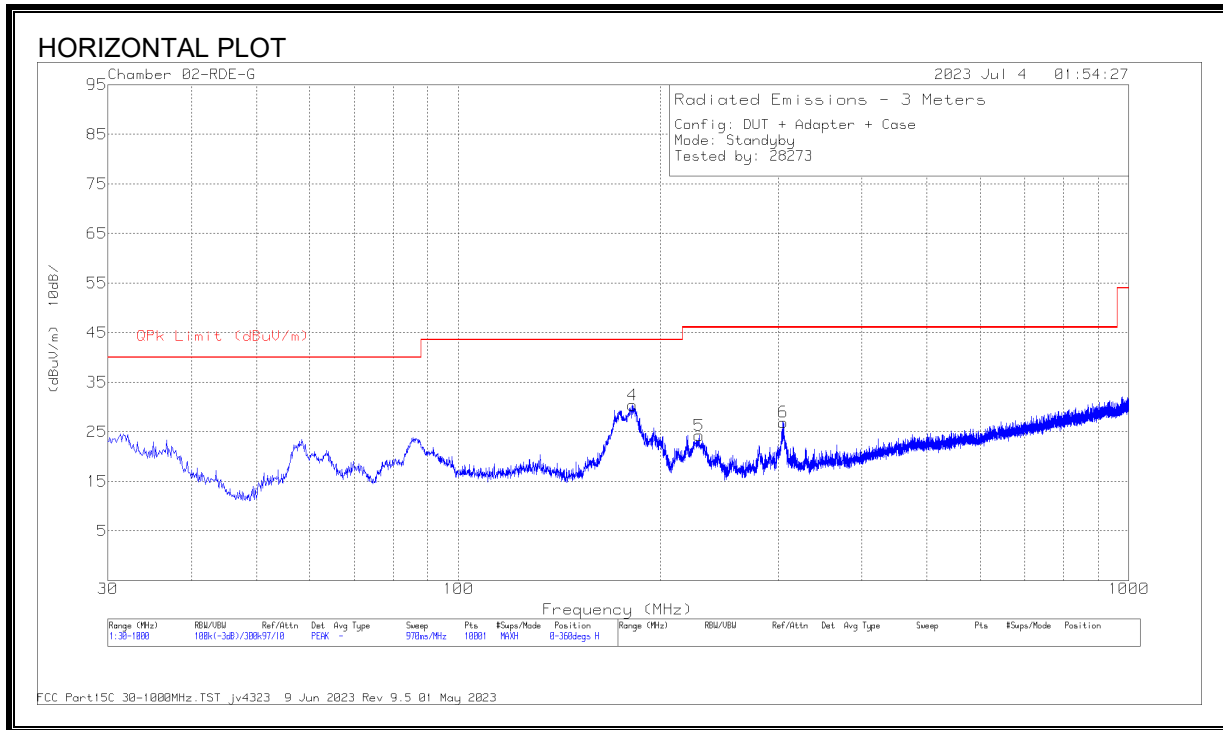



**DATA**

Marker	Frequency (MHz)	Meter Reading (dBuV)	Det	227855 ACF (dB) 3m H	Amp Cbl (dB)	Corrected Reading (dBuV/m)	QPk Limit (dBuV/m)	Margin (dB)	Azimuth (Degs)	Height (cm)	Polarity
2	* 37.76	39.07	Pk	21.2	-31.2	29.07	40	-10.93	0-360	100	V
1	31.552	37.29	Pk	25.2	-31.3	31.19	40	-8.81	0-360	100	V
3	176.858	40.3	Pk	17.3	-30	27.6	43.52	-15.92	0-360	199	V
4	181.999	43.29	Pk	17	-29.9	30.39	43.52	-13.13	0-360	99	H
5	228.656	36.95	Pk	16.9	-29.6	24.25	46.02	-21.77	0-360	99	H
6	305.48	36.64	Pk	19.5	-29.2	26.94	46.02	-19.08	0-360	99	H

\* - indicates frequency in CFR47 Pt 15 / IC RSS-Restricted Band

Pk - Peak detector

### 8.2.4. IC/ ICES-001 TX SPURIOUS EMISSION (30 - 1000 MHz)

#### Standby

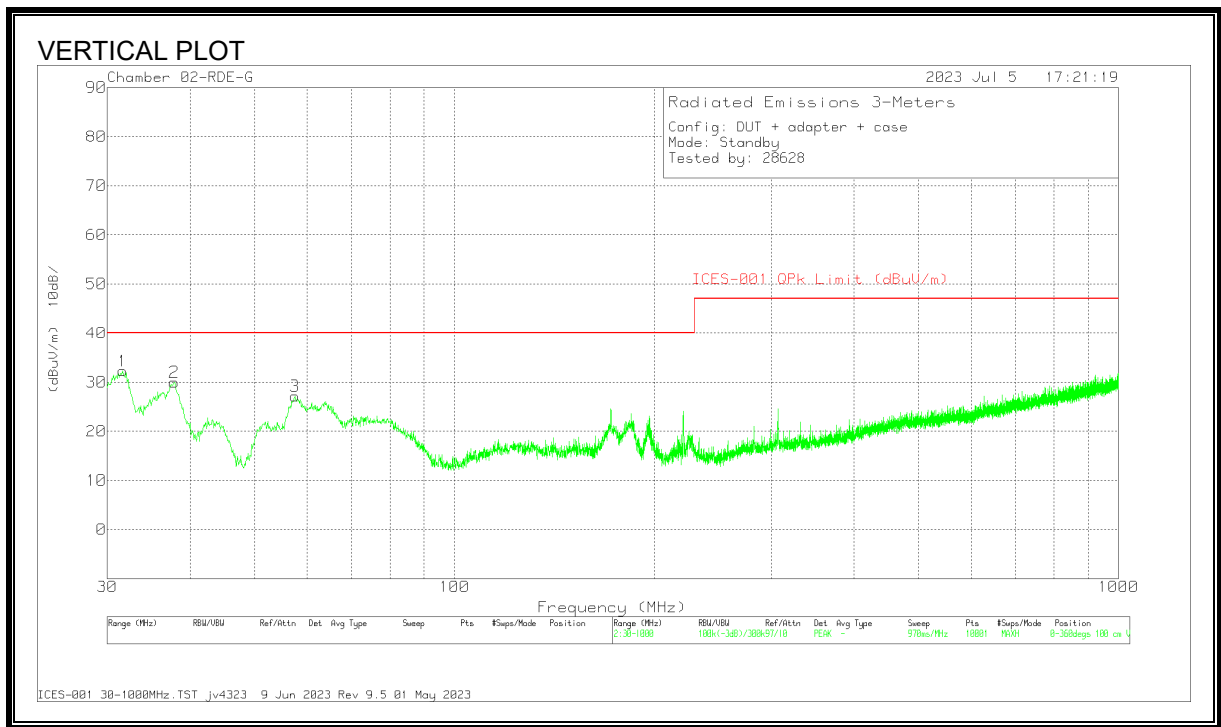
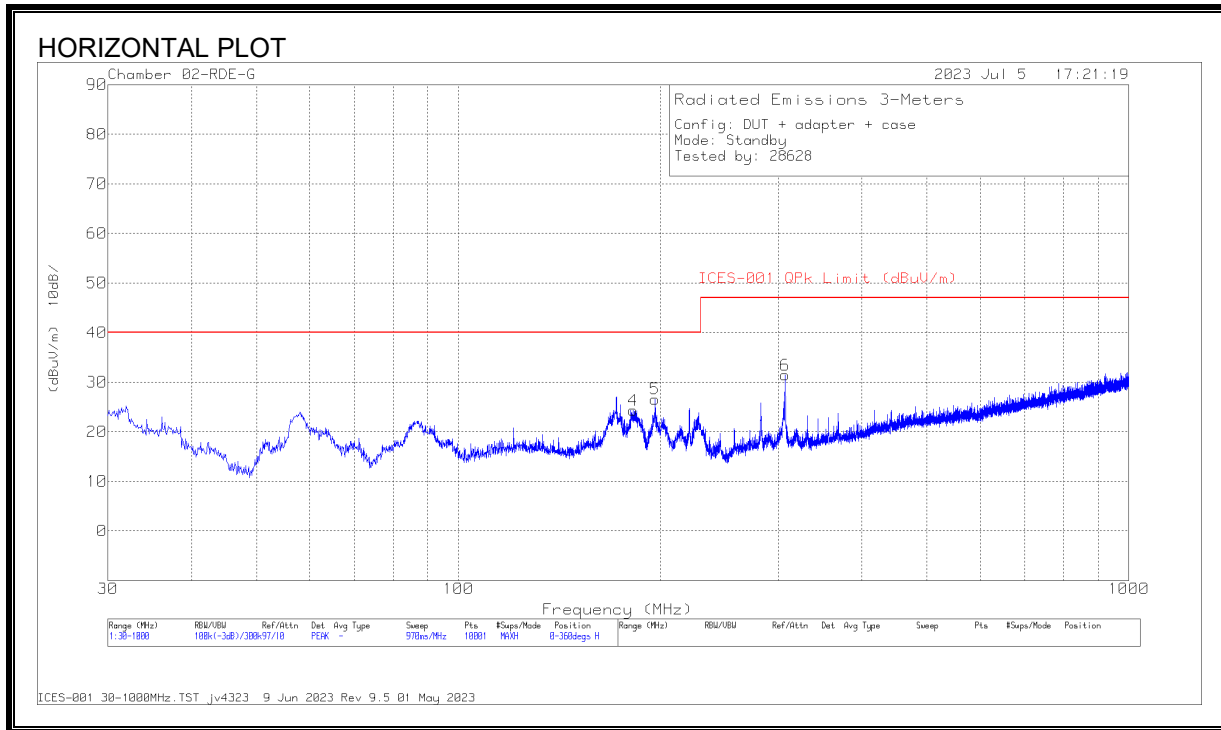

**DATA**

Marker	Frequency (MHz)	Meter Reading (dBuV)	Det	227855 ACF (dB) 3m H	Amp Cbl (dB)	Corrected Reading (dBuV/m)	ICES-001 QPk Limit (dBuV/m)	Margin (dB)	Azimuth (Degs)	Height (cm)	Polarity
1	31.649	38.39	Pk	25.2	-31.3	32.29	40	-7.71	0-360	100	V
2	37.857	40.1	Pk	21.1	-31.2	30	40	-10	0-360	100	V
3	57.548	44.96	Pk	13.2	-31	27.16	40	-12.84	0-360	100	V
4	182.387	37.23	Pk	17	-29.9	24.33	40	-15.67	0-360	199	H
5	196.549	38.4	Pk	18	-29.8	26.6	40	-13.4	0-360	99	H
6	307.129	40.94	Pk	19.6	-29.1	31.44	47	-15.56	0-360	99	H

Pk - Peak detector

### 8.3.EUT With Load

#### 8.3.1. FCC TX FUNDAMENTAL & SPURIOUS EMISSIONS (9 kHz - 30 MHz) OPERATING WITH LOAD

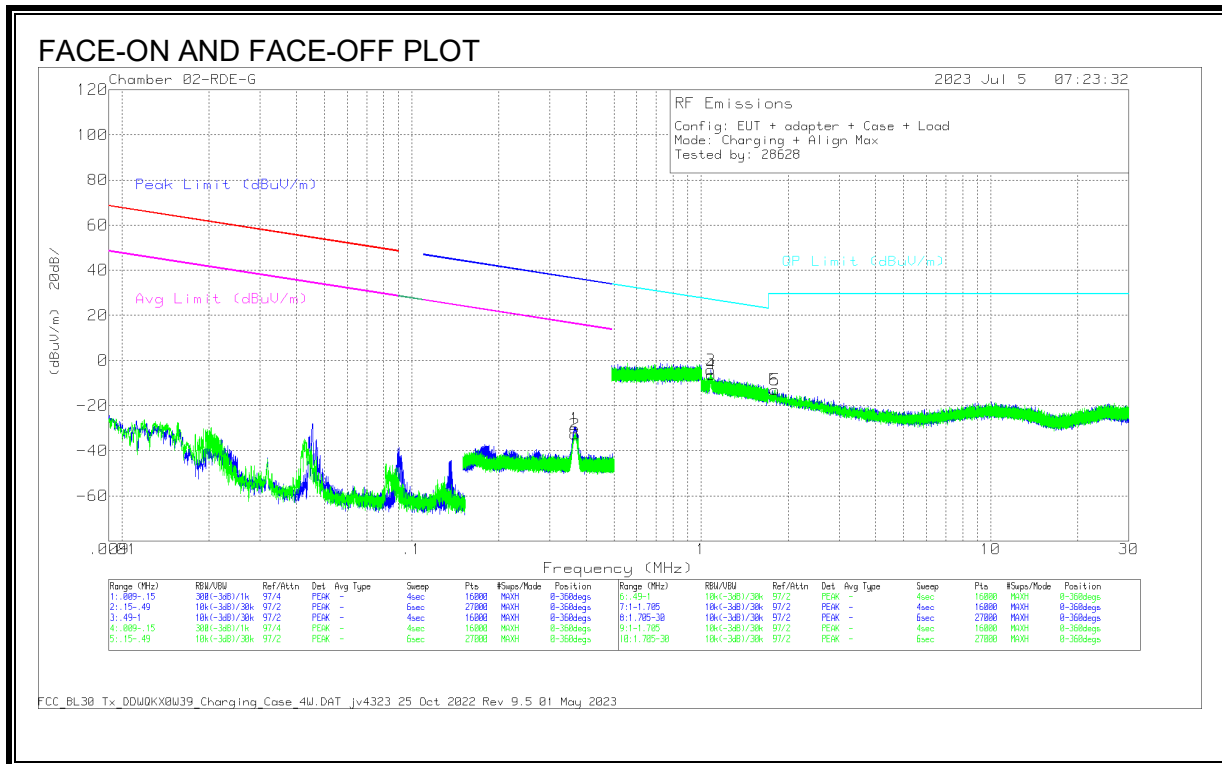

#### DATA

Marker	Frequency (MHz)	Meter Reading (dBuV)	Det	Loop Antenna E (ACF)	Cables/Amp (dB)	Dist Corr 300m	Corrected Reading (dBuVolts)	Peak Limit (dBuV/m)	Margin (dB)	Avg Limit (dBuV/m)	Margin (dB)	Azimuth (Degs)	Polarity
1	.3657	26.04	Pk	56	-32	-80	-29.96	36.35	-66.31	16.35	-46.31	0-360	Face-On
2	.3665	23.31	Pk	56	-32	-80	-32.69	36.33	-69.02	16.33	-49.02	0-360	Face-Off

Marker	Frequency (MHz)	Meter Reading (dBuV)	Det	Loop Antenna E (ACF)	Cables/Amp (dB)	Dist Corr 30m	Corrected Reading (dBuVolts)	QP Limit (dBuV/m)	Margin (dB)	Azimuth (Degs)	Polarity
3	1.079	21.45	Pk	46.4	-32	-40	-4.15	26.96	-31.11	0-360	Face-On
4	1.0834	19.57	Pk	46.3	-32	-40	-6.13	26.93	-33.06	0-360	Face-Off
5	1.7983	16.34	Pk	42.6	-31.9	-40	-12.96	29.5	-42.46	0-360	Face-On
6	1.7983	16.35	Pk	42.6	-31.9	-40	-12.95	29.5	-42.45	0-360	Face-Off

Pk - Peak detector

### 8.3.2. IC/ ICES-001 TX FUNDAMENTAL & SPURIOUS EMISSIONS (9 kHz - 30 MHz)

**OPERATING WITH LOAD**

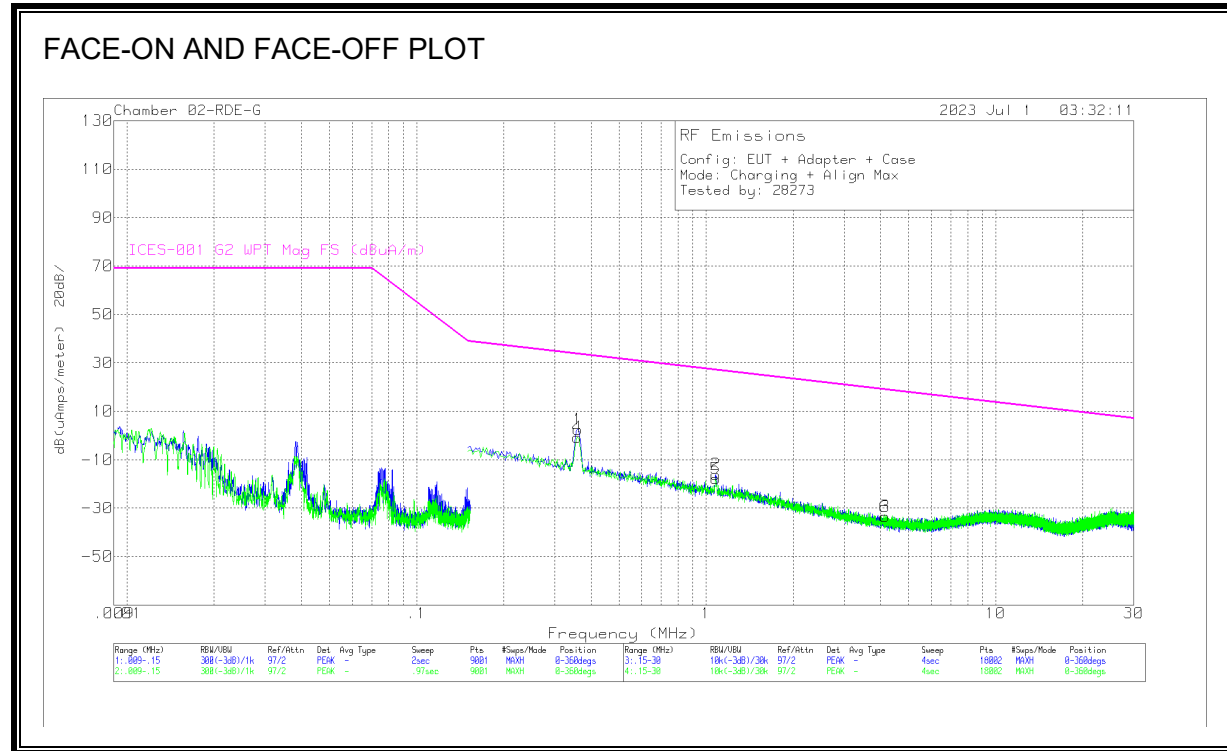

**DATA**

Marker	Frequency (MHz)	Meter Reading (dBuV)	Det	Loop Antenna H(ACF) dB/m	Cables/Am p (dB)	Corrected Reading dB(uAmps/ meter)	ICES-001 G2 WPT Mag FS (dBuA/m)	Margin (dB)	Azimuth (Degs)	Polarity
4	3589	27.92	Pk	3.4	-32	-68	33.73	-34.41	0-360	Face-Off
1	3606	31.21	Pk	3.4	-32	2.61	33.7	-31.09	0-360	Face-On
2	1.0801	21.1	Pk	-5.1	-32	-16	27.08	-43.08	0-360	Face-On
5	1.0801	19.38	Pk	-5.1	-32	-17.72	27.08	-44.8	0-360	Face-Off
6	4.1474	12.86	Pk	-14.5	-31.8	-33.44	18.95	-52.39	0-360	Face-Off
3	4.1624	12.95	Pk	-14.5	-31.8	-33.35	18.93	-52.28	0-360	Face-On

Pk - Peak detector

### 8.3.3. FCC TX SPURIOUS EMISSION (30 - 1000 MHz)

#### OPERATING WITH LOAD

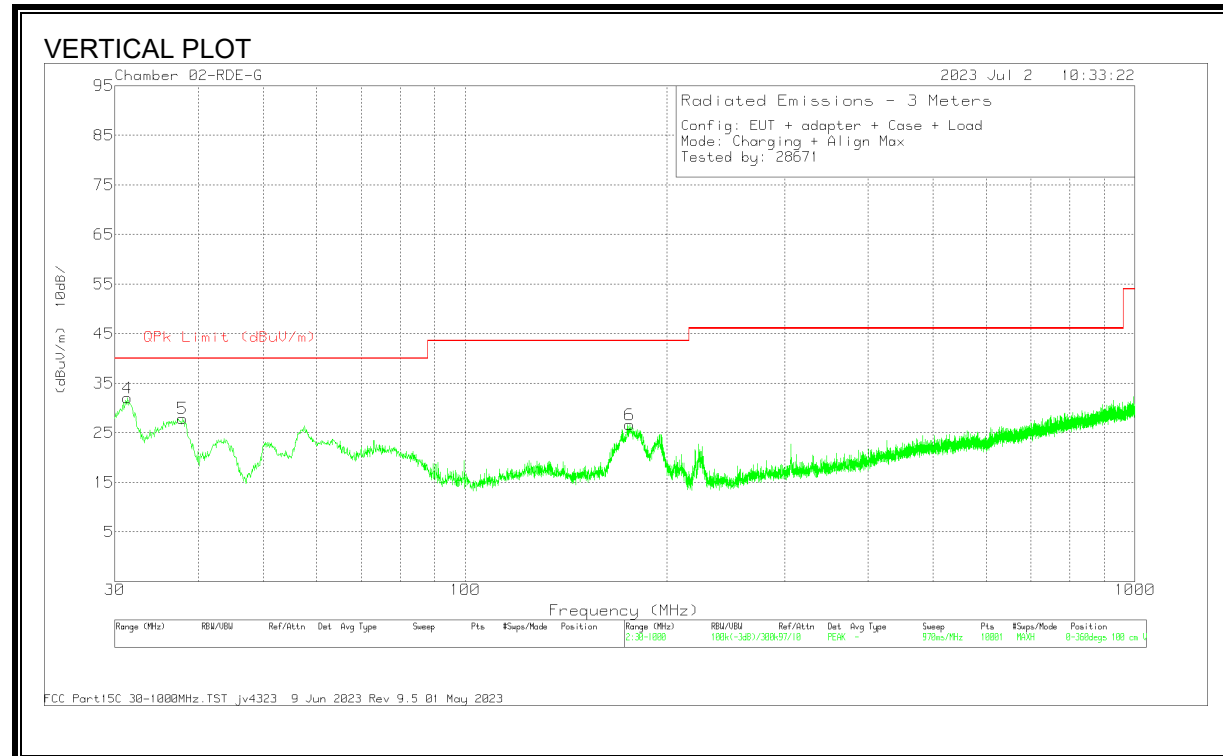
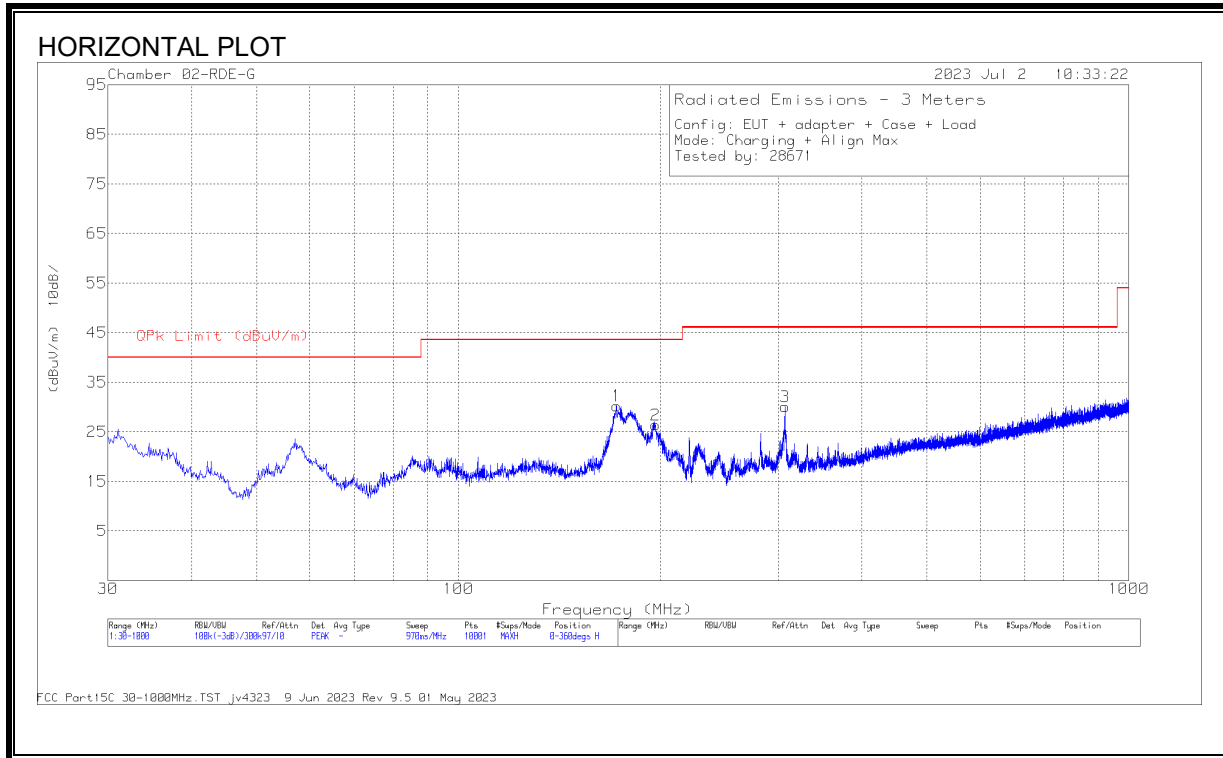

**DATA****Radiated Emissions**

Marker	Frequency (MHz)	Meter Reading (dBuV)	Det	227855 ACF (dB) 3m H	Amp Cbl (dB)	Corrected Reading (dBuV/m)	QPk Limit (dBuV/m)	Margin (dB)	Azimuth (Degs)	Height (cm)	Polarity
4	* 37.98	32.53	Qp	21	-31.2	22.33	40	-17.67	49	117	V
5	31.2502	32.56	Qp	25.4	-31.3	26.66	40	-13.34	353	117	V
1	174.591	40.55	Qp	17.4	-30	27.95	43.52	-15.57	134	110	H
6	176.048	35	Qp	17.4	-30	22.4	43.52	-21.12	138	179	V
2	180.728	38.54	Qp	17.1	-29.9	25.74	43.52	-17.78	121	119	H
3	305.839	37.67	Qp	19.5	-29.2	27.97	46.02	-18.05	142	104	H

\* - indicates frequency in CFR47 Pt 15 / IC RSS-Restricted Band

Qp - Quasi-Peak detector

### 8.3.4. IC/ ICES-001 TX SPURIOUS EMISSION (30 - 1000 MHz)

#### OPERATING WITH LOAD

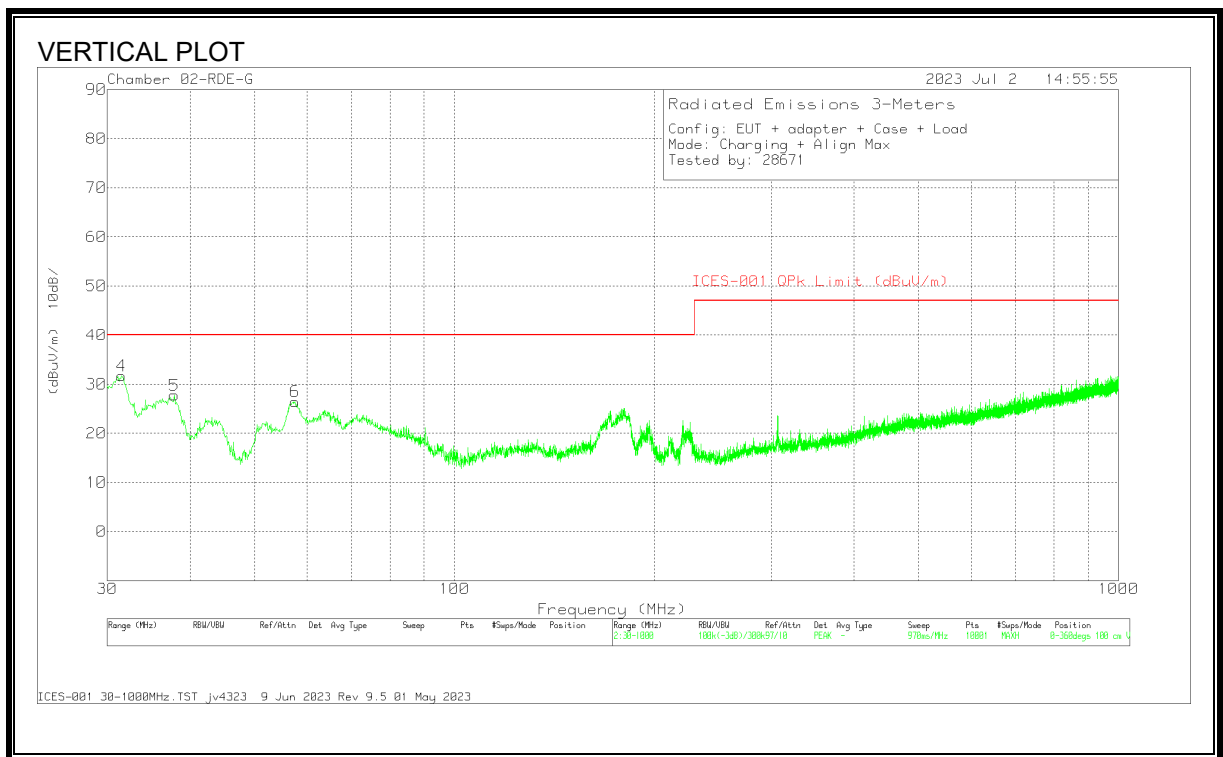
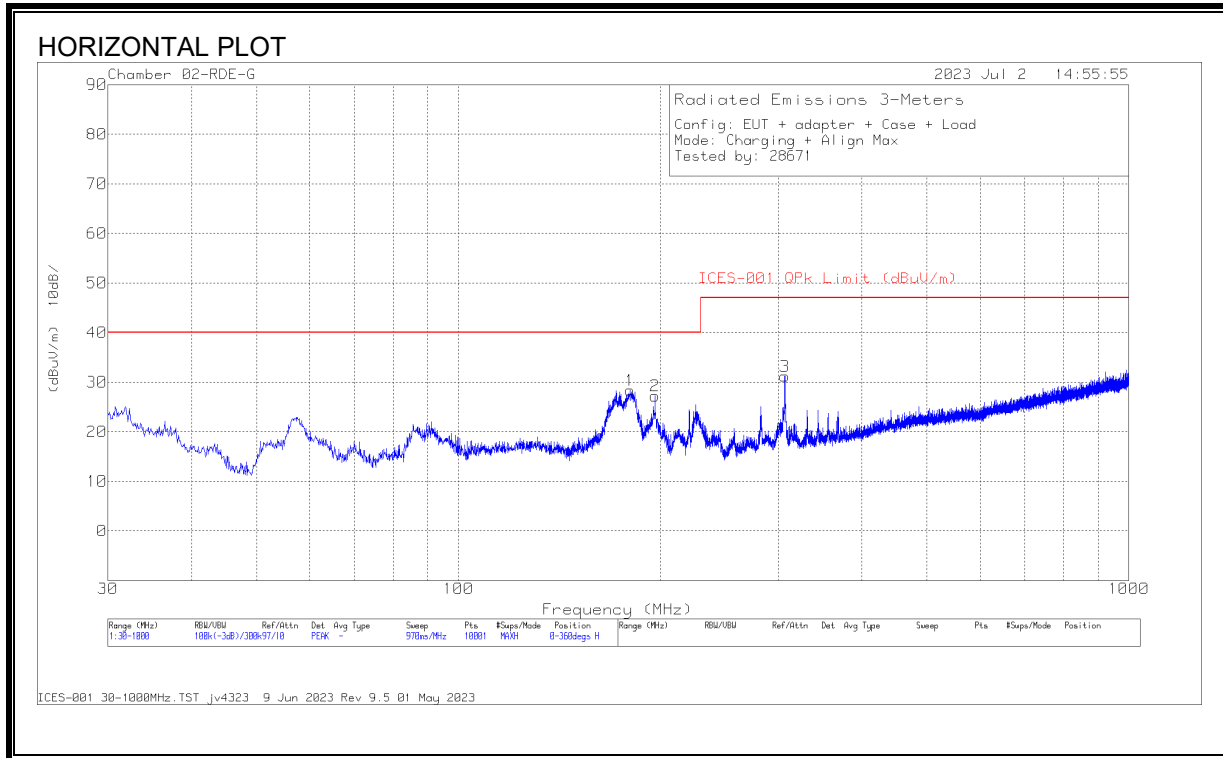



**Radiated Emissions**

Marker	Frequency (MHz)	Meter Reading (dBuV)	Det	227855 ACF (dB) 3m H	Amp Cbl (dB)	Corrected Reading (dBuV/m)	ICES-001 QPk Limit (dBuV/m)	Margin (dB)	Azimuth (Degs)	Height (cm)	Polarity
4	31.5524	33.4	Qp	25.2	-31.3	27.3	40	-12.7	321	102	V
5	37.935	31.83	Qp	21	-31.2	21.63	40	-18.37	219	114	V
6	57.243	40.97	Qp	13.1	-31	23.07	40	-16.93	248	135	V
1	180.332	37.37	Qp	17.1	-29.9	24.57	40	-15.43	141	191	H
2	196.129	36.31	Qp	18	-29.8	24.51	40	-15.49	122	181	H
3	306.515	39.19	Qp	19.6	-29.2	29.59	47	-17.41	153	105	H

Qp - Quasi-Peak detector

## 9. AC POWER LINE CONDUCTED EMISSIONS

### LIMITS

FCC §15.207 (a)

Frequency of Emission (MHz)	Conducted Limit (dB $\mu$ V)	
	Quasi-peak	Average
0.15-0.5	66 to 56 *	56 to 46 *
0.5-5	56	46
5-30	60	50

\*Decreases with the logarithm of the frequency.

ICES-001 Issue 5 Table 1:

**Table 1: Conducted emission limits for induction cooking appliances (AC mains terminals)**

Frequency range (MHz)	Appliances rated 100 V, without an earth connection Quasi-peak (dB $\mu$ V)	Appliances rated 100 V, without an earth connection Average (dB $\mu$ V)	All other appliances Quasi-peak (dB $\mu$ V)	All other appliances Average (dB $\mu$ V)
0.009 – 0.05	122	—	110	—
0.05 – 0.15	102 to 92 *	—	90 to 80 *	—
0.15 – 0.5	72 to 62 *	62 to 52 *	66 to 56 *	56 to 46 *
0.5 – 5	56	46	56	46
5 – 30	60	50	60	50

**Note:** The more stringent limit applies at transition frequencies.  
\* The limit level in dB $\mu$ V decreases linearly with the logarithm of frequency.

### TEST PROCEDURE

The EUT is placed on a non-conducting table 40 cm from the vertical ground plane and 80 cm above the horizontal ground plane. The EUT is configured in accordance with ANSI C63.10.

The receiver is set to a resolution bandwidth of 200Hz, from 9KHz to 150KHz, resolution bandwidth of 9KHz from 150KHz to 30MHz. Peak detection is used unless otherwise noted as quasi-peak or average.

Line conducted data is recorded for both NEUTRAL and HOT lines.

### RESULTS

Note: The limits on the plots from 150kHz – 30MHz cover both ICES-001 and FCC Part 15.207.

## 9.1. Standby

### 9.1.1. STANDBY MODE POWERED BY AC/DC ADAPTER

#### LINE 1 RESULTS

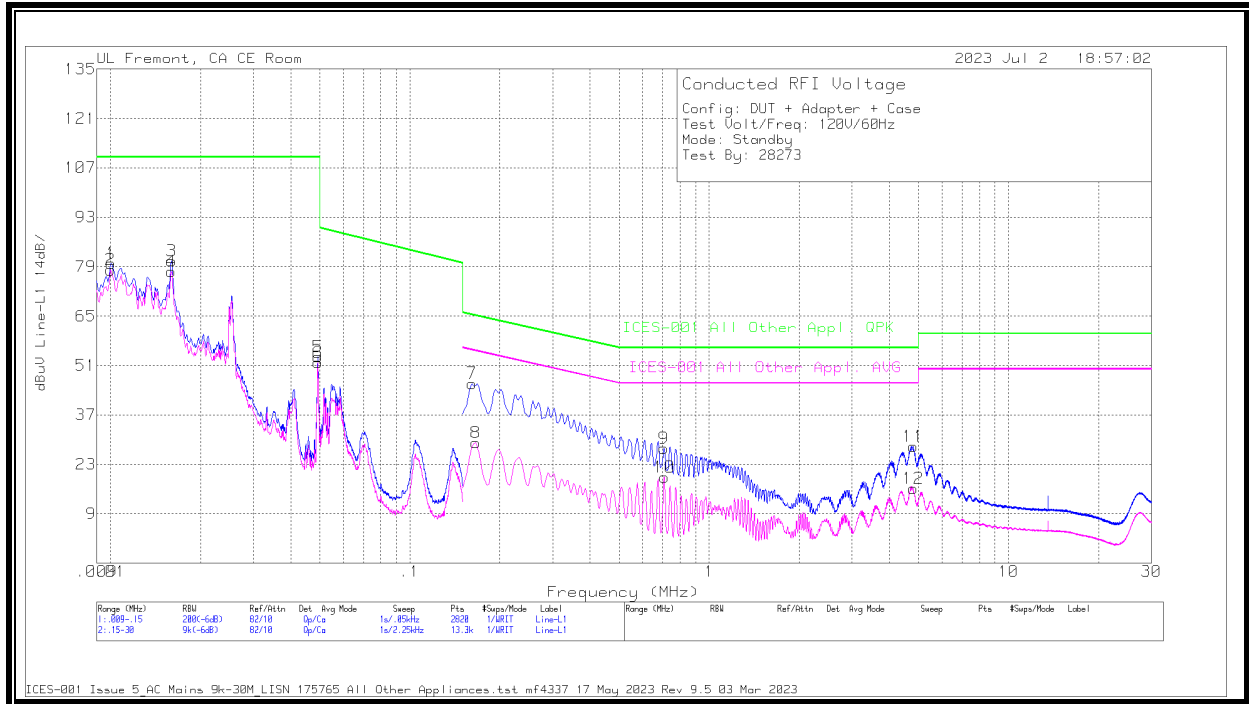

#### WORST EMISSIONS

Range 1: Line-L1 .009 - .15MHz											
Marker	Frequency (MHz)	Meter Reading (dBuV)	Det	L1_LISN.c sv dB	C1&C3 cable path loss dB	207996 Limiter with short cabl dB	Corrected Reading dBuV	ICES-001 All Other Appl. QPK dBuV	Margin (dB)	ICES-001 All Other Appl. AVG dBuV	Margin (dB)
2	.01	61.3	Ca	4.4	0	12.4	78.1	-	-	-	-
4	.016	64.82	Ca	2	0	10.9	77.72	-	-	-	-
6	.0493	41.96	Ca	.1	0	9.9	51.96	-	-	-	-
1	.0101	63.25	Qp	4.4	0	12.3	79.95	110	-30.05	-	-
3	.016	67.82	Qp	2	0	10.9	80.72	110	-29.28	-	-
5	.0493	43.51	Qp	.1	0	9.9	53.51	110	-56.49	-	-

Range 2: Line-L1 .15 - 30MHz											
Marker	Frequency (MHz)	Meter Reading (dBuV)	Det	L1_LISN.c sv dB	C1&C3 cable path loss dB	207996 Limiter with short cabl dB	Corrected Reading dBuV	ICES-001 All Other Appl. QPK dBuV	Margin (dB)	ICES-001 All Other Appl. AVG dBuV	Margin (dB)
8	.1658	19.67	Ca	0	0	9.4	29.07	-	-	55.17	-26.1
10	.708	9.96	Ca	0	.1	9.3	19.36	-	-	46	-26.64
12	4.794	6.8	Ca	0	.1	9.3	16.2	-	-	46	-29.8
7	.1613	36.52	Qp	0	0	9.4	45.92	65.4	-19.48	-	-
9	.7058	18.13	Qp	0	.1	9.3	27.53	56	-28.47	-	-
11	4.7985	18.63	Qp	0	.1	9.3	28.03	56	-27.97	-	-

**Line 2 Results**

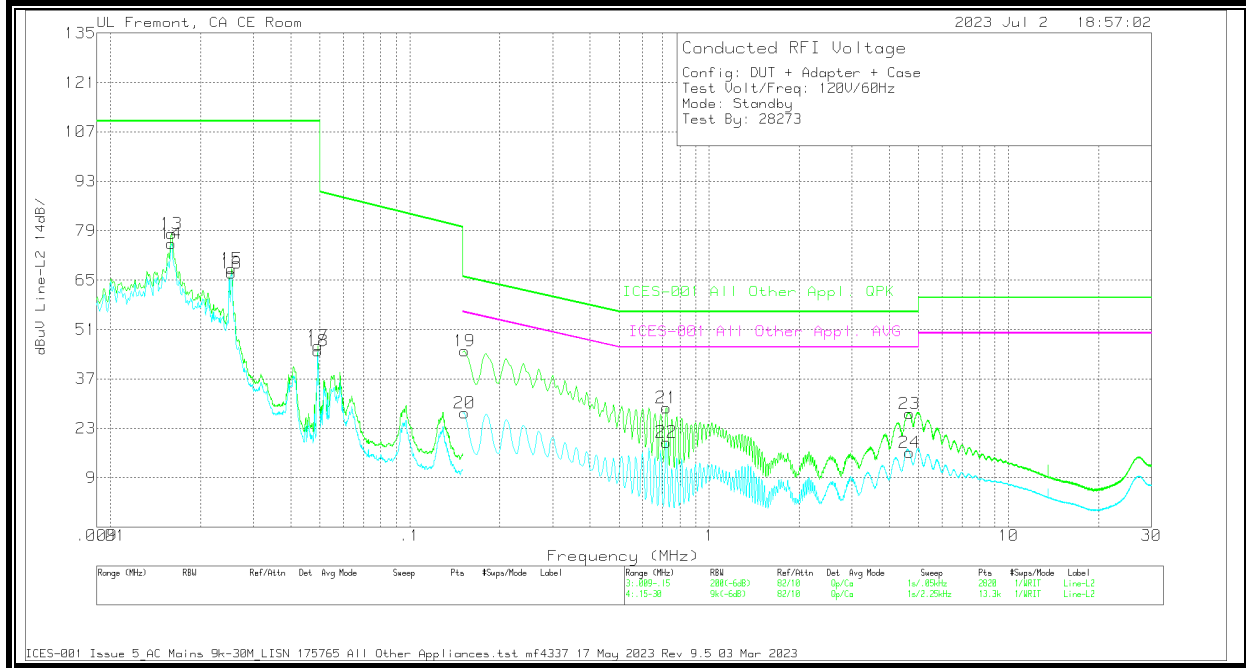

**WORST EMISSIONS**

Range 3: Line-L2 .009 - .15MHz											
Marker	Frequency (MHz)	Meter Reading (dBuV)	Det	L2_LISN dB	C2&C3 cable path loss dB	207996 Limiter with short cabl dB	Corrected Reading dBuV	ICES-001 All Other Appl. QPK dBuV	Margin (dB)	ICES-001 All Other Appl. AVG dBuV	Margin (dB)
14	.016	62.29	Ca	2.1	0	10.9	75.29	-	-	-	-
16	.0253	55.13	Ca	1	0	10.8	66.93	-	-	-	-
18	.0493	35.04	Ca	0	0	9.9	44.94	-	-	-	-
13	.016	65.26	Qp	2.1	0	10.9	78.26	110	-31.74	-	-
15	.0254	56.36	Qp	1	0	10.8	68.16	110	-41.84	-	-
17	.0493	36.33	Qp	0	0	10	46.33	110	-63.67	-	-

Range 4: Line-L2 .15 - 30MHz											
Marker	Frequency (MHz)	Meter Reading (dBuV)	Det	L2_LISN dB	C2&C3 cable path loss dB	207996 Limiter with short cabl dB	Corrected Reading dBuV	ICES-001 All Other Appl. QPK dBuV	Margin (dB)	ICES-001 All Other Appl. AVG dBuV	Margin (dB)
20	.1523	18.01	Ca	0	0	9.4	27.41	-	-	55.88	-28.47
22	.7193	9.69	Ca	0	.1	9.3	19.09	-	-	46	-26.91
24	4.6703	6.68	Ca	0	.1	9.3	16.08	-	-	46	-29.92
19	.1523	35.5	Qp	0	0	9.4	44.9	65.88	-20.98	-	-
21	.7193	19.46	Qp	0	.1	9.3	28.86	56	-27.14	-	-
23	4.6725	17.86	Qp	0	.1	9.3	27.26	56	-28.74	-	-

Qp - Quasi-Peak detector  
Ca - CISPR average detection

## 9.2. EUT With Load

### 9.2.1. OPERATING MODE WITH LOAD POWERED BY AC/DC ADAPTER

#### LINE 1 RESULTS

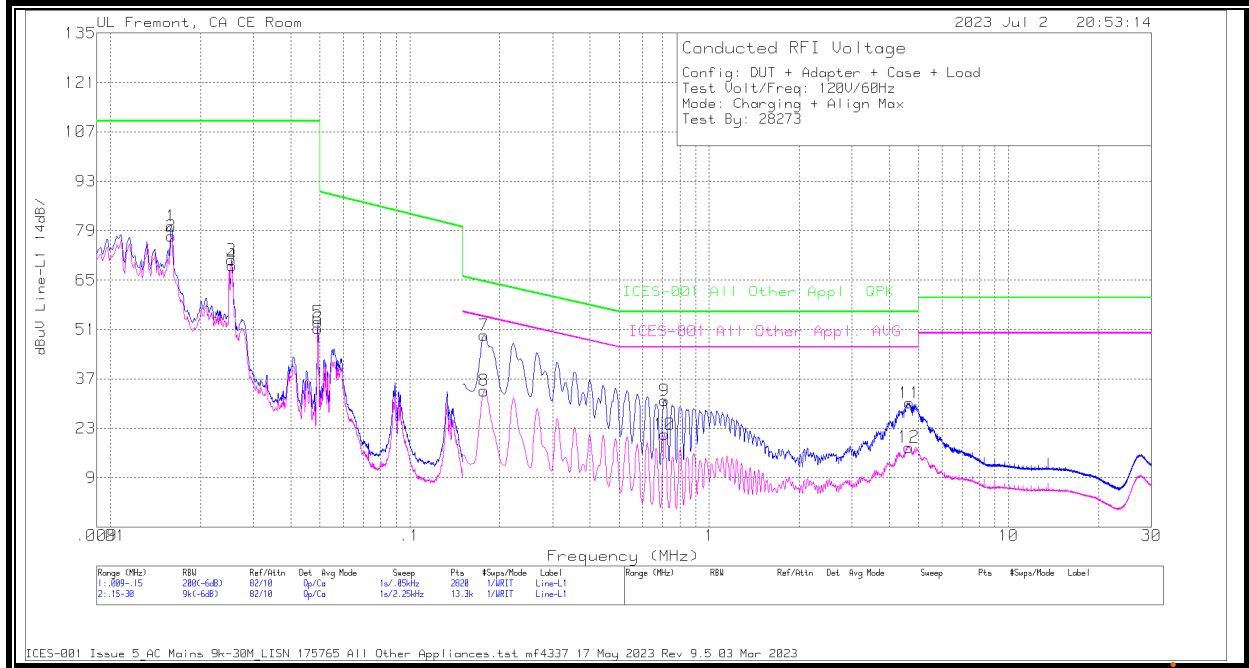

#### WORST EMISSIONS

Range 1: Line-L1 .009 - .15MHz											
Marker	Frequency (MHz)	Meter Reading (dBuV)	Det	L1_LISN.csv dB	C1&C3 cable path loss dB	207996 Limiter with short cabl dB	Corrected Reading dBuV	ICES-001 All Other Appl. QPK dBuV	Margin (dB)	ICES-001 All Other Appl. AVG dBuV	Margin (dB)
2	.016	64.51	Ca	2	0	10.9	77.41	-	-	-	-
4	.0255	57.41	Ca	1	0	10.8	69.21	-	-	-	-
6	.0493	41.42	Ca	.1	0	9.9	51.42	-	-	-	-
1	.016	67.38	Qp	2	0	10.9	80.28	110	-29.72	-	-
3	.0254	58.88	Qp	1	0	10.8	70.68	110	-39.32	-	-
5	.0493	43.1	Qp	.1	0	9.9	53.1	110	-56.9	-	-

Range 2: Line-L1 .15 - 30MHz											
Marker	Frequency (MHz)	Meter Reading (dBuV)	Det	L1_LISN.csv dB	C1&C3 cable path loss dB	207996 Limiter with short cabl dB	Corrected Reading dBuV	ICES-001 All Other Appl. QPK dBuV	Margin (dB)	ICES-001 All Other Appl. AVG dBuV	Margin (dB)
8	.177	24.27	Ca	0	0	9.4	33.67	-	-	54.63	-20.96
10	.708	11.84	Ca	0	.1	9.3	21.24	-	-	46	-24.76
12	4.6455	8.27	Ca	0	.1	9.3	17.67	-	-	46	-28.33
7	.177	40.02	Qp	0	0	9.4	49.42	64.63	-15.21	-	-
9	.708	21.59	Qp	0	.1	9.3	30.99	56	-25.01	-	-
11	4.659	20.82	Qp	0	.1	9.3	30.22	56	-25.78	-	-

**LINE 2 RESULTS**

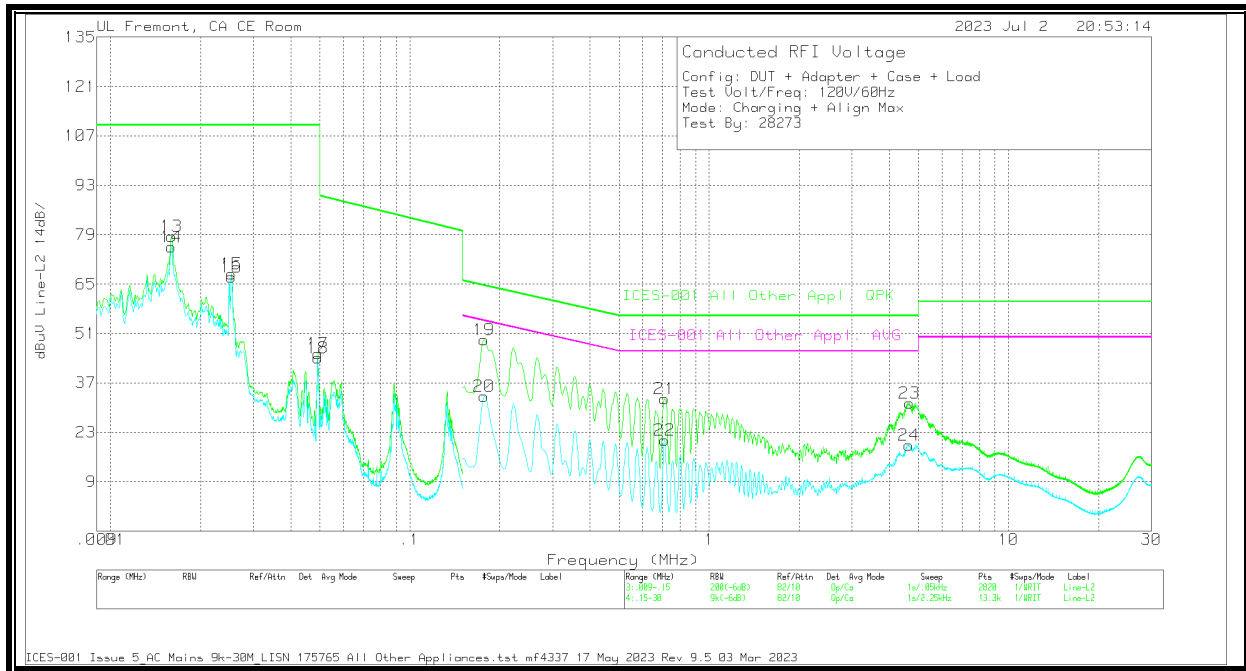

**WORST EMISSIONS**

Range 3: Line-L2 .009 - .15MHz											
Marker	Frequency (MHz)	Meter Reading (dBuV)	Det	L2_LISN dB	C2&C3 cable path loss dB	207996 Limiter with short cabl dB	Corrected Reading dBuV	ICES-001 All Other Appl. QPK dBuV	Margin (dB)	ICES-001 All Other Appl. AVG dBuV	Margin (dB)
14	.016	62.57	Ca	2.1	0	10.9	75.57	-	-	-	-
16	.0253	55.11	Ca	1	0	10.8	66.91	-	-	-	-
18	.0493	34.11	Ca	0	0	9.9	44.01	-	-	-	-
13	.016	65.48	Qp	2.1	0	10.9	78.48	110	-31.52	-	-
15	.0254	56.07	Qp	1	0	10.8	67.87	110	-42.13	-	-
17	.0493	35.42	Qp	0	0	9.9	45.32	110	-64.68	-	-

Range 4: Line-L2 .15 - 30MHz											
Marker	Frequency (MHz)	Meter Reading (dBuV)	Det	L2_LISN dB	C2&C3 cable path loss dB	207996 Limiter with short cabl dB	Corrected Reading dBuV	ICES-001 All Other Appl. QPK dBuV	Margin (dB)	ICES-001 All Other Appl. AVG dBuV	Margin (dB)
20	.177	23.79	Ca	0	0	9.4	33.19	-	-	54.63	-21.44
22	.708	11.39	Ca	0	.1	9.3	20.79	-	-	46	-25.21
24	4.6343	9.99	Ca	0	.1	9.3	19.39	-	-	46	-26.61
19	.177	39.89	Qp	0	0	9.4	49.29	64.63	-15.34	-	-
21	.708	23.06	Qp	0	.1	9.3	32.46	56	-23.54	-	-
23	4.6568	21.8	Qp	0	.1	9.3	31.2	56	-24.8	-	-

Qp - Quasi-Peak detector  
Ca - CISPR average detection

## **SETUP PHOTOS**

Please refer to 14523772-EP1V1 for setup photos

## **END OF TEST REPORT**