



**Part 2: Test Under Dynamic Transmission Condition**

*For*  
**SMARTPHONE**

**FCC ID: BCG-E8440A**  
**Model Name: A3105**

**Report Number: 14523772-S4V1**  
**Issue Date: 8/9/2023**

*Prepared for*  
**APPLE INC.**  
**1 APPLE PARK WAY**  
**CUPERTINO, CA 95014-2084**

*Prepared by*  
**UL VERIFICATION SERVICES INC.**  
**47173 BENICIA STREET**  
**FREMONT, CA 94538, U.S.A.**  
**TEL: (510) 319-4000**  
**FAX: (510) 661-0888**

**Revision History**

Rev.	Date	Revisions	Revised By
V1	8/9/2023	Initial Issue	--

## Table of Contents

<b>1.</b>	<b>Attestation of Test Results .....</b>	<b>5</b>
<b>2.</b>	<b>Introduction .....</b>	<b>6</b>
<b>3.</b>	<b>Varying Transmission Test Cases and Test Proposal.....</b>	<b>6</b>
<b>4.</b>	<b>SAR Time Averaging Validation Test Procedures.....</b>	<b>7</b>
4.1.	Test Sequence Determination for Validation .....	7
4.2.	Test Configuration Selection Criteria for Validating Smart Transmit Feature.....	8
4.2.1.	Test Configuration Selection for Time-varying Transmission Power.....	8
4.2.2.	Test Configuration Selection for Change in Call.....	8
4.2.3.	Test Configuration Selection for Change in Technology/Band.....	8
4.2.4.	Test Configuration Selection for Change in Antenna.....	9
4.2.5.	Test Configuration Selection for Change in DSI .....	9
4.2.6.	Test Configuration Selection for Change in Time Window .....	9
4.2.7.	Test Configuration Selection for SAR Exposure Switching .....	9
4.3.	Test Procedures for Conducted Power Measurements.....	10
4.3.1.	Time-varying Transmission Power Scenario .....	10
4.3.2.	Change in Call Scenario .....	11
4.3.3.	Change in Technology and Band.....	12
4.3.4.	Change in Antenna .....	13
4.3.5.	Change in DSI.....	13
4.3.6.	Change in Time Window .....	13
4.3.7.	SAR Exposure Switching .....	14
4.4.	Test Procedure for Time-varying SAR Measurements .....	15
<b>5.</b>	<b>Test Configurations .....</b>	<b>16</b>
5.1.	WWAN (Sub-6 GHz) Transmission.....	16
<b>6.</b>	<b>Conducted Power Test Results for Sub-6 GHz Smart Transmit Feature Validation.....</b>	<b>18</b>
6.1.	Measurement Setup.....	18
6.2.	$P_{limit}$ and $P_{max}$ Measurement Results.....	20
6.3.	Time-varying Transmission Power Measurement Results .....	20
6.3.1.	GPRS PCS Antenna 3 (Test Case 1 in Table 5-2) .....	21
6.3.2.	W-CDMA Band 4 Antenna 1 (Test Case 2 in Table 5-2) .....	22
6.3.3.	LTE Band 66 Antenna 1 (Test Case 3 in Table 5-2).....	23
6.3.4.	Sub-6 GHz NR Band n77 Antenna 9 (Test Case 4 in Table 5-2) .....	24
6.4.	Change in Call Test Results (Test Case 5 in Table 5-2) .....	25
6.5.	Change in Technology/Band Test Results (Test Case 6 in Table 5-2) .....	26
6.6.	Change in DSI Test Results (Test Case 7 in Table 5-2) .....	27
6.7.	Change in Time Window/Antenna Switch Test Results (Test Case 8 in Table 5-2) .....	28
6.7.1.	Transition from LTE 66 to LTE 48 (i.e., 100 seconds to 60 seconds), then Back to LTE 66.....	28
6.8.	Switch in SAR Exposure Test Results (Test Case 9 in Table 5-2).....	29
<b>7.</b>	<b>SAR Test Results for Sub-6 GHz Smart Transmit Feature Validation .....</b>	<b>30</b>
<b>8.</b>	<b>Conclusions.....</b>	<b>30</b>
<b>Appendices.....</b>		<b>31</b>
A	Test Sequences .....	31
B	Test Procedures for Sub-6 GHz NR + Sub-6 GHz Radio.....	33
B.1	Time-varying Transmission Power Test for Sub-6 GHz NR in NSA Mode.....	33

B.2	Switch in SAR Exposure Between Sub-6 GHz vs. Sub-6 GHz NR during Transmission.....	33
C	Test Setup Photos .....	34

### Figures

Figure 4-1: 100 seconds running average illustration.....	11
Figure 6-1a – 6-1c: Conducted power measurement setup .....	19
Figure A-1: Test Sequence 1 waveform .....	31
Figure A-2: Test Sequence 2 waveform .....	32

### Tables

Table 5-1: $P_{limit}$ for supported technologies and bands ( $P_{limit}$ in EFS file) .....	17
Table 5-2: Radio configurations selected for Part 2.....	17
Table 6-1: Measured $P_{limit}$ and $P_{max}$ of selected radio configurations .....	20
Table A-1: Test Sequence 2 .....	32

### 1. Attestation of Test Results

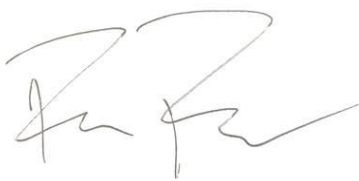
Applicant Name		APPLE INC.						
FCC ID		BCG-E8440A						
Model Name		A3105						
Reference SAR Report		14523772-S1						
Exposure Category		SAR Limits (W/Kg)						
		Peak spatial-average (1g of tissue)			Extremities (hands, wrists, ankles, etc.) (10g of tissue)			
General Population (Uncontrolled Exposure)		1.6			4			
RF Exposure Conditions		<a href="#">Equipment Class</a> - Highest Reported SAR (W/kg)						
		TNE	PCE	CBE	DTS	NII	DSS	DXX
Head		0.775	0.940	0.927	1.092	0.776	0.712	N/A
Body-worn (Dist.= 5 mm)		0.938	0.947	0.949	0.924	1.107	0.890	N/A
Hotspot (Dist.= 5 mm)		0.938	0.947	0.949	1.132	1.107	0.917	N/A
Extremities (Dist.= 0 mm)		N/A	N/A	N/A	N/A	N/A	N/A	0.006
Simultaneous TX	Head	1.231	1.393	1.383	1.393	1.393	1.375	N/A
	Body-worn	1.451	1.460	1.462	1.423	1.462	1.462	N/A
	Hotspot	1.451	1.460	1.462	1.423	1.462	1.462	N/A
Date Tested		6/21/2023 to 7/31/2023						
<p>UL Verification Services Inc. tested the above equipment in accordance with the requirements set forth in the above standards. The test results show that the equipment tested is capable of demonstrating compliance with the requirements as documented in this report.</p> <p>This report contains data provided by the customer which can impact the validity of results. UL Verification Services Inc. is only responsible for the validity of results after the integration of the data provided by the customer.</p> <p>The results documented in this report apply only to the tested sample, under the conditions and modes of operation as described herein. It is the manufacturer's responsibility to assure that additional production units of this model are manufactured with identical electrical and mechanical components. All samples tested were in good operating condition throughout the entire test program. Measurement Uncertainties are published for informational purposes only and were not taken into account unless noted otherwise.</p> <p>This document may not be altered or revised in any way unless done so by UL Verification Services Inc. and all revisions are duly noted in the revisions section. Any alteration of this document not carried out by UL Verification Services Inc. will constitute fraud and shall nullify the document. This report must not be used by the client to claim product certification, approval, or endorsement by A2LA, NIST, or any agency of the U.S. Government, or any agency of the U.S. government.</p>								
Approved & Released By:				Prepared By:				
								
Dave Weaver Operations Leader UL Verification Services Inc.				Remi Rodberg Senior Laboratory Engineer UL Verification Services Inc.				

## 2. Introduction

The equipment under test (EUT) contains the Qualcomm modem supporting 2G/3G/4G/5G technologies. The WWAN modem is enabled with Qualcomm's Smart Transmit feature with algorithms to control and manage transmitting power in real time and to ensure the time-averaged RF exposure from the WWAN modems are always in compliance with FCC requirements.

In addition to this WWAN modem, the EUT contains a different modem to support WLAN/BT/MSS (Qualcomm's time-averaging feature is not enabled on the WLAN/BT/MSS modem).

The purpose of this Part 2 report is to demonstrate that the EUT complies with the FCC RF exposure requirement under varying transmission scenarios, thereby validating the Qualcomm Smart Transmit feature.

The  $P_{limit}$  used in this report is determined and listed in the Part 0 report.

Refer to Compliance Summary report for product description and terminology used in this report.

## 3. Varying Transmission Test Cases and Test Proposal

To validate time averaging feature and demonstrate the compliance in varying transmission conditions, the following transmission scenarios are covered in Part 2 tests:

1. During a time-varying Tx power transmission: Prove that the Smart Transmit feature accounts for Tx power variations in time accurately.
2. During a call disconnect and re-establish scenario: Prove that the Smart Transmit feature accounts for history of past Tx power transmissions accurately.
3. During technology/band handover: Prove that the Smart Transmit feature functions correctly during transitions in technology/band.
4. During DSI (Device State Index) change: Prove that the Smart Transmit feature functions correctly during transition from one DSI to another.
5. During antenna (or beam) switch: Prove that the Smart Transmit feature functions correctly during transitions in antenna (such as AsDiv scenario).
6. During time window switch: Prove that the Smart Transmit feature correctly handles the transition from one time window to another specified by FCC while maintaining the normalized time-averaged RF exposure to be less than the normalized FCC limit of 1.0 W/kg at all times.
7. SAR exposure switching between two active radios (*radio1* and *radio2*): Prove that the Smart Transmit feature functions correctly and ensures total RF exposure compliance when exposure varies among  $SAR_{radio1}$  only,  $SAR_{radio1} + SAR_{radio2}$ , and  $SAR_{radio2}$  only scenarios.

As described in the Part 0 report, the RF exposure is proportional to the transmission power for a SAR-characterized wireless device. Thus, feature validation in Part 2 can be effectively performed through conducted (for  $f < 6\text{GHz}$ ) measurement. Therefore, the compliance demonstration under dynamic transmission conditions and feature validation are done in conducted/radiated power measurement setups for transmission scenarios 1 through 7.

To add confidence in the feature validation, the time-averaged SAR measurements are also performed but only performed for transmission scenario 1 to avoid the complexity in SAR (such as, for scenario 3, requiring change in SAR probe calibration file to accommodate different bands and/or tissue simulating liquid).

The strategy for testing in varying transmission conditions are outlined as follows:

- Demonstrate the total RF exposure averaged over FCC's defined time windows do not exceed FCC's SAR limit through time-averaged power measurements.
  - Measure conducted Tx power (for  $f < 6\text{GHz}$ ) versus time.
  - Convert the conducted Tx power into RF exposure and divide by the respective FCC limits to get the normalized exposure versus time.
  - Perform the running time-averaging over the FCC's defined time windows.
  - Demonstrate that the total normalized time-averaged RF exposure is less than 1 W/kg for all transmission scenarios (i.e., transmission scenarios 1 through 7), always.

Mathematical expression:

- For Sub-6 GHz transmission scenarios only:

$$1g \text{ or } 10g \text{ SAR}(t) = \frac{\text{conducted Tx power}(t)}{\text{conducted Tx power } P_{limit}} * 1g \text{ or } 10g \text{ SAR } P_{limit} \text{ (1a)}$$

$$\frac{\frac{1}{T_{SAR}} \int_{t-T_{SAR}}^t 1g \text{ or } 10g \text{ SAR}(t) dt}{FCC \text{ SAR limit}} \leq 1 \frac{W}{kg} \text{ (1b)}$$

where, *conducted Tx power(t)*, *conducted Tx power P<sub>limit</sub>*, and *1-g or 10-g SAR P<sub>limit</sub>* correspond to the measured instantaneous conducted Tx power, measured conducted Tx power at P<sub>limit</sub>, and measured 1-g SAR or 10-g SAR values at P<sub>limit</sub> corresponding to Sub-6 GHz transmission. P<sub>limit</sub> is the parameter pre-defined in Part 0 and loaded via *Embedded File System* (EFS) onto the EUT. T<sub>SAR</sub> is the FCC defined time window for Sub-6 GHz radio.

- Demonstrate the total RF exposure averaged over FCC's defined time windows do not exceed FCC's SAR limit through time-averaged SAR measurement. Note, as mentioned earlier, this measurement is performed for transmission scenario 1 only.
  - For Sub-6 GHz transmission only: Measure instantaneous SAR versus time; for LTE + Sub-6 GHz NR transmission: Request low power (or all-down bits) on LTE so that measured SAR predominantly corresponds to Sub-6 GHz NR.
  - Convert the result into RF exposure and divide by the respective FCC limits to obtain the normalized exposure versus time.
  - Perform time averaging over FCC defined time window.
  - Demonstrate that the total normalized time-average RF exposure is less than 1 W/kg for transmission scenario 1, always.

Mathematical expression:

- For Sub-6 GHz transmission only:

$$1g \text{ or } 10g \text{ SAR}(t) = \frac{\text{pointSAR}(t)}{\text{pointSAR } P_{limit}} * 1g \text{ or } 10g \text{ SAR}(t) P_{limit} \text{ (3a)}$$

$$\frac{\frac{1}{T_{SAR}} \int_{t-T_{SAR}}^t 1g \text{ or } 10g \text{ SAR}(t) dt}{FCC \text{ SAR limit}} \leq 1 \frac{W}{kg} \text{ (3b)}$$

where, *pointSAR(t)*, *pointSAR P<sub>limit</sub>*, and *1-g or 10-g SAR P<sub>limit</sub>* correspond to the measured instantaneous point SAR, measured point SAR at P<sub>limit</sub>, and measured 1-g SAR or 10-g SAR values at P<sub>limit</sub> corresponding to Sub-6 GHz transmission.<sup>1</sup>

## 4. SAR Time Averaging Validation Test Procedures

This chapter provides the test plan and test procedures for validating Qualcomm Smart Transmit feature for Sub-6 GHz transmission. The 100 seconds time window for operating  $f < 3$  GHz is used as an example to detail the test procedures in this chapter. The same test plan and test procedures described in this chapter apply to 60 seconds time window for operating  $f \geq 3$ GHz.

### 4.1. Test Sequence Determination for Validation

Following the FCC recommendation, two test sequences<sup>2</sup> having time-variation in Tx power are predefined for sub-6 GHz ( $f < 6$  GHz) validation:

<sup>1</sup> cDASY6/8 measurement system by Schmid & Partner Engineering AG (SPEAG) of Zurich, Switzerland measures relative E-field, and provides ratio of  $\frac{[\text{pointE}(t)]^2}{[\text{pointE input.power.limit}]^2}$  versus time.

<sup>2</sup> For test sequence generation, “measured P<sub>limit</sub>” and “measured P<sub>max</sub>” are used instead of the “P<sub>limit</sub>” specified in EFS entry and “P<sub>max</sub>” specified for the device, because Smart Transmit feature operates against the actual power level of the “P<sub>limit</sub>” that was calibrated for the EUT. The “measured P<sub>limit</sub>” accurately reflects what the feature is referencing

- Test sequence 1: Request EUT's Tx power to be at maximum power, measured  $P_{max}$ , for 80s, then requesting for half of the maximum power, i.e., measured  $P_{max}/2$ , for the rest of the time.
- Test sequence 2: Request EUT's Tx power to vary with time. This sequence is generated relative to measured  $P_{max}$ , measured  $P_{limit}$  and calculated  $P_{reserve}$  (= measured  $P_{limit}$  in dBm – Reserve power margin in dB) of the EUT based on measured  $P_{limit}$ .

The details for generating these two test sequences are described and listed in Appendix A.

## 4.2. Test Configuration Selection Criteria for Validating Smart Transmit Feature

For validating the Smart Transmit feature, this section provides a general guidance to select test cases. In practice, an adjustment can be made in test case selection. The justification/clarification may be provided.

### 4.2.1. Test Configuration Selection for Time-varying Transmission Power

The Smart Transmit time averaging feature operation is independent of bands, modes, and channels for a given technology. Hence, validation of Smart Transmit in one band/mode/channel per technology is sufficient. Two bands per technology are proposed and selected for this testing to provide high confidence in this validation.

The criteria for the selection are based on the  $P_{limit}$  values determined in the Part 0 report. Select two bands<sup>3</sup> in each supported technology that correspond to least<sup>4</sup> and highest<sup>5</sup>  $P_{limit}$  values that are less than  $P_{max}$  for validating Smart Transmit.

### 4.2.2. Test Configuration Selection for Change in Call

The criteria to select a test configuration for call-drop measurement is:

- Select the technology/band with the least  $P_{limit}$  among all supported technologies/bands and select the radio configuration (e.g., # of RBs, channel#) in this technology/band that corresponds to the highest measured 1-g SAR at  $P_{limit}$  listed in the Part 1 report.
- In case of multiple bands having the same least  $P_{limit}$ , select the band having the highest measured 1-g SAR at  $P_{limit}$  in the Part 0 report.

This test is performed with the EUT's Tx power requested to be at maximum power, the above band selection will result in Tx power enforcement (i.e., EUT forced to have Tx power at  $P_{reserve}$ ) for its longest duration in one FCC defined time window. The call change (call drop/reestablish) is performed during the Tx power enforcement duration (i.e., during the time when EUT is forced to have Tx power at  $P_{reserve}$ ). One test is sufficient as the feature operation is independent of technology and band.

### 4.2.3. Test Configuration Selection for Change in Technology/Band

The selection criteria for this measurement is, for a given antenna, to have the EUT switch from a technology/band with the lowest  $P_{limit}$  within the technology group (in case of multiple bands having the same  $P_{limit}$ , then select the band with highest measured 1-g SAR at  $P_{limit}$ ) to a technology/band with the highest  $P_{limit}$  within the technology group (in case of multiple bands having the same  $P_{limit}$ , then select the band with lowest measured 1-g SAR at  $P_{limit}$  in the Part 0 report, or vice versa).

---

to, therefore, it should be used during feature validation testing. The RF tune-up and device-to-device variation are already considered in the Part 0 report prior to determining  $P_{limit}$ .

<sup>3</sup> If one  $P_{limit}$  level applies to all the bands within a technology, then only one band needs to be tested. In this case, within the bands having the same  $P_{limit}$ , the radio configuration (e.g., # of RBs, channel#) and device position that correspond to the highest measured 1-g SAR at  $P_{limit}$  shown in the Part 1 report is selected.

<sup>4</sup> In case of multiple bands having the same least  $P_{limit}$  within the technology, then select the band having the highest measured 1-g SAR at  $P_{limit}$ .

<sup>5</sup> The band having a higher  $P_{limit}$  needs to be properly selected so that the power limiting enforced by Smart Transmit can be validated using the pre-defined test sequences. If the highest  $P_{limit}$  in a technology is too high where the power limiting enforcement is not needed when testing with the pre-defined test sequences, then the next highest level is checked. This process is continued within the technology until the second band for validation testing is determined.



This test is performed with the EUT's Tx power requested to be at maximum power, the technology/band switch is performed during Tx power enforcement duration (i.e., during the time when EUT is forced to have Tx power at  $P_{reserve}$ ).

#### 4.2.4. Test Configuration Selection for Change in Antenna

The criteria to select a test configuration for antenna switch measurement is:

- Whenever possible, and supported by the EUT, first select an antenna switch configuration within the same technology/band (i.e., same technology and band combination).
- Select any technology/band that supports multiple Tx antennas and has the highest difference in  $P_{limit}$  among all supported antennas.
- In case of multiple bands having the same difference in  $P_{limit}$  among supported antennas, select the band having the highest *measured* 1-g SAR at  $P_{limit}$  in the Part 1 report.

This test is performed with the EUT's Tx power requested to be at maximum power in a selected technology/band and antenna change is conducted during Tx power enforcement duration (i.e., during the time when EUT is forced to have Tx power at  $P_{reserve}$ ).

#### 4.2.5. Test Configuration Selection for Change in DSI

The criteria to select a test configuration for DSI change is:

- Select a technology/band having the  $P_{limit} < P_{max}$  within any technology and DSI group and for the same technology/band having a different  $P_{limit}$  in any other DSI group. Note that the selected DSI transition needs to be supported by the device.

This test is performed with the EUT's Tx power requested to be at maximum power in selected technology/band, and DSI change is conducted during Tx power enforcement duration (i.e., during the time when EUT is forced to have Tx power at  $P_{reserve}$ ).

#### 4.2.6. Test Configuration Selection for Change in Time Window

The FCC specifies different time windows for time averaging based on operation frequency. The criteria to select a test configuration for validating the Smart Transmit feature and demonstrating the compliance during the change in time window is:

- Select any technology/band that has an operation frequency classified in one time window defined by the FCC (such as 100-seconds time window) and its corresponding  $P_{limit}$  is less than  $P_{max}$  if possible.
- Select the second technology/band that has an operation frequency classified in a different time window defined by the FCC (such as 60-seconds time window) and its corresponding  $P_{limit}$  is less than  $P_{max}$  if possible.
- Note it is preferred both  $P_{limit}$  values of two selected technologies/bands are less than the corresponding  $P_{max}$ ; if this is not possible, at least one of technologies/bands has its  $P_{limit}$  less than  $P_{max}$ .

This test is performed with the EUT's Tx power requested to be at maximum power in selected technology/band. Test for one pair of time windows selected is sufficient as the feature operation is the same.

#### 4.2.7. Test Configuration Selection for SAR Exposure Switching

If supported, the test configuration for SAR exposure switching should cover:

1. SAR exposure switch when two active radios are in the same time window.
2. SAR exposure switch when two active radios are in different time windows. One test with two active radios in any two different time windows is sufficient as the Smart Transmit operation is the same for RF exposure switch in any combination of two different time windows.

The Smart Transmit time averaging operation is independent of the source of SAR exposure (for example, LTE vs. Sub-6 GHz NR) and ensures total time-averaged RF exposure compliance. Hence, validation of Smart Transmit in any one simultaneous SAR transmission scenario (i.e., one combination for LTE + Sub-6 GHz NR transmission) is sufficient, where the SAR exposure varies among  $SAR_{radio1}$  only,  $SAR_{radio1} + SAR_{radio2}$ , and  $SAR_{radio2}$  only scenarios.

The criteria to select a test configuration for validating the Smart Transmit feature during SAR exposure switching scenario is:

- Select any two < 6 GHz technologies/bands that the EUT supports simultaneous transmission (for example, LTE + Sub-6 GHz NR).
- Among all supported simultaneous transmission configurations, the selection order is:
  1. Select one configuration where both  $P_{limit}$  of radio1 and radio2 is less than their corresponding  $P_{max}$ , preferable with different  $P_{limits}$ . If this configuration is not available, then
  2. Select one configuration that has  $P_{limit}$  less than its  $P_{max}$  for at least one radio. If this cannot be found, then
  3. Select one configuration that has  $P_{limit}$  of radio1 and radio2 greater than  $P_{max}$ , but with the least delta between the two ( $P_{limit} - P_{max}$ ).

Test for one simultaneous transmission scenario is sufficient as the feature operation is the same.

### 4.3. Test Procedures for Conducted Power Measurements

This section provides general conducted power measurement procedures to perform compliance test under dynamic transmission scenarios described in §3. In practice, an adjustment can be made in these procedures. The justification/clarification may be provided.

#### 4.3.1. Time-varying Transmission Power Scenario

This test is performed with the two pre-defined test sequences described in §4.1 for all the technologies and bands selected in §4.2.1. The purpose of the test is to demonstrate the effectiveness of power limiting enforcement and that the time-averaged SAR (corresponding time-averaged Tx power) does not exceed the FCC limit at all times (see Eq. (1a) and (1b)).

##### Test Procedure:

1. Measure  $P_{max}$ , measure  $P_{limit}$ , and calculate  $P_{reserve}$  (= measured  $P_{limit}$  in dBm – *Reserve\_power\_margin* in dB) and follow §4.1 to generate the test sequences for all the technologies and bands selected in §4.2.1. Both test sequence 1 and test sequence 2 are created based on measured  $P_{max}$  and measured  $P_{limit}$  of the EUT. Test conditions to measure  $P_{max}$  and  $P_{limit}$  are:
  - a. Measure  $P_{max}$  with Smart Transmit **disabled** and the callbox set to request maximum power.
  - b. Measure  $P_{limit}$  with Smart Transmit **enabled**, *Reserve\_power\_margin* set to 0 dB, and the callbox set to request maximum power.
2. Set *Reserve\_power\_margin* to actual (intended) value and reset power on EUT to enable Smart Transmit, establish a radio link in the desired radio configuration, with callbox requesting the EUT's Tx power to be at a pre-defined test sequence 1, measure and record Tx power versus time and then convert the conducted Tx power into 1-g SAR or 10-g SAR value (see Eq. (1a)<sup>6</sup>) using measured  $P_{limit}$  from Step 1. Perform a running time average<sup>7</sup> to determine time-averaged power and 1-g SAR or 10-g SAR versus time, as illustrated in Figure 4-1, where using 100-seconds time window as an example.

<sup>6</sup> In Eq.(1a), instantaneous Tx power is converted into instantaneous 1-g SAR or 10-g SAR value by applying the measured worst-case 1-g SAR or 10-g SAR value at  $P_{limit}$  for the corresponding technology/band/antenna/DSI reported in the Part 1 report.

<sup>7</sup> For an easier computation of the running time average, 0 dBm can be added at the beginning of the test sequences. The length of the responding time window, for example, add 0dBm for 100-seconds so the running time average can be directly performed starting with the first 100-seconds data using excel spreadsheet. This technique applies to all tests performed in this Part 2 report for easier time-averaged computation using excel spreadsheet.

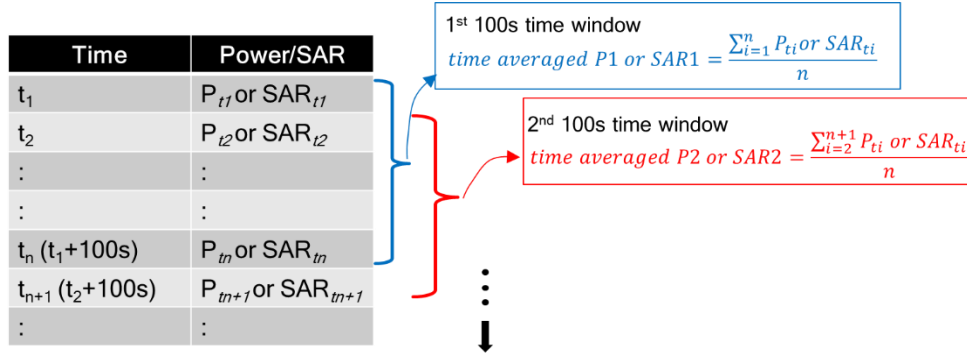

Figure 4-1: 100 seconds running average illustration

3. Make one plot containing:
  - a. Instantaneous Tx power versus time measured in Step 2.
  - b. Requested Tx power used in Step 2 (test sequence 1).
  - c. Computed time-average power versus time determined in Step 2.
  - d. Time-averaged power limit (corresponding to FCC SAR limit of 1.6 W/kg for 1-g SAR or 4.0 W/kg for 10-g SAR) given by:

$$Time\ averaged\ power\ limit = meas.P_{limit} + 10 * \log\left(\frac{FCC\ SAR\ limit}{meas.SAR\ P_{limit}}\right) \quad (5a)$$

where  $meas.P_{limit}$  and  $meas.SAR\ P_{limit}$  corresponds to measured power at  $P_{limit}$  and measured SAR at  $P_{limit}$ .

4. Make another plot containing:
  - a. Computed time-averaged 1-g SAR or 10-g SAR versus time determined in Step 2.
  - b. FCC 1-g  $SAR_{limit}$  of 1.6 W/kg or FCC 10-g  $SAR_{limit}$  of 4.0 W/kg.
5. Repeat Steps 2 through 4 for pre-defined test sequence 2 and replace the requested Tx power (test sequence 1) in Step 2 with test sequence 2.
6. Repeat Steps 2 through 5 for all the selected technologies and bands.

The validation criteria are, at all times, the time-averaged power versus time, shown in Step 3’s plot, where the result shall not exceed the time-averaged power limit (defined in Eq. (5a)); in turn, the time-averaged 1-g SAR or 10-g SAR versus time, shown in Step 4’s plot, shall not exceed the FCC limit of 1.6 W/kg for 1-g SAR or 4.0 W/kg for 10-g SAR (i.e., Eq. (1b)).

### 4.3.2. Change in Call Scenario

This test is to demonstrate that the Smart Transmit feature accurately accounts for the past transmission powers during time-averaging when a new call is established.

The call disconnection and re-establishment need to be performed during power limit enforcement, i.e., when the EUT’s transmission power is at  $P_{reserve}$  level, to demonstrate the continuity of RF exposure management and limiting in call change scenario. In other words, the RF exposure averaged over any FCC defined time window (including the time windows containing the call change) does not exceed the FCC limit of 1.6 W/kg for 1-g SAR or 4.0 W/kg for 10-g SAR.

#### Test Procedure

1. Measure  $P_{limit}$  for the technology/band selected in §4.2.2. Measure  $P_{limit}$  with Smart Transmit enabled and *Reserve\_power\_margin* set to 0 dB, and the callbox set to request maximum power.
2. Set *Reserve\_power\_margin* to actual (intended) value and reset power on EUT to enable Smart Transmit.
3. Establish radio link with callbox in the selected technology/band.
4. Request EUT’s transmission power at 0 dBm for at least one-time window specified for the selected technology/band, followed by requesting EUT’s transmission power to be at maximum power for about ~60 seconds, and then drop the call for ~10 seconds. Afterwards, re-establish another call in the same radio configuration (i.e., same technology/band/channel) and continue callbox requesting EUT’s transmission power to be at maximum power for the remaining time of at least another full duration of the specified time window. Measure and record the transmission power versus time. Once the measurement is done, extract

instantaneous transmission power versus time, convert the measured conducted transmission power into 1-g SAR or 10-g SAR values using Eq. (1a), and then perform the running time average to determine time-averaged power and 1-g SAR or 10-g SAR versus time.<sup>8</sup>

5. Make one plot containing: (a) Instantaneous Tx power versus time, (b) requested power, (c) computed time-averaged power, (d) time-averaged power limit calculated using Eq.(5a).
6. Make another plot containing: (a) Computed time-averaged 1-g SAR or 10-g SAR versus time, and (b) FCC limit of 1.6 W/kg for 1-g SAR or 4.0 W/kg for 10-g SAR.

The time-averaged power versus time shall not exceed the time-averaged power limit (defined in Eq.(5a)) and, in turn, the time-averaged 1-g SAR or 10-g SAR versus time shall not exceed the FCC limit of 1.6 W/kg for 1-g SAR or 4.0 W/kg for 10-g SAR (i.e., Eq. (1b)).

### 4.3.3. Change in Technology and Band

This test is to demonstrate the correct power control by Smart Transmit during technology switches and/or band handovers.

Like the *Change in Call Scenario* test in §4.3.2, to validate the continuity of RF exposure limiting during the transition, the technology and band handover needs to be performed when EUT's transmission power is at  $P_{reserve}$  level (i.e., during transmission power enforcement) to make sure that the EUT's transmission power from previous  $P_{reserve}$  level to the new  $P_{reserve}$  level (corresponding to new technology/band). Since the  $P_{limit}$  could vary with technology and band, Eq. (1a) can be written as follows to convert the instantaneous transmission power in 1-g SAR or 10-g SAR exposure for the two given radios, respectively:

$$1g \text{ or } 10g \text{ SAR}_1(t) = \frac{\text{conducted}_{Tx \text{ power } 1(t)}}{\text{conducted}_{Tx \text{ power } P_{limit 1}}} * 1g \text{ or } 10g \text{ SAR } P_{limit 1} \quad (7a)$$

$$1g \text{ or } 10g \text{ SAR}_2(t) = \frac{\text{conducted}_{Tx \text{ power } 2(t)}}{\text{conducted}_{Tx \text{ power } P_{limit 2}}} * 1g \text{ or } 10g \text{ SAR } P_{limit 2} \quad (7b)$$

$$\frac{1}{T_{SAR}} \left[ \int_{t-T_{SAR}}^{t_1} \frac{1g \text{ or } 10g \text{ SAR}_1(t)}{FCC \text{ SAR limit}} dt + \int_{t-T_{SAR}}^t \frac{1g \text{ or } 10g \text{ SAR}_2(t)}{FCC \text{ SAR limit}} dt \right] \leq 1 \quad (7c)$$

where,  $\text{conducted}_{Tx \text{ power } 1(t)}$ ,  $\text{conducted}_{Tx \text{ power } P_{limit 1}}$ , and  $1g \text{ or } 10g \text{ SAR } P_{limit 1}$  correspond to the measured instantaneous conducted transmission power, measured conducted transmission power at  $P_{limit}$ , and measured 1-g SAR or 10-g SAR value at  $P_{limit}$  of technology1/band1;  $\text{conducted}_{Tx \text{ power } 2(t)}$ ,  $\text{conducted}_{Tx \text{ power } P_{limit 2}}$ , and  $1g \text{ or } 10g \text{ SAR } P_{limit 2}$  correspond to the measured instantaneous conducted transmission power, measured conducted transmission power at  $P_{limit}$ , and measured 1-g SAR or 10-g SAR value at  $P_{limit}$  of technology2/band2. Transition from technology1/band1 to the technology2/band2 happens at time-instant 't1'.

### Test Procedure

1. Measure  $P_{limit}$  for both the technologies and bands selected in §4.2.3. Measure the  $P_{limit}$  with Smart Transmit *enabled* and set *Reserve\_power\_margin* to 0 dB, and the callbox set to request maximum power.
2. Set *Reserve\_power\_margin* to actual (intended) value and reset power on the EUT to enable Smart Transmit.
3. Establish a radio link with the callbox in the first technology/band selected.
4. Request the EUT's transmission power to be 0 dBm for at least one-time window specified for the selected technology/band, followed by requesting the EUT's transmission power to be at maximum power for about ~60 seconds, and then switch to the second technology/band selected. Continue with the callbox requesting the EUT's transmission power to be at maximum power for the remaining time or, at least, for another full duration of the specified time window. Measure and record the transmission power versus time for the full duration of the test.
5. Once the measurement is done, extract the instantaneous transmission power versus time and convert the conducted transmission power into a 1-g SAR or 10-g SAR value using Eq. (7a) and (7b) and corresponding

<sup>8</sup> In Eq.(1a), the instantaneous transmission power is converted into instantaneous 1-g SAR or 10-g SAR value by applying the measured worst-case 1-g SAR or 10-g SAR value at  $P_{limit}$  for the corresponding technology/band/antenna/DSI reported in the Part 1 report.

measured  $P_{limit}$  values from Step 1 of this section. Perform the running time average to determine time-averaged power and 1-g SAR or 10-g SAR versus time.<sup>9</sup>

6. Make one plot containing: (a) Instantaneous transmission power versus time, (b) requested power, (c) computed time-averaged power, (d) time-averaged power limit calculated using Eq.(5a).
7. Make another plot containing: (a) Computed time-averaged 1-g SAR or 10-g SAR versus time, and (b) FCC limit of 1.6 W/kg for 1-g SAR or 4.0 W/kg for 10-g SAR.

The time-averaged 1-g SAR or 10-g SAR versus time shall not exceed the FCC limit of 1.6 W/kg for 1-g SAR or 4.0 W/kg for 10-g SAR (i.e., Eq. (7c)).

#### 4.3.4. Change in Antenna

This test is to demonstrate the correct power control by Smart Transmit during an antenna switch, i.e., switching from one antenna to another. The test procedure is identical to §4.3.3, by replacing technology/band switch operation with an antenna switch. The time-averaged 1-g SAR or 10-g SAR versus time shall not exceed FCC limit of 1.6 W/kg for 1-g SAR or 4.0 W/kg for 10-g SAR.<sup>10</sup>

#### 4.3.5. Change in DSI

This test is to demonstrate the correct power control by Smart Transmit during a DSI switch, i.e., switching from one DSI state to another. The test procedure is identical to §4.3.3, by replacing technology/band switch operation with a DSI switch. The time-averaged 1-g SAR or 10-g SAR versus time shall not exceed FCC limit of 1.6 W/kg for 1-g SAR or 4.0 W/kg for 10-g SAR.

#### 4.3.6. Change in Time Window

This test is to demonstrate the correct power control by Smart Transmit during the change in averaging time window when a specific band handover occurs. The FCC specifies time-averaging windows of 100 seconds for transmission frequencies < 3 GHz, and 60 seconds for transmission frequencies between 3 GHz and 6 GHz.

To validate the continuity of RF exposure limiting during the transition, the band handover test needs to be performed when the EUT handovers from one operating band less than 3 GHz to greater than 3 GHz, and vice versa. The equations (3a) and (3b) in §3 can be written as follows for transmission scenarios having a change in time windows:

$$1g\ SAR_1(t) = \frac{\text{conducted}_{Tx\ power\ 1(t)}}{\text{conducted}_{Tx\ power\ P_{limit\ 1}}} * 1g\ or\ 10g\ SAR\ P_{limit\ 1} \quad (7a)$$

$$1g\ SAR_2(t) = \frac{\text{conducted}_{Tx\ power\ 2(t)}}{\text{conducted}_{Tx\ power\ P_{limit\ 2}}} * 1g\ or\ 10g\ SAR\ P_{limit\ 2} \quad (7b)$$

$$\frac{1}{T_{1SAR}} \left[ \int_{t-T_{1SAR}}^{t_1} \frac{1g\ or\ 10g\ SAR_1(t)}{FCC\ SAR\ limit} dt \right] + \frac{1}{T_{2SAR}} \left[ \int_{t-T_{2SAR}}^t \frac{1g\ or\ 10g\ SAR_2(t)}{FCC\ SAR\ limit} dt \right] \leq 1 \quad (7c)$$

where,  $\text{conducted}_{Tx\ power\ 1(t)}$ ,  $\text{conducted}_{Tx\ power\ P_{limit\ 1}(t)}$ , and  $1-g\ or\ 10-g\ SAR\ P_{limit\ 1}$  correspond to the instantaneous transmission power, conducted transmission power at  $P_{limit}$ , and compliance  $1-g\ or\ 10-g\ SAR\ values\ at\ P_{limit\ 1}$  of band1 with the time-averaging window ' $T_{1SAR}$ ';  $\text{conducted}_{Tx\ power\ 2(t)}$ ,  $\text{conducted}_{Tx\ power\ P_{limit\ 2}(t)}$ , and  $1-g\ or\ 10-g\ SAR\ P_{limit\ 2}$  correspond to the instantaneous transmission power, conducted transmission power at  $P_{limit}$ , and compliance  $1-g\ or\ 10-g\ SAR\ values\ at\ P_{limit\ 2}$  of band2 with the time-averaging window ' $T_{2SAR}$ '. One of the two bands is less than 3 GHz, another is greater than 3 GHz. Transition from first band with time-averaging window ' $T_{1SAR}$ ' to the second band with time-averaging window ' $T_{2SAR}$ ' happens at time-instant ' $t_1$ '.

<sup>9</sup> In Eq.(7a) and (7b), instantaneous transmission power is converted into instantaneous 1-g SAR or 10-g SAR value by applying the measured worst-case 1-g SAR or 10-g SAR value at  $P_{limit}$  for the corresponding technology/band/antenna/DSI reported in the Part 1 report.

<sup>10</sup> If the EUT does not support antenna switching within the same technology/band, but has multiple antennas that support different frequency bands, then the antenna switch test is included as part of change in technology and band test (§4.3.3).

## Test Procedure

1. Measure  $P_{limit}$  for both the technologies and bands selected in §4.2.6. Measure  $P_{limit}$  with Smart Transmit enabled and set Reserve\_power\_margin to 0 dB, and the callbox set to request maximum power.
2. Set Reserve\_power\_margin to actual (intended) value and enable Smart Transmit.

### Transition from 100 seconds time window to 60 seconds time window, and vice versa

3. Establish radio link with the callbox in the technology/band having 100 seconds time window selected in §4.2.6.
4. Request the EUT's transmission power to be at 0 dBm for at least 100 seconds, followed by requesting the EUT's transmission power to be at maximum power for about ~140 seconds, and then switch to the second technology/band (having 60 seconds time window) selected in §4.2.6. Continue with the callbox requesting the EUT's transmission power to be at maximum power for about ~60 seconds in this second technology/band, and then switch back to the first technology/band. Continue with the callbox requesting the EUT's transmission power to be at maximum power for at least another 100 seconds. Measure and record the transmission power versus time for the entire duration of the test.
5. Once the measurement is done, extract the instantaneous transmission power versus time and convert the conducted transmission power into 1-g SAR or 10-g SAR value (see Eq. (7a) and (7b)) using the corresponding technology/band in Step 1's result, then perform 100 seconds running average to determine time-averaged 1-g SAR or 10-g SAR versus time.<sup>11</sup>
6. Make one plot containing: (a) Instantaneous transmission power versus time measured in Step 4.
7. Make another plot containing: (a) Instantaneous 1-g SAR versus time determined in Step 5, (b) computed time-averaged 1-g SAR versus time determined in Step 5, and (c) corresponding regulatory 1-g SAR<sub>limit</sub> of 1.6W/kg or 10-g SAR<sub>limit</sub> of 4.0W/kg.

### Transition from 60 seconds time window to 100 seconds time window, and vice versa

8. Establish radio link with the callbox in the technology/band having a 60 second time window selected in §4.2.6.
9. Request the EUT's transmission power to be at 0 dBm for at least 60 seconds, followed by requesting the EUT's transmission power to be at maximum power for about ~80 seconds, and then switch to the second technology/band (having 100 seconds time window) selected in §4.2.6. Continue with the callbox requesting the EUT's transmission power to be at maximum power for about ~100 seconds in this second technology/band, and then switch back to the first technology/band. Continue with the callbox requesting the EUT's transmission power to be at maximum power for the remaining time for a total test time of 500 seconds. Measure and record the transmission power versus time for the entire duration of the test.
10. Repeat Step 5~7 to generate the plots.

The time-averaged 1-g SAR or 10-g SAR versus time shall not exceed the regulatory 1-g SAR<sub>limit</sub> of 1.6W/kg or 10-g SAR<sub>limit</sub> of 4.0W/kg.

## 4.3.7. SAR Exposure Switching

This test is to demonstrate that the Smart Transmit feature is accurately accounting for switching in exposures among SAR from radio1 only, SAR from both radio1 and radio2, and SAR from radio2 only scenarios, and ensures total time-averaged RF exposure complies with the FCC limit. Here, radio1 represents the primary radio (for example, LTE anchor in a NR non-standalone mode call) and radio2 represents secondary radio (for example, Sub-6 GHz NR). The detailed test procedure for SAR exposure switching in the case of LTE+Sub-6 GHz NR non-standalone mode transmission scenario is provided in Appendix B.2.

## Test Procedure

1. Measure the conducted transmission power corresponding to  $P_{limit}$  for radio1 and radio2 in the selected band. The test conditions to measure conducted  $P_{limit}$  are:

<sup>11</sup> In Eq.(7a) & (7b), instantaneous transmission power is converted into instantaneous 1-g SAR or 10-g SAR value by applying the worst-case 1-g SAR or 10-g SAR value tested in Part 1 for the selected technologies/bands at  $P_{limit}$ .

- a. Establish a device in call with the callbox for radio1 technology/band. Measure the conducted transmission power corresponding to radio1  $P_{limit}$  with Smart Transmit enabled, set *Reserve\_power\_margin* to 0 dB, and set the callbox to request maximum power.
- b. Repeat Step 1a to measure the conducted transmission power corresponding to radio2  $P_{limit}$ . If radio2 is dependent on radio1 (for example, non-standalone mode of Sub-6 GHz NR requiring radio1 LTE as an anchor), then establish radio1 + radio2 call with the callbox and request all down bits for radio1 LTE. In this scenario, set the callbox to request maximum power from radio2 Sub-6 GHz NR, then measure the conducted transmission power that corresponds to radio2's  $P_{limit}$  (as radio1 LTE is at all-down bits).
2. Set *Reserve\_power\_margin* to actual (intended) value, with the EUT setup for radio1 + radio2 call. In this description, it is assumed that radio2 has lower priority than radio1. Establish the device in radio1+radio2 call and request all-down bits or low power on radio1, with the callbox requesting the EUT's transmission power to be at maximum power in radio2 for at least one-time window. After one time window, set the callbox to request the EUT's transmission power to be at maximum power on radio1, i.e., all-up bits. Continue radio1 + radio2 call with both radios at maximum power for at least one-time window and drop (or request all-down bits on) radio2. Continue radio1 at maximum power for at least one-time window. Record the conducted transmission power for both radio1 and radio2 for the entire duration of this test.
3. Once the measurement is done, extract instantaneous transmission power versus time for both radio1 and radio2 links. Convert the conducted transmission power for both these radios into 1-g SAR or 10-g SAR value (see Eq. (7a) and (7b)) using the corresponding technology/band  $P_{limit}$  measured in Step 1, and then perform the running time average to determine time-averaged 1-g SAR or 10-g SAR versus time.
4. Make one plot containing: (a) Instantaneous transmission power versus time measured in Step 2.
5. Make another plot containing: (a) Instantaneous 1-g SAR versus time determined in Step 3, (b) computed time-averaged 1-g SAR versus time determined in Step 3, and (c) corresponding regulatory 1-g SAR<sub>limit</sub> of 1.6W/kg or 10-g SAR<sub>limit</sub> of 4.0W/kg.

The time-averaged 1-g SAR or 10-g SAR versus time shall not exceed the regulatory 1-g SAR<sub>limit</sub> of 1.6W/kg or 10-g SAR<sub>limit</sub> of 4.0W/kg.

#### 4.4. Test Procedure for Time-varying SAR Measurements

This section provides general time-varying SAR measurement procedures to perform compliance test under dynamic transmission scenarios described in §3. In practice, an adjustment can be made in these procedures. The justification/clarification may be provided.

To perform the validation through SAR measurement for transmission scenario 1 described in §3, the “path loss” between callbox, antenna, and EUT need to be calibrated to ensure that the EUT's transmission power reacts to the requested power from the callbox in a radiated call. It should be noted that when signaling in closed loop mode, protocol-level power control is in play, resulting in the EUT not solely following the callbox's TPC (transmit power control) commands. In other words, the EUT response has many dependencies (RSSI, quality of signal, path loss variation, fading, etc.) other than just TPC commands. These dependencies have less impact in conducted setup (as it is a controlled environment and the path loss can be very well calibrated) but have significant impact on radiated testing in an uncontrolled environment, such as a SAR test setup. Therefore, the deviation in EUT transmit power from the callbox's requested power is expected, however the time-averaged SAR should not exceed the FCC SAR requirements as Smart Transmit controls the transmission power at the EUT.

The following steps are for time averaging feature validation through SAR measurement:

1. “Path Loss” calibration: Place the EUT against the phantom in the worst-case position determined based on §4.2.1. For each band selected, prior to SAR measurement, perform the “path loss” calibration between callbox, antenna, and EUT. Since the SAR test environment is not controlled and well calibrated for OTA (Over the Air) test, extreme care needs to be taken to avoid the influence of reflections. The test setup is described in §7.
2. Time averaging feature validation:
  - a. For a given radio configuration (technology/band) selected in §4.2.1, enable Smart Transmit and set *Reserve\_power\_margin* to 0 dB, with the callbox set to request maximum power. Perform an area scan, conduct a *pointSAR* (single point) measurement at the peak location of the area scan. This *pointSAR* value, *pointSAR*  $P_{limit}$ , corresponds to *pointSAR* at the measured  $P_{limit}$  (i.e., measured  $P_{limit}$  from the EUT in Step 1 of §4.3.1).

- b. Set *Reserve\_power\_margin* to actual (intended) value and reset power on the EUT to enable Smart Transmit.<sup>12</sup> Establish radio link in desired radio configuration, with the callbox requesting the EUT's transmission power at power levels described by test sequence 1 generated in Step 1 of §4.3.1, conduct *pointSAR* measurement versus time at peak location of the area scan determined in Step 2a of this section. Once the measurement is done, extract the instantaneous *pointSAR* versus time data, *pointSAR(t)*, and convert it into instantaneous 1-g SAR or 10-g SAR versus time using Eq. (3a), re-written below:

$$1g \text{ or } 10gSAR(t) = \frac{pointSAR(t)}{pointSAR P_{limit}} * 1g \text{ or } 10gSAR P_{limit} \text{ (3a)}$$

where, *pointSAR P<sub>limit</sub>* is the value determined in Step 2a, and *pointSAR(t)* is the instantaneous *pointSAR* measured in Step 2b, *1-g or 10-g SAR P<sub>limit</sub>* is the measured 1-g SAR or 10-g SAR value listed in the Part 0 report.

- c. Perform 100 seconds running average to determine time-averaged 1-g SAR or 10-g SAR versus time.  
 d. Make one plot containing: (a) Time-averaged 1-g SAR or 10-g SAR versus time determined in Step 2c of this section, (b) FCC limit of 1.6 W/kg for 1-g SAR or 4.0 W/kg for 10-g SAR.  
 e. Repeat 2b ~ 2d for test sequence 2 generated in Step 1 of §4.3.1.  
 f. Repeat 2a ~ 2e for all the technologies and bands selected in §4.2.1.

The time-averaged 1-g SAR or 10-g SAR versus time shall not exceed FCC limit of 1.6 W/kg for 1-g SAR or 4.0 W/kg for 10-g SAR (i.e., Eq. (3b)).

## 5. Test Configurations

### 5.1. WWAN (Sub-6 GHz) Transmission

The *P<sub>limit</sub>* values for technologies and bands supported by the EUT are derived in the Part 0 report and summarized in Table 5-1.<sup>13, 14</sup>

Based on the selection criteria described in §4.2.1, the selected technologies/bands for testing time-varying test sequences are shaded in Table 5-1. The *Reserve\_power\_margin* (dB) for the EUT is set in EFS and is used in the Part 2 test.

The radio configurations used in the Part 2 test for selected technologies/bands/DSI states/antennas are listed in Table 5-2. The corresponding worst-case radio configuration 1-g SAR or 10-g SAR values for selected technology/band/DSI are extracted from the Part 0 report and are listed in the last column of Table 5-2.

Based on equations (1a), (2a), (3a) and (4a), Part 2 testing outcome is the normalized quantity, which implies that it can be applied to any radio configuration within a selected technology/band/DSI. Thus, applying the worst-case SAR obtained from the worst radio configuration in Part 1 testing to calculate time-varying SAR exposure in equations (1a), (2a), (3a) and (4a), the accuracy in compliance demonstration remains the same.

<sup>12</sup> If *Reserve\_power\_margin* cannot be set wirelessly, care must be taken to re-position the EUT in the exact same position relative to the SAM phantom as in Step 2a.

<sup>13</sup> All *P<sub>limit</sub>* power levels entered in Table 6-1 correspond to average power levels after accounting for duty cycle in the case of TDD modulation schemes, e.g., GSM, LTE TDD & Sub-6 GHz NR TDD.

<sup>14</sup> Maximum tune up target power, *P<sub>max</sub>*, is configured in the NV settings within the EUT to limit maximum transmitting power. This power is converted into peak power in the NV settings for TDD schemes. The EUT's maximum allowed output power is equal to *P<sub>max</sub>* + device uncertainty (dB).



**Table 5-1:  $P_{limit}$  for supported technologies and bands ( $P_{limit}$  in EFS file)**

Tech/Band	Antenna			Worst-case SAR (W/kg)			$P_{limit}$ (dBm) + Uncertainty (dBm)		
	Head	Body & Hotspot	Hotspot	Head	Body & Hotspot	Hotspot	Head	Body & Hotspot	Hotspot
	DSI: 0	DSI: 1	DSI: 1	DSI: 0	DSI: 1	DSI: 1	DSI: 0	DSI: 1	DSI: 1
GSM 850 2 slots	ANT 2	ANT 1	ANT 1	0.759	0.870	0.870	29.50	32.50	32.50
GSM 1900 2 slots	ANT 4	ANT 1	ANT 1	0.733	0.885	0.885	25.20	28.00	28.00
W-CDMA B2	ANT 4	ANT 4	ANT 4	0.880	0.941	0.941	19.20	20.20	20.20
W-CDMA B4	ANT 4	ANT 3	ANT 3	0.925	0.929	0.929	20.50	20.70	20.70
W-CDMA B5	ANT 2	ANT 1	ANT 1	0.794	0.608	0.608	23.50	25.70	25.70
LTE Band 5	ANT 2	ANT 3	ANT 3	0.850	0.721	0.721	23.50	25.40	25.40
LTE Band 7	ANT 4	ANT 2	ANT 2	0.904	0.947	0.947	19.20	19.00	19.00
LTE Band 12/17	ANT 2	ANT 2	ANT 1	0.646	0.534	0.750	24.20	24.70	25.70
LTE Band 13	ANT 2	ANT 2	ANT 2	0.846	0.835	0.835	23.70	24.70	24.70
LTE Band 14	ANT 2	ANT 2	ANT 2	0.844	0.861	0.861	23.70	24.70	24.70
LTE Band 25/2	ANT 4	ANT 4	ANT 4	0.940	0.947	0.947	19.20	20.20	20.20
LTE Band 26	ANT 2	ANT 1	ANT 1	0.885	0.571	0.571	23.50	25.70	25.70
LTE Band 30	ANT 4	ANT 3	ANT 3	0.933	0.922	0.922	21.50	20.20	20.20
LTE Band 41	ANT 4	ANT 2	ANT 2	0.900	0.947	0.947	21.50	20.50	20.50
LTE Band 41 (PC2)	N/A	N/A	N/A	N/A	N/A	N/A	N/A	N/A	N/A
LTE Band 48	ANT 8	ANT 8	ANT 8	0.768	0.746	0.866	22.80	22.50	22.50
LTE Band 53	ANT 2	ANT 2	ANT 2	0.773	0.938	0.938	18.50	20.50	20.50
LTE Band 66/4	ANT 2	ANT 3	ANT 1	0.937	0.915	0.935	23.00	20.70	19.70
LTE Band 71	ANT 2	ANT 2	ANT 2	0.730	0.605	0.605	24.20	24.70	24.70
MSS	N/A	ANT 1	ANT 4	N/A	0.858	0.922	N/A	22.30	21.50
NR n5	ANT 2	ANT 2	ANT 2	0.818	0.709	0.709	23.50	25.20	25.20
NR n7	ANT 2	ANT 2	ANT 1	0.767	0.901	0.902	17.00	19.00	20.00
NR n12	ANT 2	ANT 2	ANT 1	0.734	0.563	0.621	24.20	24.70	25.70
NR n14	ANT 2	ANT 3	ANT 3	0.617	0.776	0.776	23.70	25.40	25.40
NR n25/2	ANT 4	ANT 2	ANT 2	0.923	0.942	0.942	19.20	19.20	19.20
NR n26	ANT 2	ANT 1	ANT 1	0.618	0.599	0.599	23.50	25.70	25.70
NR n30	ANT 2	ANT 2	ANT 2	0.917	0.916	0.916	19.50	19.70	19.70
NR n41	ANT 4	ANT 2	ANT 2	0.889	0.919	0.919	19.50	18.50	18.50
NR n48	ANT 8	ANT 9	ANT 9	0.927	0.949	0.949	20.80	20.80	20.80
NR n53	ANT 2	ANT 2	ANT 2	0.775	0.914	0.914	16.50	18.50	18.50
NR n66	ANT 4	ANT 3	ANT 1	0.940	0.894	0.903	20.50	20.70	19.70
NR n70	ANT 4	ANT 3	ANT 1	0.903	0.833	0.898	20.50	20.70	19.70
NR n71	ANT 2	ANT 2	ANT 2	0.679	0.674	0.674	24.20	24.70	24.70
NR n77	ANT 8	ANT 4	ANT 4	0.892	0.908	0.908	20.80	19.50	19.50

**Table 5-2: Radio configurations selected for Part 2**

Part 2 Test Configurations											Part 1 worst-case radio config 1g SAR measured at $P_{lim}$ (W/kg)
Test Case	Test Scenario	Tech	Band	ANT	DSI	Channel	Freq	RB/Offset	Mode	Detail	
1	Time-varying Tx power transmission (Seq1/Seq2) for conducted power	GSM	1900	3	1	810	1909.8	N/A	B	GSM   Back   1-g   5mm	0.529
2		W-CDMA	BIV	1	1	1312	1712.4	N/A	B	W-CDMA   Edge Bottom   1-g   5mm	0.751
3		LTE	B66/4	1	1	132072	1720.0	50/24	B	LTE   Edge Bottom   1-g   5mm	0.778
4		sub6 NR	n77	9	1	633332	3500.0	135/69	B	FR1   Back   1-g   5mm	0.515
5	Call drop for conducted power test	LTE	B66/4	1	1	132072	1720.0	50/24	B	LTE   Edge Bottom   1-g   5mm	0.778
6	Tech/band for conducted power test	W-CDMA	BIV	1	1	1312	1712.4	N/A	B	W-CDMA   Edge Bottom   1-g   5mm	0.751
		LTE	B66/4	1	1	132072	1720.0	50/24	B	LTE   Edge Bottom   1-g   5mm	0.778
7	DSI switch for conducted power test	LTE	B66/4	1	0	132322	1745.0	1/49	A	LTE   Right Cheek   1-g   0mm	0.096
		LTE	B66/4	1	1	132072	1720.0	50/24	B	LTE   Edge Bottom   1-g   5mm	0.778
8	Time-window/Ant switch for conducted power test	LTE	B66/4	1	1	132072	1720.0	50/24	B	LTE   Edge Bottom   1-g   5mm	0.778
		LTE	B48	7	1	56207	3646.7	50/24	B	LTE   Edge Right   1-g   5mm	0.679
9	SAR exposure switch for conducted power test	ENDC	n77	9	1	633332	3500.0	135/69	B	FR1   Back   1-g   5mm	0.515
			B66/4	1	1	132072	1720.0	50/24	B	LTE   Edge Bottom   1-g   5mm	0.778

Based on the selection criteria described in §4.2, the radio configurations for the transmission varying test cases listed in §3 are:

1. Technologies and bands for time-varying Tx power transmission: The test case 1~4 listed in Table 5-2 are selected to test with the test sequences defined in §4.1 in both time-varying conducted power measurements and time-varying SAR measurements.
2. Technology and band for change in call test: Select the technology and frequency band having the lowest  $P_{limit}$  among all technologies and bands (test case 5 in Table 5-2) for performing the call drop test in conducted power setup.
3. Technologies and bands for change in technology/band test: Following the guidelines in §4.2.3 and 4.2.4, test case 6 in Table 5-2 is selected for handover test from a technology/band/antenna with the highest  $P_{limit}$  within one technology group, to a technology/band in the same DSI state with the lowest  $P_{limit}$  within another technology group in a conducted power setup.
4. Technologies and bands for change in DSI: Based on selection criteria in §4.2.5, for a given technology and band, test case 7 in Table 5-2 is selected for DSI switch test by establishing a call in one technology and DSI state and then handing over to another DSI state/exposure scenario in a conducted power setup.
5. Technologies and bands for change in time-window/antenna: Based on selection criteria in §4.2.6, for a given DSI state, test case 8 in Table 5-2 is selected for time window switch between 60 seconds window and 100 seconds window in a conducted power setup.
6. Technologies and bands for switch in SAR exposure: Based on selection criteria in §4.2.7 Scenario 1, test case 9 in Table 5-2 is selected for SAR exposure switching test in one of the supported simultaneous WWAN transmission scenario, i.e., LTE + Sub6 NR active in the same 100 seconds time window, in a conducted power setup.

## 6. Conducted Power Test Results for Sub-6 GHz Smart Transmit Feature Validation

### 6.1. Measurement Setup

The Rohde & Schwarz CMW500 callbox is used in this test. The test setup picture and schematic are shown in Figures 6-1a and 6-1c for measurements with a single antenna and in Figures 6-1b and 6-1d for measurements involving antenna switching (see Appendix C for missing figures). For single antenna measurements, one port (RF1 COM) of the callbox is connected to the RF port of the EUT using a directional coupler. For antenna & technology switch measurement, two ports (RF1 COM and RF3 COM) of the callbox are used for signaling two different technologies are connected to a combiner, which is, in turn, connected to a directional coupler. The other end of the directional coupler is connected to a splitter to connect to two RF ports of the EUT corresponding to the two antennas of interest. In both the setups, a power meter is used to tap the directional coupler for measuring the conducted output power of the EUT. For time averaging validation test (§4.3.1), call drop test (§4.3.2), and DSI switch test (§4.3.4), only RF1 COM port of the callbox is used to communicate with the EUT. For technology/band switch measurement (§4.3.3), both RF1 COM and RF3 COM ports of the callbox are used to switch from one technology communicating on RF1 COM port to another technology communicating on RF3 COM port.<sup>15</sup> All the path losses from the RF port of the EUT to the callbox RF COM port and to the power meter are calibrated and automatically entered as offsets in the callbox and the power meter via test scripts on the PC used to control callbox and power meter.

#### LTE + Sub-6 GHz NR Test Setup:

If the LTE conducted port and Sub-6 GHz NR conducted port are same on this EUT (i.e., they share the same antenna), then low-/high-pass filters are used to separate the LTE and Sub-6 GHz NR signals for power meter measurement via directional couplers, as shown in below Figures 6-1b and 6-1c.

<sup>15</sup> For this EUT, antenna switch test (§4.3.4) is included within time-window switch test (§4.3.6) as the selected technology/band combinations for the time-window switch test are on two different antennas.

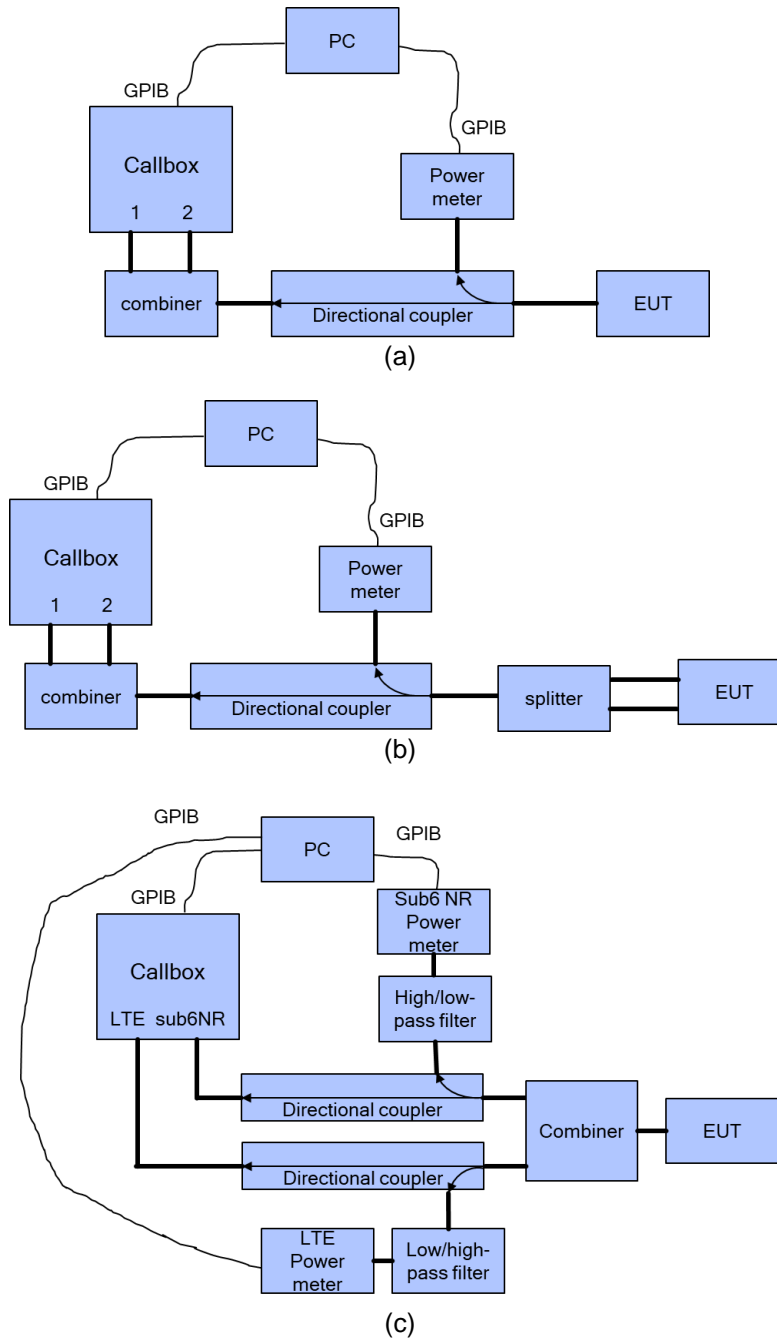

**Figure 6-1a – 6-1c: Conducted power measurement setup**

Both the callbox and power meter are connected to the PC using GPIB cables. Two test scripts are custom made for automation and the test duration set in the test scripts is 500 seconds.

For time-varying transmission power measurement, the PC runs the first test script to send GPIB commands to control the callbox’s requested power versus time, while, at the same time, recording the conducted power measured at the EUT’s RF port using the power meter. The commands sent to the callbox to request power are:

- 0 dBm for 100 seconds.
- Test sequence 1 or test sequence 2 (defined in §4.1 and generated in §4.2.1) for 360 seconds.
- Stay at the last power level of test sequence 1 or test sequence 2 for the remaining time.

The power meter readings are periodically recorded every 100 milliseconds. A running average of this measured transmission power over 100 seconds is performed in the post-data processing to determine the 100 seconds-time averaged power.

For call drop, technology/band/antenna switch, and DSI switch tests, after the call is established, the callbox is set to request the EUT’s transmission power at 0 dBm for 100 seconds while simultaneously starting the second test script run at the same time to start recording the transmission power measured at the EUT’s RF port using the power meter. After the initial 100 seconds, since starting the transmission power recording, the callbox is set to request maximum power from the EUT for the rest of the test.<sup>16</sup>

### 6.2. $P_{limit}$ and $P_{max}$ Measurement Results

The measured  $P_{limit}$  for all the selected radio configurations given in Table 5-2 are listed in Table 6-1.  $P_{max}$  was also measured for radio configurations selected for testing time-varying power transmission scenarios to generate test sequences following the test procedures in §4.1.

**Table 6-1: Measured  $P_{limit}$  and  $P_{max}$  of selected radio configurations**

Test Case	Test Scenario	Tech	Band	ANT	DSI	Channel	Freq	RB/Offset	Mode	Detail(s)	$P_{lim}$ EFS Setting <sup>1</sup> (Burst)	$P_{max}$ (Burst)	Measured $P_{lim}$
1	time-varying Tx power transmission (Seq1/Seq2) for conducted power	GSM	1900	3	1	810	1909.8	N/A	B	GSM   Back   1-g   5mm	26.50	30.50	25.50
2		WCDMA	BIV	1	1	1312	1712.4	N/A	B	W-CDMA   Edge Bottom   1-g   5mm	19.70	25.70	18.80
3		LTE	B66/4	1	1	132072	1720.0	50/24	B	LTE   Edge Bottom   1-g   5mm	19.70	25.70	18.90
4		sub6 NR	n77	9	1	633332	3500.0	135/69	B	FR1   Back   1-g   5mm	18.80	25.70	18.00
5	call drop for conducted power test	LTE	B66/4	1	1	132072	1720.0	50/24	B	LTE   Edge Bottom   1-g   5mm	19.70	25.70	18.90
6	tech/band for conducted power test	LTE	BIV	1	1	1312	1712.4	N/A	B	W-CDMA   Edge Bottom   1-g   5mm	19.70	25.70	18.80
		LTE	B66/4	1	1	132072	1720.0	50/24	B	LTE   Edge Bottom   1-g   5mm	19.70	25.70	18.90
7	DSI switch for conducted power test	LTE	B66/4	1	0	132322	1745.0	1/49	A	LTE   Right Cheek   1-g   0mm	25.00	25.70	25.00
		LTE	B66/4	1	1	132072	1720.0	50/24	B	LTE   Edge Bottom   1-g   5mm	19.70	25.70	18.90
8	Time-window/Ant switch for conducted power test	LTE	B66/4	1	1	132072	1720.0	50/24	B	LTE   Edge Bottom   1-g   5mm	19.70	25.70	18.90
		LTE	B48	7	1	56207	3646.7	50/24	B	LTE   Edge Right   1-g   5mm	22.50	26.00	22.60
9	SAR exposure switch for conducted power test	ENDC	n77	9	1	633332	3500.0	135/69	B	FR1   Back   1-g   5mm	18.80	25.70	18.00
			B66/4	1	1	132072	1720.0	50/24	B	LTE   Edge Bottom   1-g   5mm	19.70	25.70	18.90

<sup>1</sup> Lists the target power without manufacturer uncertainty per specified configuration.

### 6.3. Time-varying Transmission Power Measurement Results

The measurement setups are shown in Figures 6-1(a) and 6-1(c). The purpose of the time-varying transmission power measurement is to demonstrate the effectiveness of power limiting enforcement and that the time-averaged transmission power, when represented in time-averaged 1-g SAR or 10-g SAR values, do not exceed FCC limit as shown in Eq. (1a) and (1b), rewritten below:

$$1g \text{ or } 10g \text{ SAR}(t) = \frac{\text{conducted Tx power}(t)}{\text{conducted Tx power } P_{limit}} * 1g \text{ or } 10g \text{ SAR } P_{limit} \text{ (1a)}$$

$$\frac{\frac{1}{T_{SAR}} \int_{t-T_{SAR}}^t 1g \text{ or } 10g \text{ SAR}(t) dt}{FCC \text{ SAR limit}} \leq 1 \text{ (1b)}$$

where  $conducted \text{ Tx power}(t)$ ,  $conducted \text{ Tx power } P_{limit}$ , and  $1-g \text{ or } 10-g \text{ SAR } P_{limit}$  correspond to the measured instantaneous conducted transmission power, measured conducted Tx power at  $P_{limit}$ , and measured 1-g SAR and 10-g SAR values at  $P_{limit}$  reported in the Part 0 test (listed in Table 5-2 of this report as well).

Following the test procedure in §4.3, the conducted transmission power measurement for all selected configurations is reported in this section. In all the conducted transmission power plots, the dotted line represents the requested power by callbox (test sequence 1 or test sequence 2), the blue curve represents the instantaneous conducted transmission power measured using the power meter, the green curve represents time-averaged power, and the red line represents the conducted power limit that corresponds to FCC limit of 1.6 W/kg for 1-g SAR or 4.0 W/kg for 10-g SAR.

Similarly, in all the 1-g or 10-g SAR plots (when converted using Eq. (1a)), the green curve represents the 100/60 seconds-time averaged 1-g SAR or 10-g SAR value calculated based on the instantaneous 1-g SAR or 10-g SAR; the red line limit represents the FCC limit of 1.6 W/kg for 1-g SAR or 4.0 W/kg for 10-g SAR.

<sup>16</sup> The call drop/re-establish, or technology/band/antenna switch, or DSI switch is manually performed when the transmission power of the EUT is at  $P_{reserve}$  level. See §4.3 for the detailed test procedure of call drop test, technology/band/antenna switch test, and DSI switch test.

Time-varying transmission power measurements were conducted on test cases 1 through 9 in Table 5-2, by generating test sequence 1 and test sequence 2 given in Appendix A using measured  $P_{limit}$  and measured  $P_{max}$  (last columns of Table 6-1) for each of these test cases. Measurement results for test cases 1 through 9 are given in §6.3.1 through §6.8.

### 6.3.1. GPRS PCS Antenna 3 (Test Case 1 in Table 5-2)

#### Test Result for Test Sequence 1:

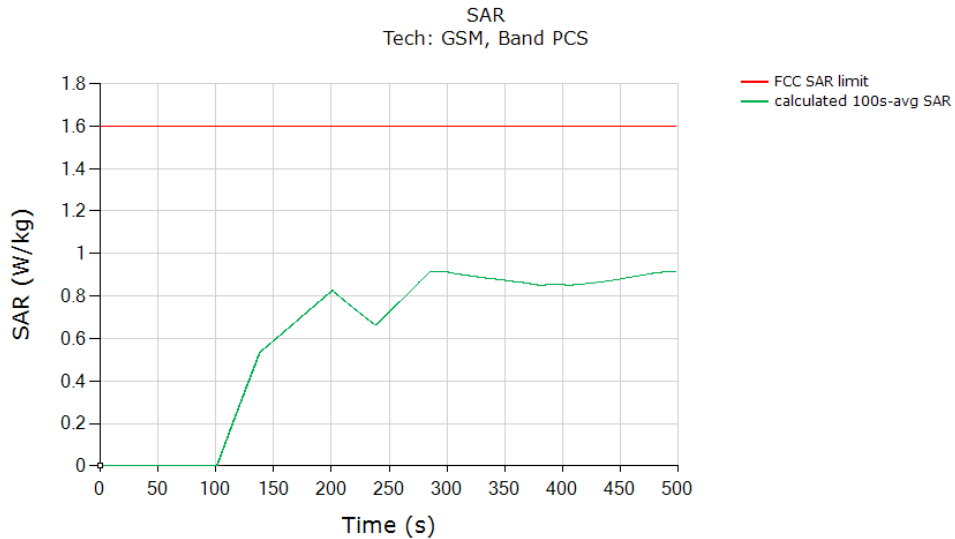

	(W/kg)
FCC 1-g SAR limit	1.6/4.0
Max 100 seconds-time averaged 1-g SAR (green curve)	0.914
<b>Validated:</b> Max time averaged SAR (green curve) is less than the $SAR_{Design Limit}$ .	

#### Test Result for Test Sequence 2:

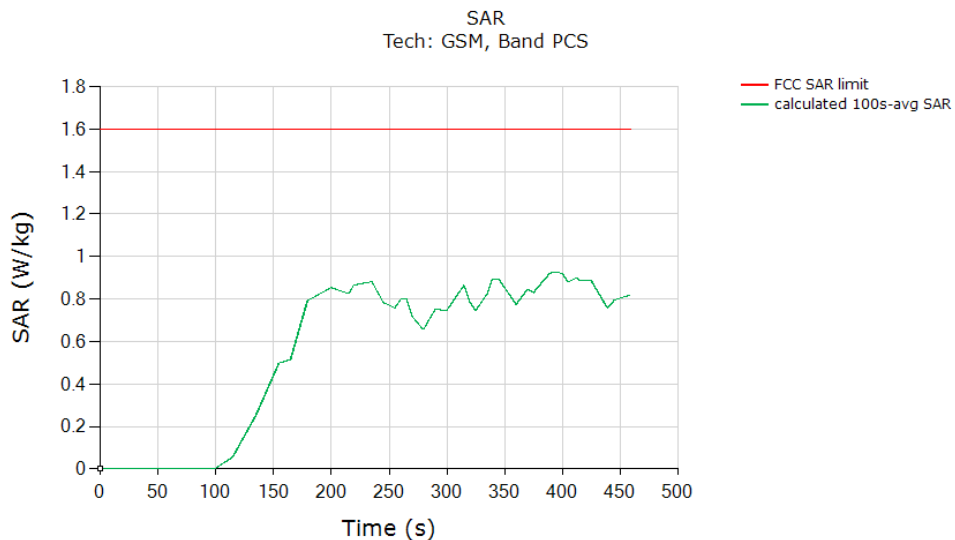

	(W/kg)
FCC 1-g SAR limit	1.6/4.0
Max 100 seconds-time averaged 1-g SAR (green curve)	0.925
<b>Validated:</b> Max time averaged SAR (green curve) is less than the $SAR_{Design Limit}$ .	

### 6.3.2. W-CDMA Band 4 Antenna 1 (Test Case 2 in Table 5-2)

Test Result for Test Sequence 1:

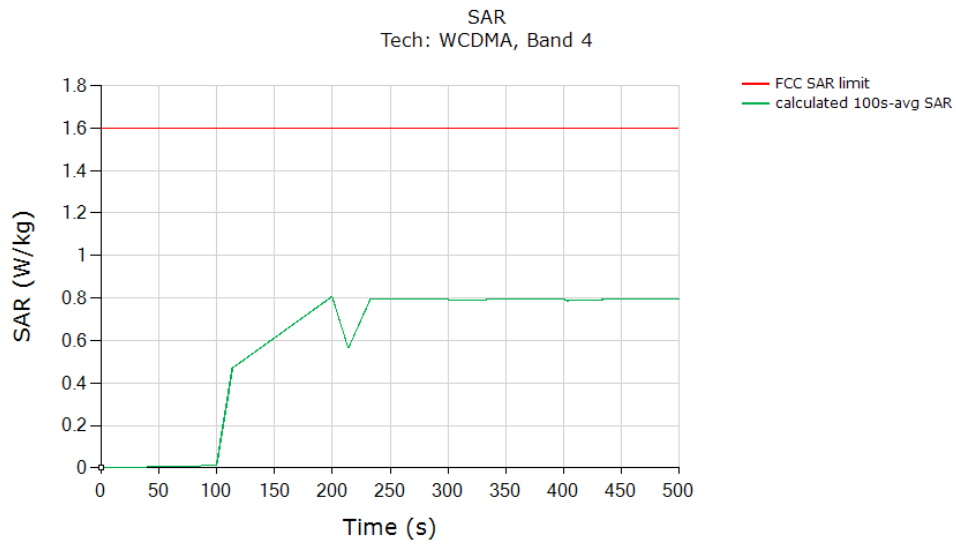

	(W/kg)
FCC 1-g SAR limit	1.6/4.0
Max 100 seconds-time averaged 1-g SAR (green curve)	0.806
<b>Validated:</b> Max time averaged SAR (green curve) is less than the SAR <sub>Design Limit</sub> .	

Test Result for Test Sequence 2:

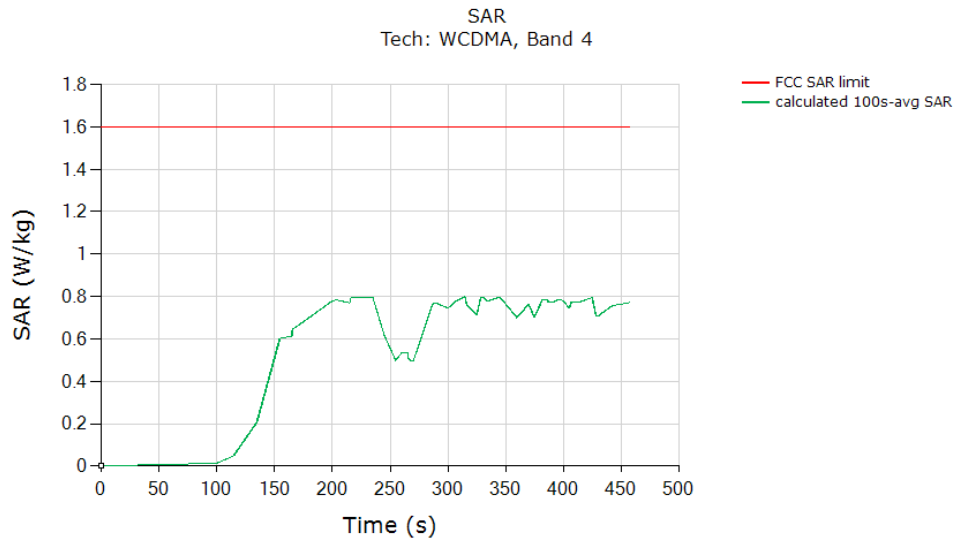

	(W/kg)
FCC 1-g SAR limit	1.6/4.0
Max 100 seconds-time averaged 1-g SAR (green curve)	0.799
<b>Validated:</b> Max time averaged SAR (green curve) is less than the SAR <sub>Design Limit</sub> .	

### 6.3.3. LTE Band 66 Antenna 1 (Test Case 3 in Table 5-2)

Test Result for Test Sequence 1:

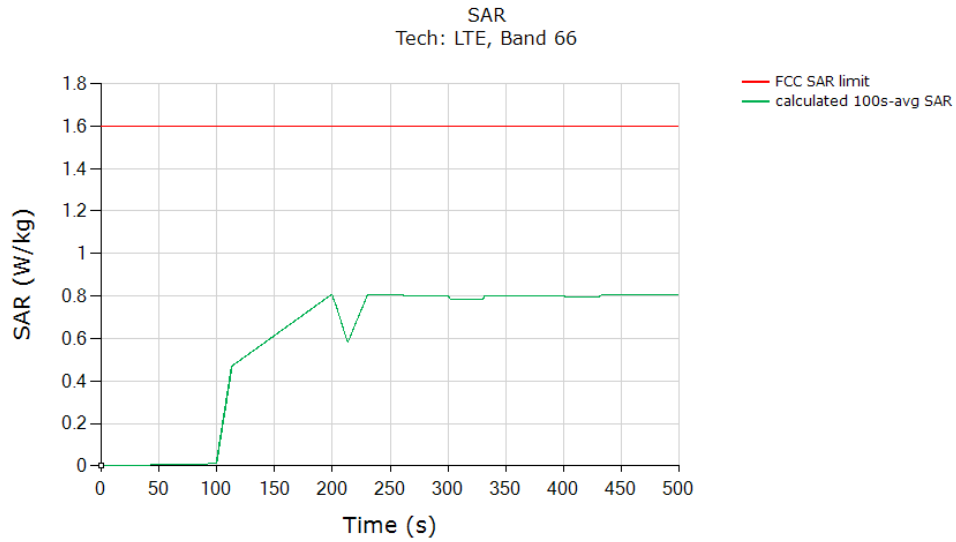

	(W/kg)
FCC 1-g SAR limit	1.6/4.0
Max 100 seconds-time averaged 1-g SAR (green curve)	0.808
<b>Validated:</b> Max time averaged SAR (green curve) is less than the SAR <sub>Design Limit</sub> .	

Test Result for Test Sequence 2:

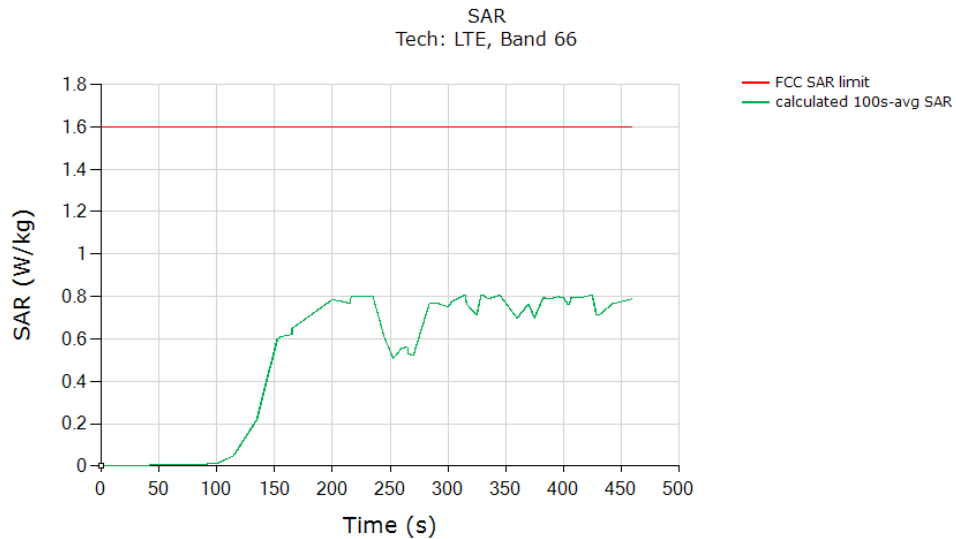

	(W/kg)
FCC 1-g SAR limit	1.6/4.0
Max 100 seconds-time averaged 1-g SAR (green curve)	0.807
<b>Validated:</b> Max time averaged SAR (green curve) is less than the SAR <sub>Design Limit</sub> .	

### 6.3.4. Sub-6 GHz NR Band n77 Antenna 9 (Test Case 4 in Table 5-2)

Test Result for Test Sequence 1:

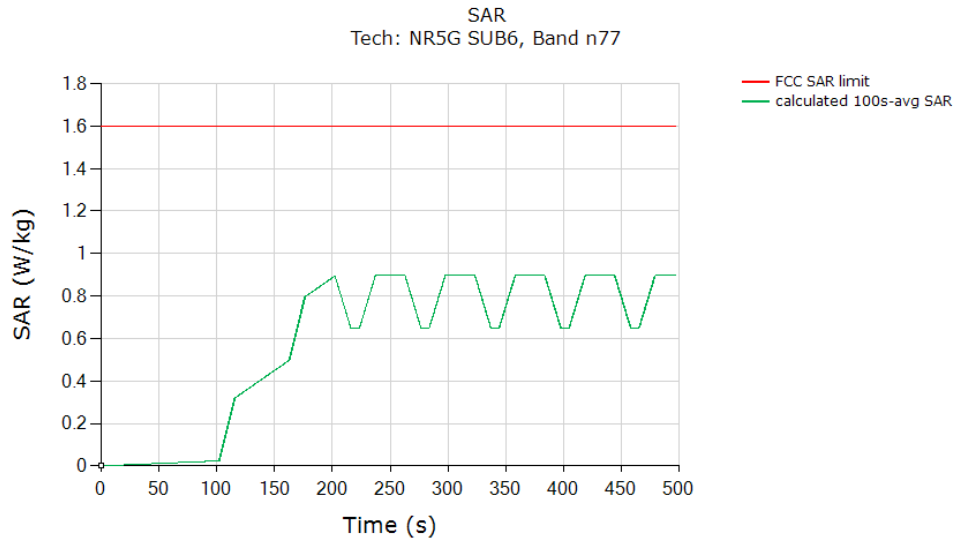

	(W/kg)
FCC 1-g SAR limit	1.6/4.0
Max 100 seconds-time averaged 1-g SAR (green curve)	0.898
<b>Validated:</b> Max time averaged SAR (green curve) is less than the SAR <sub>Design Limit</sub> .	

Test Result for Test Sequence 2:

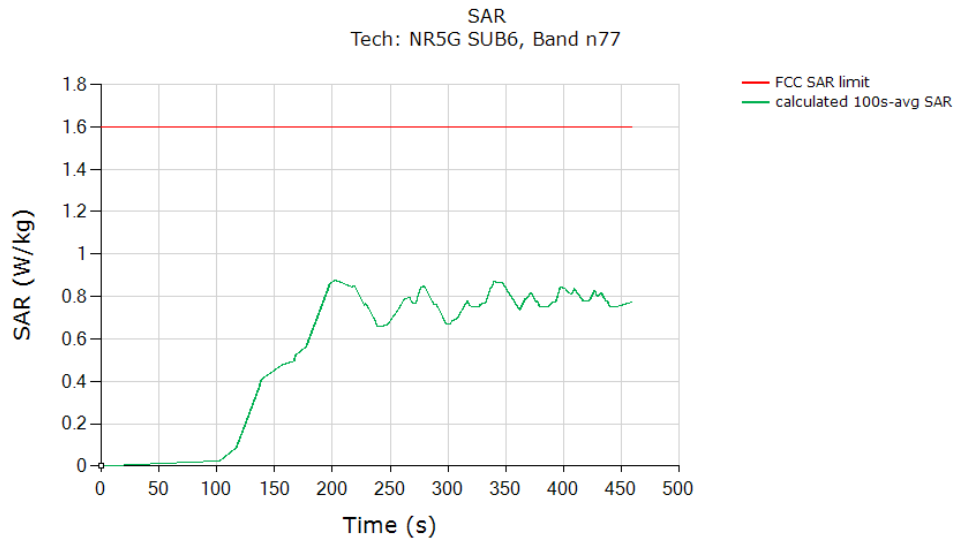

	(W/kg)
FCC 1-g SAR limit	1.6/4.0
Max 100 seconds-time averaged 1-g SAR (green curve)	0.876
<b>Validated:</b> Max time averaged SAR (green curve) is less than the SAR <sub>Design Limit</sub> .	



### 6.4. Change in Call Test Results (Test Case 5 in Table 5-2)

This test was measured with LTE 66, Antenna 1, DSI state 1, and with callbox requesting maximum power. The call drop was manually performed when the EUT is transmitting at  $P_{reserve}$ , as shown in the plot below (dotted black region). The measurement setup is shown in Figure 6-1(a) and (c). The detailed test procedure is described in §4.3.2.

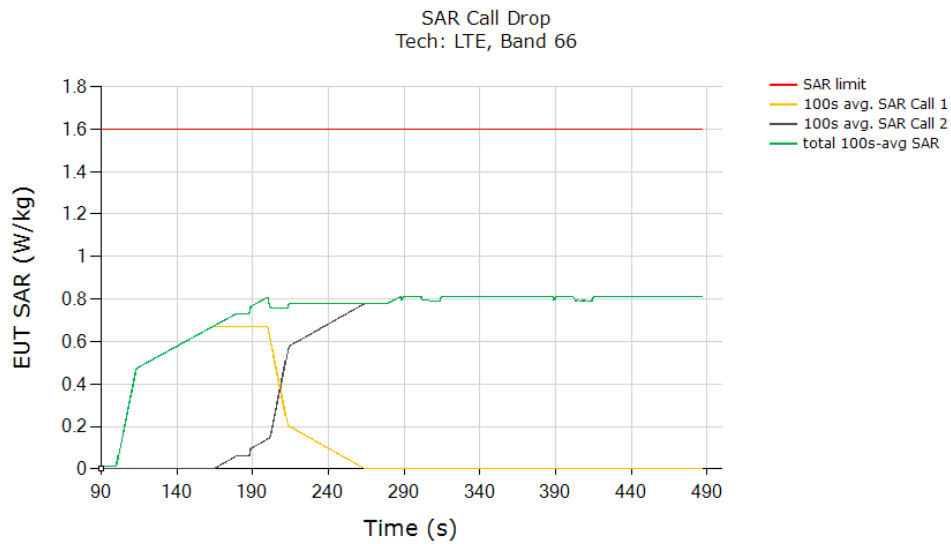

	(W/kg)
FCC 1-g SAR limit	1.6/4.0
Max 60 seconds-time averaged 1-g SAR (green curve)	0.812
Validated	

The test result validated the continuity of power limiting in the call change scenario.

### 6.5. Change in Technology/Band Test Results (Test Case 6 in Table 5-2)

This test was conducted with the callbox requesting maximum power and with an antenna and technology switch from LTE 66, Antenna 1, DSI state 1 to W-CDMA 4, Antenna 1, DSI state 1. Following the procedure detailed in §4.3.3 and using the measurement setup shown in Figure 6-1(a) and (c), the technology/band switch was performed when the EUT is transmitting at  $P_{reserve}$  level as shown in the plot below (dotted black region).

Test Result for Change in Technology/Band:

All the time-averaged conducted transmission power measurement results were converted into time-averaged normalized SAR values using Equation (7a), (7b) and (7c), and plotted below to demonstrate that the time-averaged normalized SAR versus time does not exceed the normalized FCC limit of 1.0:

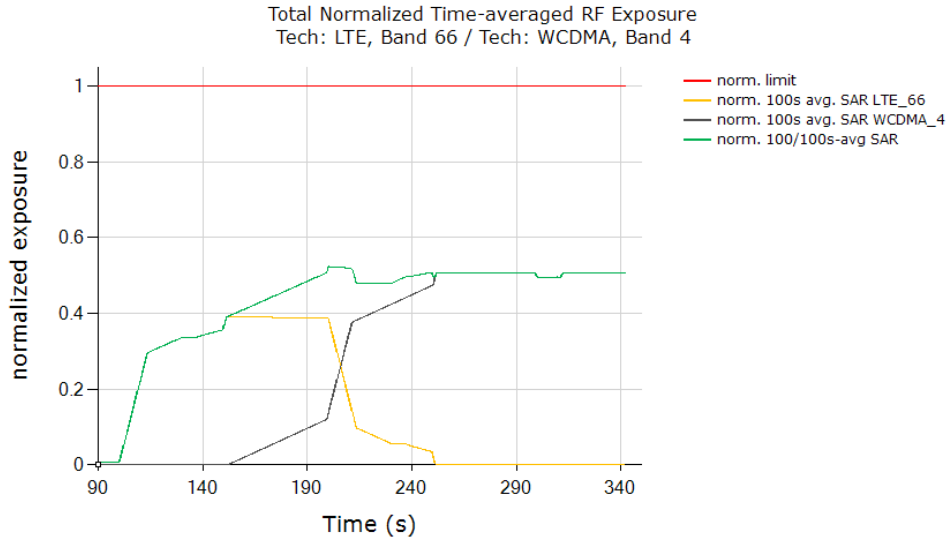

	(W/kg)
FCC normalized SAR limit	1.0
Max 100 seconds-time averaged 1-g SAR (green curve)	0.524
Validated	

The test result validated the continuity of power limiting in technology/band switch scenario.

### 6.6. Change in DSI Test Results (Test Case 7 in Table 5-2)

This test was conducted with the callbox requesting maximum power, and with the DSI switching states. Following the procedure detailed in §4.3.5 using the measurement setup shown in Figure 7-1(a) and (c), the DSI switch was performed when the EUT is transmitting at  $P_{reserve}$  level as shown in the plot below (dotted black circle).

Test Result for Change in DSI:

All the time-averaged conducted transmission power measurement results were converted into time-averaged normalized SAR values using Equation (7a), (7b) and (7c), and plotted below to demonstrate that the time-averaged normalized SAR versus time does not exceed the FCC limit of 1 unit.

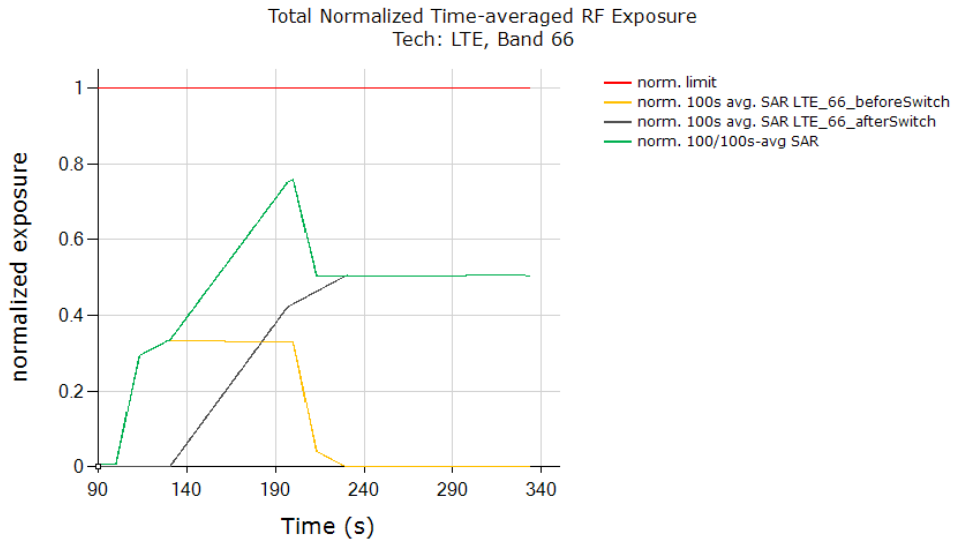

	(W/kg)
FCC normalized total exposure limit	1.0
Max 100 seconds-time averaged normalized SAR (green curve)	0.759
Validated	

The test result validated the continuity of power limiting in the DSI switching scenario.

### 6.7. Change in Time Window/Antenna Switch Test Results (Test Case 8 in Table 5-2)

This test was conducted with the callbox requesting maximum power and with time-window/antenna switch between LTE 66, Antenna 1, DSI 1 (100 seconds window) and LTE 48, Antenna 7, DSI 1 (60 seconds window). Following the procedure detailed in §4.3.6 and using the measurement setup shown in Figure 6-1(b) and (d), the time-window switch via tech/band/antenna switch was performed when the EUT is transmitting at  $P_{reserve}$  level.

#### 6.7.1. Transition from LTE 66 to LTE 48 (i.e., 100 seconds to 60 seconds), then Back to LTE 66

Test Result for Change in Time Window (from 100 seconds to 60 seconds to 100 seconds):

All the conducted transmission power measurement results were converted into time-averaged normalized SAR values using Equation (7a), (7b) and (7c) and plotted below to demonstrate that the time-averaged normalized SAR versus time does not exceed the FCC limit of 1 unit. Equation (7a) is used to convert the transmission power of the device to obtain the 100 seconds-averaged normalized SAR for LTE 66 as shown with the black curve. Similarly, equation (7b) is used to obtain the 60 seconds-averaged normalized SAR for LTE 48 as shown with the orange curve. Equation (7c) is used to obtain the total time-averaged normalized SAR as shown with the green curve (i.e., the sum of both the black and orange curves).

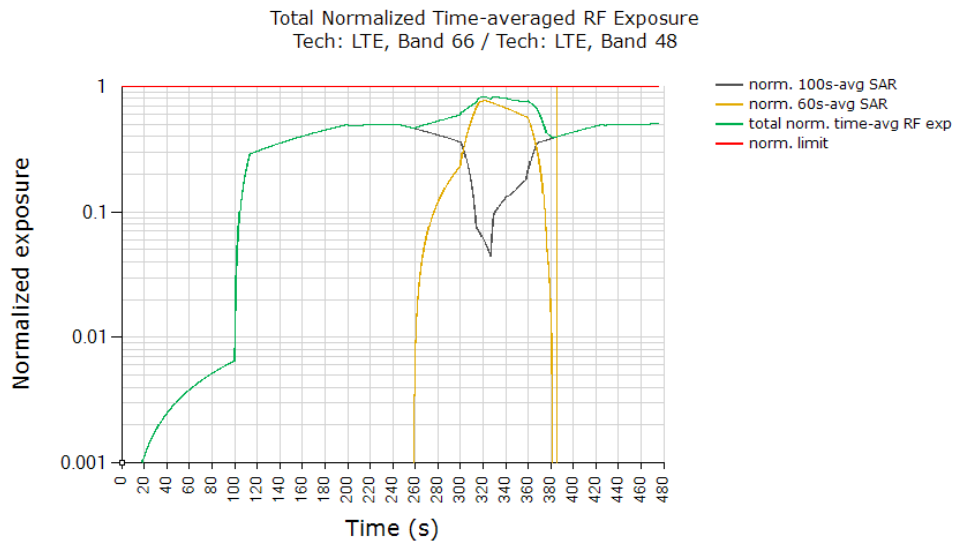

	(W/kg)
FCC normalized total exposure limit	1.0
Max time averaged normalized SAR (green curve)	0.832
Validated	

### 6.8. Switch in SAR Exposure Test Results (Test Case 9 in Table 5-2)

This test was conducted with the callbox requesting maximum power and with the EUT in LTE 66 + Sub-6 GHz NR Band n77 call. Following the procedure detailed in §4.3.7 and Appendix B.2, and using the measurement setup shown in Figure 6-1(a) and (c) or Figure 6-1(b) and (d) if LTE and Sub-6 GHz NR are sharing the same antenna port, the SAR exposure switch measurement is performed with the EUT in various SAR exposure scenarios, i.e., in SAR<sub>Sub-6 GHz NR only</sub> scenario (t =10s ~125s), SAR<sub>Sub-6 GHz NR + SAR<sub>LTE</sub></sub> scenario (t =125s ~ 235s) and SAR<sub>LTE only</sub> scenario (t > 235s).

All the conducted transmission power measurement results were converted into time-averaged normalized SAR values using Equation (7a), (7b) and (7c) and plotted below to demonstrate that the time-averaged normalized SAR versus time does not exceed the FCC limit of 1 unit. Equation (7a) is used to convert the LTE transmission power of the device to obtain the 100 seconds-averaged normalized SAR in LTE 66 as shown with the black curve. Similarly, equation (7b) is used to obtain the 100 seconds-averaged normalized SAR in Sub-6 GHz NR Band n77 as shown with the orange curve. Equation (7c) is used to obtain the total time-averaged normalized SAR as shown with the green curve (i.e., sum of both the black and orange curves).

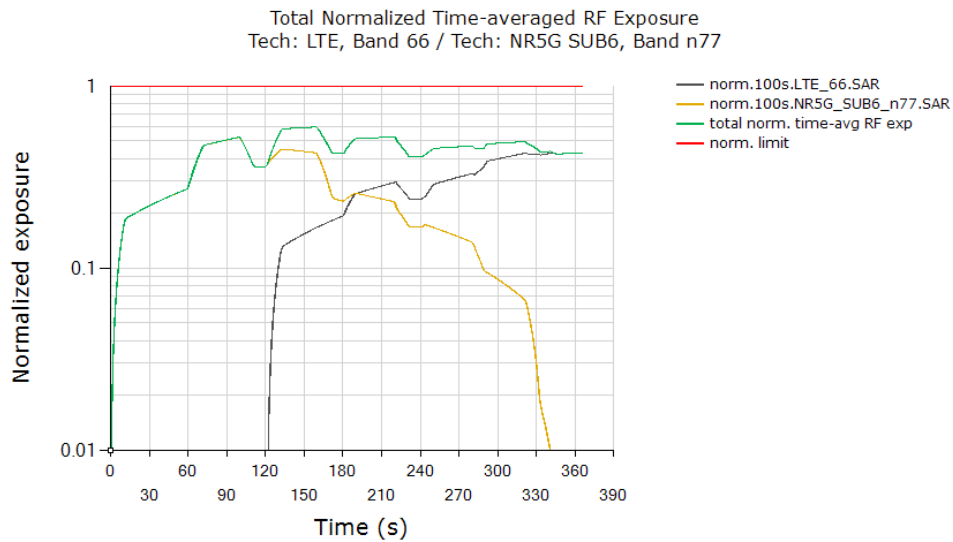

	(W/kg)
FCC normalized total exposure limit	1.0
Max time averaged normalized SAR (green curve)	0.597
<b>Validated</b>	

## 7. SAR Test Results for Sub-6 GHz Smart Transmit Feature Validation

Given the use of the same modem chipset as other models, test case reduction has been implemented per Qualcomm guidance. Measured SAR results shall be reused from reference model A2686 (FCC ID: BCG-E8427A).

## 8. Conclusions

Qualcomm Smart Transmit feature employed herein has been validated through the conducted/radiated power measurement (as demonstrated in §7 and §9), as well as SAR and PD measurement, §8 and §10 are leveraged from reference model A2686 (FCC ID: BCG-E8427A),.

As demonstrated in this report, the power limiting enforcement is effective and the total normalized time-averaged RF exposure does not exceed 1.0 for all the transmission scenarios as described in §3. Therefore, the EUT complies with FCC RF exposure requirements.

## Appendices

### A Test Sequences

1. Test sequence is generated based on the following parameters of the EUT:
  - a. Measured maximum power ( $P_{max}$ )
  - b. Measured transmission power at SAR<sub>Design Target</sub> ( $P_{limit}$ )
  - c. Reserve\_power\_margin (dB)
    - i.  $P_{reserve}$  (dBm) = measured  $P_{limit}$  (dBm) - Reserve\_power\_margin (dB)
  - d. SAR time window (100 seconds for FCC)
2. Test Sequence 1 Waveform: Based on the parameters above, Test Sequence 1 is generated with one transition between high and low transmission powers. Here, high power =  $P_{max}$ ; low power =  $P_{max}/2$ , and the transition occurs after 80 seconds at high power ( $P_{max}$ ). If the power enforcement is taking into effective during one 100 seconds/60 seconds time window, the validation test with this defined Test Sequence 1 is valid; otherwise, select other radio configurations (band/DSI within the same technology group) having lower  $P_{limit}$  for this test. The Test Sequence 1 waveform is shown below:

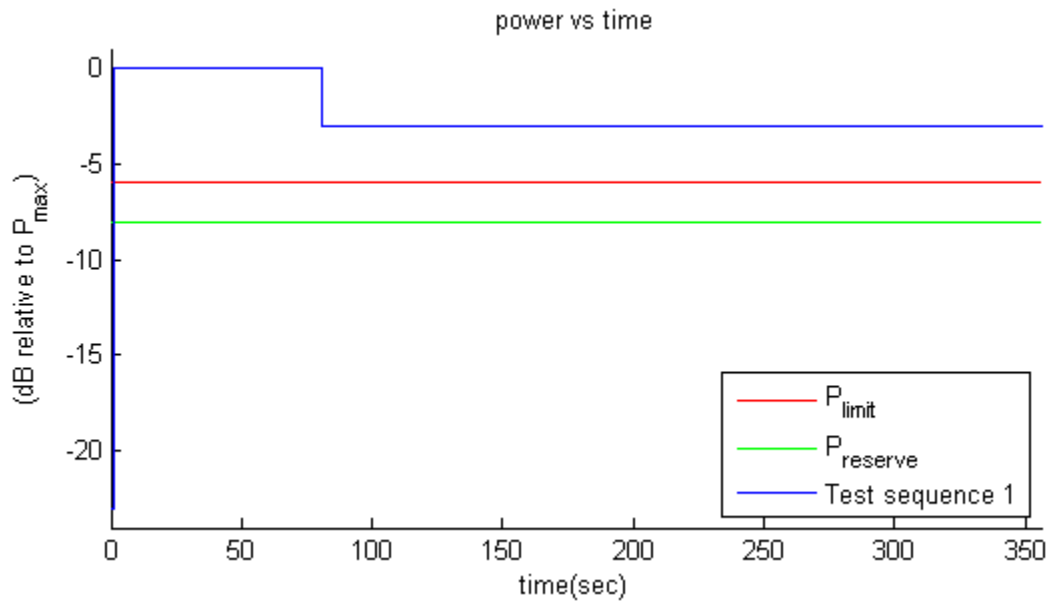
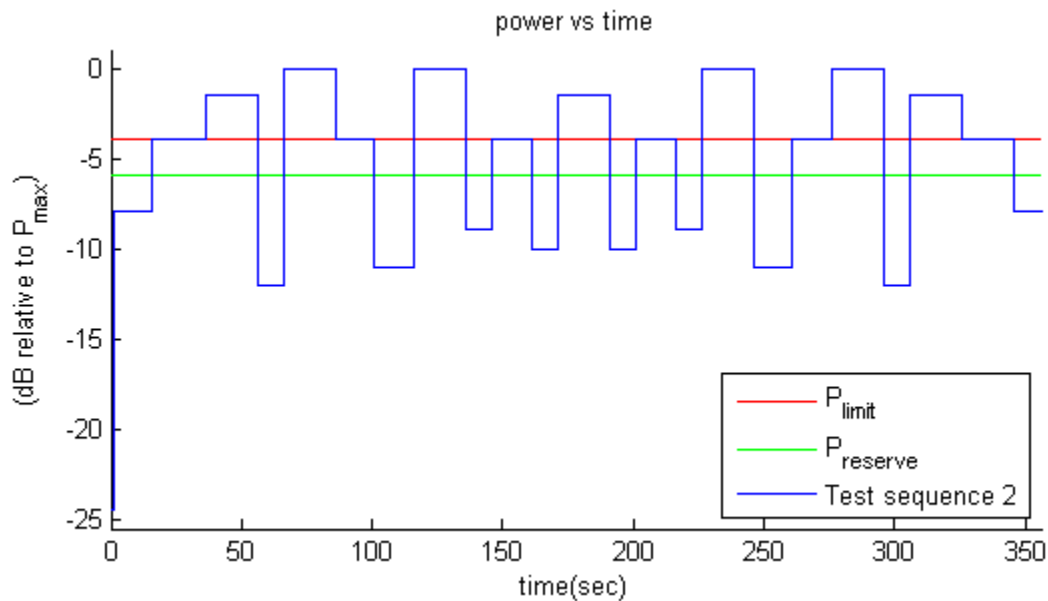

**Figure A-1: Test Sequence 1 waveform**

3. Test Sequence 2 Waveform: Based on the parameters in A-1, the Test Sequence 2 is generated as described in Table A-1 and pictured in Figure A-2, which contains two 170 seconds-long sequences (yellow and green highlighted rows) that are mirrored around the center row of 20 seconds, resulting in a total duration of 360 seconds:

**Table A-1: Test Sequence 2**

Time duration (seconds)	dB relative to $P_{limit}$ or $P_{reserve}$
15	$P_{reserve} - 2$
20	$P_{limit}$
20	$(P_{limit} + P_{max})/2$ averaged in mW and rounded to nearest 0.1 dB step
10	$P_{reserve} - 6$
20	$P_{max}$
15	$P_{limit}$
15	$P_{reserve} - 5$
20	$P_{max}$
10	$P_{reserve} - 3$
15	$P_{limit}$
10	$P_{reserve} - 4$
20	$(P_{limit} + P_{max})/2$ averaged in mW and rounded to nearest 0.1 dB step
10	$P_{reserve} - 4$
15	$P_{limit}$
10	$P_{reserve} - 3$
20	$P_{max}$
15	$P_{reserve} - 5$
15	$P_{limit}$
20	$P_{max}$
10	$P_{reserve} - 6$
20	$(P_{limit} + P_{max})/2$ averaged in mW and rounded to nearest 0.1 dB step
20	$P_{limit}$
15	$P_{reserve} - 2$



**Figure A-2: Test Sequence 2 waveform**



## B Test Procedures for Sub-6 GHz NR + Sub-6 GHz Radio

Appendix B provides the test procedures for validating the Smart Transmit feature for Sub-6 GHz + Sub-6 GHz NR non-standalone (NSA) mode transmission scenario, where Sub-6 GHz link acts as an anchor.

### B.1 Time-varying Transmission Power Test for Sub-6 GHz NR in NSA Mode

Following §4.2.1 to select the test configurations for time-varying tests, these tests are performed with two pre-defined test sequences (as described in §4.1) and applied to Sub-6 GHz NR (with Sub-6 GHz on all-down bits or low power for the entire test after establishing the Sub-6 GHz + Sub-6 GHz NR call with the callbox). Follow the test procedures described in §4.3.1 to demonstrate the effectiveness of power limiting enforcement and that the time averaged transmission power of Sub-6 GHz NR when converted into 1g SAR values do not exceed the regulatory limit (see Eq. (1a) and (1b)). Sub-6 GHz NR response to Test Sequence 1 and Test Sequence 2 will be similar to other technologies (say, LTE), and are shown in §7.2.7 and §7.2.8.

### B.2 Switch in SAR Exposure Between Sub-6 GHz vs. Sub-6 GHz NR during Transmission

This test is to demonstrate that the Smart Transmit feature accurately accounts for switching in exposures among SAR for Sub-6 GHz radio only, SAR from both Sub-6 GHz radio and Sub-6 GHz NR, and SAR from Sub-6 GHz NR only scenarios, and ensures total time-averaged RF exposure compliance with ISED limit.

#### Test Procedure:

1. Measure the conducted transmission power corresponding to  $P_{limit}$  for Sub-6 GHz and Sub-6 GHz NR in selected bands. Test conditions to measure conducted  $P_{limit}$  are:
  - a. Establish the device in a call with the callbox for Sub-6 GHz in a desired band. Measure the conducted transmission power corresponding to Sub-6 GHz  $P_{limit}$  with Smart Transmit enabled and *Reserve\_power\_margin* set to 0 dB, and the callbox set to request maximum power.
  - b. Repeat Step 1a to measure the conducted transmission power corresponding to Sub-6 GHz NR  $P_{limit}$ . If testing Sub-6 GHz + Sub-6 GHz NR in non-standalone mode (NSA), then establish a Sub-6 GHz + Sub-6 GHz NR call with the callbox and request all down bits for radio1 Sub-6 GHz. In this scenario, with the callbox requesting maximum power from the Sub-6 GHz NR radio, measure the conducted transmission power corresponding to radio2  $P_{limit}$  (as radio1 Sub-6 GHz is at all-down bits).
2. Set *Reserve\_power\_margin* to actual (intended) value with the EUT setup for Sub-6 GHz + Sub-6 GHz NR call. First, establish a Sub-6 GHz connection in all-up bits with the callbox and then a Sub-6 GHz NR connection is added with the callbox requesting the EUT to transmit at maximum power in Sub-6 GHz NR. When the Sub-6 GHz NR connection is established, request all-down bits on the Sub-6 GHz link (otherwise, Sub-6 GHz NR will not have sufficient RF exposure margin to sustain the call with Sub-6 GHz in all-up bits). Continue the Sub-6 GHz (all-down bits) + Sub-6 GHz NR transmission for more than one time-window duration to test, predominantly, the Sub-6 GHz NR SAR exposure scenario (as SAR exposure is negligible from all-down bits in Sub-6 GHz). After at least one time-window, request Sub-6 GHz to go all-up bits to test Sub-6 GHz SAR and Sub-6 GHz NR SAR exposure scenario. After at least one more time-window, drop (or request all-down bits) Sub-6 GHz NR transmission to test predominantly the Sub-6 GHz SAR exposure scenario. Continue the test for at least one more time-window. Record the conducted transmission powers for both Sub-6 GHz and Sub-6 GHz NR for the entire duration of this test.
3. Once the measurement is done, extract the instantaneous transmission power versus time for both Sub-6 GHz and Sub-6 GHz NR links. Like the technology/band switch test in §4.3.3, convert the conducted transmission power for both these radios into 1g SAR value (see Eq. (6a) and (6b)) using corresponding technology/band  $P_{limit}$  measured in Step 1 and then perform 360 seconds running average to determine time-averaged 1g SAR versus time as illustrated in Figure 4-1.<sup>17</sup>
4. Make one plot containing: (a) Instantaneous transmission power versus time measured in Step 2.
5. Make another plot containing: (a) Instantaneous 1g SAR versus time determined in Step 3, (b) computed time-averaged 1g SAR versus time determined in Step 3, and (c) corresponding regulatory 1g SAR<sub>limit</sub> of 1.6 W/kg. The validation criterion is the time-averaged 1g SAR versus time shall not exceed the regulatory 1g SAR<sub>limit</sub> of 1.6 W/kg.

<sup>17</sup> It is assumed both radios have transmission frequencies < 3 GHz; otherwise, 60 seconds running average should be performed for radios having transmission frequencies between 3 GHz and 6 GHz.

## **C Test Setup Photos**

End of Report