

TEST REPORT

Report Number : 14523772-E17V2

Applicant : APPLE, INC
1 APPLE PARK WAY
CUPERTINO, CA 95014, U.S.A.

Model : A3105

Brand : APPLE

FCC ID : BCG-E8440A

IC : 579C-E8440A

EUT Description : SMARTPHONE

Test Standard(s) : FCC 47 CFR PART 22H, 24E, AND 27L
ISED RSS-GEN Issue 5, RSS-132 Issue 4, RSS-133
Issue 6, AND RSS-139 Issue 4

Date Of Issue:

2023-08-30

Prepared by:

UL Verification Services Inc.
47173 Benicia Street
Fremont, CA 94538, U.S.A.
TEL: (510) 319-4000
FAX: (510) 661-0888



Revision History

<u>Rev.</u>	<u>Issue Date</u>	<u>Revisions</u>	<u>Revised By</u>
V1	2023-08-03	Initial Review	Eric Ting
V2	2023-08-30	Address TCB Feedback Section 6.1,9.2 and 10	Eric Ting

TABLE OF CONTENTS

1. ATTESTATION OF TEST RESULTS	5
2. SUMMARY OF TEST RESULTS	6
3. TEST METHODOLOGY	7
4. FACILITIES AND ACCREDITATION	7
5. DECISION RULES AND MEASUREMENT UNCERTAINTY	8
5.1. METROLOGICAL TRACEABILITY	8
5.2. DECISION RULES	8
5.3. MEASUREMENT UNCERTAINTY	8
5.4. SAMPLE CALCULATION	8
6. EQUIPMENT UNDER TEST	9
6.1. DESCRIPTION OF EUT	9
6.2. MAXIMUM OUTPUT POWER	9
6.3. SOFTWARE AND FIRMWARE	11
6.4. MAXIMUM ANTENNA GAIN	11
6.5. WORST-CASE CONFIGURATION AND MODE	12
6.6. DESCRIPTION OF TEST SETUP	13
7. TEST AND MEASUREMENT EQUIPMENT	15
8. RF OUTPUT POWER VERIFICATION	16
8.1. GSM	16
8.1.1. GSM 850	17
8.1.2. GSM 1900	17
8.2. WCDMA	18
8.2.1. WCDMA BAND 5	21
8.2.2. WCDMA BAND 2	22
8.2.3. WCDMA BAND 4	23
9. CONDUCTED TEST RESULTS	24
9.1. OCCUPIED BANDWIDTH	24
9.1.1. GSM	26
9.1.2. WCDMA	27
9.2. BAND EDGE AND EMISSION MASK	28
9.2.1. GSM 850	30
9.2.2. GSM 1900	31
9.2.3. WCDMA BAND 5	32
9.2.4. WCDMA BAND 2	33
9.2.5. WCDMA BAND 4	34

9.3. *OUT OF BAND EMISSIONS* 35

9.3.1. GSM 850 36

9.3.2. GSM 1900 37

9.3.3. WCDMA BAND 5 38

9.3.4. WCDMA BAND 2 39

9.3.5. WCDMA BAND 4 40

9.4. *FREQUENCY STABILITY* 41

9.4.1. GSM 42

9.4.2. WCDMA 44

9.5. *PEAK-TO-AVERAGE POWER RATIO* 47

9.5.1. GSM 47

9.5.2. WCDMA 48

10. RADIATED TEST RESULTS **49**

10.1. *FIELD STRENGTH OF SPURIOUS RADIATION, ANT 1* 54

10.1.1. GSM 850 55

10.1.2. GSM 1900 57

10.1.3. WCDMA BAND 5 59

10.1.4. WCDMA BAND 2 61

10.1.5. WCDMA BAND 4 63

10.2. *FIELD STRENGTH OF SPURIOUS RADIATION, ANT 2* 65

10.2.1. GSM 850 65

10.2.2. GSM 1900 67

10.2.3. WCDMA BAND 5 69

10.2.4. WCDMA BAND 2 71

10.2.5. WCDMA BAND 4 73

10.3. *FIELD STRENGTH OF SPURIOUS RADIATION, ANT 3* 75

10.3.1. GSM 1900 75

10.3.2. WCDMA BAND 2 77

10.3.3. WCDMA BAND 4 79

10.4. *FIELD STRENGTH OF SPURIOUS RADIATION, ANT 4* 81



10.4.1. GSM 1900 81

10.4.2. WCDMA BAND 2 83

10.4.3. WCDMA BAND 4 85

11. SETUP PHOTOS **87**

1. ATTESTATION OF TEST RESULTS

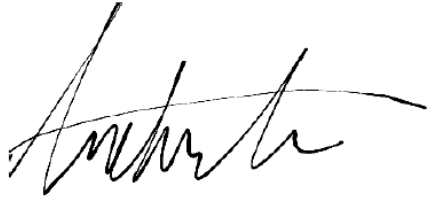
Applicant Name and Address	APPLE, INC 1 APPLE PARK WAY CUPERTINO, CA 95014, U.S.A	
Model	A3105	
Brand	APPLE	
FCC ID	BCG-E8440A	
IC	579C-E8440A	
EUT Description	SMARTPHONE	
Serial Number	Conducted: (YN44MWQV93, R99VXPQQM9, C07GVV005R0000472, C07GVV00560000472) Radiated: (JWDG4123TQ, THL2CQTMHY)	
Sample Receipt Date	2023-03-24	
Date Tested	2023-03-27 to 2023-06-30	
Applicable Standards	FCC 47 CFR Part 2, Part 22, Part 24, and Part 27 ISED RSS-GEN Issue 5, RSS-132 Issue 4, RSS-133 Issue 6, RSS-139 Issue 4.	
Test Results	COMPLIES	
<p>UL Verification Services Inc. tested the above equipment in accordance with the requirements set forth in the above standards. The test results show that the equipment tested is capable of demonstrating compliance with the requirements as documented in this report.</p> <p>The results documented in this report apply only to the tested sample, under the conditions and modes of operation as described herein. It is the manufacturer's responsibility to assure that additional production units of this model are manufactured with identical electrical and mechanical components. All samples tested were in good operating condition throughout the entire test program. Measurement Uncertainties are published for informational purposes only and were not taken into account unless noted otherwise.</p> <p>This document may not be altered or revised in any way unless done so by UL Verification Services Inc and all revisions are duly noted in the revisions section. Any alteration of this document not carried out by UL Verification Services Inc will constitute fraud and shall nullify the document.</p>		
Approved & Released By:	Reviewed By:	Prepared By:
		
Dan Corona Operations Leader UL Verification Services Inc.	Eric Ting Senior Test Engineer UL Verification Services Inc	Eric Ting Laboratory Technician UL Verification Services Inc

2. SUMMARY OF TEST RESULTS

This report contains data provided by the customer which can impact the validity of results. UL Verification Services Inc. is only responsible for the validity of results after the integration of the data provided by the customer.

Requirement Description	Requirement Clause Number (FCC)	Requirement Clause Number (ISED)	Result	Remarks
RF Conducted Output Power	2.1046(b)	-	Complies	
Effective Radiated Power	22.913 (a)(5)	RSS132§5.4	Complies	
Equivalent Isotropic Radiated power	24.232 (c), 27.50 (d) (4)	RSS133§6.4 & SRSP-510, 5.1.2 RSS139§5.5	Complies	
Occupied Bandwidth	2.1049	RSS132 RSS133§2.3 RSS139 RSS-GEN§6.7	Complies	
Band Edge and Emission Mask	2.1051, 22.917 (a), 24.238 (a), 27.53 (h)	RSS132§5.5 RSS133§6.5 RSS139§5.6	Complies	
Out of Band Emissions	2.1051, 22.917 (a), 24.238 (a), 27.53 (h)	RSS132§5.5 RSS133§6.5 RSS139§5.6	Complies	
Frequency Stability	2.1055, 22.355, 24.235, 27.54	RSS132§5.3 RSS133§6.3 RSS139§5.4	Complies	
Peak-to-Average Ratio	22.913 (d), 24.232 (d), 27.50 (d) (5)	RSS132§5.4 RSS133§6.4 RSS139§5.5	Complies	
Field Strength of Spurious Radiation	2.1053, 22.917 (a), 24.238 (a), 27.53 (h)	RSS132§5.5 RSS133§6.5 RSS139§5.6	Complies	

3. TEST METHODOLOGY

The tests documented in this report were performed in accordance with the following:

- ANSI C63.26:2015
- FCC 47 CFR Part 2, Part 22, Part 24, and Part 27
- [FCC KDB 971168 D01 v03r01](#): Power Meas License Digital Systems
- [FCC KDB 971168 D02 v02r02](#): Misc Rev Approv License Devices
- [FCC KDB 412172 D01 v01r01](#): Determining ERP and EIRP
- ISED RSS-Gen Issue 5, RSS-132 Issue 4, RSS-133 Issue 6, RSS-139 Issue 4.

4. FACILITIES AND ACCREDITATION

UL Verification Services Inc. is accredited by A2LA, certification #0751.05, for all testing performed within the scope of this report. Testing was performed at the locations noted below.

	Address	ISED CABID	ISED Company Number	FCC Registration
<input checked="" type="checkbox"/>	Building 1: 47173 Benicia Street, Fremont, CA 94538, USA	US0104	2324A	550739
<input checked="" type="checkbox"/>	Building 2: 47266 Benicia Street, Fremont, CA 94538, USA			
<input type="checkbox"/>	Building 3: 843 Auburn Court, Fremont, CA 94538 USA			
<input checked="" type="checkbox"/>	Building 4: 47658 Kato Rd, Fremont, CA 94538, USA			
<input checked="" type="checkbox"/>	Building 5: 47670 Kato Rd, Fremont, CA 94538 USA			

5. DECISION RULES AND MEASUREMENT UNCERTAINTY

5.1. METROLOGICAL TRACEABILITY

All test and measuring equipment utilized to perform the tests documented in this report are calibrated on a regular basis, with a maximum time between calibrations of one year or the manufacturers' recommendation, whichever is less, and where applicable is traceable to recognized national standards.

5.2. DECISION RULES

The Decision Rule is based on Simple Acceptance in accordance with ISO Guide 98-4:2012 Clause 8.2. (Measurement uncertainty is not taken into account when stating conformity with a specified requirement.)

5.3. MEASUREMENT UNCERTAINTY

PARAMETER	U _{Lab}
Conducted Antenna Port Emission Measurement	1.940 db
Power Spectral Density	2.466 db
Time Domain Measurements Using SA	3.39 %
RF Power Measurement Direct Method Using Power Meter	0.450 db Peak 1.300 db Ave.
Radio Frequency (Spectrum Analyzer)	141.16 Hz
Occupied Bandwidth	1.22%
Worst Case Conducted Disturbance, 9KHz to 0.15 MHz	3.78 db
Worst Case Conducted Disturbance, 0.15 to 30 MHz	3.40 db
Worst Case Radiated Disturbance, 9KHz to 30 MHz	2.87 db
Worst Case Radiated Disturbance, 30 to 1000 MHz	6.01 db
Worst Case Radiated Disturbance, 1000 to 18000 MHz	4.73 db
Worst Case Radiated Disturbance, 18000 to 26000 MHz	4.51 db
Worst Case Radiated Disturbance, 26000 to 40000 MHz	5.29 db

Uncertainty figures are valid to a confidence level of 95%.

5.4. SAMPLE CALCULATION

RADIATED EMISSIONS

Where relevant, the following sample calculation is provided:

Field Strength (dBuV/m) = Measured Voltage (dBuV) + Antenna Factor (dB/m) + Cable Loss (dB) – Preamp Gain (dB)

$$36.5 \text{ dBuV} + 18.7 \text{ dB/m} + 0.6 \text{ dB} - 26.9 \text{ dB} = 28.9 \text{ dBuV/m}$$

6. EQUIPMENT UNDER TEST

6.1. DESCRIPTION OF EUT

The Apple iPhone is a smartphone with cellular GSM, GPRS, EGPRS, UMTS, LTE, 5G NR1, IEEE 802.11a/b/g/n/ac/ax, Bluetooth (BT), Ultra-Wideband (UWB), GPS, NFC, NB UNII, 802.15.4, 802.15.4ab-NB and MSS technologies. The rechargeable battery is not user accessible.

Testing was performed on the parent model and is used to support the application for the parent and variants identified in this report based on the test plan submitted and approved via KDB inquiry by the FCC and by ISED-Canada.

6.2. MAXIMUM OUTPUT POWER

EIRP/ERP TEST PROCEDURE

ANSI C63.26:2015
KDB 971168 D01 Section 5.6

$$\text{ERP/EIRP} = \text{PMeas} + \text{GT} - \text{LC}$$

where: ERP/EIRP = effective or equivalent radiated power, respectively (expressed in the same units as PMeas, typically dBW or dBm);

PMeas = measured transmitter output power or PSD, in dBm or dBW;

GT = gain of the transmitting antenna, in dBd (ERP) or dBi (EIRP);

LC = signal attenuation in the connecting cable between the transmitter and antenna, in dB.

For devices utilizing multiple antennas, KDB 662911 provides guidance for determining the effective array transmit antenna gain term to be used in the above equation.

EUT includes different power levels for head use configuration and body use configuration and the below tables contain the highest of all configurations average conducted and ERP/EIRP output powers as follows:

GSM MODES

Part 22 / RSS 132 850MHz Ant 2								
Frequency range (MHz)	Modulation	Conducted (Average) (dBm)	Antenna Gain (dBi)	Limit (W)	ERP		99% BW (kHz)	Emission Designator
					(dBm)	(W)		
824.2-848.8	GPRS	32.50	-5.10	3.0	25.25	0.335	240.29	240KGXW
	EGPRS	27.00			19.75	0.094	238.63	239KG7W
Part 24 / RSS 133 1900MHz Ant 4								
Frequency range (MHz)	Modulation	Conducted (Average) (dBm)	Antenna Gain (dBi)	Limit (W)	EIRP		99% BW (kHz)	Emission Designator
					(dBm)	(W)		
1850.2-1909.8	GPRS	29.00	0.00	2.0	29.00	0.794	246.83	247KGXW
	EGPRS	24.00			24.00	0.251	242.03	242KG7W

WCDMA MODE

Part 22 / RSS 132 Band 5 Ant 2								
Frequency range (MHz)	Modulation	Conducted (Average) (dBm)	Antenna Gain (dBi)	Limit (W)	ERP		99% BW (kHz)	Emission Designator
					(dBm)	(W)		
826.4-846.6	REL 99	24.70	-5.10	3.0	17.45	0.056	4150	4M15F9W
	HSDPA	23.69			16.44	0.044	4142	4M14F9W
Part 24 / RSS 133 Band 2 Ant 4								
Frequency range (MHz)	Modulation	Conducted (Average) (dBm)	Antenna Gain (dBi)	Limit (W)	EIRP		99% BW (kHz)	Emission Designator
					(dBm)	(W)		
1852.4-1907.6	REL 99	22.90	0.00	2.0	22.90	0.195	4164	4M16F9W
	HSDPA	21.94			21.94	0.156	4150	4M15F9W
Part 27 / RSS 139 Band 4 Ant 4								
Frequency range (MHz)	Modulation	Conducted (Average) (dBm)	Antenna Gain (dBi)	Limit (W)	EIRP		99% BW (kHz)	Emission Designator
					(dBm)	(W)		
1712.4-1752.6	REL 99	22.90	-1.30	1.0	21.60	0.145	4148	4M15F9W
	HSDPA	21.96			20.66	0.116	4167	4M17F9W

6.3. SOFTWARE AND FIRMWARE

The EUT firmware installed during testing was version 0.13.02.

6.4. MAXIMUM ANTENNA GAIN

The antenna(s) gain and type, as provided by the manufacturer' are as follows:

Frequency Band	ANT 1 Antenna Gain (dBi)	ANT 2 Antenna Gain (dBi)	ANT 3 Antenna Gain (dBi)	ANT 4 Antenna Gain (dBi)
GSM850 and WCDMA 5 824 – 849MHz	-5.7	-5.1		
GSM1900 and WCDMA 2 1850 – 1910 MHz	-5.3	-1.1	-0.9	0.0
WCDMA 4 1710 – 1755 MHz	-3.6	-4.6	-3.2	-1.3

6.5. WORST-CASE CONFIGURATION AND MODE

The EUT was investigated in three orthogonal orientations X/Y/Z on all ANT 1, ANT2, ANT3 and ANT4 antennas to determine the worst-case orientation. The following table exhibits the worst-case orientation for different frequency bands. The full tests of the EUT have made upon the orientations that shown in the table below.

Frequency Bands	ANT1	ANT2	ANT3	ANT4
824 – 849 MHz	X	Y	N/A	N/A
1710 – 1915 MHz	Y	X	Y	Y

Based on average conducted output power measurement investigations. The worst-case is Ant1 with the highest power. Therefore, Ant 1 was used to perform all conducted tests.

The worst-case scenario for all measurements as followed:

- GSM GPRS
- GSM EGPRS
- WCDMA REL 99
- WCDMA HSDPA

Radiated spurious emissions were investigated from 9kHz to 30MHz, 30MHz-1GHz and above 18GHz. There were no emissions found with less than 20dB of margin from 9kHz to 30MHz, 30MHz-1GHz and above 18GHz.

For simultaneous transmission of multiple channels in the 2.4GHz/5GH WLAN, UWB, and Cellular bands, tests were conducted for various configurations having the highest power, least separation in frequencies and widest operation bandwidths. No noticeable new emission was found.

6.6. DESCRIPTION OF TEST SETUP

SUPPORT TEST EQUIPMENT						
Description	Manufacturer	Model	Serial Number	FCC ID/ DoC		
Laptop	Apple	MacBook Pro	HRP082673	BCGA1708		
AC/DC adapter	Apple	A1718	C4H64450HH3GN8RA6	--		
I/O CABLES (RF CONDUCTED TEST)						
Cable No.	Port	# of Identical Ports	Connector Type	Cable Type	Cable Length (m)	Remarks
1	AC	3	US 115V	Un-shielded	2.0	N/A
2	USB	1	DC	Un-shielded	1.0	N/A
3	RF In/Out	1	EUT	Un-shielded	0.6	N/A
4	RF In/Out	1	Communication Test Set	Un-shielded	1.2	N/A
5	RF In/Out	1	Barrel	N/A	N/A	N/A
I/O CABLES (RF RADIATED TEST)						
Cable No.	Port	# of Identical Ports	Connector Type	Cable Type	Cable Length (m)	Remarks
1	RF In/Out	1	Antenna	Un-shielded	5.0	N/A

CONDUCTED SETUP

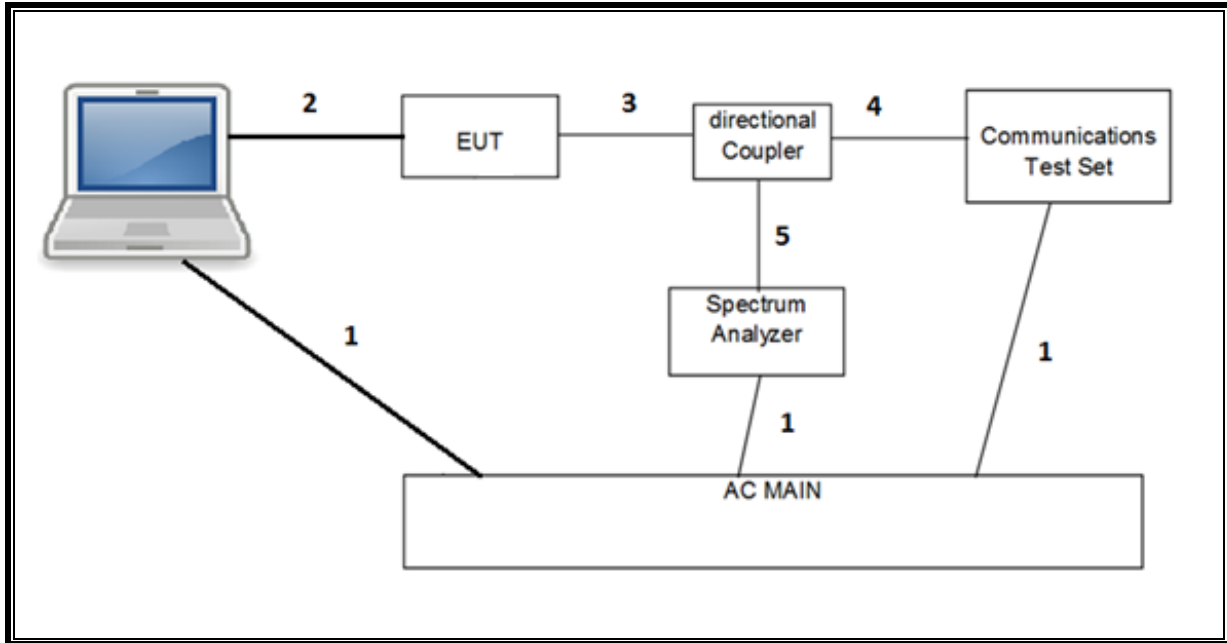

RADIATED SETUP

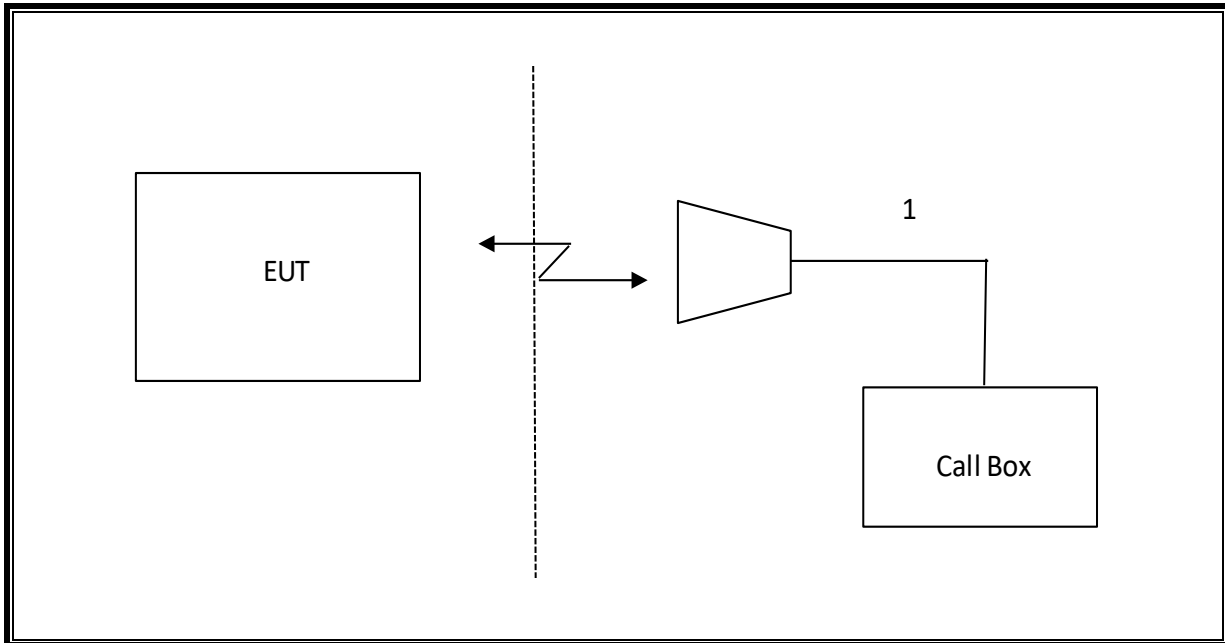

7. TEST AND MEASUREMENT EQUIPMENT

The following test and measurement equipment was utilized for the tests documented in this report:

TEST EQUIPMENT LIST				
Description	Manufacturer	Model	Asset	Cal Due
*Antenna, Horn 1-18GHz	ETS Lindgren	3117	79834	06/08/2203
*Antenna, Broadband Hybrid, 30MHz to 2000MHz	Sunol Sciences	JB3	85151	04/30/2024
Spectrum Analyzer, PXA, 3Hz to 44GHz	Keysight	N9030A	85313	02/29/2024
Spectrum Analyzer, PXA	Keysight	N9030B	222074	07/16/2023
Spectrum Analyzer, PXA, 3Hz to 44GHz	Keysight	N9030A	85201	02/29/2024
Spectrum Analyzer, PXA	Keysight	N9030B	85214	07/18/2023
Spectrum Analyzer, PXA	Keysight	N9030B	222073	07/22/2023
PXA Signal Analyzer	Keysight	N9030B	222073	07/22/2023
EMI TEST RECEIVER	Rohde & Schwarz	ESW44	230548	02/29/2024
EMI TEST RECEIVER	Rohde & Schwarz	ESW44	201498	02/29/2024
Directional Coupler	KRYTAR	152610	198816	09/23/2023
Directional Coupler	KRYTAR	152610	198817	09/23/2023
Directional Coupler	KRYTAR	152610	135712	09/23/2023
Power Meter, P-series single channel	Keysight	N1912A	90630	01/24/2024
Power Meter, P-series single channel	Keysight	N1912A	90719	01/31/2024
Power Meter, P-series single channel	Agilent	N1911A	82174	01/31/2024
Power Sensor, P – series, 50MHz to 18GHz, Wideband	Keysight	N1921A	90389	01/31/2024
Filter, BRF 2495 – 2690 MHz	Micro-Tronics	155050	155055	12/28/2023
Filter, BRF 3.4 – 3.8GHz	Micro-Tronics	208398	208398	08/19/2023
Wideband Communication Test Set, Call Box	Rohde & Schwarz	CMW500	222792	02/29/2024
Wideband Communication Test Set, Call Box	Rohde & Schwarz	CMW500	230298	02/29/2024
Wideband Communication Test Set, Call Box	Rohde & Schwarz	CMW500	230295	02/29/2024
Wideband Communication Test Set, Call Box	Rohde & Schwarz	CMW500	22796	02/29/2024
Wideband Communication Test Set, Call Box	Rohde & Schwarz	CMW500	230297	02/29/2024
*5G NR Communication Test Set, Call Box	Keysight	UXM	207269	01/31/2024
*5G NR Communication Test Set, Call Box	Keysight	UXM	199836	01/31/2024
*Chamber, Environmental	Cincinnati Sub Zero	ZPHS-8-3.5-SCT/WC	82472	11/16/2023
*Amplifier, 218GHz to 26.5GHz	Ampical	AMP18G26.5-60	171583	02/29/2024
*Amplifier, 26.5GHz to 40GHz	Ampical	AMP26G40-65	172346	02/29/2024
Antenna, Horn 18 to 26.5GHz	ARA	MWH-1826/B	172362	03/31/2024
Antenna, Horn 26.5GHz to 40GHz	ARA	MWH-2640/B	172365	03/31/2024
*Antenna, Active Loop 100KHz to 30MHz	ELECTRO-METRICS	EM-6872	219911	05/10/2023
*Antenna, Active Loop 30Hz to 1MHz	ELECTRO-METRICS	EM-6871	219909	05/10/2023
10dB Fixed Attenuator	Pasternack Enterprises	PE7087-10	236360	Verified/Characterized before use
10dB Fixed Attenuator	Pasternack Enterprises	PE7087-10	236285	Verified/Characterized before use
10dB Fixed Attenuator	Pasternack Enterprises	PE7087-10	236355	Verified/Characterized before use
UL AUTOMATION SOFTWARE				
CLT Software	UL	UL RF	Ver 3.4, May 20, 2022	
Power Measurement Software	UL	UL RF	Ver 3.1.4, April 29, 2022	
Radiated test software	UL	UL RF	Ver 9.5, Jan 21, 2022	

NOTES:

1. * Testing is completed before equipment expiration date.
2. ** Equipment listed above that has a calibration due date during the testing period, the testing is completed before equipment expiration date.

8. RF OUTPUT POWER VERIFICATION

EUT includes different power levels for head use configuration and body use configuration and the below tables contain the highest of all configurations average conducted output powers as follows:

8.1. GSM

Using CMW500 Communication Test Set

Function: Menu select > GSM Mobile Station > GSM 850/900/1800/1900

Press **Connection control** to choose the different menus

Press **RESET** > choose all to reset all settings

Connection	Press Signal Off to turn off the signal and change settings Network Support > GSM+GPRS or GSM+EGPRS Main Service > Packet Data Service selection > Test Mode A – Auto Slot Config. off
MS Signal	Press Slot Config bottom on the right twice to select and change the number of time slots and power setting > Slot configuration > Uplink/Gamma > 33 dBm for GPRS 850/900 > 27 dBm for EGPRS 850/900 > 30 dBm for GPRS1800/1900 > 26 dBm for EGPRS1800/1900
BS Signal	Enter the same channel number for TCH channel (test channel) and BCCH channel Frequency Offset > + 0 Hz Mode > BCCH and TCH BCCH Level > -85 dBm (May need to adjust if link is not stable) BCCH Channel > choose desire test channel [Enter the same channel number for TCH channel (test channel) and BCCH channel] Channel Type > Off P0> 4 dB Slot Config > Unchanged (if already set under MS Signal) TCH > choose desired test channel Hopping > Off Main Timeslot > 3 (Default)
Network	Coding Scheme > CS 1 (GPRS) and MCS5 (EGPRS) Bit Stream > 2E9-1PSR Bit Pattern
AF/RF	Enter appropriate offsets for Ext. Att. Output and Ext. Att. Input
Connection	Press Signal On to turn on the signal and change settings

RESULT

8.1.1. GSM 850

Test Engineer ID:	39004	Test Date:	4/14/2023
--------------------------	-------	-------------------	-----------

Mode	Coding Scheme	Time Slots	Ch No.	Freq. (MHz)	Conducted Average Power (dBm)	
					ANT 1	ANT 2
GPRS (GMSK)	CS1	1	128	824.2	33.21	32.09
			190	836.6	32.90	31.77
			251	848.8	33.50	32.50
		2	128	824.2	32.32	31.16
			190	836.6	32.50	31.50
			251	848.8	32.28	31.15
EGPRS (8PSK)	MCS5	1	128	824.2	27.74	26.92
			190	836.6	27.58	26.76
			251	848.8	28.00	27.00
		2	128	824.2	26.92	25.83
			190	836.6	27.00	26.00
			251	848.8	26.83	25.83

8.1.2. GSM 1900

Test Engineer ID:	39004	Test Date:	4/14/2023
--------------------------	-------	-------------------	-----------

Mode	Coding Scheme	Time Slots	Ch No.	Freq. (MHz)	Conducted Average Power (dBm)			
					ANT 1	ANT 2	ANT 3	ANT 4
GPRS (GMSK)	CS1	1	512	1850.2	31.65	29.16	31.50	28.65
			661	1880	31.29	28.81	31.16	28.30
			810	1909.8	32.00	29.50	31.20	29.00
		2	512	1850.2	30.73	28.22	30.35	27.73
			661	1880	31.00	28.50	30.50	28.00
			810	1909.8	30.66	28.15	30.40	27.66
EGPRS (8PSK)	MCS5	1	512	1850.2	27.00	23.99	26.03	23.95
			661	1880	26.65	23.76	26.50	23.74
			810	1909.8	26.86	24.00	26.15	24.00
		2	512	1850.2	25.74	22.75	24.71	22.75
			661	1880	26.00	23.00	25.23	23.00
			810	1909.8	25.76	22.77	25.50	22.77

8.2. WCDMA

TEST PROCEDURE

The transmitter output was connected to the input terminal of Directional Coupler via calibrated coaxial cable. The output coupling terminal of the Directional Coupler was directly connected to a spectrum analyzer while the output through terminal connected to the communication test set via calibrated coaxial cable.

The output power was measured with the spectrum analyzer at the low, middle and high channel in each band.

- Set the spectrum analyzer span wide enough or greater than the modulated signal BW.
- Set a spectrum analyzer at peak detection mode with VBW \geq RBW \geq 26dB BW, typically 5MHz.
- Set a marker to point the corresponding peak value.

REL 99

The following tests were completed according to the test requirements outlined in section 5.2 of the 3GPP TS34.121-1 specification. The DUT supports power Class 3, which has a nominal maximum output power of 24 dBm (+1.7/-3.7).

Mode	Subtest	Rel99
WCDMA General Settings	Loopback Mode	Test Mode 2
	Rel99 RMC	12.2kbps RMC
	Power Control Algorithm	Algorithm2
	β_c/β_d	8/15

HSDPA REL 5

The following 4 Sub-tests were completed according to Release 5 procedures in table C.10.1.4 of 3GPP TS 34.121-1 A summary of these settings are illustrated below:

Table C.10.1.4: β values for transmitter characteristics tests with HS-DPCCH

Sub-test	β_c	β_d	β_d (SF)	β_c/β_d	β_{HS} (Note 1, Note 2)	CM (dB) (Note 3)	MPR (dB) (Note 3)
1	2/15	15/15	64	2/15	4/15	0.0	0.0
2	12/15 (Note 4)	15/15 (Note 4)	64	12/15 (Note 4)	24/15	1.0	0.0
3	15/15	8/15	64	15/8	30/15	1.5	0.5
4	15/15	4/15	64	15/4	30/15	1.5	0.5

Note 1: Δ_{ACK} , Δ_{NACK} and $\Delta_{CQI} = 30/15$ with $\beta_{HS} = 30/15 * \beta_c$.

Note 2: For the HS-DPCCH power mask requirement test in clause 5.2C, 5.7A, and the Error Vector Magnitude (EVM) with HS-DPCCH test in clause 5.13.1A, and HSDPA EVM with phase discontinuity in clause 5.13.1AA, Δ_{ACK} and $\Delta_{NACK} = 30/15$ with $\beta_{HS} = 30/15 * \beta_c$, and $\Delta_{CQI} = 24/15$ with $\beta_{HS} = 24/15 * \beta_c$.

Note 3: CM = 1 for $\beta_c/\beta_d = 12/15$, $\beta_{HS}/\beta_c = 24/15$. For all other combinations of DPDCCH, DPCCH and HS-DPCCH the MPR is based on the relative CM difference. This is applicable for only UEs that support HSDPA in release 6 and later releases.

Note 4: For subtest 2 the β_c/β_d ratio of 12/15 for the TFC during the measurement period (TF1, TF0) is achieved by setting the signalled gain factors for the reference TFC (TF1, TF1) to $\beta_c = 11/15$ and $\beta_d = 15/15$.

HSPA REL 6 (HSDPA & HSUPA)

The following 5 Sub-tests were completed according to Release 6 procedures in table C.11.1.3 of 3GPP TS 34.121-1. A summary of these settings are illustrated below:

Table C.11.1.3: β values for transmitter characteristics tests with HS-DPCCH and E-DCH

Sub-test	β_c	β_d	β_d (SF)	β_c/β_d	β_{HS} (Note 1)	β_{ec}	β_{ed} (Note 4) (Note 5)	β_{ed} (SF)	β_{ed} (Codes)	CM (dB) (Note 2)	MPR (dB) (Note 2) (Note 6)	AG Index (Note 5)	E-TFCI
1	11/15 (Note 3)	15/15 (Note 3)	64	11/15 (Note 3)	22/15	209/25	1309/225	4	1	1.0	0.0	20	75
2	6/15	15/15	64	6/15	12/15	12/15	94/75	4	1	3.0	2.0	12	67
3	15/15	9/15	64	15/9	30/15	30/15	β_{ed1} : 47/15 β_{ed2} : 47/15	4	2	2.0	1.0	15	92
4	2/15	15/15	64	2/15	4/15	2/15	56/75	4	1	3.0	2.0	17	71
5	15/15	0	-	-	5/15	5/15	47/15	4	1	1.0	0.0	12	67

Note 1: For sub-test 1 to 4, Δ_{ACK} , Δ_{NACK} and $\Delta_{CQI} = 30/15$ with $\beta_{hs} = 30/15 * \beta_c$. For sub-test 5, Δ_{ACK} , Δ_{NACK} and $\Delta_{CQI} = 5/15$ with $\beta_{hs} = 5/15 * \beta_c$.

Note 2: CM = 1 for $\beta_c/\beta_d = 12/15$, $\beta_{hs}/\beta_c = 24/15$. For all other combinations of DPDCH, DPCCH, HS-DPCCH, E-DPDCH and E-DPCCH the MPR is based on the relative CM difference.

Note 3: For subtest 1 the β_c/β_d ratio of 11/15 for the TFC during the measurement period (TF1, TF0) is achieved by setting the signalled gain factors for the reference TFC (TF1, TF1) to $\beta_c = 10/15$ and $\beta_d = 15/15$.

Note 4: In case of testing by UE using E-DPDCH Physical Layer category 1, Sub-test 3 is omitted according to TS25.306 Table 5.1g.

Note 5: β_{ed} can not be set directly; it is set by Absolute Grant Value.

Note 6: For subtests 2, 3 and 4, UE may perform E-DPDCH power scaling at max power which could results in slightly smaller MPR values.

DUAL CARRIER HSDPA (DC-HSDPA (REL 8, CAT 24))

The following 4 Sub-tests for DC-HSDPA were completed according to Release 8 procedures in table C08.1.12 of 3GPP TS 34.121-1. A summary of subtest settings are illustrated below:

Table C.8.1.12: Fixed Reference Channel H-Set 12

Parameter	Unit	Value
Nominal Avg. Inf. Bit Rate	kbps	60
Inter-TTI Distance	TTI's	1
Number of HARQ Processes	Processes	6
Information Bit Payload (N_{INF})	Bits	120
Number Code Blocks	Blocks	1
Binary Channel Bits Per TTI	Bits	960
Total Available SML's in UE	SML's	19200
Number of SML's per HARQ Proc.	SML's	3200
Coding Rate		0.15
Number of Physical Channel Codes	Codes	1
Modulation		QPSK
<p>Note 1: The RMC is intended to be used for DC-HSDPA mode and both cells shall transmit with identical parameters as listed in the table.</p> <p>Note 2: Maximum number of transmission is limited to 1, i.e., retransmission is not allowed. The redundancy and constellation version 0 shall be used.</p>		

HSPA+ REL 7

The following 1 Sub-test was completed according to Release 7 procedures in table C.11.1.4 of 3GPP TS34.121. A summary of these settings are illustrated below:

Table C.11.1.4: β values for transmitter characteristics tests with HS-DPCCH and E-DCH with 16QAM

Sub-test	β_c (Note3)	β_d	β_{HS} (Note1)	β_{ec}	β_{ed} (2xSF2) (Note 4)	β_{ed} (2xSF4) (Note 4)	CM (dB) (Note 2)	MPR (dB) (Note 2)	AG Index (Note 4)	E-TFCI (Note 5)	E-TFCI (boost)
1	1	0	30/15	30/15	β_{ed1} : 30/15 β_{ed2} : 30/15	β_{ed3} : 24/15 β_{ed4} : 24/15	3.5	2.5	14	105	105

Note 1: $\Delta_{ACK}, \Delta_{NACK}$ and $\Delta_{CQI} = 30/15$ with $\beta_{hs} = 30/15 * \beta_c$.

Note 2: CM = 3.5 and the MPR is based on the relative CM difference, MPR = MAX(CM-1,0).

Note 3: DPDCH is not configured, therefore the β_c is set to 1 and $\beta_d = 0$ by default.

Note 4: β_{ed} can not be set directly; it is set by Absolute Grant Value.

Note 5: All the sub-tests require the UE to transmit 2SF2+2SF4 16QAM EDCH and they apply for UE using E-DPDCH category 7. E-DCH TTI is set to 2ms TTI and E-DCH table index = 2. To support these E-DCH configurations DPDCH is not allocated. The UE is signalled to use the extrapolation algorithm.

RESULT

8.2.1. WCDMA BAND 5

Test Engineer ID:	39004	Test Date:	4/18/2023
-------------------	-------	------------	-----------

Band	Mode		UL Ch No.	Freq. (MHz)	MPR (dB)	Conducted Average Power (dBm)		
						ANT 1	ANT 2	
W-CDMA Band 5 (850MHz)	Rel 99	RMC, 12.2 kbps	4132	826.4	N/A	25.63	24.67	
			4183	836.6	N/A	25.70	24.70	
			4233	846.6	N/A	25.66	24.65	
	HSDPA	Subtest 1	4132	826.4	0	24.66	23.65	
			4183	836.6	0	24.68	23.67	
			4233	846.6	0	24.62	23.64	
		Subtest 2	4132	826.4	0	24.68	23.69	
			4183	836.6	0	24.69	23.69	
			4233	846.6	0	24.64	23.65	
		Subtest 3	4132	826.4	0.5	24.20	23.22	
			4183	836.6	0.5	24.19	23.21	
			4233	846.6	0.5	24.15	23.15	
		Subtest 4	4132	826.4	0.5	24.16	23.16	
			4183	836.6	0.5	24.19	23.19	
			4233	846.6	0.5	24.13	23.16	
		HSPA (HSDPA & HSUPA)	Subtest 1	4132	826.4	0	24.65	23.66
				4183	836.6	0	24.68	23.70
				4233	846.6	0	24.65	23.68
	Subtest 2		4132	826.4	2	22.65	21.66	
			4183	836.6	2	22.71	21.73	
			4233	846.6	2	22.64	21.67	
	Subtest 3		4132	826.4	1	23.60	22.68	
			4183	836.6	1	23.66	22.72	
			4233	846.6	1	23.64	22.70	
	Subtest 4		4132	826.4	2	22.64	21.70	
			4183	836.6	2	22.67	21.72	
			4233	846.6	2	22.62	21.68	
	Subtest 5		4132	826.4	0	24.19	23.26	
			4183	836.6	0	24.26	23.30	
			4233	846.6	0	24.20	23.28	
	DC-HSDPA	Subtest 1	4132	826.4	0	24.62	23.73	
			4183	836.6	0	24.65	23.78	
			4233	846.6	0	24.62	23.70	
		Subtest 2	4132	826.4	0	24.66	23.75	
			4183	836.6	0	24.65	23.76	
			4233	846.6	0	24.64	23.73	
		Subtest 3	4132	826.4	0.5	24.15	23.28	
			4183	836.6	0.5	24.18	23.28	
			4233	846.6	0.5	24.14	23.24	
		Subtest 4	4132	826.4	0.5	24.16	23.24	
			4183	836.6	0.5	24.15	23.25	
			4233	846.6	0.5	24.12	23.21	

8.2.2. WCDMA BAND 2

Test Engineer ID:	28567	Test Date:	3/9/2023
-------------------	-------	------------	----------

Band	Mode		UL Ch No.	Freq. (MHz)	MPR (dB)	Conducted Average Power (dBm)				
						ANT 1	ANT2	ANT3	ANT 4	
W-CDMA Band 2 (1900MHz)	Rel 99	RMC, 12.2 kbps	9262	1852.4	N/A	25.70	23.40	25.50	22.90	
			9400	1880.0	N/A	25.55	23.24	25.46	22.86	
			9538	1907.6	N/A	25.46	23.13	25.37	22.76	
	HSDPA	Subtest 1	9262	1852.4	0	24.73	22.43	24.52	21.94	
			9400	1880.0	0	24.56	22.22	24.44	21.83	
			9538	1907.6	0	24.45	22.11	24.37	21.75	
		Subtest 2	9262	1852.4	0	24.69	22.39	24.52	21.94	
			9400	1880.0	0	24.55	22.20	24.43	21.85	
			9538	1907.6	0	24.46	22.16	24.34	21.75	
		Subtest 3	9262	1852.4	0.5	24.04	21.95	24.01	21.36	
			9400	1880.0	0.5	24.03	21.71	23.95	21.34	
			9538	1907.6	0.5	23.98	21.65	23.85	21.27	
		Subtest 4	9262	1852.4	0.5	24.21	21.94	24.01	21.44	
			9400	1880.0	0.5	24.06	21.73	23.95	21.34	
			9538	1907.6	0.5	23.97	21.63	23.84	21.27	
		HSPA (HSDPA & HSUPA)	Subtest 1	9262	1852.4	0	24.70	22.43	24.49	21.93
				9400	1880.0	0	24.59	22.28	24.47	21.90
				9538	1907.6	0	24.47	22.16	24.39	21.80
	Subtest 2		9262	1852.4	2	22.69	20.42	22.50	19.93	
			9400	1880.0	2	22.58	20.29	22.46	19.85	
			9538	1907.6	2	22.44	20.16	22.39	19.81	
	Subtest 3		9262	1852.4	1	23.69	21.43	23.48	20.92	
			9400	1880.0	1	23.56	21.24	23.47	20.94	
			9538	1907.6	1	23.42	21.16	23.37	20.80	
	Subtest 4		9262	1852.4	2	22.68	20.44	22.52	19.97	
			9400	1880.0	2	22.54	20.24	22.49	19.90	
			9538	1907.6	2	22.44	20.18	22.37	19.78	
	Subtest 5		9262	1852.4	0	24.24	22.02	24.04	21.48	
			9400	1880.0	0	24.12	21.83	24.02	21.49	
			9538	1907.6	0	24.00	21.78	23.93	21.37	
	DC-HSDPA	Subtest 1	9262	1852.4	0	24.51	22.55	24.50	22.09	
			9400	1880.0	0	24.33	22.38	24.49	22.05	
			9538	1907.6	0	24.23	22.34	24.42	21.79	
		Subtest 2	9262	1852.4	0	24.47	22.60	24.48	21.92	
			9400	1880.0	0	24.31	22.40	24.48	21.90	
			9538	1907.6	0	24.22	22.33	24.37	21.81	
		Subtest 3	9262	1852.4	0.5	24.02	22.05	24.04	21.43	
			9400	1880.0	0.5	23.80	21.87	23.98	21.39	
			9538	1907.6	0.5	23.72	21.81	23.94	21.31	
		Subtest 4	9262	1852.4	0.5	23.99	22.08	24.04	21.43	
			9400	1880.0	0.5	23.80	21.84	23.98	21.38	
			9538	1907.6	0.5	23.73	21.82	23.89	21.33	

8.2.3. WCDMA BAND 4

Test Engineer ID:	39004	Test Date:	4/18/2023
-------------------	-------	------------	-----------

Band	Mode		UL Ch No.	Freq. (MHz)	MPR (dB)	Conducted Average Power (dBm)				
						ANT 1	ANT2	ANT3	ANT4	
W-CDMA Band 4 (1700MHz)	Rel 99	RMC, 12.2 kbps	1312	1712.4	N/A	25.56	23.25	25.48	22.90	
			1413	1732.6	N/A	25.58	23.26	25.46	22.89	
			1513	1752.6	N/A	25.70	23.40	25.50	22.87	
	HSDPA	Subtest 1	1312	1712.4	0	24.59	22.25	24.52	21.88	
			1413	1732.6	0	24.57	22.26	24.46	21.90	
			1513	1752.6	0	24.69	22.40	24.47	21.91	
		Subtest 2	1312	1712.4	0	24.57	22.33	24.50	21.96	
			1413	1732.6	0	24.54	22.28	24.42	21.84	
			1513	1752.6	0	24.68	22.40	24.47	21.86	
		Subtest 3	1312	1712.4	0.5	24.04	21.82	23.96	21.40	
			1413	1732.6	0.5	24.06	21.76	23.96	21.34	
			1513	1752.6	0.5	24.19	21.91	23.97	21.34	
		Subtest 4	1312	1712.4	0.5	24.06	21.78	24.03	21.44	
			1413	1732.6	0.5	24.08	21.79	23.94	21.37	
			1513	1752.6	0.5	24.18	21.93	23.96	21.35	
		HSPA (HSDPA & HSUPA)	Subtest 1	1312	1712.4	0	24.57	22.28	24.50	21.90
				1413	1732.6	0	24.62	22.30	24.55	21.86
				1513	1752.6	0	24.73	22.44	24.53	21.87
	Subtest 2		1312	1712.4	2	22.55	20.28	22.49	19.92	
			1413	1732.6	2	22.58	20.33	22.50	19.89	
			1513	1752.6	2	22.69	20.44	22.56	19.93	
	Subtest 3		1312	1712.4	1	23.56	21.26	23.48	20.96	
			1413	1732.6	1	23.61	21.26	23.51	20.97	
			1513	1752.6	1	23.71	21.41	23.56	20.97	
	Subtest 4		1312	1712.4	2	22.60	20.28	22.52	19.99	
			1413	1732.6	2	22.63	20.30	22.50	19.95	
			1513	1752.6	2	22.70	20.45	22.57	19.99	
	Subtest 5		1312	1712.4	0	24.11	21.81	24.03	21.52	
			1413	1732.6	0	24.23	21.81	24.07	21.53	
			1513	1752.6	0	24.29	21.96	24.08	21.48	
	DC-HSDPA	Subtest 1	1312	1712.4	0	24.56	22.40	24.53	22.04	
			1413	1732.6	0	24.60	22.42	24.51	22.05	
			1513	1752.6	0	24.71	22.55	24.49	22.04	
		Subtest 2	1312	1712.4	0	24.57	22.38	24.55	22.11	
			1413	1732.6	0	24.57	22.38	24.45	22.00	
			1513	1752.6	0	24.68	22.55	24.44	22.01	
		Subtest 3	1312	1712.4	0.5	24.05	21.93	23.98	21.54	
			1413	1732.6	0.5	24.10	21.88	23.92	21.51	
			1513	1752.6	0.5	24.19	22.04	23.95	21.52	
		Subtest 4	1312	1712.4	0.5	24.09	21.95	24.04	21.59	
			1413	1732.6	0.5	24.09	21.91	23.94	21.55	
			1513	1752.6	0.5	24.19	22.04	23.96	21.53	

9. CONDUCTED TEST RESULTS

9.1. OCCUPIED BANDWIDTH

RULE PART(S)

FCC: §2.1049
ISED: RSS132; RSS133§2.3; RSS139

LIMITS

For reporting purposes only.

TEST PROCEDURE

The transmitter output was connected to a calibrated coaxial cable and coupler, the other end of which was connected to a spectrum analyzer. The occupied bandwidth was measured with the spectrum analyzer at the middle channel in each band. The 99% and -26dB bandwidths was also measured and recorded.

RESULTS

There is no limit required and power is the same for low, middle and high channel; therefore, only middle channel was tested.

GSM

Band	Modulation	Channel	f(MHz)	99% BW (kHz)	-26dB BW (kHz)
850	GPRS	190	836.6	240.29	317.60
	EGPRS			238.63	309.50
1900	GPRS	661	1880.0	246.83	316.20
	EGPRS			242.03	316.10

WCDMA

Band	Modulation	Channel	f(MHz)	99% BW (MHz)	-26dB BW (MHz)
BAND 5	REL 99	4408	836.6	4.1497	4.693
	HSDPA			4.1418	4.687
BAND 2	REL 99	9800	1880.0	4.1637	4.702
	HSDPA			4.1502	4.713
BAND 4	REL 99	1638	1732.6	4.1475	4.709
	HSDPA			4.1667	4.707

9.1.1. GSM

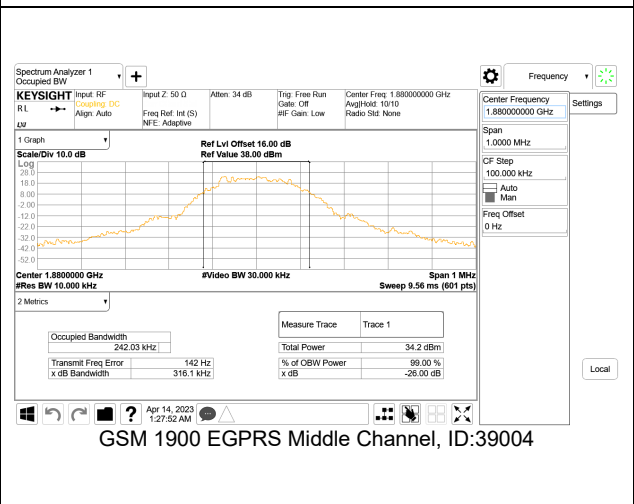
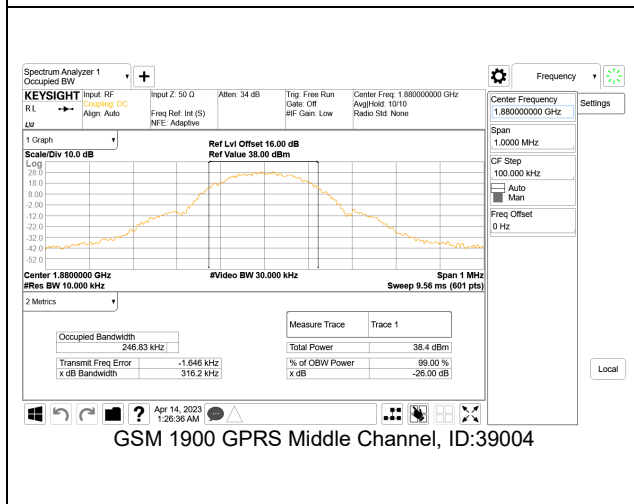
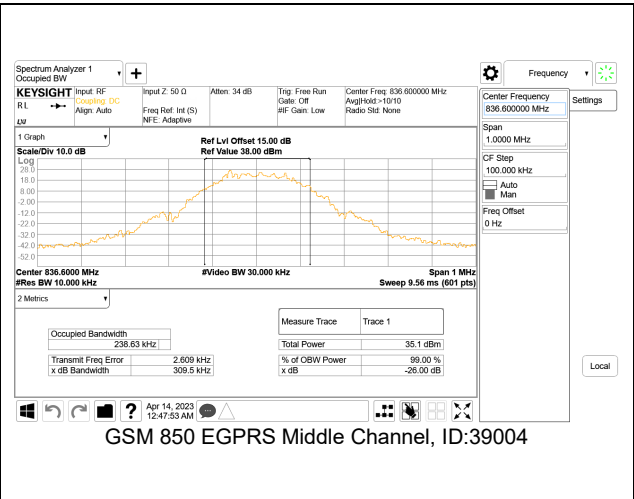
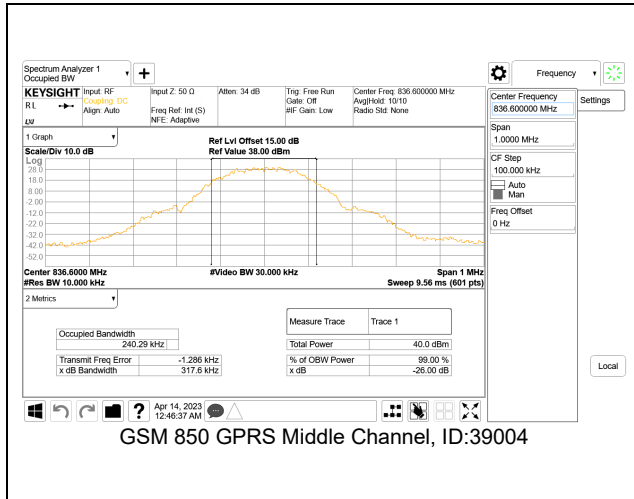

9.1.2. WCDMA

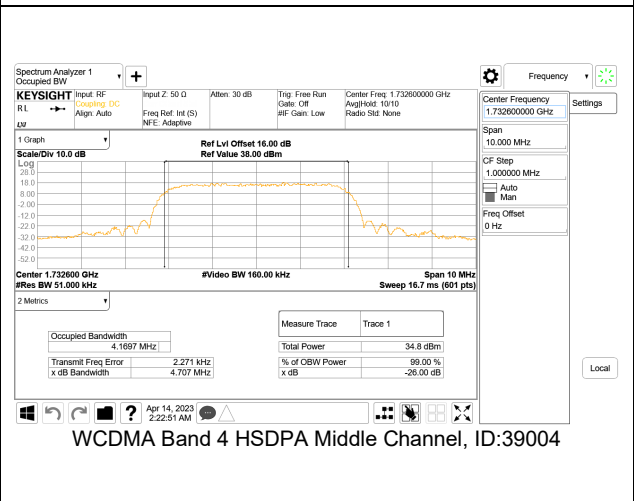
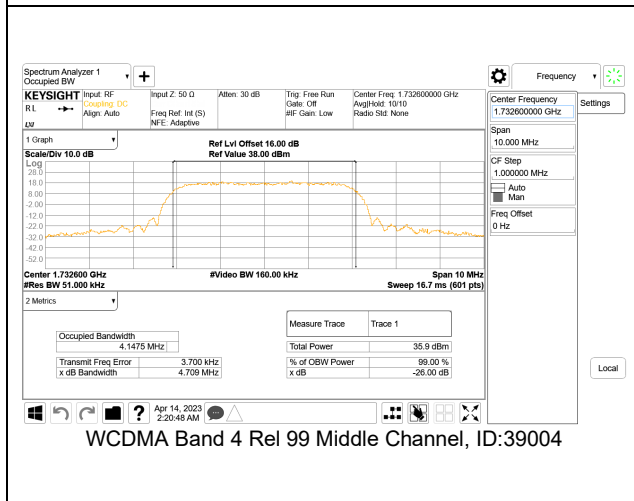
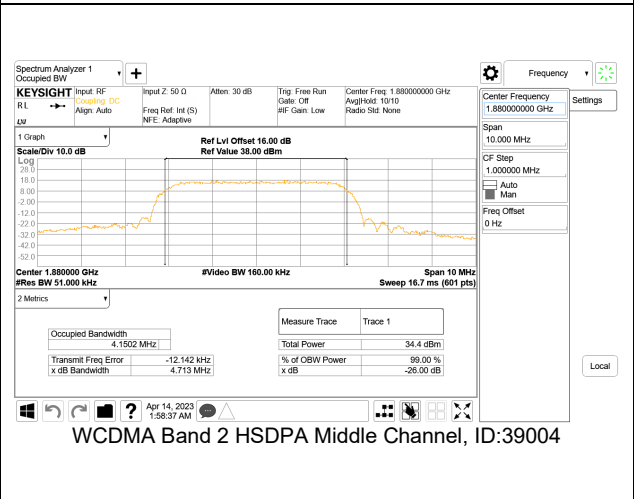
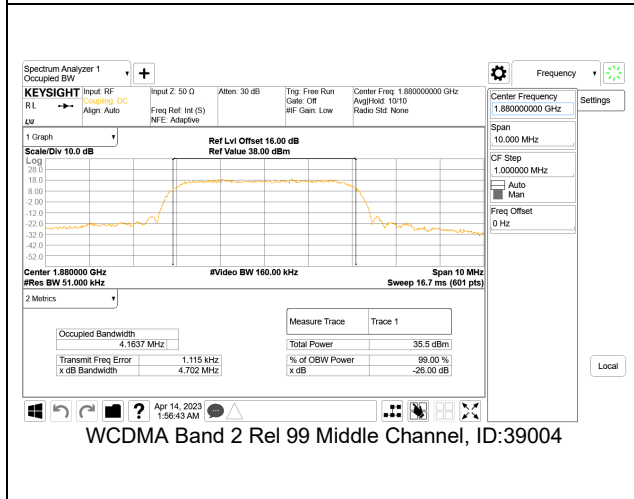
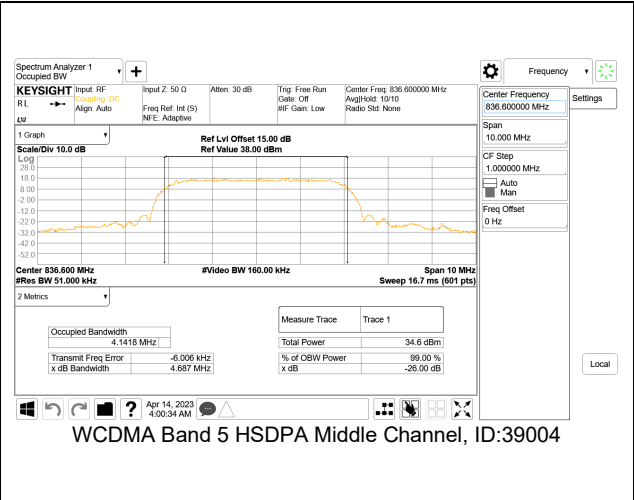
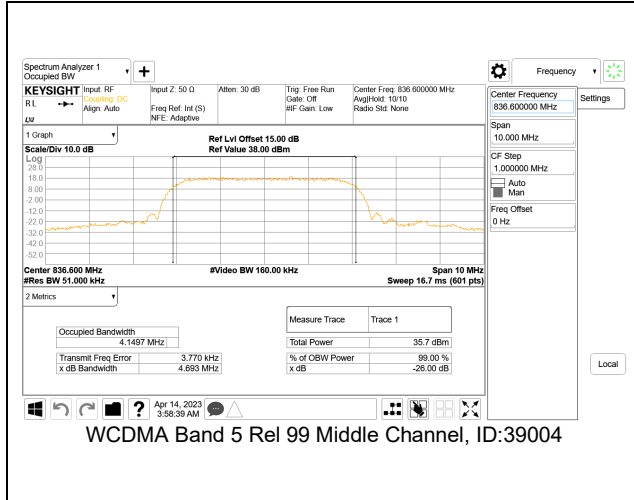

9.2. BAND EDGE AND EMISSION MASK

LIMITS

FCC: §22.917(a), §24.238, §27.53 (h)

The power of any emission outside of the authorized operating frequency ranges must be attenuated below the transmitting power (P) by a factor of at least $43 + 10 \log (P)$ dB.

(1) For any frequency removed from the EA licensee's frequency block by up to and including 37.5 kHz, the power of any emission shall be attenuated below the transmitter power (P) in watts by at least $116 \text{ Log}_{10}(f/6.1)$ decibels or $50 + 10 \text{ Log}_{10}(P)$ decibels or 80 decibels, whichever is the lesser attenuation, where f is the frequency removed from the center of the outer channel in the block in kilohertz and where f is greater than 12.5 kHz.

(2) For any frequency removed from the EA licensee's frequency block greater than 37.5 kHz, the power of any emission shall be attenuated below the transmitter power (P) in watts by at least $43 + 10 \text{ Log}_{10}(P)$ decibels or 80 decibels, whichever is the lesser attenuation, where f is the frequency removed from the center of the outer channel in the block in kilohertz and where f is greater than 37.5 kHz.

RSS132§5.5

Mobile and base station equipment shall comply with the limits in (i) and (ii) below.

- (i) In the first 1.0 MHz band immediately outside and adjacent to each of the sub-bands specified in Section 5.1, the power of emissions per any 1% of the occupied bandwidth shall be attenuated (in dB) below the transmitter output power P (dBW) by at least $43 + 10 \log_{10}p$ (watts).
- (ii) After the first 1.0 MHz immediately outside and adjacent to each of the sub-bands, the power of emissions in any 100 kHz bandwidth shall be attenuated (in dB) below the transmitter output power P (dBW) by at least $43 + 10 \log_{10} p$ (watts). If the measurement is performed using 1% of the occupied bandwidth, power integration over 100 kHz is required.

p is the output power specified in watts.

RSS133§6.5.1

Equipment shall comply with the limits in (i) and (ii) below.

- (i) In the 1.0 MHz bands immediately outside and adjacent to the equipment's operating frequency block, the emission power per any 1% of the emission bandwidth shall be attenuated (in dB) below the transmitter output power P (dBW) by at least $43 + 10 \log_{10}p$ (watts).
- (ii) After the first 1.0 MHz, the emission power in any 1 MHz bandwidth shall be attenuated (in dB) below the transmitter output power P (dBW) by at least $43 + 10 \log_{10}p$ (watts). If the measurement is performed using 1% of the emission bandwidth, power integration over 1.0 MHz is required.

RSS139§5.6

- (i) In the first 1.0 MHz bands immediately outside and adjacent to the equipment's smallest operating frequency block, Footnote 2 which can contain the equipment's occupied bandwidth, the emission power per any 1% of the emission bandwidth shall be attenuated below the transmitter output power P (in dBW) by at least $43 + 10 \log_{10} p$ (watts) dB.
- (ii) After the first 1.0 MHz outside the equipment's smallest operating frequency block, which can contain the equipment's occupied bandwidth, the emission power in any 1 MHz bandwidth shall be attenuated below the transmitter output power P (in dBW) by at least $43 + 10 \log_{10} p$ (watts) dB.

TEST PROCEDURE

The transmitter output was connected to a R&S CMW500 Test Set and configured to operate at maximum power. The band edge emissions were measured at the required operating frequencies in each band on the Spectrum Analyzer.

For each band edge measurement:

- Set the spectrum analyzer span to include the block edge frequency.
- Set a marker to point the corresponding band edge frequency in each test case.
- Set display line at -13 dBm
- Set resolution bandwidth to at least 1% of emission bandwidth.

RESULTS

9.2.1. GSM 850

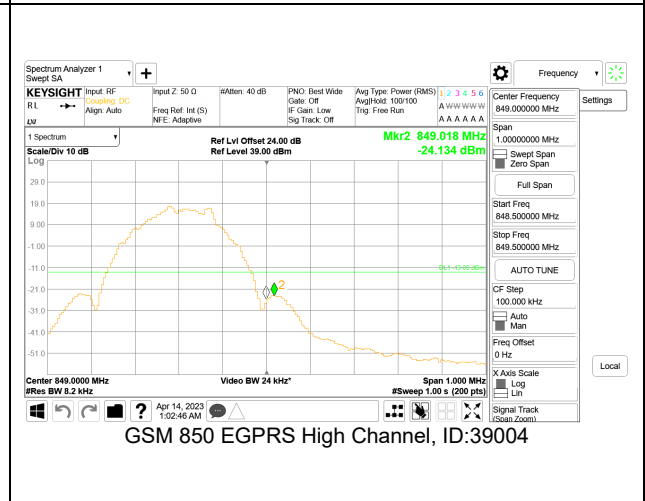
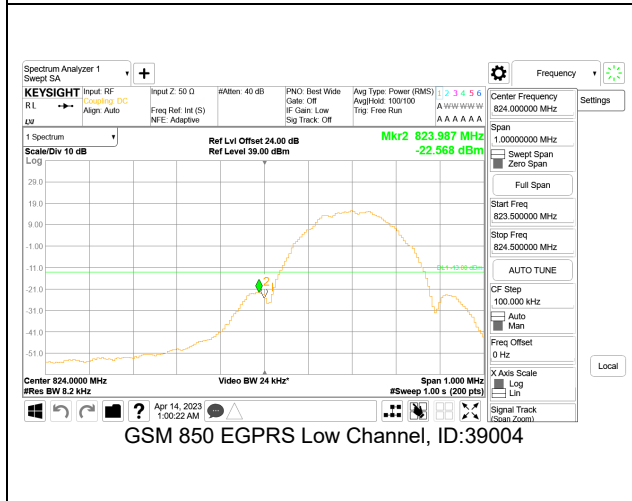
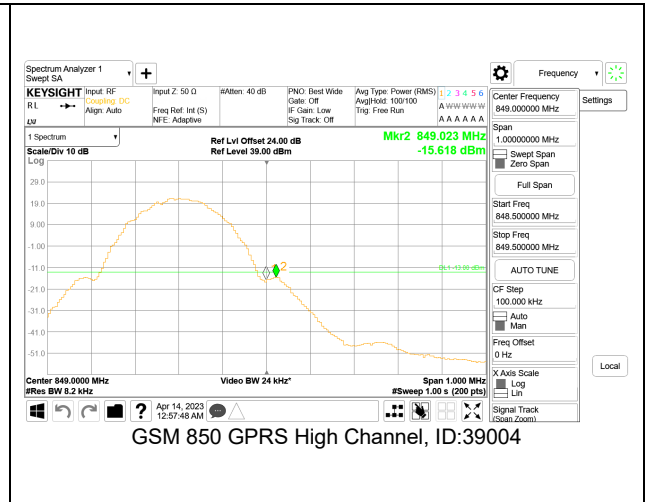
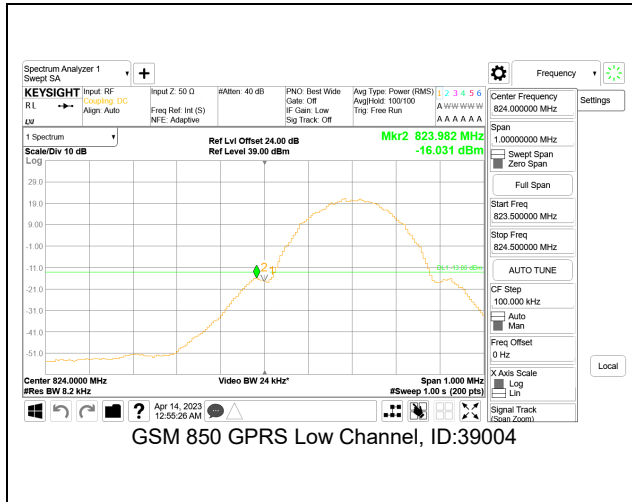

9.2.2. GSM 1900

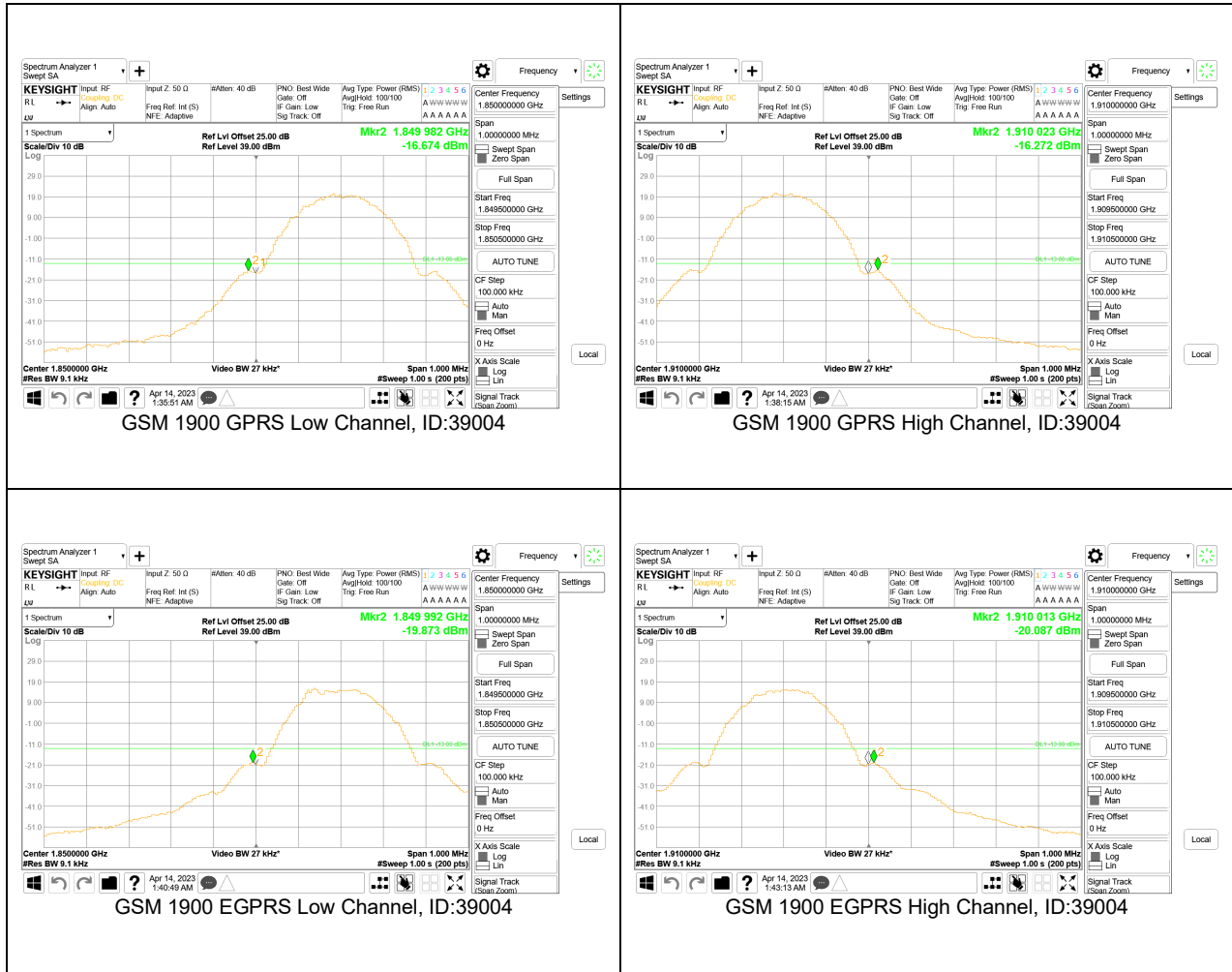

9.2.3. WCDMA BAND 5

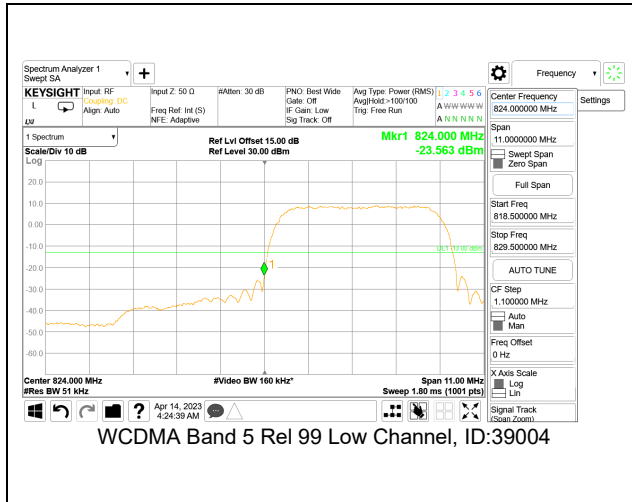

WCDMA Band 5 Rel 99 Low Channel, ID:39004

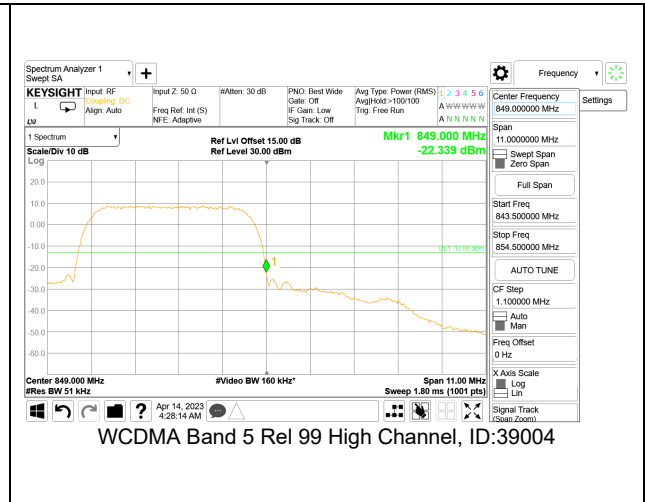

WCDMA Band 5 Rel 99 High Channel, ID:39004

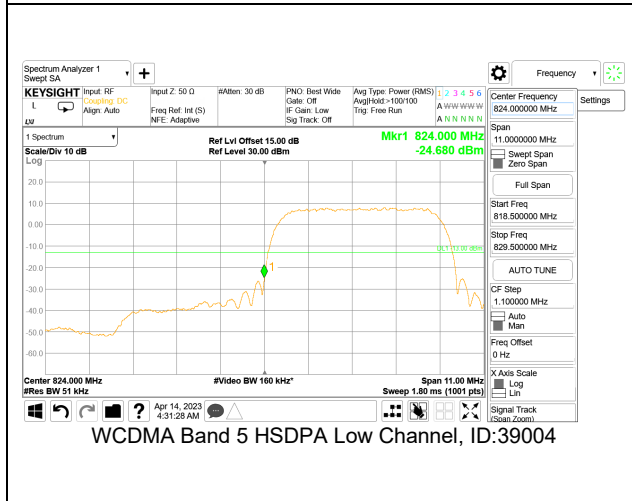

WCDMA Band 5 HSDPA Low Channel, ID:39004

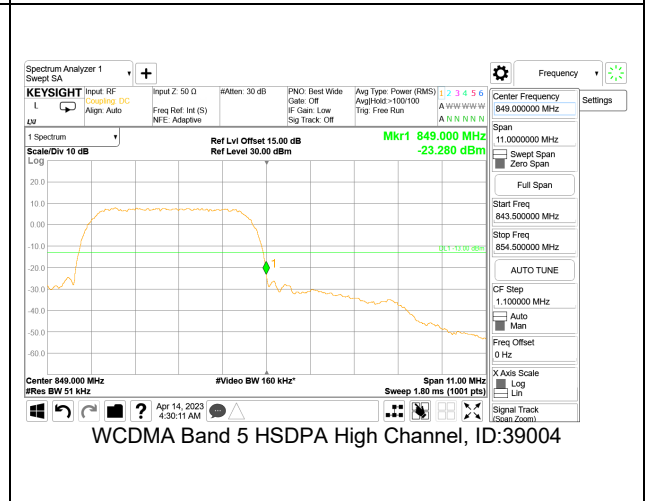

WCDMA Band 5 HSDPA High Channel, ID:39004

9.2.4. WCDMA BAND 2

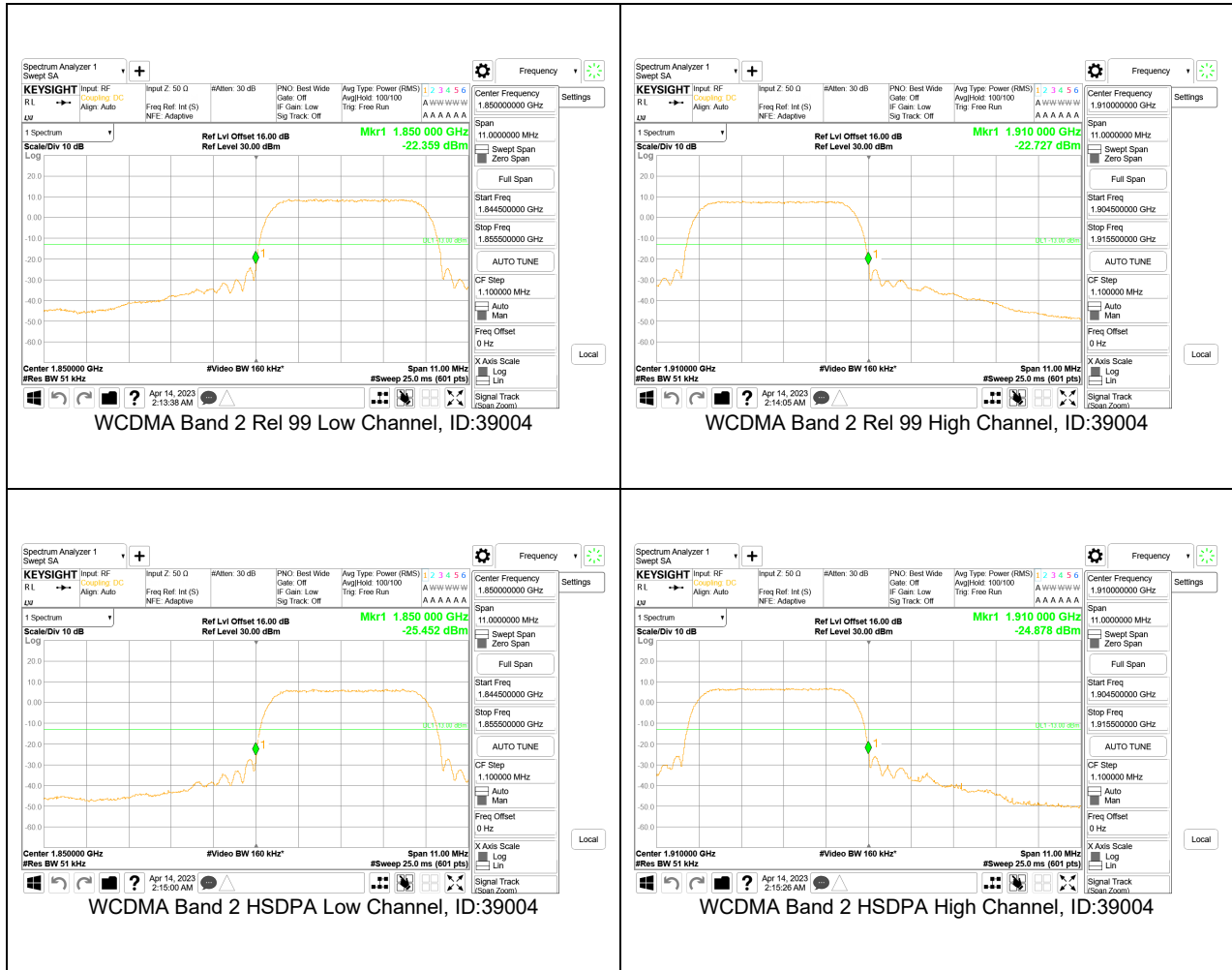

9.2.5. WCDMA BAND 4

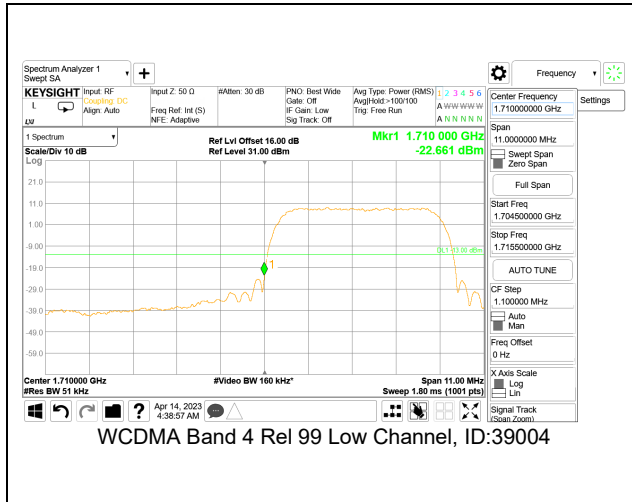

WCDMA Band 4 Rel 99 Low Channel, ID:39004

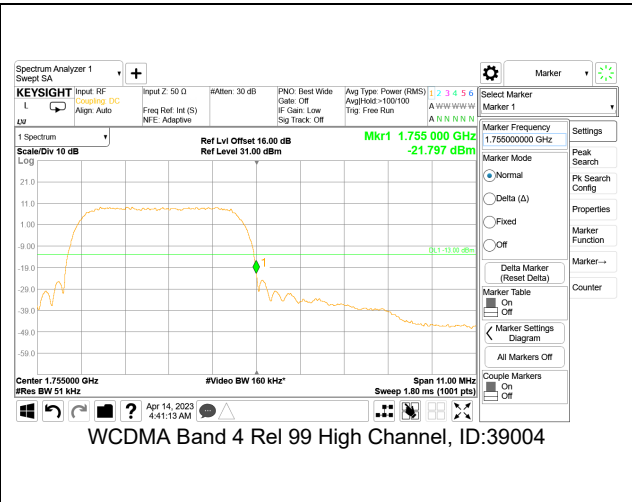

WCDMA Band 4 Rel 99 High Channel, ID:39004

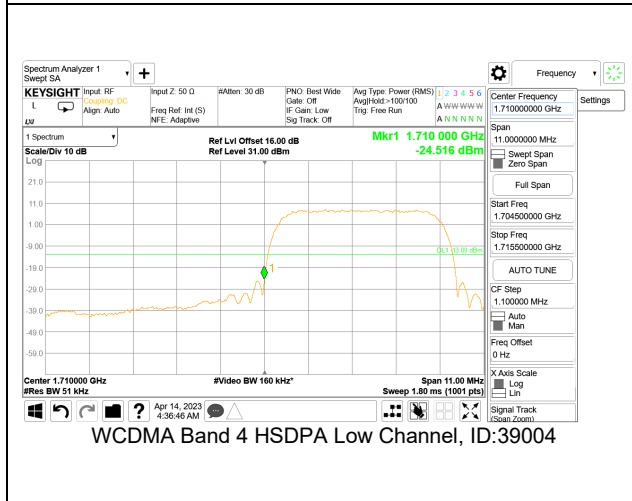

WCDMA Band 4 HSDPA Low Channel, ID:39004

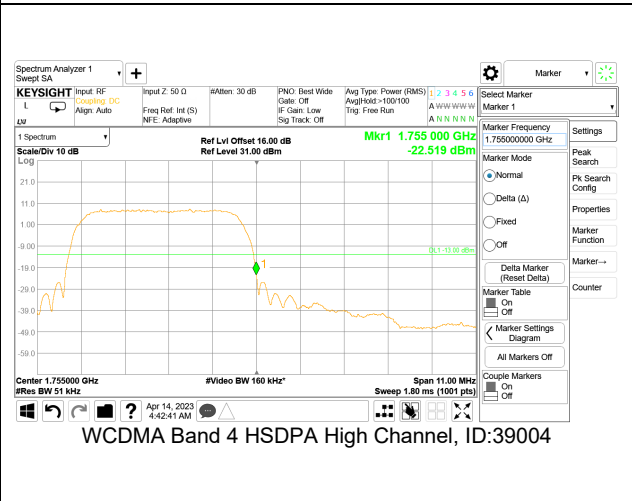

WCDMA Band 4 HSDPA High Channel, ID:39004

9.3. OUT OF BAND EMISSIONS

RULE PART(S)

FCC: §2.1051, §22.917, §24.238, and §27.53
ISED: RSS132§5.5; RSS133§6.5 and RSS139§5.6

LIMITS

FCC: §22.917(a), §24.238, §27.53 (h)

The minimum permissible attenuation level of any spurious emissions is $43 + 10 \log (P)$ dB where transmitting power (P) in Watts.

RSS132§5.5, RSS133§6.5.1, RSS139§5.6

The minimum permissible attenuation level of any spurious emissions is $43 + 10 \log (P)$ dB where transmitting power (P) in Watts.

TEST PROCEDURE

The RF output of the transmitter was connected to a spectrum analyzer through a calibrated coaxial cable. Sufficient scans were taken to show the out-of-band Emissions, if any, up to 10th harmonic. Multiple sweeps were recorded in maximum hold mode using a peak detector to ensure that the worst-case emissions were caught.

For each out of band emissions measurement:

- Set display line at -13 dBm
- Set RBW & VBW to 100 kHz for the measurement below 1 GHz, and 1 MHz for the measurement above 1 GHz.
(NOTE: Worst case set RBW/VBW to 1MHz/3MHz)

RESULTS

9.3.1. GSM 850

