

5G NR n7 35MHz BPSK Low Channel RB1-0, ID:28498

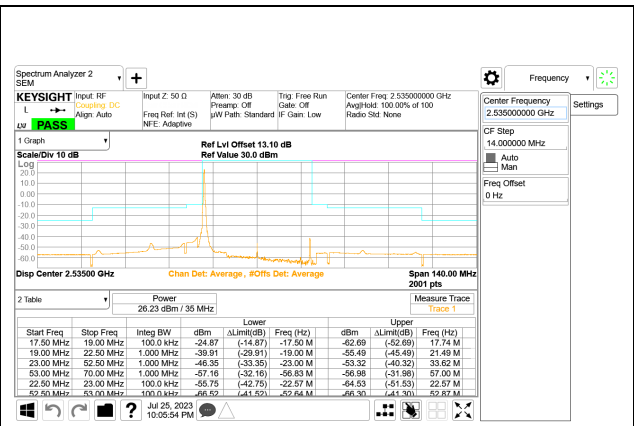

5G NR n7 35MHz BPSK Middle Channel RB1-0, ID:28498

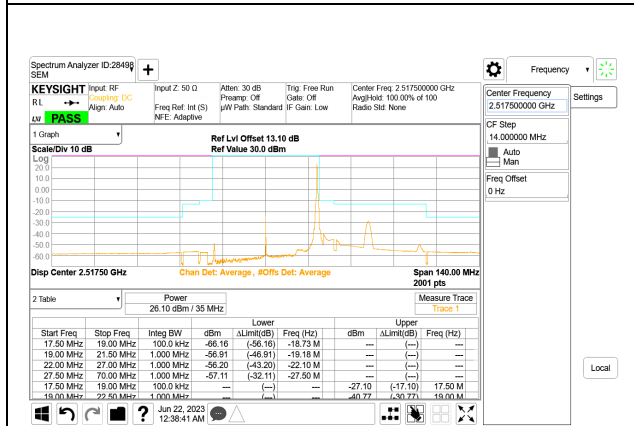

5G NR n7 35MHz BPSK Low Channel RB1-187

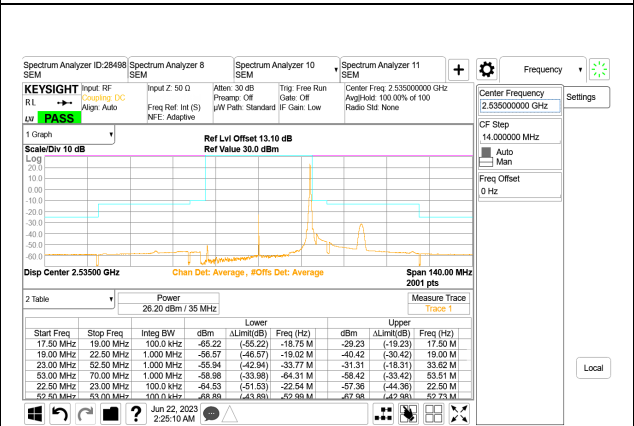

5G NR n7 35MHz BPSK Middle Channel RB1-187

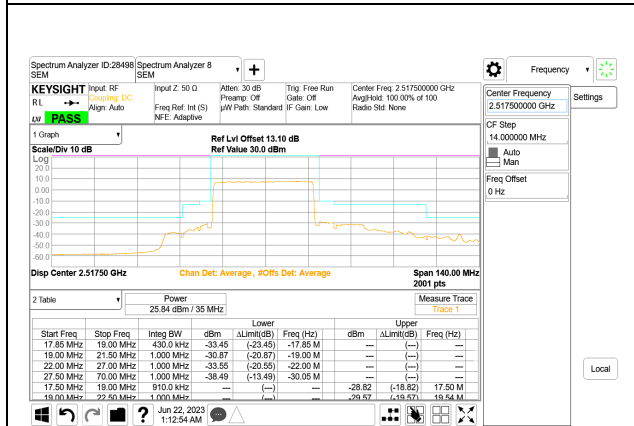

5G NR n7 35MHz BPSK Low Channel RB180-0

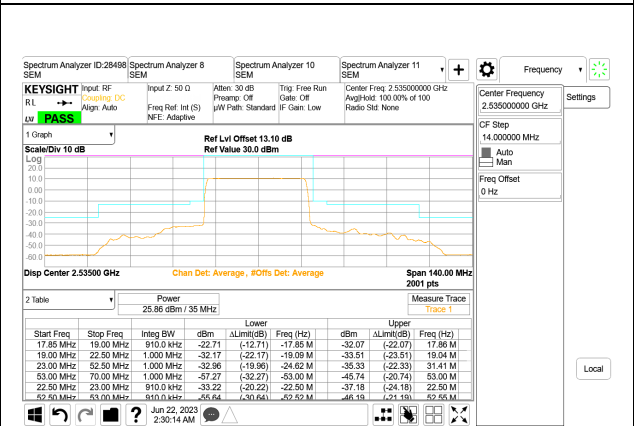

5G NR n7 35MHz BPSK Middle Channel RB180-0

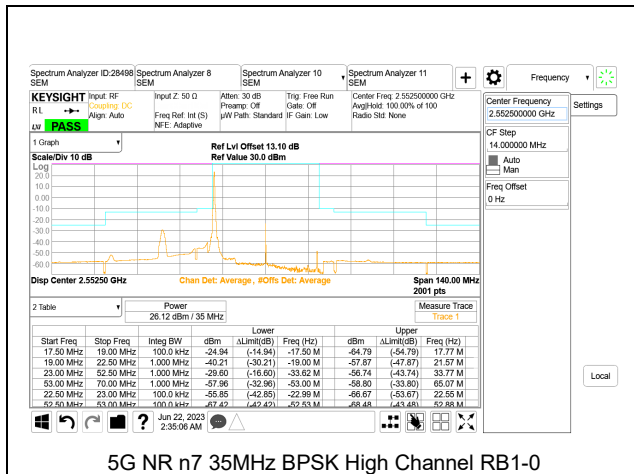

5G NR n7 35MHz BPSK High Channel RB1-0

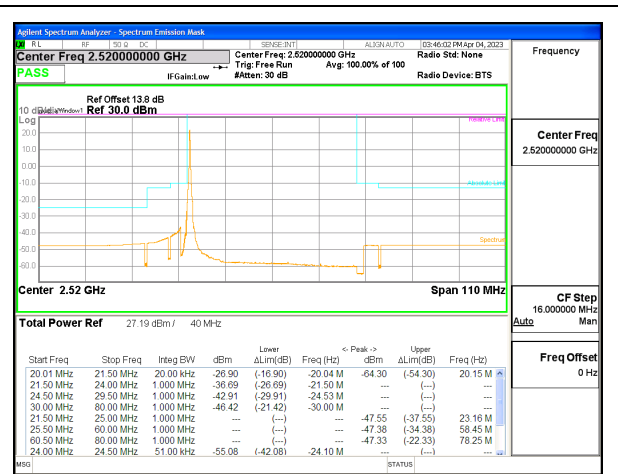

5G NR n7 40MHz BPSK Low Channel RB1-0, ID:28568

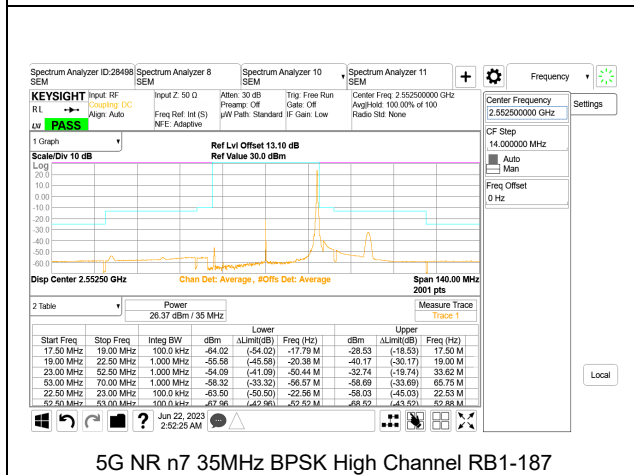

5G NR n7 35MHz BPSK High Channel RB1-187

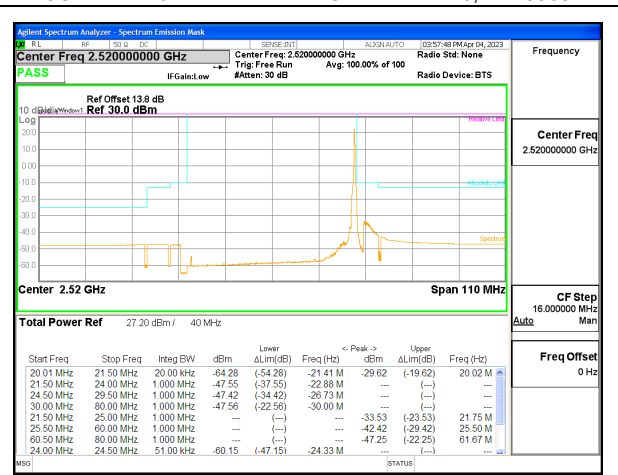

5G NR n7 40MHz BPSK Low Channel RB1-215, ID:28568

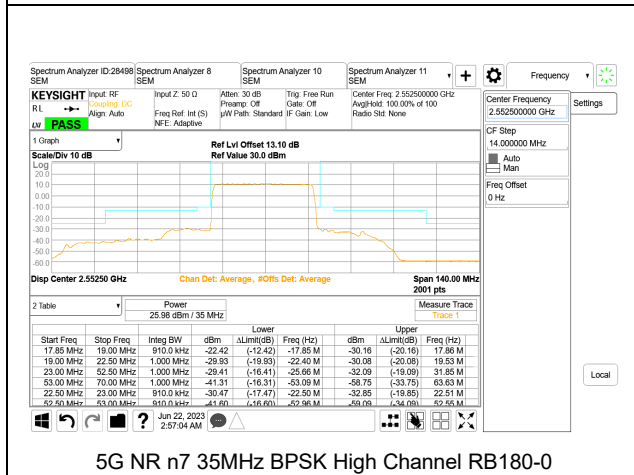

5G NR n7 35MHz BPSK High Channel RB180-0

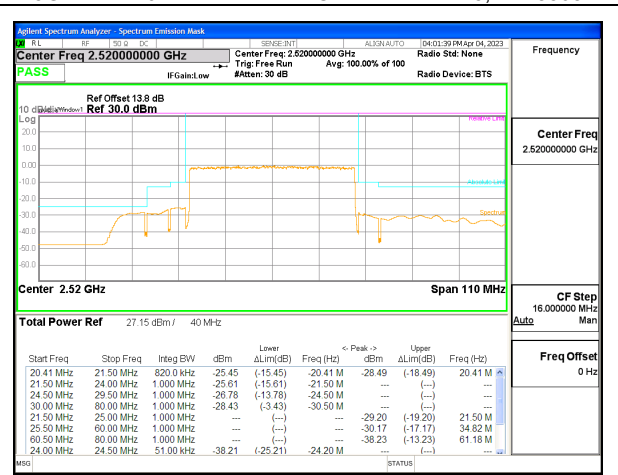

5G NR n7 40MHz BPSK Low Channel RB216-0, ID:28568

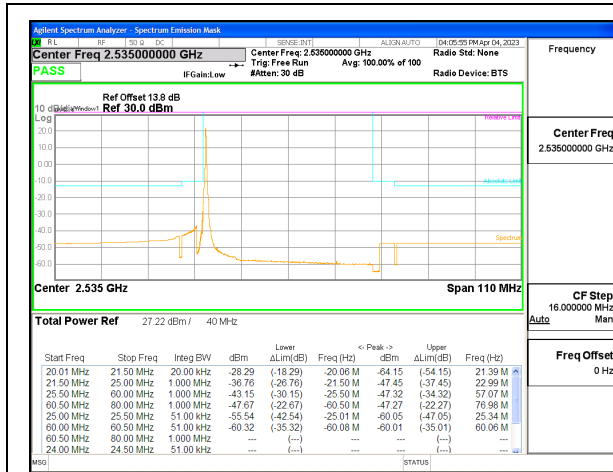

5G NR n7 40MHz BPSK Middle Channel RB1-0, ID:28568

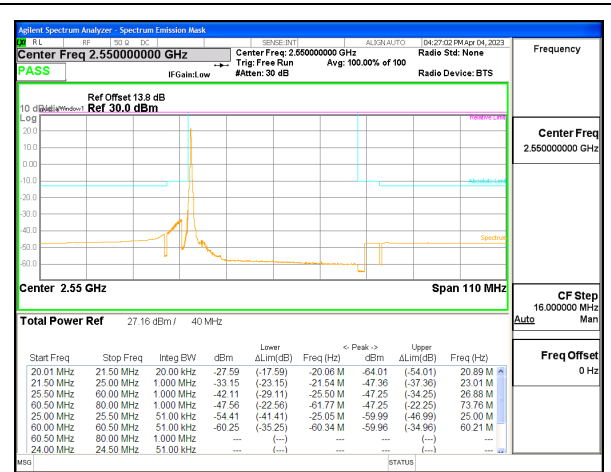

5G NR n7 40MHz BPSK High Channel RB1-0, ID:28568

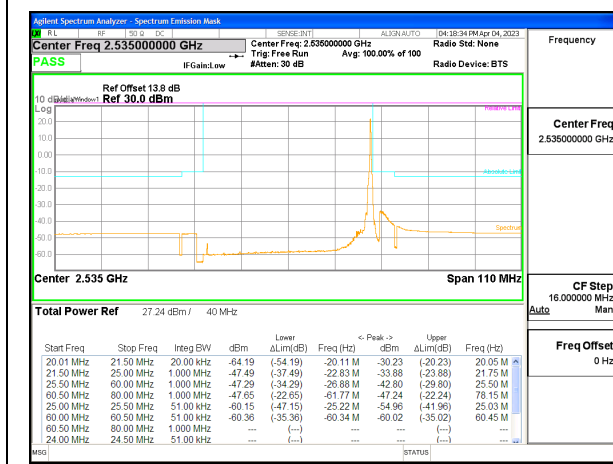

5G NR n7 40MHz BPSK Middle Channel RB1-215, ID:28568

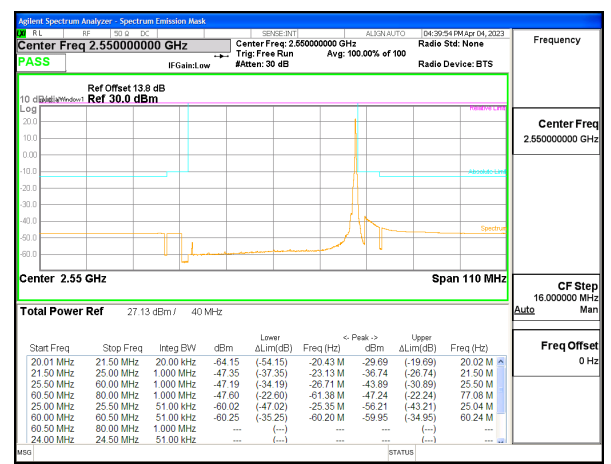

5G NR n7 40MHz BPSK High Channel RB1-215, ID:28568

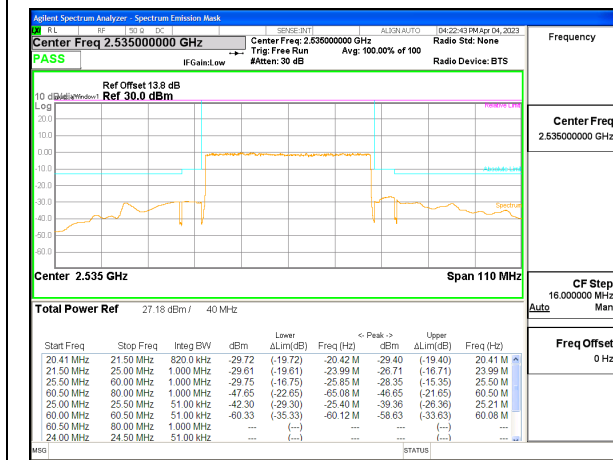

5G NR n7 40MHz BPSK Middle Channel RB216-0, ID:28568

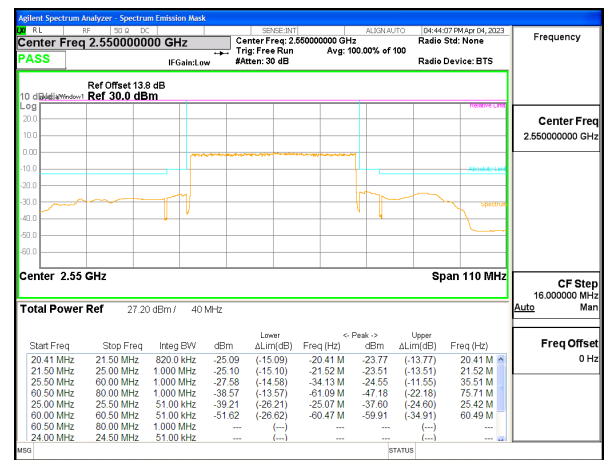

5G NR n7 40MHz BPSK High Channel RB216-0, ID:28568

9.2.2. LTE BAND 12 AND 5G NR n12

LIMITS

FCC: §27.53

(g) For operations in the 600 MHz band and the 698-746 MHz band, the power of any emission outside a licensee's frequency band(s) of operation shall be attenuated below the transmitter power (P) within the licensed band(s) of operation, measured in watts, by at least $43 + 10 \log (P)$ dB. Compliance with this provision is based on the use of measurement instrumentation employing a resolution bandwidth of 100 kilohertz or greater. However, in the 100 kilohertz bands immediately outside and adjacent to a licensee's frequency block, a resolution bandwidth of at least 30 kHz may be employed.

LTE BAND 12 EMISSION MASK

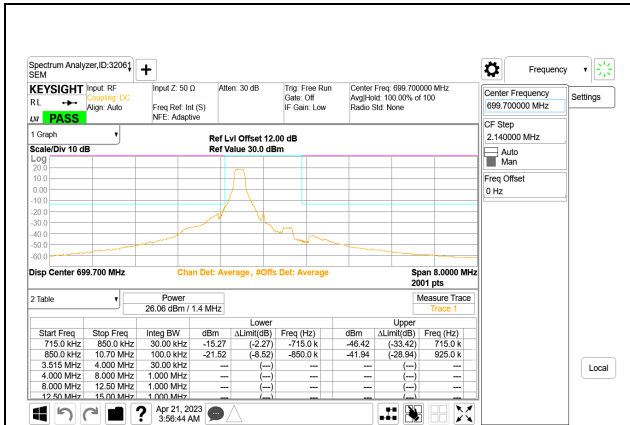

LTE B12 1.4MHz QPSK Low Channel RB1-0

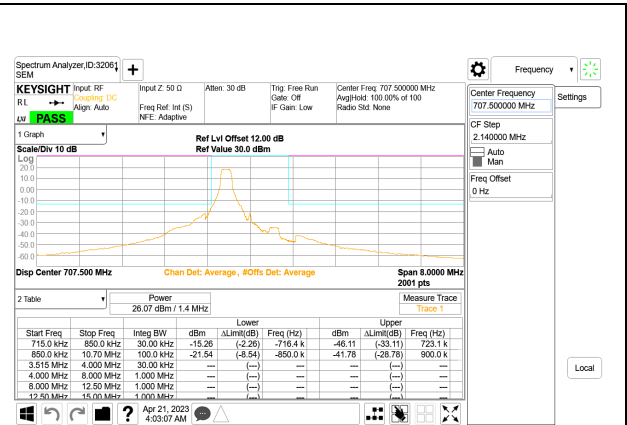

LTE B12 1.4MHz QPSK Middle Channel RB1-0

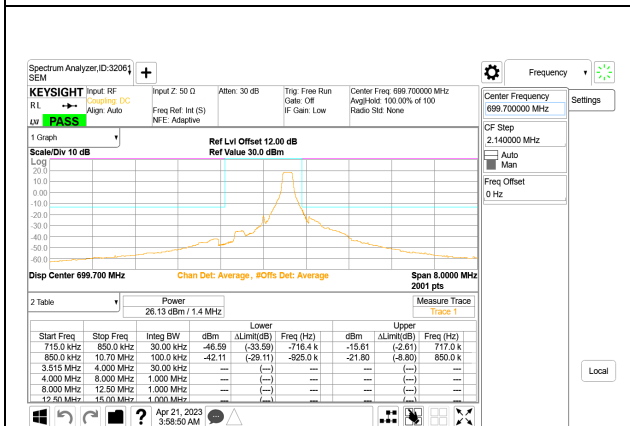

LTE B12 1.4MHz QPSK Low Channel RB1-5

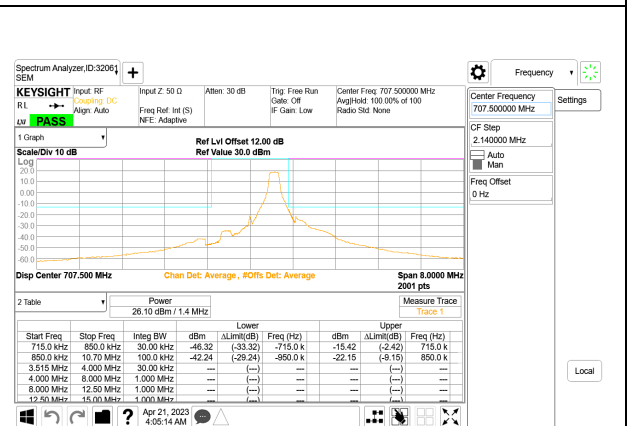

LTE B12 1.4MHz QPSK Middle Channel RB1-5

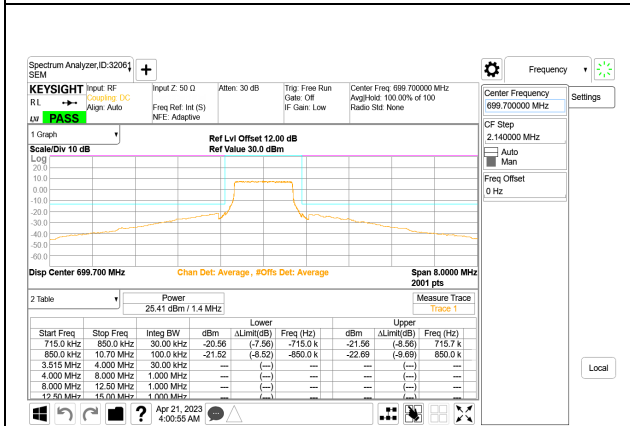

LTE B12 1.4MHz QPSK Low Channel RB6-0

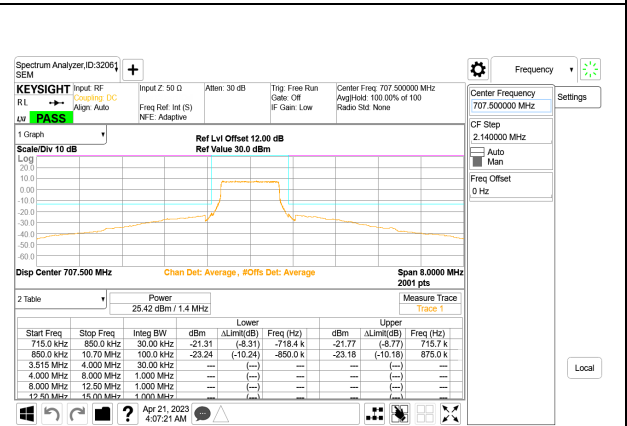

LTE B12 1.4MHz QPSK Middle Channel RB6-0

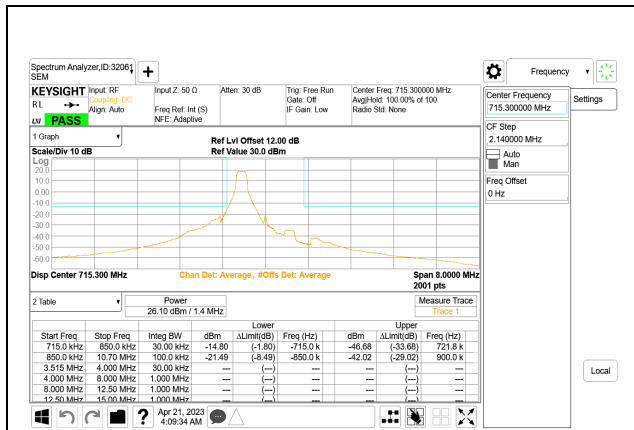

LTE B12 1.4MHz QPSK High Channel RB1-0

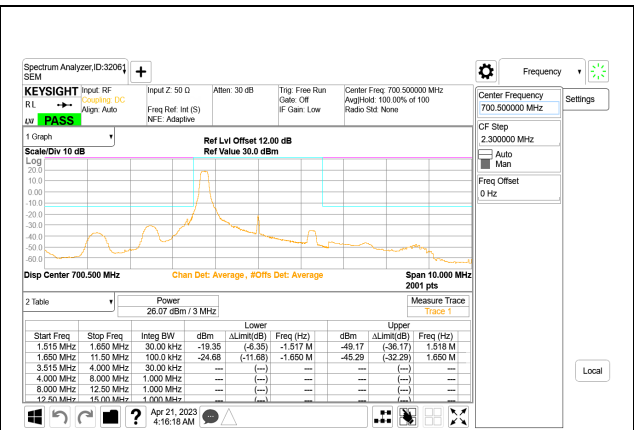

LTE B12 3MHz QPSK Low Channel RB1-0

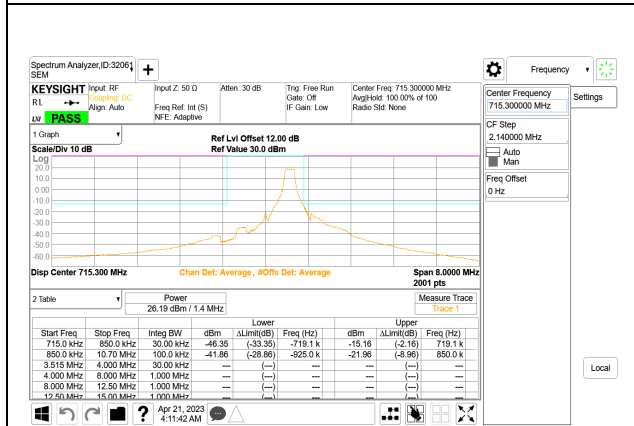

LTE B12 1.4MHz QPSK High Channel RB1-5

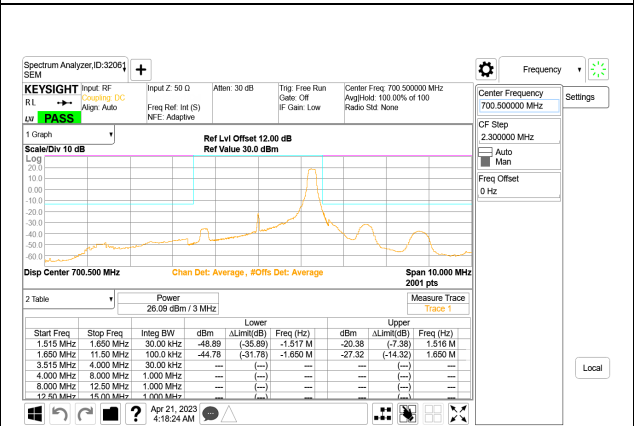

LTE B12 3MHz QPSK Low Channel RB1-14

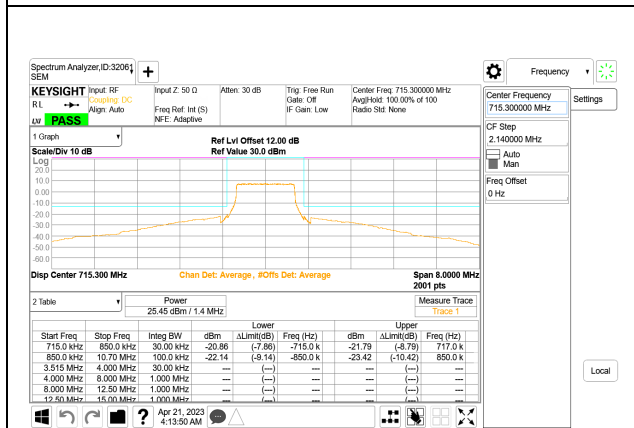

LTE B12 1.4MHz QPSK High Channel RB6-0

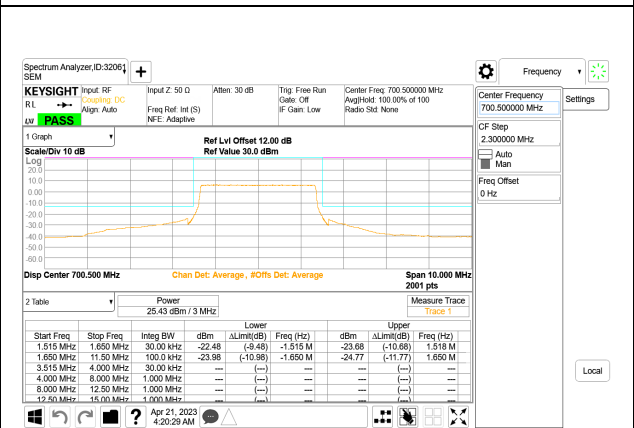

LTE B12 3MHz QPSK Low Channel RB15-0

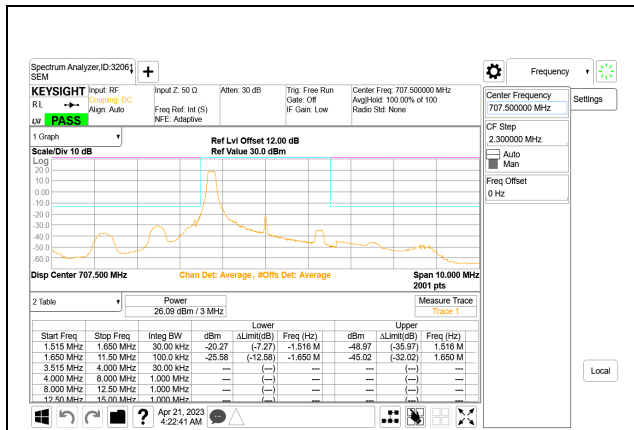

LTE B12 3MHz QPSK Middle Channel RB1-0

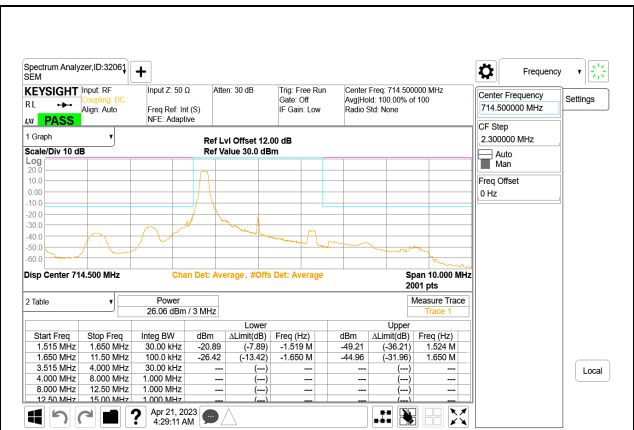

LTE B12 3MHz QPSK High Channel RB1-0

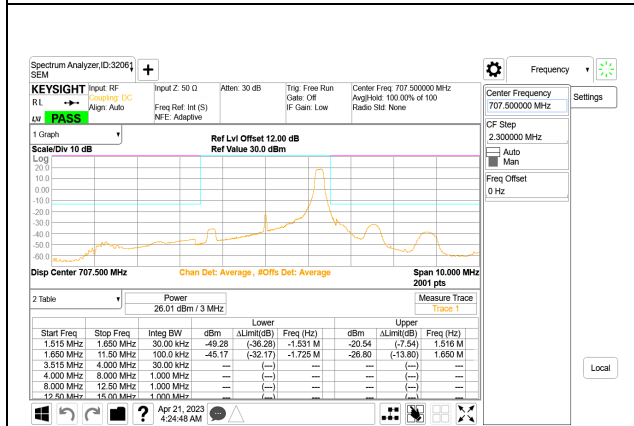

LTE B12 3MHz QPSK Middle Channel RB1-14

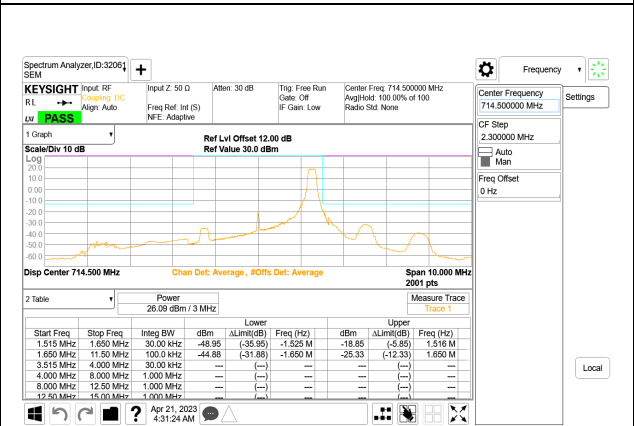

LTE B12 3MHz QPSK High Channel RB1-14

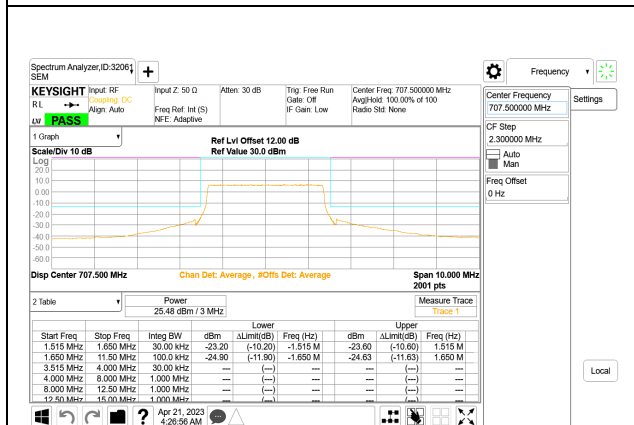

LTE B12 3MHz QPSK Middle Channel RB15-0

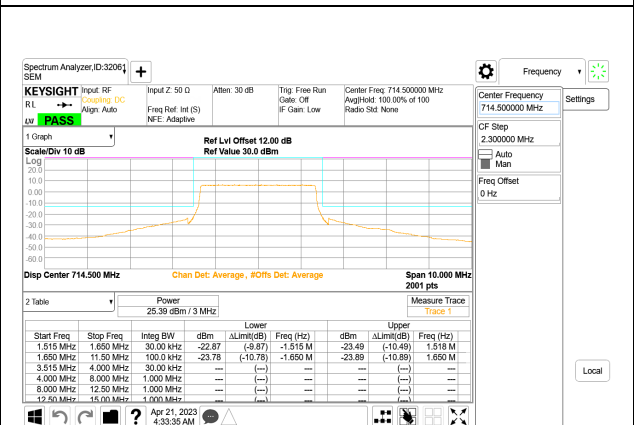

LTE B12 3MHz QPSK High Channel RB15-0

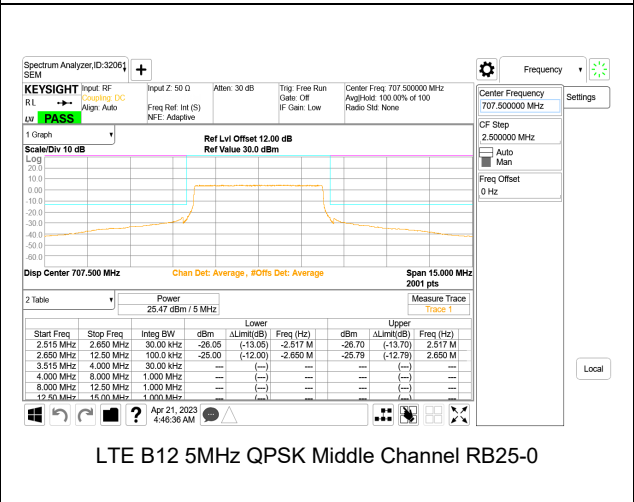
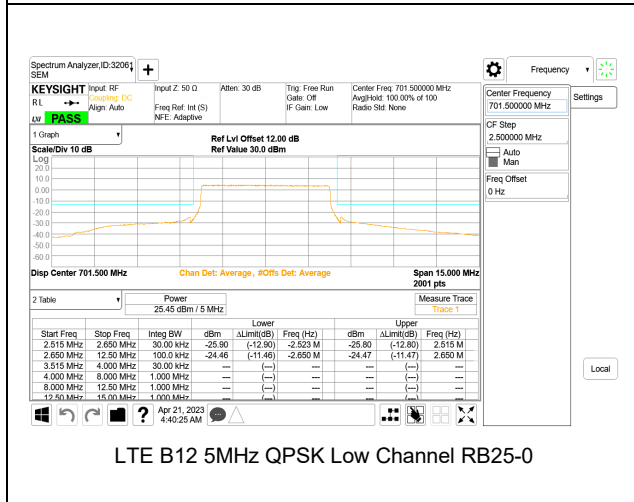
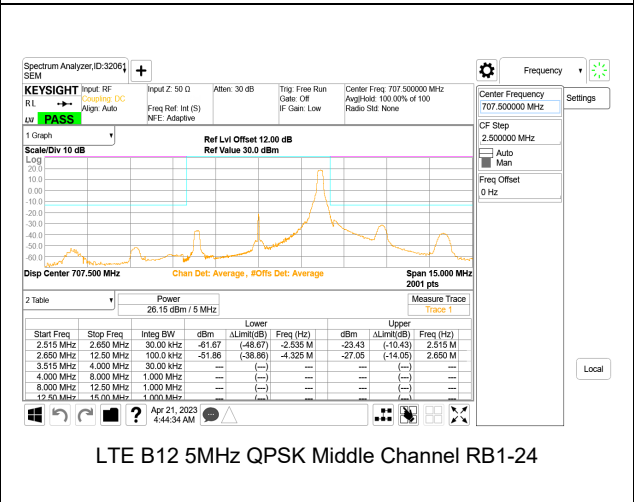
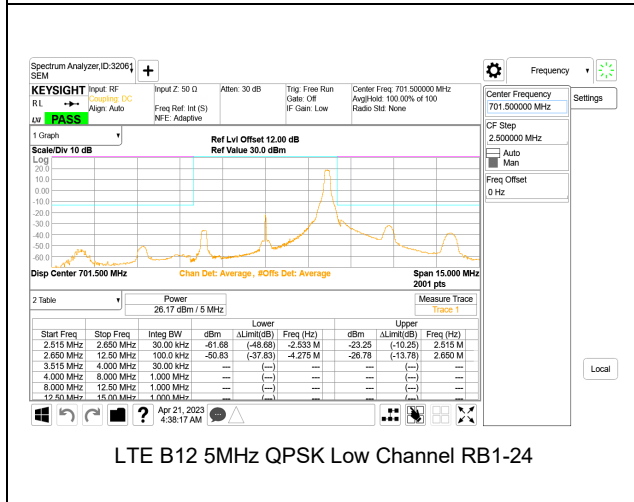
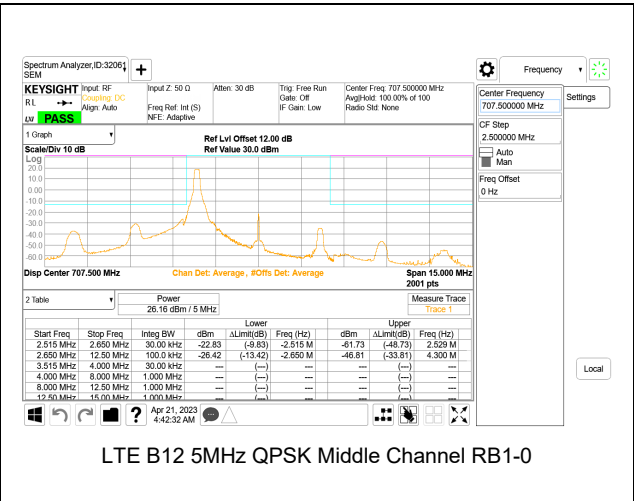
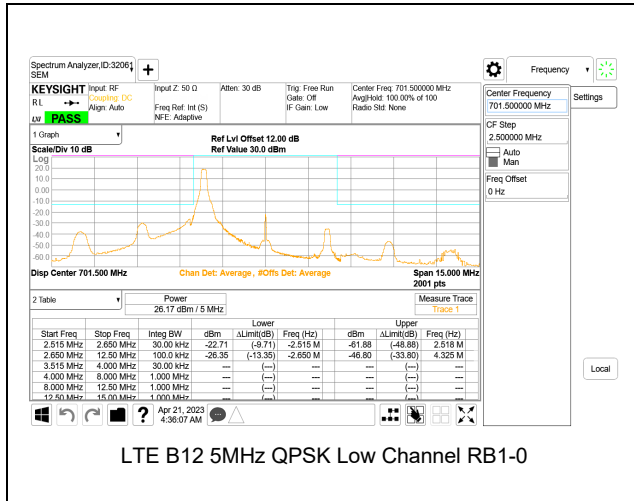

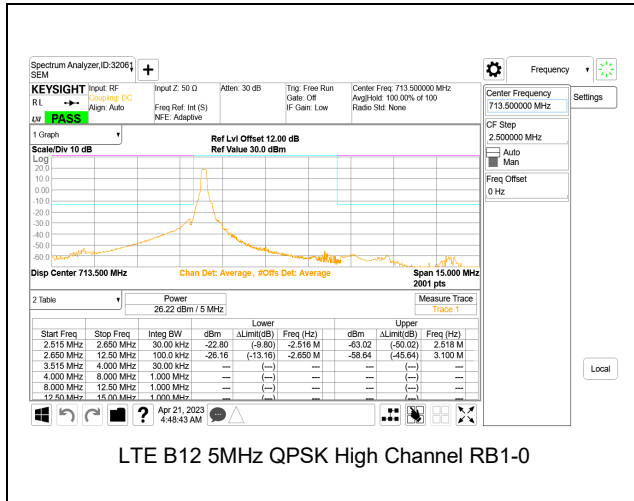

LTE B12 5MHz QPSK High Channel RB1-0

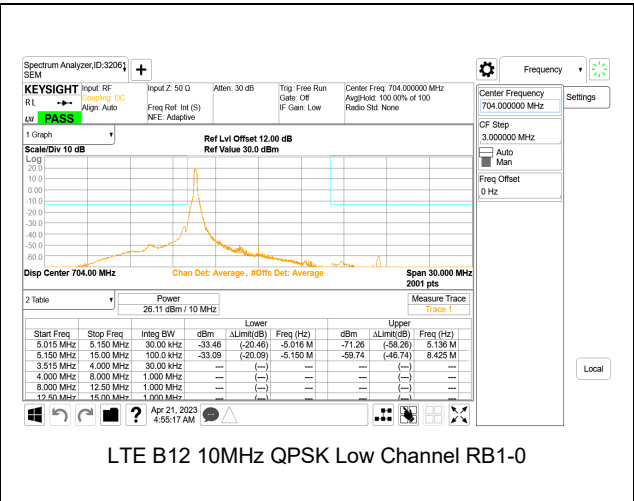

LTE B12 10MHz QPSK Low Channel RB1-0

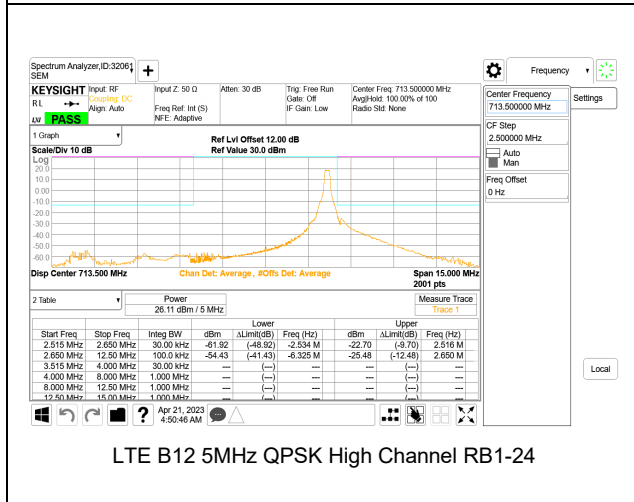

LTE B12 5MHz QPSK High Channel RB1-24

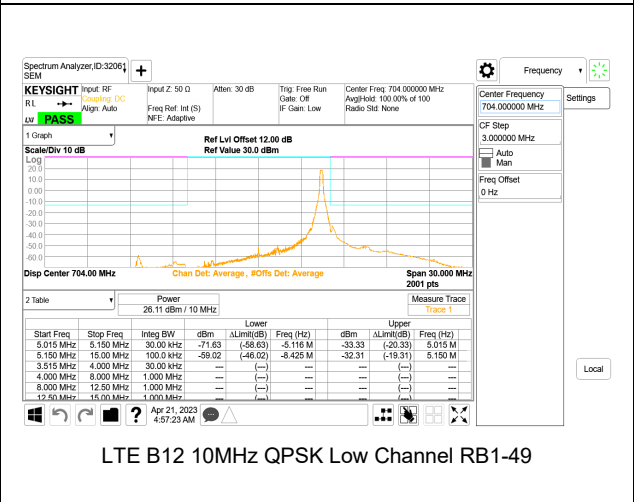

LTE B12 10MHz QPSK Low Channel RB1-49

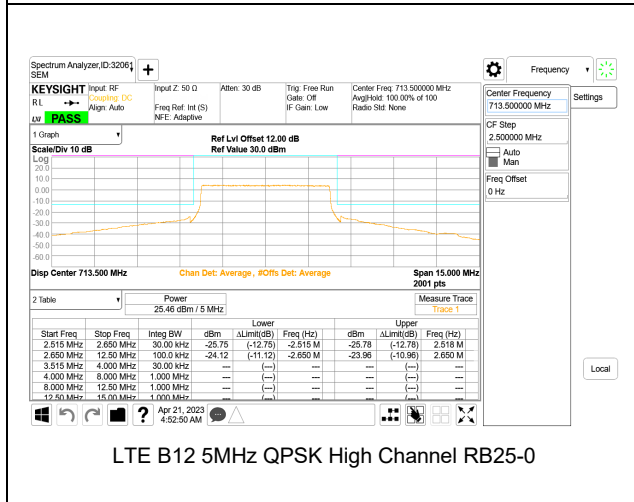

LTE B12 5MHz QPSK High Channel RB25-0

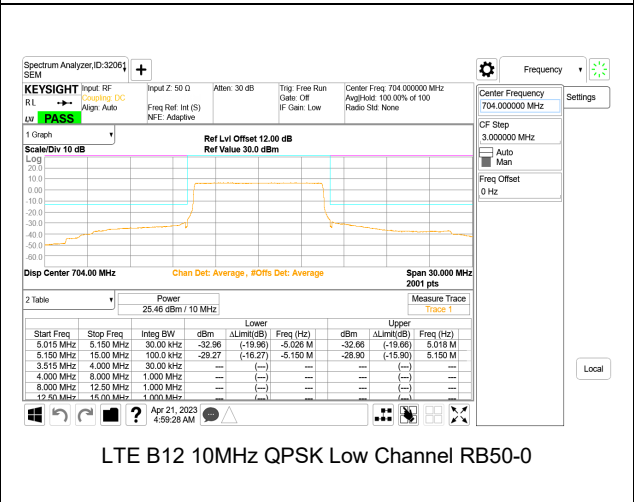

LTE B12 10MHz QPSK Low Channel RB50-0

