

# TEST REPORT

**Report Number:** 14523771-E20V2

**Applicant :** APPLE, INC  
1 APPLE PARK WAY  
CUPERTINO, CA 95014, U.S.A.

**Model :** A2849

**Brand :** APPLE

**FCC ID :** BCG-E8439A

**EUT Description :** SMARTPHONE

**Test Standard(s) :** FCC 47 CFR Part 2, Part 22, Part 27, and Part 96

**Date Of Issue:**  
2023-09-05

**Prepared by:**  
UL Verification Services Inc.  
47173 Benicia Street  
Fremont, CA 94538, U.S.A.  
TEL: (510) 319-4000  
FAX: (510) 661-0888



Revision History

<u>Rev.</u>	<u>Issue Date</u>	<u>Revisions</u>	<u>Revised By</u>
V1	2023-07-25	Initial Review	Mengistu Mekuria
V2	2023-09-05	Updated Section 1, 2, 6, 8, & 10	Binod Sitaula

## TABLE OF CONTENTS

<b>1. ATTESTATION OF TEST RESULTS</b>	<b>6</b>
<b>2. SUMMARY OF TEST RESULTS</b>	<b>7</b>
<b>3. TEST METHODOLOGY</b>	<b>8</b>
<b>4. FACILITIES AND ACCREDITATION</b>	<b>8</b>
<b>5. DECISION RULES AND MEASUREMENT UNCERTAINTY</b>	<b>9</b>
5.1. METROLOGICAL TRACEABILITY	9
5.2. DECISION RULES	9
5.3. MEASUREMENT UNCERTAINTY	9
5.4. SAMPLE CALCULATION	9
<b>6. EQUIPMENT UNDER TEST</b>	<b>10</b>
6.1. DESCRIPTION OF EUT	10
6.2. MAXIMUM OUTPUT POWER	10
6.3. SOFTWARE AND FIRMWARE	14
6.4. MAXIMUM ANTENNA GAIN	14
6.5. WORST-CASE CONFIGURATION AND MODE	15
6.6. DESCRIPTION OF TEST SETUP	16
<b>7. TEST AND MEASUREMENT EQUIPMENT</b>	<b>18</b>
<b>8. RF OUTPUT POWER VERIFICATION</b>	<b>19</b>
<b>9. CONDUCTED TEST RESULTS</b>	<b>25</b>
9.1. OCCUPIED BANDWIDTH	25
9.1.1 LTE BAND 5	28
9.1.2 LTE BAND 7	29
9.1.3 LTE BAND 41	30
9.1.4 LTE BAND 48	32
9.2. EMISSION MASK AND ADJACENT CHANNEL POWER	34
9.2.1 LTE BAND 5 EMISSION MASK	35
9.2.2 LTE BAND 7 EMISSION MASK	37
9.2.3 LTE BAND 41 EMISSION MASK	40
9.2.4 LTE BAND 48 EMISSION MASK AND ADJACENT CHANNEL POWER	43
9.3. OUT OF BAND EMISSIONS	48
9.3.1 LTE BAND 5	49

9.3.2 LTE BAND 7 ..... 50

9.3.3 LTE BAND 41 ..... 51

9.3.4 LTE BAND 48 ..... 52

9.4. FREQUENCY STABILITY ..... 54

9.4.1 LTE BAND 5 ..... 55

9.4.2 LTE BAND 7 ..... 56

9.4.3 LTE BAND 41 ..... 57

9.4.4 LTE BAND 48 ..... 58

9.5. PEAK-TO-AVERAGE POWER RATIO ..... 59

9.5.1 LTE BAND 5 ..... 59

9.5.2 LTE BAND 7 ..... 59

9.5.3 LTE BAND 41 ..... 60

9.5.4 LTE BAND 48 ..... 60

**10. RADIATED TEST RESULTS ..... 61**

10.1. FIELD STRENGTH OF SPURIOUS RADIATION, ANT 1 ..... 64

10.1.1 LTE BAND 5 ..... 65

10.1.2. LTE BAND 7 ..... 66

10.1.3 LTE BAND 41 ..... 67

10.2. FIELD STRENGTH OF SPURIOUS RADIATION, ANT2 ..... 68

10.2.1 LTE BAND 5 ..... 69

10.2.2 LTE BAND 7 ..... 70

10.2.3 LTE BAND 41 ..... 71

10.3. FIELD STRENGTH OF SPURIOUS RADIATION, ANT3 ..... 72

10.3.1 LTE BAND 5 ..... 73

10.3.2 LTE BAND 7 ..... 74

10.3.3 LTE BAND 41 ..... 75

10.4. FIELD STRENGTH OF SPURIOUS RADIATION, ANT4 ..... 76

10.4.1 LTE BAND 7 ..... 77

10.4.2 LTE BAND 41 ..... 78

10.4.3 LTE BAND 48 ..... 79

10.5. FIELD STRENGTH OF SPURIOUS RADIATION, ANT7 ..... 80

10.5.1. LTE BAND 48 ..... 81

10.6. FIELD STRENGTH OF SPURIOUS RADIATION, ANT8 ..... 82

10.6.1 LTE BAND 48 ..... 83

10.7. FIELD STRENGTH OF SPURIOUS RADIATION, ANT9 ..... 84

---

10.7.1. LTE BAND 48 .....	85
<b>11. SETUP PHOTOS.....</b>	<b>86</b>



# 1. ATTESTATION OF TEST RESULTS

Applicant Name and Address	APPLE, INC 1 APPLE PARK WAY CUPERTINO, CA 95014, U.S.A.
Model	A2849
Brand	APPLE
FCC ID	BCG-E8439A
EUT Description	SMARTPHONE
Serial Number	W7W56L746D, FNVV33XXWW, W6RH2WDKJY (RADIATED) PV2DL69JHL, MN6T009G39, C07GVM000FQ000046Y (CONDUCTED)
Sample Receipt Date	2023-02-05
Date Tested	2023-02-05 to 2023-07-22
Applicable Standards	FCC 47 CFR Part 2, Part 22, Part 27, and Part 96
Test Results	COMPLIES

UL Verification Services Inc. tested the above equipment in accordance with the requirements set forth in the above standards. The test results show that the equipment tested is capable of demonstrating compliance with the requirements as documented in this report.

The results documented in this report apply only to the tested sample, under the conditions and modes of operation as described herein. It is the manufacturer's responsibility to assure that additional production units of this model are manufactured with identical electrical and mechanical components. All samples tested were in good operating condition throughout the entire test program. Measurement Uncertainties are published for informational purposes only and were not taken into account unless noted otherwise.

This document may not be altered or revised in any way unless done so by UL Verification Services Inc. and all revisions are duly noted in the revisions section. Any alteration of this document not carried out by UL Verification Services Inc. will constitute fraud and shall nullify the document.

Approved & Released By:  	Reviewed By:  	Prepared By:  
Mengistu Mekuria Staff Engineer UL Verification Services Inc.	Tewodros Woldemichael Laboratory Engineer UL Verification Services Inc..	Matthew Wu Laboratory Engineer UL Verification Services Inc.

## 2. SUMMARY OF TEST RESULTS

This report contains data provided by the customer which can impact the validity of results. UL Verification Services Inc. is only responsible for the validity of results after the integration of the data provided by the customer.

Requirement Description	Band	Requirement Clause Number (FCC)	Result	Remarks
RF Conducted Output Power		2.1046	Complies	
Effective Radiated Power	5	22.913 (a)(5)	Complies	
Equivalent Isotropic Radiated power	7, 41, 48	27.50 (h) (2) 96.41 (b)	Complies	
Occupied Bandwidth	5, 7, 41, 48	2.1049	Complies	
Band Edge and Emission Mask	5, 7, 41, 48	2.1051, 22.917 (a), 27.53 (m)(4) &(m)(6), 96.41(e)	Complies	
Out of Band Emissions	5, 7, 41, 48	2.1051, 22.917 (a), 27.53 (m)(4) & (m)(6), 96.41(e)	Complies	
Frequency Stability	5, 7, 41, 48	2.1055, 22.355, 24.235, 27.54	Complies	
Peak-to-Average Ratio	5, 7, 41, 48	27.50 (d) (5), 96.41 (g)	Complies	
Field Strength of Spurious Radiation	5, 7, 41, 48	2.1053, 22.917 (a), 27.53 (m)(4) & (m)(6), 96.41(e)	Complies	

### 3. TEST METHODOLOGY

The tests documented in this report were performed in accordance with the following:

- ANSI C63.26:2015
- FCC 47 CFR Part 2, Part 22, Part 27 and Part 96
- [FCC KDB 971168 D01 v03r01](#): Power Meas License Digital Systems
- [FCC KDB 971168 D02 v02r02](#): Misc Rev Approv License Devices
- [FCC KDB 412172 D01 v01r01](#): Determining ERP and EIRP

### 4. FACILITIES AND ACCREDITATION

UL Verification Services Inc. is accredited by A2LA, certification #0751.05, for all testing performed within the scope of this report. Testing was performed at the locations noted below.

	Address	ISED CABID	ISED Company Number	FCC Registration
<input checked="" type="checkbox"/>	Building 1: 47173 Benicia Street, Fremont, CA 94538, USA	US0104	2324A	550739
<input checked="" type="checkbox"/>	Building 2: 47266 Benicia Street, Fremont, CA 94538, USA			
<input type="checkbox"/>	Building 3: 843 Auburn Court, Fremont, CA 94538, USA			
<input checked="" type="checkbox"/>	Building 4: 47658 Kato Rd, Fremont, CA 94538, USA			
<input checked="" type="checkbox"/>	Building 5: 47670 Kato Rd, Fremont, CA 94538, USA			



## 5. DECISION RULES AND MEASUREMENT UNCERTAINTY

### 5.1. METROLOGICAL TRACEABILITY

All test and measuring equipment utilized to perform the tests documented in this report are calibrated on a regular basis, with a maximum time between calibrations of one year or the manufacturers' recommendation, whichever is less, and where applicable is traceable to recognized national standards.

### 5.2. DECISION RULES

The Decision Rule is based on Simple Acceptance in accordance with ISO Guide 98-4:2012 Clause 8.2. (Measurement uncertainty is not taken into account when stating conformity with a specified requirement.)

### 5.3. MEASUREMENT UNCERTAINTY

Where relevant, the following measurement uncertainty levels have been estimated for tests performed on the apparatus:

PARAMETER	U <sub>Lab</sub>
Conducted Antenna Port Emission Measurement	1.940
Power Spectral Density	2.466
Time Domain Measurements Using SA	3.39
RF Power Measurement Direct Method Using Power Meter	0.450 Peak; 1.300 Ave.
Radio Frequency (Spectrum Analyzer)	141.16 Hz
Occupied Bandwidth	1.22%
Worst Case Conducted Disturbance, 9KHz to 0.15 MHz	3.78 db
Worst Case Conducted Disturbance, 0.15 to 30 MHz	3.40 db
Worst Case Radiated Disturbance, 9KHz to 30 MHz	2.87 db
Worst Case Radiated Disturbance, 30 to 1000 MHz	6.01 db
Worst Case Radiated Disturbance, 1000 to 18000 MHz	4.73 db
Worst Case Radiated Disturbance, 18000 to 26000 MHz	4.51 db
Worst Case Radiated Disturbance, 26000 to 40000 MHz	5.29 db

Uncertainty figures are valid to a confidence level of 95%.

### 5.4. SAMPLE CALCULATION

#### RADIATED EMISSIONS

Where relevant, the following sample calculation is provided:

$$\text{Field Strength (dBuV/m)} = \text{Measured Voltage (dBuV)} + \text{Antenna Factor (dB/m)} + \text{Cable Loss (dB)} - \text{Preamp Gain (dB)}$$

$$36.5 \text{ dBuV} + 18.7 \text{ dB/m} + 0.6 \text{ dB} - 26.9 \text{ dB} = 28.9 \text{ dBuV/m}$$

## 6. EQUIPMENT UNDER TEST

### 6.1. DESCRIPTION OF EUT

The Apple iPhone is a smartphone with cellular GSM, GPRS, EGPRS, UMTS, LTE, 5G NR1, 5G NR2, IEEE 802.11a/b/g/n/ac/ax, Bluetooth (BT), Ultra-Wideband (UWB), GPS, NFC, 802.15.4ab-NB and MSS technologies. The rechargeable battery is not user accessible.

Testing was performed on the parent model and is used to support the application for the parent and variants identified in this report based on the test plan submitted and approved via KDB inquiry by the FCC and by ISED-Canada.

### 6.2. MAXIMUM OUTPUT POWER

#### ERP/EIRP TEST PROCEDURE

ANSI C63.26:2015  
KDB 971168 D01 Section 5.6

$ERP/EIRP = P_{Meas} + GT - LC$

where: ERP/EIRP = effective or equivalent radiated power, respectively (expressed in the same units as  $P_{Meas}$ , typically dBW or dBm);

$P_{Meas}$  = measured transmitter output power or PSD, in dBm or dBW;

GT = gain of the transmitting antenna, in dBd (ERP) or dBi (EIRP);

LC = signal attenuation in the connecting cable between the transmitter and antenna, in dB.

For devices utilizing multiple antennas, KDB 662911 provides guidance for determining the effective array transmit antenna gain term to be used in the above equation.

EUT includes different power levels for head use configuration and body use configuration and the below tables contain the highest of all configurations average conducted and ERP/EIRP output powers as follows:

**OUTPUT POWER FOR LTE BAND 5**

Part 22H								
ERP Limit (W)		7.00						
Antenna Gain (dBi) (Ant1)		-5.50						
Bandwidth (MHz)	Modulation	Low Frequency (MHz)	Upper Frequency (MHz)	Conducted Average (dBm)	ERP Average (dBm)	ERP Average (W)	99% BW (kHz)	Emission Designator
3+5	QPSK	825.5	846.5	25.70	18.05	0.064	7493.6	7M49G7W
	16QAM			25.70	18.05	0.064	7493.3	7M49D7W
5+3	QPSK	826.5	847.5	25.70	18.05	0.064	7503.5	7M50G7W
	16QAM			25.70	18.05	0.064	7496.6	7M50D7W
5+10	QPSK	826.5	844.0	25.70	18.05	0.064	13866.0	13M9G7W
	16QAM			24.70	17.05	0.051	13893.0	13M9D7W
10+5	QPSK	829.0	846.5	25.70	18.05	0.064	13872.0	13M9G7W
	16QAM			24.70	17.05	0.051	13862.0	13M9D7W
10+10	QPSK	829.0	844.0	25.70	18.05	0.064	18749.0	18M7G7W
	16QAM			24.70	17.05	0.051	18751.0	18M8D7W

**OUTPUT POWER FOR LTE BAND 7**

Part 27								
EIRP Limit (W)		2.00						
Antenna Gain (dBi) (Ant3)		-2.40						
Bandwidth (MHz)	Modulation	Low Frequency (MHz)	Upper Frequency (MHz)	Conducted Average (dBm)	EIRP Average (dBm)	EIRP Average (W)	99% BW (kHz)	Emission Designator
10+20	QPSK	2505.5	2560.0	25.00	22.60	0.182	28299	28M3G7W
	16QAM			24.00	21.60	0.145	28292	28M3D7W
20+10	QPSK	2510.0	2564.5	25.00	22.60	0.182	28296	28M3G7W
	16QAM			24.00	21.60	0.145	28199	28M2D7W
15+15	QPSK	2507.5	2562.5	25.00	22.60	0.182	28760	28M8G7W
	16QAM			24.00	21.60	0.145	28799	28M8D7W
15+20	QPSK	2507.8	2560.0	25.00	22.60	0.182	33079	33M1G7W
	16QAM			24.00	21.60	0.145	32995	33M0D7W
20+15	QPSK	2510.0	2562.2	25.00	22.60	0.182	22038	22M0G7W
	16QAM			23.00	20.60	0.115	33024	33M0D7W
20+20	QPSK	2510.0	2560.0	24.92	22.52	0.179	37841	37M8G7W
	16QAM			23.90	21.50	0.141	37845	37M8D7W

**OUTPUT POWER FOR LTE BAND 41**

Part 27								
EIRP Limit (W)		2.00						
Antenna Gain (dBi) (Ant2)		-1.90						
Bandwidth (MHz)	Modulation	Low Frequency (MHz)	Upper Frequency (MHz)	Conducted Average (dBm)	EIRP Average (dBm)	EIRP Average (W)	99% BW (kHz)	Emission Designator
5+20	QPSK	2499.3	2680.0	28.70	26.80	0.479	23420	23M4G7W
	16QAM			27.19	25.29	0.338	23366	23M4D7W
20+5	QPSK	2506.0	2686.7	28.46	26.56	0.453	23403	23M4G7W
	16QAM			26.72	24.82	0.303	23346	23M3D7W
10+20	QPSK	2501.5	2680.0	28.23	26.33	0.430	28145	28M1G7W
	16QAM			27.05	25.15	0.327	28113	28M1D7W
20+10	QPSK	2506.0	2684.5	28.55	26.65	0.462	28183	28M2G7W
	16QAM			27.20	25.30	0.339	28071	28M1D7W
15+15	QPSK	2503.5	2682.5	28.24	26.34	0.431	28706	28M7G7W
	16QAM			27.20	25.30	0.339	28661	28M7D7W
15+20	QPSK	2503.8	2680.0	28.32	26.42	0.439	33003	33M0G7W
	16QAM			27.20	25.30	0.339	32973	33M0D7W
20+15	QPSK	2506.0	2682.2	28.68	26.78	0.476	33008	33M0G7W
	16QAM			27.20	25.30	0.339	32924	32M9D7W
20+20	QPSK	2506.0	2680.0	28.30	26.40	0.437	37799	37M8G7W
	16QAM			27.20	25.30	0.339	37843	37M8D7W

**OUTPUT POWER FOR LTE BAND 48**

**LOW CHANNEL**

Part 96								
EIRP Limit (W)/ 10MHz		0.20						
Antenna Gain (dBi) (Ant4)		-3.30						
Bandwidth (MHz)	Modulation	Low Frequency (MHz)	Upper Frequency (MHz)	Conducted Average (dBm)	EIRP Average (dBm)	EIRP Average (W)	99% BW (kHz)	Emission Designator
5+20	QPSK	3553.3	3690.0	23.20	19.90	0.098	23252	23M3G7W
	16QAM			23.20	19.90	0.098	23178	23M2D7W
20+5	QPSK	3560.0	3696.7	23.20	19.90	0.098	23268	23M3G7W
	16QAM			23.20	19.90	0.098	23272	23M3D7W
10+20	QPSK	3555.5	3690.0	23.70	20.40	0.110	27876	27M9G7W
	16QAM			23.70	20.40	0.110	28056	28M1D7W
20+10	QPSK	3560.0	3694.5	23.70	20.40	0.110	28035	28M0G7W
	16QAM			23.70	20.40	0.110	28101	28M1D7W
15+20	QPSK	3557.8	3690.0	24.20	20.90	0.123	32695	32M7G7W
	16QAM			24.20	20.90	0.123	32857	32M9D7W
20+15	QPSK	3560.0	3692.2	24.20	20.90	0.123	32834	32M8G7W
	16QAM			24.20	20.90	0.123	32858	32M9D7W
20+20	QPSK	3560.0	3690.0	24.20	20.90	0.123	37509	37M5G7W
	16QAM			24.20	20.90	0.123	37552	37M6D7W

**MIDDLE CHANNEL**

Part 96								
EIRP Limit (W)/ 10MHz		0.20						
Antenna Gain (dBi) (Ant7)		-3.80						
Bandwidth (MHz)	Modulation	Low Frequency (MHz)	Upper Frequency (MHz)	Conducted Average (dBm)	EIRP Average (dBm)	EIRP Average (W)	99% BW (kHz)	Emission Designator
5+20	QPSK	3553.3	3690.0	23.58	19.78	0.095	23252	23M3G7W
	16QAM			23.55	19.75	0.094	23178	23M2D7W
20+5	QPSK	3560.0	3696.7	23.51	19.71	0.094	23268	23M3G7W
	16QAM			23.51	19.71	0.094	23272	23M3D7W
10+20	QPSK	3555.5	3690.0	24.50	20.70	0.117	27876	27M9G7W
	16QAM			24.50	20.70	0.117	28056	28M1D7W
20+10	QPSK	3560.0	3694.5	24.50	20.70	0.117	28035	28M0G7W
	16QAM			24.50	20.70	0.117	28101	28M1D7W
15+20	QPSK	3557.8	3690.0	25.00	21.20	0.132	32695	32M7G7W
	16QAM			25.00	21.20	0.132	32857	32M9D7W
20+15	QPSK	3560.0	3692.2	25.00	21.20	0.132	32834	32M8G7W
	16QAM			25.00	21.20	0.132	32858	32M9D7W
20+20	QPSK	3560.0	3690.0	25.00	21.20	0.132	37509	37M5G7W
	16QAM			25.00	21.20	0.132	37552	37M6D7W

**HIGH CHANNEL**

Part 96								
EIRP Limit (W)/ 10MHz		0.20						
Antenna Gain (dBi) (Ant8)		-3.20						
Bandwidth (MHz)	Modulation	Low Frequency (MHz)	Upper Frequency (MHz)	Conducted Average (dBm)	EIRP Average (dBm)	EIRP Average (W)	99% BW (kHz)	Emission Designator
5+20	QPSK	3553.3	3690.0	23.87	20.67	0.117	23252	23M3G7W
	16QAM			23.78	20.58	0.114	23178	23M2D7W
20+5	QPSK	3560.0	3696.7	23.76	20.56	0.114	23268	23M3G7W
	16QAM			23.69	20.49	0.112	23272	23M3D7W
10+20	QPSK	3555.5	3690.0	24.35	21.15	0.130	27876	27M9G7W
	16QAM			24.35	21.15	0.130	28056	28M1D7W
20+10	QPSK	3560.0	3694.5	24.30	21.10	0.129	28035	28M0G7W
	16QAM			24.36	21.16	0.131	28101	28M1D7W
15+20	QPSK	3557.8	3690.0	24.85	21.65	0.146	32695	32M7G7W
	16QAM			24.85	21.65	0.146	32857	32M9D7W
20+15	QPSK	3560.0	3692.2	24.90	21.70	0.148	32834	32M8G7W
	16QAM			24.83	21.63	0.146	32858	32M9D7W
20+20	QPSK	3560.0	3690.0	24.92	21.72	0.149	37509	37M5G7W
	16QAM			24.90	21.70	0.148	37552	37M6D7W

### 6.3. SOFTWARE AND FIRMWARE

The EUT firmware installed during testing was version: 0.13.02.

### 6.4. MAXIMUM ANTENNA GAIN

The antenna(s) gain(s) and type, as provided by the manufacturer' are as follows:

LTE and 5G NR Bands	Frequency Range (MHz)	ANT 1 Antenna Gain (dBi)	ANT 2 Antenna Gain (dBi)	ANT 3 Antenna Gain (dBi)	ANT 4 Antenna Gain (dBi)	ANT 7 Antenna Gain (dBi)	ANT 8 Antenna Gain (dBi)	ANT 9 Antenna Gain (dBi)
LTE Band 5	824 – 849	-5.5	-5	-8.7				
LTE Band 7	2500 – 2570	-3.4	-2	-2.4	-1.2			
LTE Band 41	2496 – 2690	-3.2	-1.9	-2.8	-1.3			
LTE Band 48 (Low)	3550 – 3600				-3.3	-4.2	-6.1	-6.2
LTE Band 48 (Mid)	3600 – 3650				-3.2	-3.8	-4.1	-7.1
LTE Band 48 (High)	3650 – 3700				-4.1	-4.1	-3.2	-5.5

## 6.5. WORST-CASE CONFIGURATION AND MODE

The EUT supports LTE dual carrier Bands of: Band 5, Band 7, Band 41, and Band 48.

The worst-case scenario for all measurements is based on the average conducted output power measurement investigation results. Output power measurements were measured on QPSK, 16QAM and 64QAM modulations. It was found that QPSK and 16QAM results were worst case. All testing was performed using QPSK and 16QAM modulations to represent the worst case. For testing purposes emissions on sections 8 and 9 were measured while QPSK was set at or above target power for all bands. Conducted tests were performed on the worst-case antenna port because it has the highest conducted power. The worst-case antenna port is shown in the table below.

LTE Bands	Worst case Antenna Port for Conducted Power
LTE BAND 5, 7, and 41	Ant 1
LTE BAND 48	Ant 7

For Band Edge and Emission Mask: The highest BW combo and sample lower BW combinations were tested. Combination pairs of the same BW are considered generally equivalent. The RB combinations were selected such that the signal is active closest to the band limit, as this is the worst case.

For Out of Band Emissions: The highest combination and a sample lower combination was tested. The highest power RB combination was selected as worst case.

The EUT was investigated in three orthogonal orientations X/Y/Z on all ANT 1, ANT2, ANT3, ANT4, ANT7, ANT8 and ANT 9 antennas to determine the worst-case orientation. The following table exhibit the worst-case orientation for different frequency bands. The full tests of the EUT have made upon the orientations that shown in the table below.

Frequency Bands	ANT1	ANT2	ANT3	ANT4	ANT7	ANT8	ANT9
663 – 849 MHz	Z	Z	X	N/A	N/A	N/A	N/A
2300 – 2700 MHz	X	X	Y	Y	N/A	N/A	N/A
3300 – 3980 MHz	N/A	N/A	N/A	Y	Y	X	X

Radiated spurious emissions were investigated from 9kHz to 30MHz, 30MHz-1GHz and above 18GHz. There were no emissions found with less than 20dB of margin from 9kHz 1GHz.

For interband transmission of multiple channels in Ant 1 and Ant 2 in Cellular bands, tests were conducted for various configurations having the highest power, least separation in frequencies and widest operation bandwidths. No noticeable new emission was found.

## 6.6. DESCRIPTION OF TEST SETUP

SUPPORT TEST EQUIPMENT						
Description	Manufacturer	Model	Serial Number	FCC ID/ DoC		
Laptop	Apple	MacBook Pro	HRP082673	BCGA1708		
AC/DC adapter	Apple	A1718	C4H64450HH3GN8RA6	--		
I/O CABLES (RF CONDUCTED TEST)						
Cable No.	Port	# of Identical Ports	Connector Type	Cable Type	Cable Length (m)	Remarks
1	AC	3	US 115V	Un-shielded	2.0	N/A
2	USB	1	DC	Un-shielded	1.0	N/A
3	RF In/Out	1	EUT	Un-shielded	0.6	N/A
4	RF In/Out	1	Communication Test Set	Un-shielded	1.2	N/A
5	RF In/Out	1	Barrel	N/A	N/A	N/A
I/O CABLES (RF RADIATED TEST)						
Cable No.	Port	# of Identical Ports	Connector Type	Cable Type	Cable Length (m)	Remarks
1	RF In/Out	1	Antenna	Un-shielded	5.0	N/A



**CONDUCTED SETUP**

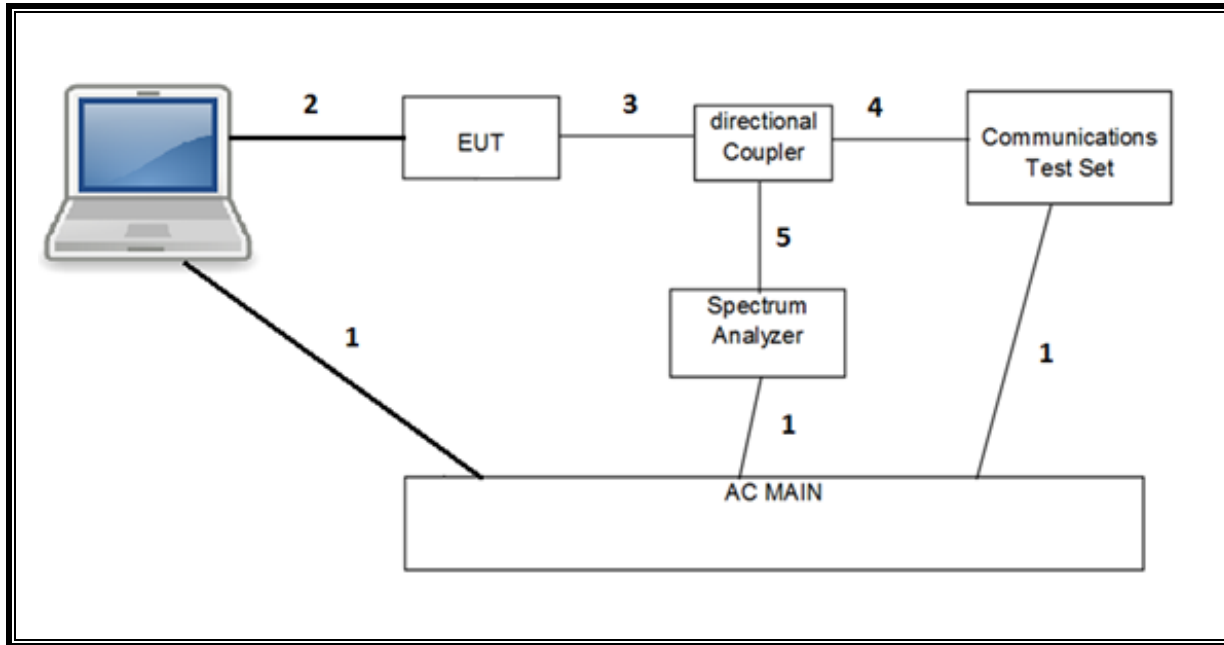

**RADIATED SETUP**

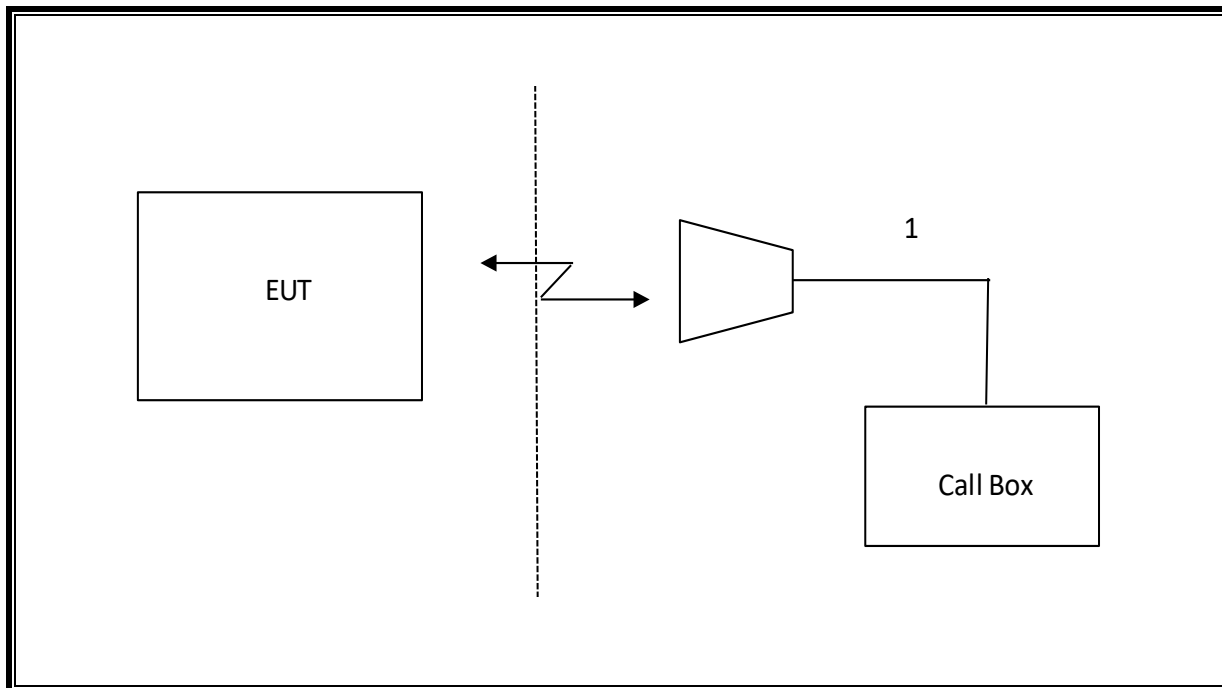

## 7. TEST AND MEASUREMENT EQUIPMENT

The following test and measurement equipment was utilized for the tests documented in this report:

TEST EQUIPMENT LIST				
Description	Manufacturer	Model	Asset	Cal Due
*Antenna, Horn 1-18GHz	ETS Lindgren	3117	79834	06/08/2023
Antenna, Broadband Hybrid, 30MHz to 2000MHz	Sunol Sciences	JB3	85151	04/30/2024
Spectrum Analyzer, PXA, 3Hz to 44GHz	Keysight	N9030A	85313	02/29/2024
Spectrum Analyzer, PXA	Keysight	N9030B	222074	07/16/2023
Spectrum Analyzer, PXA, 3Hz to 44GHz	Keysight	N9030A	85201	02/29/2024
Spectrum Analyzer, PXA	Keysight	N9030B	85214	07/18/2023
Spectrum Analyzer, PXA	Keysight	N9030B	222073	07/22/2023
PXA Signal Analyzer	Keysight	N9030B	222073	07/22/2023
EMI TEST RECEIVER	Rohde & Schwarz	ESW44	230548	02/29/2024
EMI TEST RECEIVER	Rohde & Schwarz	ESW44	201498	02/29/2024
Directional Coupler	KRYTAR	152610	198816	09/23/2023
Directional Coupler	KRYTAR	152610	198817	09/23/2023
Directional Coupler	KRYTAR	152610	135712	09/23/2023
Power Meter, P-series single channel	Keysight	N1912A	90630	01/24/2024
Power Meter, P-series single channel	Keysight	N1912A	90719	01/31/2024
Power Meter, P-series single channel	Agilent	N1911A	82174	01/31/2024
Power Sensor, P-series, 50MHz to 18GHz, Wideband	Keysight	N1921A	90389	01/31/2024
Filter, BRF 2495 – 2690 MHz	Micro-Tronics	155050	155055	12/28/2023
Filter, BRF 3.4 – 3.8GHz	Micro-Tronics	208398	208398	08/19/2023
Wideband Communication Test Set, Call Box	Rohde & Schwarz	CMW500	222792	02/29/2024
Wideband Communication Test Set, Call Box	Rohde & Schwarz	CMW500	230298	02/29/2024
Wideband Communication Test Set, Call Box	Rohde & Schwarz	CMW500	230295	02/29/2024
Wideband Communication Test Set, Call Box	Rohde & Schwarz	CMW500	22796	02/29/2024
Wideband Communication Test Set, Call Box	Rohde & Schwarz	CMW500	230297	02/29/2024
*Chamber, Environmental	Cincinnati Sub Zero	ZPHS-8-3.5-SCT/WC	82472	11/16/2023
*Amplifier, 218GHz to 26.5GHz	Ampical	AMP18G26.5-60	215705	02/26/2023
*Amplifier, 26.5GHz to 40GHz	Ampical	AMP26G40-65	172346	02/29/20224
Antenna, Horn 18 to 26.5GHz	ARA	MWH-1826/B	172362	03/31/2024
Antenna, Horn 26.5GHz to 40GHz	ARA	MWH-2640/B	172365	03/31/2024
*Antenna, Active Loop 100KHz to 30MHz	ELECTRO-METRICS	EM-6872	219911	05/10/2023
*Antenna, Active Loop 30Hz to 1MHz	ELECTRO-METRICS	EM-6871	219909	05/10/2023
10dB Fixed Attenuator	Pasternack Enterprises	PE7087-10	236360	N/A
10dB Fixed Attenuator	Pasternack Enterprises	PE7087-10	236285	N/A
10dB Fixed Attenuator	Pasternack Enterprises	PE7087-10	236355	N/A
UL AUTOMATION SOFTWARE				
CLT Software	UL	UL RF	Ver 3.4, May 20, 2022	
Power Measurement Software	UL	UL RF	Ver 3.1.4, April 29, 2022	
Radiated test software	UL	UL RF	Ver 9.5, Jan 21, 2022	

### NOTES:

- \* Testing is completed before equipment expiration date.

## 8. RF OUTPUT POWER VERIFICATION

### RULE PART(S)

FCC: §2.1046, §22.913, §27.50, §96.41

### RESULT

EUT includes different power levels for head use configuration and body use configuration and the below tables contain the highest of all configurations average conducted output powers as follows:

<b>Test Engineer ID:</b>	25602/25780	<b>Test Date:</b>	4/24/2023
--------------------------	-------------	-------------------	-----------

**OUTPUT POWER FOR LTE BAND 5 (3.0MHz + 5.0MHz)**

Bandwidth	PCC Frequency (MHz)	SCC1 Frequency (MHz)	PCC RB Size	PCC RB Offset	SCC1 RB Size	SCC1 RB Offset	Conducted Average (dBm)											
							ANT 1				ANT 2				ANT 3			
							QPSK	16QAM	64QAM	256QAM	QPSK	16QAM	64QAM	256QAM	QPSK	16QAM	64QAM	256QAM
3MHz / 5MHz	825.5	829.4	1	14	1	0	25.62	25.66	25.33	24.28	24.62	24.62	24.57	23.62	25.25	<b>25.40</b>	<b>25.18</b>	<b>24.28</b>
			15	0	25	0	25.67	<b>25.70</b>	<b>25.41</b>	<b>24.43</b>	<b>24.70</b>	<b>24.70</b>	<b>23.89</b>	25.31	25.28	25.12	24.17	
	834.0	837.9	1	14	1	0	25.63	25.69	25.09	24.13	24.63	<b>24.70</b>	<b>24.56</b>	23.60	25.34	<b>25.40</b>	<b>24.57</b>	23.63
			15	0	25	0	<b>25.70</b>	25.51	24.96	23.99	<b>24.70</b>	24.61	24.42	23.42	<b>25.40</b>	25.32	24.55	23.56
	842.5	846.5	1	14	1	0	25.61	25.46	24.48	23.60	24.64	24.34	23.87	22.90	25.33	25.30	24.44	23.47
			15	0	25	0	25.68	25.60	24.59	23.60	24.68	24.61	24.11	23.13	25.30	25.26	24.29	23.33

**OUTPUT POWER FOR LTE BAND 5 (5.0MHz + 3.0MHz)**

Bandwidth	PCC Frequency (MHz)	SCC1 Frequency (MHz)	PCC RB Size	PCC RB Offset	SCC1 RB Size	SCC1 RB Offset	Conducted Average (dBm)											
							ANT 1				ANT 2				ANT 3			
							QPSK	16QAM	64QAM	256QAM	QPSK	16QAM	64QAM	256QAM	QPSK	16QAM	64QAM	256QAM
5MHz / 3MHz	826.5	830.4	1	24	1	0	25.59	25.68	<b>25.45</b>	24.36	24.63	24.69	<b>24.70</b>	23.69	25.24	<b>25.40</b>	<b>25.15</b>	<b>24.26</b>
			25	0	15	0	25.69	<b>25.7</b>	25.42	<b>24.46</b>	24.66	<b>24.70</b>	<b>24.70</b>	<b>23.91</b>	25.32	25.37	25.08	24.14
	835.0	838.9	1	24	1	0	25.66	25.46	24.98	23.95	24.64	24.52	24.42	23.34	<b>25.31</b>	24.61	24.35	23.36
			25	0	15	0	<b>25.70</b>	25.39	24.87	23.89	<b>24.70</b>	24.51	24.32	23.33	<b>25.40</b>	24.72	24.50	23.48
	843.6	847.5	1	24	1	0	25.64	25.68	24.70	23.68	24.66	24.36	24.20	23.14	25.34	24.69	24.41	23.51
			25	0	15	0	25.66	25.52	24.56	23.57	24.67	24.33	24.18	23.19	25.14	24.41	24.19	23.24

**OUTPUT POWER FOR LTE BAND 5 (5.0MHz + 10.0MHz)**

Bandwidth	PCC Frequency (MHz)	SCC1 Frequency (MHz)	PCC RB Size	PCC RB Offset	SCC1 RB Size	SCC1 RB Offset	Conducted Average (dBm)											
							ANT 1				ANT 2				ANT 3			
							QPSK	16QAM	64QAM	256QAM	QPSK	16QAM	64QAM	256QAM	QPSK	16QAM	64QAM	256QAM
5MHz / 10MHz	826.5	833.7	1	24	1	0	25.63	<b>24.70</b>	23.62	20.69	24.67	<b>23.70</b>	22.63	19.59	25.38	24.97	23.98	20.91
			25	0	50	0	23.67	22.68	22.66	20.69	22.70	21.70	21.69	19.68	24.00	23.01	23.03	21.02
	831.6	838.8	1	24	1	0	25.68	24.69	<b>23.70</b>	<b>20.70</b>	<b>24.70</b>	<b>23.70</b>	22.66	19.64	25.36	25.13	24.02	21.03
			25	0	50	0	23.68	22.70	22.65	<b>20.70</b>	22.70	21.69	21.69	<b>19.70</b>	24.06	23.05	23.06	<b>21.07</b>
	836.8	844.0	1	24	1	0	<b>25.70</b>	<b>24.70</b>	23.69	<b>20.70</b>	24.69	<b>23.70</b>	<b>22.70</b>	19.64	<b>25.40</b>	<b>25.20</b>	<b>24.06</b>	21.03
			25	0	50	0	23.70	22.69	22.70	20.69	22.69	21.70	21.70	19.69	24.09	23.07	23.08	<b>21.07</b>

**OUTPUT POWER FOR LTE BAND 5 (10.0MHz + 5.0MHz)**

Bandwidth	PCC Frequency (MHz)	SCC1 Frequency (MHz)	PCC RB Size	PCC RB Offset	SCC1 RB Size	SCC1 RB Offset	Conducted Average (dBm)											
							ANT 1				ANT 2				ANT 3			
							QPSK	16QAM	64QAM	256QAM	QPSK	16QAM	64QAM	256QAM	QPSK	16QAM	64QAM	256QAM
10MHz / 5MHz	829.0	836.2	1	49	1	0	25.68	<b>24.70</b>	23.67	20.68	24.69	<b>23.70</b>	<b>22.70</b>	19.67	25.36	24.93	23.95	20.95
			50	0	25	0	23.70	22.70	22.70	<b>20.70</b>	22.70	21.70	21.70	<b>19.70</b>	24.06	23.08	23.07	21.02
	834.3	841.5	1	49	1	0	25.68	24.66	23.69	20.63	<b>24.70</b>	<b>23.70</b>	<b>22.70</b>	19.68	25.39	<b>25.10</b>	24.00	21.05
			50	0	25	0	23.66	22.66	22.66	20.68	22.69	21.70	21.70	<b>19.70</b>	24.08	23.10	23.09	<b>21.10</b>
	839.3	846.5	1	49	1	0	25.63	24.69	<b>23.70</b>	20.63	24.69	<b>23.70</b>	<b>22.70</b>	19.65	<b>25.40</b>	25.09	<b>24.02</b>	21.03
			50	0	25	0	23.67	22.69	22.68	20.67	22.66	21.70	21.67	<b>19.70</b>	24.10	23.09	23.11	<b>21.10</b>

**OUTPUT POWER FOR LTE BAND 5 (10.0MHz + 10.0MHz)**

Bandwidth	PCC Frequency (MHz)	SCC1 Frequency (MHz)	PCC RB Size	PCC RB Offset	SCC1 RB Size	SCC1 RB Offset	Conducted Average (dBm)											
							ANT 1				ANT 2				ANT 3			
							QPSK	16QAM	64QAM	256QAM	QPSK	16QAM	64QAM	256QAM	QPSK	16QAM	64QAM	256QAM
10MHz / 10MHz	829.0	838.9	1	49	1	0	25.68	<b>24.70</b>	23.67	20.64	24.69	<b>23.70</b>	<b>22.70</b>	19.60	25.12	<b>24.40</b>	<b>23.40</b>	20.17
			50	0	50	0	23.67	22.67	22.65	<b>20.70</b>	22.65	21.68	21.70	19.66	23.28	22.27	22.32	20.32
	831.5	841.4	1	49	1	0	<b>25.70</b>	24.61	<b>23.70</b>	20.69	<b>24.70</b>	<b>23.69</b>	<b>22.70</b>	19.65	25.37	<b>24.40</b>	<b>23.40</b>	<b>20.40</b>
			50	0	50	0	23.69	22.68	22.70	<b>20.70</b>	22.67	21.70	21.70	19.68	23.34	22.40	22.24	20.32
	834.1	844.0	1	49	1	0	<b>25.70</b>	24.66	23.66	20.67	24.69	23.64	22.69	19.60	<b>25.40</b>	<b>24.40</b>	<b>23.40</b>	20.08
			50	0	50	0	23.70	22.70	22.68	20.69	22.70	21.69	21.70	<b>19.70</b>	23.40	22.33	22.40	<b>20.40</b>

<b>Test Engineer ID:</b>	25602	<b>Test Date:</b>	4/24/2023
--------------------------	-------	-------------------	-----------

**OUTPUT POWER FOR LTE BAND 7 (10.0MHz + 20.0MHz)**

Bandwidth	PCC Frequency (MHz)	SCC1 Frequency (MHz)	PCC RB	PCC RB Offset	SCC1 RB	SCC1 RB Offset	Conducted Average (dBm)															
							ANT 1				ANT 2				ANT 3				ANT 4			
							QPSK	16QAM	64QAM	256QAM	QPSK	16QAM	64QAM	256QAM	QPSK	16QAM	64QAM	256QAM	QPSK	16QAM	64QAM	256QAM
10MHz / 20MHz	2505.5	2519.9	1	49	1	0	25.70	24.70	23.52	20.64	23.69	22.70	21.25	18.70	25.00	24.00	22.79	19.93	22.40	21.47	20.30	17.39
			50	0	100	0	23.70	22.70	22.70	20.69	21.70	20.70	20.70	18.68	23.00	22.00	22.00	20.00	22.50	19.53	19.50	17.49
	2525.6	2540.0	1	49	1	0	25.64	24.61	23.70	20.56	23.67	22.65	21.70	18.60	24.94	23.84	23.00	19.76	22.62	21.59	20.70	17.59
			50	0	100	0	23.67	22.70	22.70	20.69	21.69	20.67	20.68	18.68	22.97	21.96	21.95	20.00	20.70	19.70	19.70	17.70
	2545.6	2560.0	1	49	1	0	25.65	24.63	23.29	20.56	23.70	22.56	21.69	18.46	24.98	23.91	22.66	19.78	22.70	21.70	20.24	17.66
			50	0	100	0	23.64	22.65	22.68	20.70	21.68	20.68	20.67	18.65	22.94	21.97	21.97	19.93	20.64	19.68	19.66	17.64

**OUTPUT POWER FOR LTE BAND 7 (20.0MHz + 10.0MHz)**

Bandwidth	PCC Frequency (MHz)	SCC1 Frequency (MHz)	PCC RB	PCC RB Offset	SCC1 RB	SCC1 RB Offset	Conducted Average (dBm)															
							ANT 1				ANT 2				ANT 3				ANT 4			
							QPSK	16QAM	64QAM	256QAM	QPSK	16QAM	64QAM	256QAM	QPSK	16QAM	64QAM	256QAM	QPSK	16QAM	64QAM	256QAM
20MHz / 10MHz	2510.0	2524.4	1	99	1	0	25.70	24.66	23.70	20.60	23.70	22.70	21.70	18.50	25.00	24.00	22.77	19.91	22.43	21.41	20.39	17.38
			100	0	50	0	23.69	22.69	22.69	20.70	21.70	20.70	20.70	18.70	23.00	22.00	22.00	20.00	20.67	19.68	19.67	17.70
	2530.1	2544.5	1	99	1	0	25.68	24.70	23.70	20.49	23.68	22.67	21.57	18.49	24.96	23.88	23.00	19.71	22.70	21.58	20.70	17.49
			100	0	50	0	23.70	22.70	22.69	20.69	21.70	20.67	20.68	18.67	22.92	21.91	21.94	19.92	20.70	19.70	19.7	17.69
	2550.1	2564.5	1	99	1	0	25.65	24.67	23.35	20.44	23.64	22.63	21.52	18.41	24.94	23.91	22.61	19.87	22.25	21.70	20.34	17.50
			100	0	50	0	23.68	22.68	22.70	20.67	21.70	20.61	20.61	18.60	22.90	21.89	21.93	19.91	20.61	19.60	19.61	17.62

**OUTPUT POWER FOR LTE BAND 7 (15.0MHz + 15.0MHz)**

Bandwidth	PCC Frequency (MHz)	SCC1 Frequency (MHz)	PCC RB	PCC RB Offset	SCC1 RB	SCC1 RB Offset	Conducted Average (dBm)															
							ANT 1				ANT 2				ANT 3				ANT 4			
							QPSK	16QAM	64QAM	256QAM	QPSK	16QAM	64QAM	256QAM	QPSK	16QAM	64QAM	256QAM	QPSK	16QAM	64QAM	256QAM
15MHz / 15MHz	2507.5	2522.5	1	74	1	0	25.70	24.70	23.70	20.61	23.70	22.70	21.39	18.70	25.00	24.00	22.67	19.89	22.64	21.57	20.61	17.60
			75	0	75	0	23.70	22.70	22.70	20.70	21.70	20.70	20.69	18.69	23.00	22.00	22.00	20.00	20.59	19.56	19.58	17.59
	2527.5	2542.5	1	74	1	0	25.66	24.66	23.44	20.59	23.68	22.63	21.70	18.61	24.86	23.90	23.00	19.81	22.55	21.6	20.70	17.52
			75	0	75	0	23.69	22.68	22.69	20.67	21.70	20.66	20.70	18.70	22.92	21.93	21.94	19.93	20.70	19.7	19.70	17.70
	2547.5	2562.5	1	74	1	0	25.62	24.62	23.40	20.52	23.66	22.58	21.70	18.57	24.87	23.87	22.66	19.82	22.70	21.70	20.62	17.70
			75	0	75	0	23.61	22.70	22.62	20.66	21.66	20.67	20.66	18.64	22.91	21.90	21.91	19.91	20.66	19.66	19.65	17.66

**OUTPUT POWER FOR LTE BAND 7 (15.0MHz + 20.0MHz)**

Bandwidth	PCC Frequency (MHz)	SCC1 Frequency (MHz)	PCC RB	PCC RB Offset	SCC1 RB	SCC1 RB Offset	Conducted Average (dBm)															
							ANT 1				ANT 2				ANT 3				ANT 4			
							QPSK	16QAM	64QAM	256QAM	QPSK	16QAM	64QAM	256QAM	QPSK	16QAM	64QAM	256QAM	QPSK	16QAM	64QAM	256QAM
15MHz / 20MHz	2507.8	2524.9	1	74	1	0	25.70	24.70	23.70	20.61	23.68	22.70	21.41	18.65	25.00	24.00	22.76	19.96	22.61	21.59	20.70	17.60
			75	0	100	0	23.70	22.70	22.70	20.68	21.69	20.70	20.70	18.70	23.00	22.00	22.00	20.00	20.59	19.55	19.57	17.59
	2525.3	2542.4	1	74	1	0	25.66	24.61	23.65	20.59	23.70	22.67	21.70	18.62	24.85	23.90	23.00	19.83	22.51	21.59	20.63	17.52
			75	0	100	0	23.67	22.68	22.70	20.68	21.67	20.67	20.68	18.68	22.96	21.96	21.94	19.99	20.70	19.70	19.70	17.70
	2542.9	2560.0	1	74	1	0	25.69	24.69	23.48	20.54	23.62	22.61	21.59	18.55	24.88	23.96	22.54	19.87	22.70	21.70	20.39	17.70
			75	0	100	0	23.70	22.70	22.67	20.66	21.65	20.67	20.67	18.68	22.98	21.97	21.93	19.96	20.65	19.65	19.66	17.66

**OUTPUT POWER FOR LTE BAND 7 (20.0MHz + 15.0MHz)**

Bandwidth	PCC Frequency (MHz)	SCC1 Frequency (MHz)	PCC RB	PCC RB Offset	SCC1 RB	SCC1 RB Offset	Conducted Average (dBm)															
							ANT 1				ANT 2				ANT 3				ANT 4			
							QPSK	16QAM	64QAM	256QAM	QPSK	16QAM	64QAM	256QAM	QPSK	16QAM	64QAM	256QAM	QPSK	16QAM	64QAM	256QAM
20MHz / 15MHz	2510.0	2527.1	1	99	1	0	25.70	24.66	23.70	20.58	23.66	22.62	21.69	18.56	25.00	24.00	22.55	19.95	22.70	21.70	20.70	17.63
			100	0	75	0	23.70	22.70	22.70	20.68	21.69	20.70	20.70	18.70	23.00	22.00	22.00	20.00	20.62	19.63	19.66	17.64
	2527.6	2544.7	1	99	1	0	25.68	24.68	23.70	20.53	23.69	22.62	21.70	18.50	24.87	23.89	23.00	19.82	22.46	21.44	20.54	17.44
			100	0	75	0	23.67	22.68	22.69	20.70	21.68	20.67	20.66	18.67	22.96	21.99	21.99	19.98	20.70	19.70	19.70	17.70
	2545.1	2562.2	1	99	1	0	25.24	24.70	23.48	20.48	23.70	22.70	21.67	18.42	24.89	24.00	22.77	19.78	22.68	21.69	20.54	17.64
			100	0	75	0	23.70	22.68	22.69	20.66	21.70	20.67	20.67	18.67	22.95	21.97	22.00	19.99	20.60	19.64	19.64	17.64

**OUTPUT POWER FOR LTE BAND 7 (20.0MHz + 20.0MHz)**

Bandwidth	PCC Frequency (MHz)	SCC1 Frequency (MHz)	PCC RB	PCC RB Offset	SCC1 RB	SCC1 RB Offset	Conducted Average (dBm)															
							ANT 1				ANT 2				ANT 3				ANT 4			
							QPSK	16QAM	64QAM	256QAM	QPSK	16QAM	64QAM	256QAM	QPSK	16QAM	64QAM	256QAM	QPSK	16QAM	64QAM	256QAM
20MHz / 20MHz	2510.0	2529.8	1	99	1	0	25.30	24.58	23.35	20.59	23.61	22.60	21.68	18.62	24.53	23.90	22.61	19.88	22.51	21.65	20.55	17.59
			1	0	1	99	17.20	17.19	17.20	17.16	15.20	15.23	15.20	15.18	16.35	16.35	16.38	16.37	13.82	13.82	13.96	13.85
			100	0	100	0	23.70	22.68	22.64	20.68	21.69	20.64	20.69	18.71	22.95	21.93	21.94	19.98	20.41	19.44	19.59	17.55
			1	99	1	0	25.30	24.55	23.70	20.49	23.54	22.55	21.70	18.54	24.85	23.85	22.86	19.77	22.32	21.36	20.48	17.45
			1	0	1	99	17.20	17.19	17.14	17.17	15.14	15.20	15.13	15.15	16.50	16.50	16.43	16.50	14.20	14.20	14.20	14.20
			100	0	100	0	23.68	22.65	22.64	20.70	21.62	20.59	20.62	18.68	22.94	21.93	21.94	19.98	20.53	19.58	19.72	17.68
	2540.2	2560.0	1	99	1	0	25.44	24.59	23.68	20.49	23.52	22.51	21.85	18.45	24.92	23.87	22.88	19.86	22.50	21.56	20.30	17.62
			1	0	1	99	17.19	17.20	17.11	17.16	15.15	15.16	15.20	15.17	16.47	16.48	16.50	16.49	13.95	13.94	14.09	13.98
			100	0	100	0	23.70	22.67	22.63	20.66	21.63	20.58	20.62	18.70	22.91	21.88	21.91	19.95	20.48	19.50	19.62	17.60

<b>Test Engineer ID:</b>	12482	<b>Test Date:</b>	5/2/2023
--------------------------	-------	-------------------	----------

**OUTPUT POWER FOR LTE BAND 41 (5.0MHz + 20.0MHz)**

Bandwidth	PCC Frequency (MHz)	SCC1 Frequency (MHz)	PCC RB Size	PCC RB Offset	SCC1 RB Size	SCC1 RB Offset	Conducted Average (dBm)															
							ANT 1				ANT 2				ANT 3				ANT 4			
							QPSK	16QAM	64QAM	256QAM	QPSK	16QAM	64QAM	256QAM	QPSK	16QAM	64QAM	256QAM	QPSK	16QAM	64QAM	256QAM
5MHz / 20MHz	2499.3	2511.0	1	24	1	0	26.34	22.80	22.39	22.43	22.89	22.99	22.94	22.90	21.11	21.16	21.20	21.11	21.27	21.30	21.21	21.20
			25	0	100	0	22.55	22.55	22.51	22.52	23.00	23.03	23.06	23.00	21.20	21.20	21.26	21.20	21.30	21.30	21.30	21.30
	2583.8	2595.5	1	24	1	0	28.27	27.20	26.62	23.57	28.70	27.19	26.70	23.62	28.00	26.19	25.75	22.93	27.30	25.95	25.29	22.43
			25	0	100	0	26.70	25.70	25.70	23.70	26.70	25.68	25.70	23.70	26.00	24.71	25.00	23.00	25.70	24.70	24.70	22.70
	2668.3	2680.0	1	24	1	0	27.47	26.08	25.49	22.34	27.64	26.50	26.00	23.00	26.71	25.50	24.94	21.87	25.85	24.74	23.96	21.20
			25	0	100	0	25.56	24.56	24.57	22.56	26.00	25.00	25.00	23.00	24.78	23.54	24.00	22.00	24.30	23.30	23.30	21.30

**OUTPUT POWER FOR LTE BAND 41 (20.0MHz + 5.0MHz)**

Bandwidth	PCC Frequency (MHz)	SCC1 Frequency (MHz)	PCC RB Size	PCC RB Offset	SCC1 RB Size	SCC1 RB Offset	Conducted Average (dBm)															
							ANT 1				ANT 2				ANT 3				ANT 4			
							QPSK	16QAM	64QAM	256QAM	QPSK	16QAM	64QAM	256QAM	QPSK	16QAM	64QAM	256QAM	QPSK	16QAM	64QAM	256QAM
20MHz / 5MHz	2506.0	2517.7	1	99	1	0	26.34	25.80	26.07	22.48	26.52	26.28	26.31	22.58	25.08	24.54	24.42	21.20	25.04	24.48	24.80	21.10
			100	0	25	0	22.55	22.56	22.51	22.52	22.63	22.58	22.65	22.71	21.20	21.20	21.20	21.20	21.28	21.17	21.20	21.11
	2590.5	2602.2	1	99	1	0	28.36	27.20	26.70	23.70	28.46	26.72	26.38	23.31	28.00	26.31	25.79	22.96	27.53	25.94	25.49	22.46
			100	0	25	0	26.70	25.70	25.70	23.70	26.33	25.20	25.38	23.50	26.00	25.00	25.00	23.00	25.57	24.53	24.50	22.40
	2675.0	2686.7	1	99	1	0	27.42	25.87	25.39	22.45	27.41	26.00	25.57	22.72	26.91	25.17	24.72	21.80	26.30	24.80	24.30	21.30
			100	0	25	0	25.55	24.57	24.55	22.56	25.68	24.68	24.82	22.98	25.00	23.85	23.83	21.85	24.29	23.24	23.24	21.14

**OUTPUT POWER FOR LTE BAND 41 (10.0MHz + 20.0MHz)**

Bandwidth	PCC Frequency (MHz)	SCC1 Frequency (MHz)	PCC RB Size	PCC RB Offset	SCC1 RB Size	SCC1 RB Offset	Conducted Average (dBm)															
							ANT 1				ANT 2				ANT 3				ANT 4			
							QPSK	16QAM	64QAM	256QAM	QPSK	16QAM	64QAM	256QAM	QPSK	16QAM	64QAM	256QAM	QPSK	16QAM	64QAM	256QAM
10MHz / 20MHz	2501.5	2515.9	1	49	1	0	22.70	22.61	22.59	22.70	22.92	22.97	22.92	22.88	21.16	21.14	21.20	21.17	21.19	21.17	21.16	21.18
			50	0	100	0	22.70	22.67	22.70	22.70	23.00	23.00	23.00	23.00	21.20	21.20	21.19	21.20	21.30	21.30	21.30	21.30
	2583.6	2598.0	1	49	1	0	28.70	27.09	26.61	23.70	28.23	27.05	26.28	23.60	27.55	26.35	25.68	22.84	27.34	25.86	25.33	22.41
			50	0	100	0	26.70	25.70	26.7	23.70	26.70	25.69	25.70	23.70	26.00	25.00	25.00	23.00	25.70	24.70	24.70	22.70
	2665.6	2680.0	1	49	1	0	27.70	25.98	25.60	22.70	27.77	26.50	25.54	23.00	26.93	25.44	24.75	21.87	25.92	24.39	23.88	20.99
			50	0	100	0	25.70	24.57	24.70	22.70	26.00	25.00	25.00	23.00	25.00	24.00	23.86	22	24.30	23.30	23.30	21.30

**OUTPUT POWER FOR LTE BAND 41 (20.0MHz + 10.0MHz)**

Bandwidth	PCC Frequency (MHz)	SCC1 Frequency (MHz)	PCC RB Size	PCC RB Offset	SCC1 RB Size	SCC1 RB Offset	Conducted Average (dBm)															
							ANT 1				ANT 2				ANT 3				ANT 4			
							QPSK	16QAM	64QAM	256QAM	QPSK	16QAM	64QAM	256QAM	QPSK	16QAM	64QAM	256QAM	QPSK	16QAM	64QAM	256QAM
20MHz / 10MHz	2506.0	2520.4	1	99	1	0	26.59	26.10	25.94	22.70	26.89	26.42	26.00	23.00	25.20	24.70	24.70	21.20	25.30	24.80	24.80	21.30
			100	0	50	0	22.70	22.70	22.70	22.70	23.00	23.00	23.00	23.00	21.20	21.20	21.20	21.20	21.30	21.30	21.30	21.30
	2588.1	2602.5	1	99	1	0	28.70	27.07	26.52	23.70	28.55	27.20	26.70	23.70	28.00	26.50	26.00	23.00	27.70	26.20	25.70	22.70
			100	0	50	0	26.70	25.73	25.70	23.70	26.70	25.70	25.70	23.70	26.00	25.00	25.00	23.00	25.70	24.70	24.70	22.70
	2670.1	2684.5	1	99	1	0	27.61	25.94	25.70	22.70	27.84	26.50	26.00	23.00	27.00	25.50	25.00	22.00	26.30	24.80	24.30	21.30
			100	0	50	0	25.70	24.58	24.70	22.70	26.00	25.00	25.00	23.00	25.00	24.00	24.00	22.00	24.30	23.30	23.30	21.30

**OUTPUT POWER FOR LTE BAND 41 (15.0MHz + 15.0MHz)**

Bandwidth	PCC Frequency (MHz)	SCC1 Frequency (MHz)	PCC RB Size	PCC RB Offset	SCC1 RB Size	SCC1 RB Offset	Conducted Average (dBm)															
							ANT 1				ANT 2				ANT 3				ANT 4			
							QPSK	16QAM	64QAM	256QAM	QPSK	16QAM	64QAM	256QAM	QPSK	16QAM	64QAM	256QAM	QPSK	16QAM	64QAM	256QAM
15MHz / 15MHz	2503.5	2518.5	1	74	1	0	27.64	26.20	25.51	22.70	27.91	26.50	26.00	22.90	26.20	24.70	24.20	21.20	26.30	24.80	24.30	21.30
			75	0	75	0	22.70	22.70	22.70	22.70	23.00	23.00	23.00	23.00	21.20	21.20	21.20	21.20	21.30	21.30	21.30	21.30
	2585.5	2600.5	1	74	1	0	28.70	27.20	26.53	23.70	28.24	27.20	26.70	23.57	28.00	26.50	26.00	23.00	27.70	26.20	25.70	22.70
			75	0	75	0	26.70	25.70	25.70	23.70	26.70	25.70	25.70	23.70	26.00	25.00	25.00	23.00	25.70	24.70	24.70	22.70
	2667.5	2682.5	1	74	1	0	27.70	26.20	25.70	22.70	28.00	26.50	26.00	22.84	27.00	25.50	25.00	22.00	26.30	24.80	24.30	21.30
			75	0	75	0	25.70	24.70	24.70	22.70	26.00	25.00	25.00	23.00	25.00	24.00	24.00	22.00	24.30	23.30	23.30	21.30

**OUTPUT POWER FOR LTE BAND 41 (15.0MHz + 20.0MHz)**

Bandwidth	PCC Frequency (MHz)	SCC1 Frequency (MHz)	PCC RB Size	PCC RB Offset	SCC1 RB Size	SCC1 RB Offset	Conducted Average (dBm)															
							ANT 1				ANT 2				ANT 3				ANT 4			
							QPSK	16QAM	64QAM	256QAM	QPSK	16QAM	64QAM	256QAM	QPSK	16QAM	64QAM	256QAM	QPSK	16QAM	64QAM	256QAM
15MHz / 20MHz	2503.8	2520.9	1	74	1	0	27.70	26.20	25.49	22.70	27.89	26.50	26.00	22.77	26.20	24.70	24.20	21.20	26.3	24.80	24.30	21.30
			75	0	100	0	22.70	22.70	22.70	22.70	23.00	23.00	23.00	23.00	21.20	21.20	21.20	21.20	21.30	21.30	21.30	21.30
	2583.3	2600.4	1	74	1	0	28.70	27.20	26.60	23.70	28.32	27.20	26.70	23.53	28.00	26.50	26.00	23.00	27.70	26.20	25.70	22.70
			75	0	100	0	26.70	25.70	25.70	23.70	26.70	25.70	25.70	23.70	26.00	25.00	25.00	23.00	25.70	24.70	24.70	22.70
	2662.9	2680.0	1	74	1	0	27.70	26.20	25.70	22.70	27.97	26.50	26.00	22.86	27.00	25.50	25.00	22.00	26.30	24.80	24.30	21.30
			75	0	100	0	25.70	24.7	24.70	22.70	26.00	25.00	25.00	23.00	25.00	24.00	24.00	22.00	24.30	23.30	23.30	21.30

**OUTPUT POWER FOR LTE BAND 41 (20.0MHz + 15.0MHz)**

Bandwidth	PCC Frequency (MHz)	SCC1 Frequency (MHz)	PCC RB Size	PCC RB Offset	SCC1 RB Size	SCC1 RB Offset	Conducted Average (dBm)															
							ANT 1				ANT 2				ANT 3				ANT 4			
							QPSK	16QAM	64QAM	256QAM	QPSK	16QAM	64QAM	256QAM	QPSK	16QAM	64QAM	256QAM	QPSK	16QAM	64QAM	256QAM
20MHz / 15MHz	2506.0	2523.1	1	99	1	0	27.70	26.20	25.50	22.70	27.92	26.50	26.00	22.87	26.20	24.70	24.20	21.20	26.30	24.80	24.30	21.30
			100	0	75	0	22.70	22.70	22.70	22.70	23.00	23.00	23.00	23.00	21.20	21.20	21.20	21.20	21.30	21.30	21.30	21.30
	2585.6	2602.7	1	99	1	0	28.70	27.20	26.51	23.70	28.68	27.20	26.70	23.62	28.00	26.50	26.00	23.00	27.70	26.20	25.70	22.70
			100	0	75	0	26.70	25.70	25.70	23.70	26.70	25.70	25.70	23.70	26.00	25.00	25.00	23.00	25.70	24.70	24.70	22.70
	2665.1	2682.2	1	99	1	0	27.70	26.20	25.70	22.70	27.97	26.50	26.00	22.90	27.00	25.50	25.00	22.00	26.30	24.80	24.30	21.30
			100	0	75	0	25.70	24.70	24.70	22.70	26.00	25.00	25.00	23.00	25.00	24.00	24.00	22.00	24.3	23.30	23.30	21.30

**OUTPUT POWER FOR LTE BAND 41 (20.0MHz + 20.0MHz)**

Bandwidth	PCC Frequency (MHz)	SCC1 Frequency (MHz)	PCC RB Size	PCC RB Offset	SCC1 RB Size	SCC1 RB Offset	Conducted Average (dBm)															
							ANT 1				ANT 2				ANT 3				ANT 4			
							QPSK	16QAM	64QAM	256QAM	QPSK	16QAM	64QAM	256QAM	QPSK	16QAM	64QAM	256QAM	QPSK	16QAM	64QAM	256QAM
20MHz/ 20MHz	2506.0	2525.8	1	99	1	0	27.70	26.20	25.54	22.70	27.91	26.50	26.00	23.00	26.20	24.70	24.20	21.20	26.30	24.80	24.30	21.30
			1	0	1	99	14.70	14.70	14.70	14.70	15.00	15.00	15.00	15.00	13.20	13.20	13.20	13.20	13.30	13.30	13.30	13.30
			100	0	100	0	22.70	22.70	22.70	22.70	23.00	23.00	23.00	23.00	21.20	21.20	21.20	21.20	21.30	21.30	21.30	21.30
			1	99	1	0	28.70	27.20	26.53	23.70	28.30	27.20	26.70	23.70	28.00	26.50	26.00	23.00	27.70	26.20	25.70	22.70
			1	0	1	99	20.20	20.20	20.20	20.20	20.20	20.20	20.20	20.20	19.50	19.50	19.50	19.50	19.20	19.20	19.20	19.20
			100	0	100	0	26.70	25.70	25.70	23.70	26.70	25.70	25.70	23.70	26.00	25.00	25.00	23.00	25.70	24.70	24.70	22.70
	2660.2	2680.0	1	99	1	0	27.70	26.20	25.70	22.70	28.00	26.50	26.00	23.00	27.00	25.50	25.00	22.00	26.30	24.80	24.30	21.30
			1	0	1	99	19.20	19.20	19.20	19.20	19.50	19.50	19.50	19.50	18.50	18.50	18.50	18.50	17.80	17.80	17.80	17.80
			100	0	100	0	25.70	24.70	24.70	22.70	26.00	25.00	25.00	23.00	25.00	24.00	24.00	22.00	24.30	23.30	23.30	21.30

Test Engineer ID:	12482	Test Date:	4/25/2022
-------------------	-------	------------	-----------

**OUTPUT POWER FOR LTE BAND 48 (5.0MHz + 20.0MHz)**

Bandwidth	PCC Frequency (MHz)	SCC1 Frequency (MHz)	PCC RB Size	PCC RB Offset	SCC1 RB Size	SCC1 RB Offset	Conducted Average (dBm)																	
							ANT 7				ANT 8				ANT 9				ANT 4					
							QPSK	16QAM	64QAM	256QAM	QPSK	16QAM	64QAM	256QAM	QPSK	16QAM	64QAM	256QAM	QPSK	16QAM	64QAM	256QAM		
5MHz / 20MHz	3553.3	3565.0	1	24	1	0	20.50	20.50	20.50	20.50	20.50	20.50	20.50	20.50	20.50	20.50	20.50	20.50	19.70	19.70	19.70	19.70		
			25	0	100	0	14.00	14.00	14.00	14.00	14.00	14.00	14.00	14.00	14.00	14.00	14.00	14.00	14.00	13.20	13.20	13.20	13.20	
			1	24	1	0	24.00	24.00	24.00	20.99	24.00	24.00	24.00	20.93	23.61	23.60	20.58	23.20	23.20	23.20	20.20	20.20	20.20	20.20
3615.8	3627.5	3690.0	1	24	100	0	22.00	22.00	22.00	21.00	22.00	22.00	22.00	21.00	22.00	22.00	22.00	20.79	21.20	21.20	21.20	21.20	21.20	21.20
			25	0	100	0	20.50	20.50	20.50	20.50	20.50	20.50	20.50	20.50	20.50	20.50	20.50	20.50	20.50	19.70	19.70	19.70	19.70	
			1	24	1	0	14.00	14.00	14.00	14.00	14.00	14.00	14.00	14.00	14.00	14.00	14.00	14.00	14.00	13.20	13.20	13.20	13.20	
3678.3	3690.0	3690.0	1	24	100	0	20.50	20.50	20.50	20.50	20.50	20.50	20.50	20.50	20.50	20.50	20.50	20.50	20.50	19.70	19.70	19.70	19.70	
			25	0	100	0	14.00	14.00	14.00	14.00	14.00	14.00	14.00	14.00	14.00	14.00	14.00	14.00	14.00	13.20	13.20	13.20	13.20	
			1	24	100	0	24.00	24.00	24.00	20.99	24.00	24.00	24.00	20.93	23.61	23.60	20.58	23.20	23.20	23.20	20.20	20.20	20.20	20.20

**OUTPUT POWER FOR LTE BAND 48 (20.0MHz + 5.0MHz)**

Bandwidth	PCC Frequency (MHz)	SCC1 Frequency (MHz)	PCC RB Size	PCC RB Offset	SCC1 RB Size	SCC1 RB Offset	Conducted Average (dBm)																	
							ANT 7				ANT 8				ANT 9				ANT 4					
							QPSK	16QAM	64QAM	256QAM	QPSK	16QAM	64QAM	256QAM	QPSK	16QAM	64QAM	256QAM	QPSK	16QAM	64QAM	256QAM		
20MHz / 5MHz	3560.0	3571.7	1	99	1	0	20.50	20.50	20.50	20.50	20.50	20.50	20.50	20.50	20.50	20.50	20.50	20.50	19.70	19.70	19.70	19.70		
			100	0	25	0	14.00	14.00	14.00	14.00	14.00	14.00	14.00	14.00	14.00	14.00	14.00	14.00	14.00	13.20	13.20	13.20	13.20	
			1	99	1	0	24.00	24.00	24.00	20.97	24.00	24.00	24.00	20.94	23.80	23.74	23.62	20.82	23.20	23.20	23.20	20.20	20.20	
3622.5	3634.2	3690.0	1	99	1	0	22.00	22.00	22.00	21.00	22.00	22.00	22.00	21.00	22.00	22.00	22.00	20.82	21.20	21.20	21.20	21.20	21.20	21.20
			100	0	25	0	20.50	20.50	20.50	20.50	20.50	20.50	20.50	20.50	20.50	20.50	20.50	20.50	20.50	19.70	19.70	19.70	19.70	
			1	99	1	0	14.00	14.00	14.00	14.00	14.00	14.00	14.00	14.00	14.00	14.00	14.00	14.00	14.00	13.20	13.20	13.20	13.20	
3685.0	3696.7	3690.0	1	99	1	0	20.50	20.50	20.50	20.50	20.50	20.50	20.50	20.50	20.50	20.50	20.50	20.50	20.50	19.70	19.70	19.70	19.70	
			100	0	25	0	14.00	14.00	14.00	14.00	14.00	14.00	14.00	14.00	14.00	14.00	14.00	14.00	14.00	13.20	13.20	13.20	13.20	
			1	99	1	0	24.00	24.00	24.00	20.97	24.00	24.00	24.00	20.94	23.80	23.74	23.62	20.82	23.20	23.20	23.20	20.20	20.20	

**OUTPUT POWER FOR LTE BAND 48 (10.0MHz + 20.0MHz)**

Bandwidth	PCC Frequency (MHz)	SCC1 Frequency (MHz)	PCC RB Size	PCC RB Offset	SCC1 RB Size	SCC1 RB Offset	Conducted Average (dBm)																
							ANT 7				ANT 8				ANT 9				ANT 4				
							QPSK	16QAM	64QAM	256QAM	QPSK	16QAM	64QAM	256QAM	QPSK	16QAM	64QAM	256QAM	QPSK	16QAM	64QAM	256QAM	
10MHz / 20MHz	3555.5	3569.9	1	49	1	0	20.00	20.00	20.00	20.00	20.00	20.00	20.00	20.00	20.00	20.00	20.00	20.00	19.20	19.20	19.20	19.20	
			50	0	100	0	15.00	15.00	15.00	15.00	15.00	15.00	15.00	15.00	15.00	15.00	15.00	15.00	15.00	14.20	14.20	14.20	14.20
			1	49	1	0	24.50	24.50	24.00	21.00	24.50	24.50	24.00	20.86	24.34	24.22	23.59	21.00	23.70	23.70	23.20	20.20	20.20
3615.6	3630.0	3690.0	1	49	1	0	21.50	21.50	21.50	21.00	21.50	21.50	21.50	21.00	21.50	21.50	21.00	21.00	20.70	20.70	20.70	20.70	
			50	0	100	0	20.00	20.00	20.00	20.00	20.00	20.00	20.00	20.00	20.00	20.00	20.00	20.00	20.00	19.20	19.20	19.20	19.20
			1	49	1	0	24.50	24.50	24.00	21.00	24.50	24.50	24.00	20.86	24.34	24.22	23.59	21.00	23.70	23.70	23.20	20.20	20.20
3675.6	3690.0	3690.0	1	49	1	0	20.00	20.00	20.00	20.00	20.00	20.00	20.00	20.00	20.00	20.00	20.00	20.00	20.00	19.20	19.20	19.20	19.20
			50	0	100	0	15.00	15.00	15.00	15.00	15.00	15.00	15.00	15.00	15.00	15.00	15.00	15.00	15.00	14.20	14.20	14.20	14.20
			1	49	1	0	24.50	24.50	24.00	21.00	24.50	24.50	24.00	20.86	24.34	24.22	23.59	21.00	23.70	23.70	23.20	20.20	20.20

**OUTPUT POWER FOR LTE BAND 48 (20.0MHz + 10.0MHz)**

Bandwidth	PCC Frequency (MHz)	SCC1 Frequency (MHz)	PCC RB Size	PCC RB Offset	SCC1 RB Size	SCC1 RB Offset	Conducted Average (dBm)																
							ANT 7				ANT 8				ANT 9				ANT 4				
							QPSK	16QAM	64QAM	256QAM	QPSK	16QAM	64QAM	256QAM	QPSK	16QAM	64QAM	256QAM	QPSK	16QAM	64QAM	256QAM	
20MHz / 10MHz	3560.0	3574.4	1	99	1	0	20.00	20.00	20.00	20.00	20.00	20.00	20.00	20.00	20.00	20.00	20.00	20.00	19.20	19.20	19.20	19.20	
			100	0	50	0	15.00	15.00	15.00	15.00	15.00	15.00	15.00	15.00	15.00	15.00	15.00	15.00	15.00	14.20	14.20	14.20	14.20
			1	99	1	0	24.50	24.50	24.00	21.00	24.50	24.50	24.00	20.86	24.34	24.22	23.59	21.00	23.70	23.70	23.20	20.20	20.20
3620.1	3634.5	3690.0	1	99	1	0	21.50	21.50	21.50	21.00	21.50	21.50	21.50	21.00	21.50	21.50	21.00	21.00	20.70	20.70	20.70	20.70	
			100	0	50	0	20.00	20.00	20.00	20.00	20.00	20.00	20.00	20.00	20.00	20.00	20.00	20.00	20.00	19.20	19.20	19.20	19.20
			1	99	1	0	24.50	24.50	24.00	21.00	24.50	24.50	24.00	20.86	24.34	24.22	23.59	21.00	23.70	23.70	23.20	20.20	20.20
3680.1	3694.5	3690.0	1	99	1	0	20.00	20.00	20.00	20.00	20.00	20.00	20.00	20.00	20.00	20.00	20.00	20.00	20.00	19.20	19.20	19.20	19.20
			100	0	50	0	15.00	15.00	15.00	15.00	15.00	15.00	15.00	15.00	15.00	15.00	15.00	15.00	15.00	14.20	14.20	14.20	14.20
			1	99	1	0	24.50	24.50	24.00	21.00	24.50	24.50	24.00	20.86	24.34	24.22	23.59	21.00	23.70	23.70	23.20	20.20	20.20

**OUTPUT POWER FOR LTE BAND 48 (15.0MHz + 20.0MHz)**

Bandwidth	PCC Frequency (MHz)	SCC1 Frequency (MHz)	PCC RB Size	PCC RB Offset	SCC1 RB Size	SCC1 RB Offset	Conducted Average (dBm)															
							ANT 7				ANT 8				ANT 9				ANT 4			
							QPSK	16QAM	64QAM	256QAM	QPSK	16QAM	64QAM	256QAM	QPSK	16QAM	64QAM	256QAM	QPSK	16QAM	64QAM	256QAM
15MHz / 20MHz	3557.8	3574.9	1	74	1	0	20.00	20.00	20.00	20.00	19.95	19.96	20.00	19.98	20.00	20.00	20.00	20.00	18.90	18.92	18.90	18.86
			75	0	100	0	15.00	15.00	15.00	15.00	15.00	15.00	15.00	15.07	15.00	15.00	15.00	15.00	14.19	14.20	14.20	14.18
			1	74	1	0	25.00	25.00	24.00	21.00	24.85	24.85	23.86	20.88	24.78	24.66	23.65	21.00	24.20	24.20	23.20	20.20
3615.3	3632.4	3690.0	1	74	1	0	21.50	21.50	21.50	21.00	21.47	21.48	21.45	20.95	21.50	21.50	21.00	21.00	20.70	20.70	20.70	20.20
			75	0	100	0	20.00	20.00	20.00	20.00	19.59	19.55	19.61	19.53	20.00	20.00	20.00	20.00	19.20	19.20	19.20	19.20
			1	74	1	0	25.00	25.00	24.00	21.00	24.85	24.85	23.86	20.88	24.78	24.66	23					



## 9. CONDUCTED TEST RESULTS

### 9.1. OCCUPIED BANDWIDTH

#### RULE PART(S)

FCC: §2.1049

#### LIMITS

For reporting purposes only

#### TEST PROCEDURE

The transmitter output was connected to a calibrated coaxial cable and coupler, the other end of which was connected to a spectrum analyzer. The occupied bandwidth was measured with the spectrum analyzer at the middle channel in each band. The 99% and -26dB bandwidths was also measured and recorded.

#### RESULTS

There is no limit required and power is the same for low, middle and high channel; therefore, only middle channel was tested. Only QPSK plots are reported to show setting parameter complies with testing method/procedure.

**LTE BAND 5**

Band	Mode	RB Allocation/RB Offset	f (MHz)	99% BW (MHz)	- 26dB BW (MHz)
LTE BAND 5	3MHz + 5MHz BAND QPSK	15/0 + 25/0	836.5	7.4936	8.081
	3MHz + 5MHz BAND 16QAM			7.4933	8.080
	5MHz + 3MHz BAND QPSK	25/0 + 15/0		7.5035	8.140
	5MHz + 3MHz BAND 16QAM			7.4966	8.156
	5MHz + 10MHz BAND QPSK	25/0 + 50/0		13.866	14.74
	5MHz + 10MHz BAND 16QAM			13.893	14.79
	10MHz + 5MHz BAND QPSK	50/0 + 25/0		13.872	14.77
	10MHz + 5MHz BAND 16QAM			13.862	14.67
	10MHz + 10MHz BAND QPSK	50/0 + 50/0		18.749	19.82
	10MHz + 10MHz BAND 16QAM			18.751	19.76

**LTE Band 7**

Band	Mode	RB Allocation/RB Offset	f (MHz)	99% BW (MHz)	- 26dB BW (MHz)
LTE BAND 7	10MHz + 20MHz BAND QPSK	50/0 + 100/0	2535	28.299	30.57
	10MHz + 20MHz BAND 16QAM			28.292	30.61
	20MHz + 10MHz BAND QPSK	100/0 + 50/0		28.296	30.58
	20MHz + 10MHz BAND 16QAM			28.199	32.4
	15MHz + 15MHz BAND QPSK	75/0 + 75/0		28.786	31.12
	15MHz + 15MHz BAND 16QAM			28.799	31.13
	15MHz + 20MHz BAND QPSK	75/0 + 100/0		33.079	35.58
	15MHz + 20MHz BAND 16QAM			32.995	35.39
	20MHz + 15MHz BAND QPSK	100/0 + 75/0		33.038	35.61
	20MHz + 15MHz BAND 16QAM			33.024	35.53
	20MHz + 20MHz BAND QPSK	100/0 + 100/0		37.841	40.73
	20MHz + 20MHz BAND 16QAM			37.845	40.65

**LTE BAND 41**

Band	Mode	RB Allocation/RB Offset	f (MHz)	99% BW (MHz)	- 26dB BW (MHz)
LTE BAND 41	5MHz + 20MHz BAND QPSK	25/0 + 100/0	2593	23.420	25.4
	5MHz + 20MHz BAND 16QAM			23.366	25.26
	20MHz + 5MHz BAND QPSK	100/0 + 25/0		23.403	25.26
	20MHz + 5MHz BAND 16QAM			23.346	25.43
	10MHz + 20MHz BAND QPSK	50/0 + 100/0		28.145	30.39
	10MHz + 20MHz BAND 16QAM			28.113	30.27
	20MHz + 10MHz BAND QPSK	100/0 + 50/0		28.183	30.30
	20MHz + 10MHz BAND 16QAM			28.071	30.25
	15MHz + 15MHz BAND QPSK	75/0 + 75/0		28.706	31.10
	15MHz + 15MHz BAND 16QAM			28.661	31.12
	15MHz + 20MHz BAND QPSK	75/0 + 100/0		33.003	35.40
	15MHz + 20MHz BAND 16QAM			32.973	35.41
	20MHz + 15MHz BAND QPSK	100/0 + 75/0		33.008	35.45
	20MHz + 15MHz BAND 16QAM			32.924	35.50
	20MHz + 20MHz BAND QPSK	100/0 + 100/0		37.799	40.44
	20MHz + 20MHz BAND 16QAM			37.843	40.26

**LTE BAND 48**

Band	Mode	RB Allocation/RB Offset	f (MHz)	99% BW (MHz)	- 26dB BW (MHz)
48	5MHz + 20MHz BAND QPSK	25/0 + 100/0	3625	23.252	25.13
	5MHz + 20MHz BAND 16QAM			23.178	24.89
	20MHz + 5MHz BAND QPSK	100/0 + 25/0		23.268	25.19
	20MHz + 5MHz BAND 16QAM			23.272	24.87
	10MHz + 20MHz BAND QPSK	50/0 + 100/0		27.876	29.88
	10MHz + 20MHz BAND 16QAM			28.056	29.87
	20MHz + 10MHz BAND QPSK	100/0 + 50/0		28.035	29.74
	20MHz + 10MHz BAND 16QAM			28.101	30.15
	15MHz + 20MHz BAND QPSK	75/0 + 100/0		32.695	35.01
	15MHz + 20MHz BAND 16QAM			32.857	34.88
	20MHz + 15MHz BAND QPSK	100/0 + 75/0		32.834	34.95
	20MHz + 15MHz BAND 16QAM			32.858	34.93
	20MHz + 20MHz BAND QPSK	100/0 + 100/0		37.509	39.92
	20MHz + 20MHz BAND 16QAM			37.552	40.09



### 9.1.2 LTE BAND 7

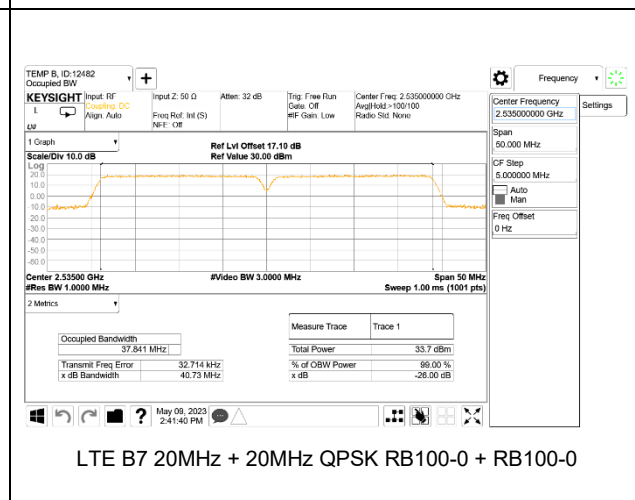
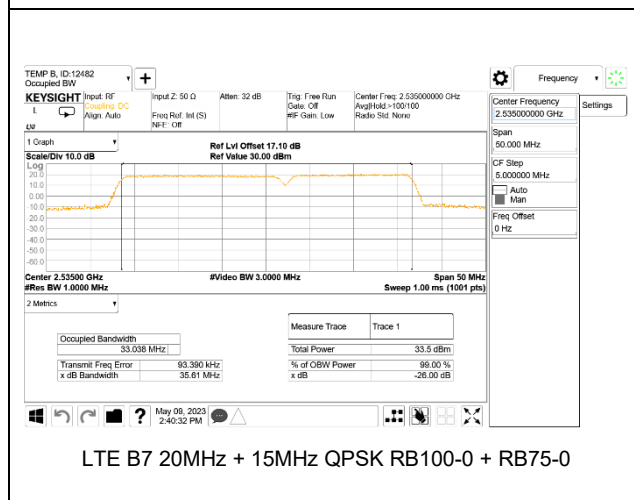
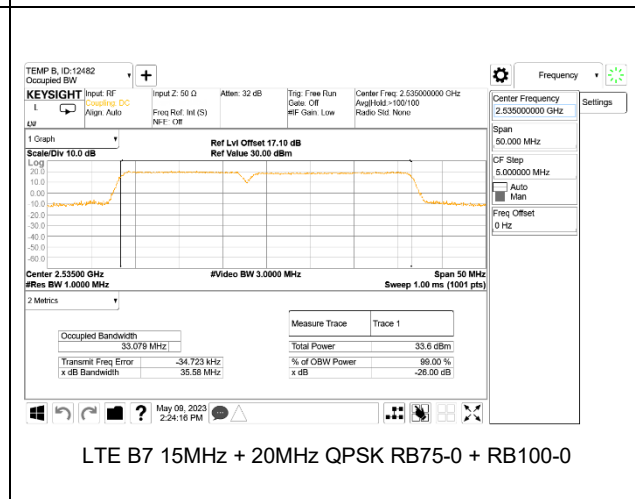
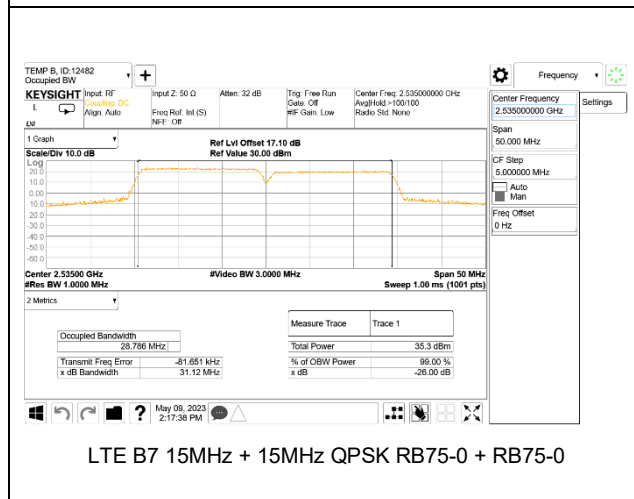
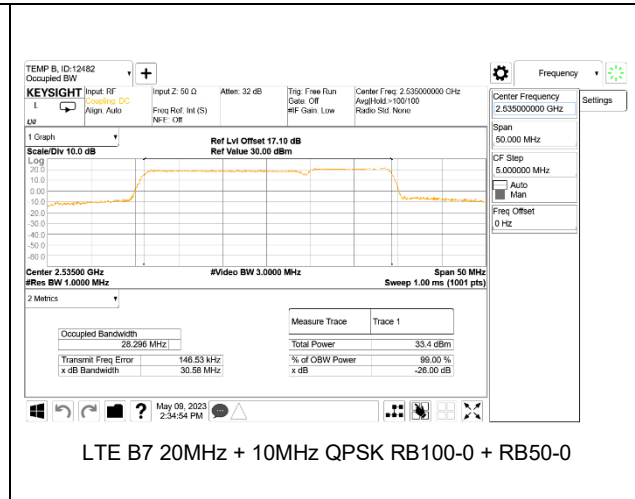
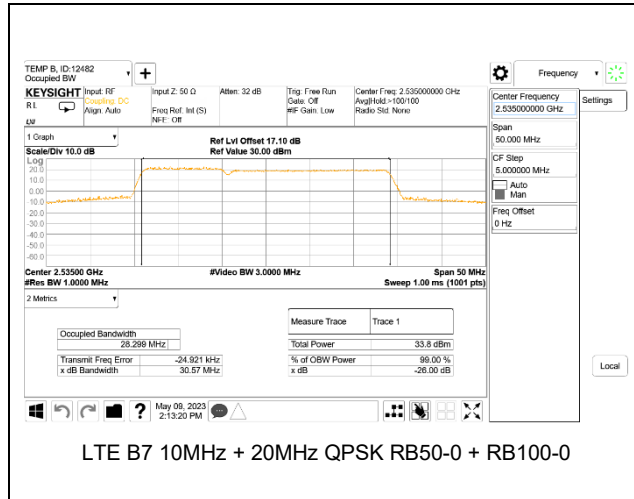

### 9.1.3 LTE BAND 41

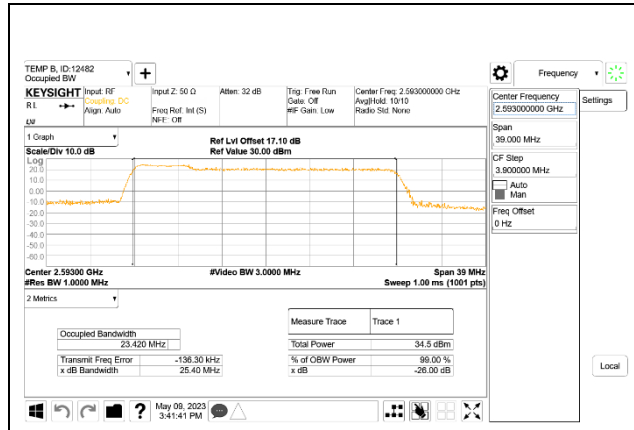

LTE B41 5MHz + 20MHz QPSK RB25-0 + RB100-0

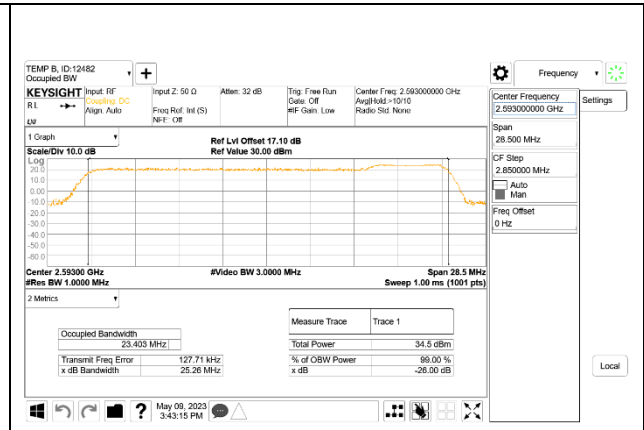

LTE B41 20MHz + 5MHz QPSK RB100-0 + RB25-0

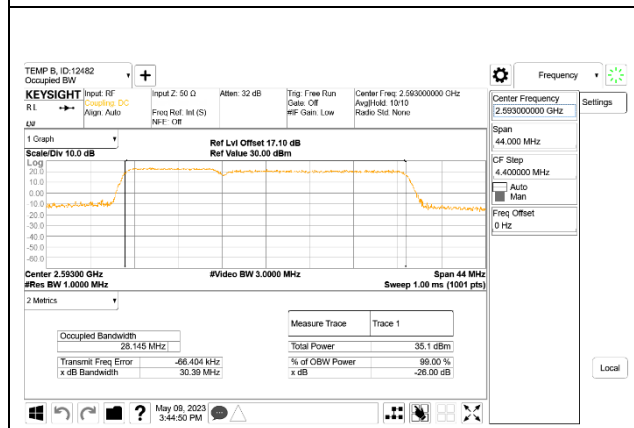

LTE B41 10MHz + 20MHz QPSK RB50-0 + RB100-0

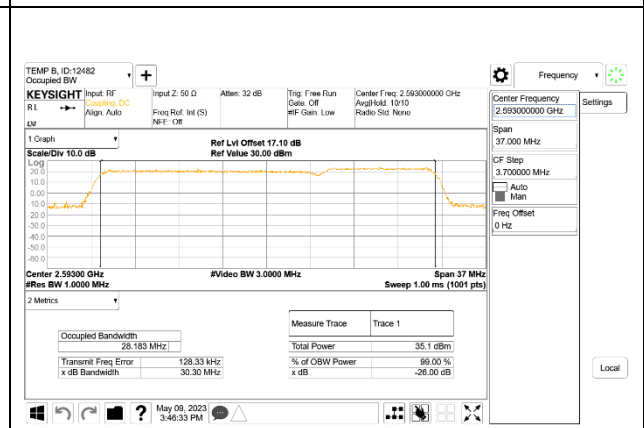

LTE B41 20MHz + 10MHz QPSK RB100-0 + RB50-0

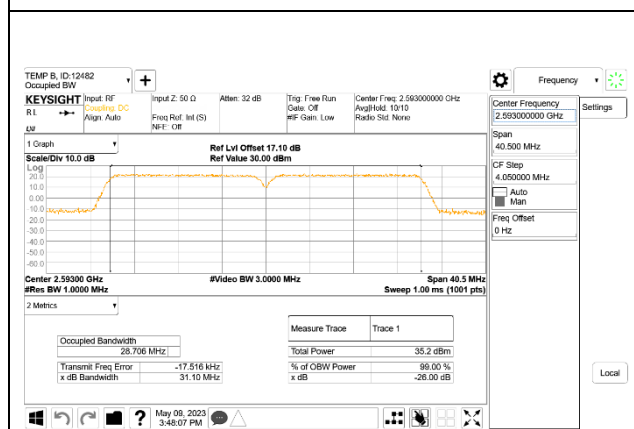

LTE B41 15MHz + 15MHz QPSK RB75-0 + RB75-0

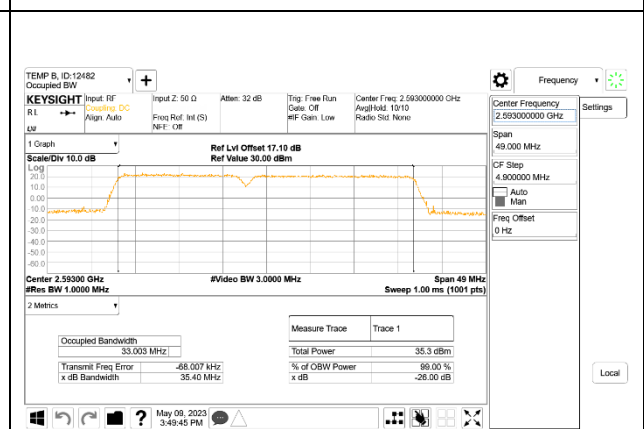

LTE B41 15MHz + 20MHz QPSK RB75-0 + RB100-0

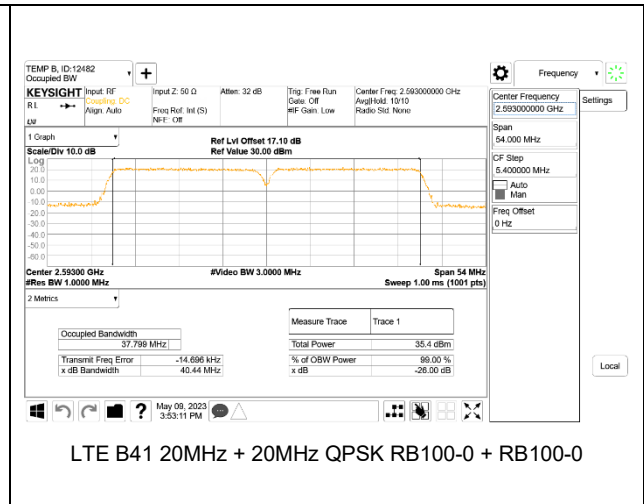
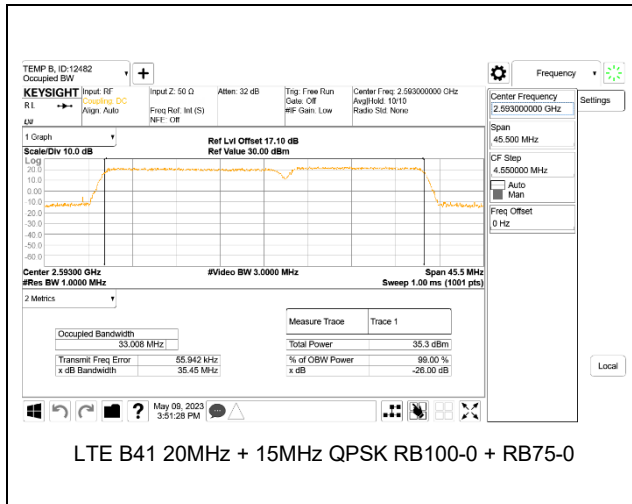

### 9.1.4 LTE BAND 48

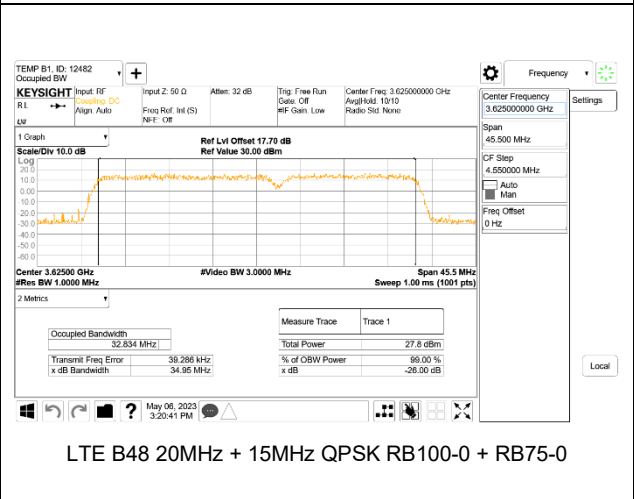
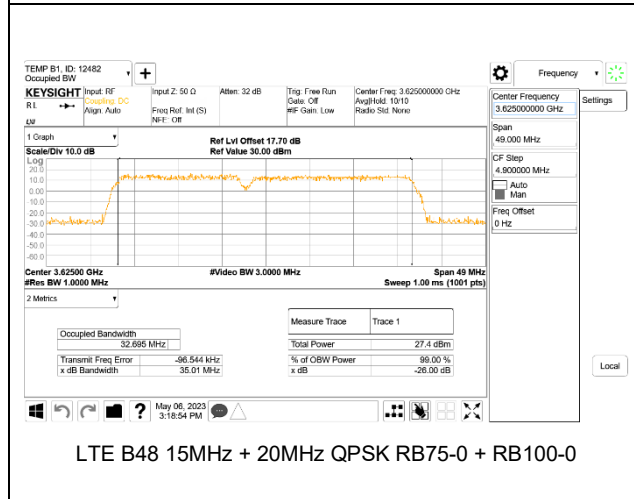
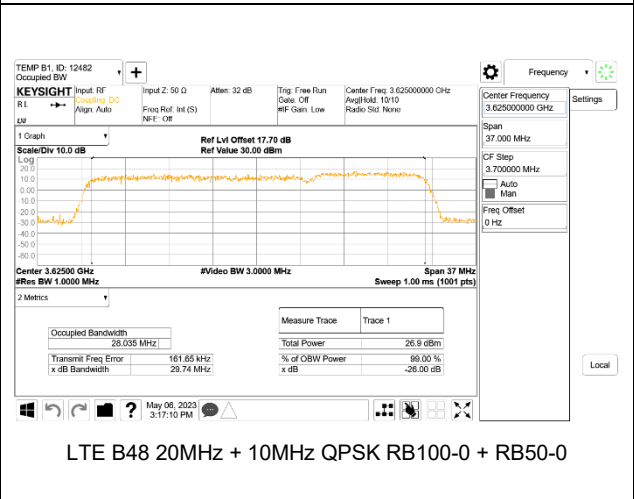
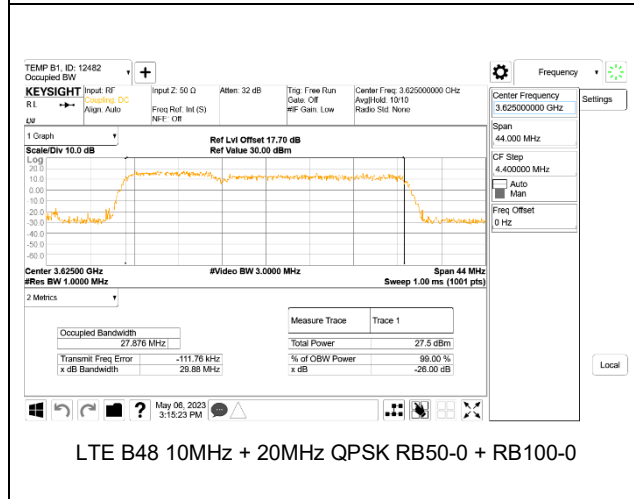
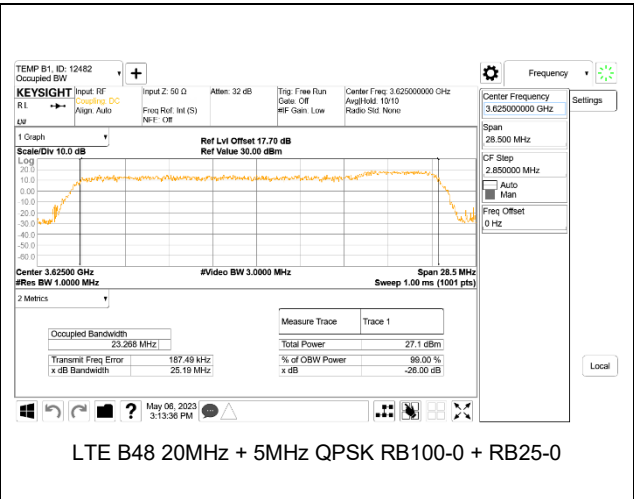
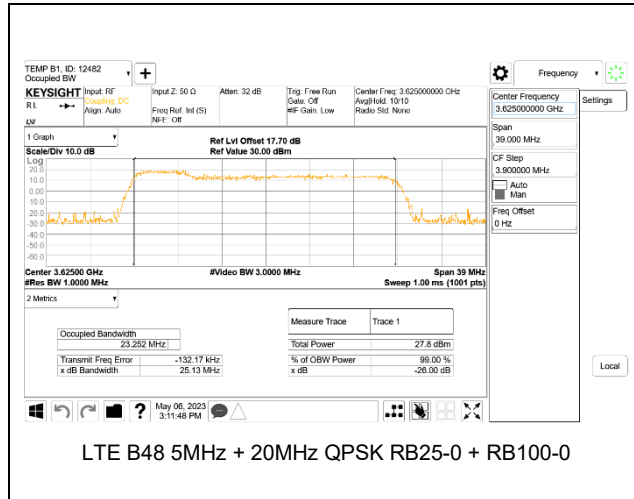



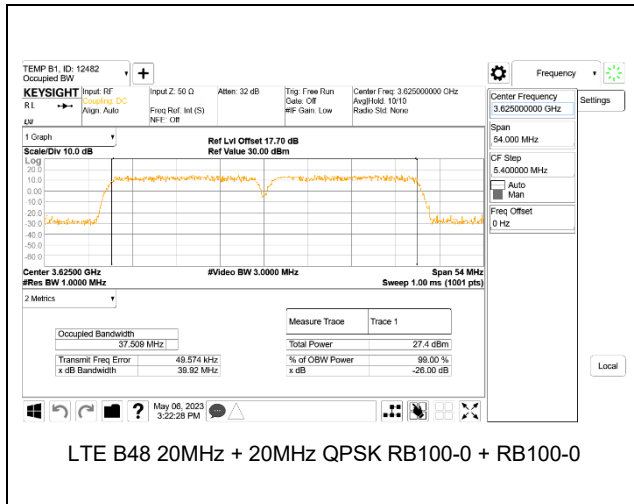

## 9.2. EMISSION MASK AND ADJACENT CHANNEL POWER

### TEST PROCEDURE

The transmitter output was connected to a R&S CMW500 Test Set and configured to operate at maximum power. The band edge emissions were measured at the required operating frequencies in each band on the Spectrum Analyzer.

For each band edge measurement:

- Set the spectrum analyzer span to include the block edge frequency.
- Set a marker to point the corresponding band edge frequency in each test case.
- Set display line at -13 dBm
- Set resolution bandwidth to at least 1% of emission bandwidth.

### TEST PROCEDURE FOR FCC PART 27

(m)(6) Measurement procedure. Compliance with these rules is based on the use of measurement instrumentation employing a resolution bandwidth of 1 megahertz or greater. However, in the 1 MHz bands immediately outside and adjacent to the frequency block a resolution bandwidth of at least one percent of the emission bandwidth of the fundamental emission of the transmitter may be employed; for mobile digital stations, in the 1 megahertz bands immediately outside and adjacent to the frequency block a resolution bandwidth of at least two percent may be employed, except when the 1 megahertz band is 2495-2496 MHz, in which case a resolution bandwidth of at least one percent may be employed. A narrower resolution bandwidth is permitted in all cases to improve measurement accuracy provided the measured power is integrated over the full required measurement bandwidth (i.e. 1 megahertz or 1 percent of emission bandwidth, as specified; or 1 megahertz or 2 percent for mobile digital stations, except in the band 2495-2496 MHz). The emission bandwidth is defined as the width of the signal between two points, one below the carrier center frequency and one above the carrier center frequency, outside of which all emissions are attenuated at least 26 dB below the transmitter power. With respect to television operations, measurements must be made of the separate visual and aural operating powers at sufficiently frequent intervals to ensure compliance with the rules.

### TEST PROCEDURE FOR FCC PART 96

(3) Measurement procedure.

(i) Compliance with this provision is based on the use of measurement instrumentation employing a resolution bandwidth of 1 megahertz or greater. However, in the 1 megahertz bands immediately outside and adjacent to the licensee's authorized frequency channel, a resolution bandwidth of no less than one percent of the fundamental emission bandwidth may be employed. A narrower resolution bandwidth is permitted in all cases to improve measurement accuracy provided the measured power is integrated over the full reference bandwidth (i.e., 1 MHz or 1 percent of emission bandwidth, as specified). The fundamental emission bandwidth is defined as the width of the signal between two points, one below the carrier center frequency and one above the carrier center frequency, outside of which all emissions are attenuated at least 26 dB below the transmitter power.

(ii) When measuring unwanted emissions to demonstrate compliance with the limits, the CBSD and End User Device nominal carrier frequency/channel shall be adjusted as close to the licensee's authorized frequency block edges, both upper and lower, as the design permits.

(iii) Compliance with emission limits shall be demonstrated using either average (RMS)-detected or peak-detected power measurement techniques.

### RESULTS

### 9.2.1 LTE BAND 5 EMISSION MASK

#### LIMITS

FCC: §22.917

The power of any emission outside of the authorized operating frequency ranges must be attenuated below the transmitting power (P) by a factor of at least  $43 + 10 \log(P)$  dB.

Equipment shall meet the unwanted emission limits specified below:

- (i) In the first 1.0 MHz band immediately outside and adjacent to each of the sub-bands specified in Section 5.1, the power of emissions per any 1% of the occupied bandwidth shall be attenuated below the transmitter output power P (dBW) by at least  $43 + 10 \log(p)$  dB.
- (ii) After the first 1.0 MHz immediately outside and adjacent to each of the sub-bands, the power of emissions in any 100 kHz bandwidth shall be attenuated below the transmitter output power P (dBW) by at least  $43 + 10 \log(p)$  dB. If the measurement is performed using 1% of the occupied bandwidth, power integration over 100 kHz is required.

p is the output power specified in watts.

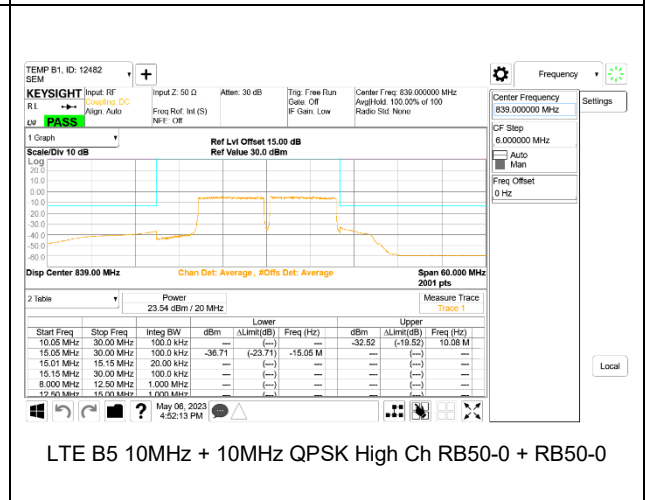
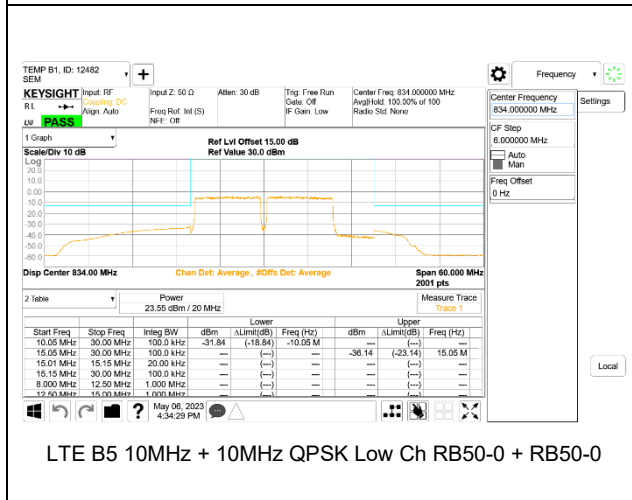
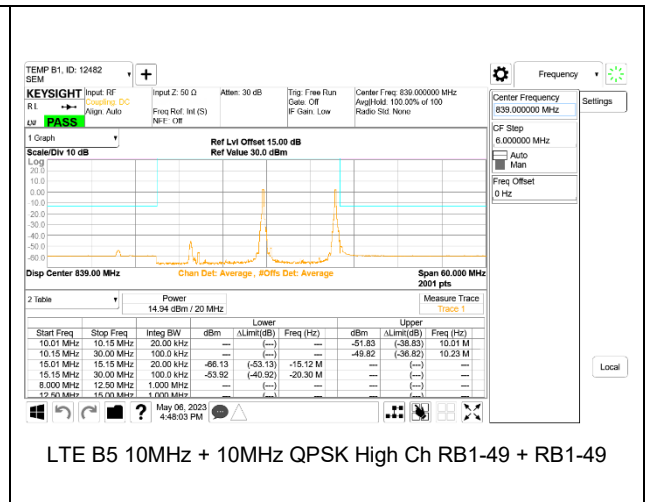
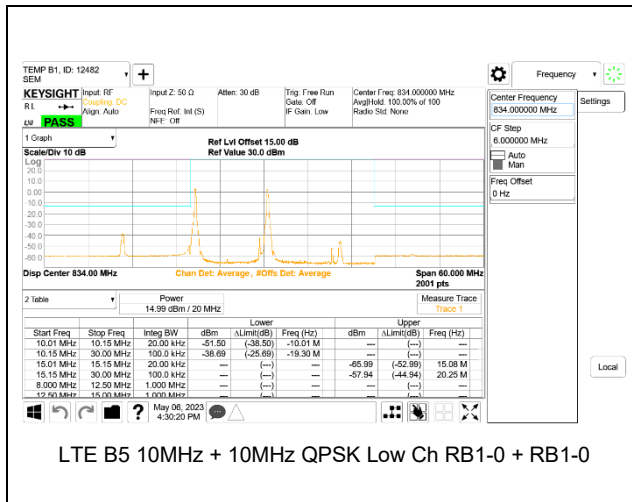

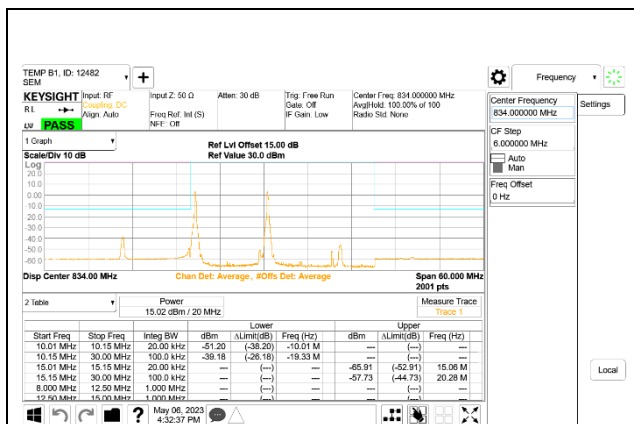

LTE B5 10MHz + 10MHz 16QAM Low Ch RB1-0 + RB1-0

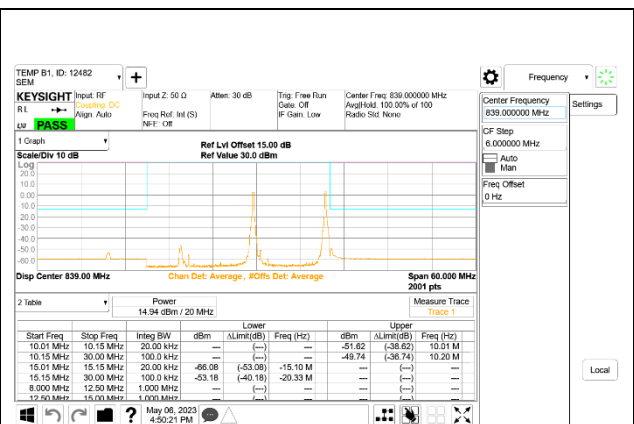

LTE B5 10MHz + 10MHz 16QAM High Ch RB1-49 + RB1-49

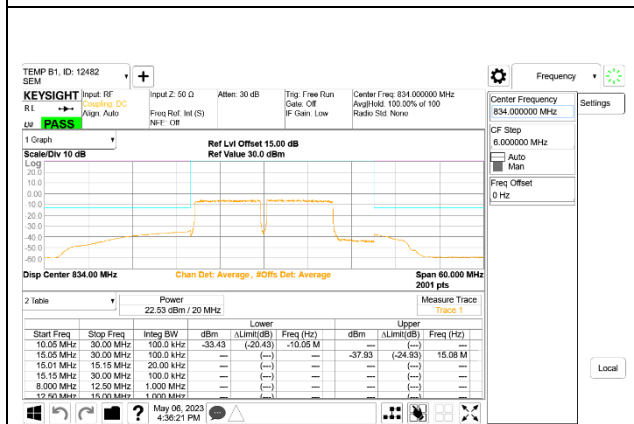

LTE B5 10MHz + 10MHz 16QAM Low Ch RB50-0 + RB50-0

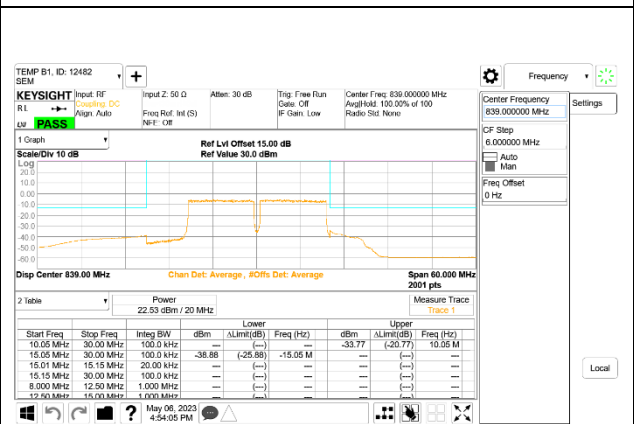

LTE B5 10MHz + 10MHz 16QAM High Ch RB50-0 + RB50-0

## 9.2.2 LTE BAND 7 EMISSION MASK

### LIMITS

FCC: §27.53(m)(4) For mobile digital stations, the attenuation factor shall be not less than 40 + 10 log (P) dB on all frequencies between the channel edge and 5 megahertz from the channel edge, 43 + 10 log (P) dB on all frequencies between 5 megahertz and X megahertz from the channel edge, and 55 + 10 log (P) dB on all frequencies more than X megahertz from the channel edge, where X is the greater of 6 megahertz or the actual emission bandwidth as defined in paragraph (m)(6) of this section. In addition, the attenuation factor shall not be less that 43 + 10 log (P) dB on all frequencies between 2490.5 MHz and 2496 MHz and 55 + 10 log (P) dB at or below 2490.5 MHz. Mobile Satellite Service licensees operating on frequencies below 2495 MHz may also submit a documented interference complaint against BRS licensees operating on channel BRS Channel 1 on the same terms and conditions as adjacent channel BRS or EBS licensees.

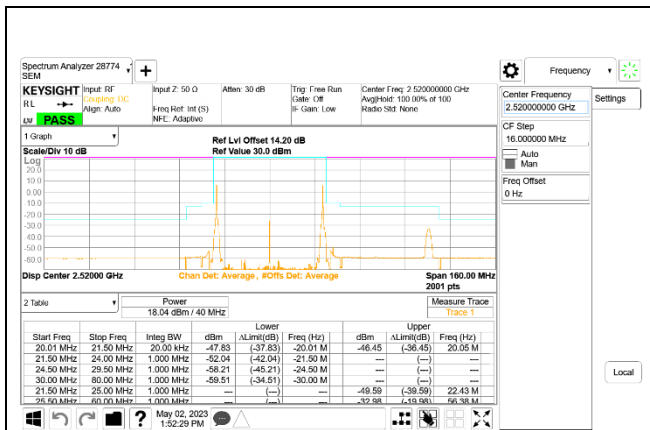

LTE B7 20MHz + 20MHz QPSK Low Ch RB1-0 + RB1-99

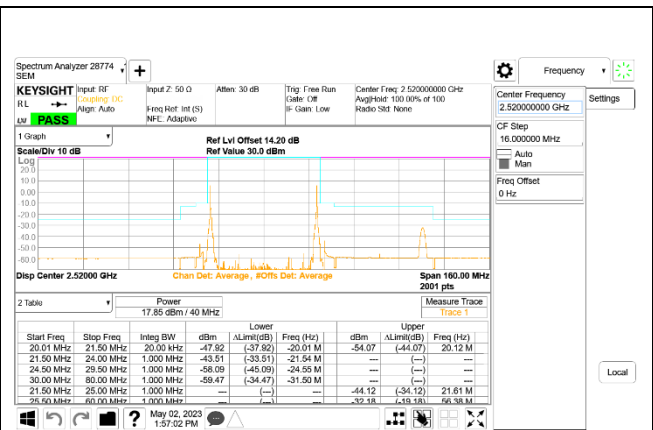

LTE B7 20MHz + 20MHz 16QAM Low Ch RB1-0 + RB1-99

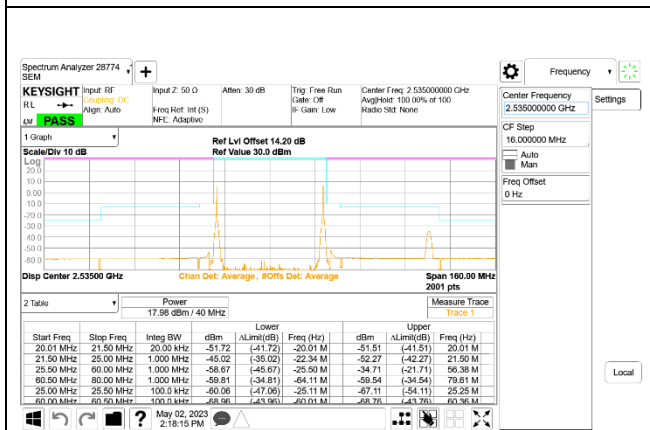

LTE B7 20MHz + 20MHz QPSK Mid Ch RB1-0 + RB1-99

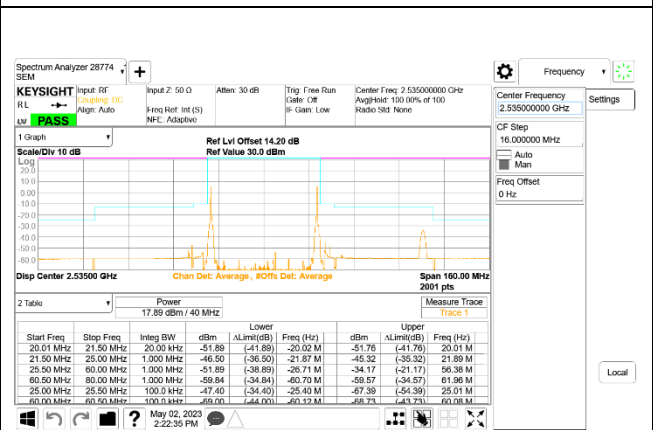

LTE B7 20MHz + 20MHz 16QAM Mid Ch RB1-0 + RB1-99

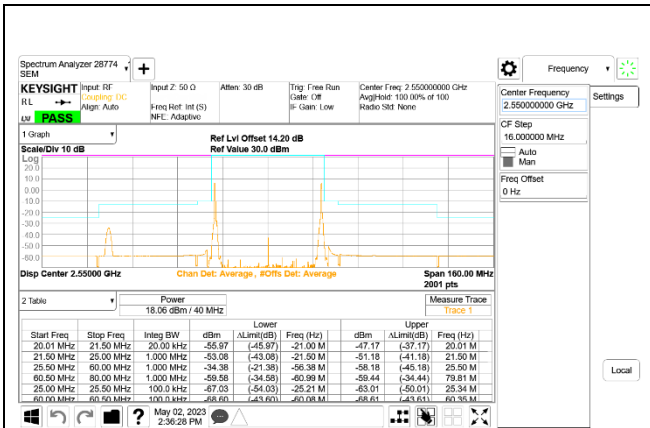

LTE B7 20MHz + 20MHz QPSK High Ch RB1-0 + RB1-99

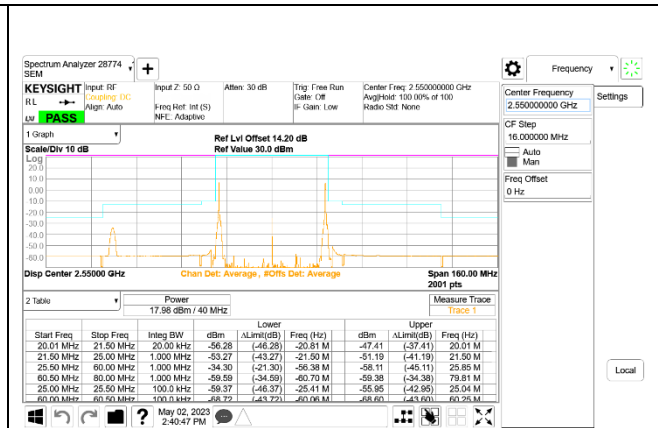

LTE B7 20MHz + 20MHz 16QAM High Ch RB1-0 + RB1-99

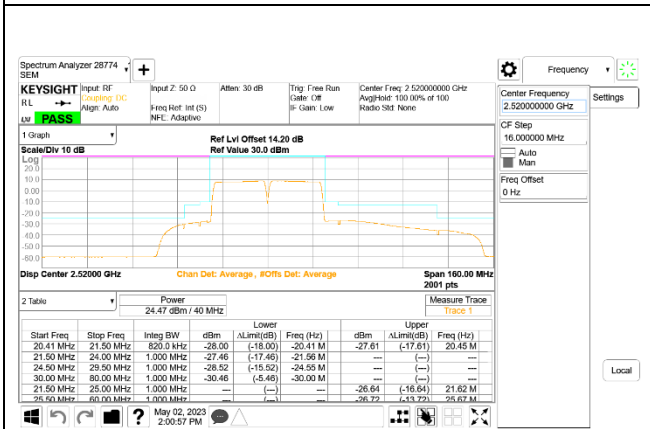

LTE B7 20MHz + 20MHz QPSK Low Ch RB100-0 + RB100-0

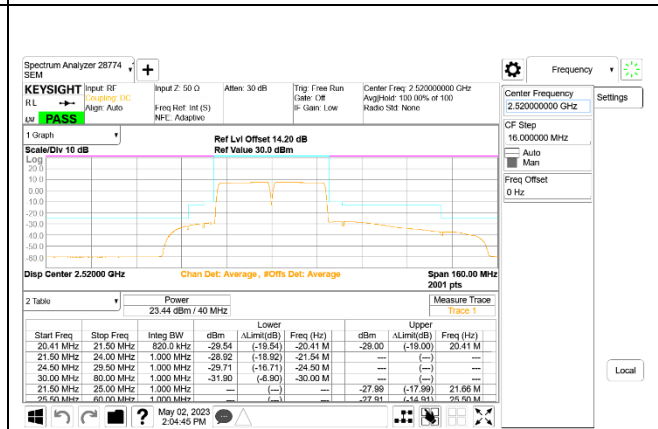

LTE B7 20MHz + 20MHz 16QAM Low Ch RB100-0 + RB100-0

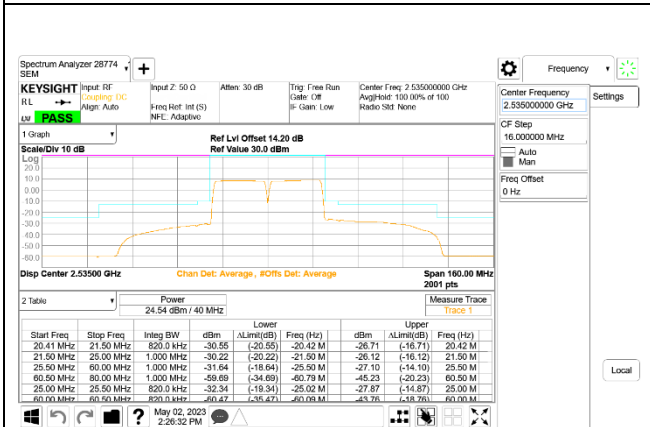

LTE B7 20MHz + 20MHz QPSK Mid Ch RB100-0 + RB100-0

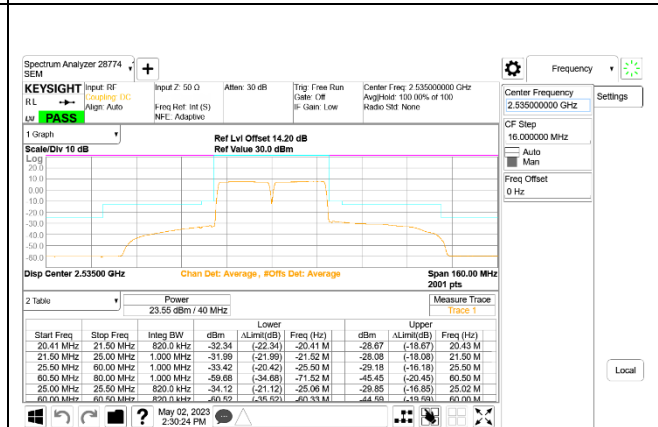

LTE B7 20MHz + 20MHz 16QAM Mid Ch RB100-0 + RB100-0

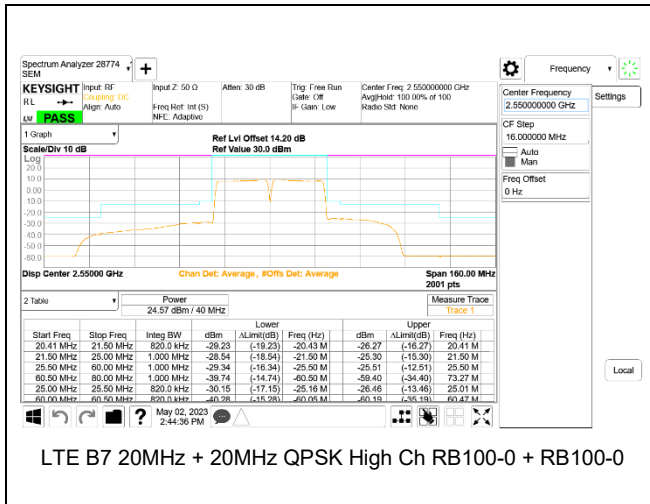

LTE B7 20MHz + 20MHz QPSK High Ch RB100-0 + RB100-0

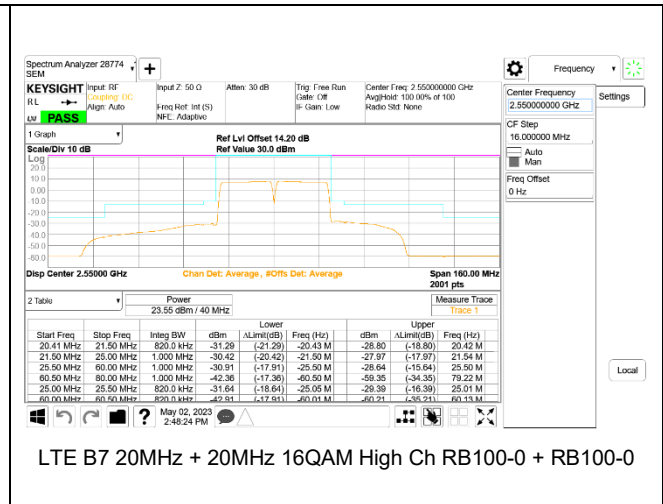

LTE B7 20MHz + 20MHz 16QAM High Ch RB100-0 + RB100-0

### 9.2.3 LTE BAND 41 EMISSION MASK

#### LIMITS

FCC: §27.53(m)(4) For mobile digital stations, the attenuation factor shall be not less than 40 + 10 log (P) dB on all frequencies between the channel edge and 5 megahertz from the channel edge, 43 + 10 log (P) dB on all frequencies between 5 megahertz and X megahertz from the channel edge, and 55 + 10 log (P) dB on all frequencies more than X megahertz from the channel edge, where X is the greater of 6 megahertz or the actual emission bandwidth as defined in paragraph (m)(6) of this section. In addition, the attenuation factor shall not be less that 43 + 10 log (P) dB on all frequencies between 2490.5 MHz and 2496 MHz and 55 + 10 log (P) dB at or below 2490.5 MHz. Mobile Satellite Service licensees operating on frequencies below 2495 MHz may also submit a documented interference complaint against BRS licensees operating on channel BRS Channel 1 on the same terms and conditions as adjacent channel BRS or EBS licensees.

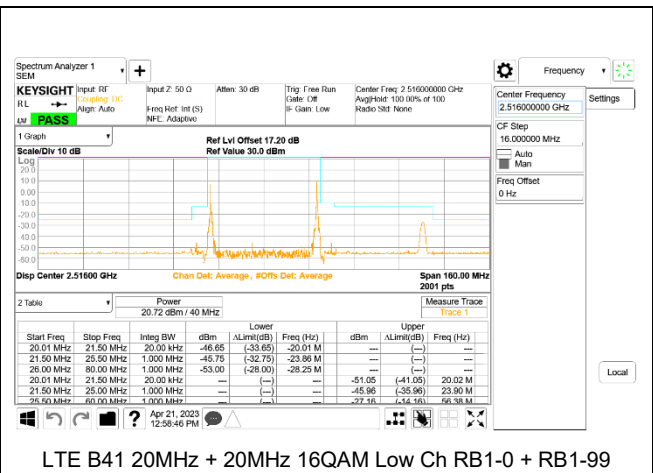
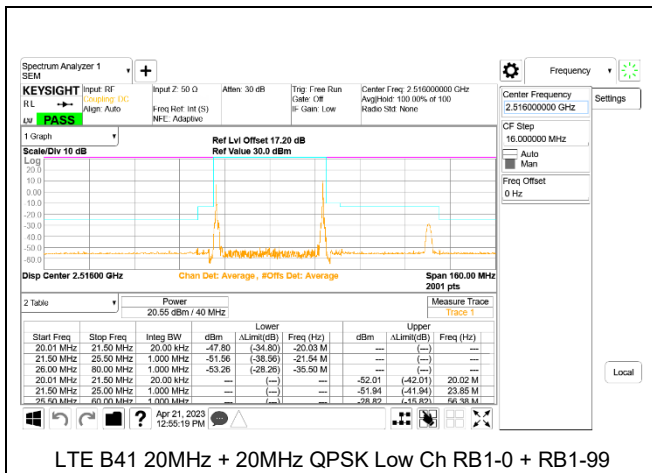

LTE B41 20MHz + 20MHz QPSK Low Ch RB1-0 + RB1-99

LTE B41 20MHz + 20MHz 16QAM Low Ch RB1-0 + RB1-99

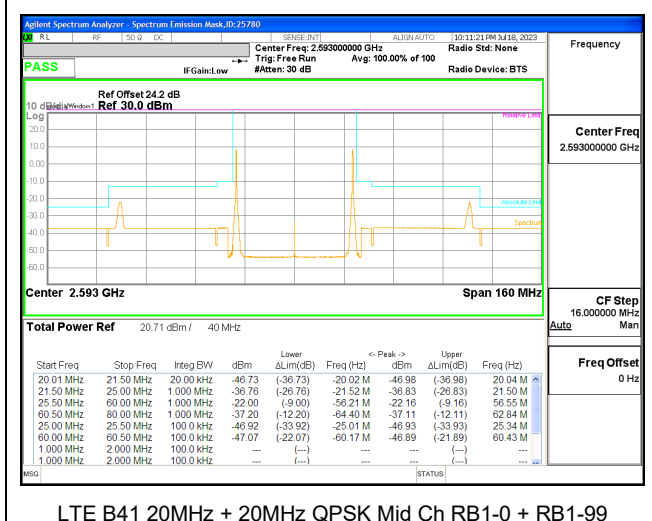

LTE B41 20MHz + 20MHz QPSK Mid Ch RB1-0 + RB1-99

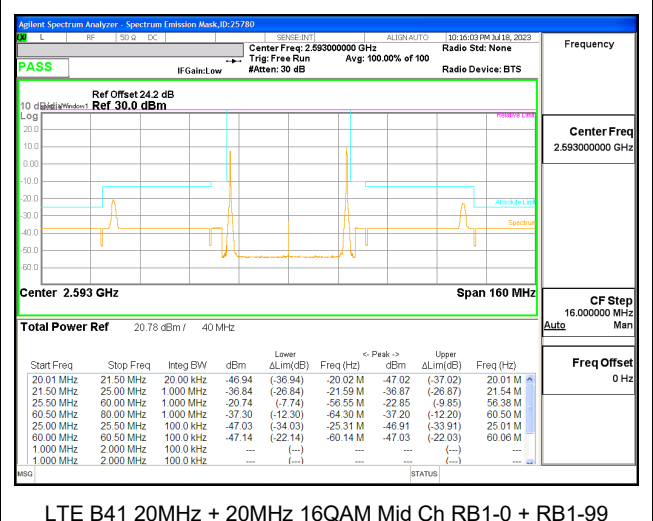

LTE B41 20MHz + 20MHz 16QAM Mid Ch RB1-0 + RB1-99



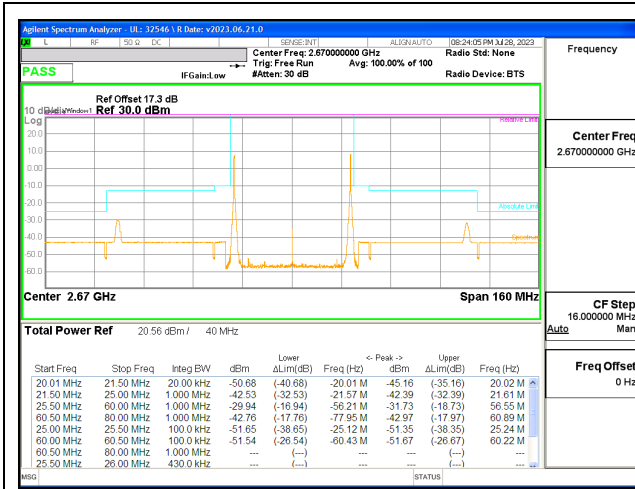

LTE B41 20MHz + 20MHz QPSK High Ch RB1-0 + RB1-99

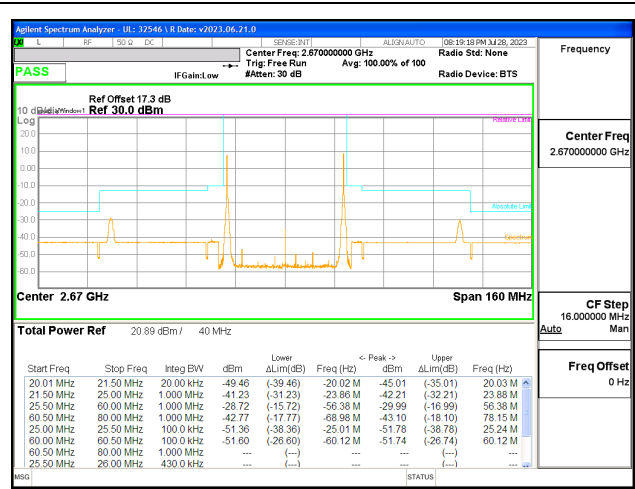

LTE B41 20MHz + 20MHz 16QAM High Ch RB1-0 + RB1-99

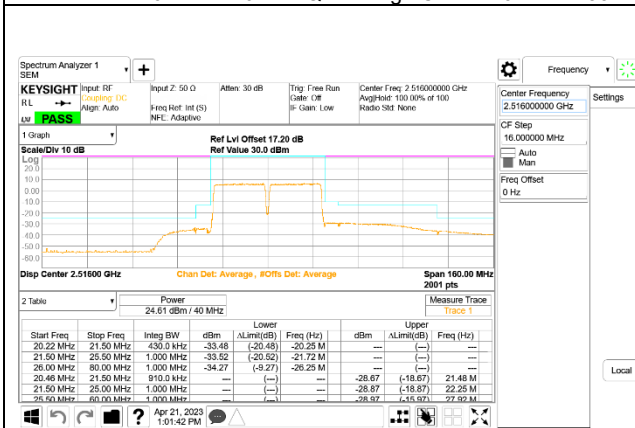

LTE B41 20MHz + 20MHz QPSK Low Ch RB100-0 + RB100-0

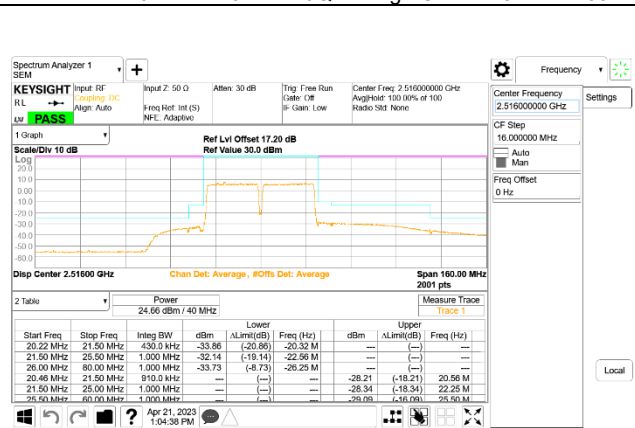

LTE B41 20MHz + 20MHz 16QAM Low Ch RB100-0 + RB100-0

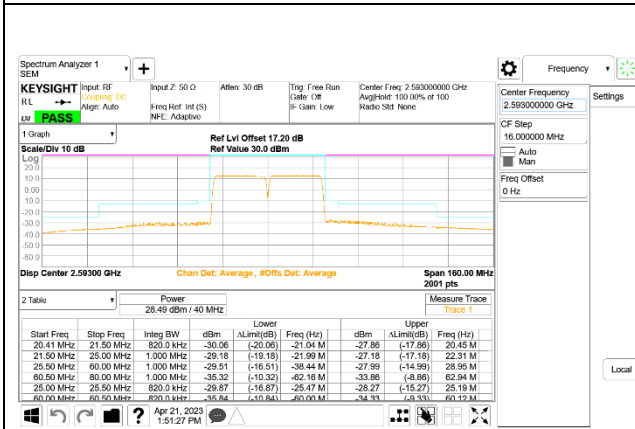

LTE B41 20MHz + 20MHz QPSK Mid Ch RB100-0 + RB100-0

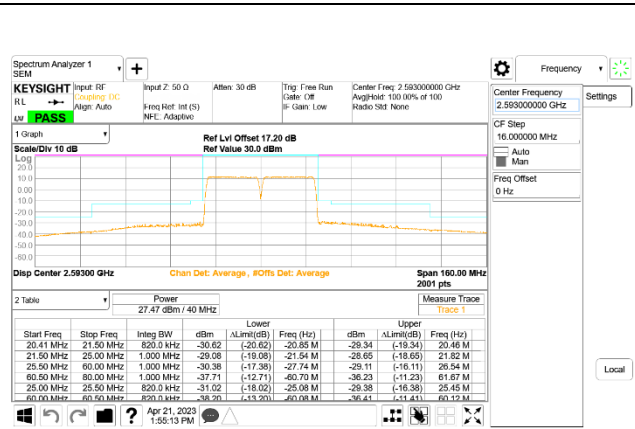

LTE B41 20MHz + 20MHz 16QAM Mid Ch RB100-0 + RB100-0

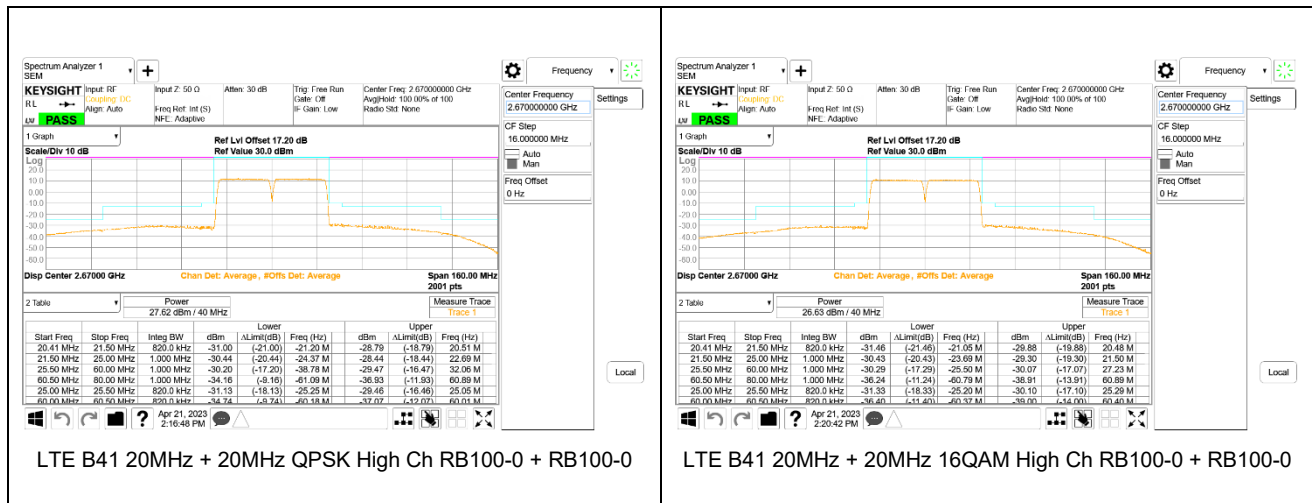

## 9.2.4 LTE BAND 48 EMISSION MASK AND ADJACENT CHANNEL POWER

### LIMITS

FCC: §96.41

(e) 3.5 GHz Emissions and Interference Limits—

(1) General protection levels

(ii) Except as otherwise specified in paragraph (e)(2) of this section, for channel and frequency assignments made by a CBSD to End User Devices, the conducted power of any End User Device emission outside the fundamental emission (whether in or outside of the authorized band) shall not exceed  $-13$  dBm/MHz within 0 to B megahertz (where B is the bandwidth in megahertz of the assigned channel or multiple contiguous channels of the End User Device) above the upper CBSD-assigned channel edge and within 0 to B megahertz below the lower CBSD-assigned channel edge. At all frequencies greater than B megahertz above the upper CBSD assigned channel edge and less than B megahertz below the lower CBSD-assigned channel edge, the conducted power of any End User Device emission shall not exceed  $-25$  dBm/MHz. Notwithstanding the emission limits in this paragraph, the Adjacent Channel Leakage Ratio for End User Devices shall be at least 30 dB.

(2) Additional protection levels. Notwithstanding paragraph (e)(1) of this section, for CBSDs and End User Devices, the conducted power of emissions below 3540 MHz or above 3710 MHz shall not exceed  $-25$  dBm/MHz, and the conducted power of emissions below 3530 MHz or above 3720 MHz shall not exceed  $-40$  dBm/MHz.  
licensees.

**LTE BAND 48 EMISSION MASK**

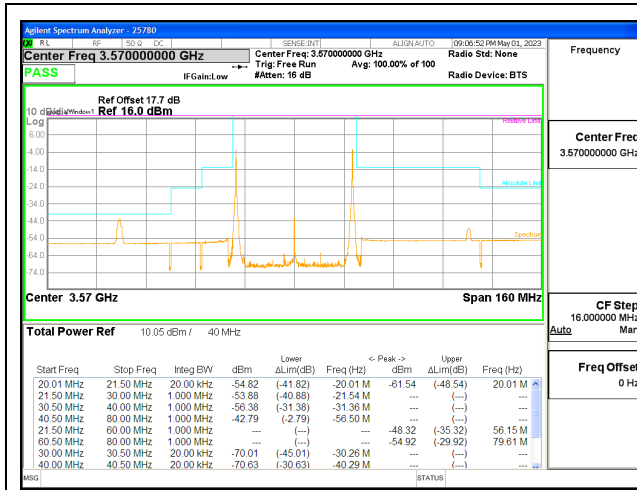

LTE B48 20MHz + 20MHz QPSK Low Ch RB1-0 + RB1-99

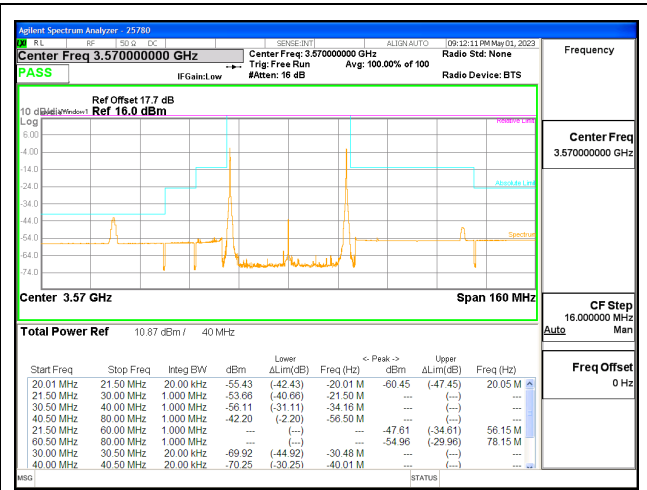

LTE B48 20MHz + 20MHz 16QAM Low Ch RB1-0 + RB1-99

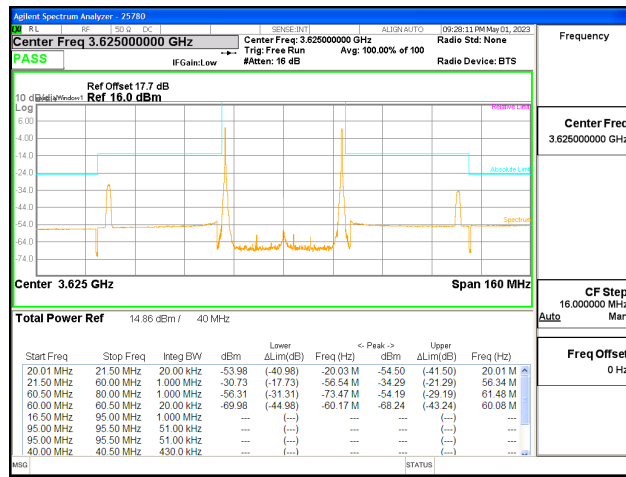

LTE B48 20MHz + 20MHz QPSK Mid Ch RB1-0 + RB1-99

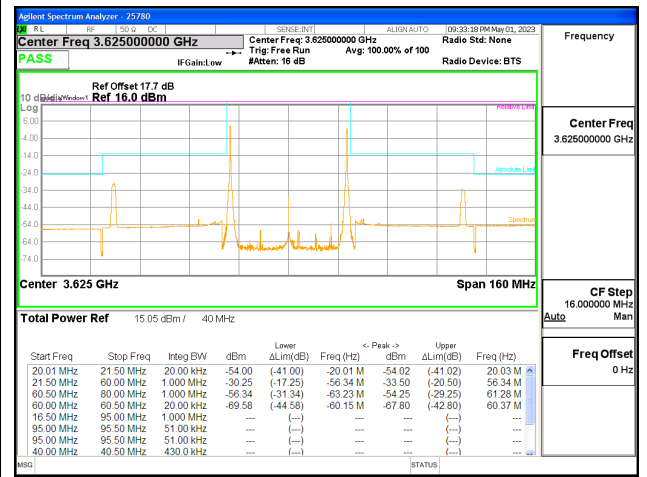

LTE B48 20MHz + 20MHz 16QAM Mid Ch RB1-0 + RB1-99

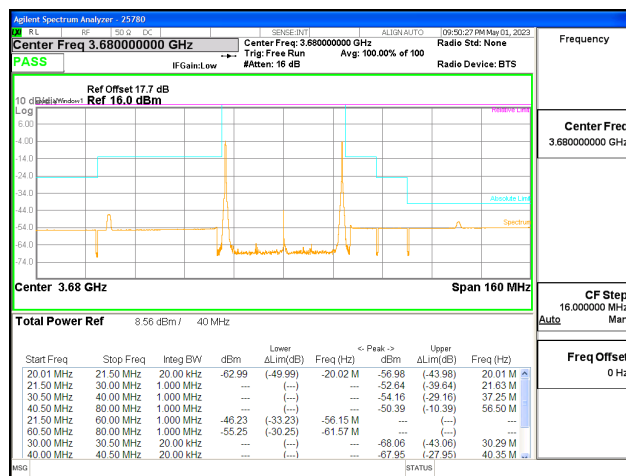

LTE B48 20MHz + 20MHz QPSK High Ch RB1-0 + RB1-99

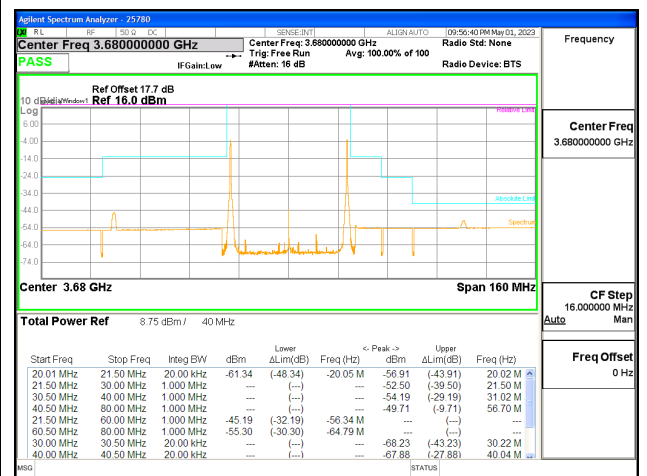

LTE B48 20MHz + 20MHz 16QAM High Ch RB1-0 + RB1-99

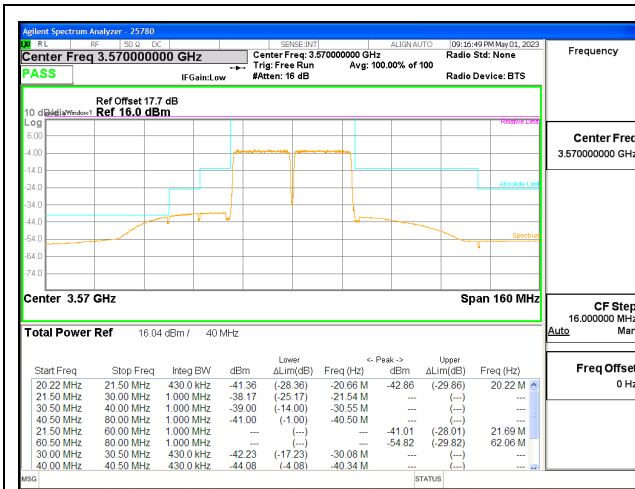

LTE B48 20MHz + 20MHz QPSK Low Ch RB100-0 + RB100-0

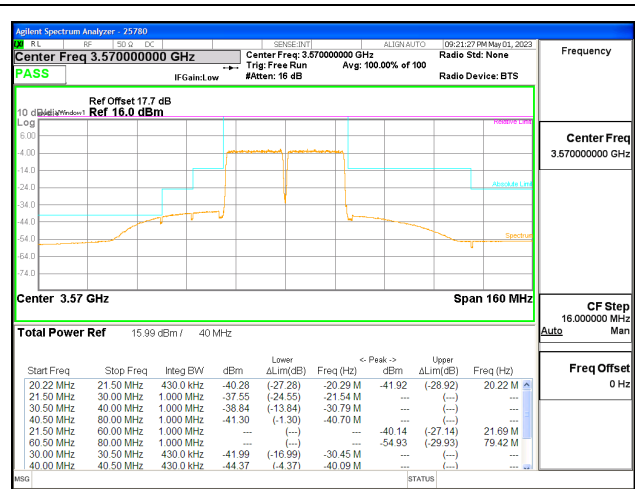

LTE B48 20MHz + 20MHz 16QAM Low Ch RB100-0 + RB100-0

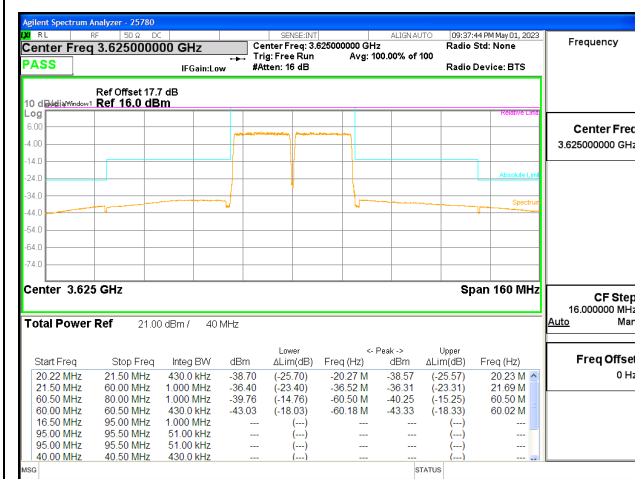

LTE B48 20MHz + 20MHz QPSK Mid Ch RB100-0 + RB100-0

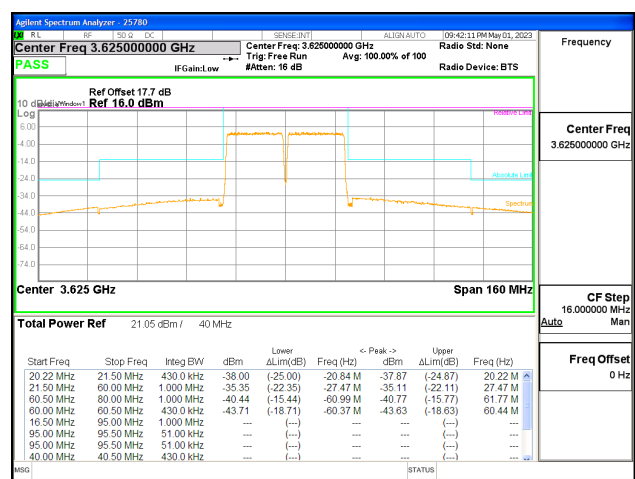

LTE B48 20MHz + 20MHz 16QAM Mid Ch RB100-0 + RB100-0

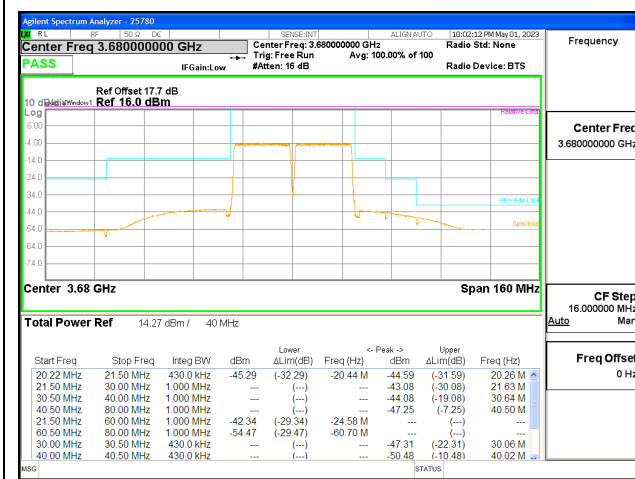

LTE B48 20MHz + 20MHz QPSK High Ch RB100-0 + RB100-0

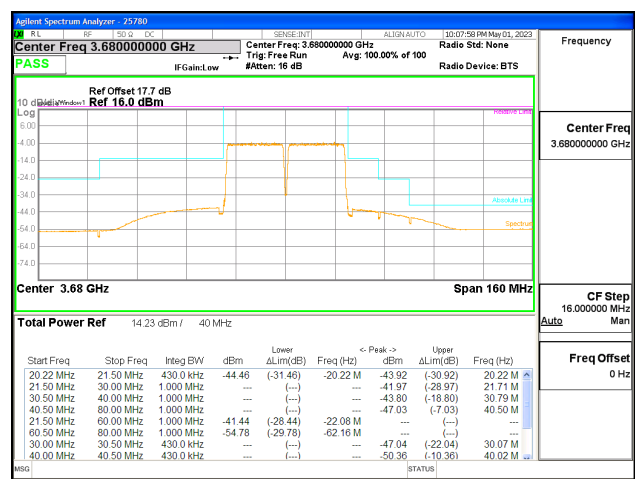

LTE B48 20MHz + 20MHz 16QAM High Ch RB100-0 + RB100-0

**LTE BAND 48 ADJACENT CHANNEL POWER**



LTE B48 20MHz + 20MHz QPSK Low Ch RB1-0 + RB1-99

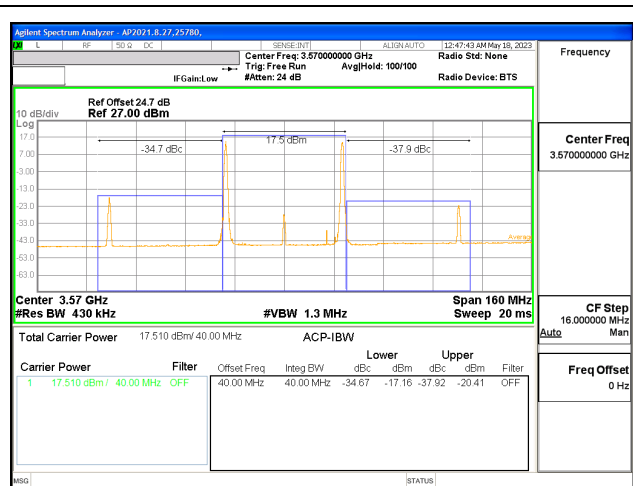

LTE B48 20MHz + 20MHz 16QAM Low Ch RB1-0 + RB1-99

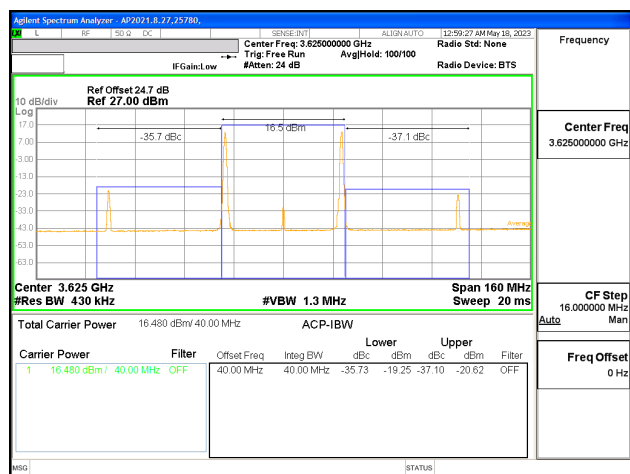

LTE B48 20MHz + 20MHz QPSK Mid Ch RB1-0 + RB1-99

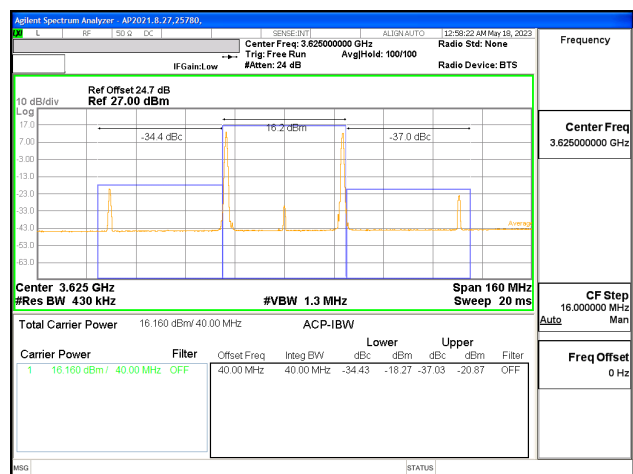

LTE B48 20MHz + 20MHz 16QAM Mid Ch RB1-0 + RB1-99

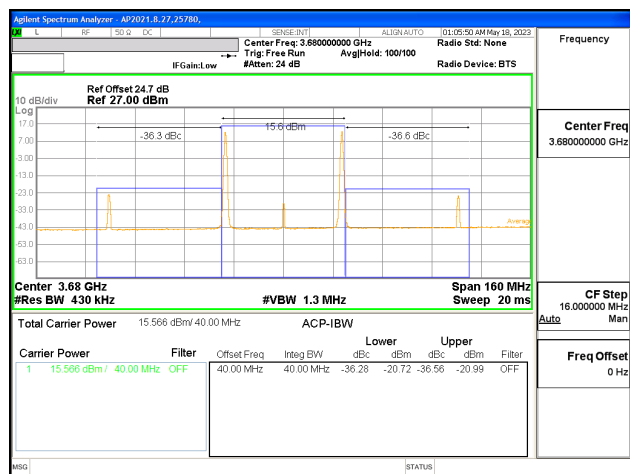

LTE B48 20MHz + 20MHz QPSK High Ch RB1-0 + RB1-99



LTE B48 20MHz + 20MHz 16QAM High Ch RB1-0 + RB1-99

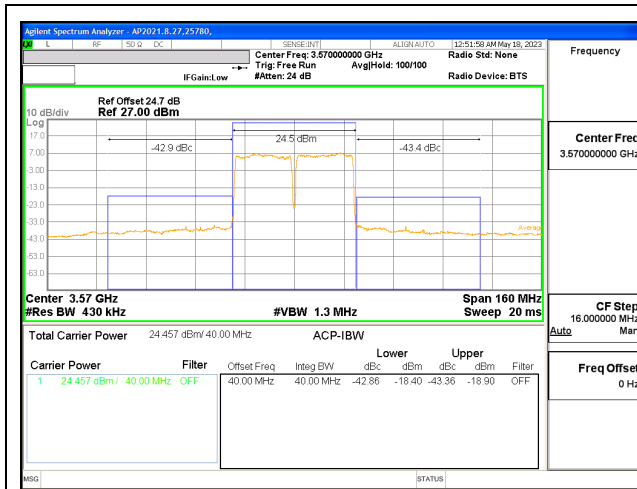

LTE B48 20MHz + 20MHz QPSK Low Ch RB100-0 + RB100-0

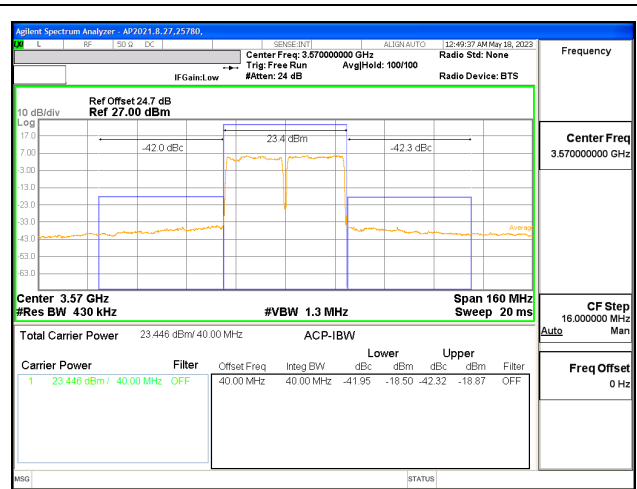

LTE B48 20MHz + 20MHz 16QAM Low Ch RB100-0 + RB100-0

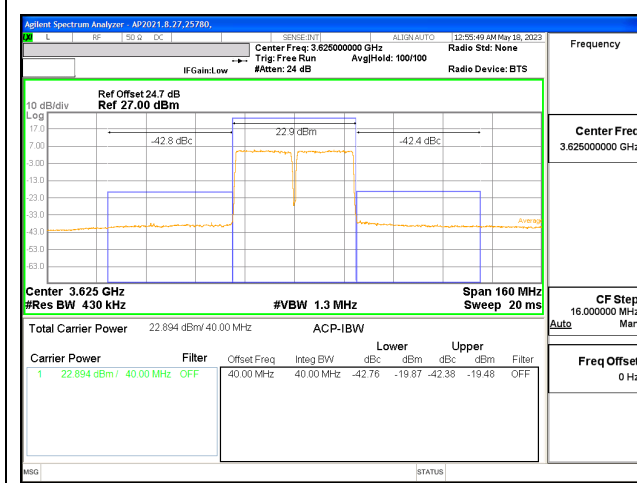

LTE B48 20MHz + 20MHz QPSK Mid Ch RB100-0 + RB100-0



LTE B48 20MHz + 20MHz 16QAM Mid Ch RB100-0 + RB100-0



LTE B48 20MHz + 20MHz QPSK High Ch RB100-0 + RB100-0



LTE B48 20MHz + 20MHz 16QAM High Ch RB100-0 + RB100-0

### **9.3. OUT OF BAND EMISSIONS**

#### **TEST PROCEDURE**

The RF output of the transmitter was connected to a spectrum analyzer through a calibrated coaxial cable. Sufficient scans were taken to show the out-of-band Emissions, if any, up to 10th harmonic. Multiple sweeps were recorded in maximum hold mode using a peak detector to ensure that the worst-case emissions were caught.

For each out of band emissions measurement:

- Set display line at -13 dBm to band 5 and -25 dBm to band 7 and 41
- Set RBW & VBW to 100 kHz for the measurement below 1 GHz, and 1 MHz for the measurement above 1 GHz.  
(NOTE: Worst case set RBW/VBW to 1MHz/3MHz)

#### **RESULTS**



### 9.3.1 LTE BAND 5

#### LIMITS

FCC: §22.917

The minimum permissible attenuation level of any spurious emissions is  $43 + 10 \log (P)$  dB where transmitting power (P) in Watts.

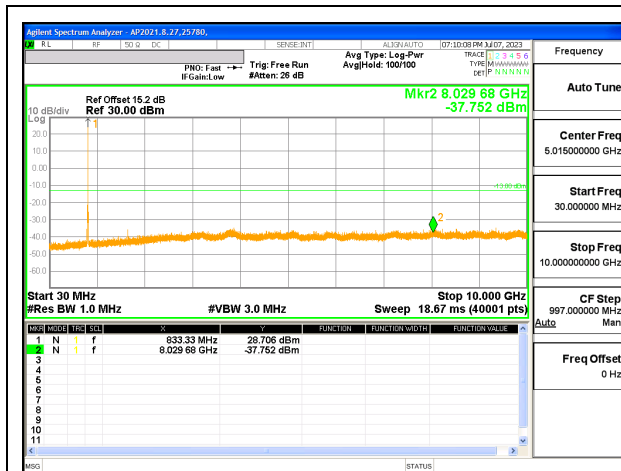

LTE B5 10MHz + 10MHz QPSK Low Ch RB1-49 + RB1-0

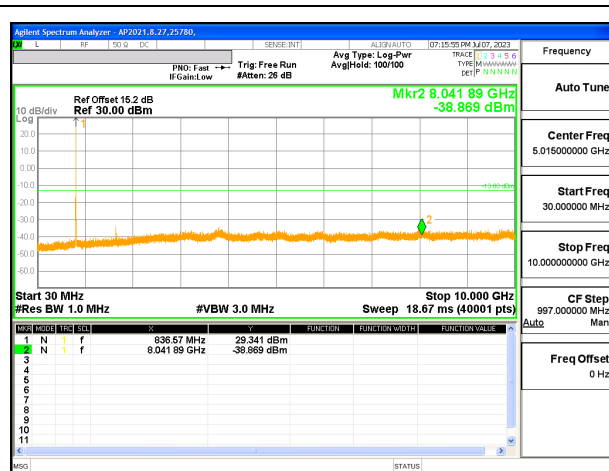

LTE B5 10MHz + 10MHz QPSK Middle Ch RB1-49 + RB1-0

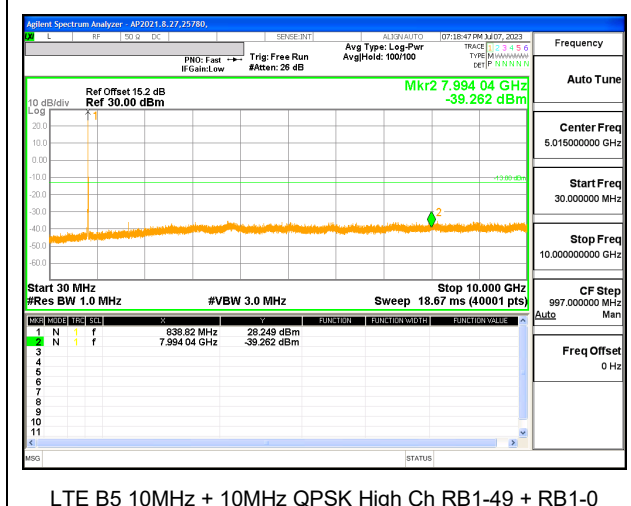

LTE B5 10MHz + 10MHz QPSK High Ch RB1-49 + RB1-0

### 9.3.2 LTE BAND 7

#### LIMITS

FCC: §27.53 (m)

The minimum permissible attenuation level of any spurious emissions is  $55 + 10 \log (P)$  dB where transmitting power (P) in Watts.

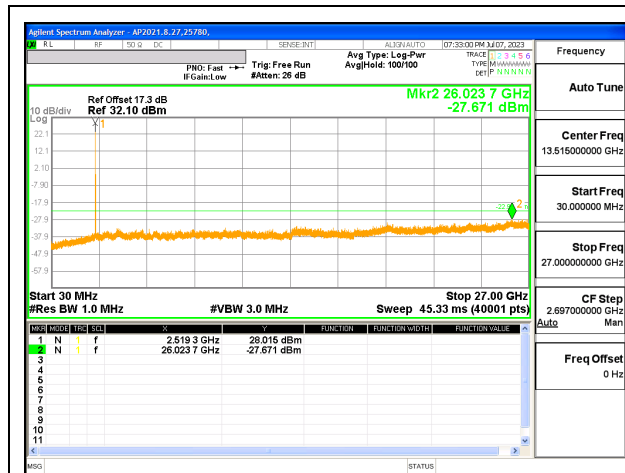

LTE B7 20MHz + 20MHz QPSK Low Ch RB1-99 + RB1-0

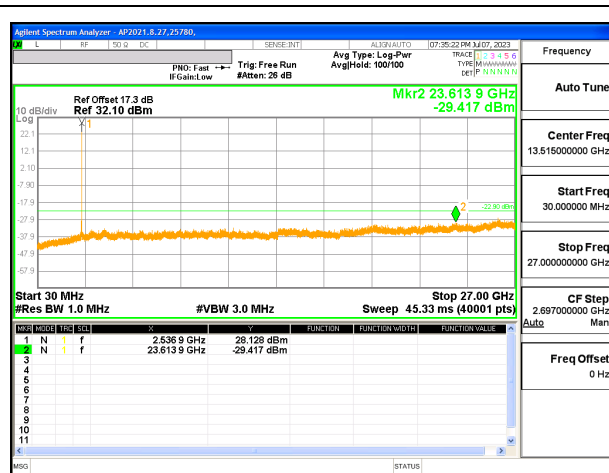

LTE B7 20MHz + 20MHz QPSK Middle Ch RB1-99 + RB1-0

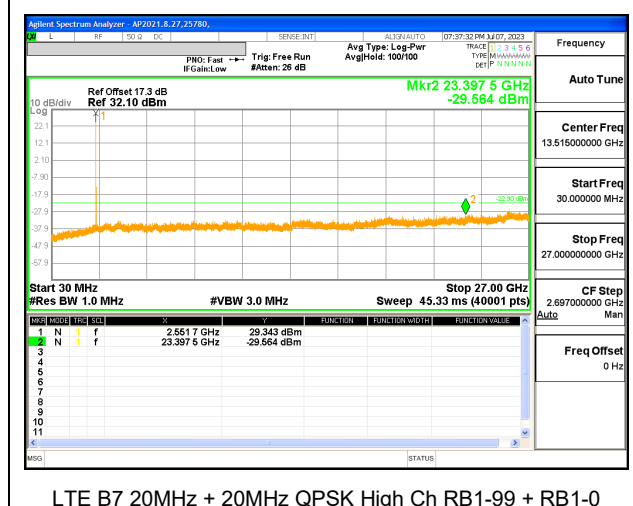

LTE B7 20MHz + 20MHz QPSK High Ch RB1-99 + RB1-0

### 9.3.3 LTE BAND 41

#### LIMITS

FCC: §27.53 (m)

The minimum permissible attenuation level of any spurious emissions is  $55 + 10 \log (P)$  dB where transmitting power (P) in Watts.

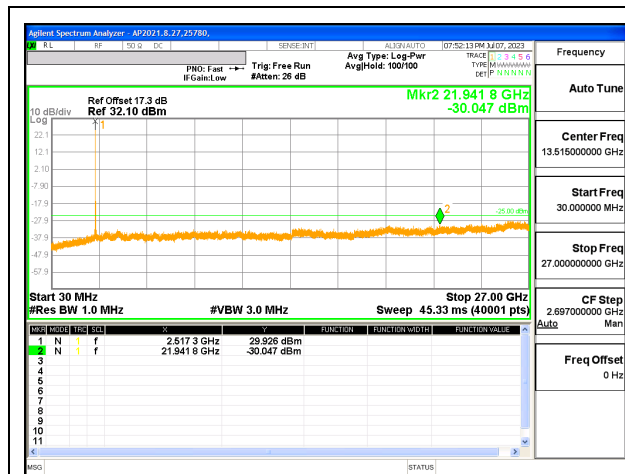

LTE B41 20MHz + 20MHz QPSK Low Ch RB1-99 + RB1-0

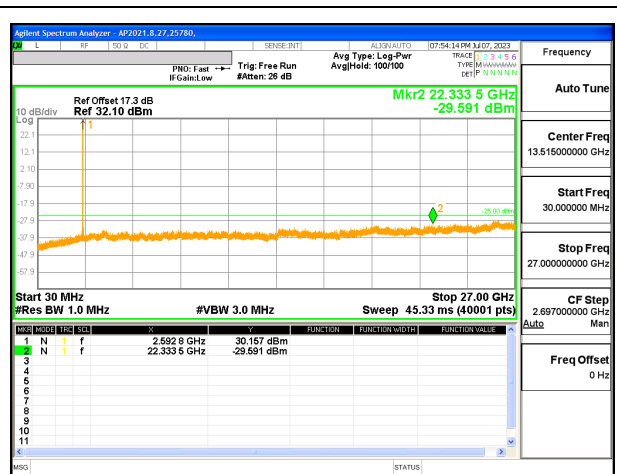

LTE B41 20MHz + 20MHz QPSK Middle Ch RB1-99 + RB1-0

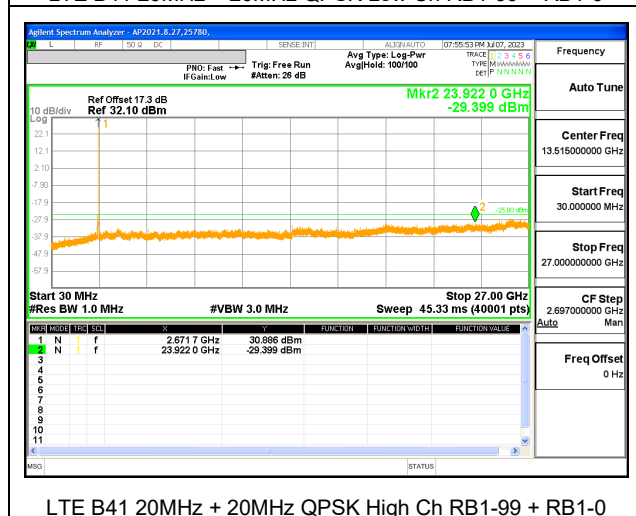

LTE B41 20MHz + 20MHz QPSK High Ch RB1-99 + RB1-0