

LTE B17 5MHz QPSK Low Channel RB1-0

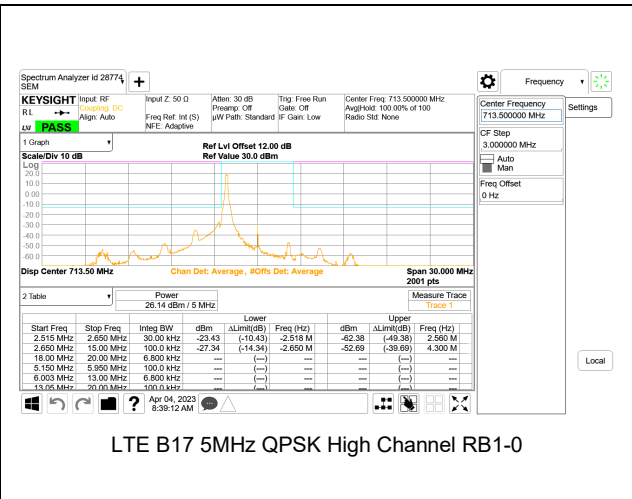

LTE B17 5MHz QPSK High Channel RB1-0

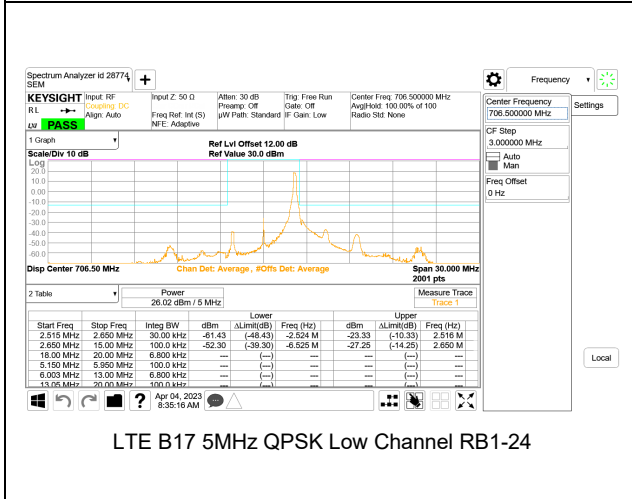

LTE B17 5MHz QPSK Low Channel RB1-24

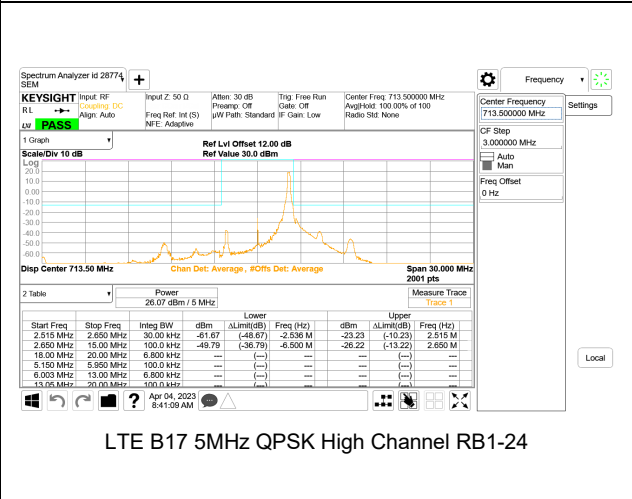

LTE B17 5MHz QPSK High Channel RB1-24

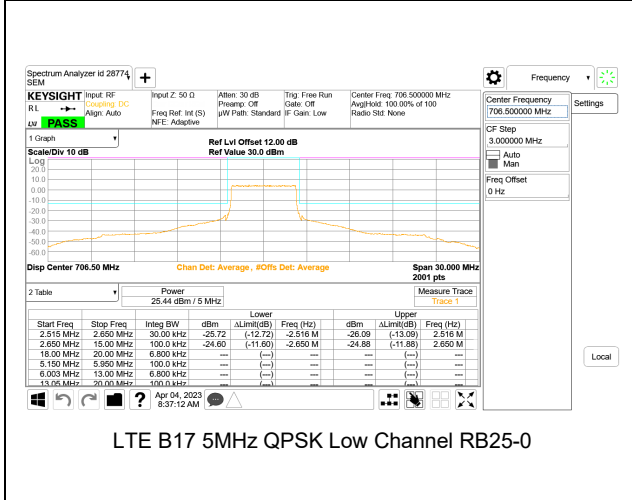

LTE B17 5MHz QPSK Low Channel RB25-0

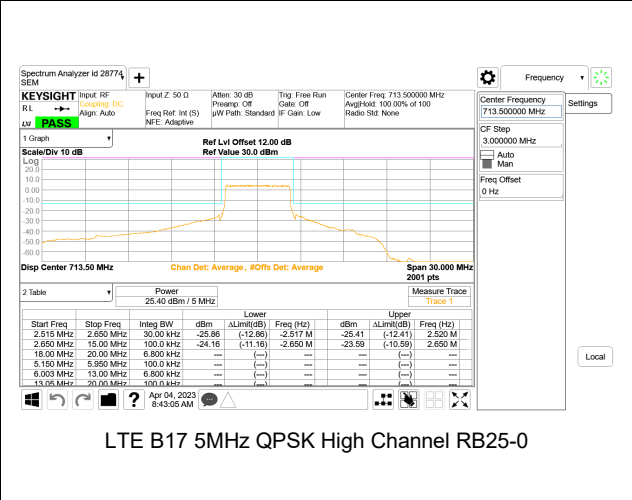

LTE B17 5MHz QPSK High Channel RB25-0

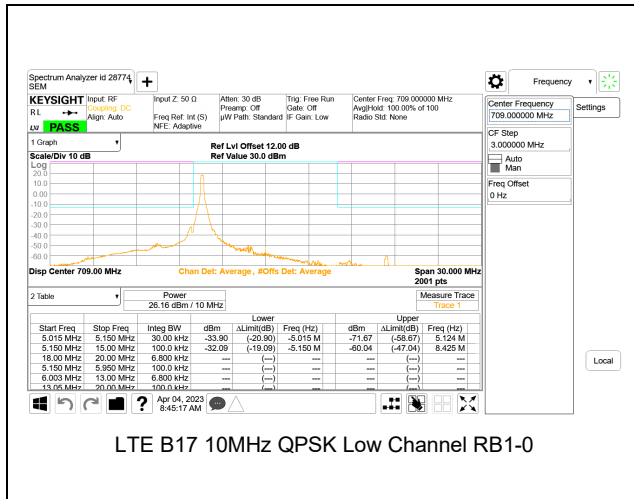

LTE B17 10MHz QPSK Low Channel RB1-0

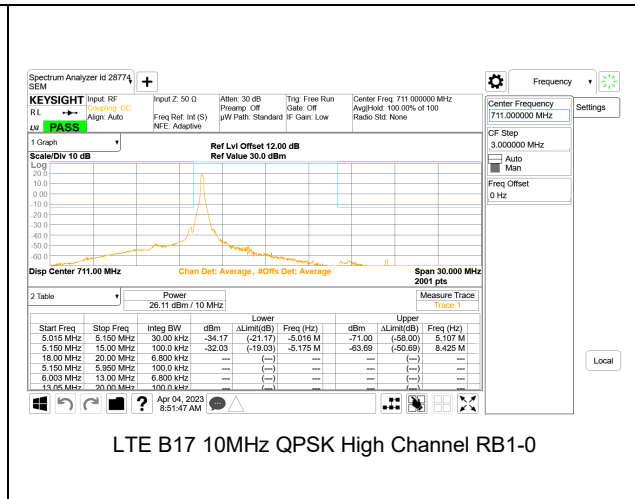

LTE B17 10MHz QPSK High Channel RB1-0

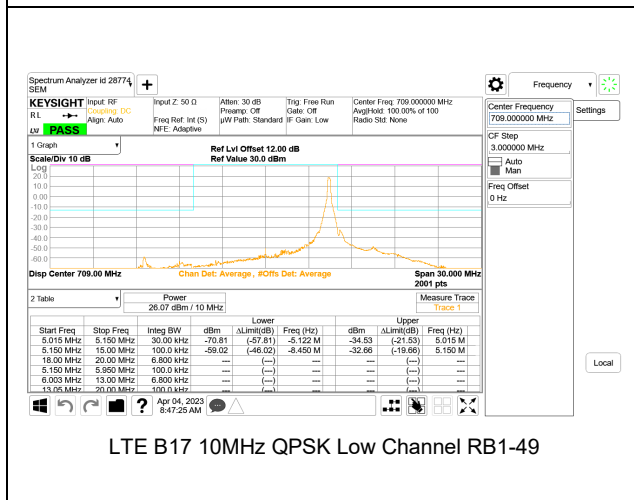

LTE B17 10MHz QPSK Low Channel RB1-49

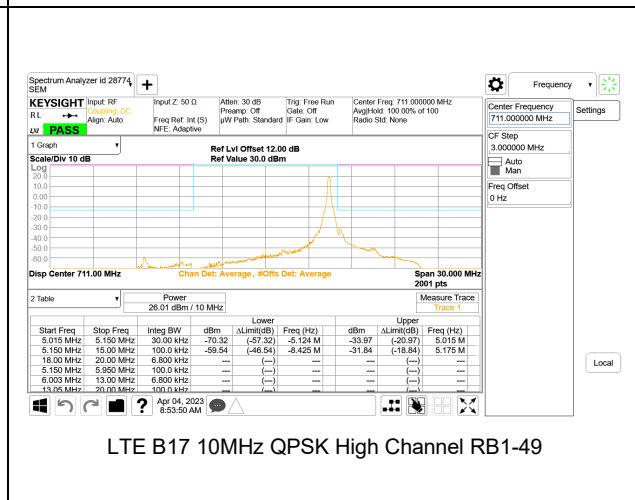

LTE B17 10MHz QPSK High Channel RB1-49

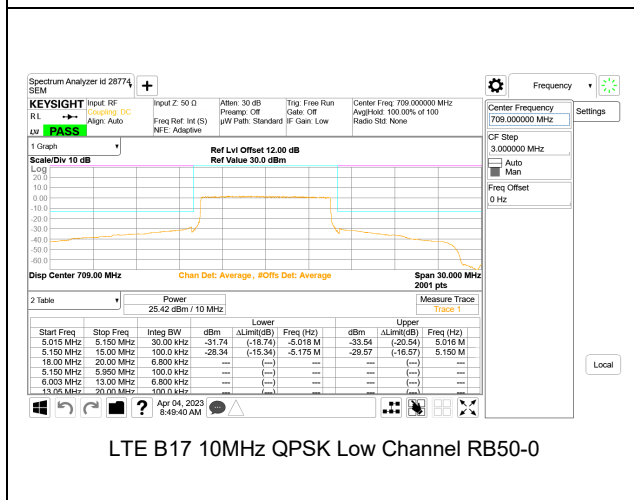

LTE B17 10MHz QPSK Low Channel RB50-0

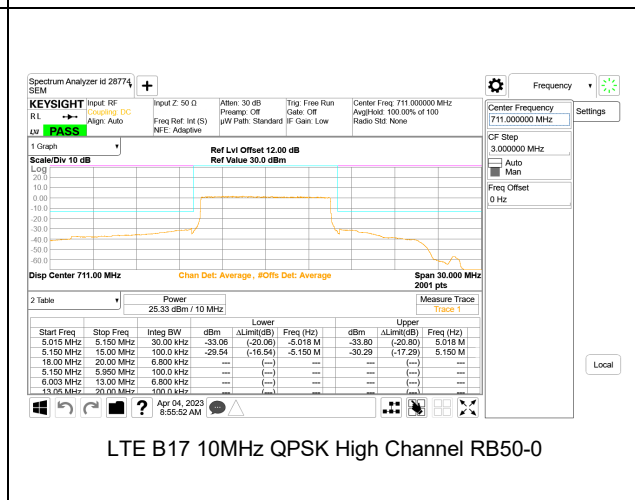

LTE B17 10MHz QPSK High Channel RB50-0

## 9.2.6. LTE BAND 25 AND 5G NR n25

### LIMITS

FCC: §24.238 (a)

The power of any emission outside of the authorized operating frequency ranges must be attenuated below the transmitting power (P) by a factor of at least  $43 + 10 \log (P)$  dB.

**LTE BAND 25 BANDEDGE**

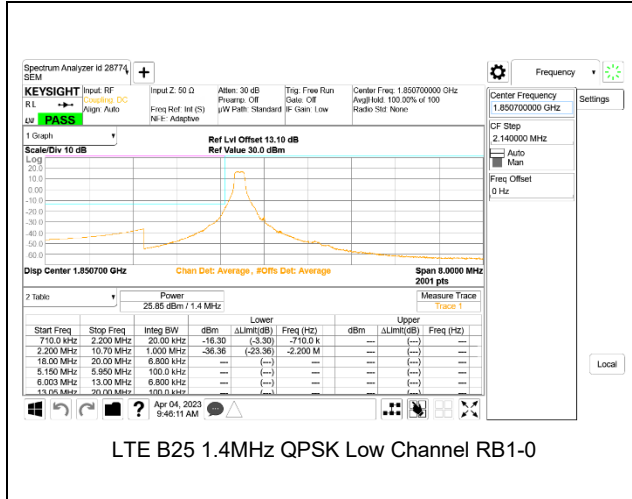

LTE B25 1.4MHz QPSK Low Channel RB1-0

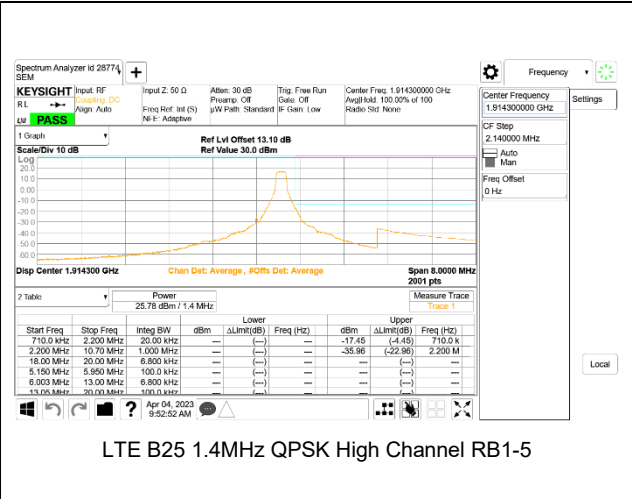

LTE B25 1.4MHz QPSK High Channel RB1-5

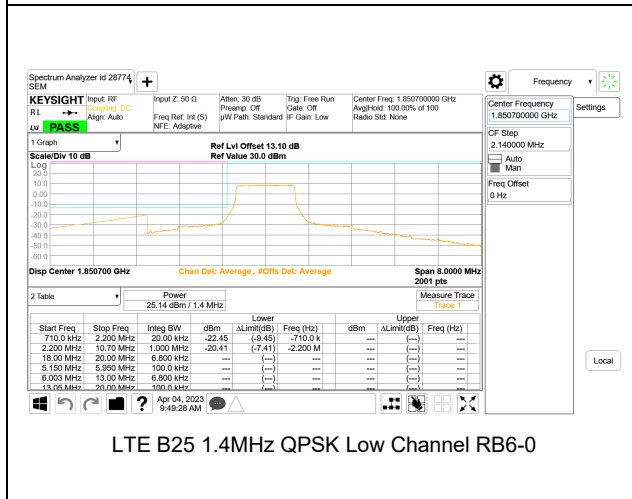

LTE B25 1.4MHz QPSK Low Channel RB6-0

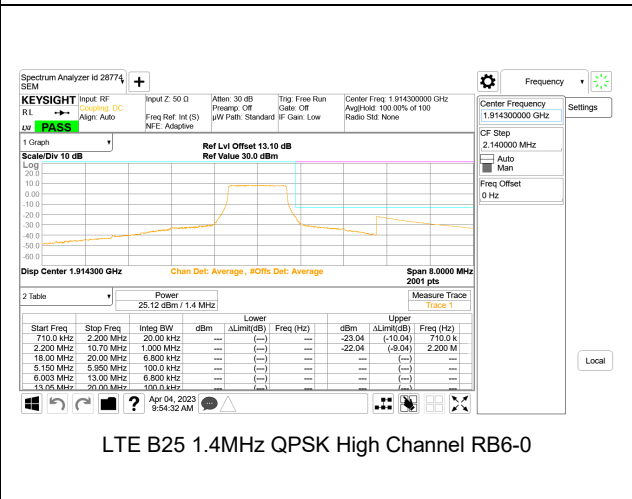

LTE B25 1.4MHz QPSK High Channel RB6-0

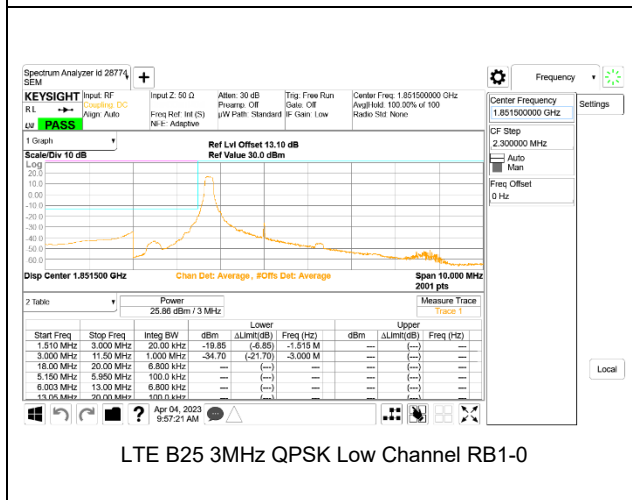

LTE B25 3MHz QPSK Low Channel RB1-0

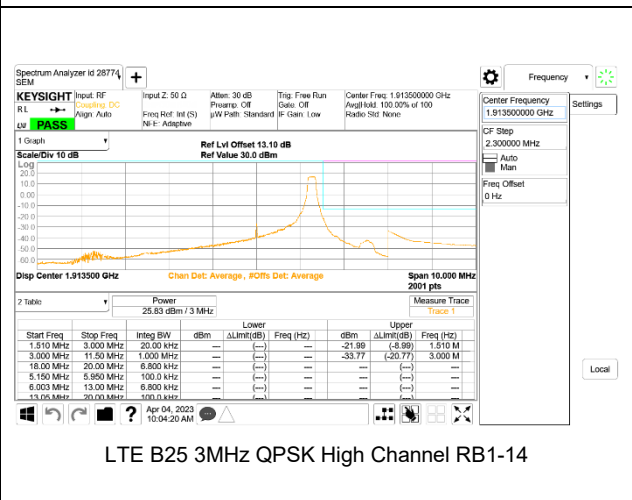

LTE B25 3MHz QPSK High Channel RB1-14

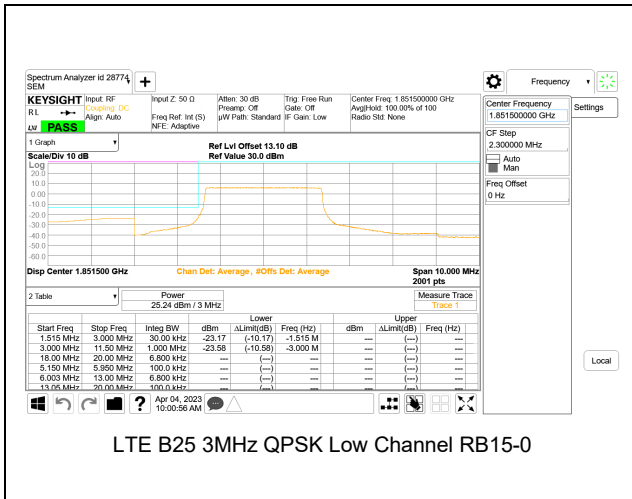

LTE B25 3MHz QPSK Low Channel RB15-0

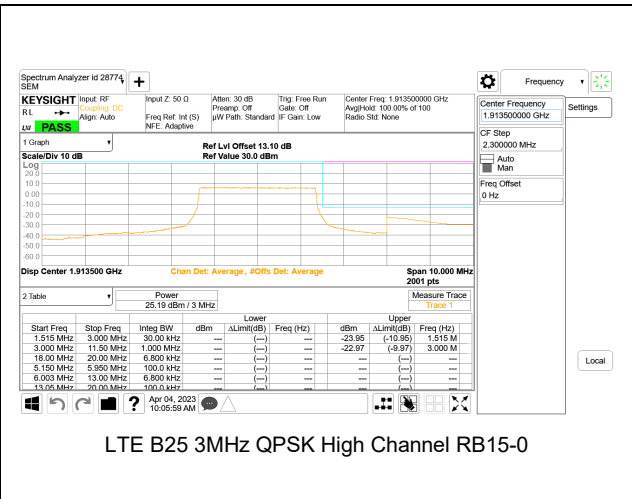

LTE B25 3MHz QPSK High Channel RB15-0

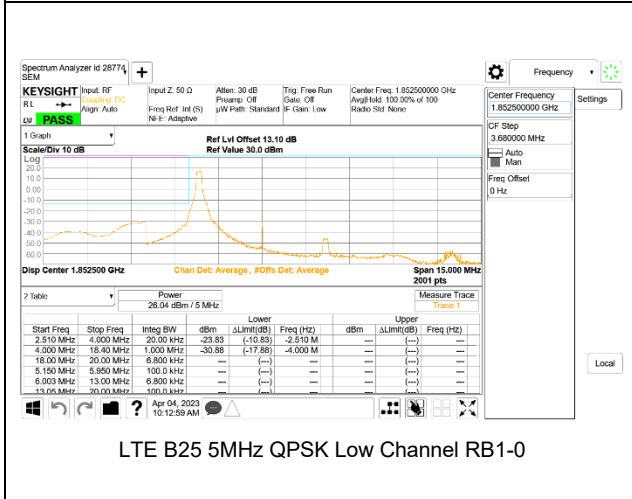

LTE B25 5MHz QPSK Low Channel RB1-0

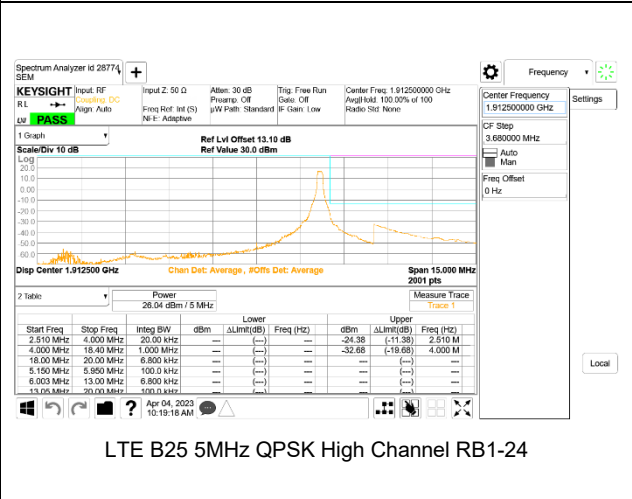

LTE B25 5MHz QPSK High Channel RB1-24

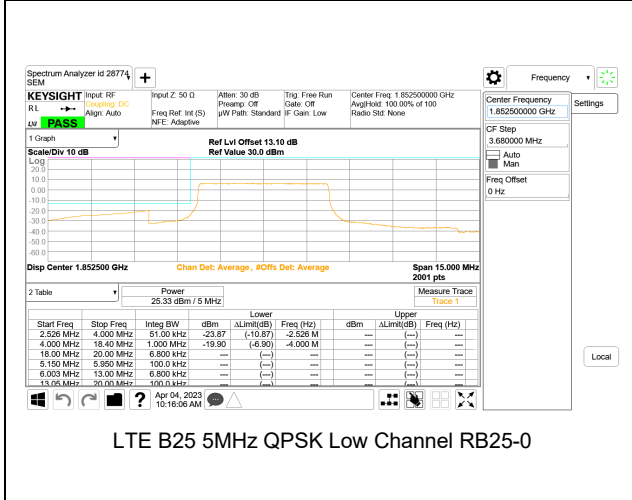

LTE B25 5MHz QPSK Low Channel RB25-0

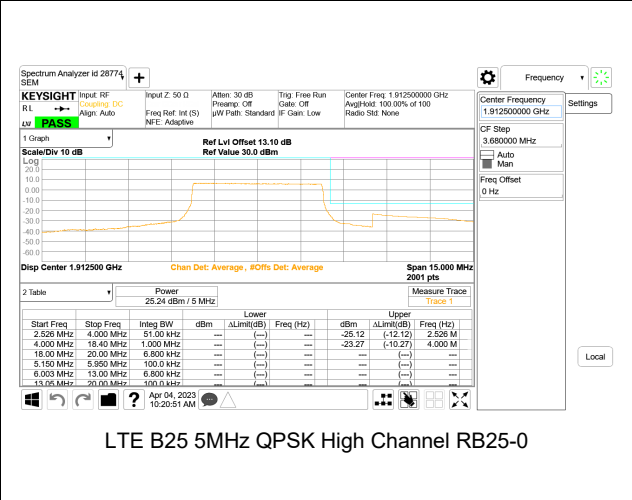

LTE B25 5MHz QPSK High Channel RB25-0

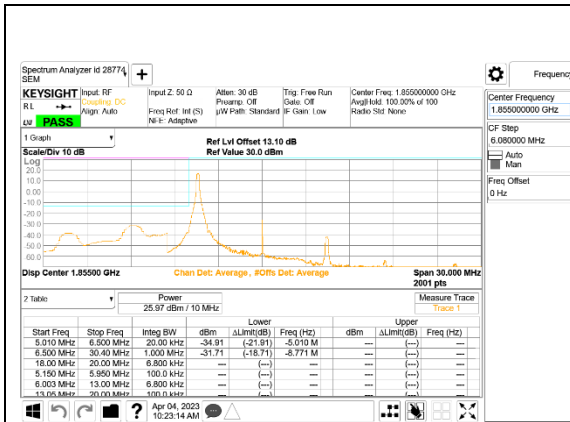

LTE B25 10MHz QPSK Low Channel RB1-0

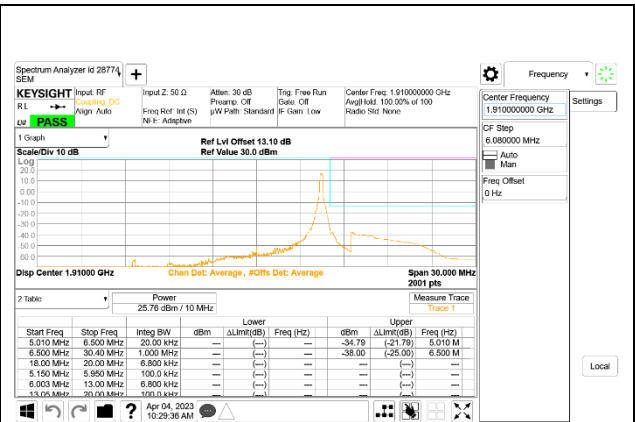

LTE B25 10MHz QPSK High Channel RB1-49

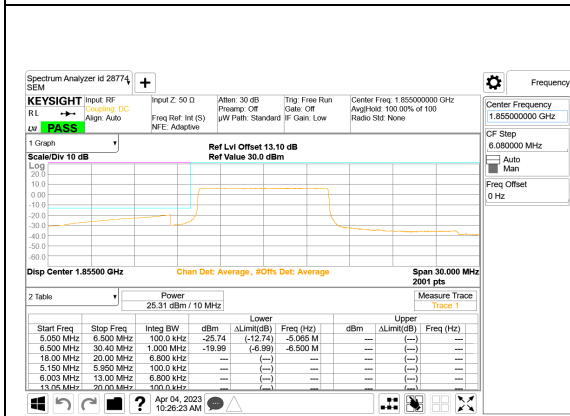

LTE B25 10MHz QPSK Low Channel RB50-0

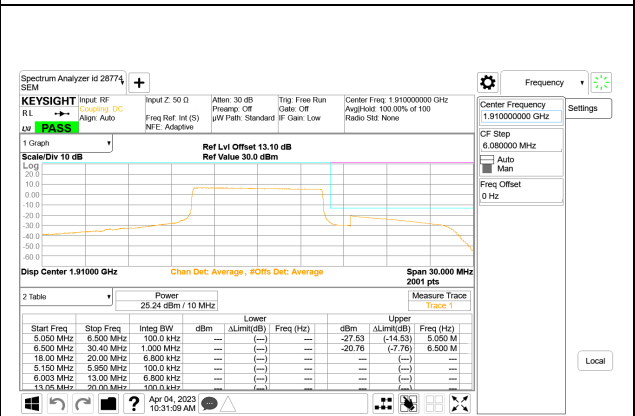

LTE B25 10MHz QPSK High Channel RB50-0

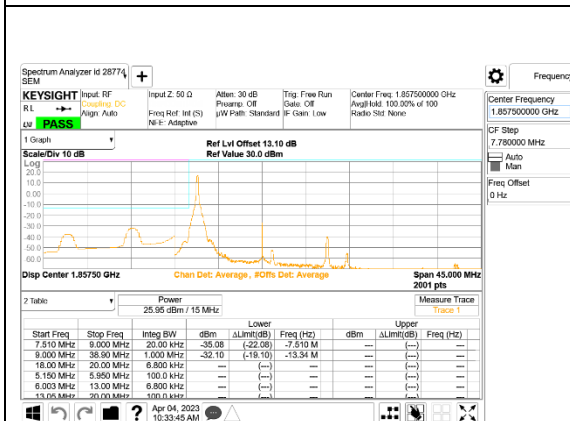

LTE B25 15MHz QPSK Low Channel RB1-0

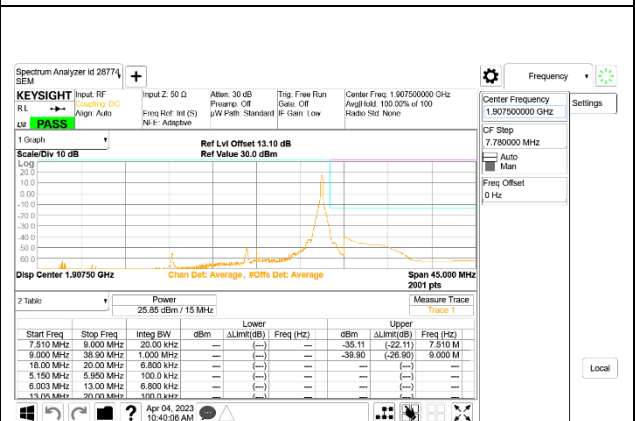

LTE B25 15MHz QPSK High Channel RB1-74

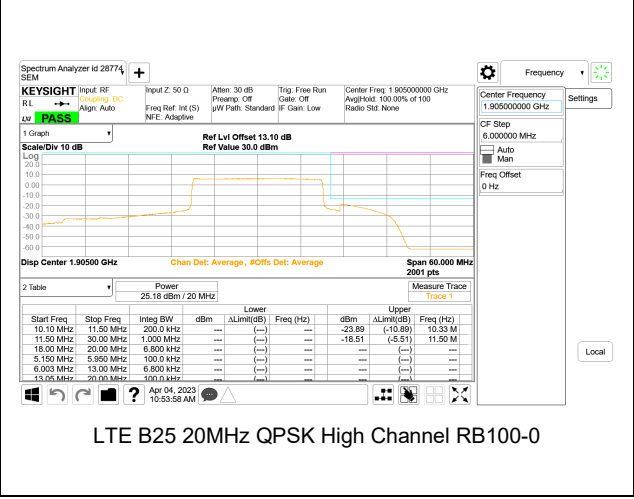
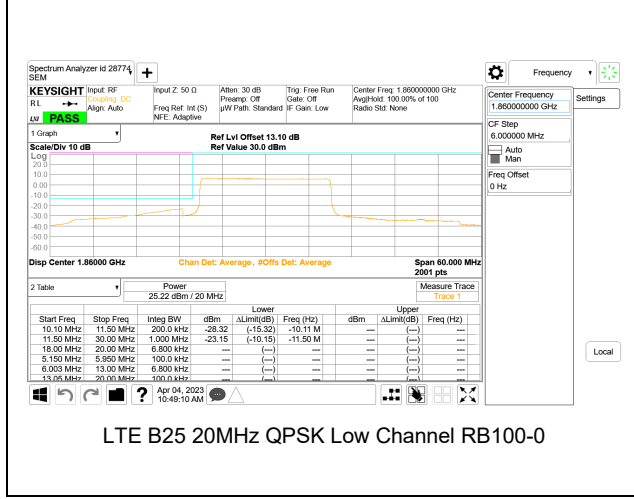
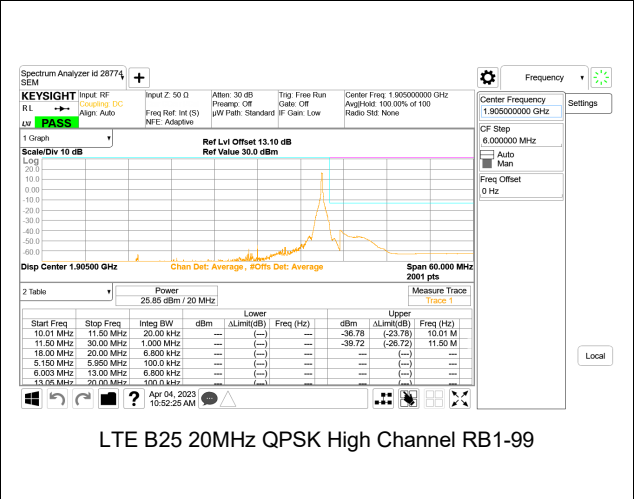
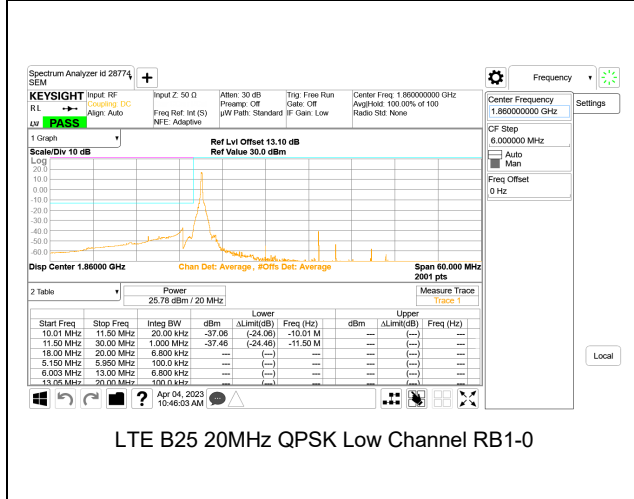
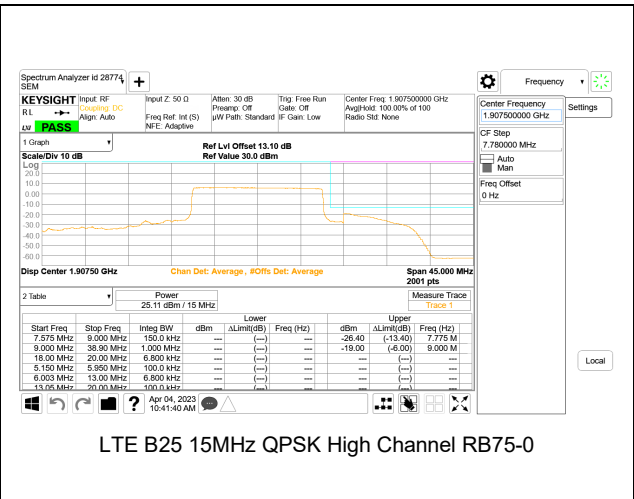
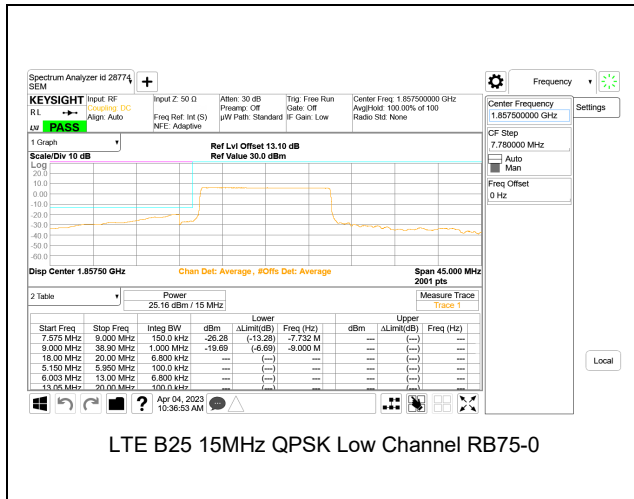

**5G NR n25 BANDEDGE**

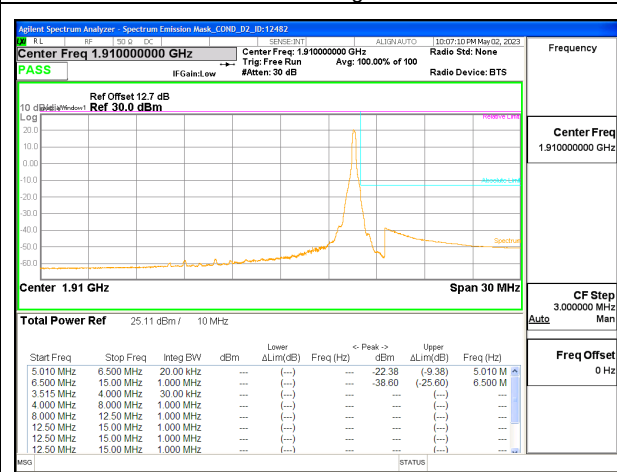
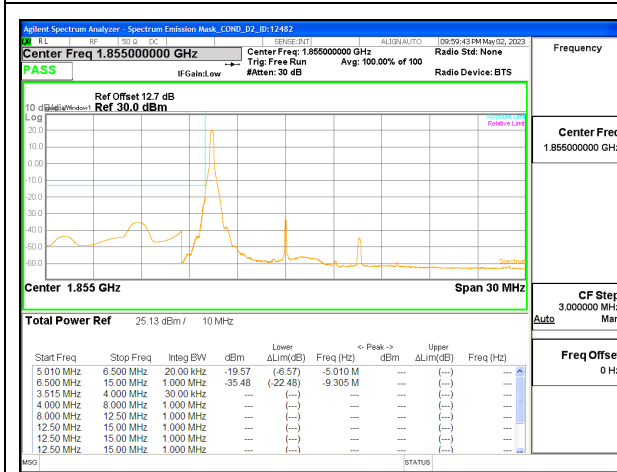
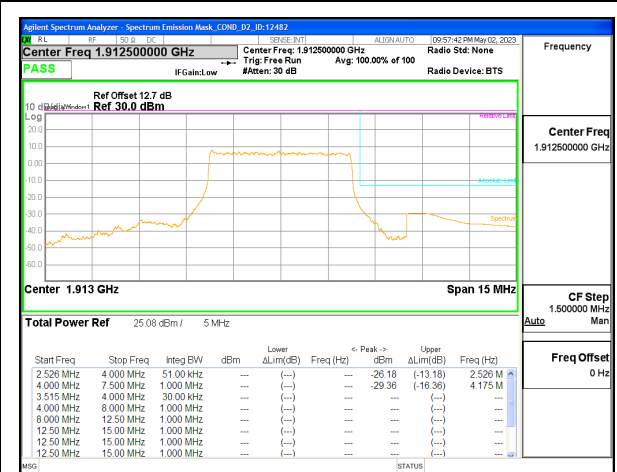
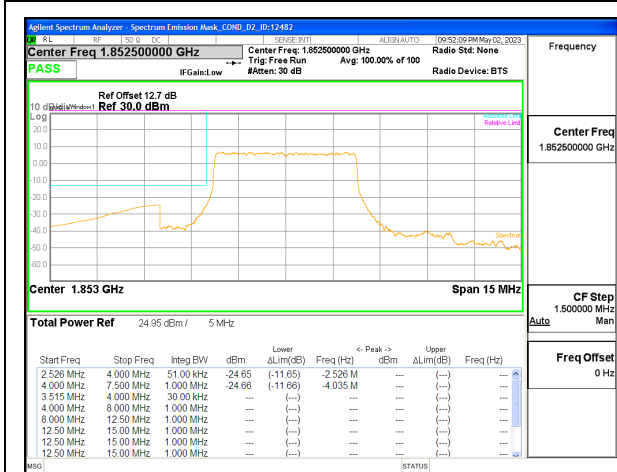
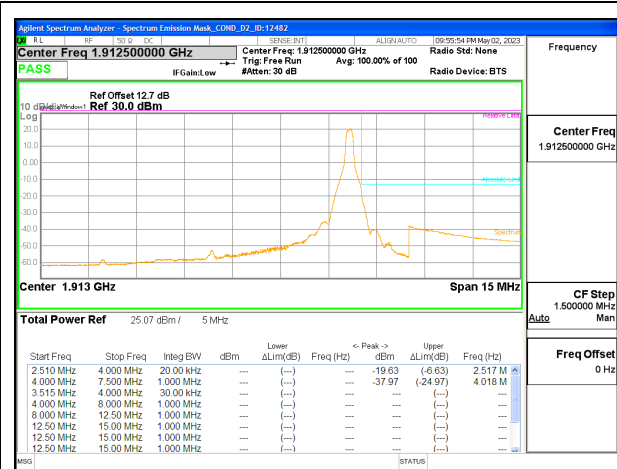
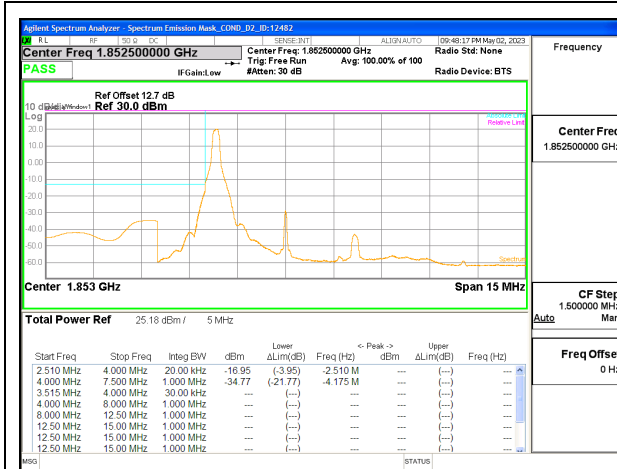



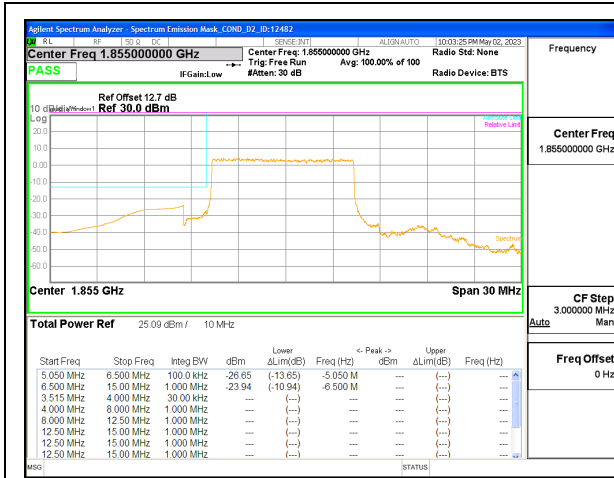

5G NR n25 10MHz BPSK Low Channel RB50-0



5G NR n25 10MHz BPSK High Channel RB50-0

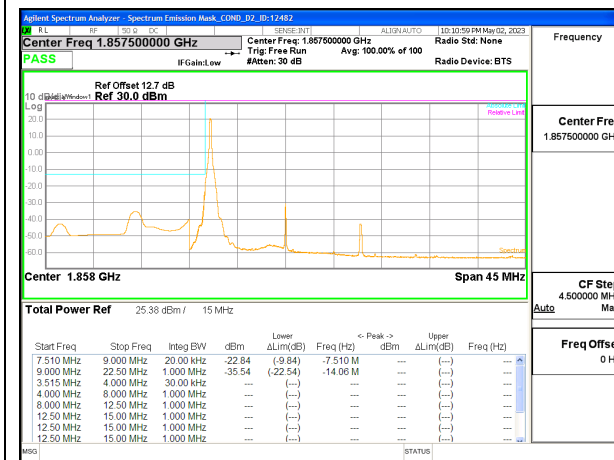

5G NR n25 15MHz BPSK Low Channel RB1-0

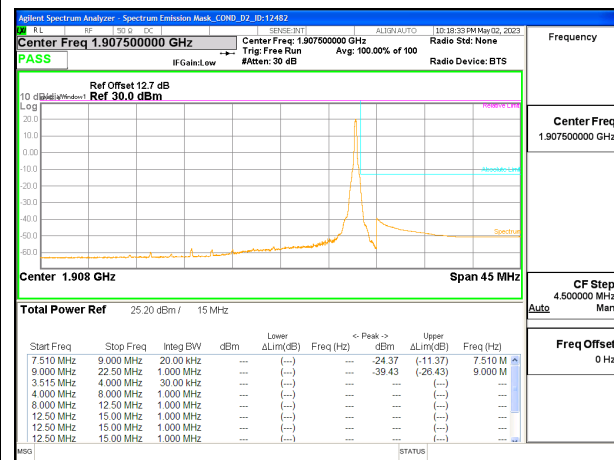

5G NR n25 15MHz BPSK High Channel RB1-78

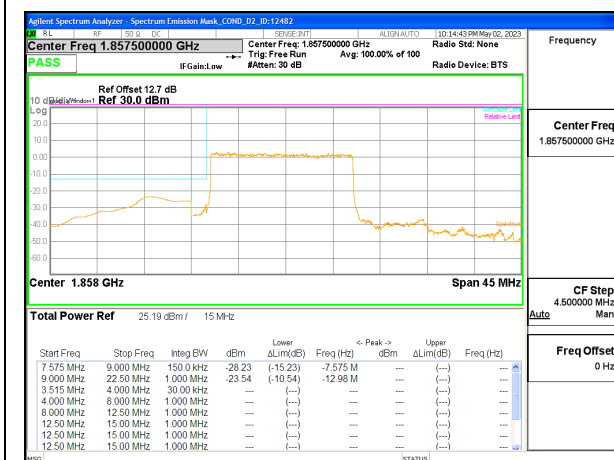

5G NR n25 15MHz BPSK Low Channel RB75-0

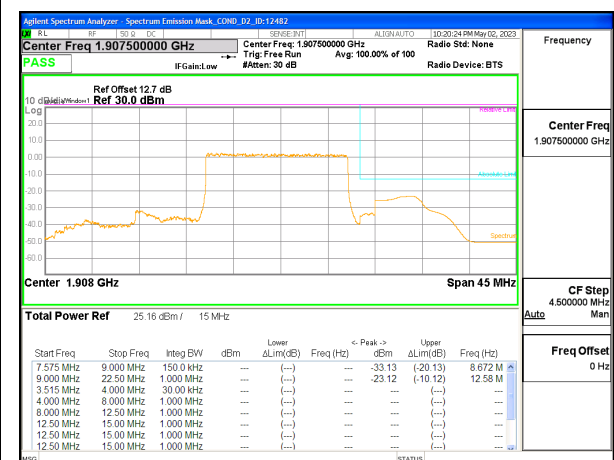

5G NR n25 15MHz BPSK High Channel RB75-0



5G NR n25 20MHz BPSK Low Channel RB1-0



5G NR n25 20MHz BPSK High Channel RB1-105



5G NR n25 20MHz BPSK Low Channel RB100-0

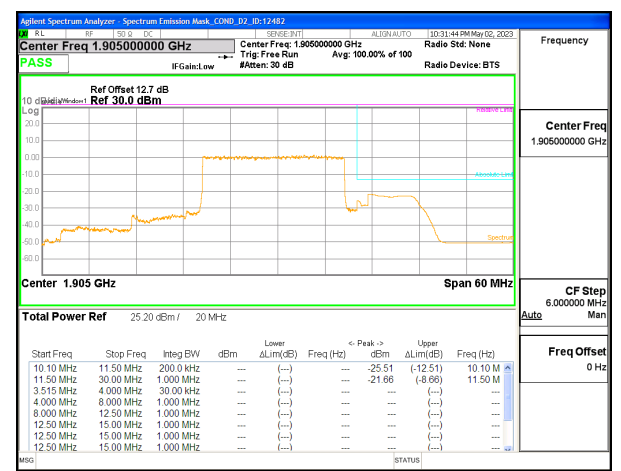

5G NR n25 20MHz BPSK High Channel RB100-0

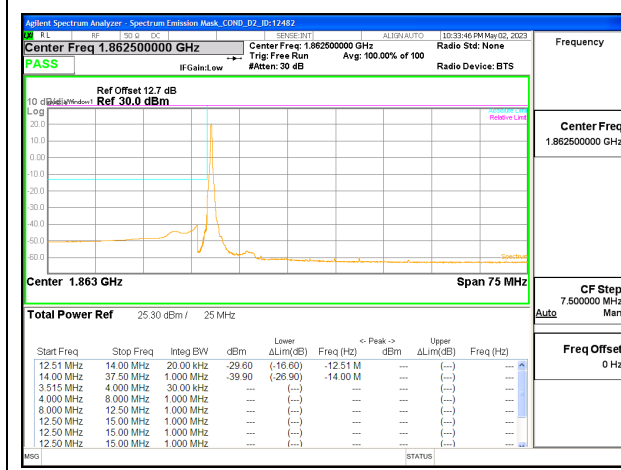

5G NR n25 25MHz BPSK Low Channel RB1-0

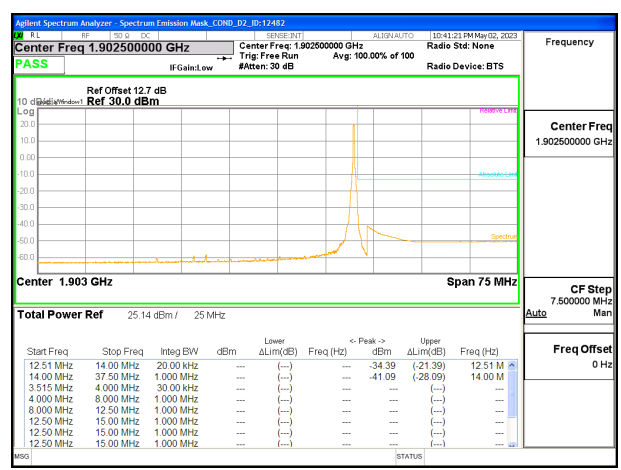

5G NR n25 25MHz BPSK High Channel RB1-132

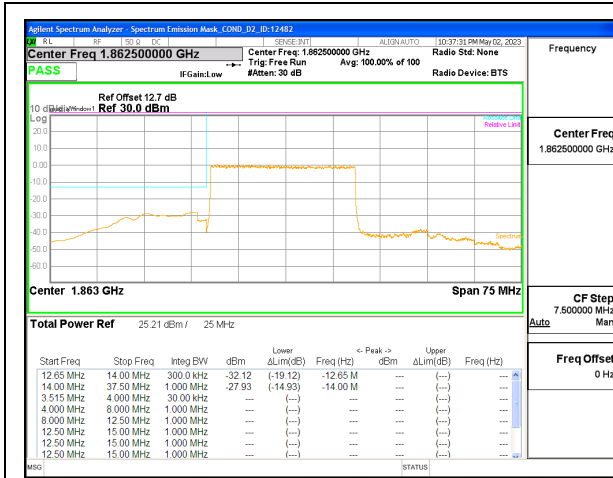

5G NR n25 25MHz BPSK Low Channel RB128-0

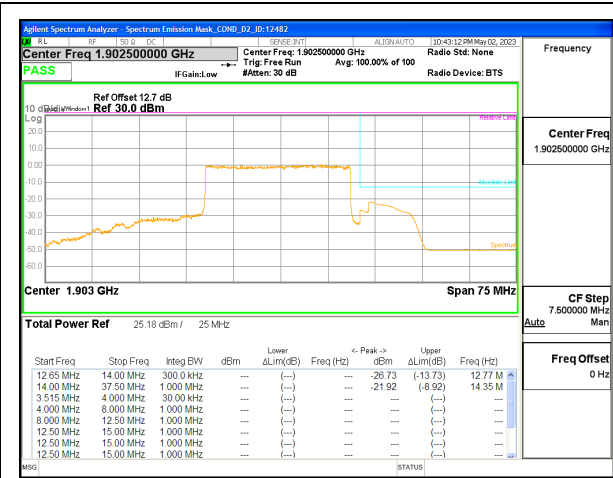

5G NR n25 25MHz BPSK High Channel RB128-0

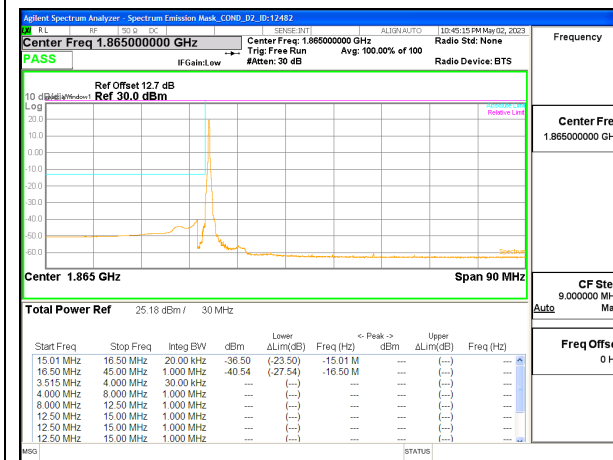

5G NR n25 30MHz BPSK Low Channel RB1-0

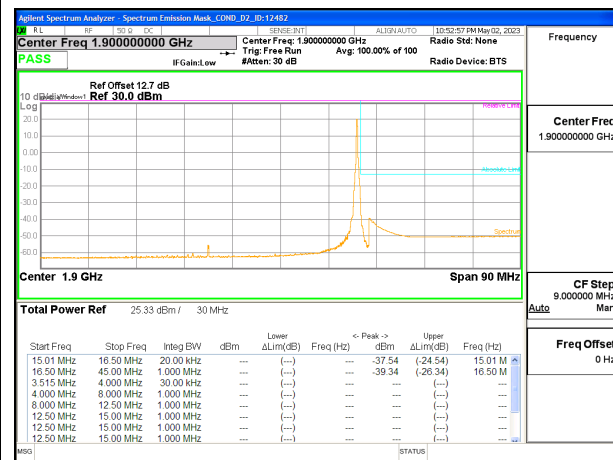

5G NR n25 30MHz BPSK High Channel RB1-159

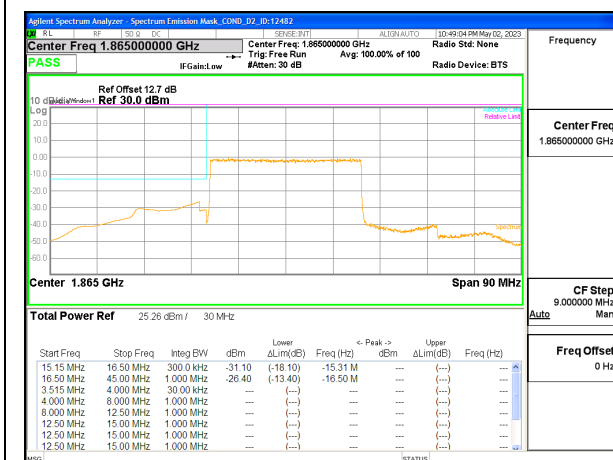

5G NR n25 30MHz BPSK Low Channel RB160-0

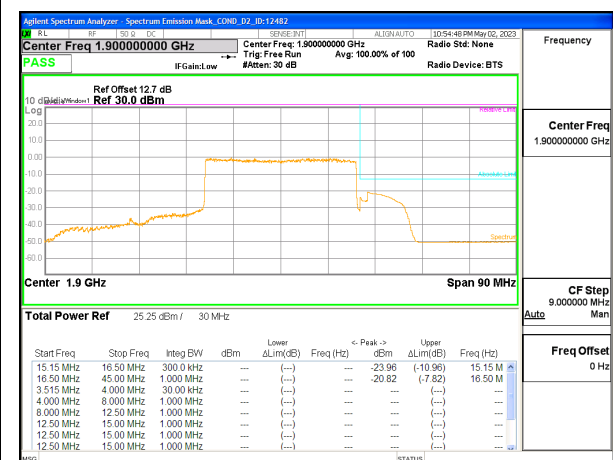

5G NR n25 30MHz BPSK High Channel RB160-0

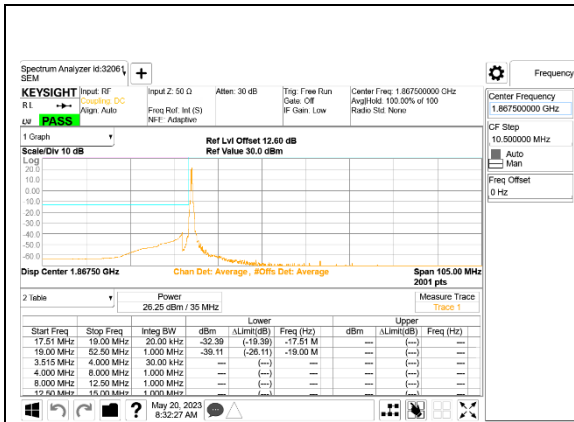

5G NR n25 35MHz BPSK Low Channel RB1-0

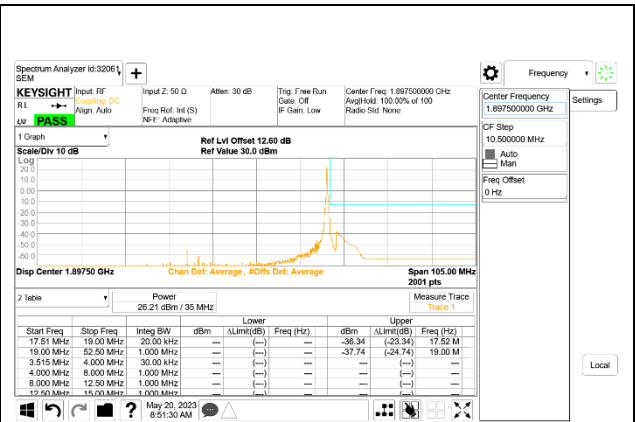

5G NR n25 35MHz BPSK High Channel RB1-187

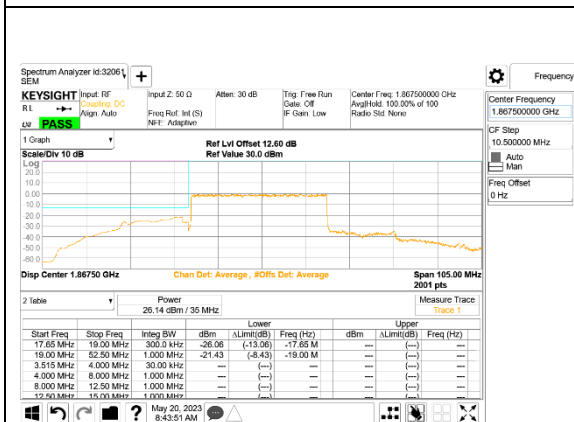

5G NR n25 35MHz BPSK Low Channel RB180-0

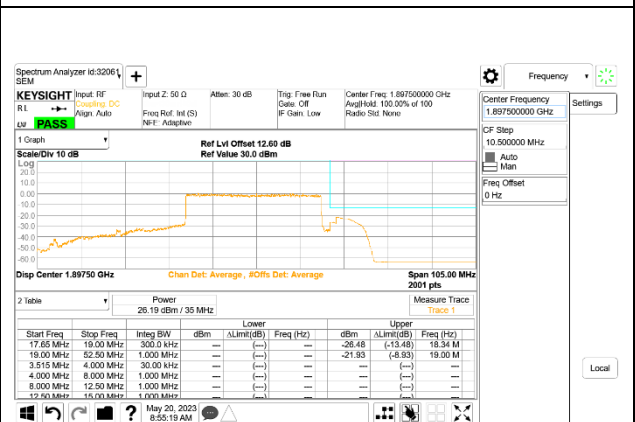

5G NR n25 35MHz BPSK High Channel RB180-0

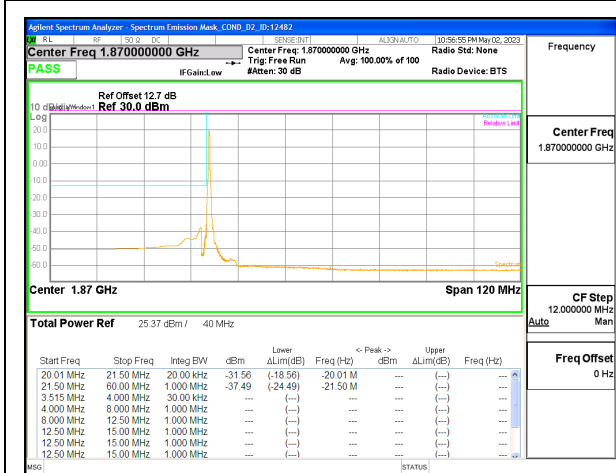

5G NR n25 40MHz BPSK Low Channel RB1-0

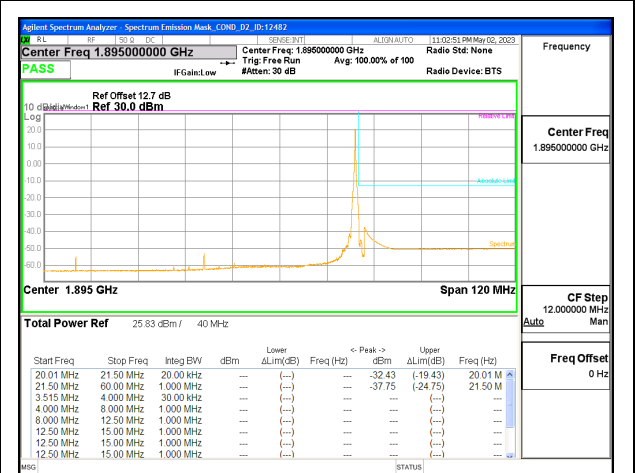

5G NR n25 40MHz BPSK High Channel RB1-215

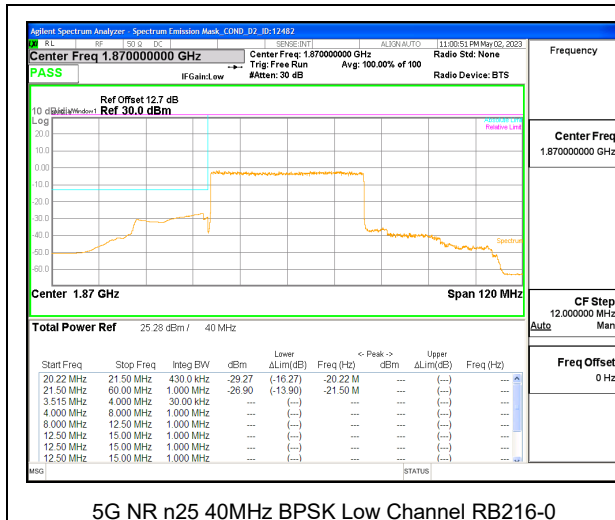

5G NR n25 40MHz BPSK Low Channel RB216-0

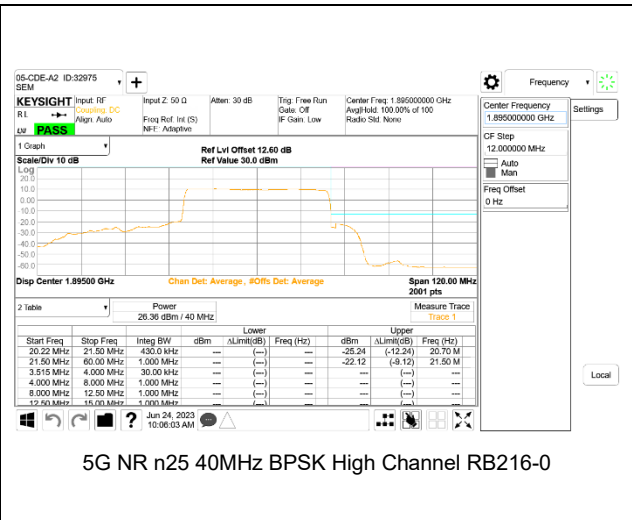

5G NR n25 40MHz BPSK High Channel RB216-0

## 9.2.7. LTE BAND 26 AND 5G NR n26 (PART 90S)

### LIMITS

FCC: §90.691 Emission mask requirements for EA-based systems.

(a) Out-of-band emission requirement shall apply only to the “outer” channels included in an EA license and to spectrum adjacent to interior channels used by incumbent licensees. The emission limits are as follows:

(1) For any frequency removed from the EA licensee's frequency block by up to and including 37.5 kHz, the power of any emission shall be attenuated below the transmitter power ( $P$ ) in watts by at least  $116 \text{ Log}_{10}(f/6.1)$  decibels or  $50 + 10 \text{ Log}_{10}(P)$  decibels or 80 decibels, whichever is the lesser attenuation, where  $f$  is the frequency removed from the center of the outer channel in the block in kilohertz and where  $f$  is greater than 12.5 kHz.

(2) For any frequency removed from the EA licensee's frequency block greater than 37.5 kHz, the power of any emission shall be attenuated below the transmitter power ( $P$ ) in watts by at least  $43 + 10 \text{ Log}_{10}(P)$  decibels or 80 decibels, whichever is the lesser attenuation, where  $f$  is the frequency removed from the center of the outer channel in the block in kilohertz and where  $f$  is greater than 37.5 kHz.

NOTE: According to 971168 D02 Misc Rev Approv License Devices v02r02, Section VIII (c):

For Section 90.691(a) compliance testing, use RBW = 300 Hz for offsets less than 37.5 kHz from a channel edge; RBW = 100 kHz for offsets greater than 37.5 kHz is allowed.

**LTE BAND 26 EMISSION MASK**

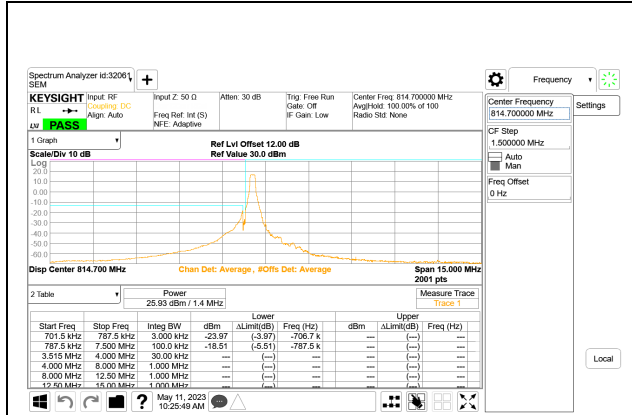

LTE B26 1.4MHz QPSK Low Channel RB1-0

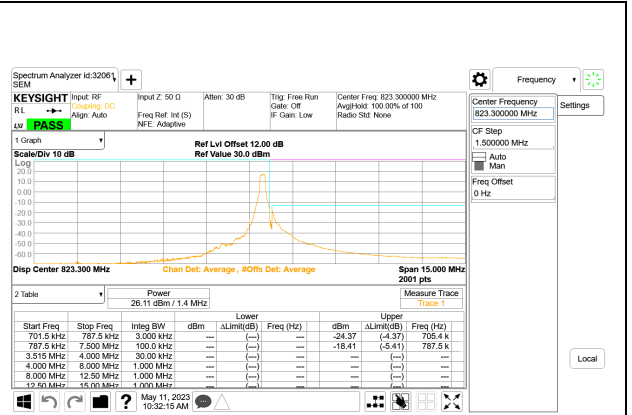

LTE B26 1.4MHz QPSK High Channel RB1-5

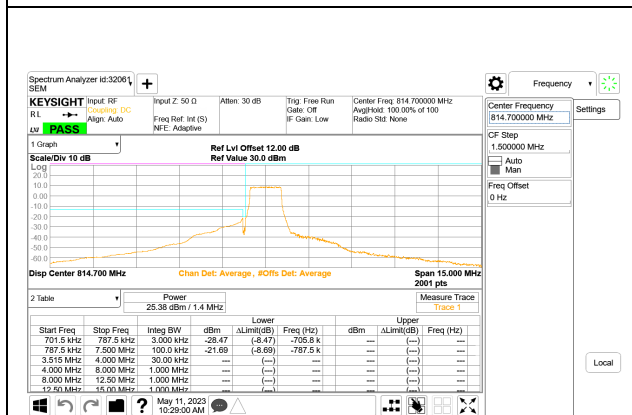

LTE B26 1.4MHz QPSK Low Channel RB6-0

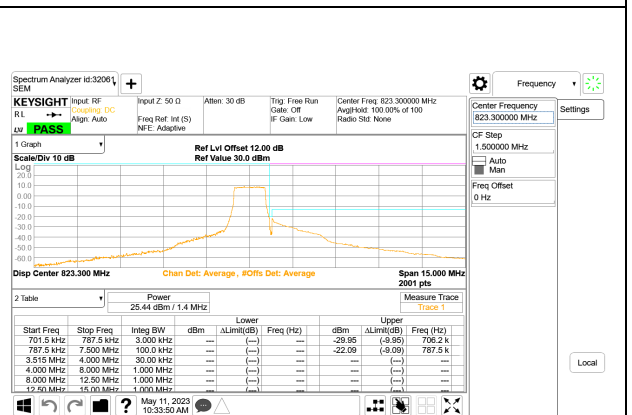

LTE B26 1.4MHz QPSK High Channel RB6-0

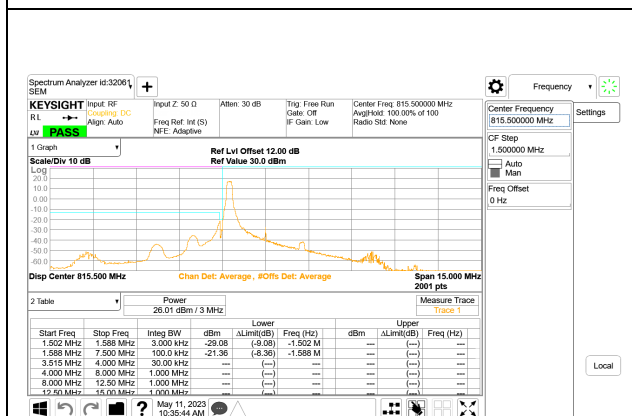

LTE B26 3MHz QPSK Low Channel RB1-0

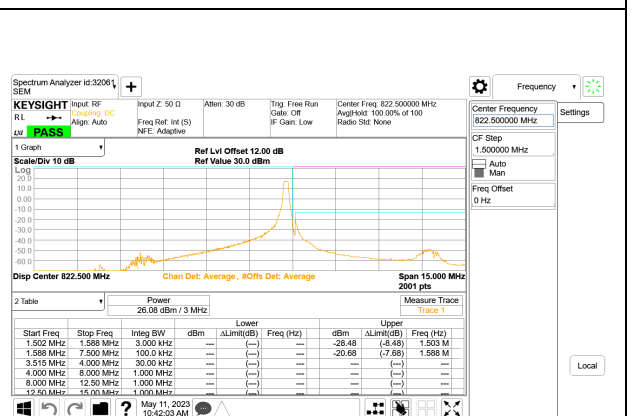

LTE B26 3MHz QPSK High Channel RB1-14