

LTE B66 15MHz QPSK Low Channel RB75-0, ID:25780

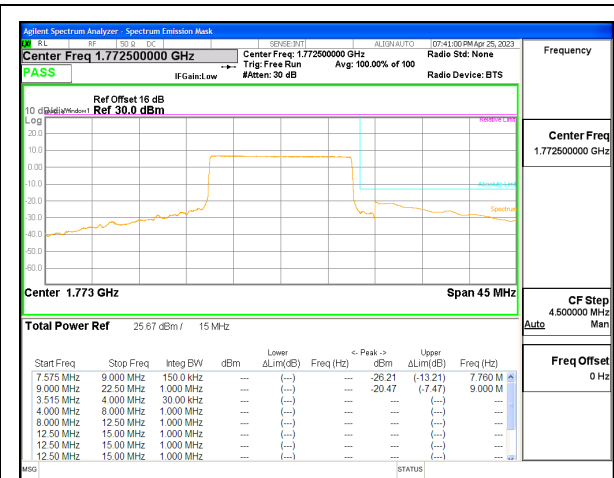

LTE B66 15MHz QPSK High Channel RB75-0, ID:25780

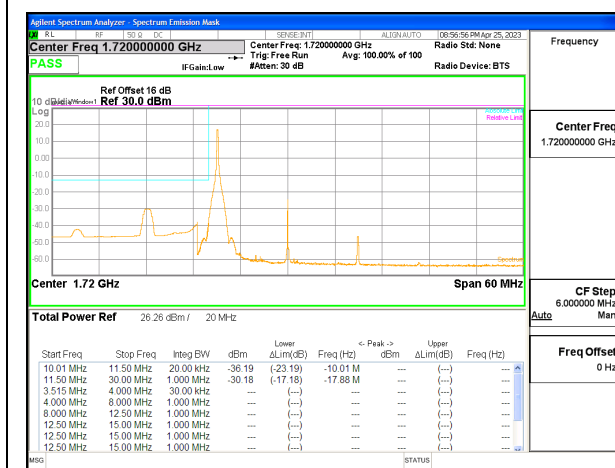

LTE B66 20MHz QPSK Low Channel RB1-0, ID:25780

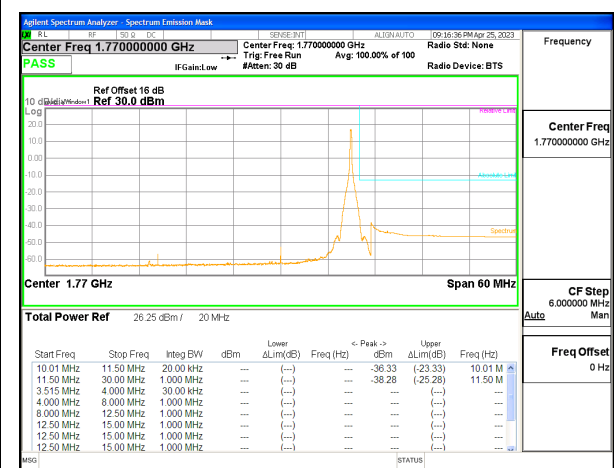

LTE B66 20MHz QPSK High Channel RB1-99, ID:25780

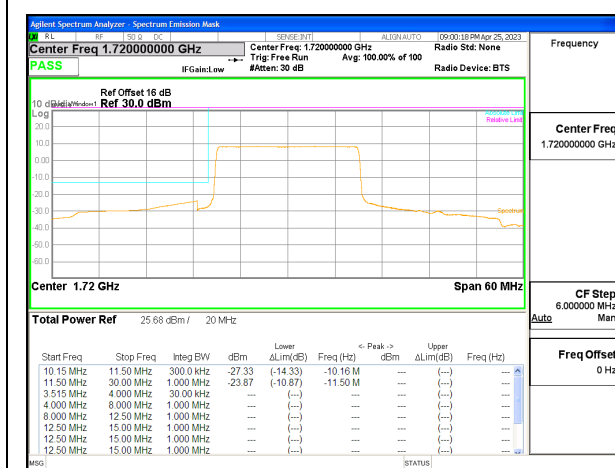

LTE B66 20MHz QPSK Low Channel RB100-0, ID:25780

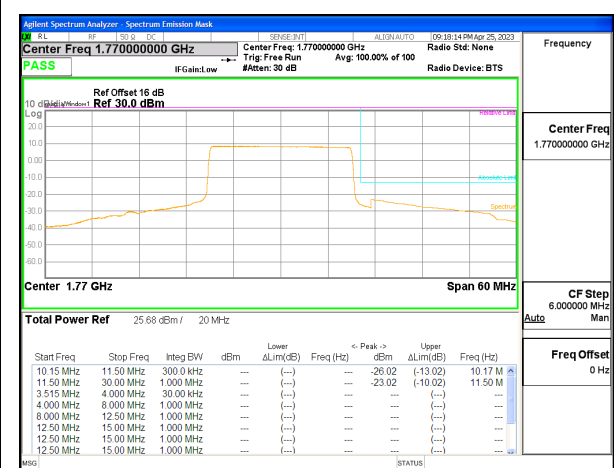

LTE B66 20MHz QPSK High Channel RB100-0, ID:25780

5G NR n66 BANDEDGE

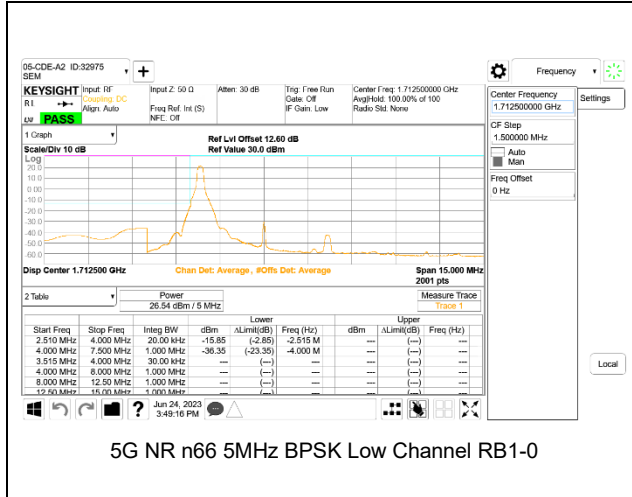

5G NR n66 5MHz BPSK Low Channel RB1-0

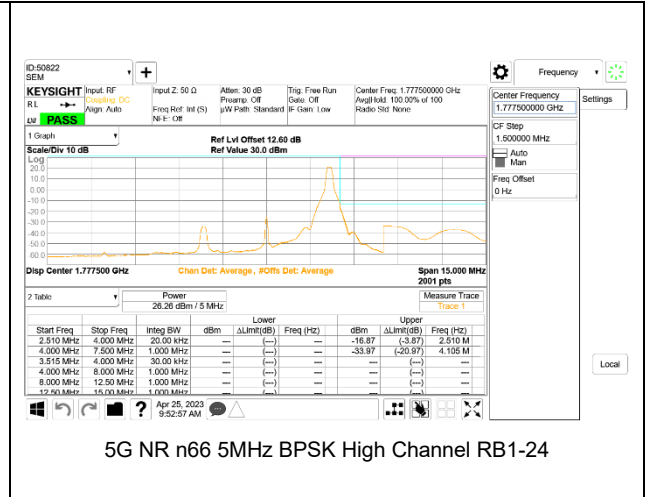

5G NR n66 5MHz BPSK High Channel RB1-24

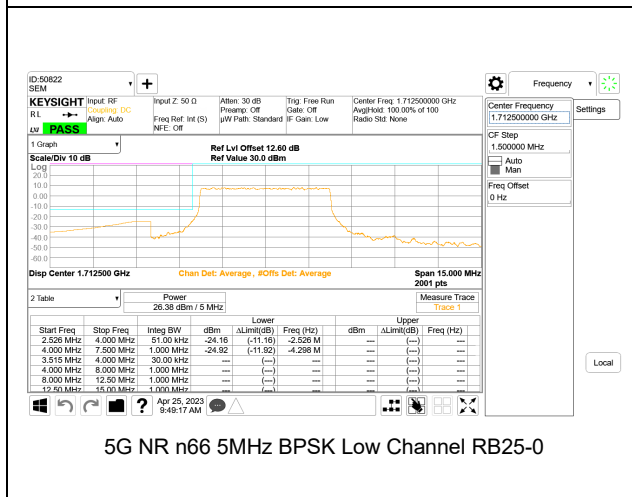

5G NR n66 5MHz BPSK Low Channel RB25-0

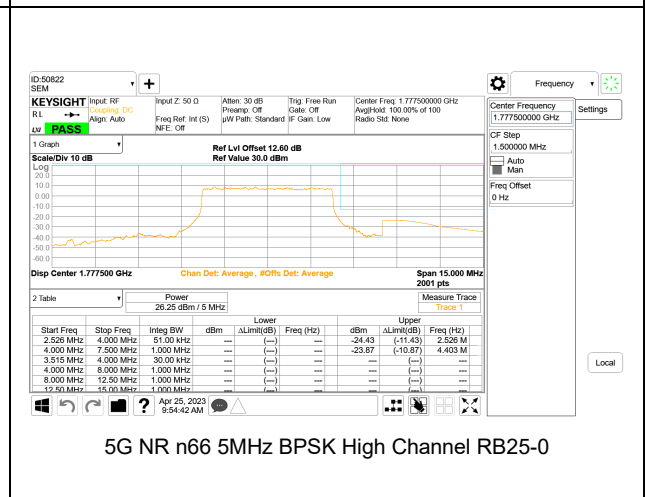

5G NR n66 5MHz BPSK High Channel RB25-0

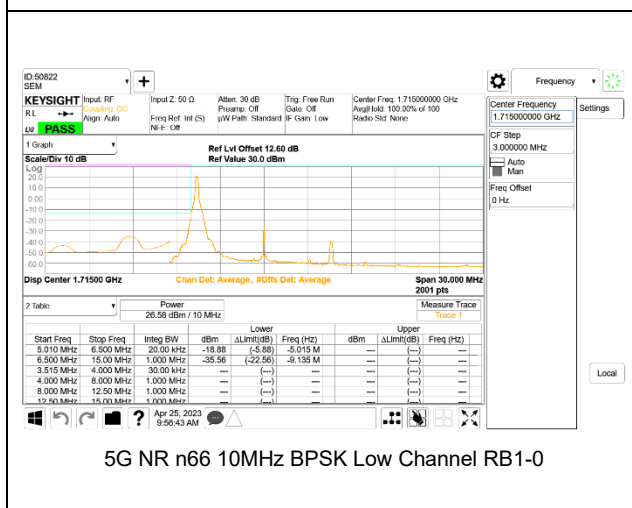

5G NR n66 10MHz BPSK Low Channel RB1-0

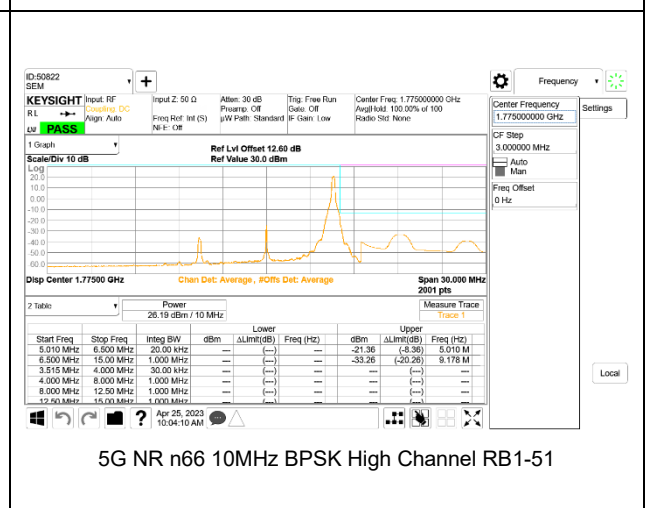

5G NR n66 10MHz BPSK High Channel RB1-51

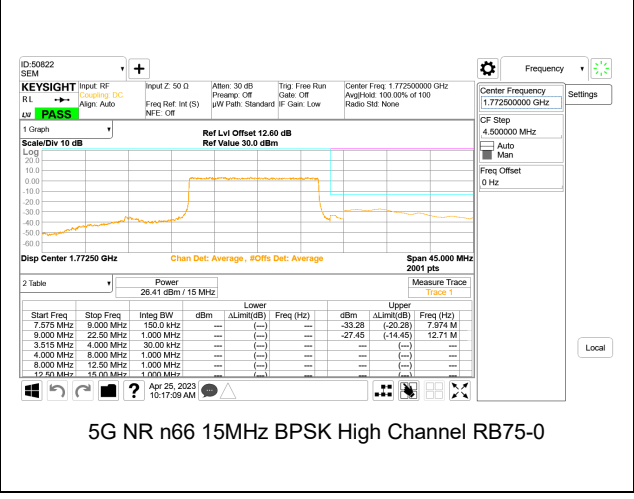
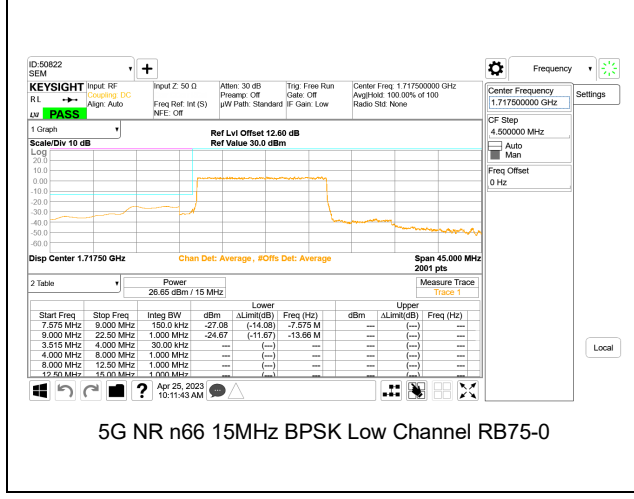
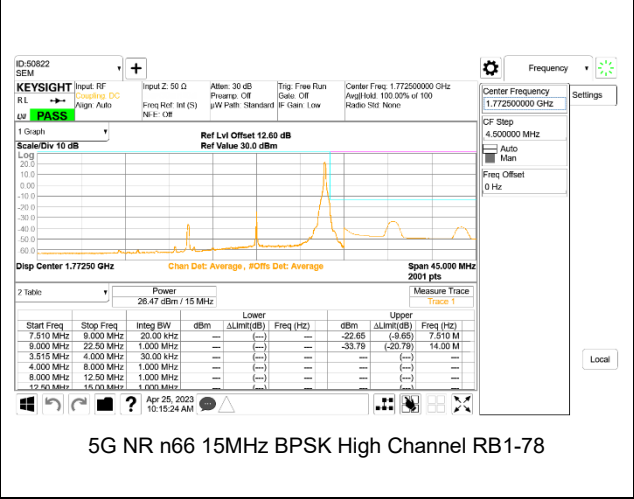
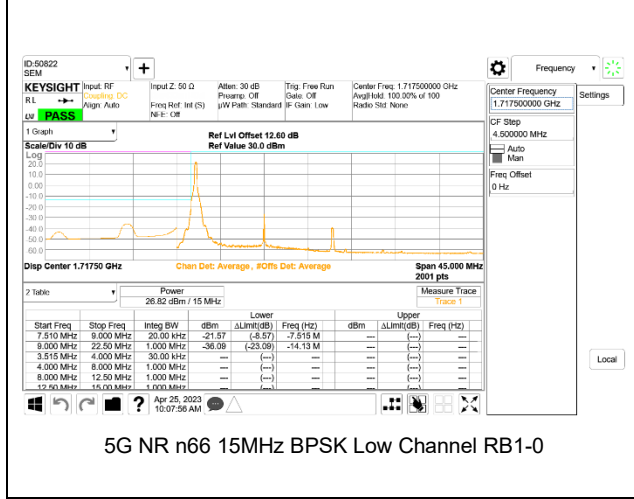
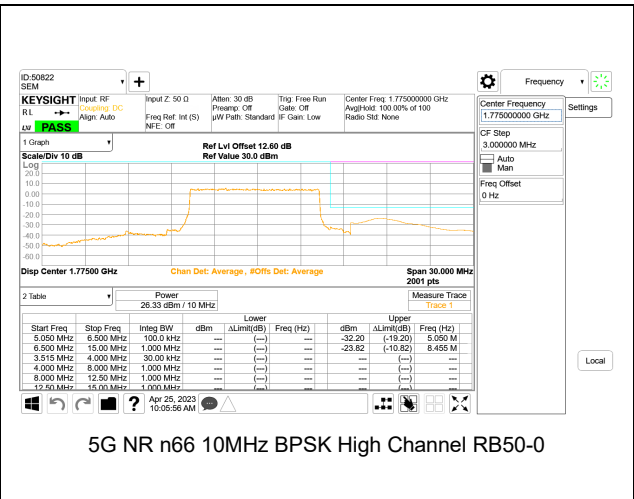
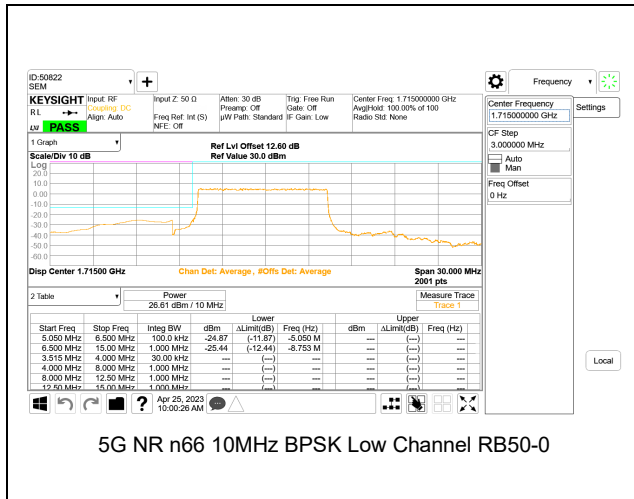

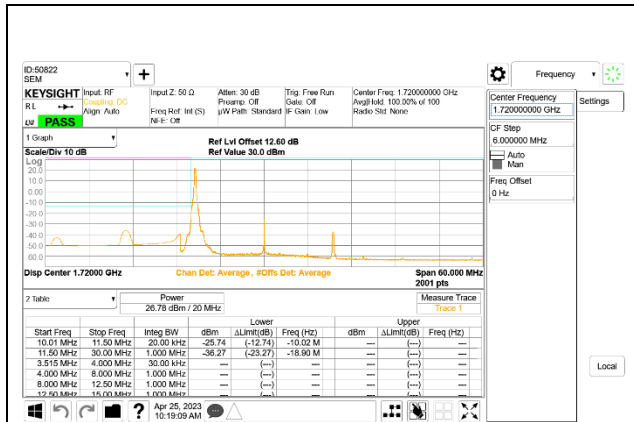

5G NR n66 20MHz BPSK Low Channel RB1-0

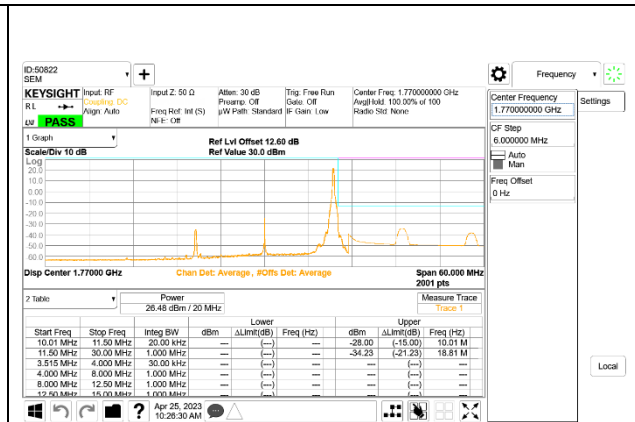

5G NR n66 20MHz BPSK High Channel RB1-105

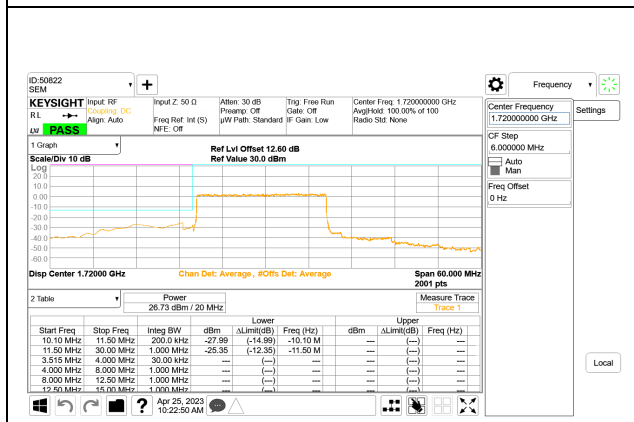

5G NR n66 20MHz BPSK Low Channel RB100-0

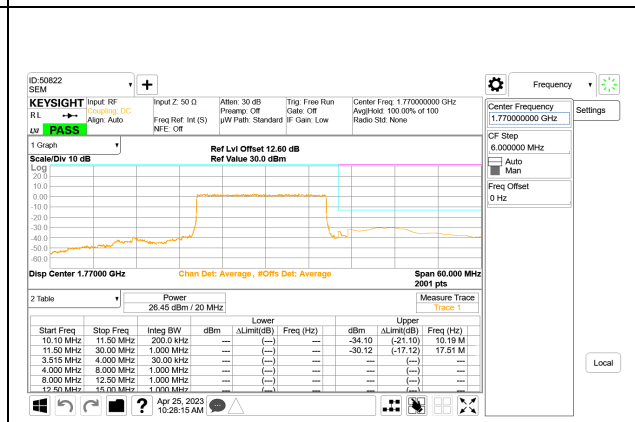

5G NR n66 20MHz BPSK High Channel RB100-0

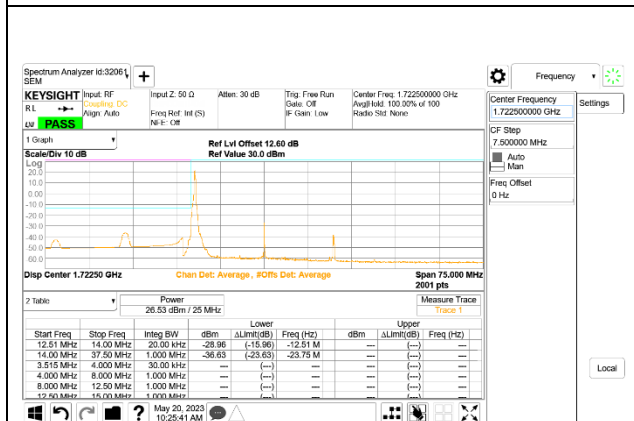

5G NR n66 25MHz BPSK Low Channel RB1-0

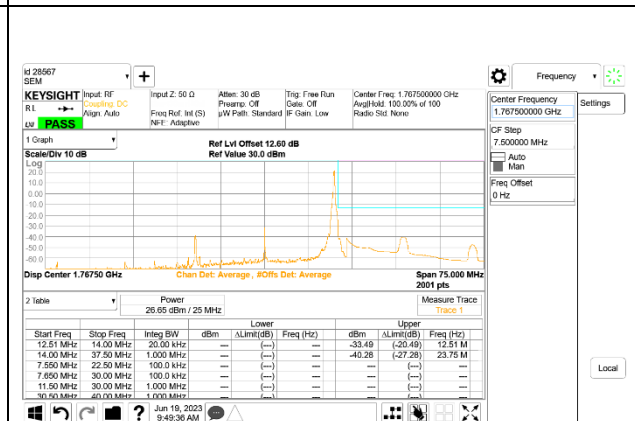

5G NR n66 25MHz BPSK High Channel RB1-132

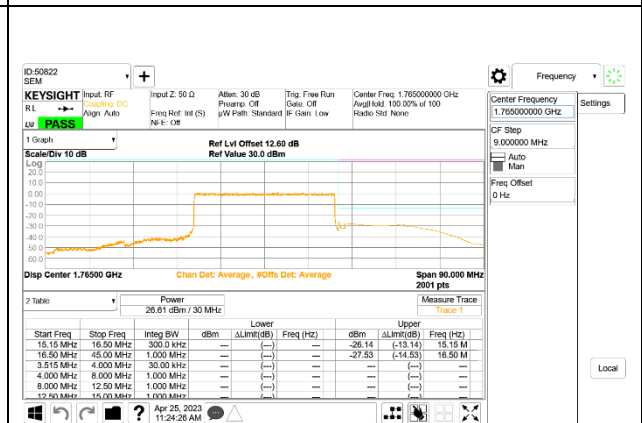
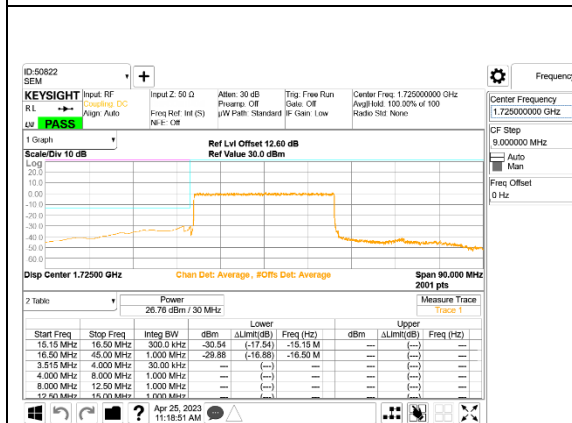
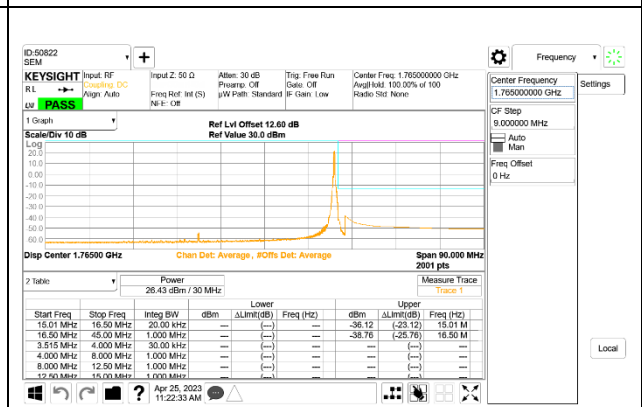
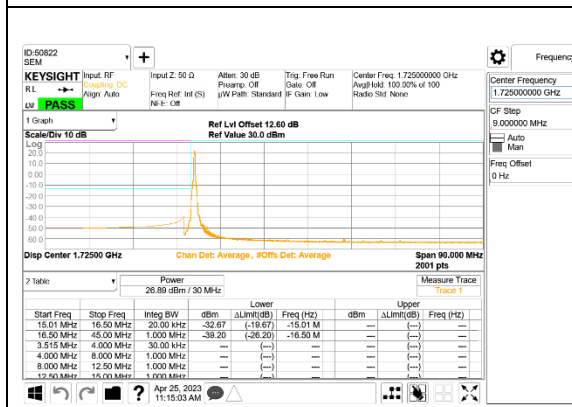
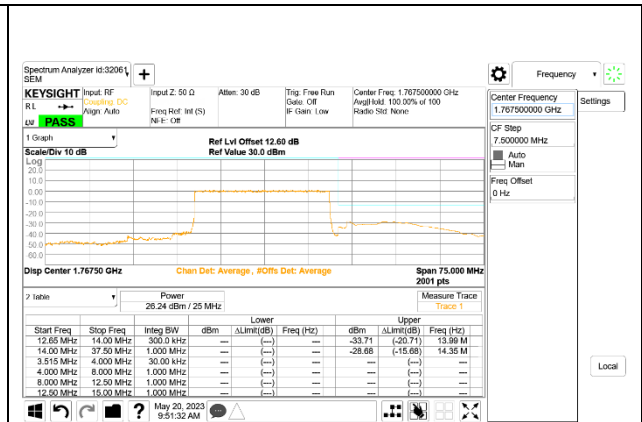
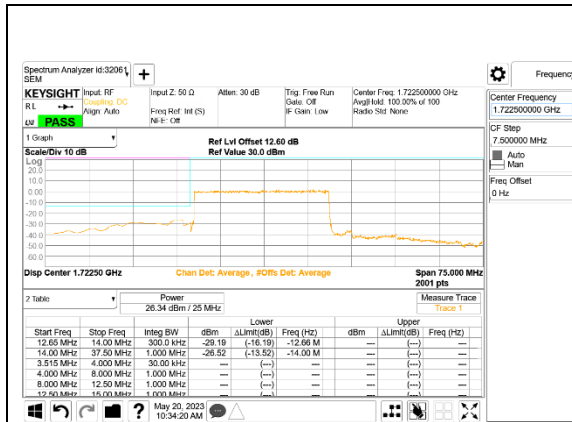

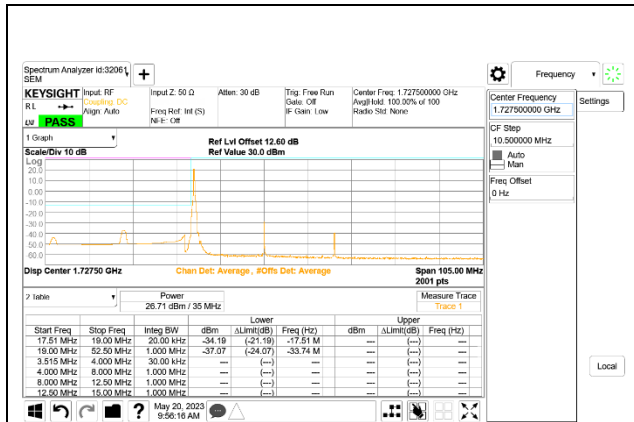

5G NR n66 35MHz BPSK Low Channel RB1-0

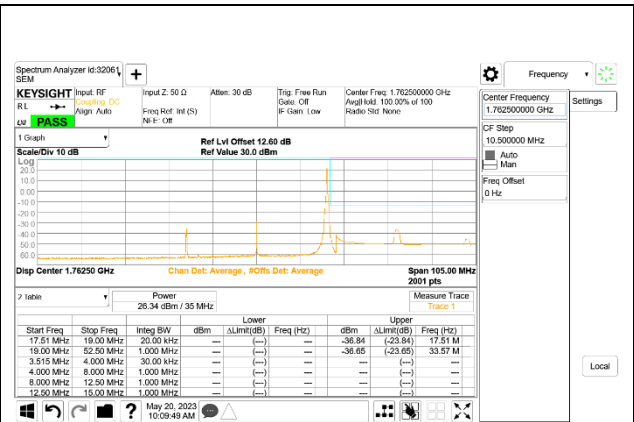

5G NR n66 35MHz BPSK High Channel RB1-187

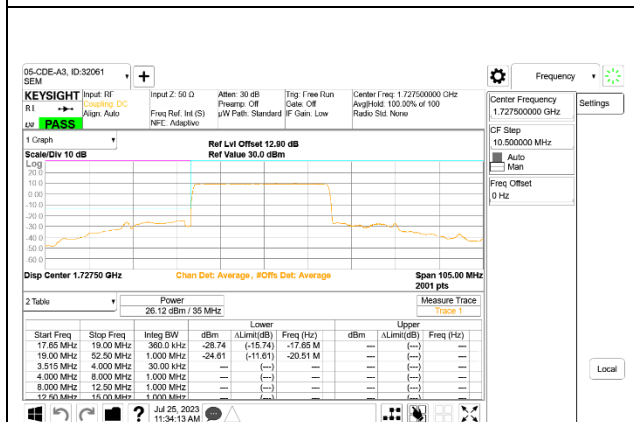

5G NR n66 35MHz BPSK Low Channel RB180-0

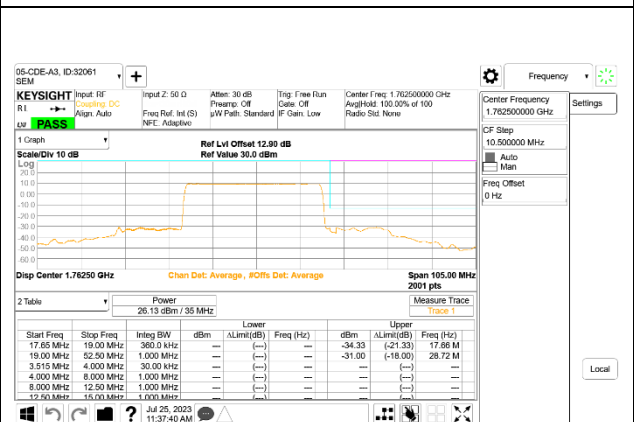

5G NR n66 35MHz BPSK High Channel RB180-0

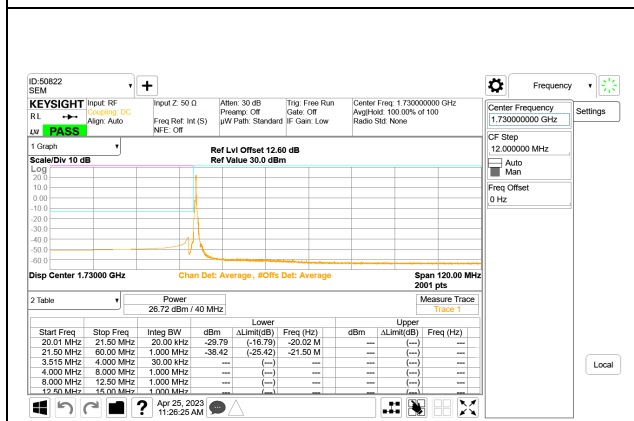

5G NR n66 40MHz BPSK Low Channel RB1-0

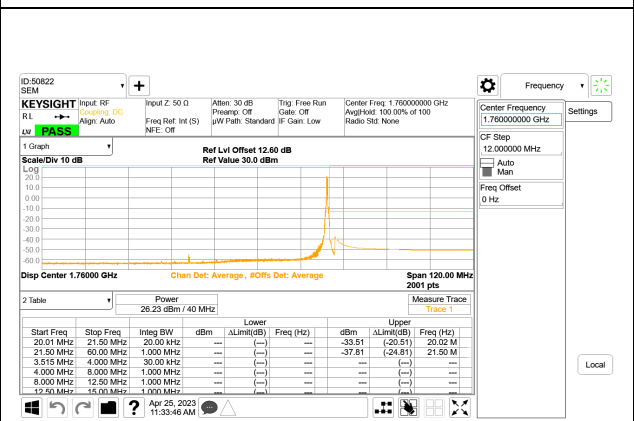

5G NR n66 40MHz BPSK High Channel RB1-215

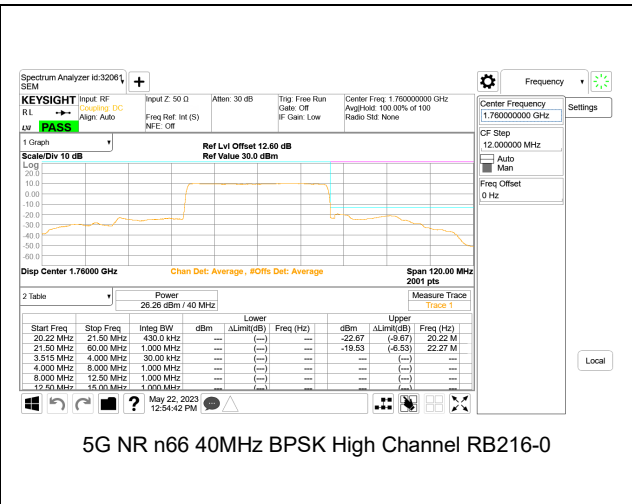
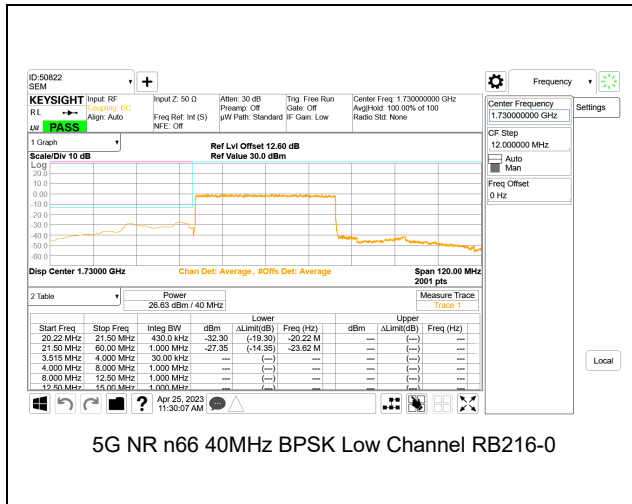

9.2.13. 5G NR n70

LIMITS

FCC: §27.53(h)

The power of any emission outside of the authorized operating frequency ranges must be attenuated below the transmitting power (P) by a factor of at least 43 + 10 log (P) dB.

NOTE: 20MHz and 25MHz Bandwidth Upper Block Bandedge is covered by 5G NR n66 20MHz and 25MHz Bandwidth.

5G NR n70 EMISSION MASK

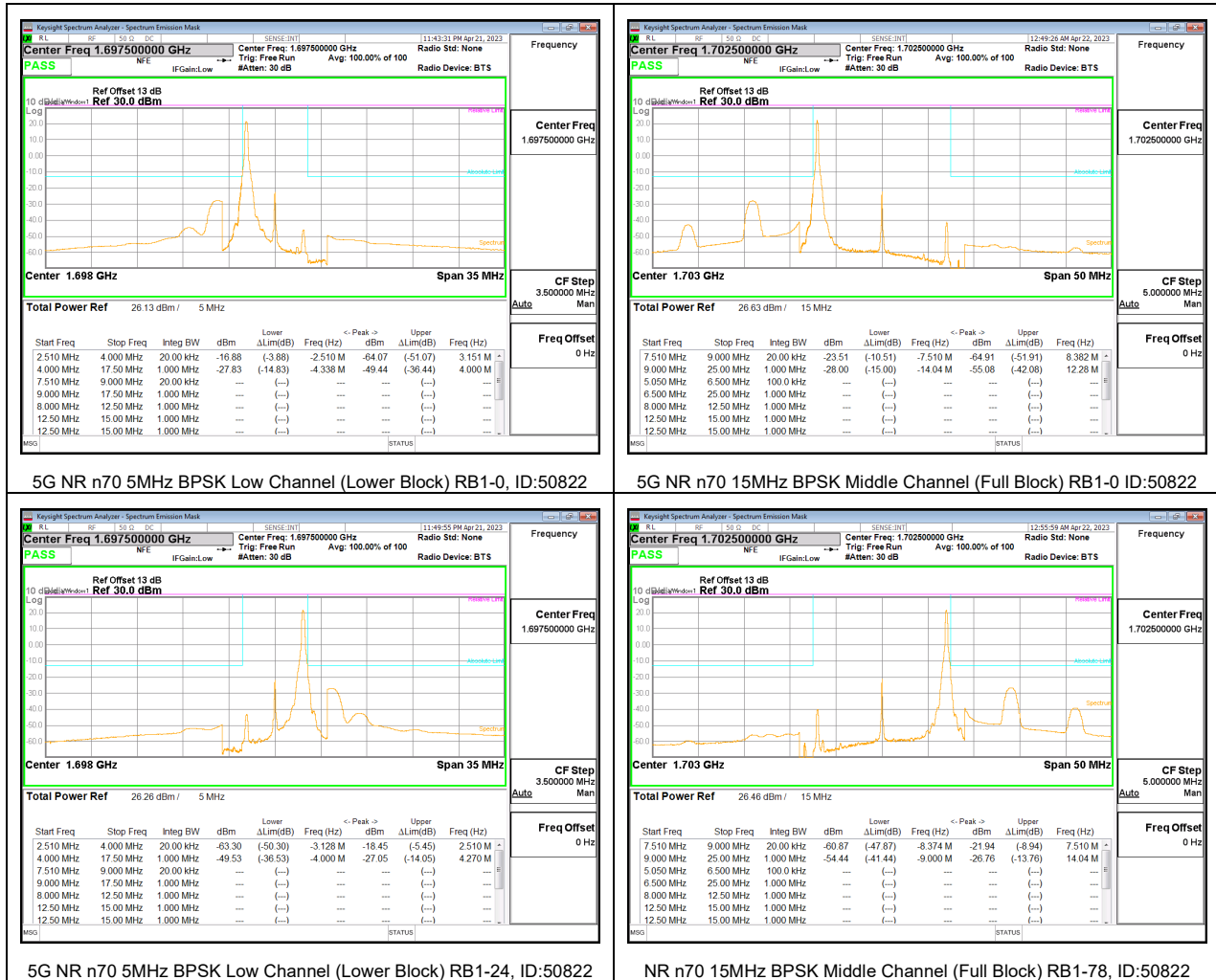

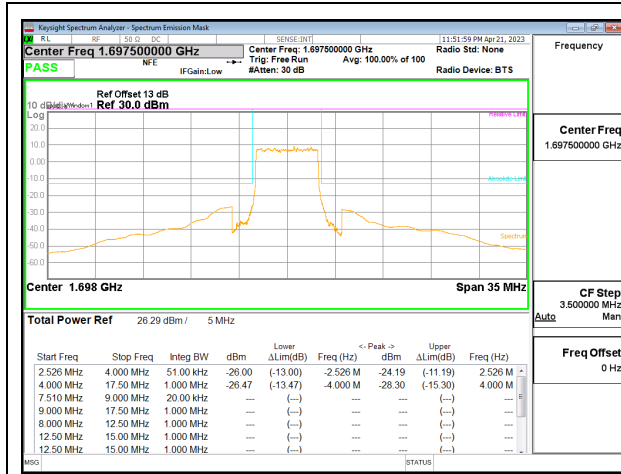

5G NR n70 5MHz BPSK Low Channel (Lower Block) RB25-0, ID:50822

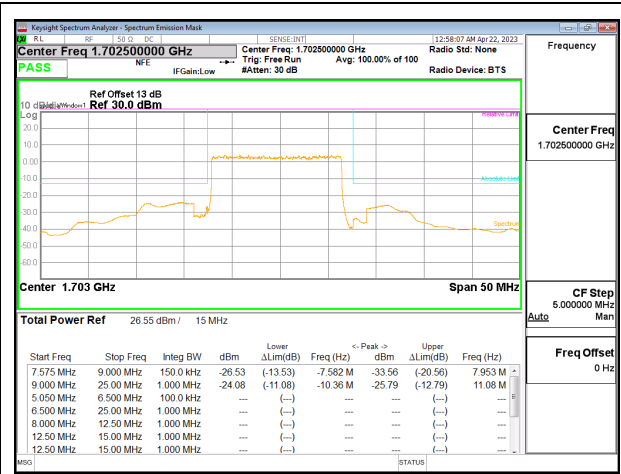

5G NR n70 15MHz BPSK Middle Channel (Full Block) RB75-0, ID:50822

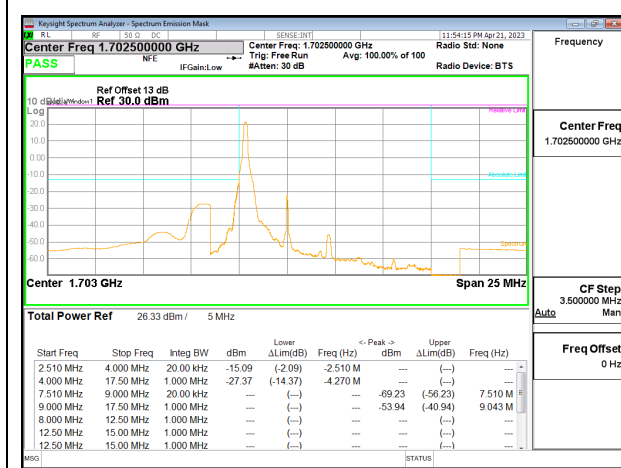

5G NR n70 5MHz BPSK Middle Channel (Upper Block) RB1-0, ID:50822

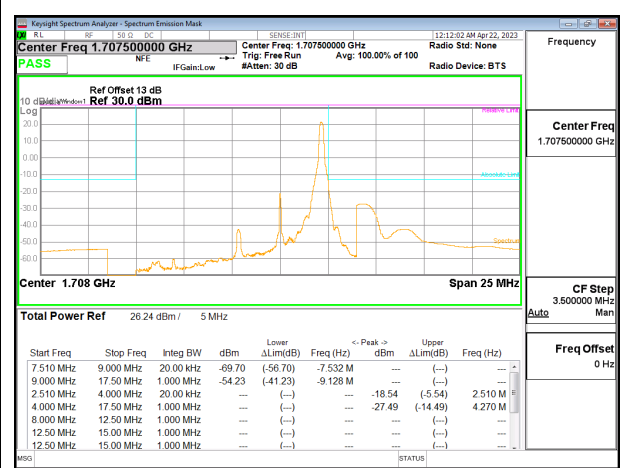

5G NR n70 5MHz BPSK High Channel (Upper Block) RB1-25, ID:50822

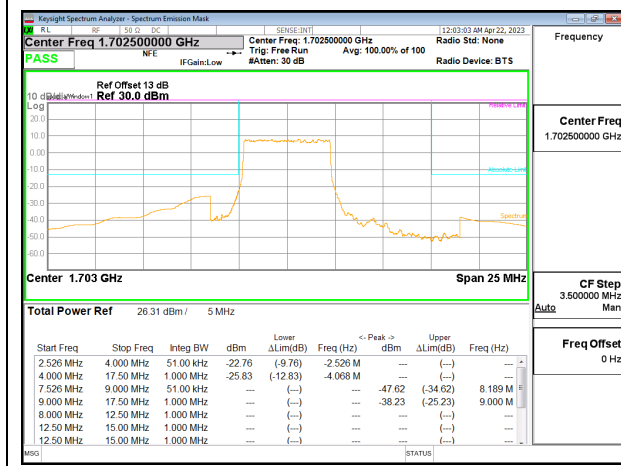

5G NR n70 5MHz BPSK Middle Channel (Upper Block) RB25-0, ID:50822

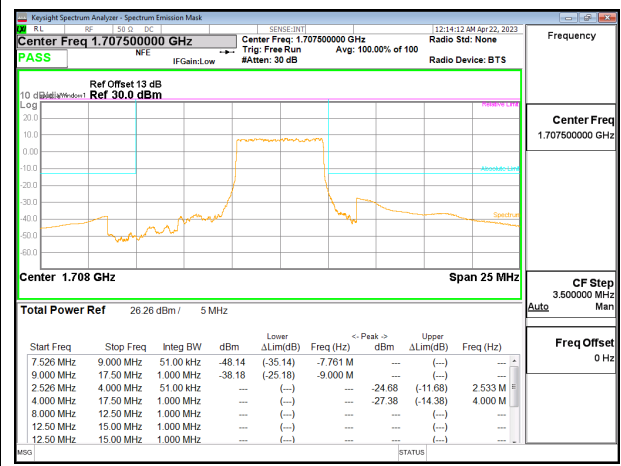

5G NR n70 5MHz BPSK High Channel (Upper Block) RB25-0, ID:50822

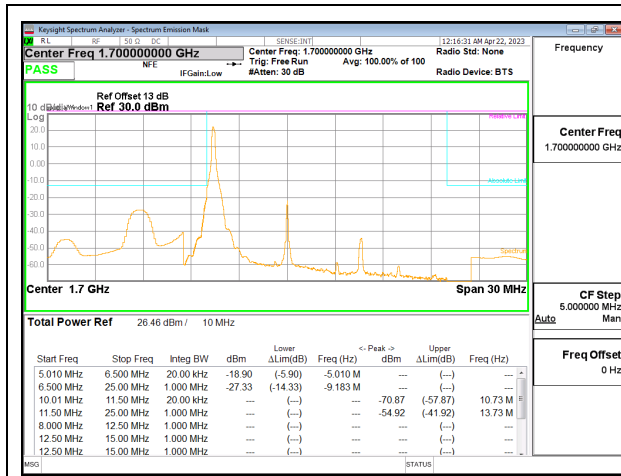

5G NR n70 10MHz BPSK Low Channel (Full Block) RB1-0, ID:50822

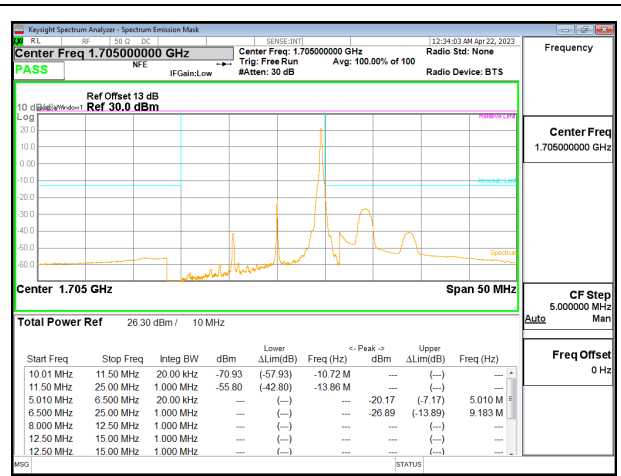

5G NR n70 10MHz BPSK High Channel (Full Block) RB1-51, ID:50822

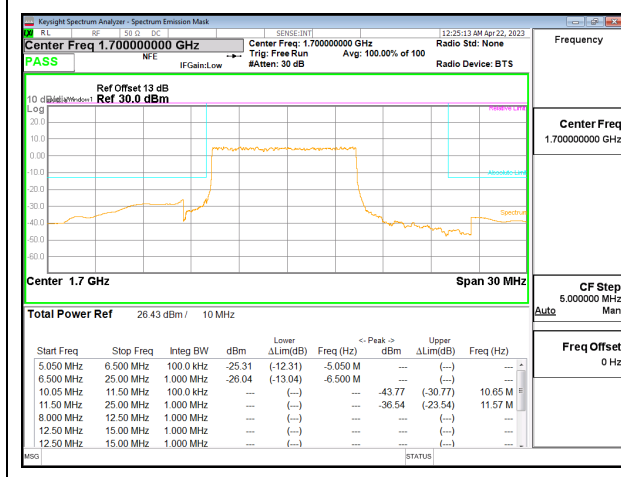

5G NR n70 10MHz BPSK Low Channel (Full Block) RB50-0, ID:50822

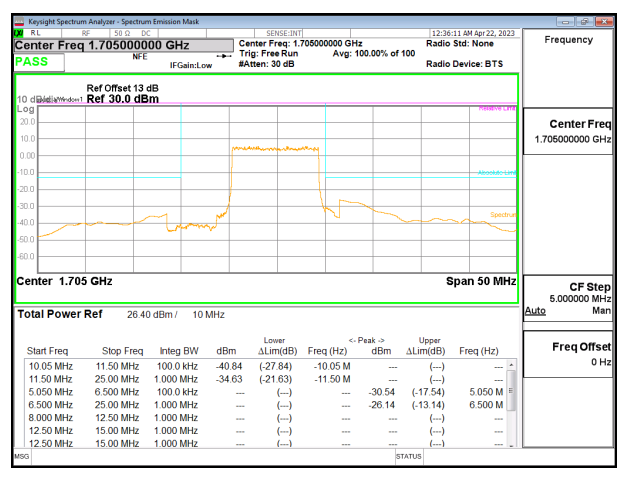

5G NR n70 10MHz BPSK High Channel (Full Block) RB50-0, ID:50822

9.2.14. LTE BAND 71 AND 5G NR n71

LIMITS

FCC: §27.53

(g) For operations in the 600 MHz band and the 698-746 MHz band, the power of any emission outside a licensee's frequency band(s) of operation shall be attenuated below the transmitter power (P) within the licensed band(s) of operation, measured in watts, by at least $43 + 10 \log (P)$ dB. Compliance with this provision is based on the use of measurement instrumentation employing a resolution bandwidth of 100 kilohertz or greater. However, in the 100 kilohertz bands immediately outside and adjacent to a licensee's frequency block, a resolution bandwidth of at least 30 kHz may be employed.

LTE BAND 71 ADJACENT CHANNEL POWER

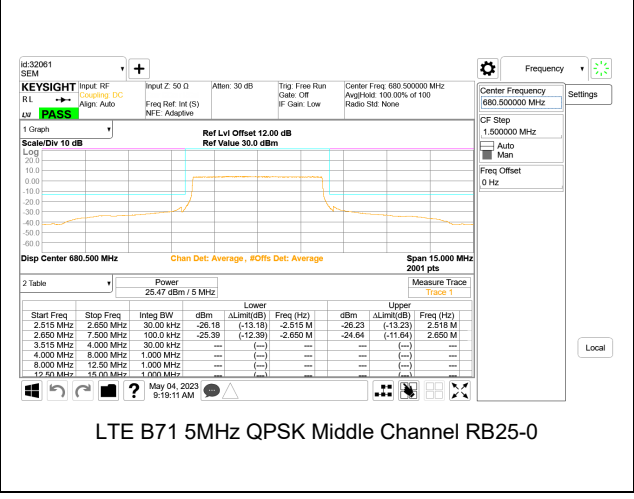
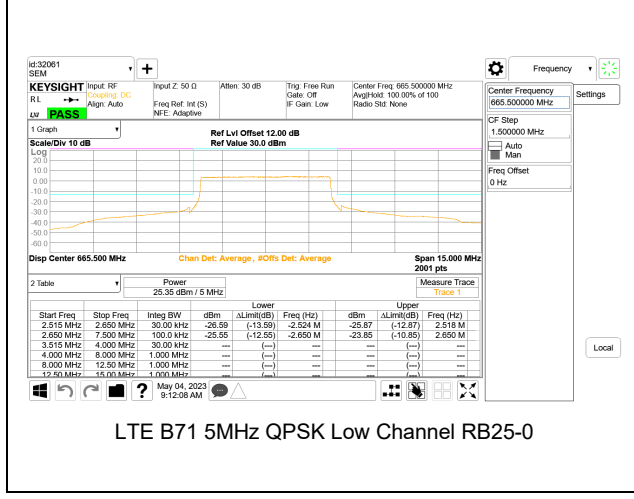
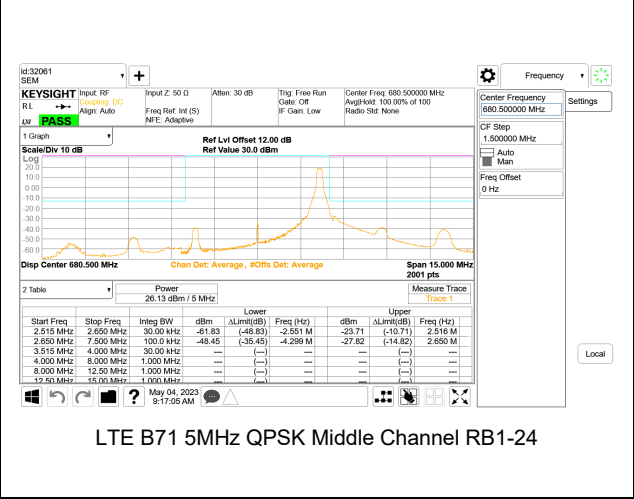
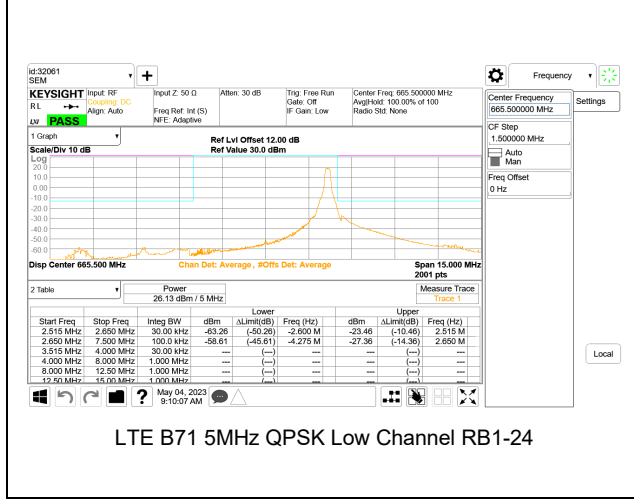
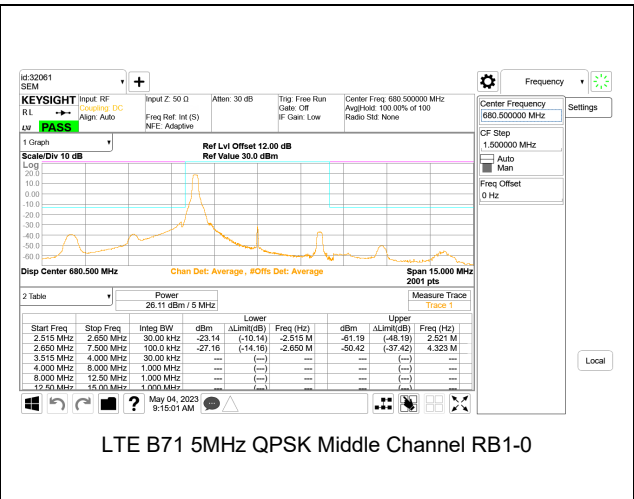
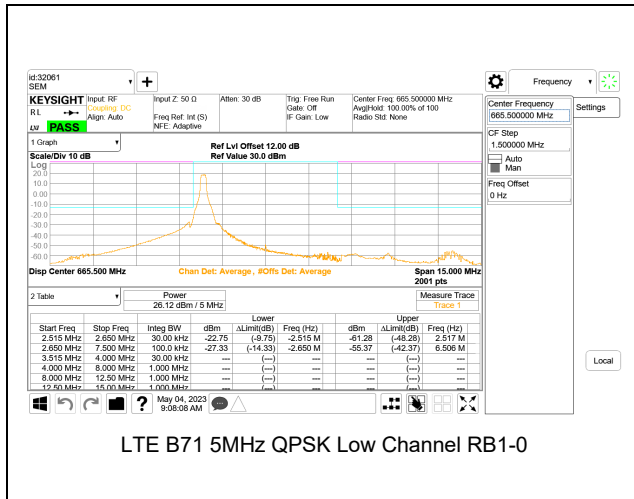

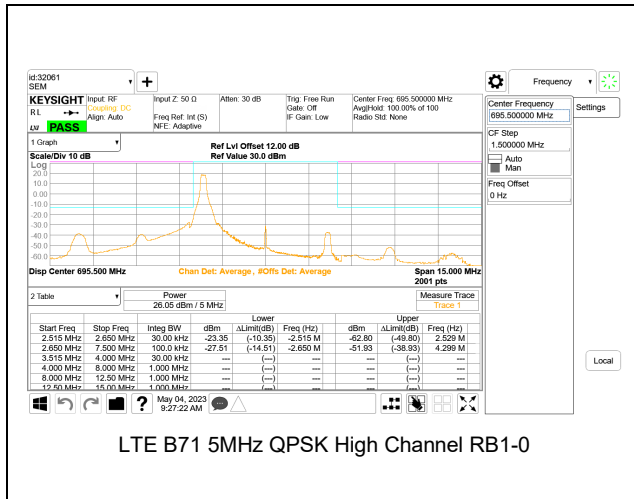

LTE B71 5MHz QPSK High Channel RB1-0

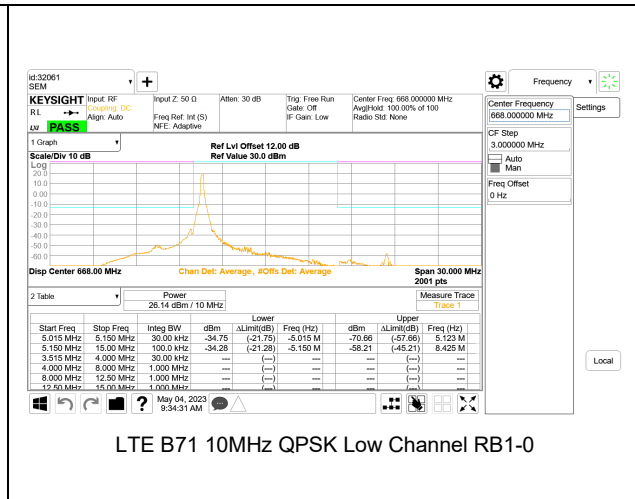

LTE B71 10MHz QPSK Low Channel RB1-0

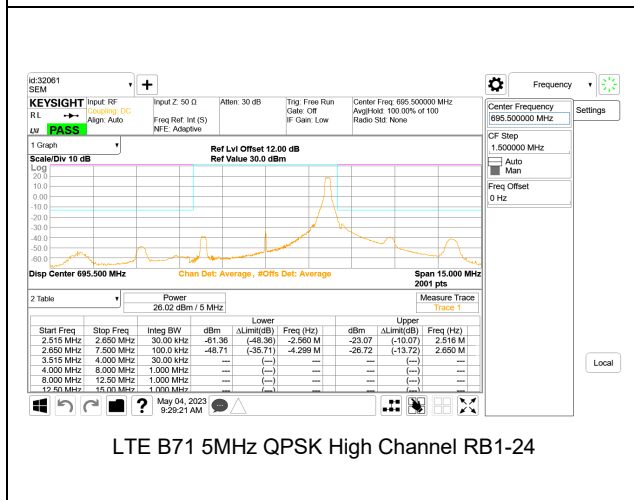

LTE B71 5MHz QPSK High Channel RB1-24

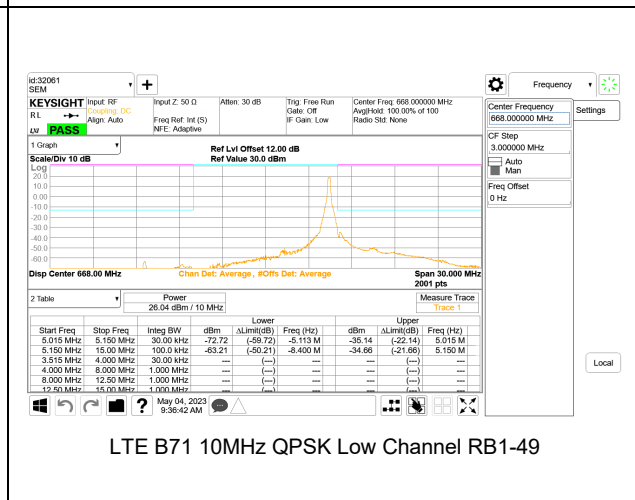

LTE B71 10MHz QPSK Low Channel RB1-49

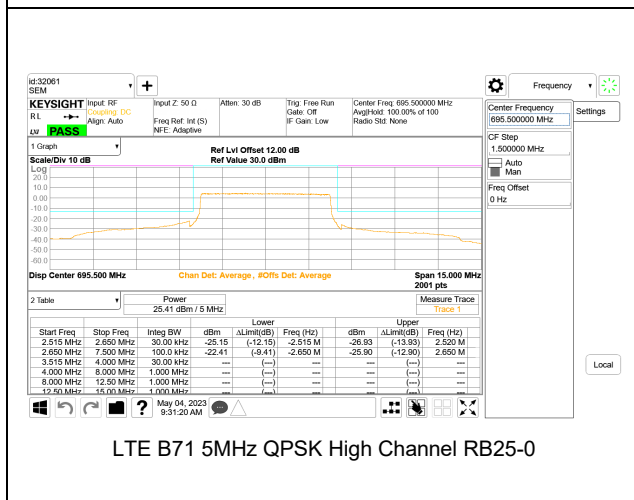

LTE B71 5MHz QPSK High Channel RB25-0

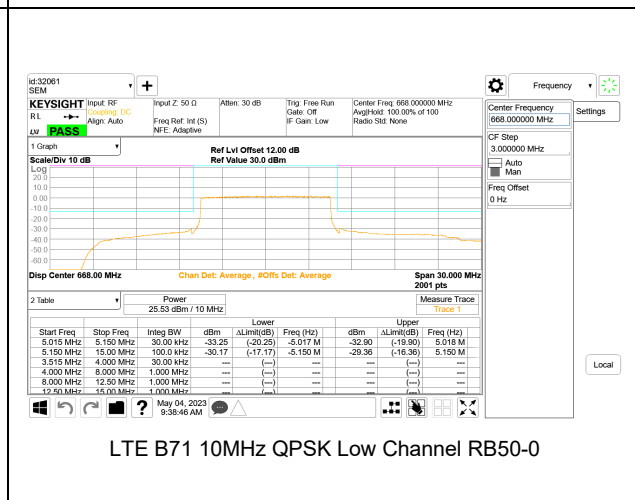

LTE B71 10MHz QPSK Low Channel RB50-0

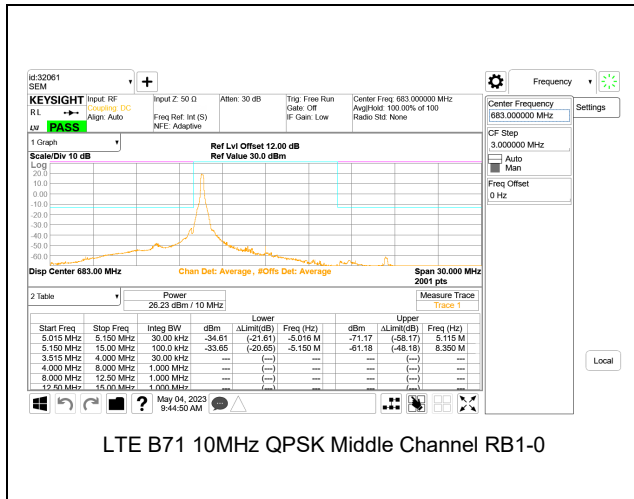

LTE B71 10MHz QPSK Middle Channel RB1-0

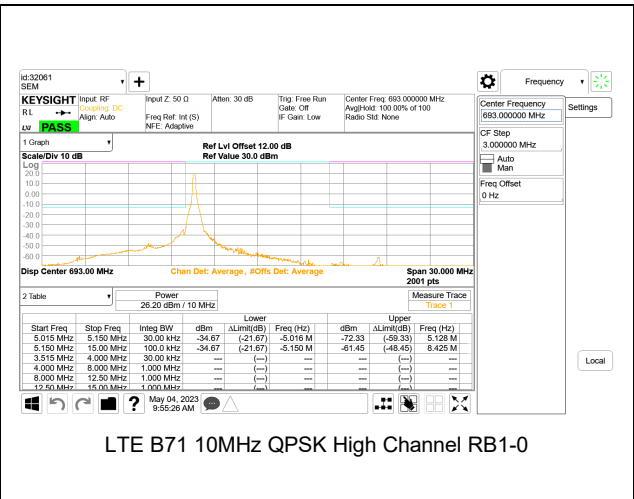

LTE B71 10MHz QPSK High Channel RB1-0

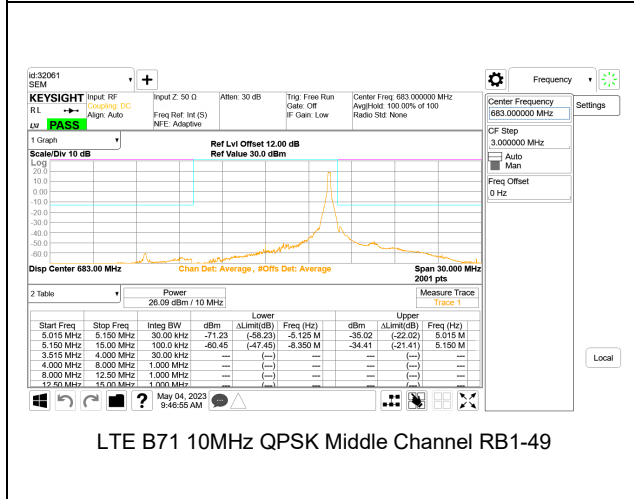

LTE B71 10MHz QPSK Middle Channel RB1-49

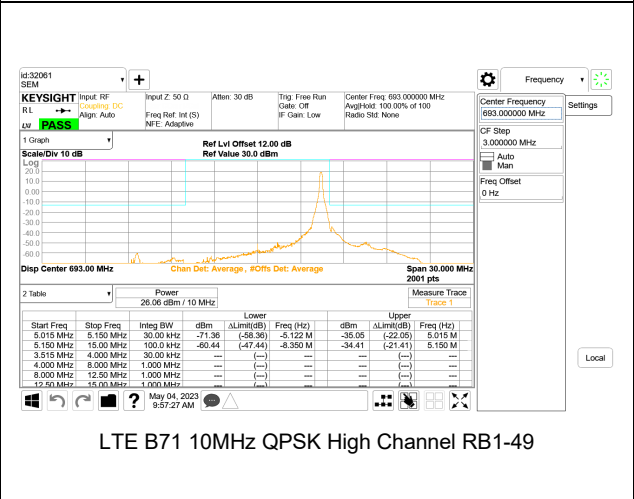

LTE B71 10MHz QPSK High Channel RB1-49

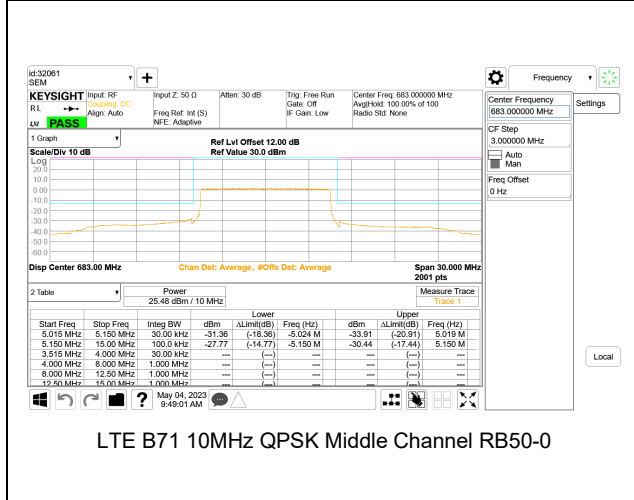

LTE B71 10MHz QPSK Middle Channel RB50-0

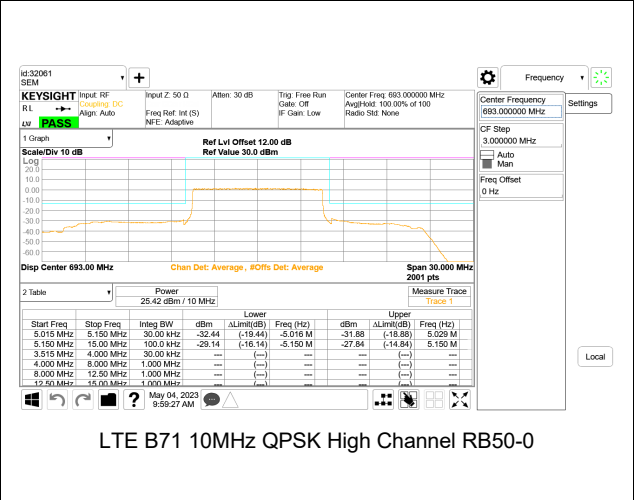

LTE B71 10MHz QPSK High Channel RB50-0