



iPhone User Guide

Everything you need to
know about iPhone



Get started

Set up a few basic features before you start using your new iPhone.

[Setup basics](#)

Add a personal touch

Your iPhone can reflect your personal style and preferences. Showcase your favorite photos on the Lock Screen, add widgets to the Home Screen, adjust text size, ringtones, and more.

[Make your iPhone your own](#)

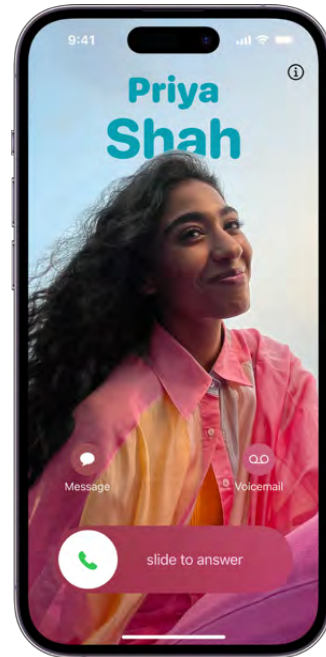

Take your best shot

Use your iPhone to capture the moment, wherever you are. Learn how to take photos and videos on the fly, and use other camera features on your iPhone.

[Take great photos and videos](#)

Stay connected

iPhone makes it easy to reach the people important to you. Add them to your contacts so you have their information everywhere you need it—then catch up with text messages, phone calls, or FaceTime.

[Keep in touch with friends and family](#)



All in the family

You and your family members can use Family Sharing to share app purchases, your location, and even health data. You can also set up parental controls to manage how children spend time on their devices.

[Share features with your family](#)

Simplify your day

Learn how to use the apps on your iPhone to direct you to the places you go most often, pay for your morning coffee, remind you of important tasks, and even lock your front door automatically when you leave home.

[Use iPhone for your daily routines](#)



Ask the experts

Check out these tips from Apple Support advisors to keep your iPhone, and the information you keep on it, safe and secure.

[Expert advice from Apple Support](#)

To explore the iPhone User Guide, click [Table of Contents](#) at the top of the page, or enter a word or phrase in the search field. You can also [download the guide](#) from Apple Books (where available).

Welcome

[Introduction to iPhone](#)

[iPhone models](#)

[What's new in iOS 17](#)

[Set up and get started](#)

[Basics](#)

[Personalize your iPhone](#)

[Work with text and graphics](#)

[Apps](#)

[Siri](#)

[iPhone safety features](#)

[Family Sharing](#)

[Screen Time](#)

[Accessories](#)

[Use iPhone with iPad, Mac, and PC](#)

[CarPlay](#)

[Accessibility](#)

[Privacy and security](#)

[Restart, update, reset, and restore](#)

[Safety, handling, and support](#)

[Copyright](#)

Introduction to iPhone

Setup basics

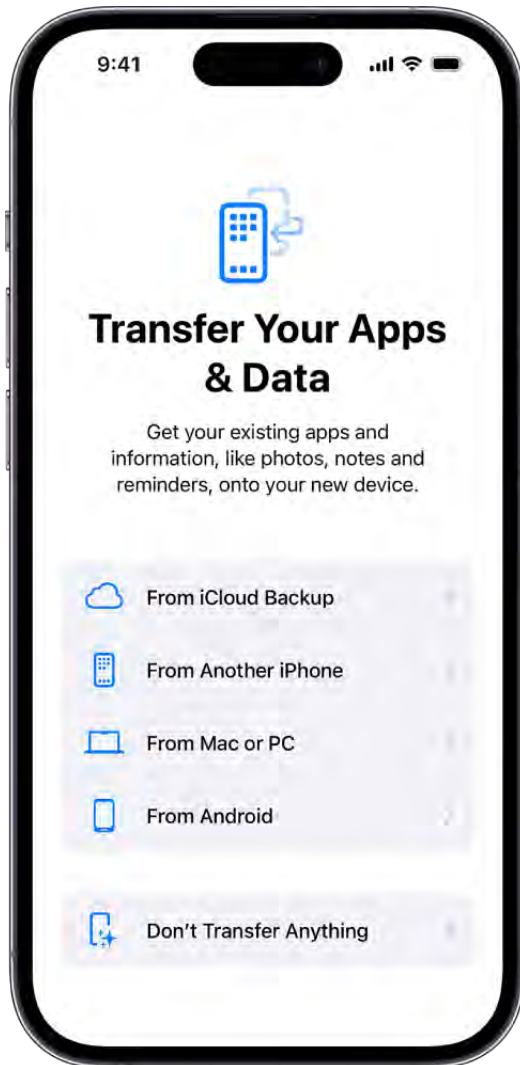

Transfer your apps and info onto your new iPhone

When you first turn on your iPhone and begin the setup process, you can wirelessly transfer many of your apps, settings, and content from your previous iPhone directly to your new iPhone—just bring the two devices close together, then follow the onscreen instructions.

If you have an Android device, tap Move Data from Android on your iPhone during the setup process, then open the Move to iOS app on your Android device.



Set up cellular service and connect to Wi-Fi

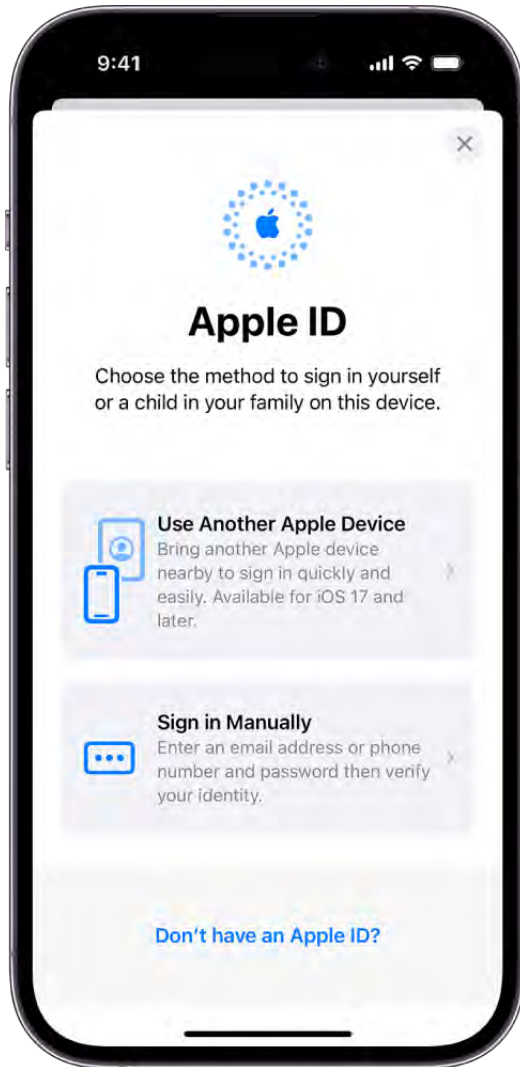

Depending on your model, use an eSIM from your carrier or install a physical SIM card to connect to your cellular network. To check if your iPhone is connected to your cellular plan, go to Settings  > Cellular.

To connect your iPhone to your home Wi-Fi network, go to Settings  > Wi-Fi, turn on Wi-Fi, then choose your network. iPhone automatically connects to your Wi-Fi network whenever you're home.



Sign in with your Apple ID

Your Apple ID is the account you use to access Apple services such as Apple Music, FaceTime, iCloud, and iMessage. If you don't have an Apple ID, you can create one.

To sign in with your Apple ID, go to Settings  > Sign in to your iPhone. To verify that you're signed in, go to Settings  > [your name]; your Apple ID appears below your name.

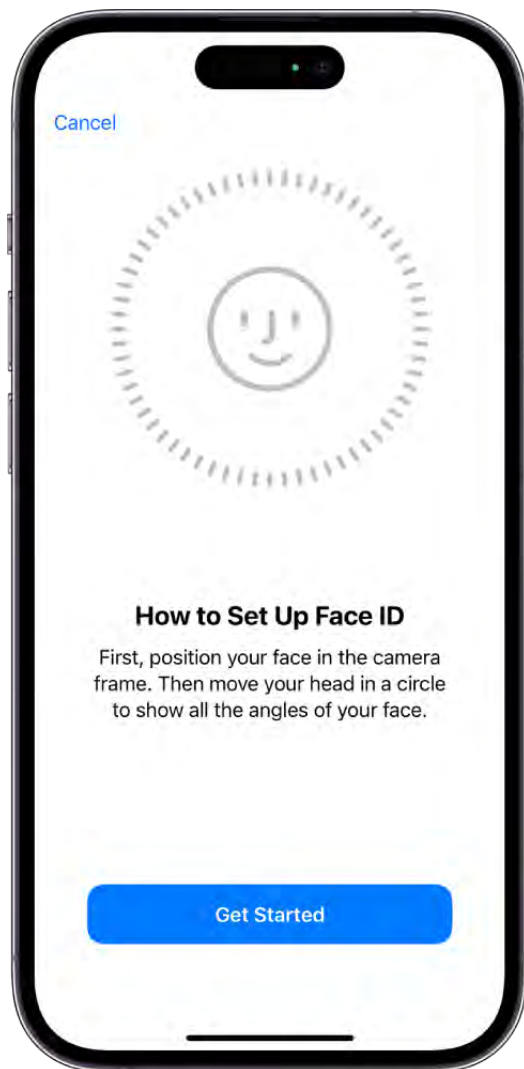

DRAFT: APPLE CONFIDENTIAL



Set up Face ID or Touch ID

You can use Face ID (face recognition) or Touch ID (your fingerprint) to securely unlock your iPhone, sign in to many apps, and make purchases. For your security, Face ID and Touch ID data doesn't leave your device and isn't saved anywhere else.

Depending on your iPhone model, do one of the following:

- *Set up Face ID:* Go to Settings  > Face ID & Passcode, tap Set up Face ID, then follow the onscreen instructions.
- *Set up Touch ID:* Go to Settings  > Touch ID & Passcode, tap Add a Fingerprint, then follow the onscreen instructions.

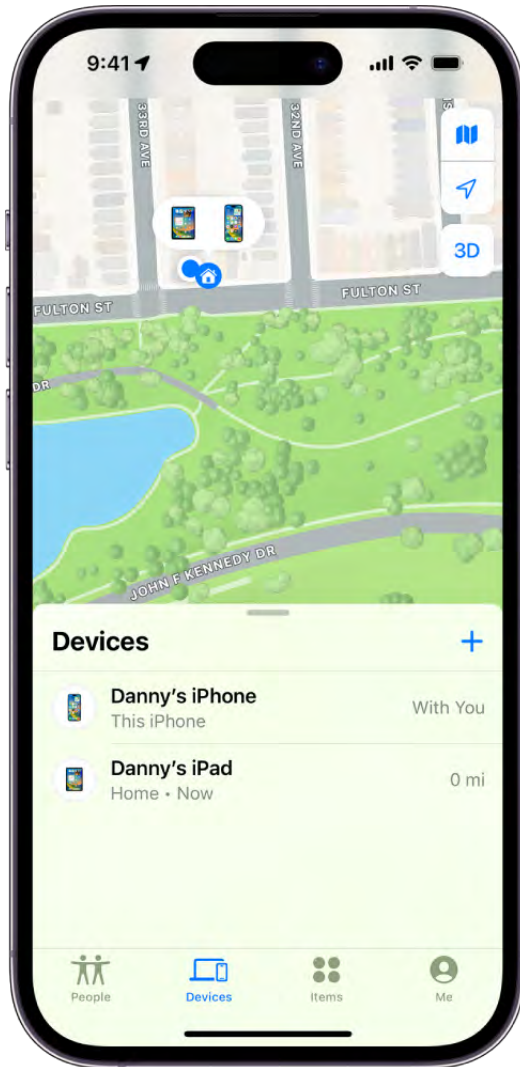

DO NOT DISTRIBUTE

DRAFT: APPLE CONFIDENTIAL



Turn on Find My iPhone

You can locate your iPhone if it's ever lost or stolen.

Go to Settings  > [your name] > Find My, tap Find My iPhone, then turn on Find My iPhone. You can see the location of your devices in the Find My app . If you lose your iPhone and don't have access to the Find My app, you can locate your device using Find iPhone on iCloud.com.

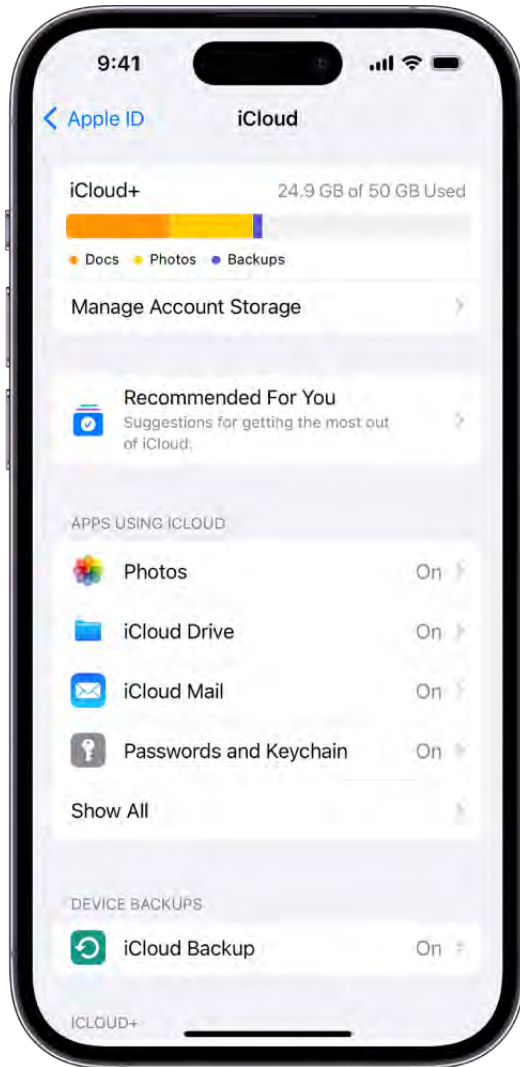

Store your data with iCloud

iCloud helps you keep your important info safe and in sync across your devices. If you replace or lose your iPhone, or it's damaged or stolen, your photos, videos, and more remain secure in iCloud.

To turn on or change the features you want to use with iCloud, go to Settings  > [your name] > iCloud.

Want to learn more?

- [Turn on and set up iPhone](#)
- [Set up cellular service](#)
- [Connect iPhone to the internet](#)
- [Set up Face ID on iPhone](#)

DRAFT: APPLE CONFIDENTIAL

- [Locate a device in Find My](#)
- [Use iCloud on iPhone](#)

Not all features are available for all iPhone models.

Make your iPhone your own

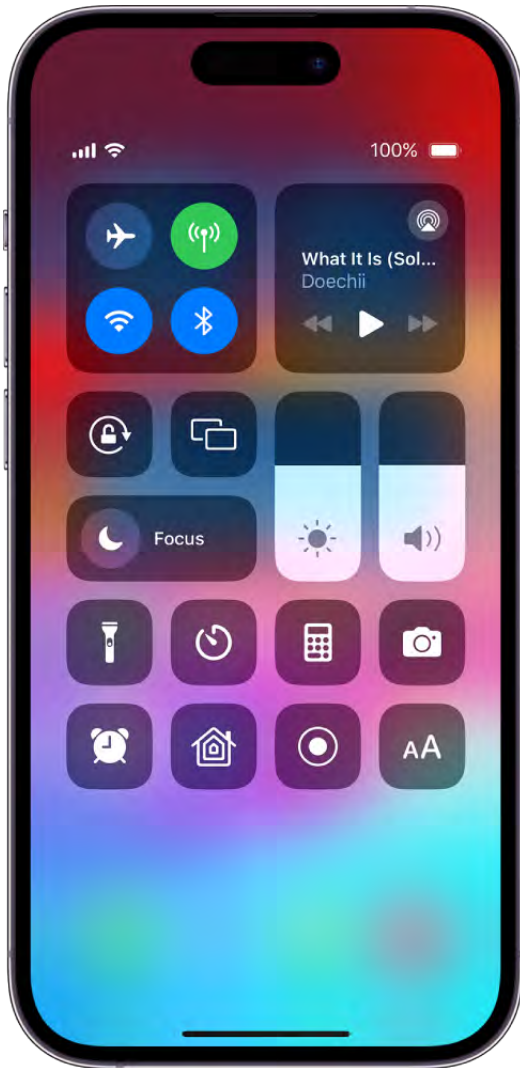

Keep your favorite features handy

Some iPhone features—like the flashlight, timer, or calculator—are just a swipe away in Control Center. To quickly open Control Center on an iPhone with Face ID, swipe down from the top-right edge; on an iPhone with a Home button, swipe up from the bottom of the screen.

You can add more features—like the alarm or magnifier—to Control Center in Settings  > Control Center.

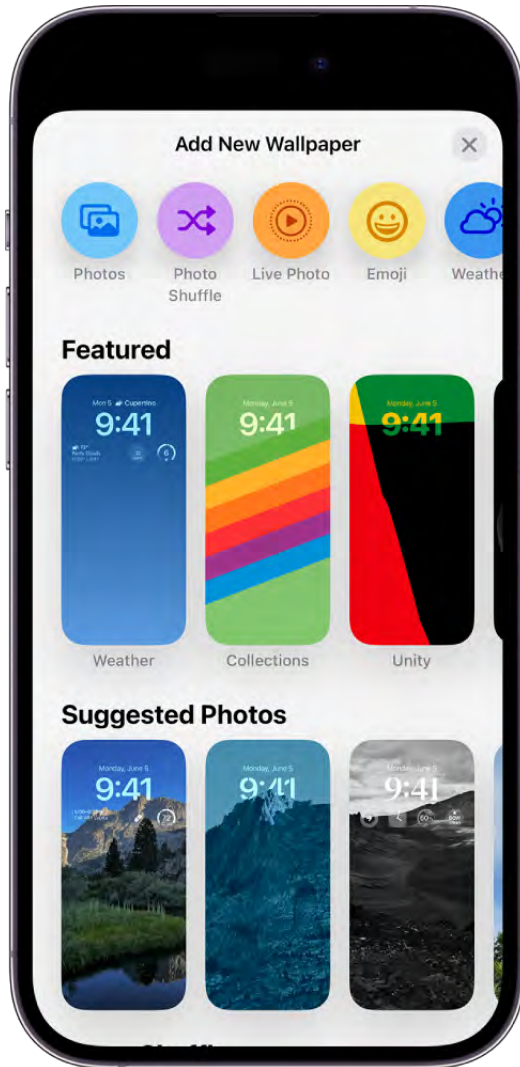

Personalize your Lock Screen

You can showcase a favorite photo, add filters, and widgets, and even change the font of the date and time.

To get started, touch and hold the Lock Screen, then tap  at the bottom of the screen. Browse the gallery of options, then tap one to customize its appearance. When you've created a Lock Screen that you like, tap Add, then tap Set as Wallpaper Pair.



Add widgets to your Home Screen

Widgets let you easily see the information that's most important to you, like the current weather and upcoming calendar events. You can also complete tasks—for example, check off an item in your Reminders to-do list, or play a song in Music.

To add a widget, touch and hold the background on any Home Screen page until the apps jiggle, then tap **+**.



Customize your phone calls

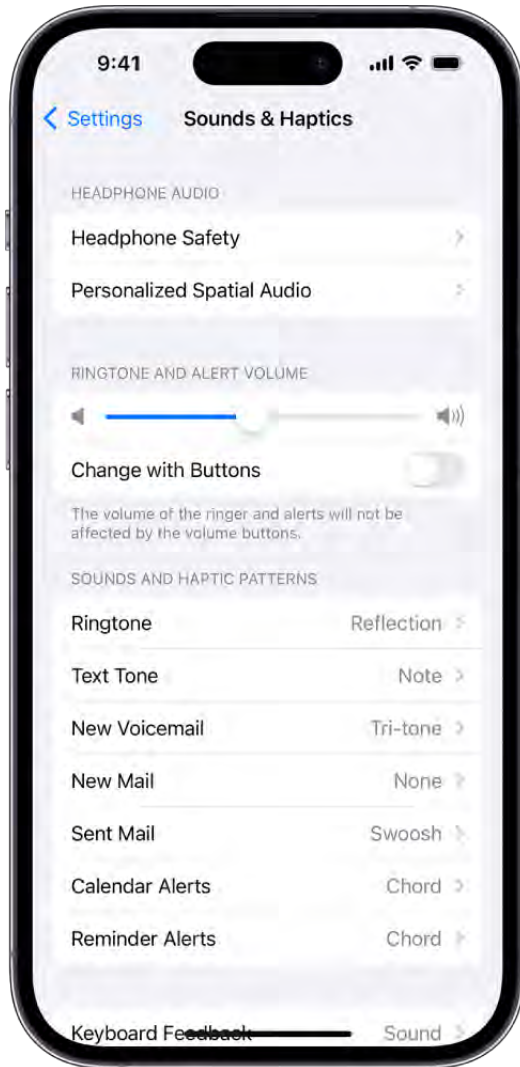

Create your own unique call poster to personalize what people see when you call them. Choose your favorite photo or emoji, pair it with your preferred font, then add colors to make it pop. When you make a phone call, your call poster appears on the screen of the person you're calling.

To get started, open the Contacts app , tap your name, then tap Contact Photo & Poster.



Choose sounds and vibrations

iPhone can play different sounds and vibrations for phone calls, text messages, calendar alerts, and other notifications.

Go to Settings  > Sounds & Haptics. You can also change the sounds iPhone plays for certain people; in the Contacts app , tap a person's name, tap Edit, then tap Ringtone or Text Tone.

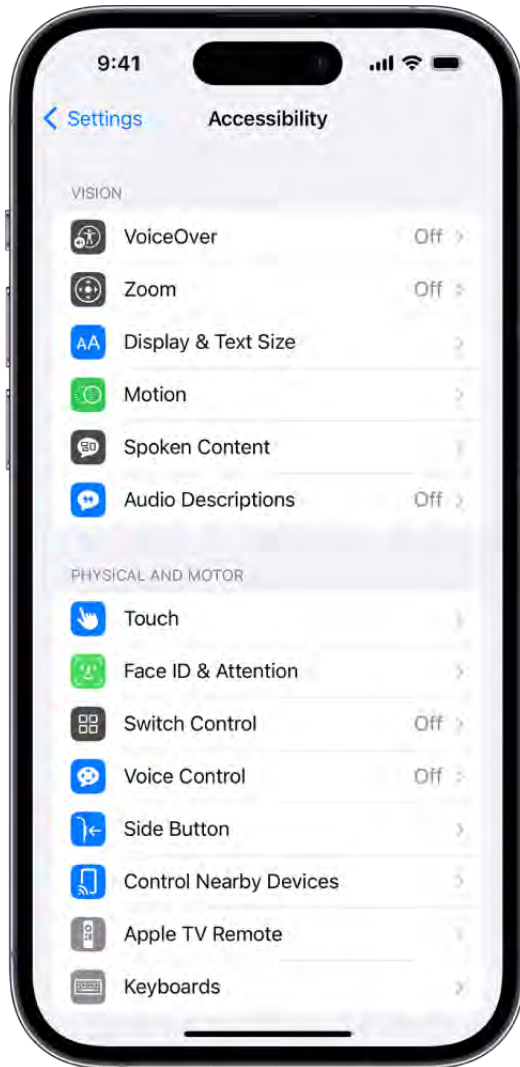

Use built-in accessibility features

iPhone provides many accessibility features to support your vision, physical and motor, hearing, and learning needs. Change text size, make it easier to use the touchscreen, control your iPhone with just your voice, and more.

To customize these settings, go to Settings  > Accessibility.



Check privacy settings

iPhone is designed to protect your privacy and information. You can grant or deny apps permission to track your activity across other companies' apps and websites. You can also use Safety Check to review and update which people and apps have access to your information. Go to Settings  > Privacy & Security, then tap Tracking or Safety Check.

Want to learn more?

- [Use and customize Control Center on iPhone](#)
- [Create a custom iPhone Lock Screen](#)
- [Add, edit, and remove widgets on iPhone](#)
- [Change iPhone sounds and vibrations](#)
- [Get started with accessibility features on iPhone](#)

DRAFT: APPLE CONFIDENTIAL

- Use the built-in privacy and security protections of iPhone

Not all features are available for all iPhone models.

Take great photos and videos



Capture the moment

To quickly open Camera, just swipe left on the Lock Screen. Camera automatically focuses the shot and adjusts the exposure. Tap the Shutter button to take a photo.

DRAFT: APPLE CONFIDENTIAL





Quickly switch to video

You can record videos without switching out of Photo mode. Just touch and hold the Shutter button and Camera begins recording a QuickTake video. Release the button to stop recording. QuickTake is available on iPhone XS, iPhone XR, and later.

DRAFT: APPLE CONFIDENTIAL





Take the perfect selfie

To take a selfie, open Camera, then tap  or  (depending on your model). Hold your iPhone in front of you, then tap the Shutter button or either volume button to take the shot.

DRAFT: APPLE CONFIDENTIAL



Shoot photos in low light

On supported models, Night mode automatically takes bright, detailed photos in low-light settings. When  turns yellow, Night mode is on. Tap the Shutter button, then hold your iPhone still to capture the shot. To experiment with Night mode, tap , then move the slider below the frame to adjust the exposure time.

DRAFT: APPLE CONFIDENTIAL



Stabilize video recordings with Action mode

Action mode helps you capture smooth hand-held videos even when you're moving around a lot—when jogging or hiking, for example. To turn on Action mode, open Camera, switch to Video mode, then tap .

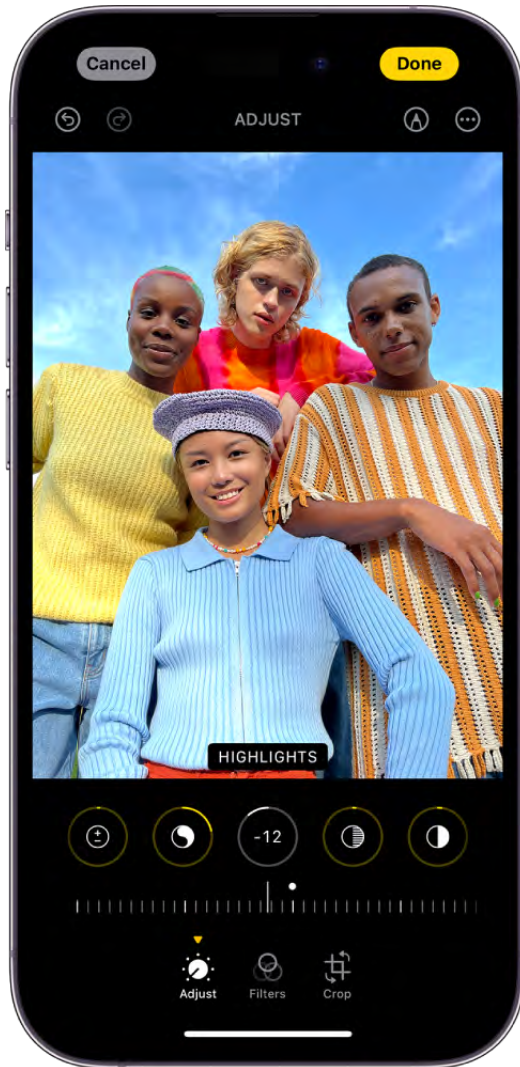

Add the final touches

After you take a photo or video, use the editing tools in the Photos app to make it even better. Open a photo or video, tap Edit, then tap the buttons at the bottom of the screen to adjust lighting, add a filter, crop, or rotate. As you make edits, tap the photo to compare your changes to the original.

Want to learn more? Check out the [Camera](#) and [Photos](#) chapters.

Not all features are available for all iPhone models.

Keep in touch with friends and family



A smarter address book

Enter phone numbers, email addresses, birthdays, and more in the Contacts app  once, and you have them everywhere you need them—from Messages to FaceTime to Mail. You can also add contact information from another account (like Google or Yahoo).

Go to Settings  > Contacts > Accounts, then tap Add Account.

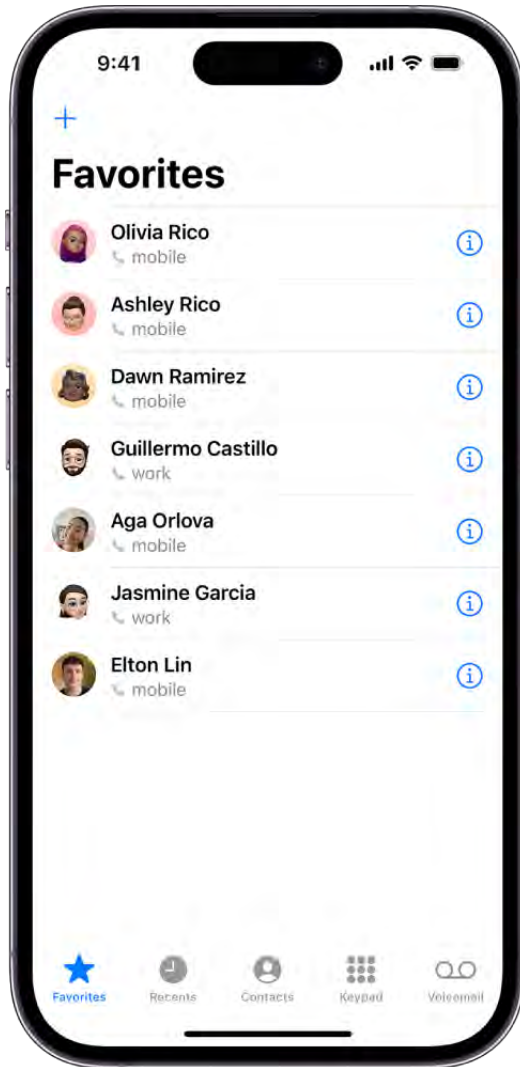

Choose your favorites

Add the people you talk to frequently to your Favorites list in the Phone app  to make them easier to reach.

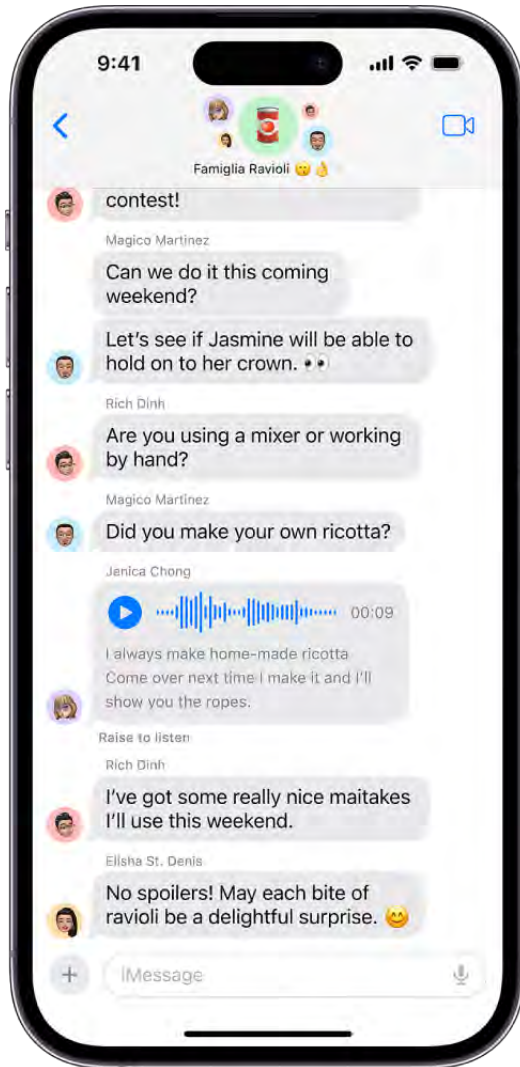

In the Phone app, tap Favorites, tap , then choose a contact. To call a Favorite, just tap their name.

DRAFT: APPLE CONFIDENTIAL



Start a group conversation

You can send messages to a group of people you want to talk to all at the same time, like members of your family.

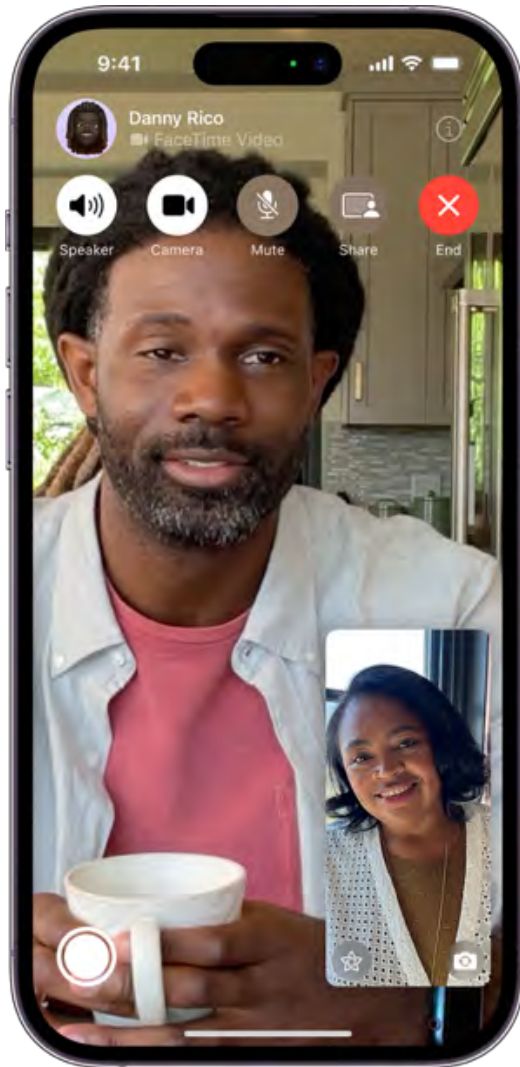

In the Messages app , tap , type the names of the people you want to send a message to, then send the first message.

DRAFT: APPLE CONFIDENTIAL



Make a video call

You can use FaceTime to make video calls with your friends and family.

In the FaceTime app , tap New FaceTime near the top of the screen, type the name of the person you want to call, then tap . During the call, you can tap the screen to show the FaceTime controls (in case you want to mute yourself, for example).



Add people to a FaceTime call

You can add more people to a FaceTime call—friends and family can join at any time. Tap the screen to show the controls, tap ⓘ, then tap Add People.

Want to learn more?

- [Add and use contact information on iPhone](#)
- [Use Contacts from the Phone app on iPhone](#)
- [Have a group conversation in Messages on iPhone](#)
- [Make FaceTime calls on iPhone](#)
- [Make a Group FaceTime call on iPhone](#)

Not all features are available in all countries or regions.

Share features with your family



Set up Family Sharing

With Family Sharing, you and your family members can share purchases, subscriptions, your location, and more. Everyone uses their own device and Apple ID, but iCloud storage, subscriptions (including to services like Apple Music and Apple Arcade), and other content is shared.

To get started, go to Settings  > [your name] > Family Sharing.



Share your location with Find My

When you set up Family Sharing, you can share your location with members of your family and help them find lost devices with the Find My app .

To share your location with family members, go to Settings  > [your name] > Family Sharing, then scroll down and tap Location. Tap the name of a family member you want to share your location with. After you share your location with members of your Family Sharing group, they can help locate a missing device.

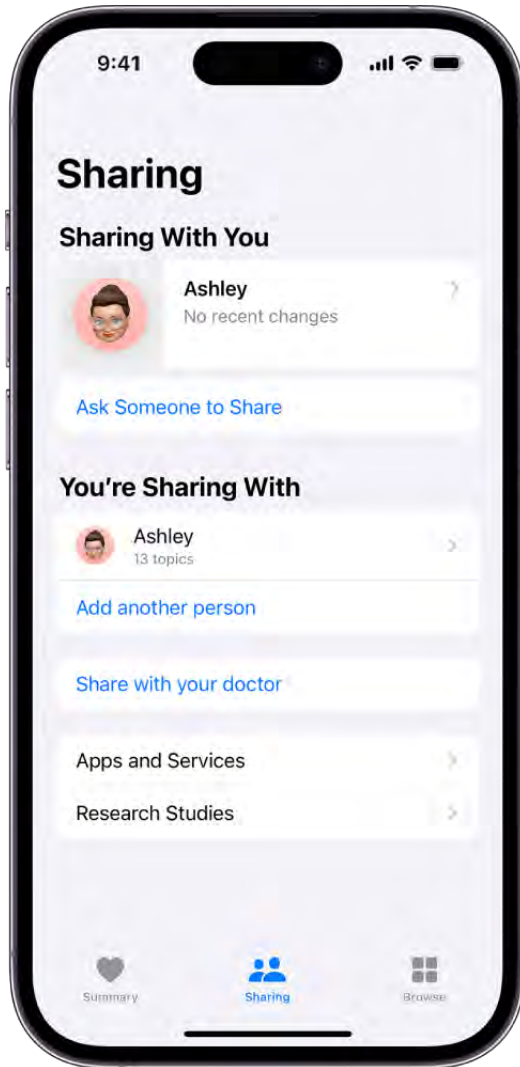

Share your health data

You can use the Health app  to share your health data—such as your activity, mobility, and health trends—with family members.

In the Health app, tap Sharing at the bottom of the screen, then tap Share with Someone. You can choose what you want to share, and if you want the people you're sharing with to be notified about significant trends, like a steep decline in activity.

DRAFT: APPLE CONFIDENTIAL



Start a family photo library

You can use iCloud Shared Photo Library to share photos and videos with up to five other family members. Everyone can add, edit, and caption photos, and enjoy the shared photos in their memories, featured photos, and Photos widget.

To get started, go to Settings  > [your name] > iCloud > Photos, turn on Sync this iPhone, then tap Shared Library.

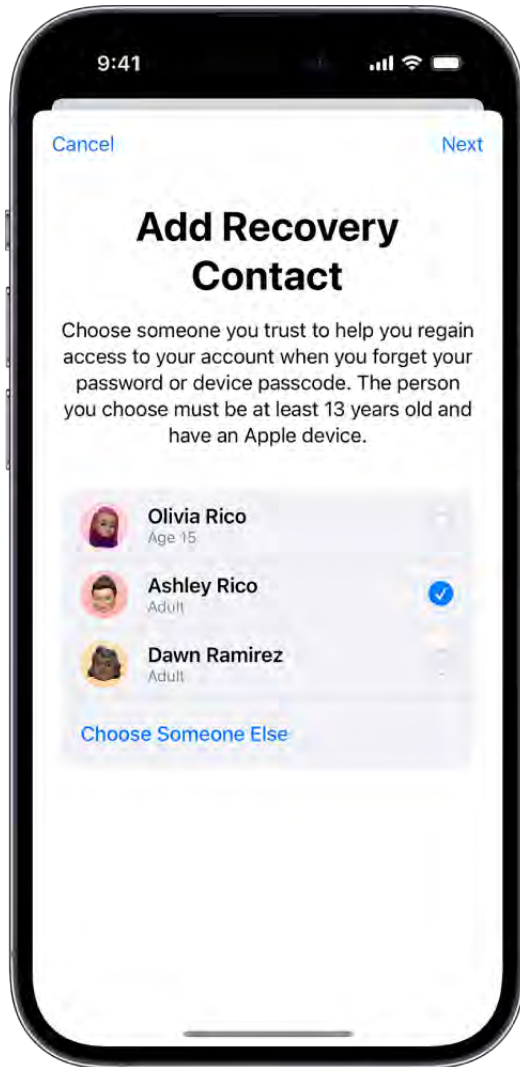

Just in case

You can add family members and other trusted people as Account Recovery Contacts to help you regain access to your account if you ever get locked out. The Digital Legacy program allows you to designate people as Legacy Contacts so they can access your account and personal information in the event of your death.

To add people, go to Settings  > [your name] > Sign-In & Security, then choose Account Recovery or Legacy Contact.

Want to learn more?

- [Set up Family Sharing on iPhone](#)
- [Share locations with family members and locate their lost devices on iPhone](#)
- [Share your data in Health on iPhone](#)

- [Set up or join an iCloud Shared Photo Library](#)
- [Keep your Apple ID secure on iPhone](#)

Not all features are available in all countries or regions.

Use iPhone for your daily routines



Start the day with the info you need

While iPhone is charging, you can put it in StandBy to view useful and timely information at a glance. With StandBy, you can use your iPhone as a bedside clock that displays the time, temperature, and other information you might want to see when you wake up in the morning, or before you go to bed.

To use StandBy, connect iPhone to a charger, stand it on its side (in landscape orientation), then tap the screen.



Get directions to your favorite places

Whether you're walking, driving, or biking, you can use the Maps app  to get directions to places you visit frequently, like your home or your favorite café, without entering the address every time.

In the Maps app, tap **+** in the row of Favorites, then add a location.

DRAFT: APPLE CONFIDENTIAL



Set up a virtual wallet



Keep your credit cards, transit passes, vaccination cards, and more in the Wallet app  on your iPhone. When you add a credit or debit card to Wallet, you can use it to make secure payments in stores and online, and send and receive money from friends and family.

To add your first card, open the Wallet app, tap , then follow the onscreen instructions.



Stay focused

Whether you're driving, working, or just need to step away from your iPhone, you can set up a Focus to temporarily silence notifications that don't match your task—and let other people know you're busy.

Go to Settings  > Focus, then choose the Focus you want to use, or tap  to create your own.



Reminders when you need them

You can use the Reminders app  to make to-do lists for projects around the house and grocery lists that sort items into categories. You can also get a reminder about something when you arrive at a certain location.

To create your first reminder, open the Reminders app, then tap New Reminder.



Forgot to turn off the lights?

With the Home app  on iPhone, you can securely control HomeKit-enabled accessories, such as lights, smart TVs, and thermostats from anywhere. You can also create automations that simplify your normal routines, like automatically turning on your entryway lights when you arrive home at night.

To add your first Works with HomeKit accessory, open the Home app, tap , then tap Add Accessory.

Want to learn more?

- [Use StandBy to transform the iPhone screen while charging](#)
- [Save favorite places in Maps on iPhone](#)
- [Keep cards and passes in Wallet on iPhone](#)

- [Set up a Focus on iPhone](#)
- [Make a grocery list in Reminders on iPhone](#)
- [Intro to Home on iPhone.](#)

Not all features are available for all iPhone models.

Expert advice from Apple Support

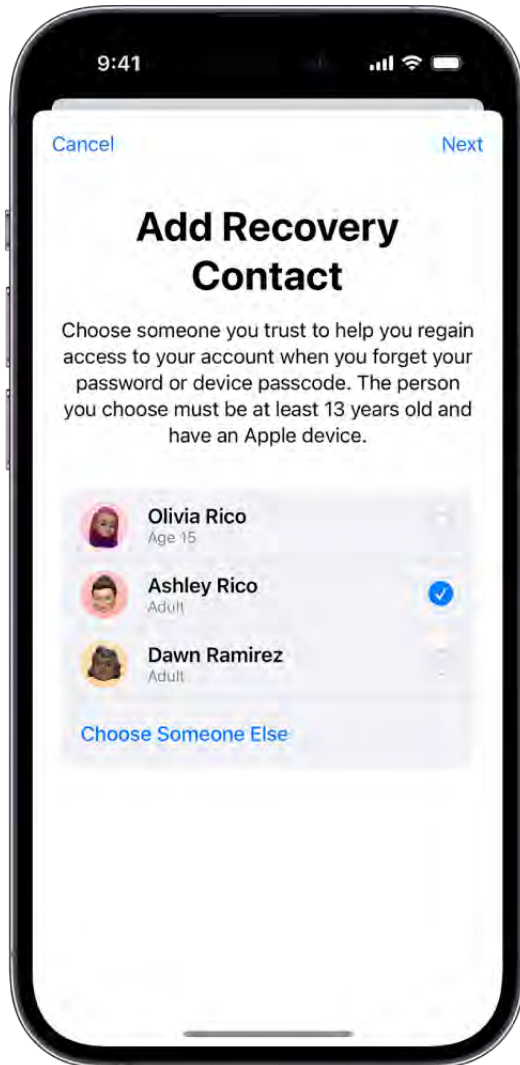

Just in case you forget

After you set up your iPhone, there are a few things you really don't want to forget—your iPhone passcode, your Apple ID, and your Apple ID password. Your iPhone passcode is the four- or six-digit numerical code that you use to unlock your iPhone. You use your

DRAFT: APPLE CONFIDENTIAL

Apple ID and password to sign in to Apple services, make purchases in the App Store, and more. Your Apple ID is typically your primary email address, and you create a unique password to use with it.

If you think you might forget these things, you can designate a trusted person as your account recovery contact. Your recovery contact doesn't have access to your iPhone or Apple account, but they can give you a code to reset your passcode or access your account if you get locked out. To set up a recovery contact, go to Settings > [your name] > Sign-In & Security > Account Recovery, tap Add Recovery Contact, then follow the onscreen instructions.

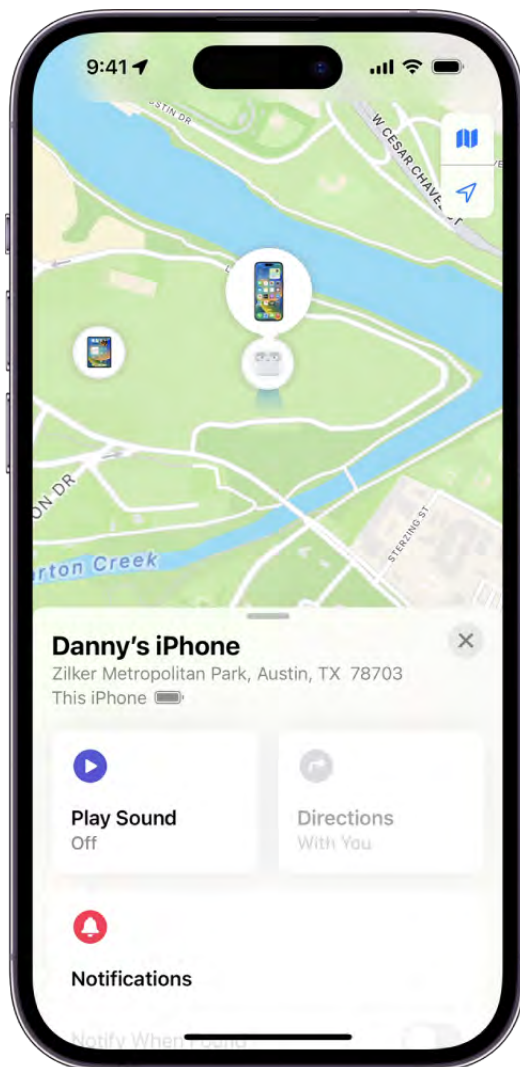

How to find your iPhone if it's lost or stolen

It's easy to find your iPhone if it ever gets lost or stolen—as long as you turn on Find My iPhone before that happens. First, make sure you're signed in to your iPhone with your Apple ID and password, then go to Settings > [your name] > Find My > Find My iPhone, and turn on Find My iPhone.

DRAFT: APPLE CONFIDENTIAL

After you turn on Find My iPhone, you can use the Find My app on another Apple device to see the location of your iPhone; you can even play a sound on your lost iPhone to help you find it. (Make sure you're signed in to the other Apple device with your Apple ID.) If you don't have another Apple device, go to www.icloud.com/find on any web browser and sign in with your Apple ID and password.

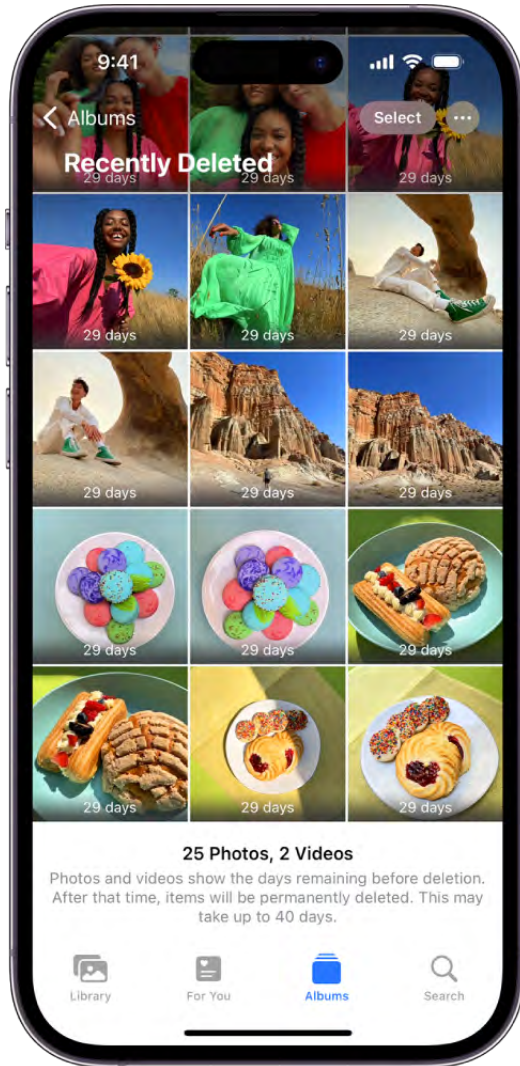

Recover deleted photos or videos

When you delete photos or videos from the Photos app, they're automatically saved in the Recently Deleted folder for 30 days. If you accidentally delete a photo or video, you can recover it and restore it to your Photos library.

To recover deleted items, open the Photos app, tap Albums, swipe up, then tap Recently Deleted (below Utilities). Unlock the folder using your iPhone passcode, Face ID, or Touch ID. Tap a photo or video, tap Recover, then tap Recover Photo or Video.



Maximize the life of your iPhone battery

There are a few easy steps you can take to preserve the life of your iPhone battery. First, make sure your iPhone is updated to the latest version of iOS. To check if a software update is available, go to Settings > General > Software Update.

Next, always connect to Wi-Fi when it's available; a Wi-Fi connection uses less battery power than a cellular connection.

Last, turn down your screen brightness: Open Control Center and drag . To automatically dim your screen based on the surrounding light, go to Settings > Accessibility > Display & Text Size, then turn on Auto-Brightness.

| To learn more about your iPhone battery health go to Settings > Battery.

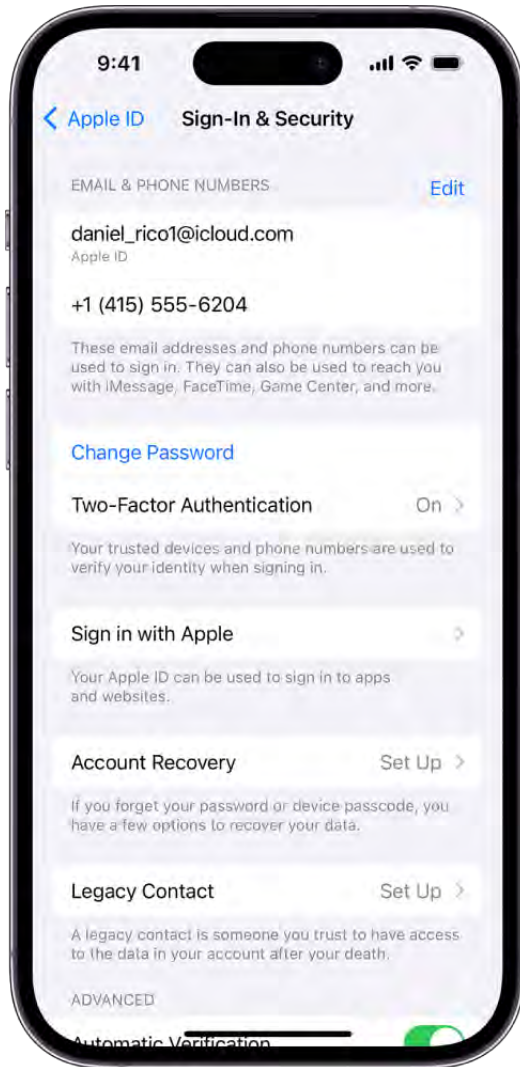

If you get a new phone number

The phone number associated with your Apple ID is often used to verify your identity and authenticate that your iPhone is really yours—it's known as your trusted phone number. If you get a new phone number, make sure you update your trusted phone number so you don't lose access to your account if you forget your Apple ID, or move to a new iPhone.

To update your trusted phone number, go to Settings > [your name] > Sign-In & Security, then tap Edit next to Email & Phone Numbers. Tap Add Email or Phone Number, then tap Add a Phone Number. Enter your new phone number and follow the onscreen instructions to verify your new number.



All about eSIM

An eSIM is a digital version of the physical SIM card inside your iPhone that connects to your cellular carrier. With eSIM, you don't have to swap out your SIM card when you get a new iPhone, and you can easily connect to new cellular carriers at home or while traveling. If you purchased an iPhone 14 model or later in the United States, your iPhone automatically connects to your cellular carrier using eSIM.

If you erase your iPhone, or restore it from a backup and accidentally delete your eSIM, your iPhone may lose its cellular connection; to restore it, you'll need to contact your cellular provider.

Want to learn more?

- [Keep your Apple ID secure on iPhone](#)
- [Locate a device in Find My on iPhone](#)

DRAFT: APPLE CONFIDENTIAL

- Delete or hide photos and videos on iPhone
- Check the iPhone battery health and usage
- Set up an eSIM

Not all features are available for all iPhone models.

iPhone models

iPhone models compatible with iOS 17

This guide helps you get started using iPhone and discover all the amazing things it can do with iOS 17, which is compatible with the following models:

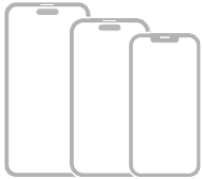

[iPhone XR](#)

[iPhone Xs](#)

[iPhone Xs Max](#)

[iPhone 11](#)

[iPhone 11 Pro](#)

[iPhone 11 Pro Max](#)

[iPhone 12 mini](#)

[iPhone 12](#)

[iPhone 12 Pro](#)

[iPhone 12 Pro Max](#)

[iPhone 13 mini](#)

[iPhone 13](#)

[iPhone 13 Pro](#)

[iPhone 13 Pro Max](#)

[iPhone 14](#)

[iPhone 14 Plus](#)

[iPhone 14 Pro](#)

[iPhone 14 Pro Max](#)

[iPhone X](#)

[iPhone XX](#)

[iPhone Y](#)

[iPhone YY](#)



[iPhone SE \(2nd generation\)](#)

[iPhone SE \(3rd generation\)](#)

DRAFT: APPLE CONFIDENTIAL

Your features and apps may vary depending on your iPhone model, region, language, and carrier. To find out which features are supported in your region, see the [iOS and iPadOS Feature Availability website](#).

Note: Apps and services that send or receive data over a cellular network, or that answer incoming calls, may incur additional fees. Contact your carrier for information about your service plan and fees.

Identify your iPhone model and iOS version

Go to Settings  > General > About. See [Get information about your iPhone](#).

To determine your iPhone model from the physical details, see the Apple Support article [Identify your iPhone model](#).

Get iOS updates

To update your iPhone to the latest iOS software compatible with your model, go to Settings  > General > Software Update. See [Update iOS on iPhone](#).

iPhone XR

Learn the location of the cameras, buttons, and other essential hardware features on iPhone XR.

DRAFT: APPLE CONFIDENTIAL

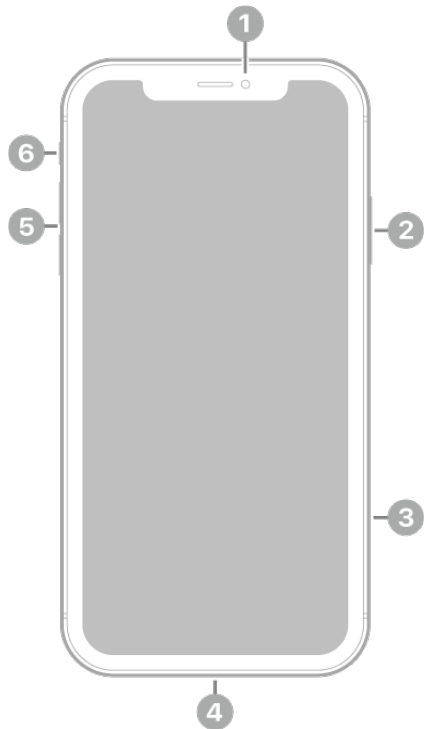

- 1 Front camera
- 2 Side button
- 3 SIM tray
- 4 Lightning connector
- 5 Volume buttons
- 6 Ring/Silent switch

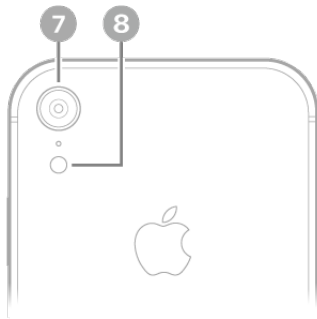

- 7 Rear camera
- 8 Flash

Get started with iPhone XR

- [Turn on and set up iPhone](#)
- [Learn gestures for iPhone models with Face ID](#)
- [iPhone camera basics](#)
- [Qi-certified wireless chargers for iPhone](#)
- [What's new in iOS 17](#)

iPhone Xs

Learn the location of the cameras, buttons, and other essential hardware features on iPhone Xs.

DRAFT: APPLE CONFIDENTIAL

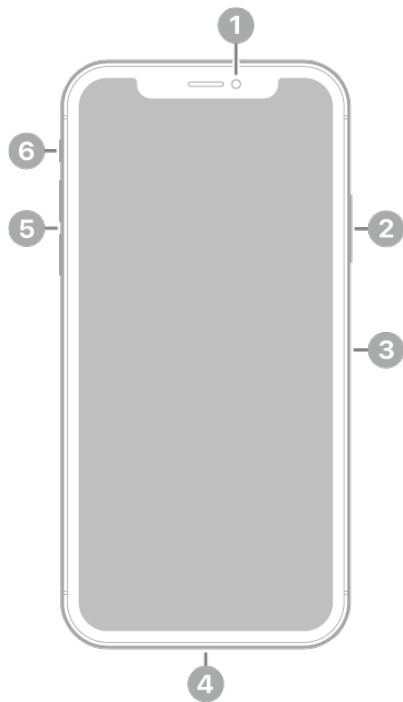

- 1 Front camera
- 2 Side button
- 3 SIM tray
- 4 Lightning connector
- 5 Volume buttons
- 6 Ring/Silent switch

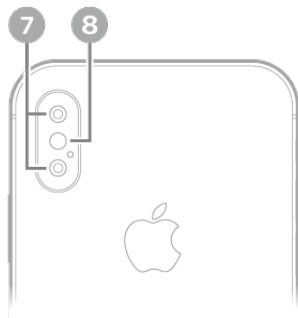

- 7 Rear cameras
- 8 Flash

Get started with iPhone Xs

- [Turn on and set up iPhone](#)
- [Learn gestures for iPhone models with Face ID](#)
- [iPhone camera basics](#)
- [Qi-certified wireless chargers for iPhone](#)
- [What's new in iOS 17](#)

iPhone Xs Max

Learn the location of the cameras, buttons, and other essential hardware features on iPhone Xs Max.

DRAFT: APPLE CONFIDENTIAL

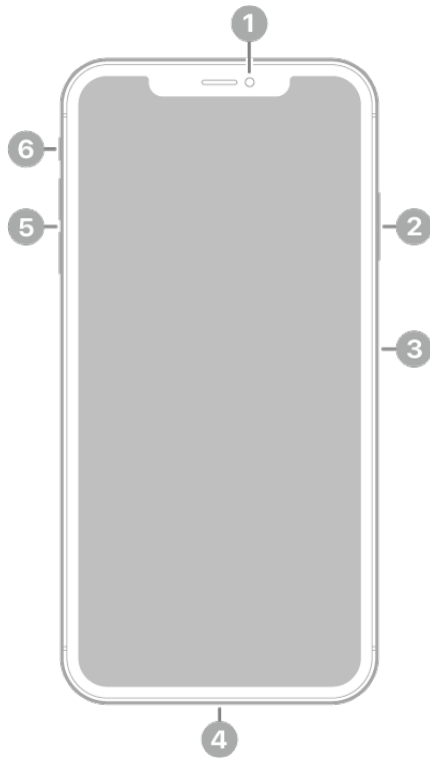

- ① Front camera
- ② Side button
- ③ SIM tray
- ④ Lightning connector
- ⑤ Volume buttons
- ⑥ Ring/Silent switch

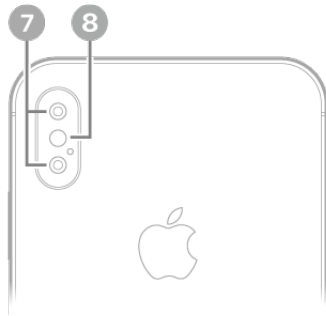

- ⑦ Rear cameras
- ⑧ Flash

Get started with iPhone Xs Max

- [Turn on and set up iPhone](#)
- [Learn gestures for iPhone models with Face ID](#)
- [iPhone camera basics](#)
- [Qi-certified wireless chargers for iPhone](#)
- [What's new in iOS 17](#)

iPhone 11

Learn the location of the cameras, buttons, and other essential hardware features on iPhone 11.

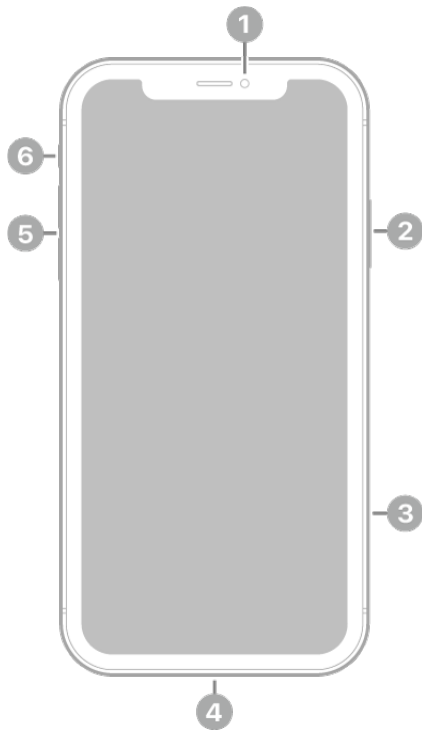

- 1 Front camera
- 2 Side button
- 3 SIM tray
- 4 Lightning connector
- 5 Volume buttons
- 6 Ring/Silent switch

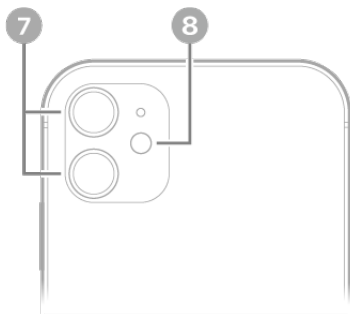

- 7 Rear cameras
- 8 Flash

Get started with iPhone 11

- [Turn on and set up iPhone](#)
- [Learn gestures for iPhone models with Face ID](#)
- [iPhone camera basics](#)
- [Qi-certified wireless chargers for iPhone](#)
- [What's new in iOS 17](#)

iPhone 11 Pro

Learn the location of the cameras, buttons, and other essential hardware features on iPhone 11 Pro.

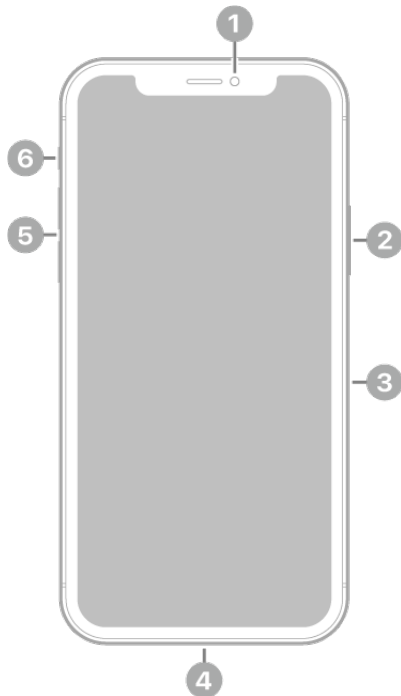

- 1 Front camera
- 2 Side button
- 3 SIM tray
- 4 Lightning connector
- 5 Volume buttons
- 6 Ring/Silent switch

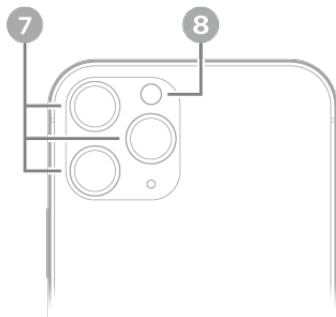

- 7 Rear cameras
- 8 Flash

Get started with iPhone 11 Pro

- [Turn on and set up iPhone](#)
- [Learn gestures for iPhone models with Face ID](#)
- [iPhone camera basics](#)
- [Qi-certified wireless chargers for iPhone](#)
- [What's new in iOS 17](#)

iPhone 11 Pro Max

Learn the location of the cameras, buttons, and other essential hardware features on iPhone 11 Pro Max.

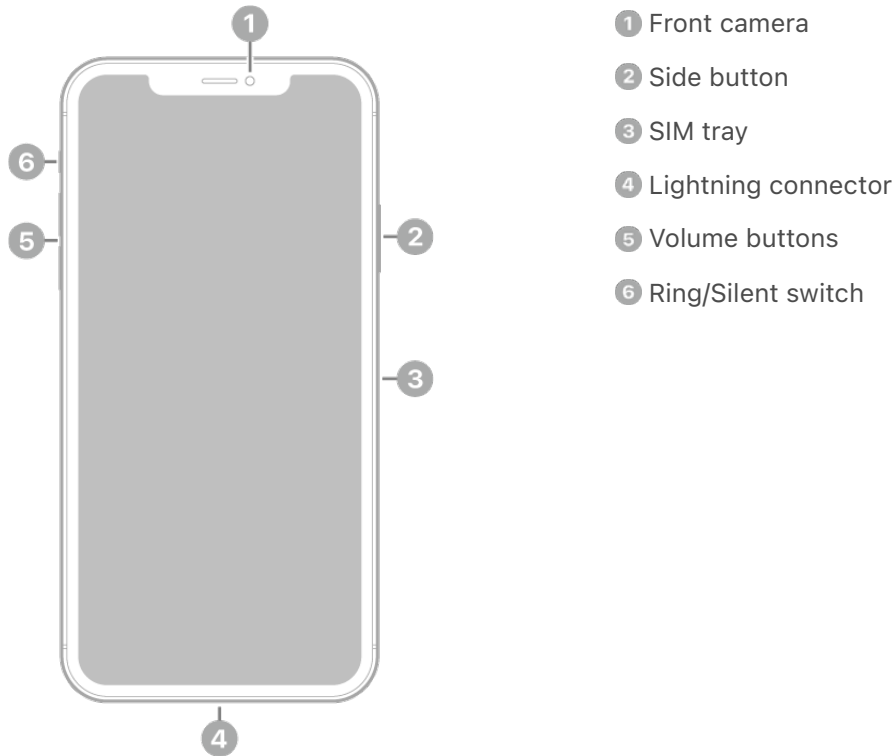

- 1 Front camera
- 2 Side button
- 3 SIM tray
- 4 Lightning connector
- 5 Volume buttons
- 6 Ring/Silent switch

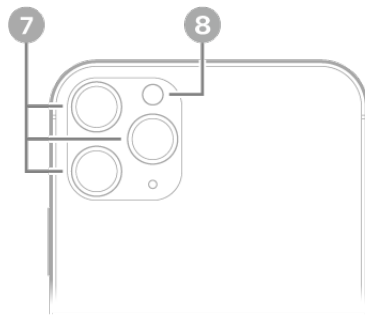

- 7 Rear cameras
- 8 Flash

Get started with iPhone 11 Pro Max

- [Turn on and set up iPhone](#)
- [Learn gestures for iPhone models with Face ID](#)
- [iPhone camera basics](#)
- [Qi-certified wireless chargers for iPhone](#)
- [What's new in iOS 17](#)

iPhone SE (2nd generation)

Learn the location of the cameras, buttons, and other essential hardware features on iPhone SE (2nd generation).

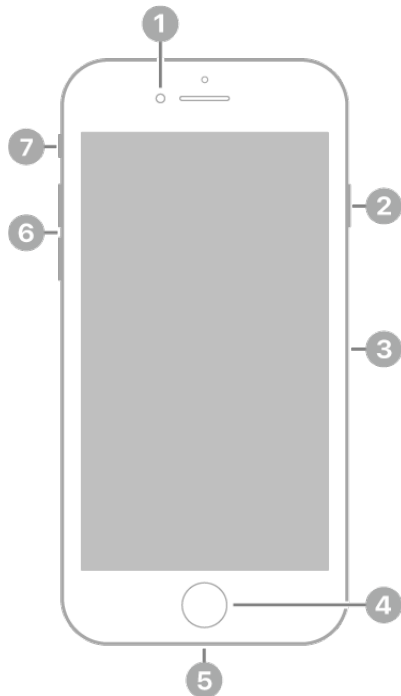

- 1 Front camera
- 2 Side button
- 3 SIM tray
- 4 Home button/Touch ID
- 5 Lightning connector
- 6 Volume buttons
- 7 Ring/Silent switch



- 8 Rear camera
- 9 Flash

Get started with iPhone SE

- [Turn on and set up iPhone](#)
- [Learn basic gestures to interact with iPhone](#)
- [iPhone camera basics](#)
- [Qi-certified wireless chargers for iPhone](#)
- [What's new in iOS 17](#)

iPhone 12 mini

Learn the location of the cameras, buttons, and other essential hardware features on iPhone 12 mini.

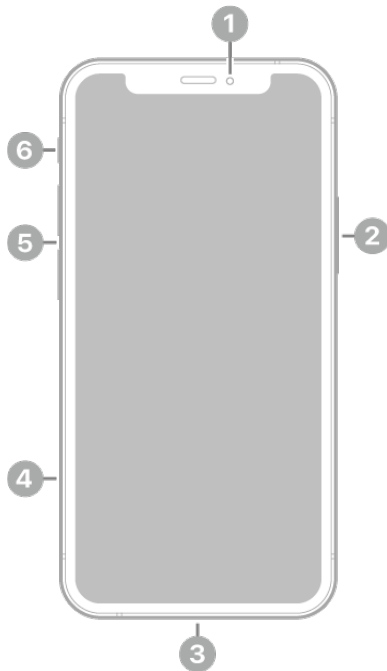

- 1 Front camera
- 2 Side button
- 3 Lightning connector
- 4 SIM tray
- 5 Volume buttons
- 6 Ring/Silent switch

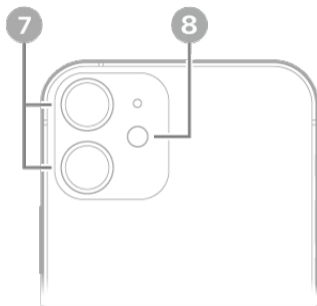

- 7 Rear cameras
- 8 Flash

Get started with iPhone 12 mini

- [Turn on and set up iPhone](#)
- [Learn gestures for iPhone models with Face ID](#)
- [iPhone camera basics](#)
- [MagSafe chargers and battery packs for iPhone](#)
- [What's new in iOS 17](#)

iPhone 12

Learn the location of the cameras, buttons, and other essential hardware features on iPhone 12.

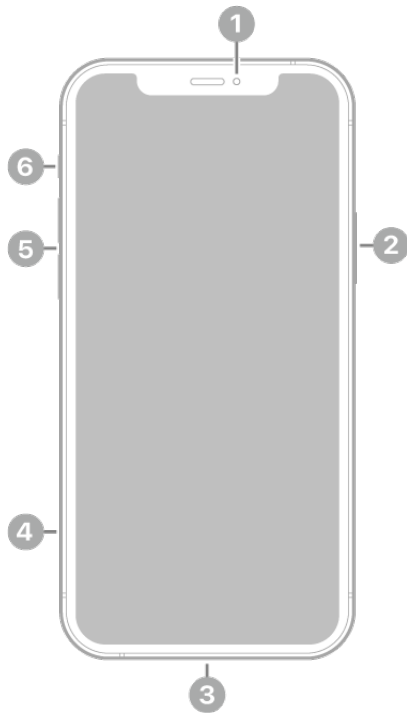

- ① Front camera
- ② Side button
- ③ Lightning connector
- ④ SIM tray
- ⑤ Volume buttons
- ⑥ Ring/Silent switch

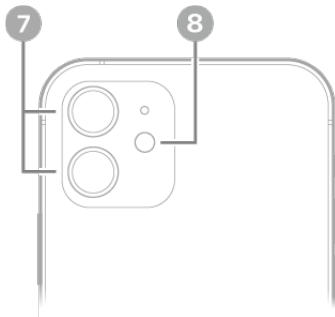

- ⑦ Rear cameras
- ⑧ Flash

Get started with iPhone 12

- [Turn on and set up iPhone](#)
- [Learn gestures for iPhone models with Face ID](#)
- [iPhone camera basics](#)
- [MagSafe chargers and battery packs for iPhone](#)
- [What's new in iOS 17](#)

iPhone 12 Pro

Learn the location of the cameras, buttons, and other essential hardware features on iPhone 12 Pro.

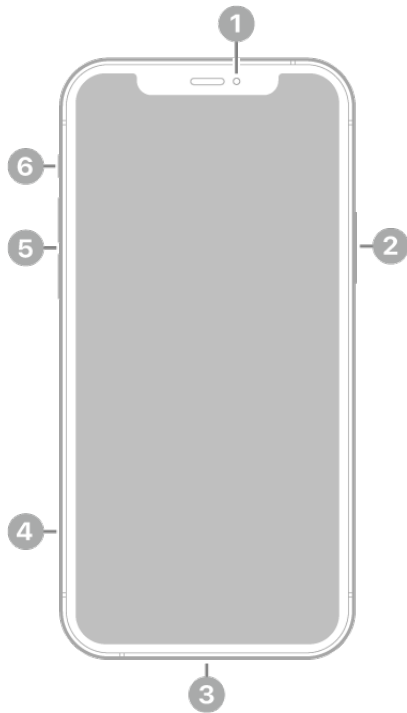

- ① Front camera
- ② Side button
- ③ Lightning connector
- ④ SIM tray
- ⑤ Volume buttons
- ⑥ Ring/Silent switch

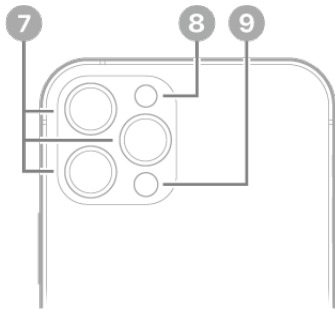

- ⑦ Rear cameras
- ⑧ Flash
- ⑨ LiDAR Scanner

Get started with iPhone 12 Pro

- [Turn on and set up iPhone](#)
- [Learn gestures for iPhone models with Face ID](#)
- [iPhone camera basics](#)
- [MagSafe chargers and battery packs for iPhone](#)
- [What's new in iOS 17](#)

iPhone 12 Pro Max

Learn the location of the cameras, buttons, and other essential hardware features on iPhone 12 Pro Max.

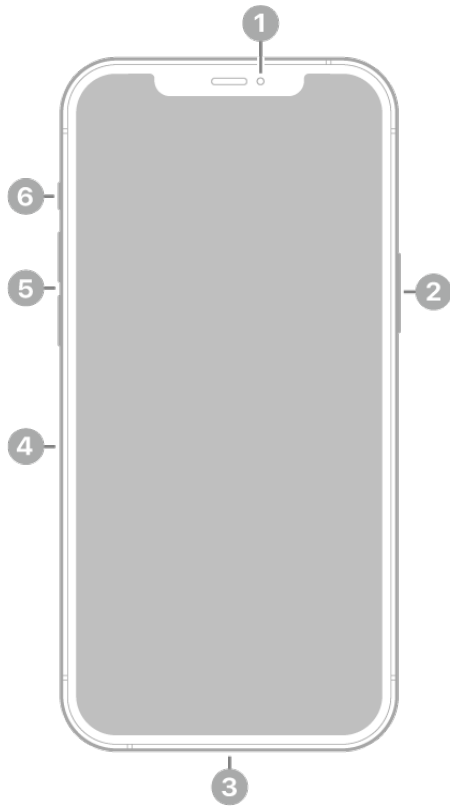

- 1 Front camera
- 2 Side button
- 3 Lightning connector
- 4 SIM tray
- 5 Volume buttons
- 6 Ring/Silent switch

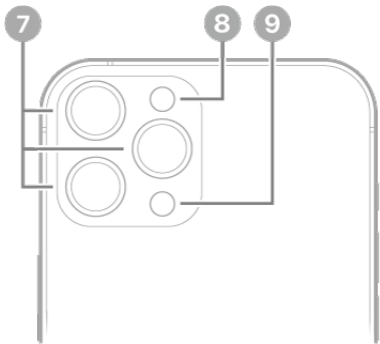

- 7 Rear cameras
- 8 Flash
- 9 LiDAR Scanner

Get started with iPhone 12 Pro Max

- [Turn on and set up iPhone](#)
- [Learn gestures for iPhone models with Face ID](#)
- [iPhone camera basics](#)
- [MagSafe chargers and battery packs for iPhone](#)
- [What's new in iOS 17](#)

iPhone 13 mini

Learn the location of the cameras, buttons, and other essential hardware features on iPhone 13 mini.

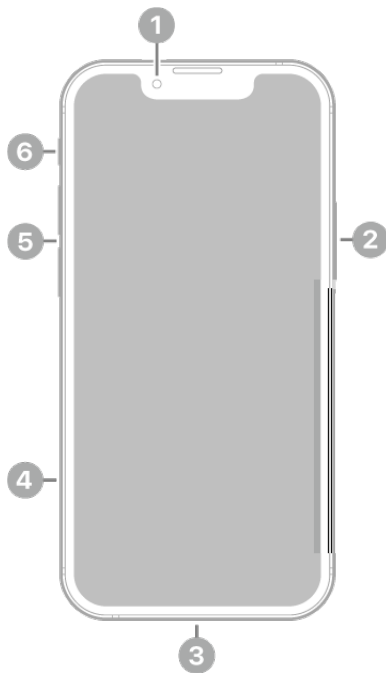

- ① Front camera
- ② Side button
- ③ Lightning connector
- ④ SIM tray
- ⑤ Volume buttons
- ⑥ Ring/Silent switch

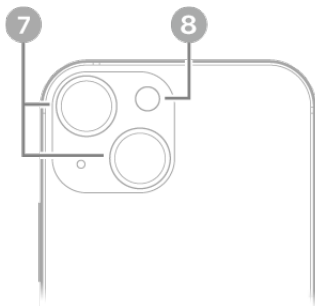

- ⑦ Rear cameras
- ⑧ Flash

Get started with iPhone 13 mini

- [Turn on and set up iPhone](#)
- [Learn gestures for iPhone models with Face ID](#)
- [iPhone camera basics](#)
- [MagSafe chargers and battery packs for iPhone](#)
- [What's new in iOS 17](#)

iPhone 13

Learn the location of the cameras, buttons, and other essential hardware features on iPhone 13.

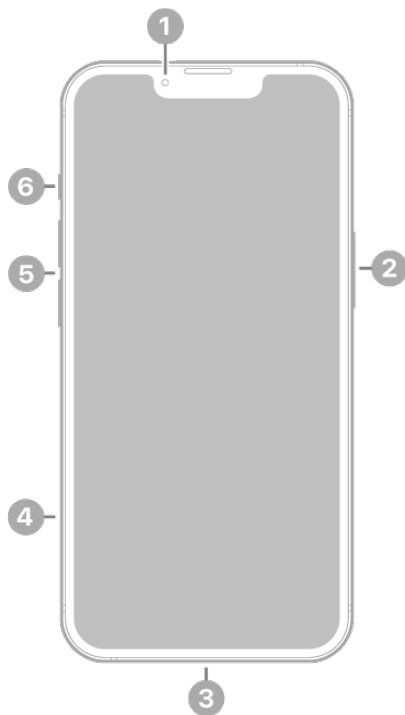

- ① Front camera
- ② Side button
- ③ Lightning connector
- ④ SIM tray
- ⑤ Volume buttons
- ⑥ Ring/Silent switch

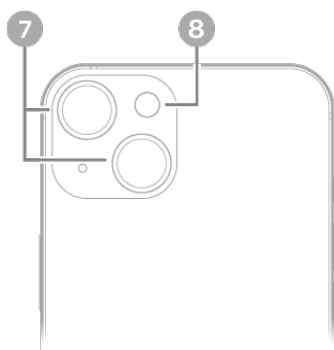

- ⑦ Rear cameras
- ⑧ Flash

Get started with iPhone 13

- [Turn on and set up iPhone](#)
- [Learn gestures for iPhone models with Face ID](#)
- [iPhone camera basics](#)
- [MagSafe chargers and battery packs for iPhone](#)
- [What's new in iOS 17](#)

iPhone 13 Pro

Learn the location of the cameras, buttons, and other essential hardware features on iPhone 13 Pro.

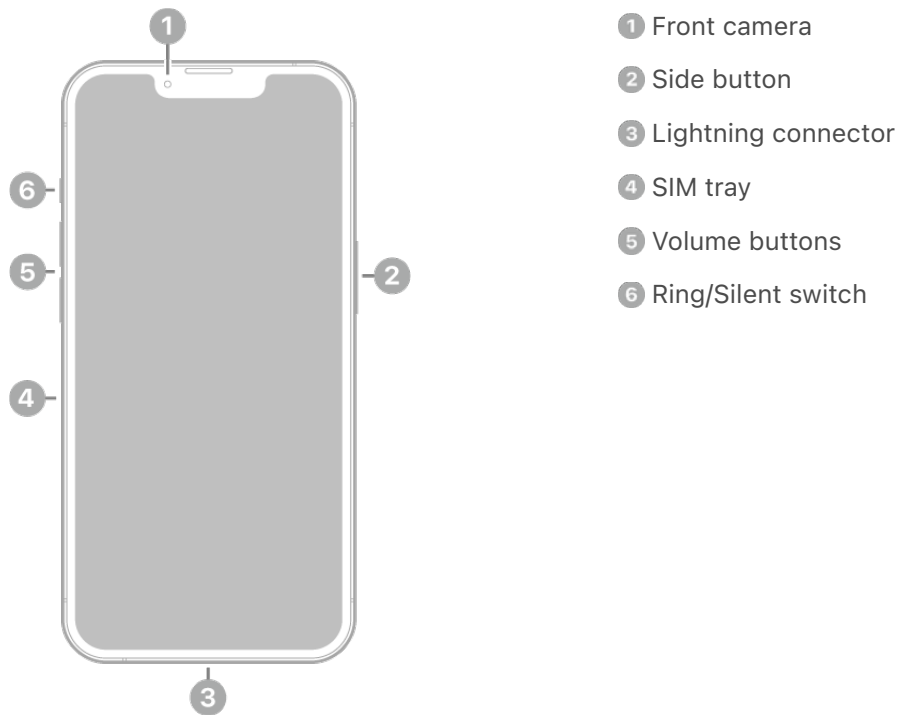

- ① Front camera
- ② Side button
- ③ Lightning connector
- ④ SIM tray
- ⑤ Volume buttons
- ⑥ Ring/Silent switch

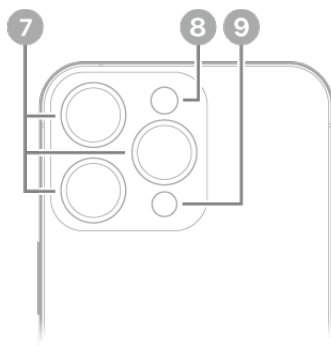

- ⑦ Rear cameras
- ⑧ Flash
- ⑨ LiDAR Scanner

Get started with iPhone 13 Pro

- [Turn on and set up iPhone](#)
- [Learn gestures for iPhone models with Face ID](#)
- [iPhone camera basics](#)
- [MagSafe chargers and battery packs for iPhone](#)
- [What's new in iOS 17](#)

iPhone 13 Pro Max

Learn the location of the cameras, buttons, and other essential hardware features on iPhone 13 Pro Max.

DRAFT: APPLE CONFIDENTIAL

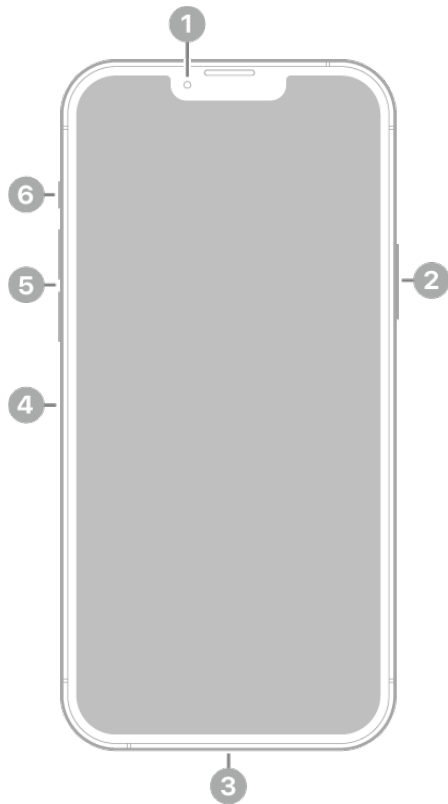

- ① Front camera
- ② Side button
- ③ Lightning connector
- ④ SIM tray
- ⑤ Volume buttons
- ⑥ Ring/Silent switch

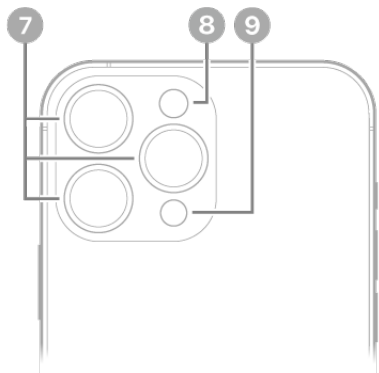

- ⑦ Rear cameras
- ⑧ Flash
- ⑨ LiDAR Scanner

Get started with iPhone 13 Pro Max

- [Turn on and set up iPhone](#)
- [Learn gestures for iPhone models with Face ID](#)
- [iPhone camera basics](#)
- [MagSafe chargers and battery packs for iPhone](#)
- [What's new in iOS 17](#)

iPhone SE (3rd generation)

Learn the location of the cameras, buttons, and other essential hardware features on iPhone SE (3rd generation).

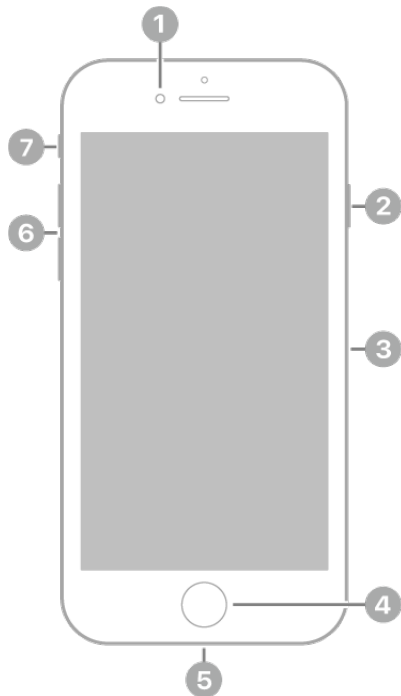

- 1 Front camera
- 2 Side button
- 3 SIM tray
- 4 Home button/Touch ID
- 5 Lightning connector
- 6 Volume buttons
- 7 Ring/Silent switch

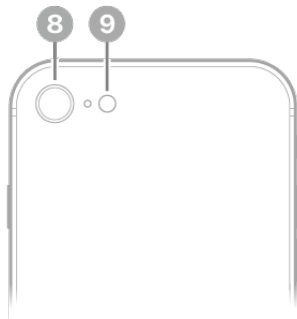

- 8 Rear camera
- 9 Flash

Get started with iPhone SE

- [Turn on and set up iPhone](#)
- [Learn basic gestures to interact with iPhone](#)
- [iPhone camera basics](#)
- [Qi-certified wireless chargers for iPhone](#)
- [What's new in iOS 17](#)

iPhone 14

Learn the location of the cameras, buttons, and other essential hardware features on iPhone 14.

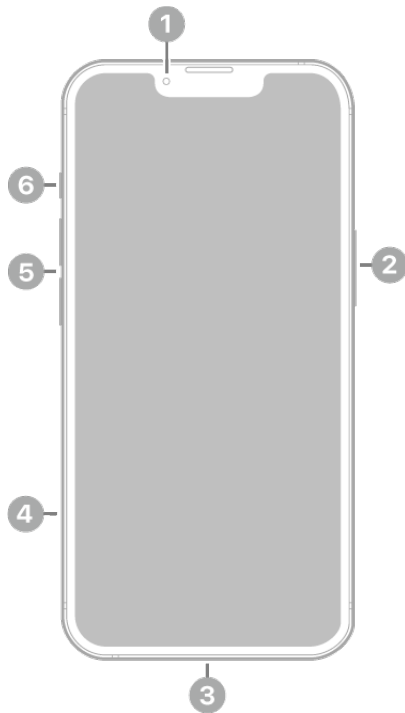

- ① Front camera
- ② Side button
- ③ Lightning connector
- ④ SIM tray (available on models purchased outside the U.S.)
- ⑤ Volume buttons
- ⑥ Ring/Silent switch

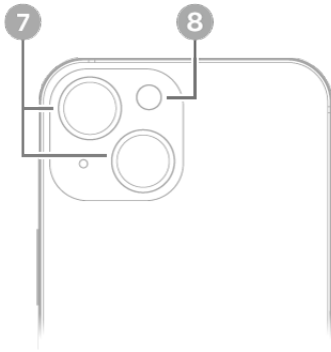

- ⑦ Rear cameras
- ⑧ Flash

Get started with iPhone 14

- [Turn on and set up iPhone](#)
- [Learn gestures for iPhone models with Face ID](#)
- [iPhone camera basics](#)
- [MagSafe chargers and battery packs for iPhone](#)
- [What's new in iOS 17](#)

iPhone 14 Plus

Learn the location of the cameras, buttons, and other essential hardware features on iPhone 14 Plus.

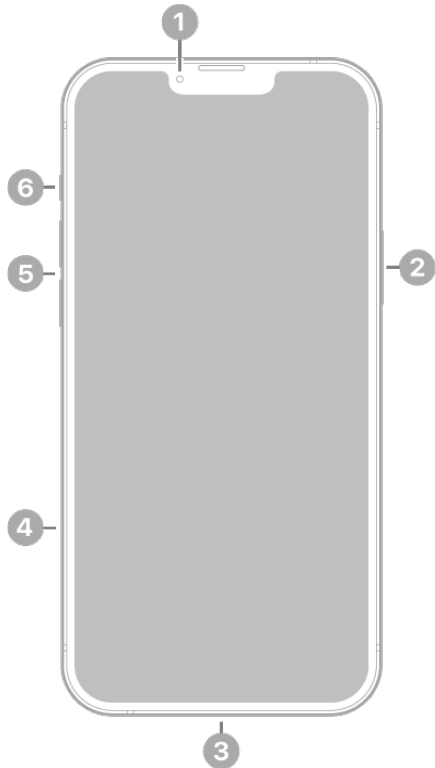

- 1 Front camera
- 2 Side button
- 3 Lightning connector
- 4 SIM tray (available on models purchased outside the U.S.)
- 5 Volume buttons
- 6 Ring/Silent switch

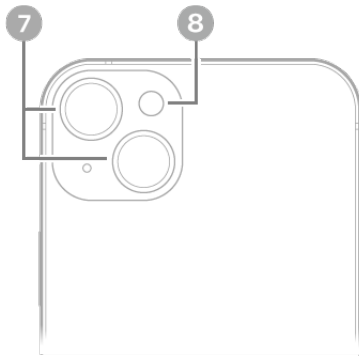

- 7 Rear cameras
- 8 Flash

Get started with iPhone 14 Plus

- [Turn on and set up iPhone](#)
- [Learn gestures for iPhone models with Face ID](#)
- [iPhone camera basics](#)
- [MagSafe chargers and battery packs for iPhone](#)
- [What's new in iOS 17](#)

iPhone 14 Pro

Learn the location of the cameras, buttons, and other essential hardware features on iPhone 14 Pro.

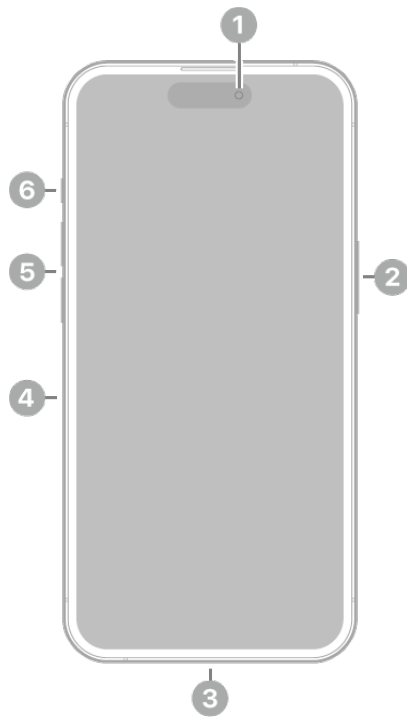

- ① Front camera
- ② Side button
- ③ Lightning connector
- ④ SIM tray (available on models purchased outside the U.S.)
- ⑤ Volume buttons
- ⑥ Ring/Silent switch

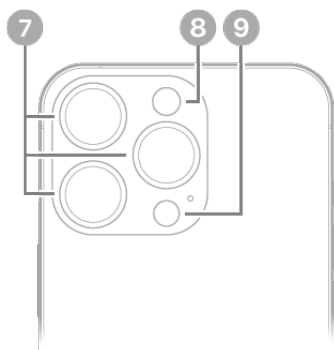

- ⑦ Rear cameras
- ⑧ Flash
- ⑨ LiDAR Scanner

Get started with iPhone 14 Pro

- [Turn on and set up iPhone](#)
- [Learn gestures for iPhone models with Face ID](#)
- [iPhone camera basics](#)
- [MagSafe chargers and battery packs for iPhone](#)
- [What's new in iOS 17](#)

iPhone 14 Pro Max

Learn the location of the cameras, buttons, and other essential hardware features on iPhone 14 Pro Max.

DRAFT: APPLE CONFIDENTIAL

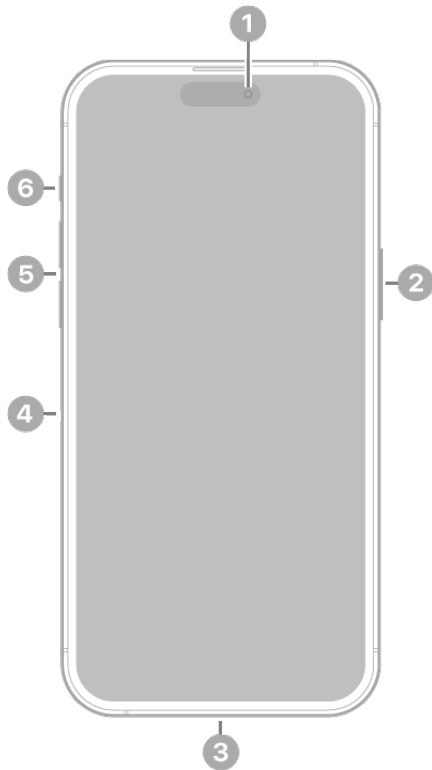

- 1 Front camera
- 2 Side button
- 3 Lightning connector
- 4 SIM tray (available on models purchased outside the U.S.)
- 5 Volume buttons
- 6 Ring/Silent switch

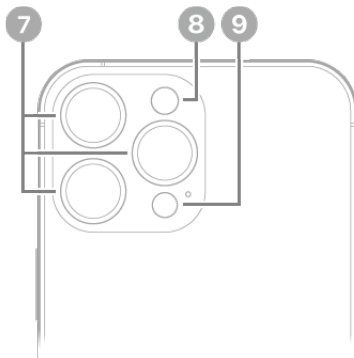

- 7 Rear cameras
- 8 Flash
- 9 LiDAR Scanner

Get started with iPhone 14 Pro Max

- [Turn on and set up iPhone](#)
- [Learn gestures for iPhone models with Face ID](#)
- [iPhone camera basics](#)
- [MagSafe chargers and battery packs for iPhone](#)
- [What's new in iOS 17](#)

iPhone X

Learn the location of the cameras, buttons, and other essential hardware features on iPhone X

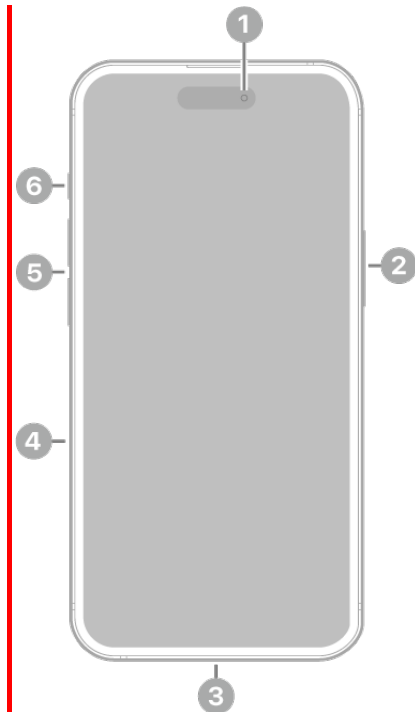

- 1 Front camera
- 2 Side button
- 3 USB-C connector
- 4 SIM tray (available on models purchased outside the U.S.)
- 5 Volume buttons
- 6 Ring/Silent switch

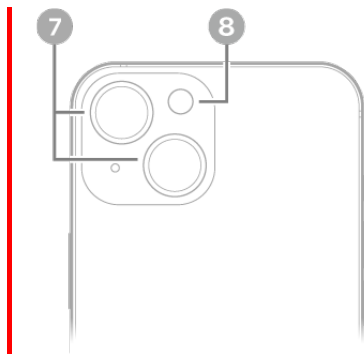

- 7 Rear cameras
- 8 Flash

Get started with iPhone X

- [Turn on and set up iPhone](#)
- [Learn gestures for iPhone models with Face ID](#)
- [iPhone camera basics](#)
- [MagSafe chargers and battery packs for iPhone](#)
- [What's new in iOS 17](#)

iPhone XX

Learn the location of the cameras, buttons, and other essential hardware features on iPhone XX.

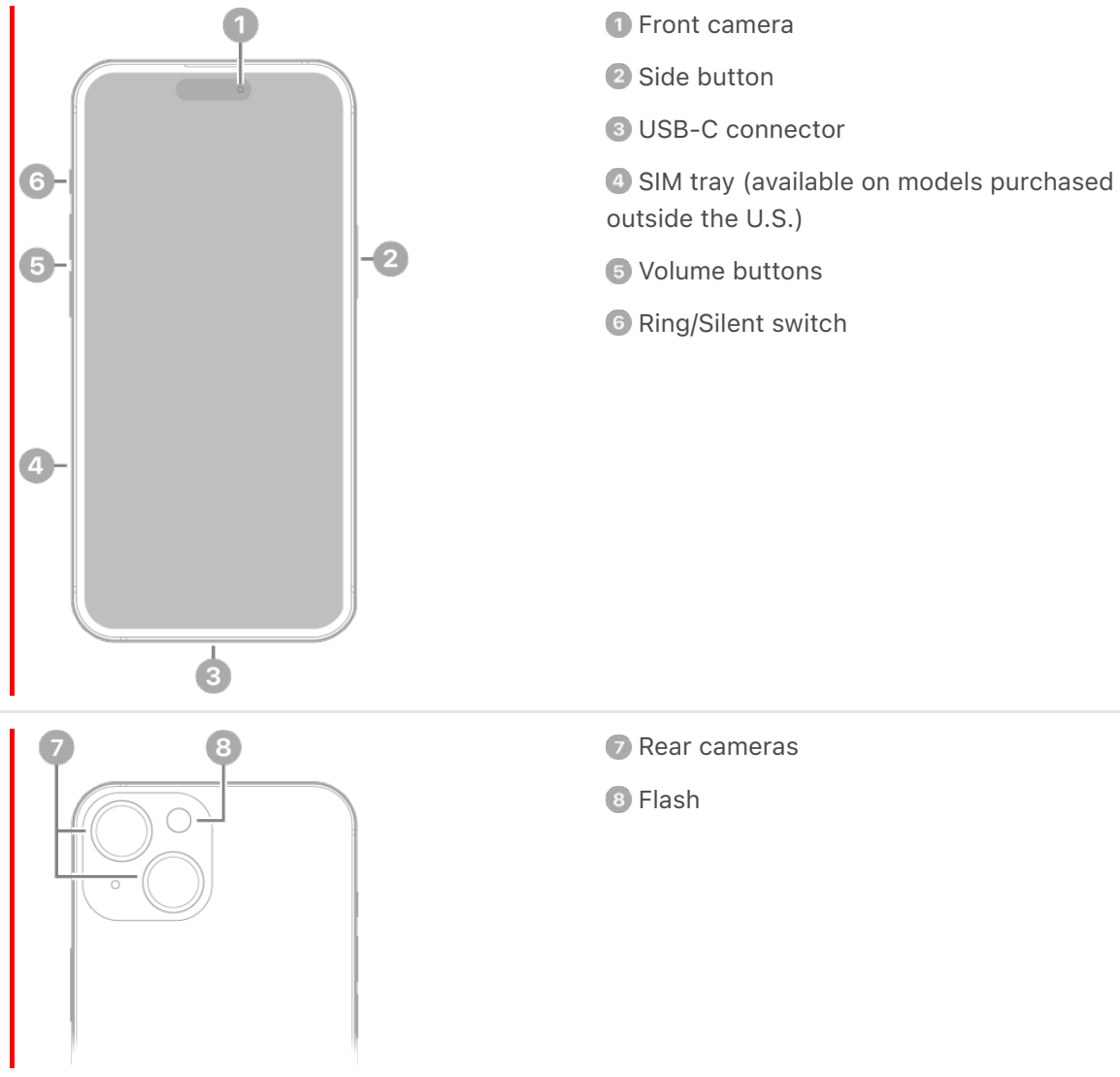

Get started with iPhone XX

- [Turn on and set up iPhone](#)
- [Learn gestures for iPhone models with Face ID](#)
- [iPhone camera basics](#)
- [MagSafe chargers and battery packs for iPhone](#)
- [What's new in iOS 17](#)

iPhone Y

Learn the location of the cameras, buttons, and other essential hardware features on iPhone Y.

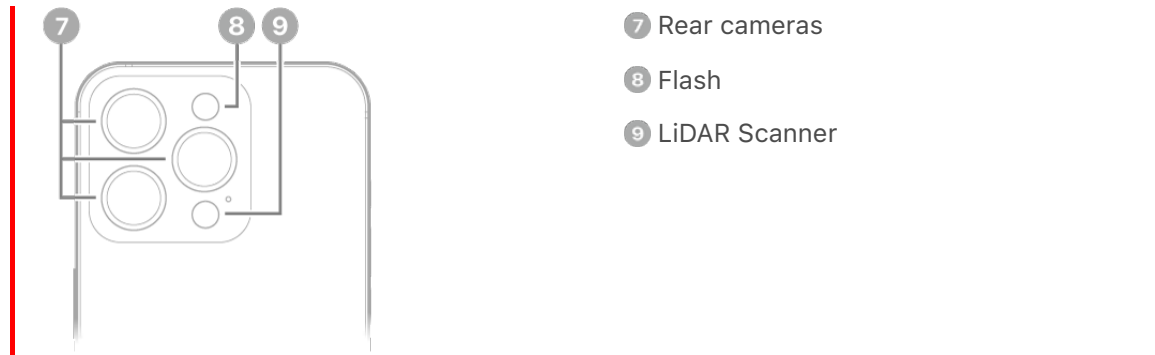
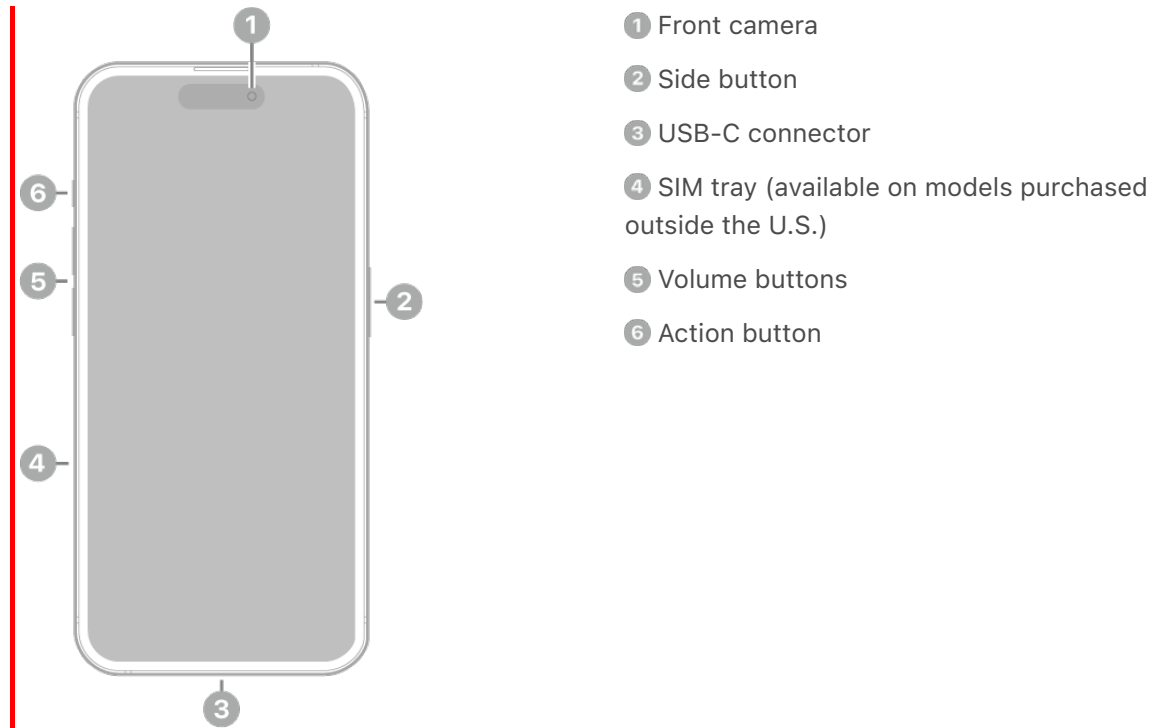

Get started with iPhone Y

- [Turn on and set up iPhone](#)
- [Learn gestures for iPhone models with Face ID](#)
- [Customize the Action button on iPhone Y](#)
- [iPhone camera basics](#)
- [MagSafe chargers and battery packs for iPhone](#)
- [What's new in iOS 17](#)

iPhone YY

Learn the location of the cameras, buttons, and other essential hardware features on iPhone YY.

DRAFT: APPLE CONFIDENTIAL

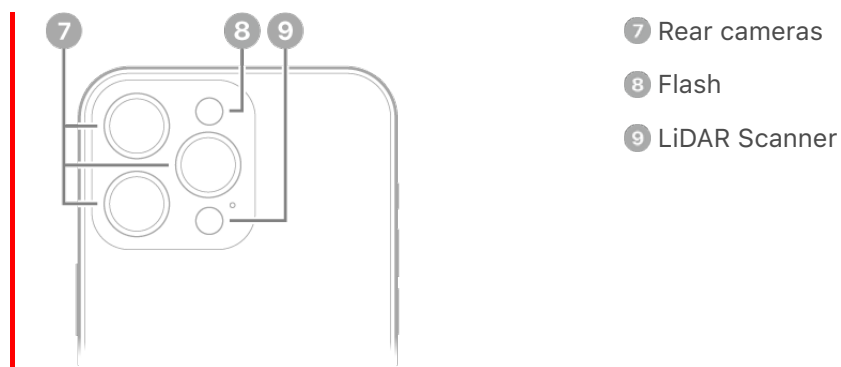
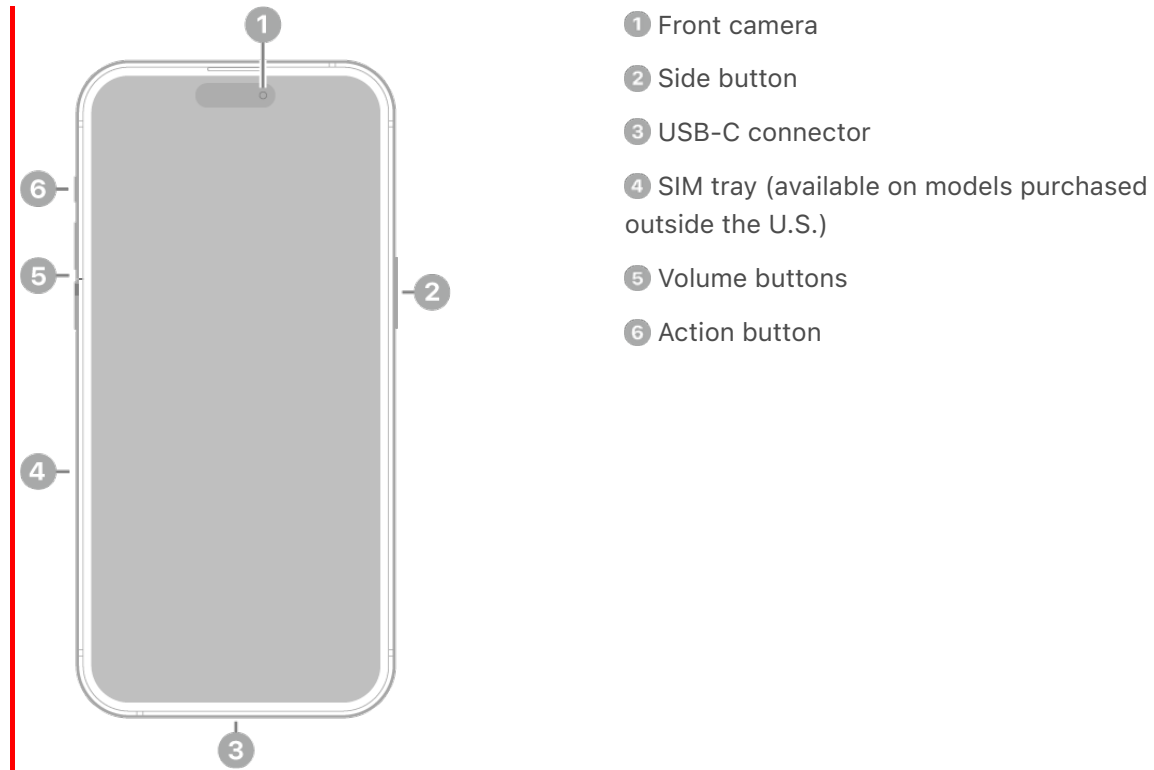

Get started with iPhone YY

- [Turn on and set up iPhone](#)
- [Learn gestures for iPhone models with Face ID](#)
- [Customize the Action button on iPhone Y](#)
- [iPhone camera basics](#)
- [MagSafe chargers and battery packs for iPhone](#)
- [What's new in iOS 17](#)

What's new in iOS 17

StandBy. Turn your iPhone on its side while charging to glance at important information from a distance. You can turn your iPhone into a bedside clock, view photos, control music and more. See [Use StandBy to transform the iPhone screen while charging](#).



Interactive widgets. Widgets on your Home Screen, Lock Screen, and StandBy are even more useful with interactivity. Just tap a widget to complete tasks like checking off a to-do, controlling your living room lights, or playing a new podcast episode. See [Add, edit, and remove widgets on iPhone](#).



Contact Posters. Create a unique screen that other people see when you call them. When you make a phone call, your Contact Poster appears on the screen of the person you're calling. See [Add or edit your photo and poster](#).



Live Voicemail. When a call you receive goes to voicemail, see a live transcript of the message as it's being recorded, giving you immediate context for the call. If it's something you want to address right then, you can pick up the call (available in US and Canada). See [Turn on Live Voicemail](#).

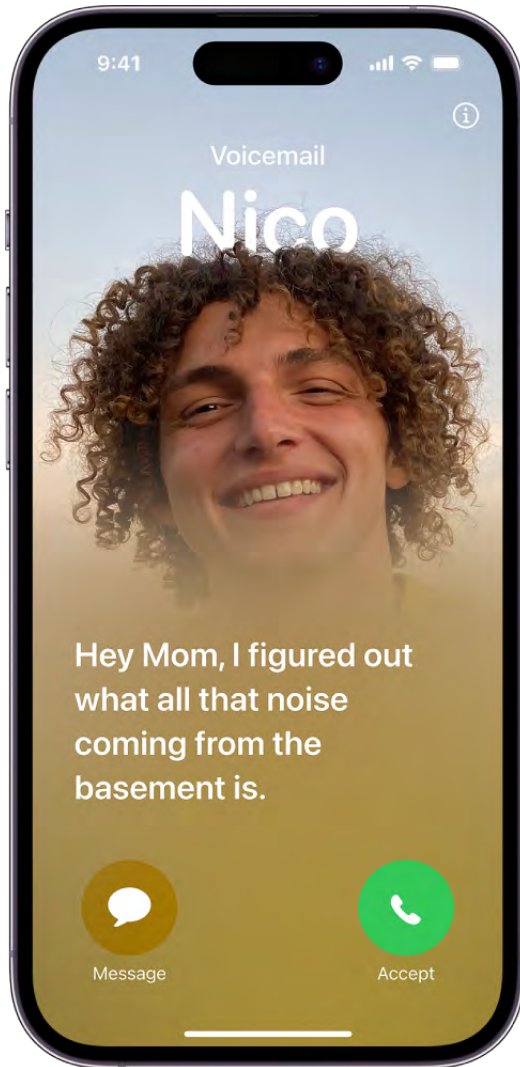

Stickers. Use Stickers to decorate your photos, screenshots, and more. You can add stickers anywhere you can use the onscreen keyboard or Markup tools. Create stickers from Memoji in Messages, or make stickers from your own photos or Live Photos. See [Send stickers in Messages on iPhone](#), [Decorate text documents with stickers](#), and [Make stickers from your photos on iPhone](#).



Messages. Use Check In to let a friend or family member know when you arrive safely at a destination. You can also share your location or request a friend’s location right in a Messages conversation. Audio messages are now transcribed, so you can read them in the moment and listen later. Find the message you’re looking for faster by combining filters to narrow your search. See [Use Check In on iPhone to let your friends know you’ve arrived](#), [Share your location in Messages on iPhone](#), [Send and receive recorded audio messages on iPhone](#), and [Search in Messages on iPhone](#).

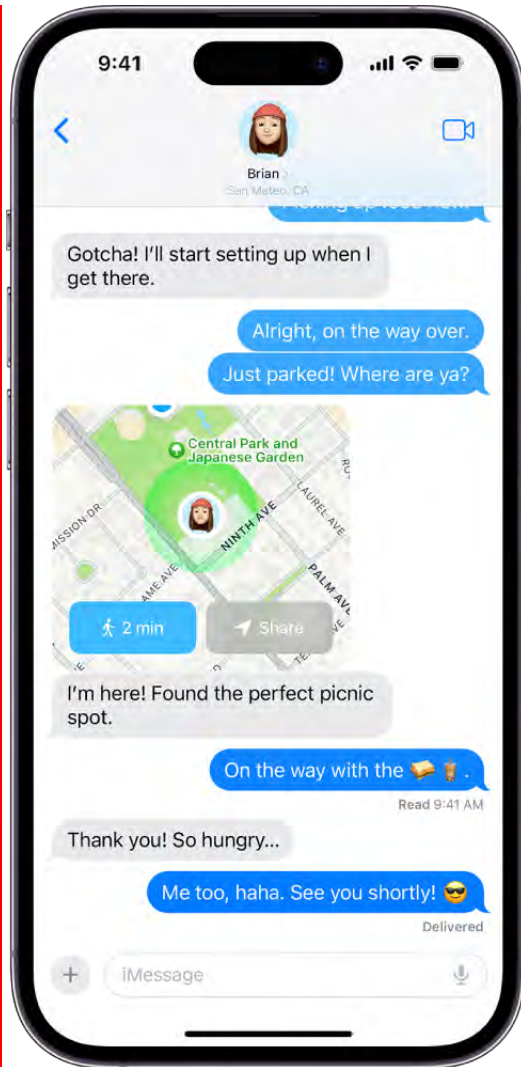

Keyboard. Autocorrected words are temporarily underlined so you know what's been changed, and you can revert back to the original word with just a tap. Predictive text appears inline as you type—just tap the Space bar to finish a word or sentence (not available in all countries or regions). See [Enter text using the onscreen keyboard](#) and [Use predictive text on iPhone](#).

FaceTime. If someone doesn't answer your FaceTime call, now you can leave them an audio or video message. During a FaceTime call, use hand gestures to create reactions like hearts, confetti, and fireworks that fill the screen. Hand off FaceTime calls between your iPhone and Apple TV. See [Record a video message](#), [Receive a video message or Live Voicemail](#), [Add reactions during a video call](#), and [Hand off a FaceTime call from your iPhone to your other Apple devices](#).

DRAFT: APPLE CONFIDENTIAL

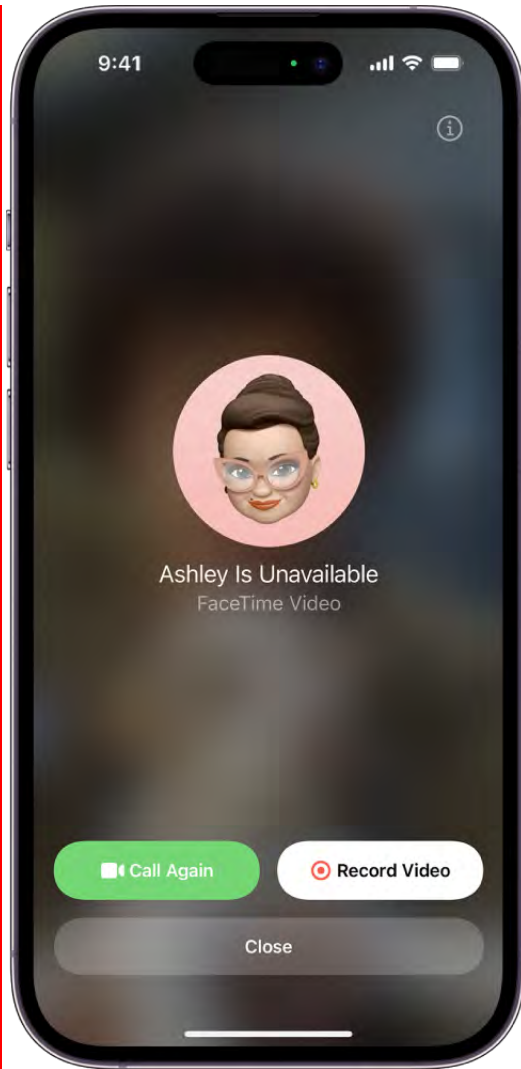

AirDrop. Hold your iPhone near someone else's to swap phone numbers, email addresses, and Contact Posters with NameDrop. You can also initiate an AirDrop transfer, or start a SharePlay session, when you bring two phones close together. See [Use NameDrop on to share your contact info](#), [Share photos and videos by bringing two iPhones together](#), and [Start a SharePlay session by holding two iPhone devices close together](#).



Maps. Save an area of a map to your iPhone and explore it offline. When driving an electric vehicle, choose a preferred charging network and see real-time charging station availability. See [Download offline Maps on iPhone](#).

DRAFT: APPLE CONFIDENTIAL

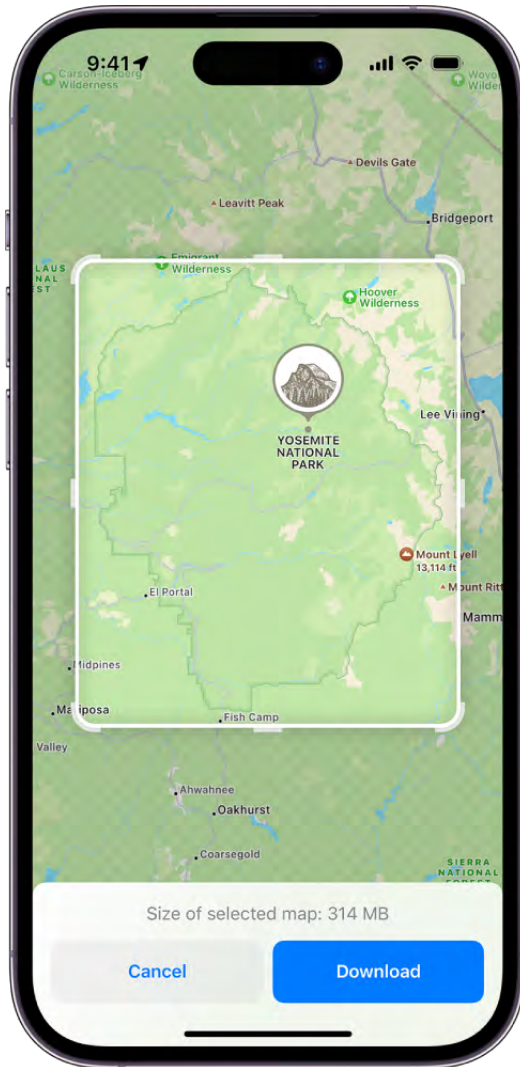

Visual Look Up. Pause a video on any frame to use Visual Look Up in your videos as well as photos. Visual Look Up can identify food and suggest recipes for similar dishes from a photo. Visual Look Up information is also available for objects that you lift from the background of photos. See [Use Visual Look Up to identify objects in your photos and videos on iPhone.](#)

DO NOT DISTRIBUTE

DRAFT: APPLE CONFIDENTIAL

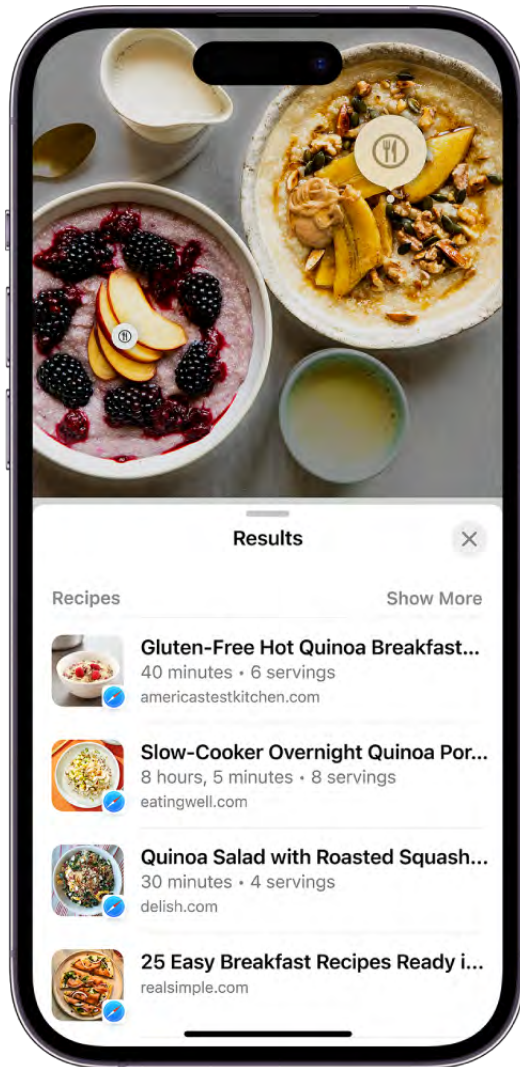

Photos. iPhone recognizes and sorts pets just like a friend or family member in the People & Pets album. Choose a new focus point when you edit a portrait. Add any photo from your photo library to a memory and reorder photos and videos within a memory. See [Identify people and pets in Photos on iPhone](#), [Change the focus point of a portrait](#), and [Personalize your memories in Photos on iPhone](#).

Health. Keep track of your state of mind to help build emotional awareness and resilience. You can also access mental health resources, articles, and standardized assessments about how you're feeling to help you determine if you should talk to your doctor. See [Track your mental wellbeing in Health on iPhone](#).

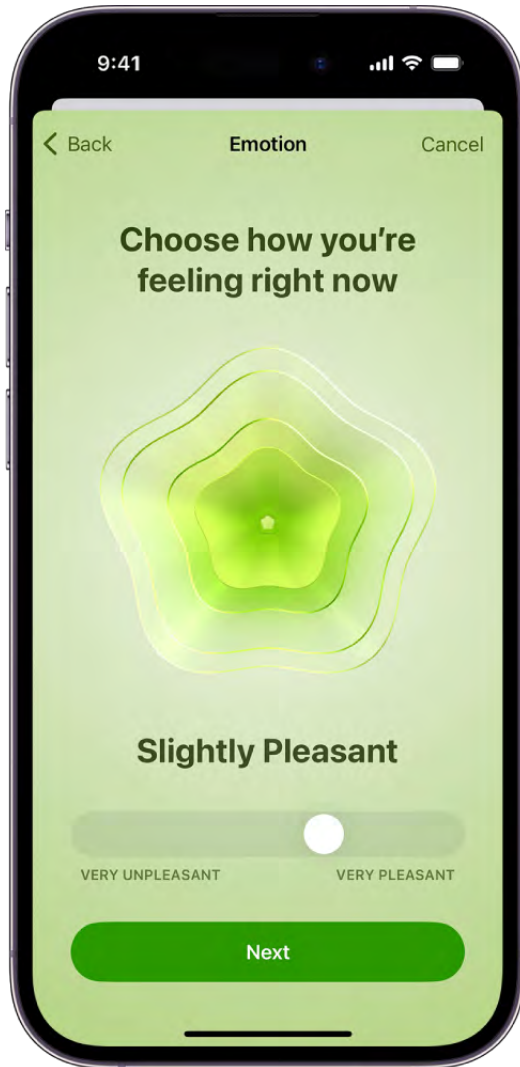

Fitness. The redesigned Sharing tab provides highlights of your friends' activity like workout streaks and awards. Create a workout and meditation schedule based on exactly what you want with Custom Plans in Apple Fitness+. See [Share your activity in Fitness on iPhone](#) and [Create a Custom Plan in Apple Fitness+ on iPhone](#).

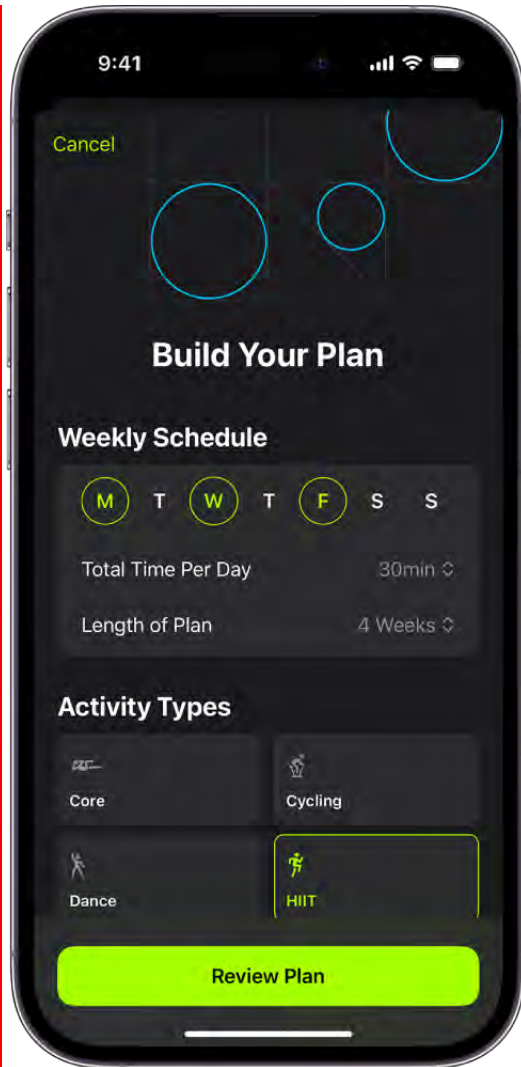

Screen Distance. Help protect your vision with the Screen Distance feature in Screen Time, which encourages you to move your iPhone farther away if you've held it closer than 12 inches for an extended period. See [Protect your vision health with Screen Distance on iPhone](#).

Safari. Use different profiles for different topics—like work and personal—to keep your browsing separate. Autofill verification codes you receive in Mail are populated automatically, so you don't have to leave Safari to fill them in, and you can share passwords to a set of accounts with trusted friends and family. See [Create multiple Safari profiles on iPhone](#) and [Share passwords or passkeys with people you trust on iPhone](#).

DRAFT: APPLE CONFIDENTIAL

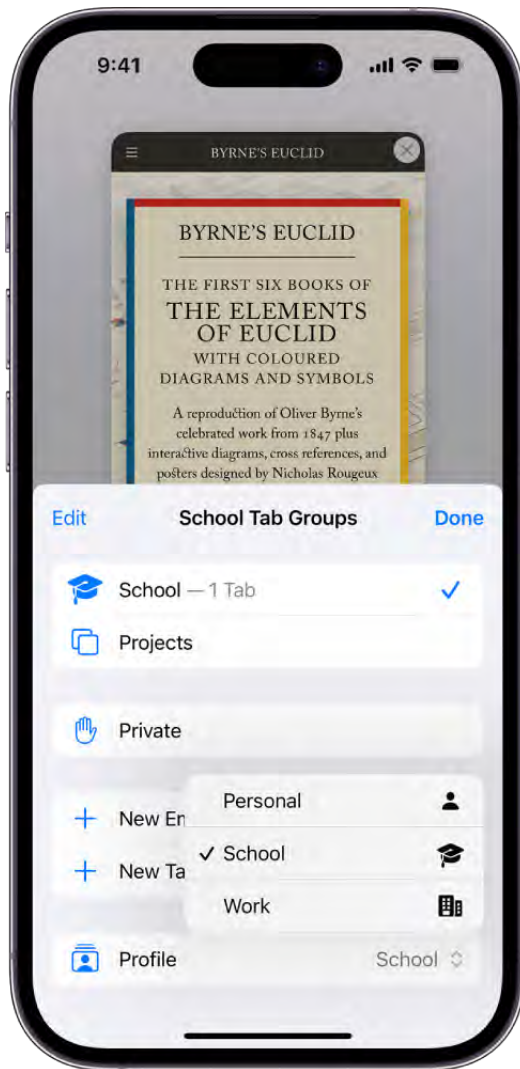

Privacy and Security. Communication Safety now includes protections against sensitive videos and photos including content sent and received in AirDrop, Contact Posters, systemwide photo picker, and FaceTime messages. You can choose to blur sensitive photos and videos before you view them using Sensitive Content Warning. Enhancements to Lockdown Mode help protect against sophisticated cyber attacks. See [Receive warnings about sensitive content on iPhone](#) and [Harden your iPhone from a cyberattack with Lockdown Mode](#).

Accessibility. Personal Voice helps people with speech loss create a voice that sounds like them and use it with Live Speech to communicate in calls and conversations. Point and Speak makes it easier for people who are blind or have low vision to interact with physical objects that have text labels. See [Record a Personal Voice on iPhone](#).

Magnifier. Point and Speak makes it easier for people who are blind or have low vision to interact with physical objects that have text labels. See [Read aloud text and labels around you using Magnifier on iPhone](#).

DRAFT: APPLE CONFIDENTIAL

Reminders. Grocery Lists automatically sort items into categories to make shopping easier. Lists can also be divided into sections with headers, and a new Column View arranges sections next to each other to help visualize your tasks. See [Make a grocery list in Reminders on iPhone](#).

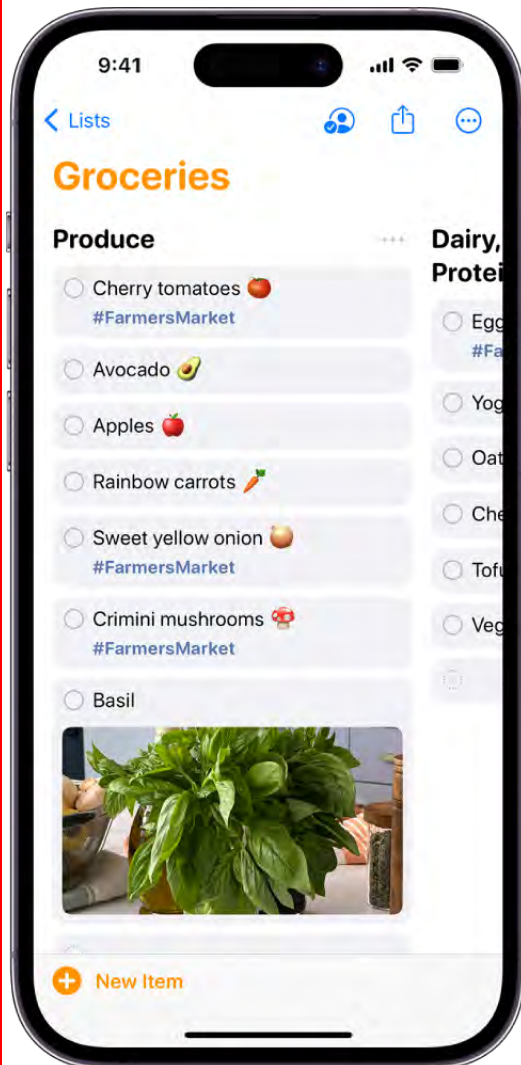

Notes. Easily review PDFs and scans of presentations, assignments, research papers, and more right in your note. You can also add links to connect related notes, like a trip itinerary and a list of recommended restaurants. See [Work with PDFs in Notes on iPhone](#) and [Add links in Notes on iPhone](#).

Freeform. Use new drawing tools like a watercolor brush, calligraphy pen, highlighter, variable-width pen, and ruler while brainstorming on a board. See [Draw or handwrite on a Freeform board on iPhone](#).

Find My. Share AirTags and other Find My items with up to five other people. Everyone you share with can track the item and play sounds. Get directions to help you find a person you're trying to meet up with. See [Share an AirTag or other item in Find My on iPhone](#).

DRAFT: APPLE CONFIDENTIAL

[iPhone](#) and [Use Precision Finding on iPhone XY to meet up with a friend](#) .

News. Apple News+ subscribers can do daily crossword puzzles in the News app, and Apple News+ audio stories are available in the Podcasts app. See [Solve crossword puzzles in Apple News on iPhone](#) and [Listen to subscriber-only content in Podcasts on iPhone](#).

Home. Activity History lets you see who locked or unlocked the door—and when. It also shows recent activity for garage doors, contact sensors, and your security system. See [View Activity History](#).

Learn tricks for iOS 17 The Tips app adds new suggestions frequently, so you can get the most from your iPhone. See [Get tips](#).

Note: New features and apps may vary depending on your iPhone model, region, language, and carrier.

Set up and get started

Turn on and set up iPhone

You can turn on and set up your new iPhone with an internet connection. You can also set up iPhone by connecting it to your computer. If you have another iPhone, an iPad, or an Android device, you can transfer your data to your new iPhone.

Note: If your iPhone is deployed or managed by a company or other organization, see an administrator for setup instructions. For general information, see the [Apple at Work website](#).

Prepare for setup

To make setup as smooth as possible, have the following items available:

- An internet connection through a Wi-Fi network (you may need the name and password of the network) or cellular data service through a carrier (not required for iPhone 14 and later models)
- Your Apple ID and password; if you don't have an Apple ID, you can create one during setup
- Your credit or debit card account information, if you want to add a card to Apple Pay during setup
- Your previous iPhone or a [backup of your device](#), if you're transferring your data to your new device

Tip: If you don't have sufficient storage space to back up your device, iCloud will grant you as much as you need to complete a temporary backup, free of charge, for up to three weeks from the purchase of your iPhone. On your previous device, go to Settings > General > Transfer or Reset [*device*]. Tap Get Started, then follow the onscreen instructions.

- Your Android device, if you're transferring your Android content
-

Turn on and set up your iPhone

1. Press and hold the side button until the Apple logo appears.

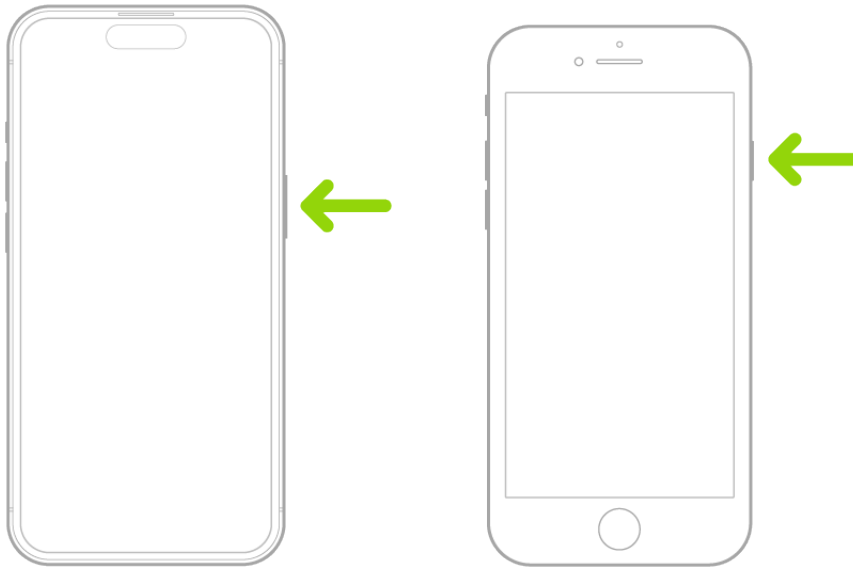

If iPhone doesn't turn on, you might need to [charge the battery](#). For more help, see the Apple Support article [If your iPhone won't turn on or is frozen](#).

Tip: If you're blind or have low vision, you can triple-click the side button (on an iPhone with Face ID) or triple-click the Home button (on other iPhone models) to turn on VoiceOver, the screen reader. You can also double-tap the screen with three fingers to turn on Zoom. See [Get started with accessibility features on iPhone](#).

2. Do one of the following:

- **Use Quick Start:** If you have another iPhone or iPad with iOS 11, iPadOS 13, or later, you can use Quick Start to automatically set up your new device. Bring the two devices close together, then follow the onscreen instructions to securely copy many of your settings, preferences, and iCloud Keychain. You can then restore the rest of your data and content to your new device from your iCloud backup.

Or, if both devices have iOS 12.4, iPadOS 13, or later, you can transfer all your data wirelessly from your previous device to your new one. Keep your devices near each other and plugged into power until the migration process is complete.

You can also transfer your data using a wired connection between your devices. See the Apple Support article [Use Quick Start to transfer data to a new iPhone or iPad](#).

- **Set Up Manually:** If you don't have another device, tap Set Up Manually, then follow the onscreen setup instructions.

Move from an Android device to iPhone

If you have an Android device, you can transfer your data with the Move to iOS app when you first set up your new iPhone.

Note: If you already completed setup and want to use Move to iOS, you must erase your iPhone and start over, or move your data manually. See the Apple Support article [Move content manually from your Android device to your iPhone or iPad](#).

1. On your device with Android version 4.0 or later, see the Apple Support article [Move from Android to iPhone or iPad](#) and download the Move to iOS app.
2. On your iPhone, do the following:
 - Follow the setup assistant.
 - On the Transfer Your Apps & Data screen, tap From Android.
3. On the Android device, do the following:
 - Turn on Wi-Fi.
 - Open the Move to iOS app.
 - Follow the onscreen instructions.

WARNING: To avoid injury, read [Important safety information for iPhone](#) before using iPhone.

Wake and unlock iPhone

iPhone turns off the display to save power, locks for security, and goes to sleep when you're not using it. You can quickly wake and unlock iPhone when you want to use it again.

Wake iPhone

To wake iPhone, do one of the following:

- Press the side button.

DRAFT: APPLE CONFIDENTIAL

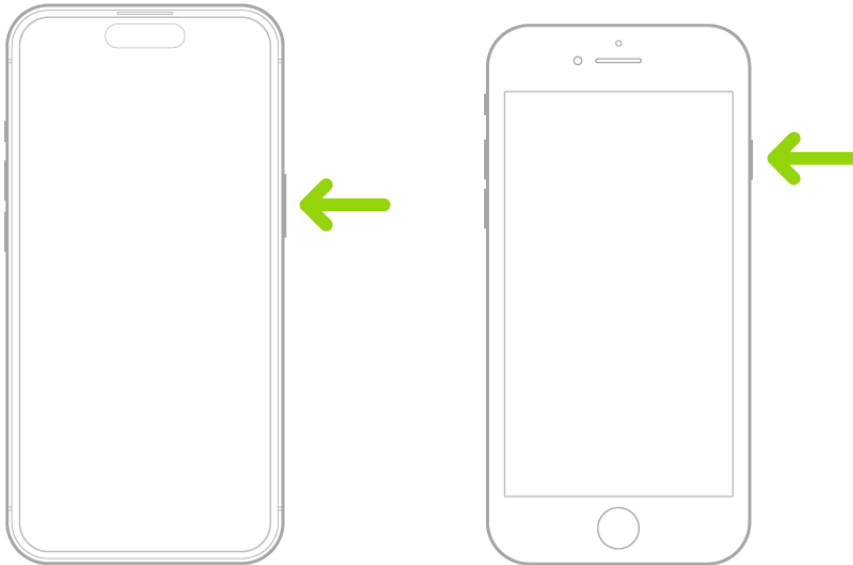

- Raise iPhone.

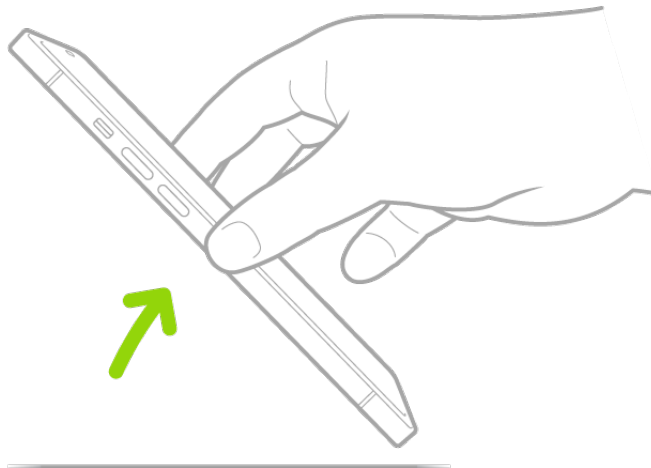

Note: To turn off Raise to Wake, go to Settings  > Display & Brightness.

- Tap the screen (not available on iPhone SE).

DRAFT: APPLE CONFIDENTIAL

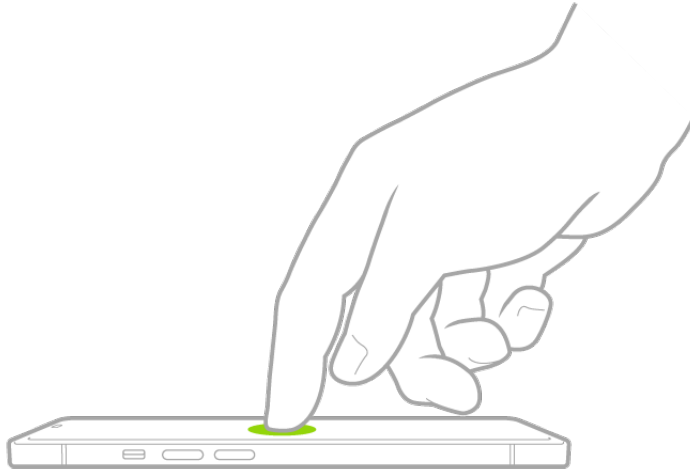

Unlock iPhone with Face ID

If you have an iPhone with Face ID, but you didn't turn on Face ID during setup, see [Set up Face ID](#).

1. Tap the screen or raise iPhone to wake it, then glance at your iPhone.

The lock icon animates from closed to open to indicate that iPhone is unlocked.

2. Swipe up from the bottom of the screen.

To lock iPhone again, press the side button. iPhone locks automatically if you don't touch the screen for a minute or so. However, if Attention Aware Features is turned on in Settings  > Face ID & Passcode, iPhone won't dim or lock as long as it detects attention.

Unlock iPhone with Touch ID

If you have an iPhone with a Home button, but you didn't turn on Touch ID during setup, see [Set up Touch ID on iPhone](#).

To unlock iPhone, press the Home button using the finger you registered with Touch ID.

DRAFT: APPLE CONFIDENTIAL

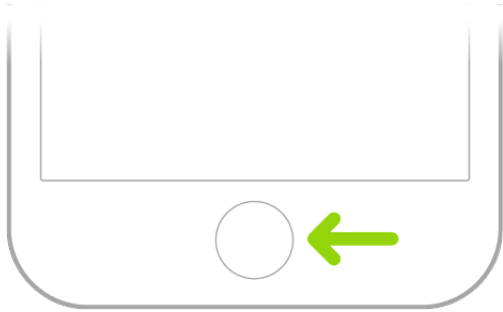

To lock iPhone again, press the side button. iPhone locks automatically if you don't touch the screen for a minute or so.

Unlock iPhone with a passcode

If you didn't create a passcode when you set up iPhone, see [Set a passcode on iPhone](#).

1. Swipe up from the bottom of the Lock Screen (on an iPhone with Face ID) or press the Home button (on other iPhone models).
2. Enter your passcode.

To lock iPhone again, press the side button. iPhone locks automatically if you don't touch the screen for a minute or so.

Set up cellular service on iPhone

Your iPhone needs a physical SIM or an eSIM to connect to a cellular network. (Not all options are available on all models or in all countries and regions. On iPhone 14 and later models purchased in the U.S., you can only use eSIM.) Contact your carrier to get a SIM and set up cellular service.

Set up an eSIM

Supported iPhone models can digitally store an eSIM provided by your carrier. If your carrier supports either eSIM Carrier Activation or eSIM Quick Transfer, you can turn on your iPhone and follow the instructions to activate your eSIM during setup.

If you already completed setup, you can do any of the following:

- *eSIM Carrier Activation*: Some carriers can assign a new eSIM directly to your iPhone; contact your carrier to initiate this process. When you receive the "Finish Setting Up Cellular" notification, tap it. Or go to Settings  > Cellular, then tap Set Up Cellular or Add eSIM.

DRAFT: APPLE CONFIDENTIAL

- **eSIM Quick Transfer:** Some carriers support transferring a phone number from your previous iPhone to your new iPhone without needing to contact them (requires iOS 16 or later on both devices).

On your new iPhone, go to Settings > Cellular, tap Set Up Cellular or Add eSIM, then tap Transfer From Nearby iPhone or choose a phone number. On your previous iPhone, follow the instructions to confirm the transfer.

Note: After your phone number is transferred to your new iPhone, it stops working on your previous iPhone.

- **Scan a QR Code provided by your carrier:** Go to Settings > Cellular, tap Set Up Cellular or Add eSIM, then tap Use QR Code. (You may need to tap Other Options first.) Position iPhone so the QR code appears in the frame, or enter the details manually. You may be asked to enter a confirmation code provided by your carrier.
- **Transfer from a different smartphone:** If your previous phone isn't an Apple iPhone, contact your carrier to transfer the phone number.
- **Activate service through a participating carrier's app:** Go to the App Store, download the carrier's app, then use the app to activate cellular service.

Note: If prompted, [connect your iPhone to an available Wi-Fi or cellular network](#). eSIM setup requires an internet connection.

Install a physical SIM

You can get a nano-SIM card from a carrier or move it from your previous iPhone.

Note: Physical SIM isn't compatible with iPhone 14 and later models purchased in the U.S.

1. Insert a paper clip or SIM eject tool into the small hole of the SIM tray, then push in toward iPhone to eject the tray.

DRAFT: APPLE CONFIDENTIAL

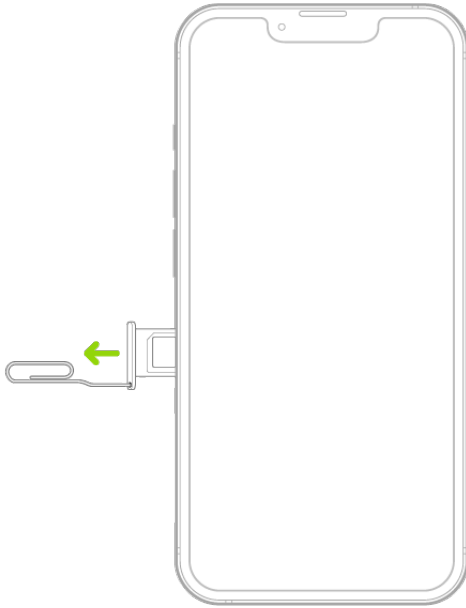

Note: The shape and orientation of the SIM tray depend on the iPhone model and your country or region.

2. Remove the tray from iPhone.
3. Place the SIM in the tray. The angled corner determines the correct orientation.

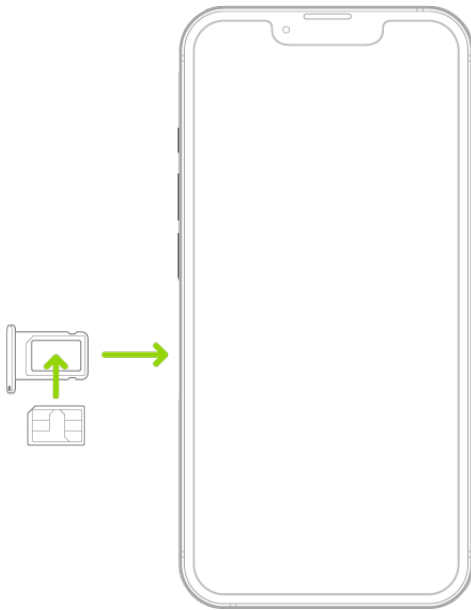

4. Insert the tray back into iPhone.
5. If you previously set up a PIN on the SIM, carefully enter the PIN when prompted.

WARNING: Never try to guess a SIM PIN. An incorrect guess can permanently lock your SIM, and you won't be able to make phone calls or use cellular data through your carrier until you get a new SIM. See the Apple Support article [Use a SIM PIN for your](#)

iPhone or iPad.

Convert a physical SIM to an eSIM

If your carrier supports it, you can convert a physical SIM to an eSIM on a supported iPhone model.

1. Go to Settings  > Cellular, tap Set Up Cellular or Add eSIM, then choose the phone number with a physical SIM.
 2. Tap Convert to eSIM, then follow the onscreen instructions.
-

Important: The availability of cellular capabilities depends on the wireless network, your iPhone model, and your location.

Consider applicable data, voice, and roaming charges when managing your cellular plans, especially when you travel with iPhone. See [View or change cellular data settings on iPhone](#).

Some carriers let you unlock iPhone for use with another carrier (additional fees may apply). Contact your carrier for authorization and setup information. See the Apple Support article [How to unlock your iPhone for use with a different carrier](#).

Use Dual SIM on iPhone

Here are some of the many ways you can use Dual SIM:

- Use one number for business and another number for personal calls.
- Add a local data plan when you travel to another country or region.
- Have separate voice and data plans.

Note: To use two different carriers, your iPhone must be unlocked. See the Apple Support article [How to unlock your iPhone for use with a different carrier](#).

You can set up Dual SIM with the following:

- One physical SIM and one eSIM; available on iPhone XR, iPhone Xs, iPhone 11, iPhone 12, iPhone 13, iPhone SE (2nd generation), and iPhone 14 and later (purchased outside the U.S.)
- Two eSIMs; iPhone 13, iPhone SE (3rd generation), and later

Note: eSIM isn't available in certain countries or regions.

Set up Dual SIM

1. Go to Settings  > Cellular, then make sure you have at least two lines (below SIMs). To add a line, see [Set up cellular service on iPhone](#).
2. Turn on two lines—tap a line, then tap Turn On this Line.

You can also change settings such as Cellular Plan Label, Wi-Fi Calling (if available from your carrier), Calls on Other Devices, or SIM PIN. The label appears in Phone, Messages, and Contacts.

3. Choose the default line for cellular data—tap Cellular Data, then tap a line. To use either line depending on coverage and availability, turn on Allow Cellular Data Switching.

You may incur roaming charges if Data Roaming is on and you're outside the country or region covered by the carrier's network.

4. Choose the default line for voice calls—tap Default Voice Line, then tap a line.

When using Dual SIM, note the following:

- Wi-Fi Calling must be turned on for a line to enable that line to receive calls while the other line is in use for a call. If you receive a call on one line while the other is in use for a call, and no Wi-Fi connection is available, iPhone uses the cellular data of the line that is in use for the call to receive the other line's call. Charges may apply. The line that is in use for the call must be permitted for data use in your Cellular Data settings (either as the default line, or as the non-default line with Allow Cellular Data Switching turned on) to receive the other line's call.
- If you don't turn on Wi-Fi Calling for a line, any incoming phone calls on that line (including calls from emergency services) go directly to voicemail (if available from your carrier) when the other line is in use; you won't receive missed call notifications.

If you set up conditional call forwarding (if available from your carrier) from one line to another when a line is busy or not in service, the calls don't go to voicemail; contact your carrier for setup information.

- If you make a phone call from another device, such as your Mac, by relaying it through your iPhone with Dual SIM, the call is made using your default voice line.

DRAFT: APPLE CONFIDENTIAL

- If you start an SMS/MMS Messages conversation using one line, you can't switch the conversation to your other line; you need to delete the conversation and start a new conversation using the other line. Also, you may incur additional charges if you send SMS/MMS attachments on the line that's not selected for cellular data.
 - Instant Hotspot and Personal Hotspot use the line selected for cellular data.
-

Connect iPhone to the internet

Connect your iPhone to the internet by using an available Wi-Fi or cellular network.

Connect iPhone to a Wi-Fi network

1. Go to Settings  > Wi-Fi, then turn on Wi-Fi.
2. Tap one of the following:
 - *A network*: Enter the password, if required.
 - *Other*: To join a hidden network, enter the name of the network, security type, and password.

If  appears at the top of the screen, iPhone is connected to a Wi-Fi network. (To verify this, open Safari to view a webpage.) iPhone reconnects when you return to the same location.

Join a Personal Hotspot

If an iPad (Wi-Fi + Cellular) or another iPhone is sharing a Personal Hotspot, you can use its cellular internet connection.

1. Go to Settings  > Wi-Fi, then choose the name of the device sharing the Personal Hotspot.
 2. If asked for a password on your iPhone, enter the password shown in Settings > Cellular > Personal Hotspot on the device sharing the Personal Hotspot.
-

Connect iPhone to a cellular network

Your iPhone automatically connects to your carrier's cellular data network if a Wi-Fi network isn't available. If iPhone doesn't connect, check the following:

1. Verify that your SIM is activated and unlocked. See [Set up cellular service on iPhone](#).

DRAFT: APPLE CONFIDENTIAL

2. Go to Settings  > Cellular.
 3. Verify that Cellular Data is turned on. If you're [using Dual SIM](#), tap Cellular Data, then verify the selected line. (You can choose only one line for cellular data.)
-

When you need an internet connection, iPhone does the following, in order, until the connection is made:

- Tries to connect to the most recently used available Wi-Fi network
- Shows a list of Wi-Fi networks in range and connects to the one you choose
- Connects to your carrier's cellular data network

On an iPhone that supports 5G, iPhone may use your 5G cellular data instead of Wi-Fi. If so, you see Using 5G Cellular For Internet below the Wi-Fi network's name. To switch back to Wi-Fi, tap  next to the network name, then tap Use Wi-Fi for Internet. See the Apple Support article [Use 5G with your iPhone](#).

Note: If a Wi-Fi connection to the internet isn't available, apps and services may transfer data over your carrier's cellular network, which may result in additional fees. Contact your carrier for information about your cellular data rates. To manage cellular data usage, see [View or change cellular data settings on iPhone](#).

Apple ID and iCloud

Sign in to your iPhone with Apple ID

Your Apple ID is the account you use to access Apple services such as the App Store, the iTunes Store, Apple Books, Apple Music, FaceTime, iCloud, iMessage, and more.

Sign in with your Apple ID

If you didn't sign in during setup, do the following:

1. Go to Settings .
2. Tap Sign in to your iPhone.
3. Enter your Apple ID and password.

If you don't have an Apple ID, you can create one.

4. If you protect your account with two-factor authentication, enter the six-digit verification code.

If you forgot your Apple ID or password, see the [Recover your Apple ID website](#).

Change your Apple ID settings

1. Go to Settings  > [your name].
2. Do any of the following:
 - Update your contact information
 - Change your password
 - [Add or remove Account Recovery Contacts](#)
 - [Use iCloud](#)
 - View and manage your subscriptions
 - Update your payment methods or billing address
 - [Manage Family Sharing](#)

Use iCloud on iPhone

iCloud securely stores your photos, videos, documents, backups, and more—and keeps them updated across all your devices—automatically. With iCloud, you can also share photos, calendars, notes, folders, and files with friends and family. iCloud provides you with an email account and 5 GB of free storage for your data. For more storage and additional features, you can [subscribe to iCloud+](#).

Note: Some iCloud features have [minimum system requirements](#). The availability of iCloud and its features varies by country or region.

Change your iCloud settings

[Sign in with your Apple ID](#), then do the following:

1. Go to Settings  > [your name] > iCloud.

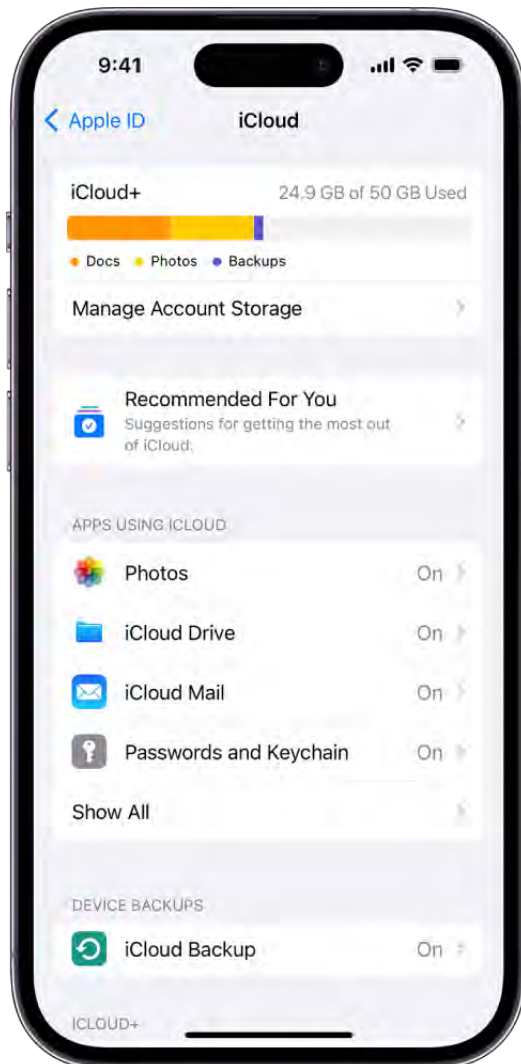

2. Do any of the following:

- See your iCloud storage status.
- Turn on the features you want to use, such as Photos, iCloud Drive, and iCloud Backup.

For information on how to customize iCloud features on your other devices, see [Set up iCloud and change settings on all your devices](#) in the iCloud User Guide.

Ways to use iCloud on iPhone

iCloud can keep your iPhone backed up automatically. See [Back up iPhone](#).

You can also keep the following information stored in iCloud and kept up to date across your iPhone and other Apple devices:

- Photos and videos; see [Use iCloud Photos on iPhone](#)
- Files and documents; see [Set up iCloud Drive on iPhone](#)
- iCloud Mail
- Contacts, Calendars, Notes, and Reminders
- Data from compatible third-party apps and games
- Messages; see [Set up Messages on iPhone](#)
- Passwords and payment methods; see [Make your passkeys and passwords available on all your devices with iPhone and iCloud Keychain](#)
- Safari bookmarks and open tabs; see [Bookmark a website in Safari on iPhone](#) and [Organize your tabs with Tab Groups in Safari on iPhone](#)
- News, Stocks, and Weather settings
- Home and Health data
- Voice memos
- Map favorites

You can also do the following:

- Share your photos and videos. See [Create shared albums in Photos on iPhone](#) and [Set up or join an iCloud Shared Photo Library in Photos on iPhone](#).

DRAFT: APPLE CONFIDENTIAL

- Share folders and documents with iCloud Drive. See [Share files and folders in iCloud Drive on iPhone](#).
- Use Find My to locate a missing device or share locations with friends and family. See [Locate a device in Find My on iPhone](#) and [Locate a friend in Find My on iPhone](#).

For additional storage and access to iCloud Private Relay, Hide My Email, and HomeKit Secure Video support, you can [subscribe to iCloud+](#).

You can also access your iCloud data on iPad, Apple Watch, Mac, Apple TV, your Windows computer, and [iCloud.com](#). To learn more about the available features and how they work across all your devices, see the [iCloud User Guide](#).

Subscribe to iCloud+ on iPhone

iCloud+ gives you [everything iCloud offers](#) plus premium features including iCloud Private Relay, Hide My Email, HomeKit Secure Video support, and all the storage you need for your photos, files, and more.

You can subscribe to iCloud+ or to Apple One, which includes iCloud+ and other Apple services. See the Apple Support article [Bundle Apple subscriptions with Apple One](#).

Note: Some iCloud+ features have [minimum system requirements](#). The availability of iCloud+ and its features varies by country or region.

What's included with iCloud+

When you subscribe to iCloud+, you can do the following on iPhone:

- Get 50 GB, 200 GB, or 2 TB of storage.
- Create unique, random email addresses that forward to your personal inbox with Hide My Email. See [Use Hide My Email in Safari on iPhone](#) and [Use Hide My Email in Mail on iPhone](#).
- Browse the web in an even more secure and private way with iCloud Private Relay. See [Protect your web browsing with iCloud Private Relay on iPhone](#).
- Set up home security cameras with HomeKit Secure Video so you can view your footage from anywhere while keeping it private and secure. See [Set up security cameras in Home on iPhone](#).

DRAFT: APPLE CONFIDENTIAL

- Use a custom email domain to personalize iCloud Mail. See [Set up a custom email domain with iCloud Mail on iPhone](#).

To learn more about iCloud+ features and how they work across all your devices, see the [iCloud User Guide](#).

Upgrade, change, or cancel your iCloud+ subscription

1. Go to Settings  > [your name] > iCloud.
2. Tap Manage Account Storage, tap Change Storage Plan, select an option, then follow the onscreen instructions.

Note: If you cancel your iCloud+ subscription, you lose access to the additional iCloud storage and iCloud+ features.

Share iCloud+

You can use [Family Sharing](#) to share iCloud+ with up to five other family members. When your family members accept your invitation to share iCloud+, they have instant access to the additional storage and features.

Note: To stop sharing iCloud+ with a family group, you can cancel the subscription, leave the family group, or leave or turn off Family Sharing. See [Add a member to a Family Sharing group on iPhone](#).

For information about combining your Apple subscriptions, see the Apple Support article [Bundle Apple subscriptions with Apple One](#).

Find settings on iPhone

In the Settings app , you can search for iPhone settings you want to change, such as your passcode, notification sounds, and more.

1. Tap Settings on the Home Screen (or in the [App Library](#)).

DRAFT: APPLE CONFIDENTIAL



2. Swipe down to reveal the search field, tap the search field, enter a term—"volume," for example—then tap a setting.

DRAFT: APPLE CONFIDENTIAL

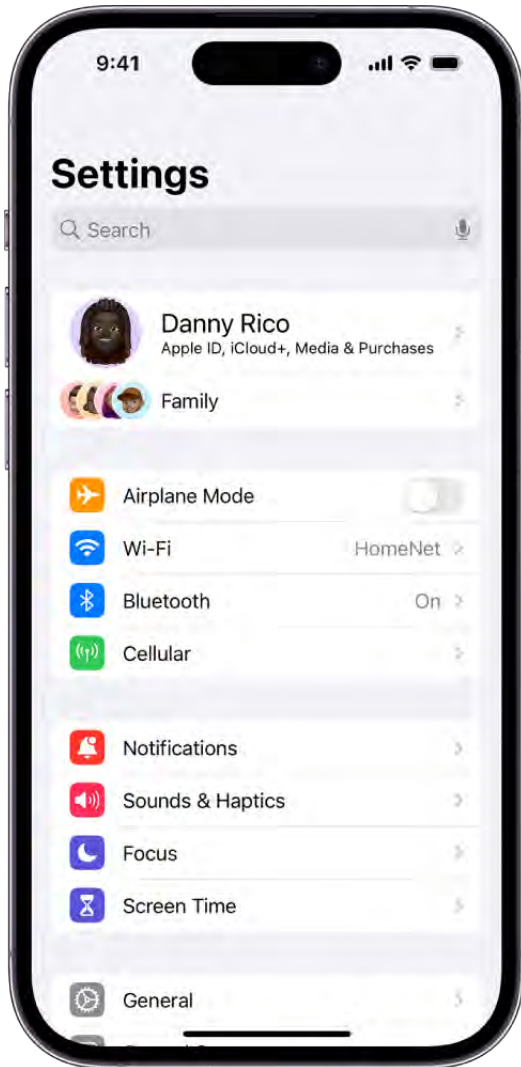

Tip: You can also [search for settings](#) from the Home Screen or Lock Screen.

Set up mail, contacts, and calendar accounts on iPhone

In addition to the apps that come with iPhone and that you use with [iCloud](#), iPhone works with Microsoft Exchange and many of the most popular internet-based mail, contacts, and calendar services. You can set up accounts for these services.

Set up a mail account

1. Go to Settings  > Mail > Accounts > Add Account.
2. Do one of the following:
 - Tap a service—for example, iCloud or Microsoft Exchange—then enter your account information.
 - Tap Other, tap Add Mail Account, then enter your account information.

See [Add and remove email accounts on iPhone](#).

Set up a contacts account

1. Go to Settings  > Contacts > Accounts > Add Account.
2. Do one of the following:
 - Tap a service—for example, iCloud or Microsoft Exchange—then enter your account information.
 - Tap Other, tap Add LDAP Account or Add CardDAV Account (if your organization supports it), then enter the server and account information.

See [Use other contact accounts on iPhone](#).

Set up a calendar account

1. Go to Settings  > Calendar > Accounts > Add Account.
2. Do one of the following:
 - *Choose a service:* Tap a service—for example, iCloud or Microsoft Exchange—then enter your account information.
 - *Add a calendar account:* Tap Other, tap Add CalDAV Account, then enter your server and account information.
 - *Subscribe to iCal (.ics) calendars:* Tap Other, tap Add Subscribed Calendar, then enter the URL of the .ics file to subscribe to; or import an .ics file from Mail.

See [Set up multiple calendars on iPhone](#).

DRAFT: APPLE CONFIDENTIAL





For information about setting up a Microsoft Exchange account in a corporate environment, see the Apple Support article [Set up Exchange ActiveSync on your iPhone or iPad](#).

If you turn on iCloud Keychain on your iPhone, your accounts stay up to date on all your devices that have iCloud Keychain turned on. See [Use to iCloud Keychain to keep passwords, accounts, and more up to date with iCloud](#) in the iCloud User Guide.



Learn the meaning of the iPhone status icons

The icons in the status bar at the top of the screen provide information about iPhone. On an iPhone with Face ID, there are additional status icons at the top of Control Center.

















Note: If you [turn on a Focus](#), its icon appears in the status bar.

Status icon	What it means
	Wi-Fi. iPhone is connected to the internet over a Wi-Fi network. See Connect iPhone to a Wi-Fi network .
	Cell signal. The number of bars indicates the signal strength of your cellular service. If there's no signal, "No Service" appears.
	Dual cell signals. On models with Dual SIM, the upper row of bars indicates the signal strength of the line you use for cellular data. The lower row of bars indicates the signal strength of your other line. If there's no signal, "No Service" appears. To see the status icons with their corresponding cellular plan labels and carrier names, open Control Center.
	Airplane mode. Airplane mode is on—you can't make phone calls, and other wireless functions may be disabled. See Choose iPhone settings for travel .
5G	5G. Your carrier's 5G network is available, and supported models can connect to the internet over that network (not available in all countries or regions). See the Apple Support article Use 5G with your iPhone .
5G^U	5G UC. Your carrier's 5G UC network is available, which can include your carrier's higher frequency version of 5G. Supported models can connect to the internet over that network (not available in all countries or regions). See the Apple Support article Use 5G with your iPhone .
5G+	5G+. Your carrier's 5G+ network is available, which can include your carrier's higher frequency version of 5G. Supported models can connect to the internet over that network (not available in all countries or regions). See the Apple Support article Use 5G with your iPhone .

DRAFT: APPLE CONFIDENTIAL

5G^U_W	5G UW. Your carrier's 5G UW network is available, which can include your carrier's higher frequency version of 5G. Supported models can connect to the internet over that network (not available in all countries or regions). See the Apple Support article Use 5G with your iPhone .
5G^E	5G E. Your carrier's 5G E network is available, and iPhone can connect to the internet over that network (not available in all countries or regions). See View or change cellular data settings on iPhone .
LTE	LTE. Your carrier's LTE network is available, and iPhone can connect to the internet over that network (not available in all countries or regions). See View or change cellular data settings on iPhone .
4G	UMTS. Your carrier's 4G UMTS (GSM) or LTE network (depending on the carrier) is available, and iPhone can connect to the internet over that network (not available in all countries or regions). See View or change cellular data settings on iPhone .
3G	UMTS/EV-DO. Your carrier's 3G UMTS (GSM) or EV-DO (CDMA) network is available, and iPhone can connect to the internet over that network. See View or change cellular data settings on iPhone .
E	EDGE. Your carrier's EDGE (GSM) network is available, and iPhone can connect to the internet over that network. See View or change cellular data settings on iPhone .
G	GPRS/1xRTT. Your carrier's GPRS (GSM) or 1xRTT (CDMA) network is available, and iPhone can connect to the internet over that network. See View or change cellular data settings on iPhone .
SOS ■■■■	SOS only. Full service from your cellular provider isn't available, but emergency calls may be possible through other carrier networks (not available in all countries or regions). See Use SOS to contact emergency services on your iPhone .
	Emergency SOS via satellite. iPhone isn't connected to a cellular or Wi-Fi network, but you can contact emergency services via satellite. See Use Emergency SOS via satellite on your iPhone .
Wi-Fi	Wi-Fi calling. iPhone is set up for Wi-Fi calling. iPhone also displays a carrier name next to the icon. See Make calls using Wi-Fi on iPhone .
	Personal Hotspot connection. iPhone is connected to the internet through the Personal Hotspot of another device. See Join a Personal Hotspot .
VPN	VPN. iPhone is connected to a network using VPN.
	Navigation. iPhone is providing turn-by-turn directions. See Get driving directions in Maps on iPhone .

DRAFT: APPLE CONFIDENTIAL

	Personal Hotspot. iPhone is providing a Personal Hotspot. See Share your internet connection from iPhone .
	Phone call. iPhone is on a phone call. See Make a call on iPhone .
	FaceTime. iPhone is on a FaceTime call. See Make FaceTime calls on iPhone .
	Screen recording. iPhone is recording your screen. See Take a screenshot on iPhone .
	Camera in use. An app is using your camera. See iPhone camera basics .
	Microphone in use. An app is using your microphone. See Make a basic recording .
	Syncing. iPhone is syncing with your computer. See Sync supported content .
	Network activity. Shows that there's network activity. Some third-party apps may also use it to show an active process.
	Call forwarding. Call forwarding is set up. See Set up call forwarding and call waiting on iPhone .
	Lock. iPhone is locked. See Wake and unlock iPhone .
	Do Not Disturb. Do Not Disturb is turned on. See Turn on or schedule a Focus on iPhone .
	Portrait orientation lock. The iPhone screen is locked in portrait orientation. See Change or lock the screen orientation on iPhone .
	Location services. An app is using Location Services. See Control the location information you share on iPhone .
	Alarm. An alarm is set. See Set an alarm in Clock on iPhone .
	Headphones connected. iPhone is paired with Bluetooth® headphones that are turned on and within Bluetooth range. See Set up and listen to Bluetooth headphones .
	Battery. Shows the iPhone battery level. When the icon is yellow, Low Power Mode is on. See Monitor the iPhone battery level .

DRAFT: APPLE CONFIDENTIAL



Battery charging. Shows the iPhone battery is charging. See [Charge the iPhone battery](#).



Bluetooth battery. Shows the battery level of a paired Bluetooth device. See [Set up and use Bluetooth accessories on iPhone](#).



AirPlay. AirPlay is on. See [Wirelessly stream videos and photos to Apple TV or a smart TV from iPhone](#).



Voice Control. Voice Control is turned on in Settings > Accessibility. See [Use Voice Control to interact with iPhone](#).



TTY. Software RTT / TTY or Hardware TTY is turned on. See [Set up and use RTT and TTY on iPhone](#).



CarPlay. iPhone is connected to CarPlay. See [Connect iPhone to CarPlay](#).



Siri Eyes Free. You can ask a question or make a request to Siri in your car. See [Use Siri in your car](#).

Charge and monitor the battery

Charge the iPhone battery

iPhone has an internal, lithium-ion rechargeable battery, which currently provides the best performance for your device. Compared with traditional battery technology, lithium-ion batteries are lighter, charge faster, last longer, and have a higher power density for more battery life.

To understand how your battery works so you can get the most out of it, see the [Apple Lithium-ion Batteries website](#).

About charging the battery



The battery icon in the top-right corner shows the battery level or charging status. When you're syncing or using iPhone, it may take longer to charge the battery.

If iPhone is very low on power, it may display an image of a nearly depleted battery, indicating that it needs to charge for up to 10 minutes before you can use it. If iPhone is extremely low on power when you begin to charge it, the display may be blank for up to 2 minutes before the low-battery image appears. See the Apple Support article [If your iPhone won't charge](#).

Charge the battery

To charge iPhone, do any of the following:

- Connect iPhone to a power outlet using the charging cable (included) and an Apple USB power adapter (sold separately). See [Power adapters for iPhone](#).

DRAFT: APPLE CONFIDENTIAL

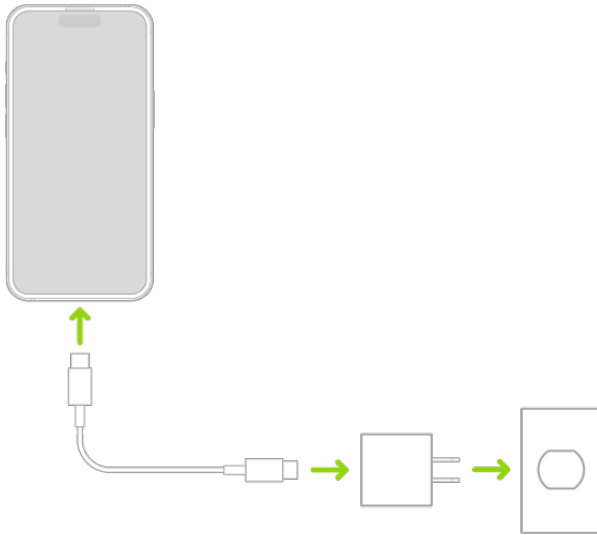

- Place iPhone face up on MagSafe Charger or MagSafe Duo Charger (connected to Apple 20W USB-C power adapter or other compatible power adapter) or on a Qi-certified charger. (MagSafe Charger, MagSafe Duo Charger, power adapters, and Qi-certified chargers are sold separately.) See [MagSafe chargers and battery packs for iPhone](#) and [Qi-certified wireless chargers for iPhone](#).

Note: You can also use third-party power adapters and Qi-certified chargers that are compliant with applicable country regulations and international and regional safety standards. See “Charging” in [Important safety information for iPhone](#).

- [Connect iPhone and your computer with a cable.](#)

Make sure your computer is turned on—if iPhone is connected to a computer that’s turned off, the battery may drain instead of charge. Look for ⚡ on the battery icon to make sure your iPhone is charging.

Note: Don’t try to charge your iPhone by connecting it to your keyboard, unless your keyboard has a high-power USB port.

Connecting iPhone to a power outlet or placing it on a wireless charger can start an iCloud backup or wireless computer syncing. See [Back up iPhone](#) and [Sync supported content](#).

WARNING: If you suspect there may be liquid in the charging port of iPhone, don’t plug the charging cable into it. For information about exposure to liquid, and other important safety information about the battery and charging iPhone, see [Important safety information for iPhone](#).

Optimize iPhone battery charging

iPhone has a setting that helps slow the rate of your battery's aging by reducing the time it spends fully charged. This setting uses machine learning to understand your daily charging routine, then waits to finish charging past 80% until you need it.

1. Go to Settings  > Battery > Battery Health & Charging.
2. Turn on Optimized Battery Charging .

If optimized charging doesn't start when expected, see the Apple Support article [About Optimized Battery Charging on your iPhone](#).

Battery life and charge cycles vary with use and settings. To learn how to maximize your battery's performance and lifespan, see the Apple Support article [iPhone Battery and Performance](#).

The iPhone battery should be serviced or recycled by Apple or an Apple Authorized Service Provider. See the [Battery Service and Recycling website](#).

Charge iPhone with cleaner energy sources (U.S. only)

With Clean Energy Charging, iPhone uses a forecast of the carbon emissions in your local energy grid to charge during times of cleaner energy production. iPhone learns from your daily charging routine so it can reach full charge before you need to use it.

Turn on Clean Energy Charging

1. Go to Settings  > Battery.
 2. Tap Battery Health & Charging, then turn on Clean Energy Charging
-

Show the iPhone battery percentage

You can view how much charge remains in your iPhone battery in the status bar. You can also add a widget to the Home Screen to monitor the battery levels of your iPhone and connected accessories (including AirPods and other devices).

DRAFT: APPLE CONFIDENTIAL

See the iPhone battery percentage in the status bar

Go to Settings  > Battery, then turn on Battery Percentage.

On an iPhone with Face ID, the battery percentage appears inside the battery symbol on the status bar.

Tip: On iPhone models with Face ID, you can also swipe down from the top-right corner to quickly view the battery percentage in Control Center.

Add a Batteries widget to your Lock Screen or Home Screen

See [Add a widget to your Home Screen](#) and [Create a custom iPhone Lock Screen](#).

Check the iPhone battery health and usage

You can view information about your iPhone battery health and learn how your iPhone usage affects the battery level.

Review your iPhone battery health

Go to Settings  > Battery, then tap Battery Health & Charging.

iPhone displays information about your battery's capacity, peak performance, and whether your battery needs to be serviced.

View your battery usage information

Go to Settings  > Battery.

Information about your battery usage and activity appears for the last 24 hours and up to the last 10 days.

- *Insights and suggestions:* You might see insights about conditions or usage patterns that cause iPhone to consume energy. You might also see suggestions for lowering energy consumption. If a suggestion appears, you can tap it to go to the corresponding setting.
- *Last Charged:* Indicates how fully the battery was last charged and the time it was disconnected.
- *Battery Level graph (in Last 24 Hours):* Shows the battery level, charging intervals, and periods when iPhone was in Low Power Mode or the battery was critically low.

DRAFT: APPLE CONFIDENTIAL

- *Battery Usage graph (in Last 10 Days)*: Shows the percentage of battery used each day.
- *Activity graph*: Shows activity over time, split by whether the screen was on or off.
- *Screen On and Screen Off*: Shows total activity for the selected time interval, for when the screen was on and when it was off. The Last 10 Days view shows the average per day.
- *Battery Usage by App*: Shows the proportion of the battery used by each app in the selected time interval.
- *Activity by App*: Shows the amount of time each app was used in the selected time interval.

Note: To see battery information for a specific hour or day, tap that time interval in the graph. To deselect it, tap outside the graph.

Battery life and charge cycles vary with use and settings. To learn how to maximize your battery's performance and lifespan, see the Apple Support article [iPhone Battery and Performance](#).

The iPhone battery should be serviced or recycled by Apple or an Apple Authorized Service Provider. See the [Battery Service and Recycling website](#).

Use Low Power Mode to reduce power usage on iPhone

Low Power Mode reduces the amount of power that your iPhone uses when the battery gets low. It optimizes performance for essential tasks like making and receiving calls, sending and receiving email and messages, accessing the internet, and more. On an iPhone model with ProMotion display technology, Low Power Mode limits the display refresh rate to 60 frames per second.





Note: Your iPhone might perform some tasks more slowly when in Low Power Mode.

If iPhone switches to Low Power Mode automatically, it turns off Low Power Mode after charging to 80%.



Turn Low Power Mode on or off

Low Power Mode automatically turns on when the battery level is low and automatically turns off when the battery is charged to a certain level.

To manually turn Low Power Mode on or off, use any of the following methods:

- *In Settings:* Go to Settings  > Battery.
 - *In Control Center:* Open Control Center, then tap .
(If you don't see , add it to Control Center—go to Settings  > Control Center, then tap  next to Low Power Mode.)
-

Bookmark or download the iPhone User Guide

You can read the iPhone User Guide in the Safari app , or download it to the Books app  so you can read it even when you're offline.

View and bookmark the user guide in Safari

In Safari, go to <https://support.apple.com/guide/iphone>.

To view the user guide in a different language, scroll down to the bottom of the page, tap the country or region link (United States, for example), then choose a country or region.

Tip: For quick access, add the guide as a shortcut on your Home Screen or as a bookmark in Safari. Tap , then choose any of the following:

- *Add to Home Screen:* The shortcut appears as a new icon on the Home Screen.
 - *Add Bookmark:* The bookmark appears when you tap  in Safari.
-

Download the user guide from Apple Books

If you [download the guide](#) from Apple Books (where available), you can read it even when iPhone isn't connected to the internet.





1. Open the Books app .
 2. Tap Search, tap the search field, then enter "iPhone User Guide."
 3. Tap Get, then wait for the book to download.
-

Basics

Learn gestures for iPhone

Learn basic gestures to interact with iPhone

Control iPhone and its apps using a few simple gestures—tap, touch and hold, swipe, scroll, and zoom.

Symbol	Gesture
	Tap. Briefly touch an item on the screen with one finger. For example, to open an app, tap its icon on the Home Screen.
	Touch and hold. Press an item on the screen until something happens. For example, if you touch and hold the wallpaper of the Home Screen, the app icons begin to jiggle.
	Swipe. Move one finger across the screen quickly. For example, swipe left on the Home Screen to see more apps.
	Scroll. Move one finger across the screen without lifting. For example, in Photos, you can drag a list up or down to see more. Swipe to scroll quickly; touch the screen to stop scrolling.
	Zoom. Place two fingers on the screen near each other. Spread them apart to zoom in, or move them toward each other to zoom out. You can also double-tap a photo or webpage to zoom in, and double-tap again to zoom out. In Maps, double-tap and hold, then drag up to zoom in or drag down to zoom out.

Learn gestures for iPhone models with Face ID

Here's a handy reference to the gestures you use for interacting with an iPhone that has Face ID.

Gesture	Description

DRAFT: APPLE CONFIDENTIAL



Go Home. Swipe up from the bottom edge of the screen to return to the Home Screen at any time. See [Open apps on iPhone](#).



Quickly access controls. Swipe down from the top-right corner to open Control Center; touch and hold a control to reveal more options. To add or remove controls, go to Settings  > Control Center. See [Use and customize Control Center on iPhone](#).



Open the App Switcher. Swipe up from the bottom edge, pause in the center of the screen, then lift your finger. To browse the open apps, swipe right, then tap the app you want to use. See [Switch between open apps on iPhone](#).



Switch between open apps. Swipe right or left along the bottom edge of the screen to quickly switch between open apps. See [Switch between open apps on iPhone](#).

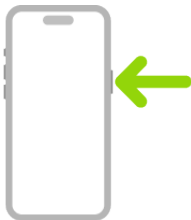

Use Siri. Just say, **|** "Siri" or "Hey Siri." Or hold down the side button while you ask a question or make a request, then release the button. See [Use Siri on iPhone](#).

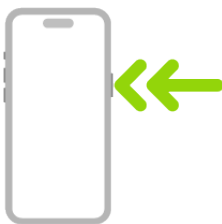

Use Apple Pay. Double-click the side button to display your default credit card, then glance at iPhone to authenticate with Face ID. See [Use Apple Pay for contactless payments on iPhone](#).



Use Accessibility Shortcut. Triple-click the side button. See [Quickly open features with Accessibility Shortcut on iPhone](#).

DRAFT: APPLE CONFIDENTIAL

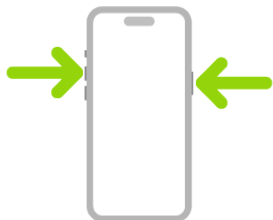

Take a screenshot. Simultaneously press and quickly release the side button and volume up button. See [Take a screenshot with an iPhone that has Face ID](#).

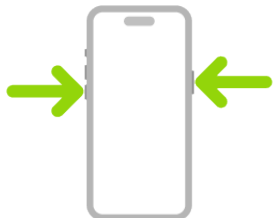

Use Emergency SOS (all countries or regions except India). Simultaneously press and hold the side button and either volume button until the sliders appear and the countdown on Emergency SOS ends, then release the buttons. See [Quickly call emergency services \(all countries or regions except India\)](#).



Use Emergency SOS (in India). Quickly press the side button 3 times until the sliders appear and the countdown on Emergency SOS ends.

If you've turned on Accessibility Shortcut, simultaneously press and hold the side button and either volume button until the sliders appear and the countdown on Emergency SOS ends, then release the buttons.

See [Quickly call emergency services \(India\)](#).

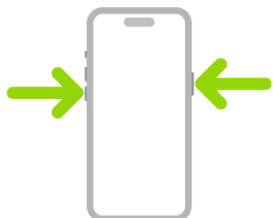

Turn off. Simultaneously press and hold the side button and either volume button until the sliders appear, then drag the top slider to power off. Or go to Settings > General > Shut Down. See [Turn off iPhone](#).

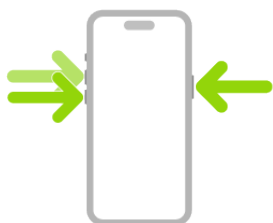

Force restart. Press and release the volume up button, press and release the volume down button, then press and hold the side button until the Apple logo appears. See [Force restart iPhone](#).

Adjust the volume on iPhone

When you're on the phone or listening to songs, movies, or other media on iPhone, you can use the buttons on the side of your device to adjust the audio volume. Otherwise, the buttons control the volume for the ringer, alerts, and other sound effects. You can also use Siri to turn the volume up or down.

Siri: Say something like: "Turn up the volume" or "Turn down the volume." [Learn how to use Siri](#).

DRAFT: APPLE CONFIDENTIAL

WARNING: For information about avoiding hearing loss, see [Important safety information for iPhone](#).



Lock the ringer and alert volumes in Settings

1. Go to Settings .
2. Tap Sounds & Haptics.
3. Turn off Change with Buttons.

Adjust the volume in Control Center

When iPhone is locked or when you're using an app, you can adjust the volume in Control Center.

Open Control Center, then drag .

Reduce loud headphone sounds

1. Go to Settings  > Sounds & Haptics > Headphone Safety.
2. Turn on Reduce Loud Sounds, then drag the slider to specify the maximum volume.

Note: If you [set up Screen Time for a family member](#), you can prevent them from changing the Reduce Loud Sounds level. Go to Settings > Screen Time > Content & Privacy Restrictions > Reduce Loud Sounds, turn on Content & Privacy Restrictions, tap Reduce Loud Sounds, then select Don't Allow.

Temporarily silence calls, alerts, and notifications

Open Control Center, tap Focus, then tap Do Not Disturb. (See [Set Do Not Disturb](#).)

Put iPhone in Silent mode

To put iPhone in Silent mode , set the Ring/Silent switch so that the switch shows orange (depending on your model). To turn off Silent mode, set the switch back.



Note: iPhone Y has an Action button instead of a Ring/Silent switch. The Action button can be used to turn Silent mode on or off, in addition to other functions. See [Customize the Action button on iPhone Y](#)

When Silent mode is off, iPhone plays all sounds. When Silent mode is on, iPhone doesn't ring or play alerts or other sound effects (but iPhone may still vibrate).

Important: Clock alarms, audio apps such as Music, and many games play sounds through the built-in speaker, even when Silent mode is on. In some countries or regions, the sound effects for Camera, Voice Memos, and Emergency Alerts are played, even when the Ring/Silent switch is set to silent.

On iPhone, there are several ways to protect your hearing from loud volume while listening to headphone audio. See [Use audiogram data in Health on iPhone](#).

Use your apps

Open apps on iPhone

You can quickly open apps from your Home Screen pages or your [App Library](#).

1. To go to the Home Screen, swipe up from the bottom edge of the screen (on an iPhone with Face ID) or press the Home button (on an iPhone with a Home button).

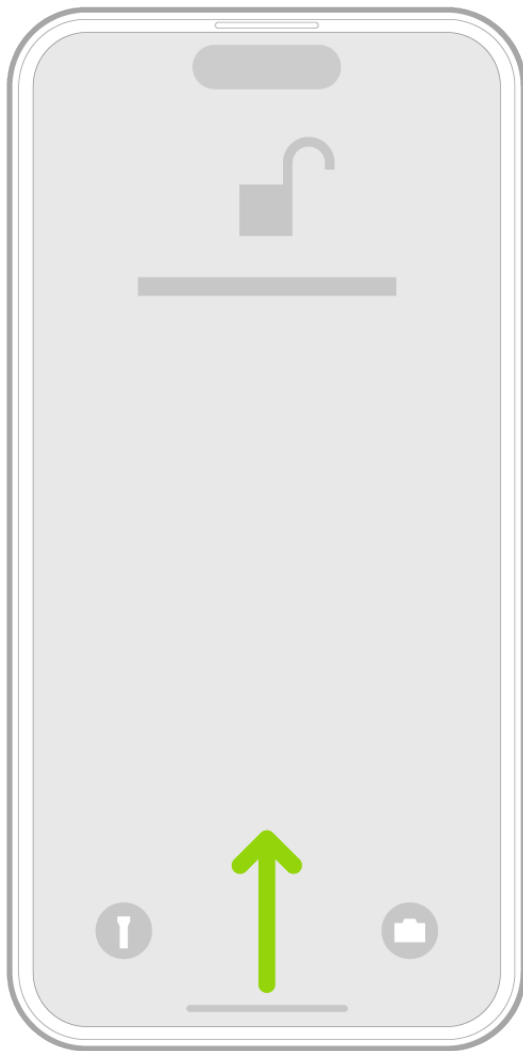

2. Swipe left to browse apps on other Home Screen pages.

DRAFT: APPLE CONFIDENTIAL

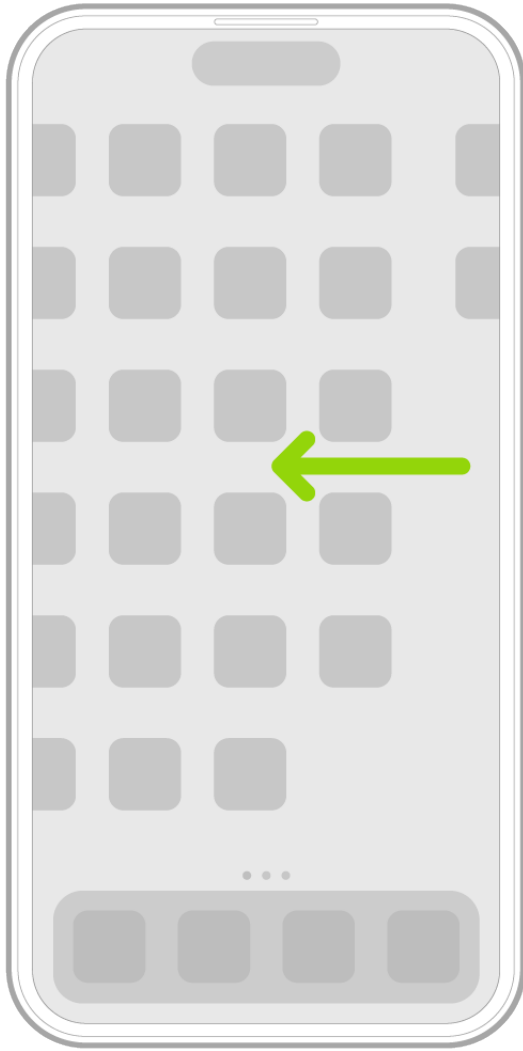

3. Swipe left past all your Home Screen pages to see App Library, where your apps are organized by category.
4. To open an app, tap its icon.
5. To return to App Library, swipe up from the bottom edge of the screen (on an iPhone with Face ID) or press the Home button (on an iPhone with a Home button).

Find your apps in App Library on iPhone

App Library shows your apps organized into categories, such as Social, Entertainment, and Productivity & Finance. The apps you use most are near the top of the screen and at the top level of their categories, so you can easily locate and open them.



Note: The apps in App Library are organized in categories intelligently, based on how you use your apps. You can add apps in App Library to the Home Screen, but you can't move them to another category in App Library.

Find and open an app in App Library

1. Go to the Home Screen, then swipe left past all your Home Screen pages to get to App Library.
2. Tap the search field at the top of the screen, then enter the name of the app you're looking for. Or scroll up and down to browse the alphabetical list.
3. To open an app, tap it.

If a category has a few small app icons, you can tap them to expand the category and see all the apps in it.

Hide and show Home Screen pages

Because you can find all of your apps in App Library, you might not need as many Home Screen pages for apps. You can hide some Home Screen pages, which brings App Library closer to your first Home Screen page. (When you want to see the hidden pages again, you can show them.)

1. Touch and hold the Home Screen until the apps begin to jiggle.
2. Tap the dots at the bottom of the screen.

Thumbnail images of your Home Screen pages appear with checkmarks below them.

3. To hide pages, tap to remove the checkmarks.

To show hidden pages, tap to add the checkmarks.

4. Tap Done (on an iPhone with Face ID) or press the Home button (on other iPhone models).

With the extra Home Screen pages hidden, you can go from the first page of the Home Screen to App Library (and back) with only one or two swipes.

Note: When Home Screen pages are hidden, new apps you download from the App Store may be added to App Library instead of the Home Screen.

Reorder Home Screen pages

If you have multiple Home Screen pages, you change their order. For example, you can gather together your favorite apps on one Home Screen page, and then make that your first Home Screen page.

1.  Touch and hold the Home Screen wallpaper until the apps begin to jiggle.
2. Tap the dots at the bottom of the screen.

Thumbnail images of your Home Screen pages appear with checkmarks below them.

3. To move each Home Screen page, touch and hold it, then drag it to a new position.
4. Tap Done twice (on an iPhone with Face ID) or press the Home button twice (on other iPhone models).

Change where new apps get downloaded

When you download new apps from the App Store, you can add them to the Home Screen and App Library, or to App Library only.

DRAFT: APPLE CONFIDENTIAL

1. Go to Settings  > Home Screen.
2. Choose whether to add new apps to both your Home Screen and App Library, or to App Library only.

Note: To allow app notification badges to appear on apps in App Library, turn on Show in App Library.

Move an app from App Library to the Home Screen

You can add an app in App Library to the Home Screen, unless it's already there.

Touch and hold the app, then tap Add to Home Screen (available only if the app isn't already on the Home Screen).

The app appears on the Home Screen and in App Library.

Switch between open apps on iPhone

Open the App Switcher to quickly switch from one open app to another on your iPhone. When you switch back, you can pick up right where you left off.

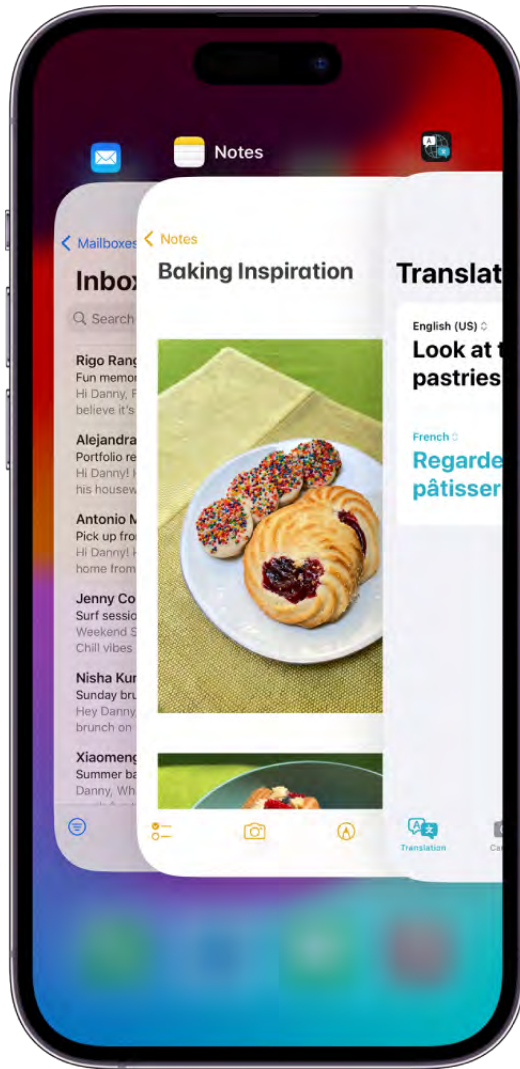

Use the App Switcher

1. To see all your open apps in the App Switcher, do one of the following:
 - *On an iPhone with Face ID:* Swipe up from the bottom of the screen, then pause in the center of the screen.
 - *On an iPhone with a Home button:* Double-click the Home button.
2. To browse the open apps, swipe right, then tap the app you want to use.

Switch between open apps

To quickly switch between open apps on an iPhone with Face ID, swipe right or left along the bottom edge of the screen.

Quit and reopen an app on iPhone

If an app isn't responding, you can quit it and then reopen it to try and resolve the issue. (Typically, there's no reason to quit an app; quitting it doesn't save battery power, for example.)

1. To quit the app, open the App Switcher, swipe right to find the app, then swipe up on the app.
 2. To reopen the app, go to the Home Screen (or [App Library](#)), then tap the app.
-

If quitting and reopening the app doesn't resolve the issue, try restarting iPhone.

Multitask with Picture in Picture on iPhone

With Picture in Picture, you can watch a video or use FaceTime while you use other apps.

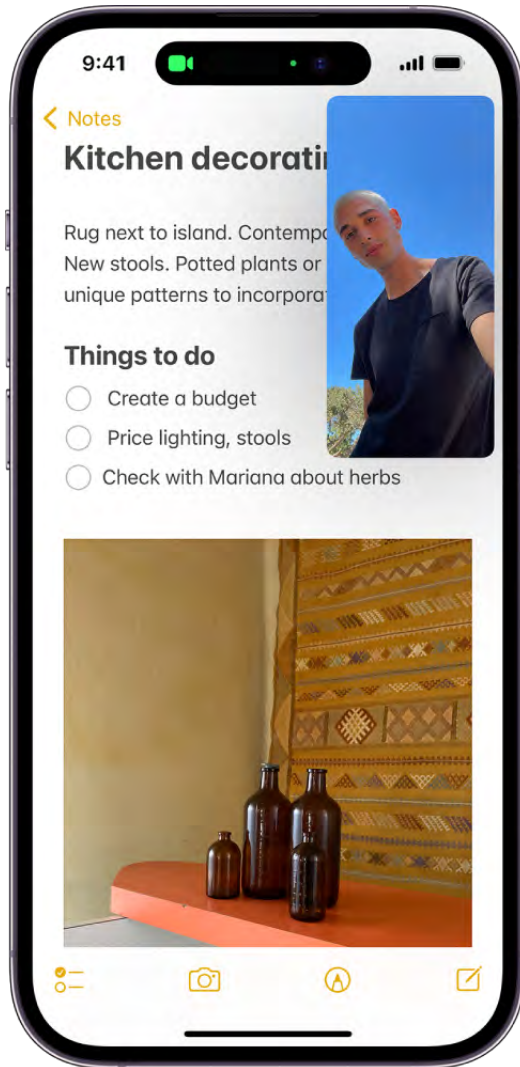

While watching a video, tap .

The video window scales down to a corner of your screen so you can see the Home Screen and open other apps. With the video window showing, you can do any of the following:

- *Resize the video window:* To make the small video window larger, pinch open. To shrink it again, pinch closed.
- *Show and hide controls:* Tap the video window.
- *Move the video window:* Drag it to a different corner of the screen.
- *Hide the video window:* Drag it off the left or right edge of the screen.
- *Close the video window:* Tap .

- *Return to a full video screen:* Tap  in the small video window.
-

Access features from the iPhone Lock Screen

The Lock Screen appears when you turn on or wake iPhone. From the Lock Screen, you can see notifications, open Camera and Control Center, get information from your favorite apps at a glance, control media playback, and more.

You can personalize your Lock Screen by adding features—choose a wallpaper, showcase a favorite photo, change the font of the date and time, add widgets, and more. See [Create a custom iPhone Lock Screen](#).



Access features and information from the Lock Screen

You can quickly access useful features and information from the Lock Screen, even while iPhone is locked. From the Lock Screen, do any of the following:

- *Open Camera:* Swipe left. On supported models, you can touch and hold , then lift your finger. (See [iPhone camera basics](#).)
- *Open Control Center:* Swipe down from the top-right corner (on an iPhone with Face ID) or swipe up from the bottom edge of the screen (on other iPhone models). (See [Use and customize Control Center on iPhone](#).)
- *See earlier notifications:* Swipe up from the center. (See [View and respond to notifications on iPhone](#).)
- *View more widgets:* Swipe right. (See [Add, edit, and remove widgets on iPhone](#).) You can interact with widgets on the Lock Screen and the Home Screen to perform tasks—for example, tap an item in the Reminders widget to check it off, or tap the Play button in the Podcasts widget to play an episode.
- *Control media playback:* Use the playback controls (Now Playing) on the Lock Screen to play, pause, rewind, or fast-forward media playing on your iPhone. (See [View and control Live Activities on the Lock Screen](#).)

To choose what you can access from the Lock Screen, see [Control access to information on the iPhone Lock Screen](#).

Show notification previews on the Lock Screen

1. Go to Settings  > Notifications.
2. Tap Show Previews, then tap Always.
3. Choose how you want notifications displayed on the Lock Screen:
 - *View just the number of notifications:* Select Count.
 - *View the notifications grouped into stacks by app:* Select Stack.
 - *View the notifications in a list:* Select List.

You can pinch the notifications on the Lock Screen to change the layout.

Notification previews can include text from Messages, lines from Mail messages, and details about Calendar invitations. See [View and respond to notifications on iPhone](#).

DRAFT: APPLE CONFIDENTIAL

View and control Live Activities on the Lock Screen

You can view Live Activities on your Lock Screen—including live sports updates, order updates, and media playing—so you can follow along right on your Lock Screen, even when you can't watch the entire event.

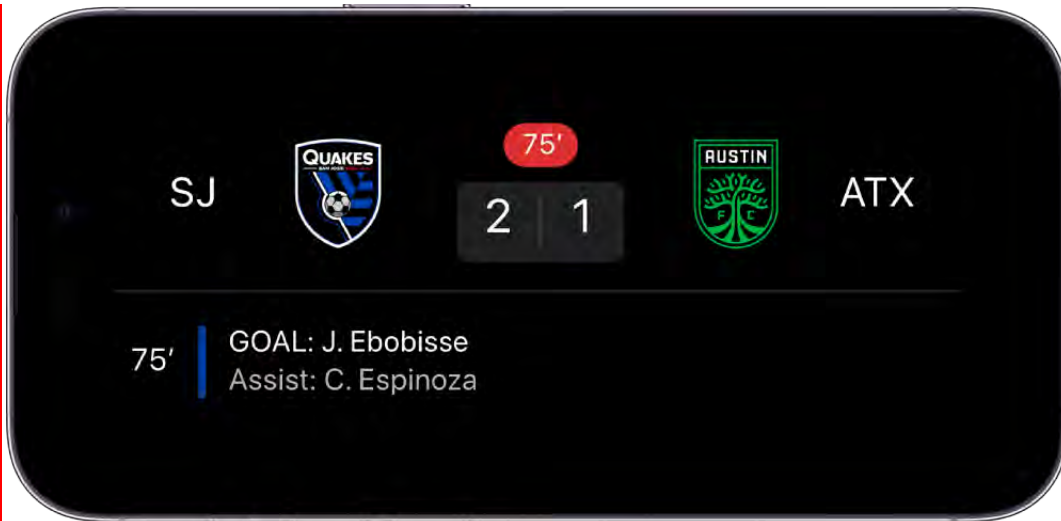

When you play music, a movie, or other media on your iPhone, you can use the playback controls (Now Playing) on your Lock Screen to play, pause, rewind, and fast-forward.

You can also control media playback on a remote device (such as your Apple TV or HomePod) from your iPhone Lock Screen.

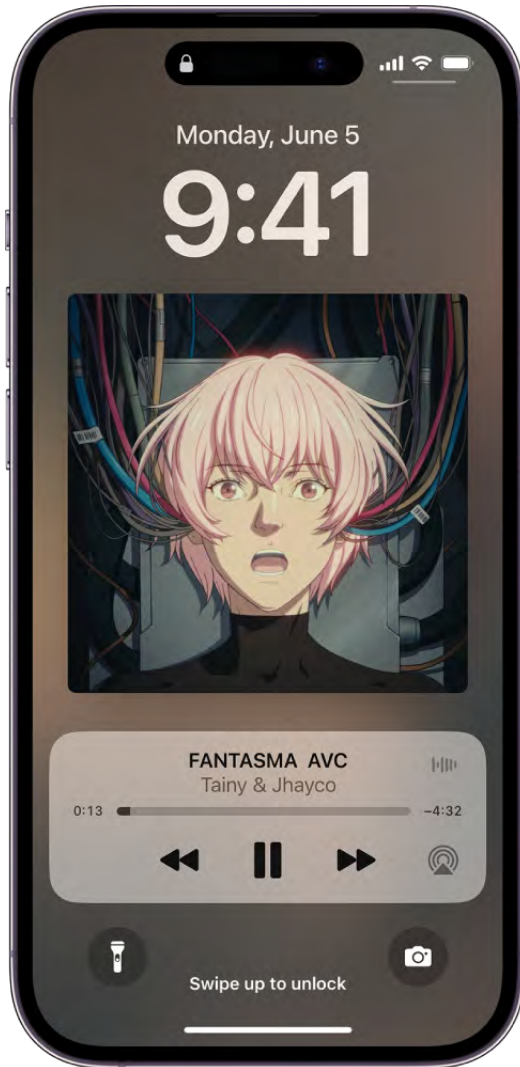

View Live Activities in the Dynamic Island on iPhone

On iPhone 14 Pro and later, you can check alerts and current activity in progress—such as a Voice Memo recording in progress, an AirDrop connection, and directions from Maps—in the Dynamic Island on the Home Screen or in any app. The Dynamic Island appears whenever your iPhone is unlocked.

DRAFT: APPLE CONFIDENTIAL

A Voice Memo
recording in progress

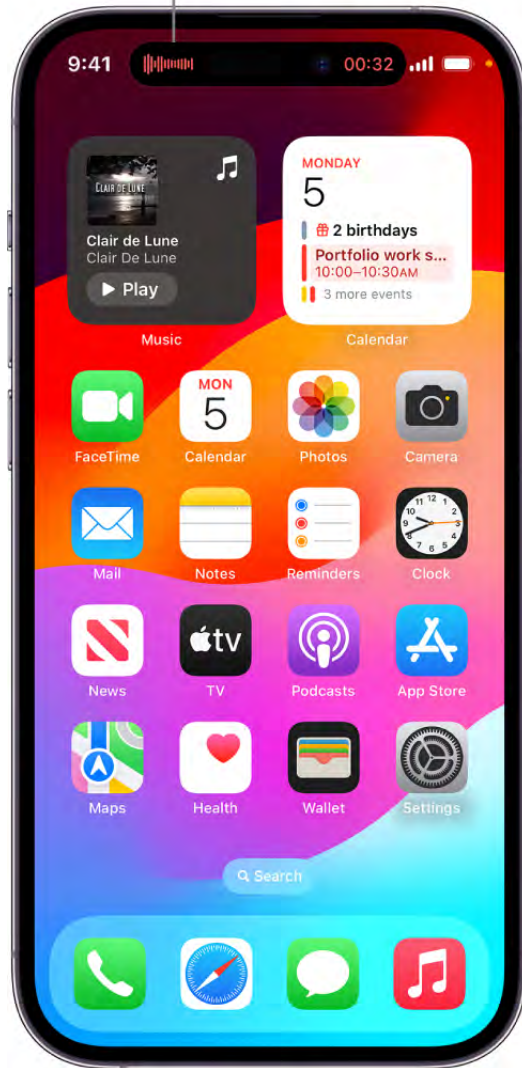

You can do any of the following in the Dynamic Island:

- *Expand the activity to see more detail:* Touch and hold the activity or swipe from the center to the right or left side.
- *Collapse the activity to make the Dynamic Island smaller:* Swipe from the right or left side toward the center.
- *Switch between two activities:* Swipe from one side or the other.

Perform quick actions on iPhone



On the Home Screen, in App Library, in Control Center, and in apps, you can use quick actions menus, see previews, and more.

Perform quick actions from the Home Screen and App Library

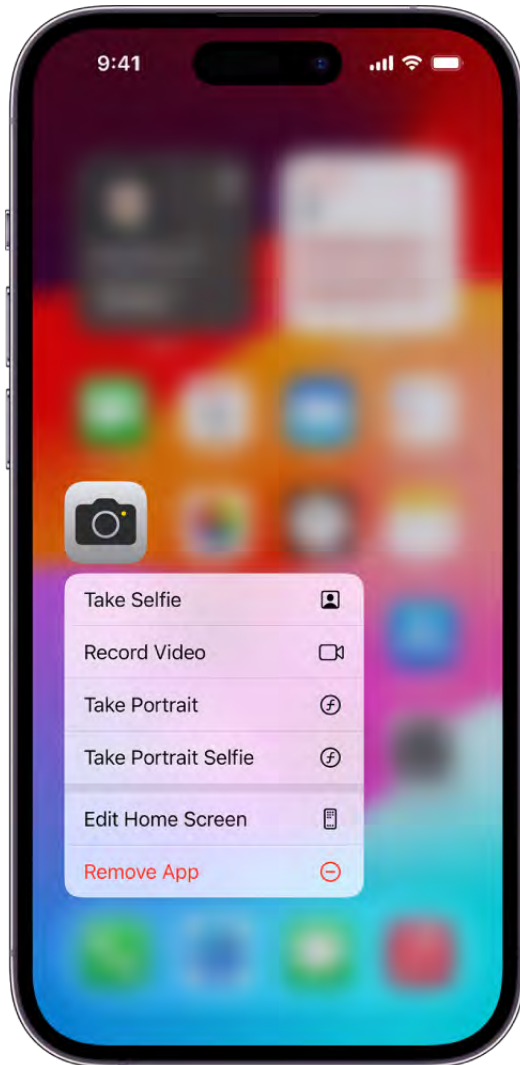
On the Home Screen and in App Library, touch and hold apps to open quick actions menus.



For example:

- Touch and hold Camera , then choose Take Selfie.
- Touch and hold Maps , then choose Send My Location.
- Touch and hold Notes , then choose New Note.

Note: If you touch and hold an app for too long before choosing a quick action, all of the apps begin to jiggle. Tap Done (on an iPhone with Face ID) or press the Home button (on other iPhone models), then try again.

See previews and other quick actions menus

- In Photos, touch and hold an image to preview it and see a list of options.
 - In Mail, touch and hold a message in a mailbox to preview the message contents and see a list of options.
 - Open Control Center, then touch and hold an item like Camera  or the brightness control to see options.
 - On the Lock Screen, touch and hold a notification to respond to it.
 - When typing, touch and hold the Space bar with one finger to [turn the onscreen keyboard into a trackpad](#).
-

Search with Spotlight on iPhone

On iPhone, you can search for apps and contacts, content in apps like Mail and Messages, and even text in your photos using Live Text. You can check stock and currency information, find and open webpages, apps, and images in your photo library, across your system, and on the web.

When you search for an app, app shortcuts for your most likely next action appear within the Top Hit. (For example, a shortcut to the Favorites album appears when you search for Photos.)

In Settings > Siri & Search, you can choose which apps you want to include in search results. Search offers suggestions based on your app usage, and updates results as you type.

Choose which apps to include in Search

1. Go to Settings  > Siri & Search.
 2. Scroll down, tap an app, then turn Show App in Search on or off.
-

Search with iPhone

1. Tap  at the bottom of the Home Screen (on models with Face ID) or swipe down on the Home Screen or the Lock Screen.
2. Enter what you're looking for in the search field.

3. Do any of the following:

- *Hide the keyboard and see more results on the screen:* Tap Search.
- *Open a suggested app:* Tap it.
- *Take quick action:* Start a timer, turn on a Focus, find the name of a song with Shazam, run any shortcut, and more. Search for an app's name to see shortcuts available for the app, or create your own using the Shortcuts app.
- *Check a suggested website:* Tap it.
- *Get more information about a search suggestion:* Tap it, then tap one of the results to open it.
- *Start a new search:* Tap  in the search field.

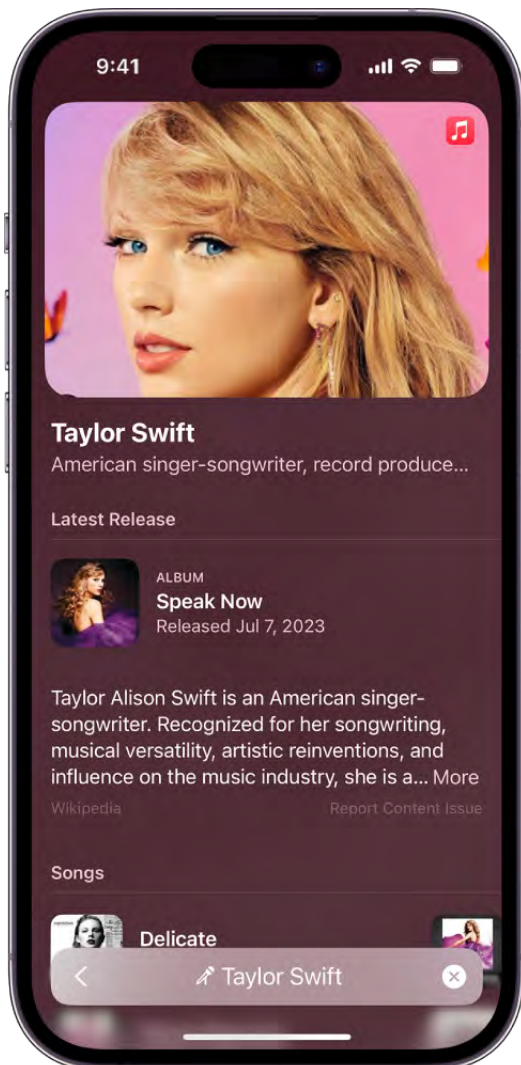

Turn off Location-Based Suggestions

1. Go to Settings  > Privacy & Security > Location Services.
2. Tap System Services, then turn off Suggestions & Search.

Search in apps

Many apps include a search field or a search button so you can find something within the app. For example, in the Maps app, you can search for a specific location.

1. In an app, tap the search field or .

If you don't see a search field or button, swipe down from the top.

2. Type your search, then tap Search.

Add a dictionary

On iPhone, you can add dictionaries, which can be used in searches.

1. Go to Settings  > General > Dictionary.
2. Select a dictionary.

Get information about your iPhone

View overall storage availability and storage used per app

Go to Settings  > General > iPhone Storage.

See the Apple Support articles [How to check the storage on your iPhone and iPad](#) and [Manage your iCloud storage](#).

See battery usage

Go to Settings  > Battery to see the elapsed time since iPhone was charged as well as battery usage by app.

You can also display battery level as a percentage, turn Low Power Mode on or off, and check your battery's health.

See [Monitor the iPhone battery level](#).

View call time and cellular usage

Go to Settings  > Cellular. See [View or change cellular data settings on iPhone](#).

See more information about iPhone

Go to Settings  > General > About. The items you can view include:

- Name
- iOS software version
- Model name
- Part and model numbers. To the right of Model, the part number appears. To see the model number, tap the part number.
- Serial number
- Number of songs, videos, photos, and apps
- Capacity and available storage space
- Wi-Fi and Bluetooth® addresses
- Cellular network
- Carrier settings. To the right of Carrier, the carrier settings version number appears. To see additional carrier-specific information, tap the version number. Contact your carrier for more details.
- IMEI (International Mobile Equipment Identity)
- ICCID (Integrated Circuit Card Identifier, or Smart Card) for GSM networks
- MEID (Mobile Equipment Identifier) for CDMA networks
- Modem firmware

To copy the serial number and other identifiers, touch and hold the identifier until Copy appears.

To see Legal & Regulatory information (including legal notices and license, warranty, and RF exposure information) and regulatory marks, go to Settings > General > Legal & Regulatory.

On supported models, you can also find the IMEI on the SIM card tray and the model number in the SIM tray opening.

View or turn off diagnostic information

Go to Settings  > Privacy & Security > Analytics & Improvements.

To help Apple improve products and services, iPhone sends diagnostic and usage data. This data doesn't personally identify you, but may include location information.

View or change cellular data settings on iPhone

You can turn cellular data and roaming on or off, set which apps and services use cellular data, see cellular data usage, and set other cellular data options.

Note: For help with cellular network services, voicemail, and billing, contact your wireless service provider.

If iPhone is connected to the internet using the cellular data network, an icon identifying the cellular network appears in the [status bar](#).

5G, LTE, 4G, and 3G service on GSM cellular networks support simultaneous voice and data communications. For all other cellular connections, you can't use internet services while you're talking on the phone unless iPhone also has a Wi-Fi connection to the internet. Depending on your network connection, you may not be able to receive calls while iPhone transfers data over the cellular network—when downloading a webpage, for example.

- *GSM networks:* On an EDGE or GPRS connection, incoming calls may go directly to voicemail during data transfers. For incoming calls that you answer, data transfers are paused.
- *CDMA networks:* On EV-DO connections, data transfers are paused when you answer incoming calls. On 1xRTT connections, incoming calls may go directly to voicemail during data transfers. For incoming calls that you answer, data transfers are paused.

Data transfer resumes when you end the call.

If Cellular Data is off, all data services—including email, web browsing, and push notifications—use Wi-Fi only. If Cellular Data is on, carrier charges may apply. For example, using certain features and services that transfer data, such as Siri and Messages, could result in charges to your data plan.

Choose cellular data options for data usage, performance, battery life, and more

To turn Cellular Data on or off, go to Settings  > Cellular.

To set options when Cellular Data is on, go to Settings > Cellular > Cellular Data Options, then do any of the following:

- *Reduce cellular usage:* Turn on Low Data Mode, or tap Data Mode, then choose Low Data Mode. This mode pauses automatic updates and background tasks when iPhone isn't connected to Wi-Fi.
- *Turn Data Roaming on or off:* Data Roaming permits internet access over a cellular data network when you're in a region not covered by your carrier's network. When you're traveling, you can turn off Data Roaming to avoid roaming charges.

Depending on your iPhone model, carrier, and region, the following options may be available:

- *Turn Voice Roaming on or off:* (CDMA) Turn Voice Roaming off to avoid charges from using other carrier's networks. When your carrier's network isn't available, iPhone won't have cellular (data or voice) service.
- *Enable or disable 4G/LTE:* Using 4G or LTE loads internet data faster in some cases but may decrease battery performance. There may be options for turning off 4G/LTE or for selecting Voice & Data (VoLTE) or Data Only.

On iPhone 12 models and later with a 5G data plan, you can do the following:

- *Enable Smart Data mode to optimize battery life:* Tap Voice & Data, then choose 5G Auto. In this mode, your iPhone automatically switches to LTE when 5G speeds don't provide noticeably better performance.
- *Use higher-quality video and FaceTime HD on 5G networks:* Tap Data Mode, then choose Allow More Data on 5G.

Set up a Personal Hotspot to begin sharing the cellular internet connection from iPhone

1. Go to Settings  > Cellular, then turn on Cellular Data.
 2. Tap Set up Personal Hotspot, then follow the instructions in [Share your internet connection from iPhone](#).
-

Set cellular data use for apps and services

Go to Settings  > Cellular, then turn Cellular Data on or off for any app (such as Maps) or service (such as Wi-Fi Assist) that can use cellular data.

If a setting is off, iPhone uses only Wi-Fi for that service.

Note: Wi-Fi Assist is on by default. If Wi-Fi connectivity is poor, Wi-Fi Assist automatically switches to cellular data to boost the signal. Because you stay connected to the internet over cellular when you have a poor Wi-Fi connection, you might use more cellular data, which may incur additional charges depending on your data plan. See the Apple Support article [About Wi-Fi Assist](#).

Lock your SIM card

If your device uses a SIM card for phone calls or cellular data, you can lock the card with a personal identification number (PIN) to prevent others from using the card. Then, every time you restart your device or remove the SIM card, your card locks automatically, and you're required to enter your PIN. See [Use a SIM PIN for your iPhone or iPad](#).

Choose iPhone settings for travel

When you travel with iPhone, choose settings that comply with airline requirements. Some airlines let you keep your iPhone turned on if you switch to airplane mode. By default, Wi-Fi and Bluetooth® are disabled in airplane mode—you can't make calls, but you can listen to music, play games, watch videos, and use other apps that don't require network or phone connections.

To choose settings that minimize cellular charges when you travel, see [View or change cellular data settings on iPhone](#).

Turn on airplane mode

Open Control Center, then tap .



Tap to turn on airplane mode.



You can also turn airplane mode on or off in Settings . When airplane mode is on,  appears in the status bar.

Turn on Wi-Fi or Bluetooth while in airplane mode

If your airline allows it, you can use Wi-Fi or Bluetooth while in airplane mode.

1. Open Control Center, then turn on airplane mode.
2. Tap  to turn on Wi-Fi or  to turn on Bluetooth.

DRAFT: APPLE CONFIDENTIAL

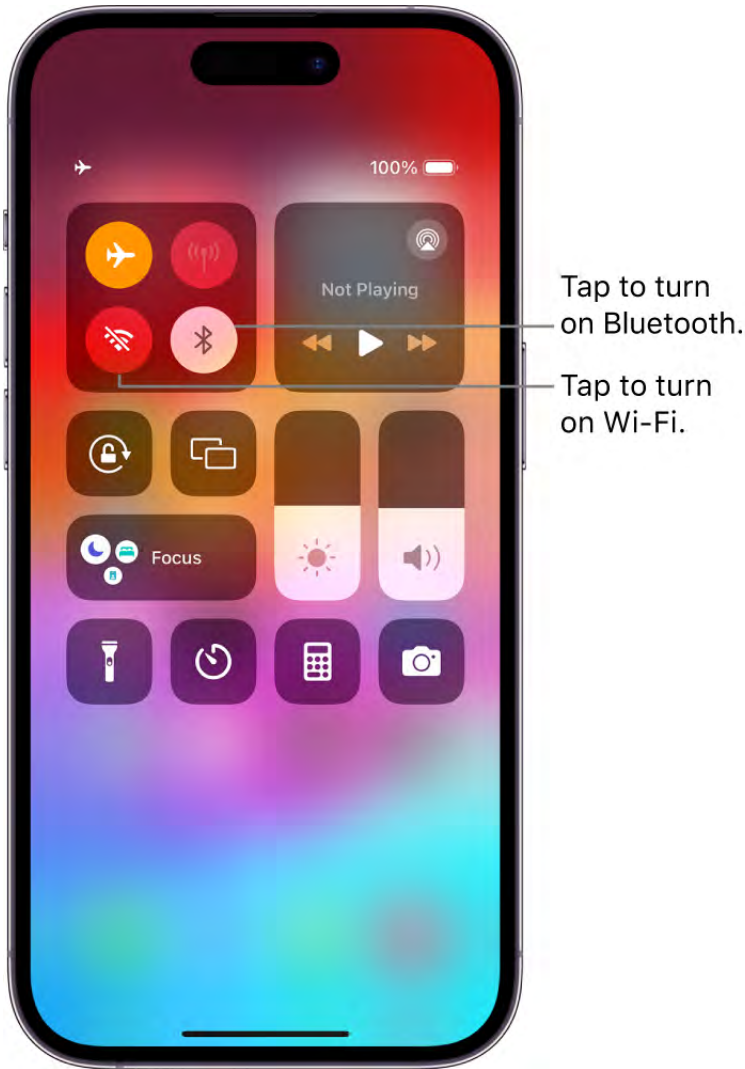

If you turn on Wi-Fi or Bluetooth while in airplane mode, it may be on the next time you return to airplane mode. You can turn it off again in Control Center.

DO NOT DISTRIBUTE

DRAFT: APPLE CONFIDENTIAL



Tap to turn off Bluetooth in airplane mode.

Tap to turn off Wi-Fi in airplane mode.

Personalize your iPhone

Change iPhone sounds and vibrations

In Settings , change the sounds iPhone plays when you get a call, text, voicemail, email, reminder, or other type of notification.

On supported models, you feel a tap—called *haptic feedback*—after you perform some actions, such as when you touch and hold the Camera icon on the Home Screen.

Set sound and vibration options

1. Go to Settings  > Sounds & Haptics.
2. To set the volume for all sounds, drag the slider below Ringtone and Alert Volume.
3. To set the tones and vibration patterns for sounds, tap a sound type, such as ringtone or text tone.
4. Do any of the following:
 - Choose a tone (scroll to see them all).

Ringtones play for incoming calls, clock alarms, and the clock timer; text tones are used for text messages, new voicemail, and other alerts.
 - Tap Vibration, then choose a vibration pattern, or tap Create New Vibration to create your own.

You can also change the sounds iPhone plays for certain people. Go to Contacts , tap a person's name, tap Edit, then choose a ringtone and text tone.

Turn haptic feedback off or on



1. On supported models, go to Settings  > Sounds & Haptics.
2. Turn System Haptics off or on.

When System Haptics is off, you won't hear or feel vibrations for incoming calls and alerts.

Have iPhone play a sound effect when it's turned on and off

On iPhone 14 or later, you can have iPhone play a sound when it's turned on and off.

1. Go to Settings  > Accessibility > Audio/Visual.
 2. Turn on Power On & Off Sounds.
-

Tip: If you're not receiving incoming calls and alerts when you expect them, open Control Center, then check whether Do Not Disturb is on. If  is highlighted, tap it to turn off Do Not Disturb. (When Do Not Disturb is on,  also appears in the status bar.)

Customize the Action button on D8y

D8y has an Action button in place of the Ring/Silent switch. You can choose which function you want the Action button to perform when you press it. Because the button is so accessible, it's useful for actions you perform often. (The location of the Action button is shown below.) It's easy to change the action when you decide you want to use it for a different function.

DRAFT: APPLE CONFIDENTIAL



Customize the Action button on iPhone Y

1. Go to Settings > Action Button.

An image of the side of the iPhone appears with icons representing actions you can assign to the Action button.











2. To choose an action, swipe to the action you want to use—its name appears below the dots.

Tip: To put iPhoneY in Silent mode, swipe to 

To choose another action, swipe to it.

3. If there are additional options for the selected action, tap  below your choice to see the list of options.

For some actions, such as Shortcuts and Accessibility, you need to select a specific option—otherwise the Action button will do nothing.

Icon	Action
	<i>Set Silent mode:</i> Turn Silent mode on or off.
	<i>Focus:</i> Turn a specific Focus on or off.
	<i>Camera:</i> Open the Camera app to quickly take a photo, selfie, video, portrait, or portrait selfie.
	<i>Flashlight:</i> Turn the flashlight on or off.
	<i>Voice Memo:</i> Start or stop recording a voice memo.
	<i>Magnifier:</i> Open the Magnifier app.
	<i>Shortcut:</i> Open an app or run your favorite shortcut.
	<i>Accessibility:</i> Quickly access your favorite accessibility feature.
No Action	Do nothing.

Create a custom iPhone Lock Screen

You can personalize your Lock Screen by choosing a wallpaper, showcasing a favorite photo, changing the font of the date and time, adding widgets, and more.

You can create more than one Lock Screen, [switch between Lock Screens](#), and even link a Lock Screen to a Focus. So, for example, you could set a specific Lock Screen for when you're working.

Personalize a new Lock Screen

DRAFT: APPLE CONFIDENTIAL

1. Touch and hold the Lock Screen until Customize and  appear at the bottom of the screen.

If they don't appear, touch and hold the Lock Screen again, then enter your passcode.

2. Tap  to create a new Lock Screen, or to make changes to a Lock Screen, swipe to the screen you want to change, tap Customize, then tap Lock Screen.

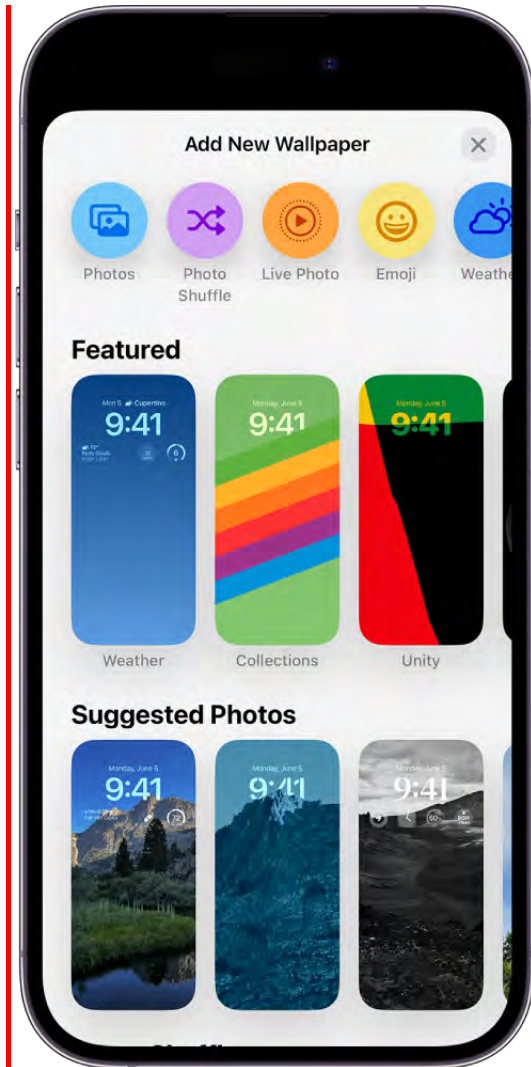

3. If you're creating a new Lock Screen, tap one of the wallpaper options to select it as your Lock Screen.

If you choose Photos or Photo Shuffle, see [Customize your Lock Screen photo](#).

4. Tap the time to change the font, color, and style.

Drag the slider to make the font heavier or lighter (available for solid fonts). To change the time, see [Change the date and time on iPhone](#).

DRAFT: APPLE CONFIDENTIAL

- To add widgets that include information such as today's headlines, the weather, and calendar events, tap Add Widgets, the date, or the field below the time. (See [Add, edit, and remove widgets on iPhone.](#))

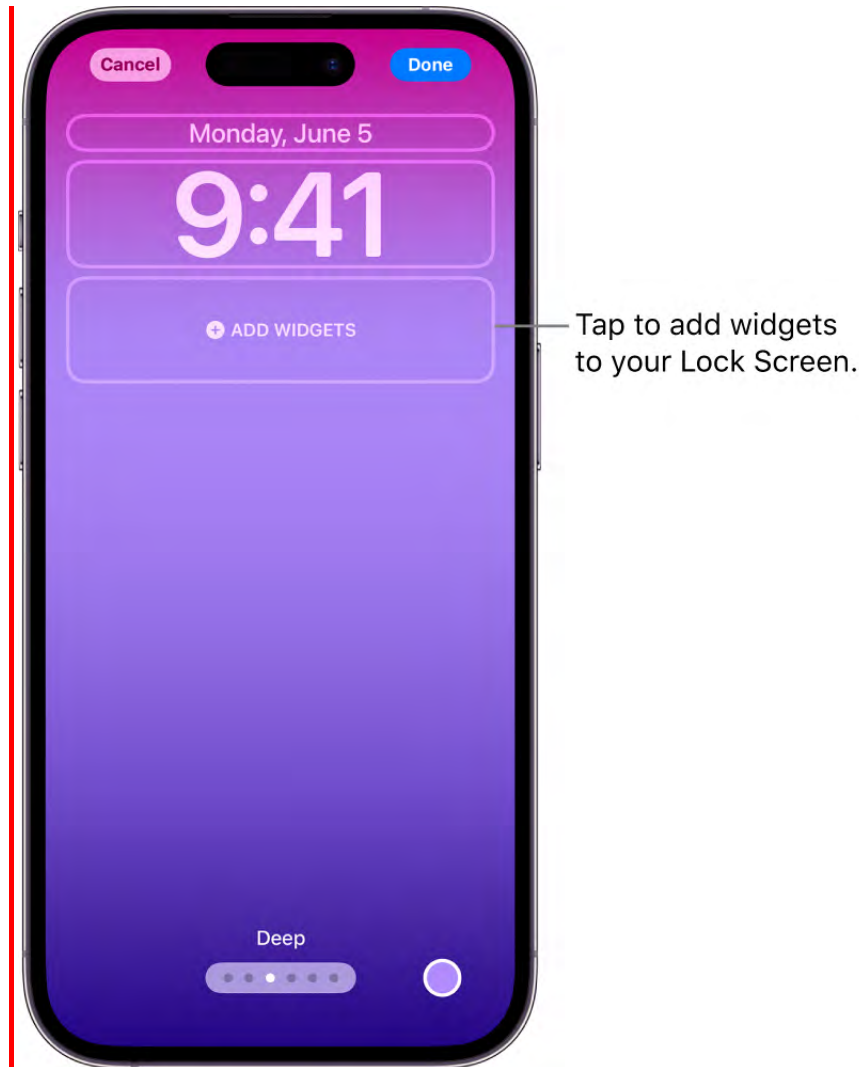

- Tap Add or Done, then tap Set as Wallpaper Pair or Customize Home Screen.
 - Choose whether to use the wallpaper on both the Lock Screen and Home Screen:* Tap Set as Wallpaper Pair.
 - Make further changes to the Home Screen:* Tap Customize Home Screen. Tap a color to change the wallpaper color, tap  to use a custom photo, or select Blur to blur the wallpaper so the apps stand out.



Customize your Lock Screen photo



If you choose a photo for your Lock Screen, you can reposition the photo, change the photo style, and more.

Do any of the following:

- *Reposition your photo:* To reposition your selected image, pinch open to zoom in on it, drag the image with two fingers to move it, then pinch closed to zoom out.
- *Change the photo style:* Swipe left or right to try different photo styles with complementary color filters and fonts.
- *Create a multilayered effect:* If you have a photo that supports layering—like an image with people, pets, or the sky—tap  at the bottom right, then choose Depth Effect.

Note: The multilayered effect is available on supported models. Layering may not be available if the subject is too high or too low, or if it obscures too much of the clock.

- *Create a motion effect with a Live Photo:* If you select a Live Photo that can be translated into slow motion, tap  at the bottom left to play the Live Photo when the device wakes up.
- *Set the shuffle frequency:* If you choose Photo Shuffle, you can preview the photos by tapping , and you can set the shuffle frequency by tapping  and then selecting an option below Shuffle Frequency.

Tip: Alternatively, you can add a photo directly from your photo library to your Home Screen and Lock Screen. In the Photos app , tap Library, select a photo, then tap . Scroll down and select Use as Wallpaper, tap Add, then choose whether to show it on both your Home Screen and Lock Screen.

Link a Focus to your Lock Screen

Focus helps you concentrate on a task by minimizing distractions. You can set up a Focus to temporarily silence all notifications, or allow only specific notifications (ones that apply to your task, for example). By linking a Focus to your Lock Screen, your Focus settings apply whenever you use that particular Lock Screen.

1. Touch and hold the Lock Screen until the Customize button appears at the bottom of the screen.
2. Tap Focus near the bottom of the wallpaper to see the Focus options—for example, Do Not Disturb, Personal, Sleep, and Work.
3. Select a Focus, then tap .

See [Set up a Focus](#).

Edit or change your Lock Screen

After you create a custom Lock Screen, you can make changes to it.

1. Touch and hold the Lock Screen until Customize and  appear at the bottom of the screen.

If they don't appear, touch and hold the Lock Screen again, then enter your passcode.
2. Swipe to the screen you want to change, tap Customize, then tap Lock Screen.
3. Tap the time to change the font, color, and style.
4. To add widgets that include information such as today's headlines, the weather, and calendar events, tap Add Widgets, the date, or the field below the time. (See [Add, edit, and remove widgets on iPhone](#).)
5. Tap Add or Done, then tap Set as Wallpaper Pair or Customize Home Screen.

Switch between Lock Screens

You can create multiple custom Lock Screens and switch between them throughout the day.

1. Touch and hold the Lock Screen until the Customize button appears at the bottom of the screen.
2. Swipe to the Lock Screen you want to use, then tap it.

Note: If a Lock Screen links to a specific Focus, switching from that Lock Screen to another also switches your Focus. See [Link a Focus to your Lock Screen](#).

Delete a Lock Screen

You can delete Lock Screens you no longer need.

1. Touch and hold the Lock Screen until the Customize button appears at the bottom of the screen.
2. Swipe to go to the Lock Screen you want to delete, swipe up on the screen, then tap .

Change the wallpaper on iPhone

On iPhone, you can change the wallpaper on the Lock Screen and the Home Screen. You can set your wallpaper in Settings or through the wallpaper gallery from your Lock Screen. See [Create a custom iPhone Lock Screen](#).

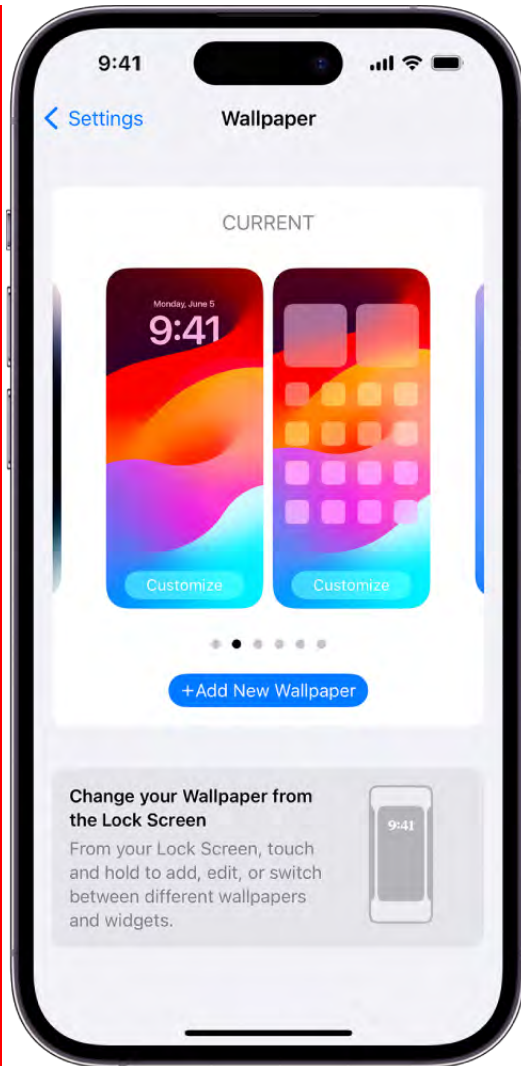

Change the wallpaper

1. Go to Settings  > Wallpaper, then tap Add New Wallpaper.

The wallpaper gallery appears.



2. Do one of the following:
 - Tap a button at the top of the wallpaper gallery—for example, Photos, People, Photo Shuffle, Emoji, or Weather—to design your wallpaper with a photo, an emoji pattern, a picture of your local weather, and more.
 - Tap a wallpaper option in one of the categories—for example, Featured, Suggested Photos, or Photo Shuffle.
 3. To customize a photo on your wallpaper, see [Customize your Lock Screen photo](#).
 4. Tap Add, then do one of the following:
 - *Choose whether to use the wallpaper on both the Lock Screen and Home Screen:* Tap Set as Wallpaper Pair.
 - *Make further changes to the Home Screen:* Tap Customize Home Screen. Tap a color to change the wallpaper color, tap  to use a custom photo, or select Blur to blur the wallpaper so the apps stand out.
-

Adjust the screen brightness and color on iPhone

On iPhone, you can make your screen dimmer or brighter (dimming the screen extends battery life). You can also adjust the screen brightness and color manually or automatically with Dark Mode, True Tone, and Night Shift.

Adjust the screen brightness manually

To make your iPhone screen dimmer or brighter, do one of the following:

- Open Control Center, then drag .
 - Go to Settings  > Display & Brightness, then drag the slider.
-

Adjust the screen brightness automatically



iPhone adjusts the screen brightness for current light conditions using the built-in ambient light sensor.

1. Go to Settings  > Accessibility.
2. Tap Display & Text Size, then turn on Auto-Brightness.

Turn Dark Mode on or off

Dark Mode gives the entire iPhone experience a dark color scheme that's perfect for low-light environments. With Dark Mode on, you can use your iPhone while, for example, reading in bed, without disturbing the person next to you.

Do any of the following:

- Open Control Center, touch and hold , then tap  to turn Dark Mode on or off.
- Go to Settings  > Display & Brightness, then select Dark to turn on Dark Mode, or select Light to turn it off.



Schedule Dark Mode to turn on and off automatically

You can set Dark Mode to turn on automatically at night (or on a custom schedule) in Settings.

1. Go to Settings  > Display & Brightness.
2. Turn on Automatic, then tap Options.
3. Select either Sunset to Sunrise or Custom Schedule.

If you choose Custom Schedule, tap the options to schedule the times you want Dark Mode to turn on and off.

If you select Sunset to Sunrise, iPhone uses the data from your clock and geolocation to determine when it's nighttime for you.

Turn Night Shift on or off

You can turn on Night Shift manually, which is helpful when you're in a darkened room during the day.

Open Control Center, touch and hold , then tap .

Schedule Night Shift to turn on and off automatically

Schedule Night Shift to shift the colors in your display to the warmer end of the spectrum at night and make viewing the screen easier on your eyes.

1. Go to Settings  > Display & Brightness > Night Shift.
2. Turn on Scheduled.
3. To adjust the color balance for Night Shift, drag the slider below Color Temperature toward the warmer or cooler end of the spectrum.
4. Tap From, then select either Sunset to Sunrise or Custom Schedule.

If you choose Custom Schedule, tap the options to schedule the times you want Night Shift to turn on and off.



If you select Sunset to Sunrise, iPhone uses the data from your clock and geolocation to determine when it's nighttime for you.

Note: The Sunset to Sunrise option isn't available if you turned off Location Services in Settings  > Privacy & Security, or if you turned off Setting Time Zone in Settings > Privacy & Security > Location Services > System Services.

Turn True Tone on or off

On supported models, True Tone automatically adapts the color and intensity of the display to match the light in your environment.

Do any of the following:

- Open Control Center, touch and hold , then tap  to turn True Tone on or off.
 - Go to Settings  > Display & Brightness, then turn True Tone on or off.
-

Keep the iPhone display on longer

The iPhone display stays on while you're looking at it, but it dims and eventually locks (for your security) when you look away for a while. If you need the display to stay on longer (for example, when you're navigating with Maps), you can change how long it takes iPhone to automatically dim and lock.

Change when iPhone automatically locks

You can set how long it takes iPhone to automatically lock.

Go to Settings  > Display & Brightness > Auto-Lock, then choose a length of time.

Keep your Lock Screen visible with Always On Display

On iPhone 14 Pro, iPhone 14 Pro Max, iPhone Y, and iPhone YY, the Always On Display setting allows a dimmed version of your Lock Screen to stay visible, even when your iPhone is locked, so you can glance at your Lock Screen to check essential information, like alerts, the date and time, and information in your widgets.

The display automatically turns off when iPhone is face down or obstructed from view, not near a paired Apple Watch, when a CarPlay session begins, while Continuity Camera is in use, while [Low Power Mode](#) is on, while [Sleep Focus](#) is on, or at your usual bedtime.

The Always On Display setting is on by default. To turn it off, go to Settings  > Display & Brightness, then turn off Always On Display.

Tip: When Always On Display is turned on, you can choose whether to show your wallpaper or notifications on your Lock Screen. In Settings > Display & Brightness > Always On Display, turn Show Wallpaper or Show Notifications on or off.

Use StandBy to transform the iPhone screen while charging

While iPhone is charging, you can turn it on its side to activate StandBy, which displays useful and timely information at a glance—from helpful widgets, to your favorite photos, to beautiful clocks—all visible from a distance. You can use StandBy to turn your iPhone into a bedside clock, a digital photo frame, a display for viewing widgets or Live Activities in full screen, and more.

Connect iPhone to a charger, turn it on its side (in landscape orientation), then tap the screen. You can swipe left or right to switch between widgets, photos, and clocks. You can swipe up or down to scroll between options for each of these views.



StandBy activates by default when iPhone is on its side while charging. To turn it off, go to Settings  > StandBy, then turn off StandBy.

When StandBy is on, the Always On setting is on, and Night Mode is on, StandBy adapts the screen to low ambient light at night and displays in a red tint so that it's not intrusive while you're sleeping.





Magnify the iPhone screen with Display Zoom

You can see larger onscreen controls on an iPhone with Display Zoom.

1. Go to Settings  > Display & Brightness > Display Zoom.
2. Select Larger Text to make all the text on iPhone larger.
3. Tap Done, then tap Use Zoomed.

Change the name of your iPhone

You can change the name of your iPhone, which is used by iCloud, AirDrop, your Personal Hotspot, and your computer.

1. Go to Settings  > General > About > Name.
2. Tap , enter a new name, then tap Done.

Change the date and time on iPhone

By default, the date and time, visible on the Lock Screen, are set automatically based on your location. If you want to change them—for example, when you're traveling—you can adjust them.

1. Go to Settings  > General > Date & Time.
 2. Turn on any of the following:
 - *Set Automatically*: iPhone gets the correct time over the network and updates it for the time zone you're in. Some networks don't support network time, so in some countries or regions, iPhone may not be able to automatically determine the local time.
 - *24-Hour Time*: (not available in all countries or regions) iPhone displays the hours from 0 to 23.
-

To change the default date and time, turn off Set Automatically, then change the date and time displayed.

Tip: To change the font color and style of the clock on the Lock Screen, see [Create a custom iPhone Lock Screen](#).

Change the language and region on iPhone

You choose the language and region of your iPhone during setup. If you travel or move, you can change the language or region.

1. Go to Settings  > General > Language & Region.
2. Set the following:
 - The language for iPhone
 - Your preferred form of address. (Choose feminine, masculine, or neutral. Turn on Share with All Apps so all apps personalize how they address you. Available for some primary languages, for example, Spanish.)

DRAFT: APPLE CONFIDENTIAL

- The region
 - The calendar format
 - The temperature unit (Celsius or Fahrenheit)
 - The measurement system (metric, US, or UK)
 - The first day of the week
 - Live Text (text you can select in images to copy or take action on)
3. To add another language and keyboard to your iPhone, tap Add Language, then select a language.
-

Customize the Home Screen

Organize your apps in folders on iPhone

You can organize your apps into folders to make them easier to find on your Home Screen pages.

Create folders

1. Touch and hold the Home Screen background until the apps begin to jiggle.
2. To create a folder, drag an app onto another app.
3. Drag other apps into the folder.

You can have multiple pages of apps in the folder.

4. To rename the folder, touch and hold it, tap Rename, then enter a new name.

If the apps begin to jiggle, tap the Home Screen background and try again.

5. When you're finished, tap Done, then tap the Home Screen background twice.

To delete a folder, tap the folder to open it, then drag all the apps out of it. The folder is automatically deleted.

Note: Organizing your apps on the Home Screen doesn't affect the organization of apps in the [App Library](#).

Move an app from a folder to the Home Screen

You can move an app from a folder to the Home Screen to make it easier to locate and open.

1. Go to the Home Screen page with the folder that contains the app, then tap the folder to open it.
 2. Touch and hold the app until the apps begin to jiggle.
 3. Drag the app from the folder to the Home Screen.
-

Add, edit, and remove widgets on iPhone



What are widgets?

Widgets are a way to view current information at a glance—today’s headlines, weather, reminders, battery levels, and more. You can view widgets in Today View and add them to your Home Screen or Lock Screen to keep this information at your fingertips.

You can also interact with widgets on the Home Screen and Lock Screen without opening the app—you can take action on the widgets for Music, Podcasts, Safari, Home, Contacts, and more. For example, tap  on the Music or Podcasts widget to play a selection.

Add a widget to your Home Screen

1. Go to the Home Screen page where you want to add the widget, then touch and hold the Home Screen background until the apps begin to jiggle.
2. Tap  at the top of the screen to open the widget gallery.
3. Scroll or search to find the widget you want, tap it, then swipe through the size options.

The different sizes display different information.

4. When you see the size you want, tap Add Widget.
5. While the apps are still jiggling, move the widget where you want it on the screen, then tap Done.

Note: You can also **add widgets to your Lock Screen**. To learn how, see [Personalize a new Lock Screen](#).

Tip: A Smart Stack (with dots next to it) is a set of widgets that uses information such as the time, your location, and activity to automatically display the most relevant widget at the appropriate time in your day. You can add a Smart Stack to the Home Screen, then swipe up and down through it to see the widgets it contains.

Interact with widgets

You can perform tasks on widgets on your Home Screen or Lock Screen. Tap an item in the Reminders widget to check it off, tap the Play button in the Podcasts widget to play an episode, or tap the Home widget to turn on your living room lights—all without opening an app.

Edit a widget on your Home Screen

You can customize most widgets right from your Home Screen so they display the information you want to see. For example, for a Mail widget, you can tap the mailbox shown in the widget, then choose a different mailbox so the messages in that mailbox are displayed in the widget. Or you can customize a Smart Stack to rotate through its widgets based on your activity, your location, the time of day, and so on.

1. On your Home Screen, touch and hold a widget to open the [quick actions](#) menu.
2. Tap Edit Widget if it appears (or Edit Stack, if it's a Smart Stack), then choose options.

DRAFT: APPLE CONFIDENTIAL

For a Smart Stack, you can turn Smart Rotate or Widget Suggestions off or on, reorder widgets by dragging them within the stack, drag a widget from the Smart Stack to the Home Screen, or remove a widget by tapping – in its upper-left corner.

When you turn on Widget Suggestions, suggested widgets for apps you already use automatically appear in your Smart Stack at the right time based on your past activity. An option lets you add the widget to your stack so it's always there when you need it.

3. Tap Done.

Remove a widget from the Home Screen

1. Touch and hold the widget to open the quick actions menu.
2. Tap Remove Widget (or Remove Stack), then tap Remove.

View widgets in Today View

To view widgets in Today View, swipe right from the left edge of the Home Screen, then scroll up and down.

Note: If the widgets don't appear when you swipe right on the Lock Screen, see [View widgets in Today View and Search when iPhone is locked](#).

View widgets in Today View and Search when iPhone is locked

1. Go to Settings  > Face ID & Passcode (on an iPhone with Face ID) or Touch ID & Passcode (on other iPhone models).
2. Enter your passcode.
3. Turn on Today View and Search (below Allow Access When Locked).

Move apps and widgets on the Home Screen on iPhone

You can change the layout of your Home Screen—move apps and widgets around or drag them to other Home Screen pages, temporarily hide Home Screen pages, change where new apps get downloaded, and more.

Tip: You can move all your apps and widgets related to a particular [Focus](#) (your Work Focus, for example) onto one Home Screen page, and make that page accessible during that Focus.

Move apps and widgets around on your iPhone

1. Touch and hold any app or widget on the Home Screen, then tap Edit Home Screen.

The apps begin to jiggle.

2. Drag an app to one of the following locations:

- Another location on the same page
- Another Home Screen page

Drag the app or widget to the right edge of the screen. You might need to wait a second for the new page to appear. The dots above the Dock show how many pages you have and which one you're viewing.

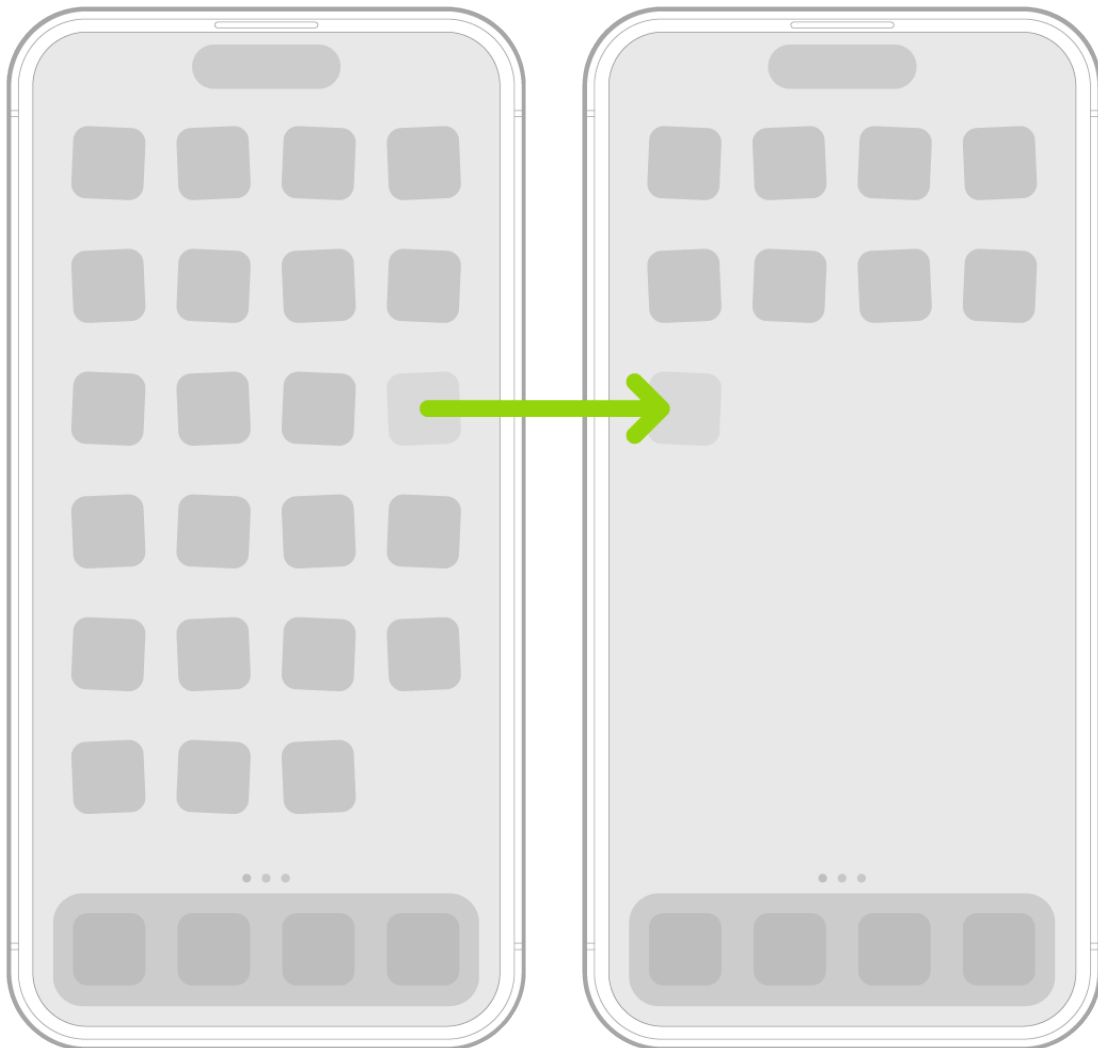

3. When you're finished, press the Home button (on an iPhone with a Home button) or tap Done (on other iPhone models).
-

DRAFT: APPLE CONFIDENTIAL

Reset the Home Screen and apps to their original layout

1. Go to Settings  > General > Transfer or Reset iPhone.
2. Tap Reset, tap Reset Home Screen Layout, then tap Reset Home Screen.

Any folders you've created are removed, and apps you've downloaded are arranged alphabetically after apps that came with your iPhone.

Remove apps from iPhone

You can easily remove apps from your iPhone. If you change your mind, you can download the apps again later.

Remove apps

Do any of the following:

- *Remove an app from the Home Screen:* Touch and hold the app on the Home Screen, tap Remove App, then tap Remove from Home Screen to keep it in App Library, or tap Delete App to delete it from iPhone.
- *Delete an app from App Library and Home Screen:* Touch and hold the app in App Library, tap Delete App, then tap Delete. (See [Find your apps in App Library](#).)

If you change your mind, you can [redownload apps](#) you've removed.

In addition to removing third-party apps from the Home Screen, you can remove the following built-in Apple apps that came with your iPhone:

- [Books](#)
- [Calculator](#)
- [Calendar](#)
- [Clock](#)
- [Compass](#)
- [Contacts](#) (Contact information remains available through Phone, Messages, Mail, FaceTime, and other apps. To remove a contact, you must restore Contacts.)

DRAFT: APPLE CONFIDENTIAL

- [FaceTime](#)
- [Files](#)
- [Find My](#) (Removing this app doesn't turn off location sharing or Find My for your device or items—it just removes the ability to view locations in the Find My app on that device.)
- [Fitness](#)
- [Freeform](#)
- [Health](#)
- [Home](#)
- [iTunes Store](#)
- [Magnifier](#)
- [Mail](#)
- [Maps](#)
- [Measure](#)
- [Music](#)
- [News](#)
- [Notes](#)
- [Podcasts](#)
- [Reminders](#)
- [Shortcuts](#)
- [Stocks](#)
- [Tips](#)
- [Translate](#)
- [TV](#)
- [Voice Memos](#)

DRAFT: APPLE CONFIDENTIAL

- [Wallet](#) (Removing this app doesn't delete cards and passes you stored in iCloud.)
- [Watch](#)
- [Weather](#)

Note: When you remove a built-in app from your Home Screen, you also remove any related user data and configuration files. Removing built-in apps from your Home Screen can affect other system functionality. See the Apple Support article [Delete built-in Apple apps on your iOS 12, iOS 13, or iPadOS device or Apple Watch](#).

Use and customize Control Center on iPhone



Control Center on iPhone gives you instant access to useful controls—including airplane mode, Do Not Disturb, a flashlight, volume, screen brightness—and apps.

Open Control Center

- *On an iPhone with Face ID:* Swipe down from the top-right edge. To close Control Center, swipe up from the bottom.
- *On an iPhone with a Home button:* Swipe up from the bottom. To close Control Center, swipe down or press the Home button.

Access more controls in Control Center

Many controls offer additional options. To see available options, touch and hold a control. For example, you can do the following in Control Center:





- Touch and hold the top-left group of controls, then tap  to open the AirDrop options.
- Touch and hold  to take a selfie, take a photo, or record a video.

DRAFT: APPLE CONFIDENTIAL



Add and organize controls

You can customize Control Center by adding more controls and shortcuts to many apps, such as Calculator, Notes, Voice Memos, and more.



1. Go to Settings  > Control Center.
2. To add or remove controls, tap  or  next to a control.
3. To rearrange controls, touch  next to a control, then drag it to a new position.

Temporarily disconnect from a Wi-Fi network

In Control Center, tap ; to reconnect, tap it again.



To see the name of the connected Wi-Fi network, touch and hold .

DRAFT: APPLE CONFIDENTIAL

Because Wi-Fi isn't turned off when you disconnect from a network, AirPlay and AirDrop still work, and iPhone joins known networks when you change locations or restart iPhone. To turn off Wi-Fi, go to Settings  > Wi-Fi. (To turn on Wi-Fi again in Control Center, tap .) For information about turning Wi-Fi on or off in Control Center while in airplane mode, see [Choose iPhone settings for travel](#).

Temporarily disconnect from Bluetooth devices

In Control Center, tap ; to allow connections, tap the button again.

Because Bluetooth® isn't turned off when you disconnect from devices, location accuracy and other services are still enabled. To turn off Bluetooth, go to Settings  > Bluetooth, then turn off Bluetooth. To turn on Bluetooth again in Control Center, tap . For information about turning Bluetooth on or off in Control Center while in airplane mode, see [Choose iPhone settings for travel](#).

Turn off access to Control Center in apps

Go to Settings  > Control Center, then turn off Access Within Apps.

Change or lock the screen orientation on iPhone

Many apps give you a different view when you rotate iPhone.



DRAFT: APPLE CONFIDENTIAL



Lock or unlock the screen orientation

You can lock the screen orientation so that it doesn't change when you rotate iPhone.

Open Control Center, then tap .

When the screen orientation is locked,  appears in the status bar (on supported models).

Set up Focus, notifications, and Do Not Disturb

View and respond to notifications on iPhone

Notifications help you keep track of what's new—they let you know if you missed a call, if the date of an event moved, and more. You can customize your notification settings so you see only what's important to you.

Unless you have notifications silenced with a [Focus](#), iPhone displays them as they arrive—they roll in from the bottom of the screen to minimize distraction. You can view them on the Lock Screen in an expanded list view, stacked view, or count view. Pinch the notifications on the Lock Screen to change the layout.

Note: While you're using an app, you might be asked how you want to receive notifications from it—immediately, not at all, or in a [scheduled summary](#). You can [change this setting](#) later in Settings > Notifications.

Find your notifications in Notification Center

To see your notifications in Notification Center, do any of the following:

- *On the Lock Screen:* Swipe up from the middle of the screen.
- *On other screens:* Swipe down from the top center. Then you can scroll up to see older notifications, if there are any.

To close Notification Center, swipe up from the bottom with one finger or press the Home button (on an iPhone with a Home button).

Respond to notifications

When you have multiple notifications in Notification Center or on the Lock Screen, they're grouped by app, which makes them easier to view and manage. Notifications from some apps may also be grouped by organizing features within the app, such as by topic or thread. Grouped notifications appear as small stacks, with the most recent notification on top.

Do any of the following:

- *To expand a group of notifications to see them individually:* Tap the group. To close the group, tap Show Less.

DRAFT: APPLE CONFIDENTIAL

- *To view a notification and perform quick actions if the app offers them (on supported models):* Touch and hold the notification.
 - *To open a notification's app:* Tap the notification.
-

Schedule a notification summary

You can reduce distractions in your day by scheduling your notifications to be delivered as a summary—you choose which notifications to include in the summary and what time you want to receive it.

The notification summary is personalized to you and intelligently ordered by priority, based on your current activity, with the most relevant notifications at the top. The summary is especially useful because it allows you to engage with notifications on your own time. You can take this even further by using [Focus](#) to filter notifications while you focus on an activity.

1. Go to Settings  > Notifications > Scheduled Summary, then turn on Scheduled Summary.
 2. Select the apps to include in your summary.
 3. Set a time for your summary. If you want to receive another summary, tap Add Summary.
 4. Tap A to Z below Apps in Summary, then make sure the apps you want to include in your summary are turned on.
-

View, dismiss, clear, and mute notifications

When notifications appear on your iPhone, do any of the following:

- *Handle a notification you receive while using another app:* Tap to view it, then swipe up to dismiss it.
- *Clear notifications:* Swipe left on a notification or group of notifications, then tap Clear or Clear All.
- *Mute notifications for an app:* Swipe left on the notification or group of notifications, tap Options, then tap an option to mute the app's notifications for an hour or a day. This sends them directly to Notification Center and prevents them from appearing on the Lock Screen, playing a sound, lighting up the screen, or presenting a banner.

To see and hear these notifications again, swipe left on the notification in Notification Center, tap Options, then tap Unmute.

DRAFT: APPLE CONFIDENTIAL

- *Turn off notifications for an app or notification group:* Swipe left on a notification or group of notifications, tap Options, then tap Turn Off.
- *Change how an app displays notifications:* Swipe left on a notification, tap Options, then tap View Settings. See [Change notification settings](#) to learn about the settings you can change.
- *Clear all your notifications in Notification Center:* [Go to Notification Center](#), tap , then tap Clear.
- *Silence all notifications:* Turn on Do Not Disturb. See [Turn on or schedule a Focus on iPhone](#).

When you haven't used an app for a while, you may see a suggestion that you turn off notifications for that app.

Show recent notifications on the Lock Screen

You can allow access to Notification Center on the Lock Screen.

1. Go to Settings  > Face ID & Passcode (on an iPhone with Face ID) or Touch ID & Passcode (on other iPhone models).
2. Enter your passcode.
3. Scroll down and turn on Notification Center (below Allow Access When Locked).

Change notification settings on iPhone

In Settings , choose which apps can send notifications, change the alert sound, set up location-based alerts, allow government alerts, and more.

Change notification settings

Most notification settings can be customized for each app. You can turn app notifications on or off, have notifications play a sound, choose how and where you want app notifications to appear when your device is unlocked, and more.

1. Go to Settings  > Notifications.
2. Choose how you want notifications displayed on the Lock Screen:
 - *View just the number of notifications:* Tap Count.

DRAFT: APPLE CONFIDENTIAL

- *View the notifications grouped into stacks by app:* Tap Stack.
- *View the notifications in a list:* Tap List.

When notifications arrive, you can change the layout by pinching the notifications on the Lock Screen.

3. To schedule a notification summary, tap Scheduled Summary, then turn on Scheduled Summary. (See [schedule a notification summary](#).)
4. To choose when you want notification previews to appear, tap Show Previews, select an option—Always, When Unlocked, or Never—then tap  at the top left.

Previews can include things like text (from Messages and Mail) and invitation details (from Calendar). You can override this setting for individual apps.

5. Tap an app below Notification Style, then turn Allow Notifications on or off.

If you turn on Allow Notifications, choose when you want the notifications delivered—immediately or in the scheduled notification summary—and turn Time Sensitive Notifications on or off.

For many apps, you can also set a notification banner style and turn sounds and badges on or off.

6. Tap Notification Grouping, then choose how you want the notifications grouped:
 - *Automatic:* The notifications from the app are grouped according to organizing criteria within the app, such as by topic or thread.
 - *By App:* All the notifications from the app are grouped together.
 - *Off:* Turn off grouping.

To turn off notifications selectively for apps, go to Settings > Notifications > Siri Suggestions, then turn off any app.

When you use Focus, it delays the delivery of notifications on iPhone to prevent interruptions. You can schedule a time to receive a summary of the notifications you missed. See [Schedule a notification summary](#).

Set up or turn off location-based alerts

Some apps use your location to send you relevant alerts based on where you are. For example, you might get a reminder to call someone when you get to a specific place or when you leave for your next location.

If you don't want to see these types of alerts, you can turn them off.

1. Go to Settings  > Privacy & Security > Location Services.
2. Turn on Location Services.
3. Tap an app (if any appear in the list), then choose whether you want to share your location while using that app.

See the Apple Support article [About privacy and Location Services](#).

Receive Web Push notifications from web apps

You can receive standard Web Push notifications from a web app when you [add its website icon to your Home Screen](#). Web Push notifications can keep you informed of activity in the app. After you subscribe for push notifications within the web app, the app can send you notification alerts and badges similar to the ones you get from other apps on your iPhone.

Get government alerts

In some countries or regions, you can turn on alerts in the Government Alerts list. For example, on iPhone in the United States, you can receive National Alerts, and you can turn AMBER, Public Safety, and Emergency Alerts (which include both Severe and Extreme Imminent Threat alerts) on or off (they're on by default). On iPhone in Japan, you can receive Emergency Earthquake Alerts from the Japan Meteorological Agency.

1. Go to Settings  > Notifications.
2. Scroll down to the Government Alerts section, then turn on the ones you want.

Government alerts vary by carrier and iPhone model, and may not work under all conditions. See the Apple Support article [About emergency and government alerts](#).

Set up a Focus on iPhone

Focus is a feature that helps you reduce distractions and set boundaries. When you want to concentrate on a specific activity, you can customize one of the provided Focus options—for example Work, Personal, or Sleep—or [create a custom Focus](#). You can use Focus to temporarily silence all notifications, or allow only specific notifications—ones that apply to your task, for example—and let other people and apps know you're busy.

DRAFT: APPLE CONFIDENTIAL

When a Focus is [linked to your Lock Screen](#), you can turn it on by simply swiping to the corresponding Lock Screen.

Likewise, you can [customize a Home Screen page](#) that has only apps related to a Focus and make that page your Home Screen during that Focus. iPhone also suggests Home Screen pages with apps and widgets that are relevant to the Focus you're setting up.

Tip: To quickly silence all notifications, open Control Center, tap Focus, then turn on Do Not Disturb.

Set up a Focus

1. Go to Settings  > Focus, then tap a Focus—for example, Do Not Disturb, Personal, Sleep, or Work.

For the Focus you select, you can set up the options described in the steps below, but you don't have to set up all of them.

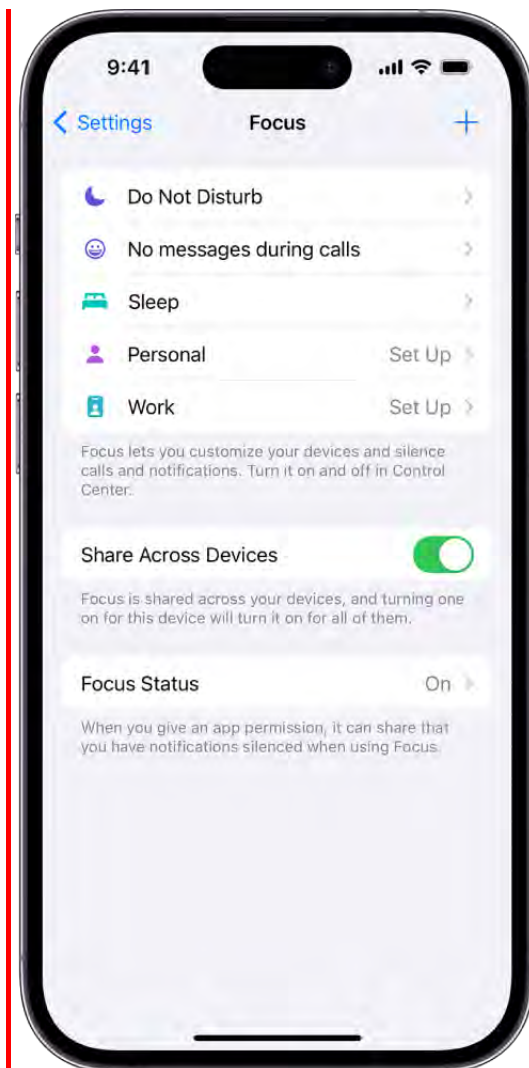

DRAFT: APPLE CONFIDENTIAL

2. Specify which apps and people can send you notifications during your Focus. See [Allow or silence notifications for a Focus on iPhone](#).

After you specify which people and apps to allow notifications from, an Options link appears.

3. Tap Options, then do any of the following:
 - *Show silenced notifications on the Lock Screen or send them to Notification Center*: Turn Show On Lock Screen on or off.
 - *Darken the Lock Screen during this Focus*: Turn on Dim Lock Screen.
 - *Hide notification badges on Home Screen apps*: Turn on Hide Notification Badges.
4. When you're finished selecting options, tap  at the top of the screen.
5. To change the Lock Screen to use with this Focus, tap the Lock Screen preview below Customize Screens, select a Lock Screen, then tap Done at the top of the screen.
6. To choose a Home Screen page to use with this Focus, tap the Home Screen preview below Customize Screens, select a page, then tap Done.

The Home Screen options that appear include the apps and widgets most relevant to the Focus you're setting up.

To make changes to the Home Screen to customize it further for your Focus, see [Move apps and widgets on the Home Screen](#).

7. To share your Focus across your Apple devices, tap , then turn on Share Across Devices (you must be signed in with the same Apple ID on all your devices).

After setting up your Focus, you can return to Settings > Focus at any time and change any of the options you chose above.

You can [schedule a Focus to turn on automatically](#) or [turn it on or off in Control Center](#).

When you set up a Sleep Focus, you can also change your next bedtime and wake-up time, or adjust your sleep schedule by tapping Set Up Sleep in Health. See [Set an alarm in Clock on iPhone](#) or [Add or change sleep schedules in Health on iPhone](#).

Add Focus filters

When you set up a Focus, you can add app filters that determine what information apps will show during the Focus. For example, you can choose which mail account or which calendar to use during the Focus.

DRAFT: APPLE CONFIDENTIAL

1. Go to Settings > Focus, then tap the Focus you want to add filters to.
 2. Scroll down to Focus filters, then tap Add Filter.
 3. Tap an app, then select the information from that app you want to use during the Focus:
 - *Calendar*: Choose which calendars you want to show during the Focus.
 - *Mail*: Choose which mail accounts you want to use during the Focus.
 - *Messages*: Choose which message conversations you want to see during the Focus—for example, only conversations from people you've allowed notifications from during this Focus.
 - *Safari*: Choose which Tab Group you want to use during the Focus.
 4. Tap Add to add the filter to the Focus.
-

Create a Custom Focus

If you want to concentrate on an activity that's different from any of the provided Focus options, you can create a Custom Focus.

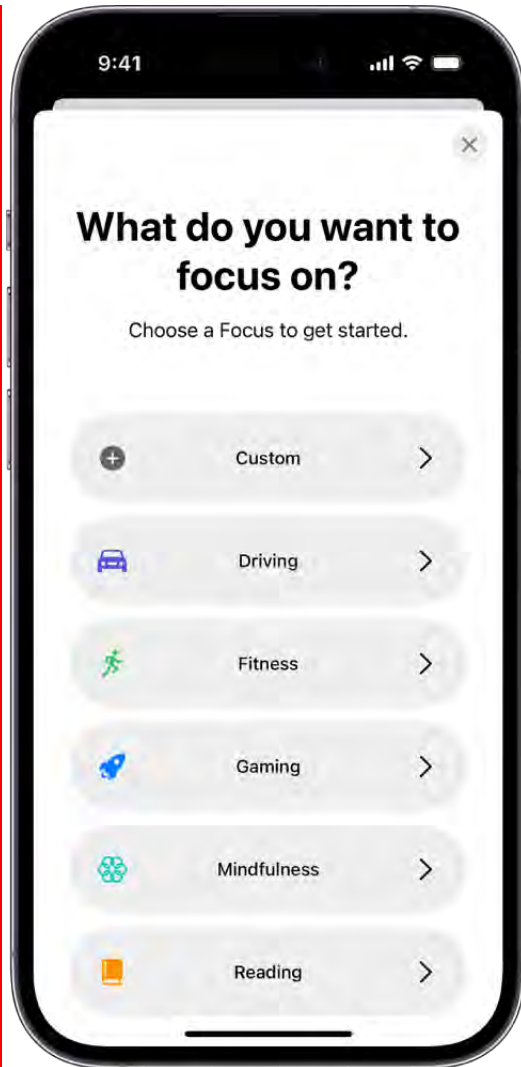

1. Go to Settings  > Focus.
2. Tap **+** at the top right, then tap Custom.
3. Enter a name for your Focus, then tap Return.
4. Choose a color and an icon to represent your Focus, then tap Next.
5. Tap Customize Focus, then set up the options for your custom Focus.

Keep your Focus settings up to date across all your Apple devices

You can use the same Focus settings on all your Apple devices where you're signed in with the same Apple ID.



Go to Settings  > Focus, then turn on Share Across Devices.

Note: **Focus filters** don't get synced across devices—they're only on the device where you set them up.

Allow or silence notifications for a Focus on iPhone

When you [set up a Focus](#), you can select people and apps you want to receive notifications from by either silencing them or allowing them. For example, set up a Work Focus and allow only notifications from your coworkers and the apps you use for work.

Allow or silence notifications from specific people during a Focus

1. Go to Settings  > Focus, then choose a Focus—for example, Do Not Disturb, Personal, Sleep, or Work.
2. Tap People (or tap Choose People), then do one of the following:
 - *Allow specific people:* Tap Allow Notifications From, tap , then select from your contacts.



You can also turn on options to allow calls from certain groups of people and allow repeated calls (two or more calls from the same person within 3 minutes).

- *Silence specific people:* Tap Silence Notifications From, tap , then select from your contacts.

You can also turn on Allow Calls From Silenced People.

Note: Regardless of your Focus settings, you can allow calls from your emergency contacts to come through. See [Allow calls from emergency contacts when notifications are silenced](#), below.

Allow or silence notifications from specific apps during a Focus

1. Go to Settings  > Focus, then choose a Focus—for example, Do Not Disturb, Personal, Sleep, or Work.
2. Tap Apps (or tap Choose Apps), then do one of the following:
 - *Allow specific apps:* Tap Allow Notifications From, tap , then select apps.
 - *Silence specific apps:* Tap Silence Notifications From, tap , then select apps.

Note: You can allow or silence notifications from specific web apps you've added to your Home Screen. (See [Receive Web Push notifications from web apps](#).)

You can also turn on Time Sensitive Notifications, which allows all apps to send time-sensitive notifications immediately.

Share your Focus status

When you're using a Focus, it limits the notifications you receive from people and apps. When someone outside your allowed notifications tries to contact you, your Focus status appears in Messages and other apps you give permission to, so they know you're busy.

When you give an app permission to share your Focus status, others can see that you have notifications silenced, but not the name of the Focus you have turned on. This information is shared only when you have a Focus turned on and after you give the app permission.

1. Go to Settings > Focus > Focus Status.
 2. Turn on Share Focus Status, then select the Focus options you want to share.
-

Allow calls from emergency contacts when notifications are silenced

You can allow sounds and vibrations from emergency contacts to come through even when your iPhone or notifications are silenced.

1. Open Contacts .
2. Select a contact, then tap Edit.
3. Tap Ringtone or Text Tone, then turn on Emergency Bypass.

Or, [set up your Medical ID](#) and identify an emergency contact.

Turn on or schedule a Focus on iPhone

To use a Focus, you can turn it on directly in Control Center, or schedule it to turn on automatically.



Turn on a Focus in Control Center

1. Open Control Center, tap Focus, then tap the Focus you want to turn on (for example, Do Not Disturb).

Note: If another Focus is already on, it turns off when you tap the new one.

DRAFT: APPLE CONFIDENTIAL



2. To choose an ending point for the Focus, tap , select an option (such as "For 1 hour" or "Until I leave this location"), then tap  again.

DO NOT DISTRIBUTE

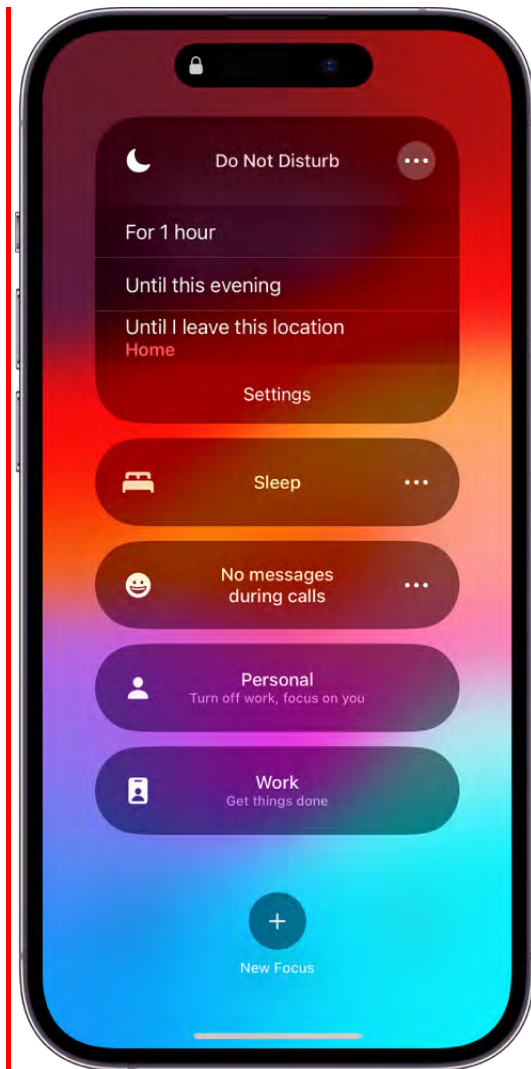



When a Focus is on, its icon (for example, 🌙 for Do Not Disturb) appears in the status bar and on the Lock Screen, and your status is automatically displayed in the Messages app. People who try to send you a message will see that you've silenced notifications, but they can still notify you if something is urgent.

Note: You can also turn a Focus on or off by going to Settings  > Focus, tapping the Focus, then turning it on.

Schedule a Focus to turn on automatically

You can schedule a Focus to turn on at certain times, when you're at a particular location, or when you open a specific app.

1. Go to Settings  > Focus, then tap the Focus you want to schedule.
2. To have this Focus turn on automatically based on cues like your location or app usage, tap Smart Activation, turn on Smart Activation, then tap  at the top left.