



TEST REPORT

Report Number: 14523778-E3V2

Applicant : APPLE, INC.
1 APPLE PARK WAY
CUPERTINO, CA 95014, U.S.A

Model : A2847 (Parent Model)
A3093, A3094, A3096 (Variant Model)

FCC ID : BCG-E8431A (Parent Model)
BCG-E8432A, BCG-E8433A, BCG-E8434A (Variant Model)

IC : 579C-E8431A (Parent Model)
579C-E8432A, 579C-E8433A, 579C-E8434A (Variant Model)

EUT Description : SMARTPHONE

Test Standard(s) : FCC 47 CFR PART 15 SUBPART C
ISED RSS-247 ISSUE 2
ISED RSS-GEN ISSUE 5 + A1 + A2

Date Of Issue:
August 15, 2023

Prepared by:
UL Verification Services Inc.
47173 Benicia Street
Fremont, CA 94538 U.S.A.
TEL: (510) 319-4000
FAX: (510) 661-0888



REVISION HISTORY

Rev.	Issue Date	Revisions	Revised By
V1	08/10/2023	Initial Issue	Chin Pang
V2	08/15/2023	Address TCB questions sections 6, 8, 9, 10	Everardo Torres

TABLE OF CONTENTS

1. ATTESTATION OF TEST RESULTS	5
2. TEST SUMMARY	7
3. TEST METHODOLOGY	7
4. FACILITIES AND ACCREDITATION	7
5. DECISION RULES AND MEASUREMENT UNCERTAINTY	8
5.1. METROLOGICAL TRACEABILITY	8
5.2. DECISION RULES.....	8
5.3. MEASUREMENT UNCERTAINTY.....	8
5.4. SAMPLE CALCULATION	9
6. EQUIPMENT UNDER TEST	10
6.1. EUT DESCRIPTION	10
6.2. MAXIMUM OUTPUT POWER.....	10
6.3. DESCRIPTION OF AVAILABLE ANTENNAS	11
6.4. SOFTWARE AND FIRMWARE.....	11
6.5. WORST-CASE CONFIGURATION AND MODE.....	11
6.6. DESCRIPTION OF TEST SETUP.....	12
7. MEASUREMENT METHOD.....	16
8. TEST AND MEASUREMENT EQUIPMENT	17
9. ANTENNA PORT TEST RESULTS	18
9.1. ON TIME AND DUTY CYCLE.....	18
9.2. 99% BANDWIDTH.....	19
9.2.1. HIGH POWER HDR (HDR4).....	20
9.2.2. HIGH POWER HDR TXBF (HDR4).....	21
9.2.3. HIGH POWER HDR (HDR8).....	22
9.2.4. HIGH POWER HDR TXBF (HDR8).....	23
9.3. 6 dB BANDWIDTH.....	24
9.3.1. HIGH POWER HDR (HDR4).....	25
9.4. HIGH POWER HDR4 TXBF.....	26
9.5. OUTPUT POWER.....	27
9.5.1. HIGH POWER HDR (HDR4).....	28
9.5.2. HIGH POWER HDR TXBF (HDR4).....	28
9.5.3. HIGH POWER HDR (HDR8).....	29
9.5.4. HIGH POWER HDR TXBF (HDR8).....	29
9.5.5. LOW POWER HDR (HDR4)	30

9.5.6.	LOW POWER HDR TXBF (HDR4)	30
9.5.7.	LOW POWER HDR (HDR8)	31
9.5.8.	LOW POWER HDR TXBF (HDR8)	31
9.6.	AVERAGE POWER	32
9.6.1.	HIGH POWER HDR (HDR4)	33
9.6.2.	HIGH POWER HDR TXBF (HDR4)	33
9.6.3.	HIGH POWER HDR (HDR8)	34
9.6.4.	HIGH POWER HDR TXBF (HDR8)	34
9.6.5.	LOW POWER HDR (HDR4)	35
9.6.6.	LOW POWER HDR TXBF (HDR4)	35
9.6.7.	LOW POWER HDR (HDR8)	36
9.6.8.	LOW POWER HDR TXBF (HDR8)	36
9.7.	POWER SPECTRAL DENSITY	37
9.7.1.	HIGH POWER HDR (HDR4)	38
9.7.2.	HIGH POWER HDR TXBF (HDR4)	39
9.7.3.	HIGH POWER HDR (HDR8)	40
9.7.4.	HIGH POWER HDR TXBF (HDR8)	41
9.8.	CONDUCTED SPURIOUS EMISSIONS	42
9.8.1.	HIGH POWER HDR (HDR4)	43
9.8.2.	HIGH POWER HDR TXBF (HDR4)	45
9.8.3.	HIGH POWER HDR (HDR8)	47
9.8.4.	HIGH POWER HDR TXBF (HDR8)	49
9.8.5.	LOW POWER HDR (HDR4)	51
9.8.6.	LOW POWER HDR TXBF (HDR4)	53
9.8.7.	LOW POWER HDR (HDR8)	55
9.8.8.	LOW POWER HDR TXBF (HDR8)	57
10.	RADIATED TEST RESULTS	59
10.1.	LIMITS AND PROCEDURE	59
10.2.	TRANSMITTER ABOVE 1 GHz	61
10.2.1.	HIGH POWER HDR (HDR4)	61
10.2.2.	HIGH POWER HDR TXBF (HDR4)	69
10.2.3.	HIGH POWER HDR8	73
10.2.4.	HIGH POWER HDR TXBF (HDR8)	81
10.2.5.	LOW POWER HDR (HDR4)	85
10.2.6.	LOW POWER HDR TXBF (HDR4)	93
10.2.7.	LOW POWER HDR (HDR8)	97
10.2.8.	LOW POWER HDR TXBF (HDR8)	105
10.2.9.	HARMONICS AND SPURIOUS EMISSIONS	109
10.3.	WORST CASE BELOW 1 GHz	115
10.4.	WORST CASE 18-26.5 GHz	117
11.	AC POWER LINE CONDUCTED EMISSIONS	119
11.1.	AC Power Line With AC/DC Adapter	120
11.2.	AC Power Line With Laptop	122
12.	SETUP PHOTOS	124

1. ATTESTATION OF TEST RESULTS

COMPANY NAME: APPLE INC.
1 APPLE PARK WAY
CUPERTINO, CA 95014, U.S.A

EUT DESCRIPTION: SMARTPHONE

MODEL: A2847 (Parent Model)
A3093, A3094, A3096 (Variant Model)

BRAND: APPLE

SERIAL NUMBER: C3QD24KHHHC (Conducted)
TV3HK457C7 & GM66G6WQ4Q (Radiated)

SAMPLE RECEIPT DATE: MARCH 13, 2023

DATE TESTED: MARCH 14 – AUGUST 1, 2023

APPLICABLE STANDARDS	
STANDARD	TEST RESULTS
CFR 47 Part 15 Subpart C	Complies
ISED RSS-247 Issue 2	Complies
ISED RSS-GEN Issue 5 + A1 + A2	Complies

UL Verification Services Inc. tested the above equipment in accordance with the requirements set forth in the above standards. The test results show that the equipment tested is capable of demonstrating compliance with the requirements as documented in this report.

The results documented in this report apply only to the tested sample, under the conditions and modes of operation as described herein. It is the manufacturer's responsibility to assure that additional production units of this model are manufactured with identical electrical and mechanical components. All samples tested were in good operating condition throughout the entire test program. Measurement Uncertainties are published for informational purposes only and were not taken into account unless noted otherwise.

This document may not be altered or revised in any way unless done so by UL Verification Services Inc. and all revisions are duly noted in the revisions section. Any alteration of this document not carried out by UL Verification Services Inc. will constitute fraud and shall nullify the document. This report must not be used by the client to claim product certification, approval, or endorsement by A2LA, NIST, any agency of the Federal Government, or any agency of the U.S. government.

Approved & Released For
UL Verification Services Inc. By:



Chin Pang
Senior Lab Engineer
Consumer Technology Division
UL Verification Services Inc.

Prepared By:



Chris Xiong
Senior Test Engineer
Consumer Technology Division
UL Verification Services Inc.

2. TEST SUMMARY

FCC Clause	ISED Clause	Requirement	Result	Comment
See Comment		Duty Cycle	Reporting purposes only	ANSI C63.10 Section 11.6.
	RSS-GEN 6.7	99% OBW	Reporting purposes only	ANSI C63.10 Section 6.9.3.
15.247 (a) (2)	RSS-247 5.2 (a)	6dB BW	complies	None.
15.247 (b) (3)	RSS-247 5.4 (d)	Output Power	complies	None.
See Comment		Average power	Reporting purposes only	Per ANSI C63.10, Section 11.9.2.3.2.
15.247 (e)	RSS-247 5.2 (b)	PSD	complies	None.
15.247 (d)	RSS-247 5.5	Conducted Spurious Emissions	complies	None.
15.209, 15.205	RSS-GEN 8.9, 8.10	Radiated Emissions	complies	None.
15.207	RSS-Gen 8.8	AC Mains Conducted Emissions	complies	None.

3. TEST METHODOLOGY

The tests documented in this report were performed in accordance with;

- FCC CFR 47 Part 2,
- FCC CFR 47 Part 15,
- ANSI C63.10-2013,
- KDB 558074 D01 15.247 Meas Guidance v05r02,
- KDB 662911 D01 Multiple Transmitter Output v02r01
- RSS-GEN Issue 5 + A1:2019 + A2:2021
- RSS-247 Issue 2.

4. FACILITIES AND ACCREDITATION

UL Verification Services Inc. is accredited by A2LA, certification #0751.05, for all testing performed within the scope of this report. Testing was performed at the locations noted below.

	Address	ISED CABID	ISED Company Number	FCC Registration
<input type="checkbox"/>	Building 1: 47173 Benicia Street, Fremont, CA 94538, USA	US0104	2324A	550739
<input checked="" type="checkbox"/>	Building 2: 47266 Benicia Street, Fremont, CA 94538, USA			
<input checked="" type="checkbox"/>	Building 3: 843 Auburn Court, Fremont, CA 94538 USA			
<input checked="" type="checkbox"/>	Building 4: 47658 Kato Rd, Fremont, CA 94538 USA			
<input type="checkbox"/>	Building 5: 47670 Kato Rd, Fremont, CA 94538 USA			

5. DECISION RULES AND MEASUREMENT UNCERTAINTY

5.1. METROLOGICAL TRACEABILITY

All test and measuring equipment utilized to perform the tests documented in this report are calibrated on a regular basis, with a maximum time between calibrations of one year or the manufacturers' recommendation, whichever is less, and where applicable is traceable to recognized national standards.

5.2. DECISION RULES

The Decision Rule is based on Simple Acceptance in accordance with ISO Guide 98-4:2012 Clause 8.2. (Measurement uncertainty is not taken into account when stating conformity with a specified requirement.)

5.3. MEASUREMENT UNCERTAINTY

Where relevant, the following measurement uncertainty levels have been estimated for tests performed on the apparatus:

PARAMETER	U _{LAB}
Conducted Antenna Port Emission Measurement	1.94 dB
Power Spectral Density	2.466 dB
Time Domain Measurements Using SA	3.39 dB
RF Power Measurement Direct Method Using Power Meter	0.450 dB(Peak), 1.3 dB (Ave)
Radio Frequency (Spectrum Analyzer)	141.16 Hz
Occupied Bandwidth	1.22%
Worst Case Conducted Disturbance, 0.15 to 30 MHz	3.40 dB
Worst Case Radiated Disturbance, 9KHz to 30 MHz	2.87 dB
Worst Case Radiated Disturbance, 30 to 1000 MHz	6.01 dB
Worst Case Radiated Disturbance, 1000 to 18000 MHz	4.73 dB
Worst Case Radiated Disturbance, 18000 to 26000 MHz	4.51 dB

Uncertainty figures are valid to a confidence level of 95%.

5.4. SAMPLE CALCULATION

RADIATED EMISSIONS

Where relevant, the following sample calculation is provided:

Field Strength (dBuV/m) = Measured Voltage (dBuV) + Antenna Factor (dB/m) + Cable Loss (dB) – Preamp Gain (dB)

36.5 dBuV + 18.7 dB/m + 0.6 dB – 26.9 dB = 28.9 dBuV/m

MAINS CONDUCTED EMISSIONS

Where relevant, the following sample calculation is provided:

Final Voltage (dBuV) = Measured Voltage (dBuV) + Cable Loss (dB) + Limiter Factor (dB) + LISN Insertion Loss.

36.5 dBuV + 0 dB + 10.1 dB + 0 dB = 46.6 dBuV

6. EQUIPMENT UNDER TEST

6.1. EUT DESCRIPTION

The Apple iPhone is a smartphone with multimedia functions (music, application support, and video), cellular GSM, GPRS, EGPRS, UMTS, LTE, 5G, IEEE 802.11a/b/g/n/ac/ax, Bluetooth, Ultra-Wideband, GPS, NFC, 802.15.4ab-NB and MSS technologies. The rechargeable battery is not user accessible.

The Model and FCC/IC ID covered by this report includes:

Parent Model: A2847, FCC ID: BCG-E8431A, IC ID: 579C-E8431A

Variant Model: A3093, FCC ID: BCG-E8432A, IC ID: 579C-E8432A
 A3094, FCC ID: BCG-E8433A, IC ID: 579C-E8433A
 A3096, FCC ID: BCG-E8434A, IC ID: 579C-E8434A

6.2. MAXIMUM OUTPUT POWER

The transmitter has a maximum peak conducted output power as follows:

Antenna	Frequency Range (MHz)	Mode	Configuration	Output Power (dBm)	Output Power (mW)
ANT 4	2404 - 2476	HDR4	High Power	14.75	29.85
			Low Power	8.75	7.50
		HDR8	High Power	16.08	40.55
			Low Power	10.07	10.16
ANT 3	2404 - 2476	HDR4	High Power	14.76	29.92
			Low Power	8.74	7.48
		HDR8	High Power	16.05	40.27
			Low Power	10.06	10.14
Beamforming, ANT 4 + ANT 3	2404 - 2476	HDR4	High Power	17.75	59.57
			Low Power	11.77	15.03
		HDR8	High Power	19.09	81.10
			Low Power	13.05	20.18

6.3. DESCRIPTION OF AVAILABLE ANTENNAS

The antenna(s) gain, as provided by the manufacturer' are as follows:

Frequency Range (GHz)	ANT 4 (dBi)	ANT 3 (dBi)
2.4	-1.7	-1.0

6.4. SOFTWARE AND FIRMWARE

The EUT firmware version is 21.1.547.9113

6.5. WORST-CASE CONFIGURATION AND MODE

The EUT was investigated in three orthogonal orientations X, Y and Z on ANT 4, ANT 3 and 2TX beamforming. It was determined that X (Flatbed) orientation was the worst-case orientation for ANT 3 and ANT 4. And Y (Landscape) was the worst case for beamforming 2TX.

Radiated band edge, harmonic and spurious emissions from 1GHz to 18GHz were performed with the EUT set to transmit at highest power on Low/Middle/High channels.

Radiated emissions below 1GHz, 18-26GHz and power line conducted emissions were performed with the EUT transmits at the channel with the highest output power as worst-case scenario. There were no emissions found below 30MHz within 20dB of the limit.

For below 1GHz tests were performed with EUT connected to AC power adapter as the worst case; and for above 1GHz, the worst-case configuration reported was tested with EUT only. For AC line conducted emission, test was investigated with AC power adapter and with laptop.

High power HDR4 and HDR8 TXBF harmonic spurious 1-18GHz were investigated to determine the worst case and results showed HDR4 was the worst case. Therefore, High Power Beamforming HDR4 mode was set to maximum power based on SISO to cover both SISO and MIMO modes to complies with radiated spurious emissions limits in the restricted bands between 1GHz and 18GHz low/mid/high channel (except the band edge).

99% and 6dB bandwidth measurements were performed only for high power mode to cover low power mode since 99% and 6dB bandwidth results are not different on low power mode. PSD measurements were done only for high power mode to cover low power mode as worst-case scenario.

Note: In the Radiated Plots and emissions data, ANT0=ANT4 and ANT1=ANT 3.

6.6. DESCRIPTION OF TEST SETUP

SUPPORT TEST EQUIPMENT						
Description	Manufacturer	Model	Serial Number	FCC ID/ DoC		
Laptop	Apple	Macbook Pro	C02VD7SAHV22	BCGA1708		
Laptop AC/DC adapter	Liteon Technology	A1424	NSW25679	DoC		
EUT AC/DC adapter	Apple	A1720	C3D8417A7R93KVPA8	DoC		
Conducted Switch Box	UL	n/a	208281	N/A		
10dB Fixed Attenuator, 2 Watts Up to 26.5 GHz	Pasternack Enterprises	PE7024-10	236358	N/A		
I/O CABLES (RF CONDUCTED TEST)						
Cable No.	Port	# of Identical Ports	Connector Type	Cable Type	Cable Length (m)	Remarks
1	SMA	1	SMA	Shielded	0.75	To spectrum Analyzer
2	Antenna	2	SMA	Un-shielded	0.2	To Conducted Switch Box
3	USB-C	1	USB-C	Shielded	1.0	N/A
4	AC	1	AC	Un-shielded	2	N/A
I/O CABLES (RF RADIATED AND AC LINE CONDUCTED TEST)						
Cable No.	Port	# of Identical Ports	Connector Type	Cable Type	Cable Length (m)	Remarks
1	AC	1	AC	Un-shielded	2	N/A
2	USB	1	USB	Shielded	1	N/A

TEST SETUP

The EUT setup is shown as below. Test software exercised the radio card.

SETUP DIAGRAM FOR CONDUCTED TESTS

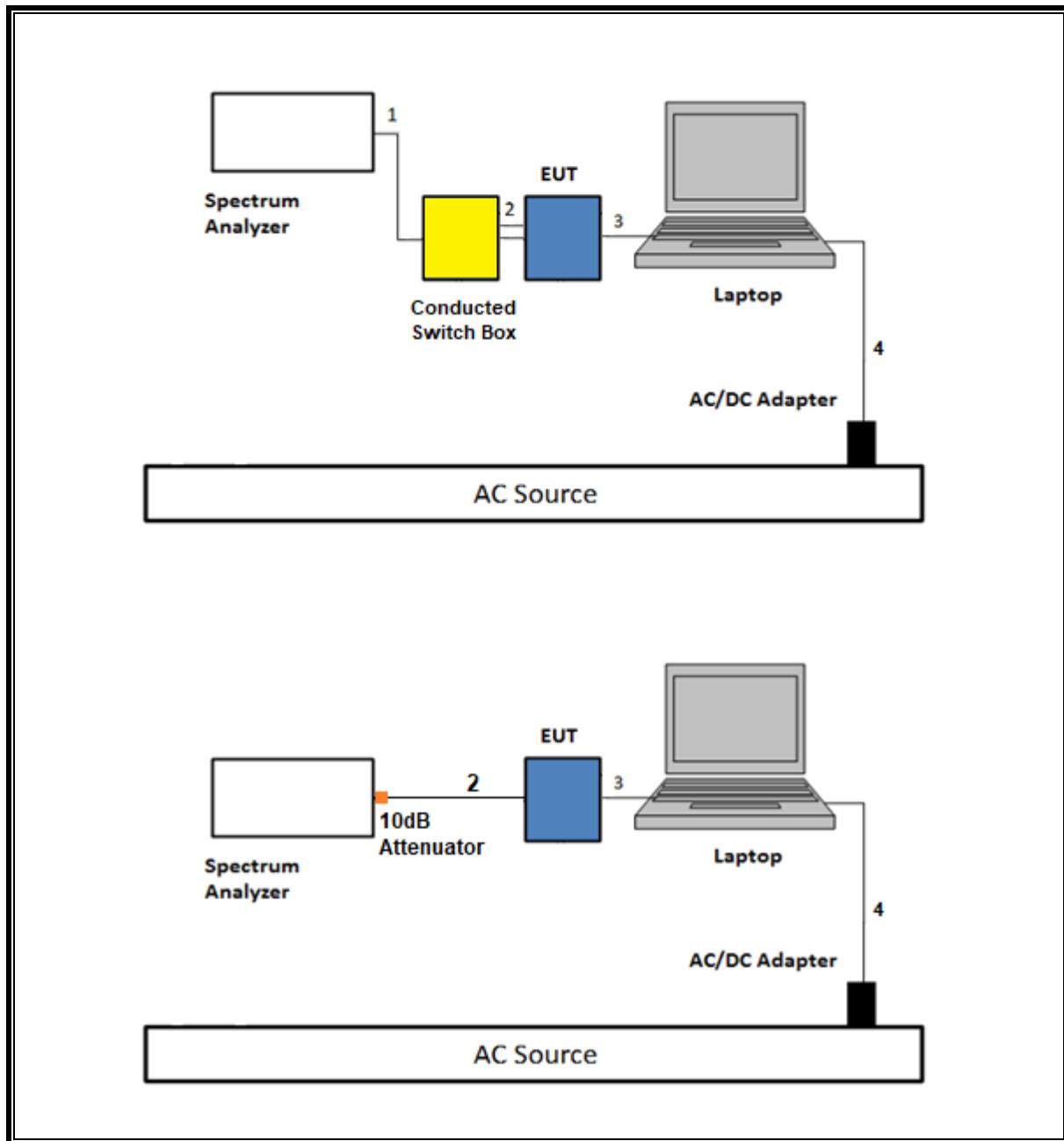

SETUP DIAGRAM FOR RADIATED TESTS ABOVE 1 GHz

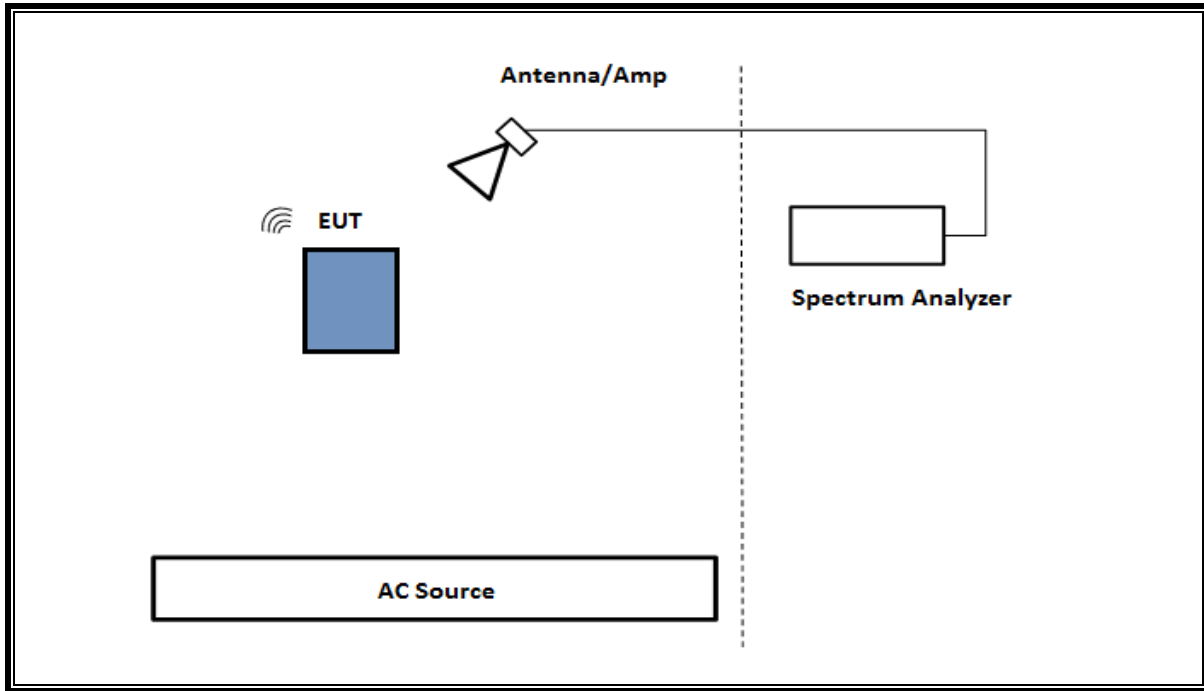

SETUP DIAGRAM FOR BELOW 1GHz and AC LINE CONDUCTED TEST

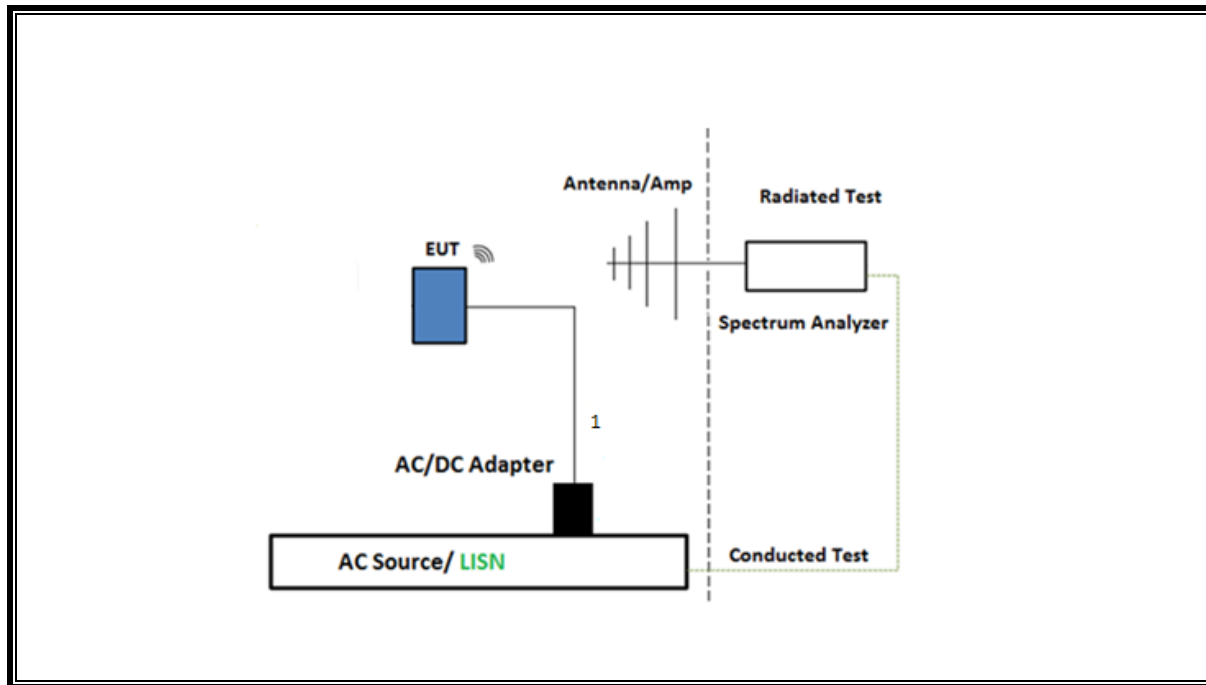

TEST SETUP - AC LINE CONDUCTED: LAPTOP CONFIGURATION

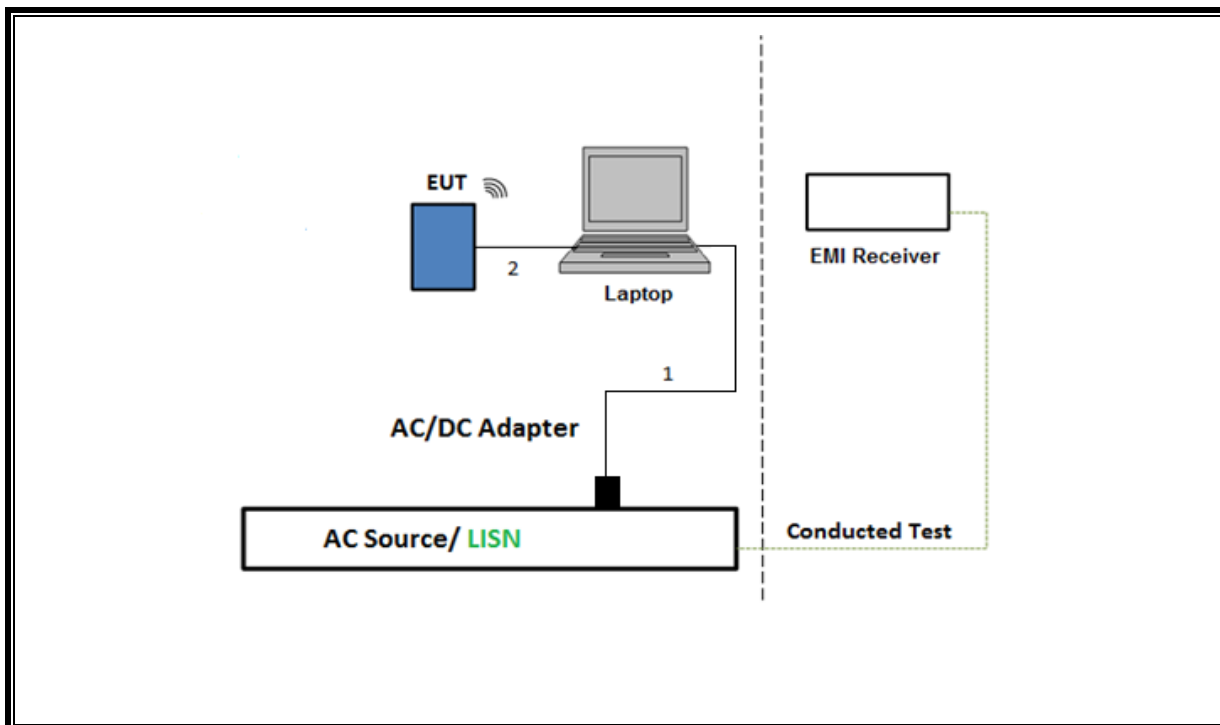

7. MEASUREMENT METHOD

On Time and Duty Cycle: KDB 558074 D01 v05r02, Section 6.

6 dB BW: ANSI C63.10 Subclause -11.8.1, $RBW \geq DTS BW$

Occupied BW (99%): ANSI C63.10-2013 Section 6.9.3

Output Power: ANSI C63.10 Subclause -11.9.1.3, Method PKPM1 Peak-reading power meter

Output Power: ANSI C63.10 Subclause -11.9.2.3.2, Measurement using gated average power meter.

PSD: ANSI C63.10 Subclause -11.10.2, Method PKPSD (peak PSD)

Radiated emissions restricted frequency bands: ANSI C63.10 Subclause -11.12.1 & Clause 13

Conducted emissions in restricted frequency bands: ANSI C63.10 Subclause -11.12.2

Band-edge: ANSI C63.10 Subclause -11.13.3.2 & Clause 13, Integration method -Peak detection

Band-edge: ANSI C63.10 Subclause -11.13.3.3 & Clause 13, Integration method -Trace averaging with continuous transmission at full power

Radiated Band-edge: ANSI C63.10-2013 Section 6.10.5 & 13

AC Power Line Conducted Emissions: ANSI C63.10-2013, Section 6.2.

Radiated emissions non-restricted frequency bands: ANSI C63.10 Subclause – 11.11 & Clause 13

Radiated Spurious Emissions Below 30MHz: ANSI C63.10-2013 Section 6.4 & 13

NOTE: All conducted antenna port tests for Beamforming applied the same test procedures as HDR normal modes.

8. TEST AND MEASUREMENT EQUIPMENT

The following test and measurement equipment was utilized for the tests documented in this report:

Description	Manufacturer	Model	ID Num	Cal Due	Last Cal
Spectrum Analyzer, PXA, 3Hz to 44GHz	Keysight Technologies Inc	N9030A	80397	02/29/2024	02/29/2023
10dB Fixed Attenuator, 2 Watts Up to 26.5 GHz	Pasternack Enterprises	PE7024-10	236355	Verified/Characterized before use	
EMI TEST RECEIVER	Rohde & Schwarz	ESW44	170063	02/29/2024	02/29/2023
Antenna, Horn 1-18GHz	ETS-Lindgren (Cedar Park, Texas)	3117	230300	01/12/2024	01/12/2023
RF Filter Box, 1-18GHz, 12 Port.	UL-FR1	Frankenstein	231875	02/27/2024	02/27/2023
EMI TEST RECEIVER	Rohde & Schwarz	ESW44	230548	02/29/2024	02/29/2023
*Antenna, Horn 1-18GHz	ETS-Lindgren (Cedar Park, Texas)	3117	80404	08/08/2023	08/08/2022
RF Filter Box, 1-18GHz, 12 Port	UL-FR1	Frankenstein	216812	09/17/2023	09/17/2022
EMI TEST RECEIVER	Rohde & Schwarz	ESW44	201499	02/29/2024	02/29/2023
Antenna, Horn 1-18GHz	ETS-Lindgren (Cedar Park, Texas)	3117	41112	10/07/2023	10/07/2022
RF Filter Box, 1-18GHz, 12 Port	UL-FR1	Frankenstein	231249	02/29/2024	02/29/2023
EMI TEST RECEIVER	Rohde & Schwarz	ESW44	191428	02/29/2024	02/29/2023
Antenna, Horn 1-18GHz	ETS-Lindgren (Cedar Park, Texas)	3117	206807	02/28/2024	02/28/2023
RF Filter Box, 1-18GHz, 12 Port.	UL-FR1	Frankenstein	230878	02/29/2024	02/29/2023
EMI TEST RECEIVER, with B8 option	Rohde & Schwarz	ESW44	169937	02/29/2024	02/29/2023
*Antenna, Broadband Hybrid, 30MHz to 2000MHz	Sunol Sciences Corp.	JB3	85151	03/31/2023	03/31/2022
*Amplifier, 10KHz to 1GHz, 32dB	Sonoma Instrument Co.	310N	89831	08/10/2023	08/10/2022
*Power Sensor, P - series, 50MHz to 18GHz, Wideband	Keysight Technologies Inc	N1921A	90391	01/31/2024	01/31/2023
Power Meter, P-series single channel	Keysight Technologies Inc	N1911A	90718	01/31/2024	01/31/2023
Antenna Horn, 18 to 26.5GHz	ARA	MWH-1826/B	172363	01/31/2024	01/31/2023
*Amplifier 18-26.5GHz, +5Vdc, 60dB min	AMPLICAL	AMP18G26.5-60	171580	06/10/2023	06/10/2022
*Antenna, Passive Loop 30Hz to 1MHz	Electro-Metrics	EM-6871	170013	07/28/2023	07/28/2022
*Antenna, Passive Loop 100KHz to 30MHz	ETS-Lindgren	EM-6872	170015	07/28/2023	07/28/2022

AC Line Conducted					
Description	Manufacturer	Model	ID Num	Cal Due	Last Cal
EMI Test Receiver 9kHz-7GHz	Rohde & Schwarz	ESR	93091	02/29/2024	02/29/2023
LISN for Conducted Emissions CISPR-16	FISCHER CUSTOM COMMUNICATIONS	FCC-LISN-50/250-25-2-01-480V	175764	01/31/2024	01/31/2023
*Transient Limiter	TE	TBFL1	207996	07/15/2023	07/15/2022
UL AUTOMATION SOFTWARE					
Radiated Software	UL	UL EMC	Ver 9.5, May 1, 2023		
Conducted Software	UL	UL EMC	2020.8.16		
AC Line Conducted Software	UL	UL EMC	Ver 9.5, Mar 3, 2023		

*Testing was completed before equipment expiration date.

9. ANTENNA PORT TEST RESULTS

9.1. ON TIME AND DUTY CYCLE

LIMITS

None; for reporting purposes only.

PROCEDURE

KDB 558074 Zero-Span Spectrum Analyzer Method.

ON TIME AND DUTY CYCLE RESULTS

Mode	ON Time B (msec)	Period (msec)	Duty Cycle x (linear)	Duty Cycle (%)	Duty Cycle Correction Factor (dB)	1/B Minimum VBW (kHz)
2.4GHz Band						
HDR4	1.0	1.0	1.000	100.00%	0.00	0.010
HDR8	1.0	1.0	1.000	100.00%	0.00	0.010

DUTY CYCLE PLOTS

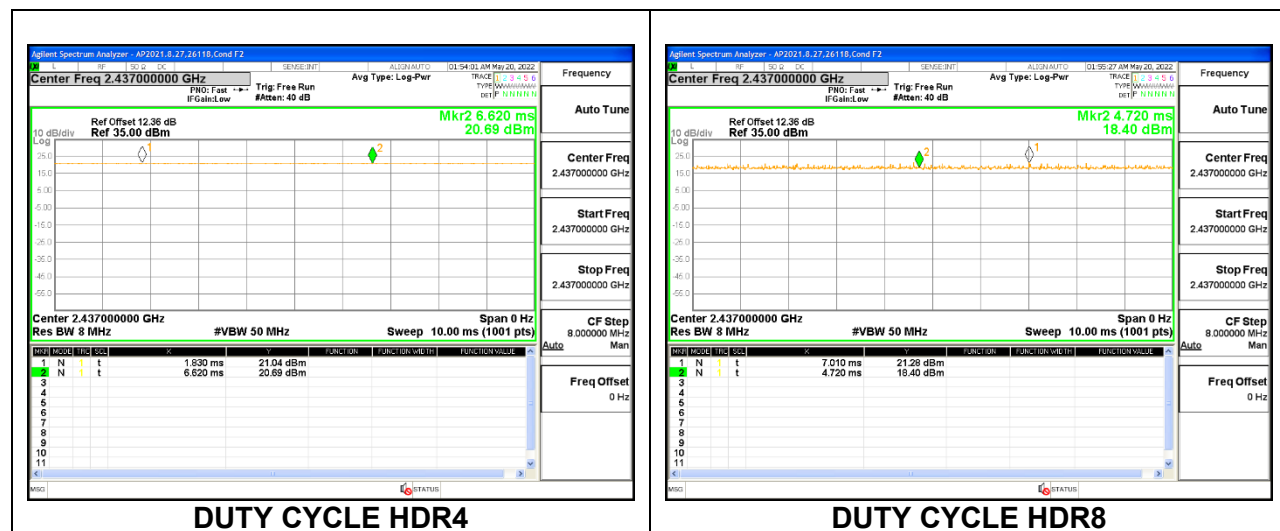

Note: There are the same duty cycle factor on 1TX and 2TX.

9.2. 99% BANDWIDTH**LIMITS**

None; for reporting purposes only.

RESULTS

Only High-Power modes result is reported, it covers all Low Power modes. Only Mid channel plot is reported to show analyzer's settings.

9.2.1. HIGH POWER HDR (HDR4)

ANT 4

Channel	Frequency (MHz)	99% Bandwidth (MHz)
Low	2404	2.3111
Middle	2440	2.3115
High	2476	2.3214

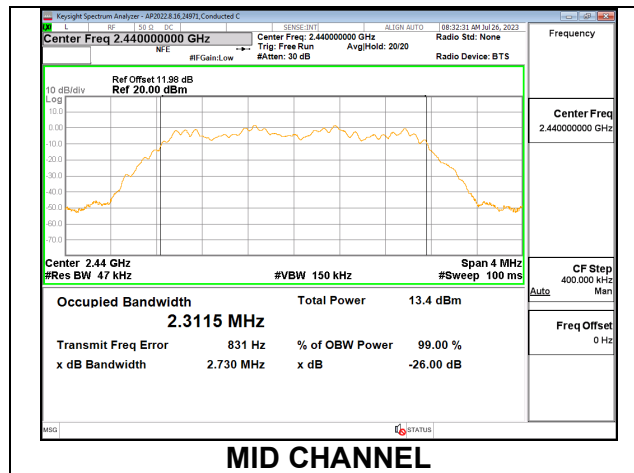

ANT 3

Channel	Frequency (MHz)	99% Bandwidth (MHz)
Low	2404	2.3128
Middle	2440	2.3127
High	2476	2.3145

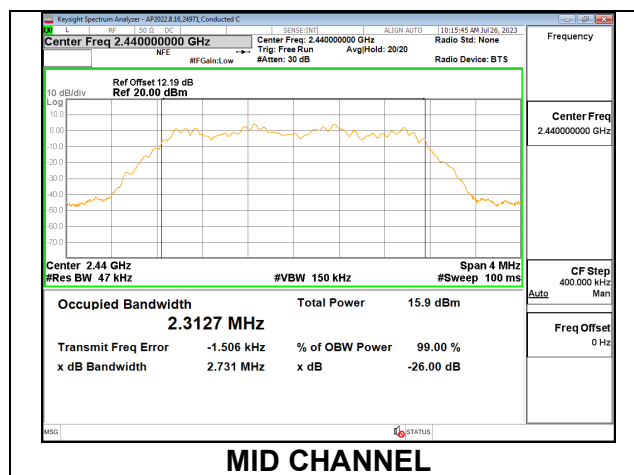

9.2.2. HIGH POWER HDR TXBF (HDR4)

Channel	Frequency (MHz)	99% Bandwidth ANT 4 (MHz)	99% Bandwidth ANT 3 (MHz)
Low	2404	2.3112	2.3127
Middle	2440	2.3115	2.3128
High	2476	2.3127	2.3145

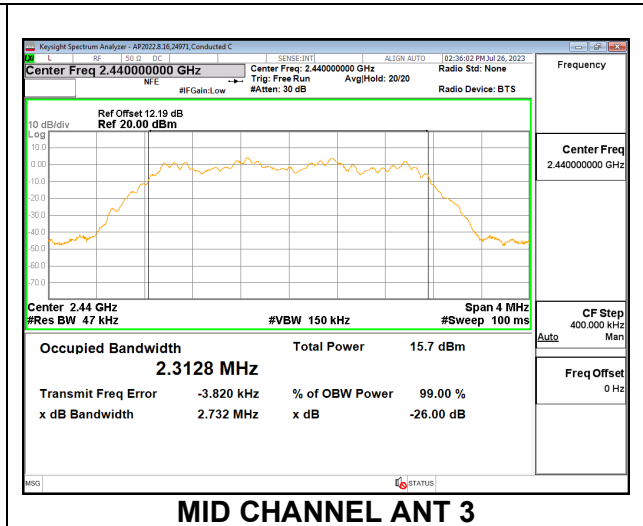
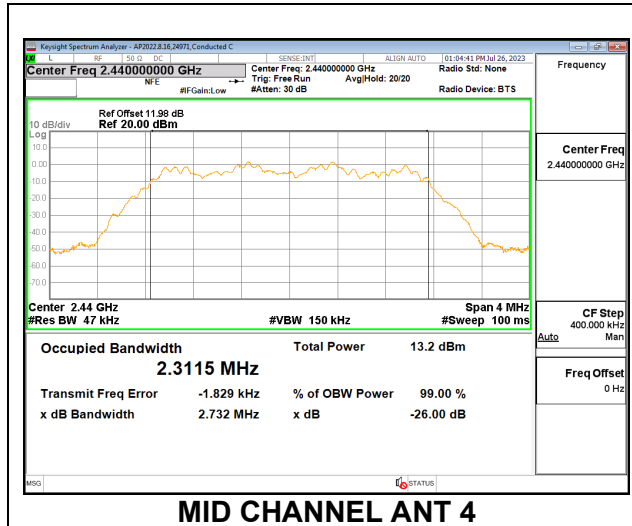

9.2.3. HIGH POWER HDR (HDR8)

ANT 4

Channel	Frequency (MHz)	99% Bandwidth (MHz)
Low	2404	4.6545
Middle	2440	4.6489
High	2476	4.6549

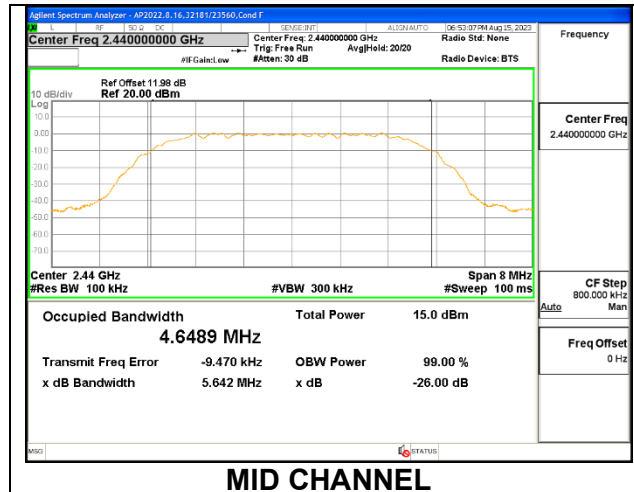

ANT 3

Channel	Frequency (MHz)	99% Bandwidth (MHz)
Low	2404	4.6693
Middle	2440	4.6541
High	2476	4.6570

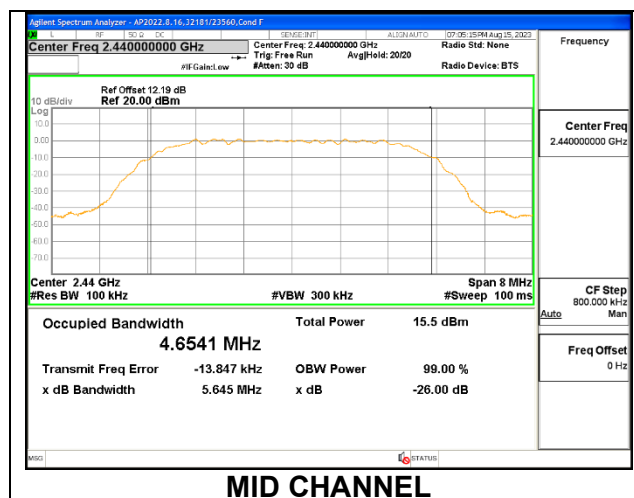

9.2.4. HIGH POWER HDR TXBF (HDR8)

Channel	Frequency (MHz)	99% Bandwidth ANT 4 (MHz)	99% Bandwidth ANT 3 (MHz)
Low	2404	4.6758	4.6672
Middle	2440	4.6705	4.6523
High	2476	4.6430	4.6588

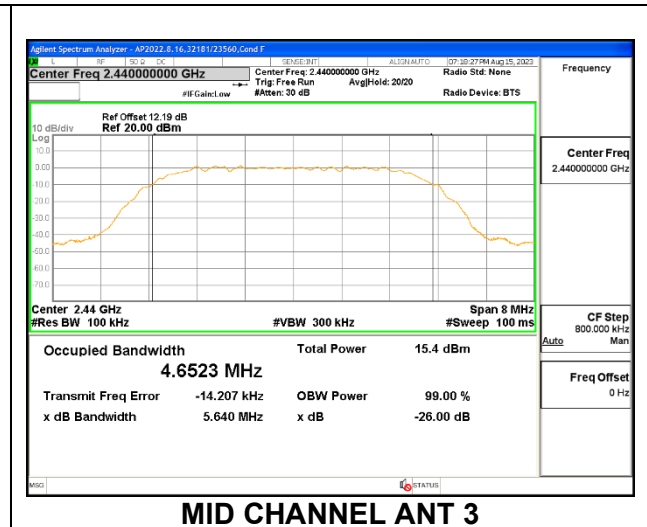
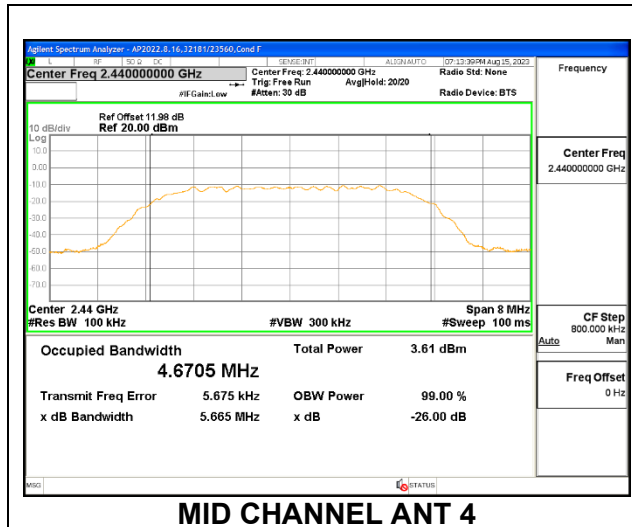

9.3. 6 dB BANDWIDTH

LIMITS

FCC §15.407 (e)

RSS-247 5.2 (a)

The minimum 6 dB bandwidth shall be at least 500 kHz.

RESULTS

The 6dB bandwidth was measured for the narrowest bandwidth mode, HDR4, to demonstrate compliance with the minimum required bandwidth of 500 kHz. Other modes were not tested as their bandwidth is greater than the HDR4 mode, as demonstrated by the 99% bandwidth measurements performed on all modes.

Only Mid channel plot is reported to show setting parameter complies with testing method/procedure.

Only High-Power modes result is reported, it covers all Low Power modes.

9.3.1. HIGH POWER HDR (HDR4)

ANT 4

Channel	Frequency (MHz)	6 dB Bandwidth (MHz)	Minimum Limit (MHz)
Low	2404	2.092	0.5
Middle	2440	2.108	0.5
High	2476	2.116	0.5

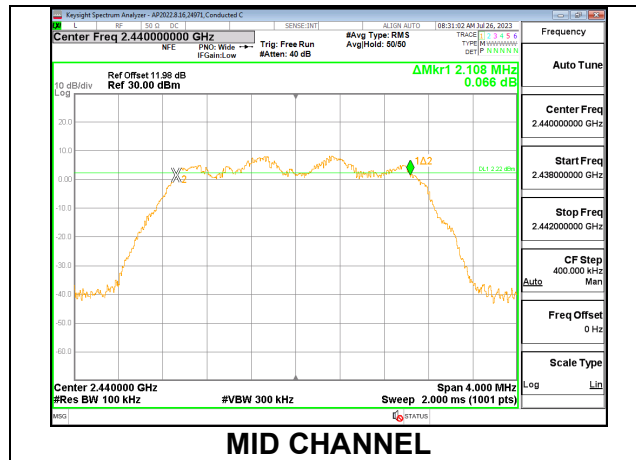

ANT 3

Channel	Frequency (MHz)	6 dB Bandwidth (MHz)	Minimum Limit (MHz)
Low	2404	2.112	0.5
Middle	2440	2.104	0.5
High	2476	2.108	0.5

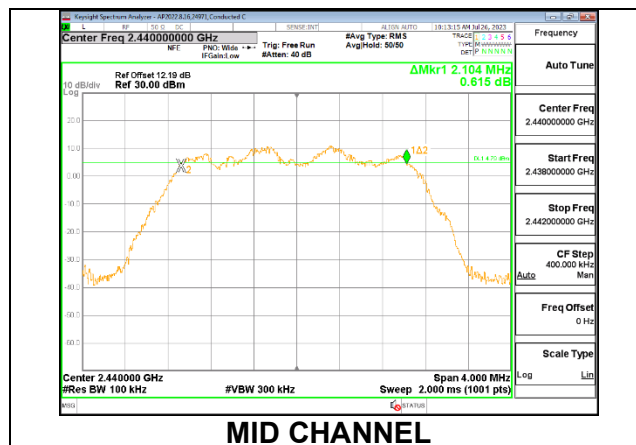

9.4. HIGH POWER HDR4 TXBF

Channel	Frequency (MHz)	6 dB Bandwidth ANT 4 (MHz)	6 dB Bandwidth ANT 3 (MHz)	Minimum Limit (MHz)
Low	2404	2.100	2.072	0.5
Mid	2440	2.100	2.112	0.5
High	2476	2.108	2.108	0.5

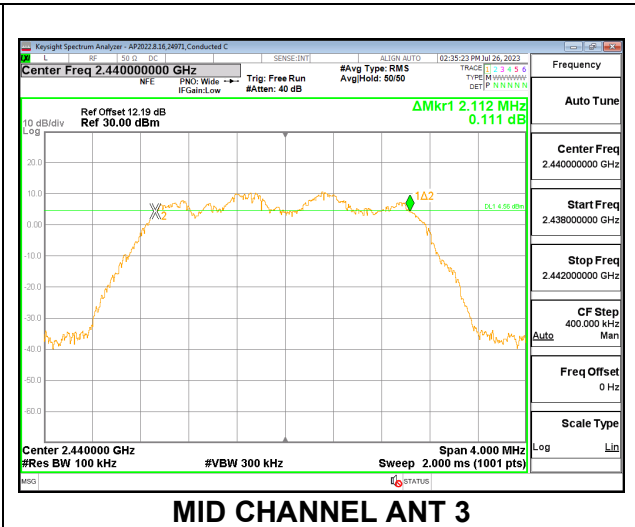
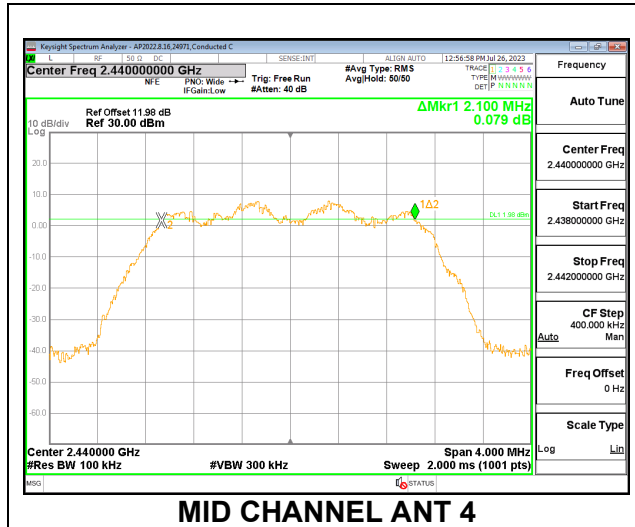

9.5. OUTPUT POWER

LIMITS

FCC §15.247 (b) (3)

RSS-247 5.4 (d)

The maximum antenna gain is less than or equal to 6 dBi, therefore the limit is 30 dBm.

TEST PROCEDURE

Measurements perform using a wideband RF power meter.

The power output was measured on the EUT antenna port using SMA cable with 10dB attenuator connected to a power meter via wideband peak power sensor. Peak output power was read directly from the power meter.

DIRECTIONAL ANTENNA GAIN

For 1 TX:

There is only one transmitter output therefore the directional gain is equal to the antenna gain.

For 2 TX:

Tx chains are correlated for power and PSD due to the device supporting Beamforming mode. The directional gains are as follows:

Band (GHz)	ANT 4 Antenna Gain (dBi)	ANT 3 Antenna Gain (dBi)	Uncorrelated Chains Directional Gain (dBi)	Correlated Chains Directional Gain (dBi)
2.4	-1.7	-1	-1.34	1.67

Directional Gain Calculation:

ANSI C63.10-2013 section 14.4.3

Uncorrelated directional gain= $10 \cdot \text{LOG}((10^{(\text{Ant1}/10)}+10^{(\text{Ant2}/10)})/2)$

Correlated directional Gain= $10 \cdot \text{LOG}(((10^{(\text{Ant1}/20)}+10^{(\text{Ant2}/20)})^2)/2)$

Sample Calculation:

Ant4 =-1.7, Ant3 =-1

Uncorrelated Antenna gain = $10 \log[(10^{(-1/10)}+10^{(-1.9/10)})/2]$ = -1.34 dBi

Correlated Antenna gain = $10 \log[(10^{(-1/20)}+10^{(-1.9/20)})^2/2]$ = 1.67dBi

RESULTS

9.5.1. HIGH POWER HDR (HDR4)

ANT 4

Tested By:	24971
Date:	7/19/2023

Channel	Frequency (MHz)	Peak Power Reading (dBm)	Limit (dBm)	Margin (dB)
Low	2404	14.69	30	-15.31
Middle	2440	14.75	30	-15.25
High	2476	14.72	30	-15.28

ANT 3

Tested By:	24971
Date:	7/19/2023

Channel	Frequency (MHz)	Peak Power Reading (dBm)	Limit (dBm)	Margin (dB)
Low	2404	14.72	30	-15.28
Middle	2440	14.76	30	-15.24
High	2476	14.74	30	-15.26

9.5.2. HIGH POWER HDR TXBF (HDR4)

Tested By:	24971
Date:	7/19/2023

Channel	Frequency (MHz)	Peak Power Reading ANT 4 (dBm)	Peak Power Reading ANT 3 (dBm)	Total Corr'd Power (dBm)	Limit (dBm)	Margin (dB)
Low	2404	14.70	14.72	17.72	30.00	-12.28
Middle	2440	14.72	14.75	17.75	30.00	-12.25
High	2476	14.71	14.71	17.72	30.00	-12.28

9.5.3. HIGH POWER HDR (HDR8)

ANT 4

Tested By:	24971
Date:	7/19/2023

Channel	Frequency (MHz)	Peak Power Reading (dBm)	Limit (dBm)	Margin (dB)
Low	2404	16.04	30	-13.96
Middle	2440	16.08	30	-13.92
High	2476	16.02	30	-13.98

ANT 3

Tested By:	24971
Date:	7/19/2023

Channel	Frequency (MHz)	Peak Power Reading (dBm)	Limit (dBm)	Margin (dB)
Low	2404	16.01	30	-13.99
Middle	2440	16.05	30	-13.95
High	2476	16.04	30	-13.96

9.5.4. HIGH POWER HDR TXBF (HDR8)

Tested By:	24971
Date:	7/19/2023

Channel	Frequency (MHz)	Peak Power Reading ANT 4 (dBm)	Peak Power Reading ANT 3 (dBm)	Total Corr'd Power (dBm)	Limit (dBm)	Margin (dB)
Low	2404	16.02	16.05	19.05	30.00	-10.95
Middle	2440	16.07	16.08	19.09	30.00	-10.91
High	2476	16.03	16.01	19.03	30.00	-10.97

9.5.5. LOW POWER HDR (HDR4)**ANT 4**

Tested By:	24971
Date:	7/19/2023

Channel	Frequency (MHz)	Peak Power Reading (dBm)	Limit (dBm)	Margin (dB)
Low	2404	8.69	30	-21.31
Middle	2440	8.75	30	-21.25
High	2476	8.72	30	-21.28

ANT 3

Tested By:	24971
Date:	7/19/2023

Channel	Frequency (MHz)	Peak Power Reading (dBm)	Limit (dBm)	Margin (dB)
Low	2404	8.73	30	-21.27
Middle	2440	8.74	30	-21.26
High	2476	8.70	30	-21.30

9.5.6. LOW POWER HDR TXBF (HDR4)

Tested By:	24971
Date:	7/19/2023

Channel	Frequency (MHz)	Peak Power Reading ANT 4 (dBm)	Peak Power Reading ANT 3 (dBm)	Total Corr'd Power (dBm)	Limit (dBm)	Margin (dB)
Low	2404	8.72	8.71	11.73	30.00	-18.27
Middle	2440	8.77	8.75	11.77	30.00	-18.23
High	2476	8.72	8.69	11.72	30.00	-18.28

9.5.7. LOW POWER HDR (HDR8)

ANT 4

Tested By:	24971
Date:	7/19/2023

Channel	Frequency (MHz)	Peak Power Reading (dBm)	Limit (dBm)	Margin (dB)
Low	2404	9.99	30	-20.01
Middle	2440	10.07	30	-19.93
High	2476	10.02	30	-19.98

ANT 3

Tested By:	24971
Date:	7/19/2023

Channel	Frequency (MHz)	Peak Power Reading (dBm)	Limit (dBm)	Margin (dB)
Low	2404	10.02	30	-19.98
Middle	2440	10.06	30	-19.94
High	2476	10.05	30	-19.95

9.5.8. LOW POWER HDR TXBF (HDR8)

Tested By:	24971
Date:	7/19/2023

Channel	Frequency (MHz)	Peak Power Reading ANT 4 (dBm)	Peak Power Reading ANT 3 (dBm)	Total Corr'd Power (dBm)	Limit (dBm)	Margin (dB)
Low	2404	10.02	10.04	13.04	30.00	-16.96
Middle	2440	10.06	10.02	13.05	30.00	-16.95
High	2476	10.03	10.03	13.04	30.00	-16.96

9.6. AVERAGE POWER

LIMITS

None; for reporting purposes only.

TEST PROCEDURE

Measurements perform using a wideband RF power meter.

The power output was measured on the EUT antenna port using SMA cable with 10dB attenuator connected to a power meter via wideband average power sensor. Gated average output power was read directly from power meter.

RESULTS

9.6.1. HIGH POWER HDR (HDR4)

ANT 4

Tested By:	24971
Date:	7/19/23

Channel	Frequency (MHz)	AV power (dBm)
Low	2404	12.20
Middle	2440	12.22
High	2476	12.23

ANT 3

Tested By:	24971
Date:	7/19/23

Channel	Frequency (MHz)	AV power (dBm)
Low	2404	12.24
Middle	2440	12.25
High	2476	12.23

9.6.2. HIGH POWER HDR TXBF (HDR4)

Tested By:	24971
Date:	7/19/23

Channel	Frequency (MHz)	Average Power ANT 4 (dBm)	Average Power ANT 3 (dBm)	Total Power (dBm)
Low	2404	12.21	12.20	15.22
Middle	2440	12.24	12.23	15.25
High	2476	12.22	12.19	15.22

9.6.3. HIGH POWER HDR (HDR8)

ANT 4

Tested By:	24971
Date:	7/19/23

Channel	Frequency (MHz)	AV power (dBm)
Low	2404	13.22
Middle	2440	13.25
High	2476	13.24

ANT 3

Tested By:	24971
Date:	7/19/23

Channel	Frequency (MHz)	AV power (dBm)
Low	2404	13.23
Middle	2440	13.23
High	2476	13.21

9.6.4. HIGH POWER HDR TXBF (HDR8)

Tested By:	24971
Date:	7/19/23

Channel	Frequency (MHz)	Average Power ANT 4 (dBm)	Average Power ANT 3 (dBm)	Total Power (dBm)
Low	2404	13.20	13.23	16.23
Middle	2440	13.24	13.23	16.25
High	2476	13.21	13.22	16.23

9.6.5. LOW POWER HDR (HDR4)

ANT 4

Tested By:	24971
Date:	7/19/23

Channel	Frequency (MHz)	AV power (dBm)
Low	2404	6.20
Middle	2440	6.23
High	2476	6.24

ANT 3

Tested By:	24971
Date:	7/19/23

Channel	Frequency (MHz)	AV power (dBm)
Low	2404	6.22
Middle	2440	6.25
High	2476	6.23

9.6.6. LOW POWER HDR TXBF (HDR4)

Tested By:	24971
Date:	7/19/23

Channel	Frequency (MHz)	Average Power ANT 4 (dBm)	Average Power ANT 3 (dBm)	Total Power (dBm)
Low	2404	6.23	6.23	9.24
Middle	2440	6.24	6.22	9.24
High	2476	6.20	6.21	9.22

9.6.7. LOW POWER HDR (HDR8)

ANT 4

Tested By:	24971
Date:	7/19/23

Channel	Frequency (MHz)	AV power (dBm)
Low	2404	7.21
Middle	2440	7.24
High	2476	7.19

ANT 3

Tested By:	24971
Date:	7/19/23

Channel	Frequency (MHz)	AV power (dBm)
Low	2404	7.24
Middle	2440	7.22
High	2476	7.23

9.6.8. LOW POWER HDR TXBF (HDR8)

Tested By:	24971
Date:	7/19/23

Channel	Frequency (MHz)	Average Power ANT 4 (dBm)	Average Power ANT 3 (dBm)	Total Power (dBm)
Low	2404	7.20	7.21	10.22
Middle	2440	7.22	7.23	10.24
High	2476	7.19	7.20	10.21

9.7. POWER SPECTRAL DENSITY

LIMITS

FCC §15.247 (e)

RSS-247 (5.2) (b)

The power spectral density conducted from the transmitter to the antenna shall not be greater than 8 dBm in any 3 kHz band during any time interval of continuous transmission.

RESULTS

Only High-Power modes result is reported, it covers all Low Power modes

9.7.1. HIGH POWER HDR (HDR4)

ANT 4

Channel	Frequency (MHz)	PSD (dBm/3kHz)	Limit (dBm/3kHz)	Margin (dB)
Low	2404	-3.653	8	-11.65
Middle	2440	-3.381	8	-11.38
High	2476	-3.821	8	-11.82

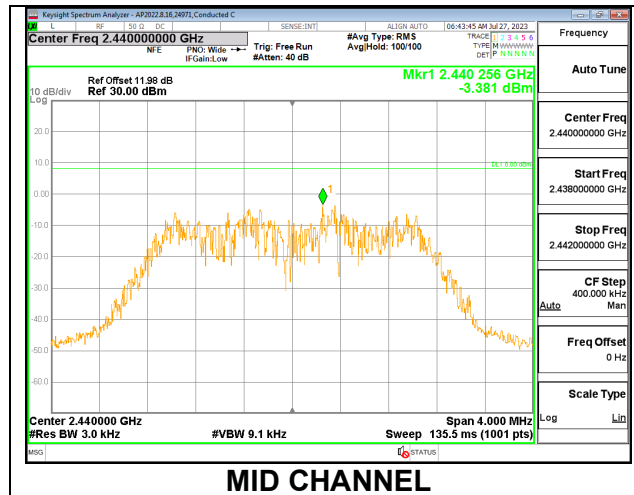

ANT 3

Channel	Frequency (MHz)	PSD (dBm/3kHz)	Limit (dBm/3kHz)	Margin (dB)
Low	2404	-3.481	8	-11.48
Middle	2440	-2.482	8	-10.48
High	2476	-2.494	8	-10.49

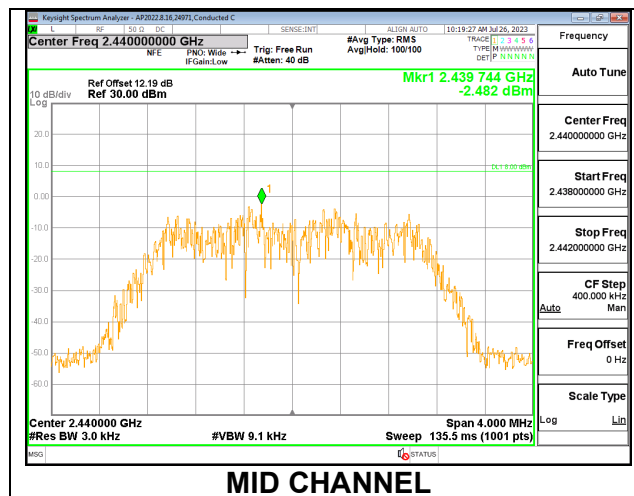

9.7.2. HIGH POWER HDR TXBF (HDR4)

Note: Test procedures and setting are same as HDR normal mode.

PSD Results

Channel	Frequency (MHz)	ANT 4 Meas (dBm/ 3kHz)	ANT 3 Meas (dBm/ 3kHz)	Total Corr'd PSD (dBm/ 3kHz)	Limit (dBm/ 3kHz)	Margin (dB)
Low	2404	-3.837	-3.938	-0.88	8.0	-8.9
Mid	2440	-3.672	-3.582	-0.62	8.0	-8.6
High	2476	-3.607	-3.275	-0.43	8.0	-8.4

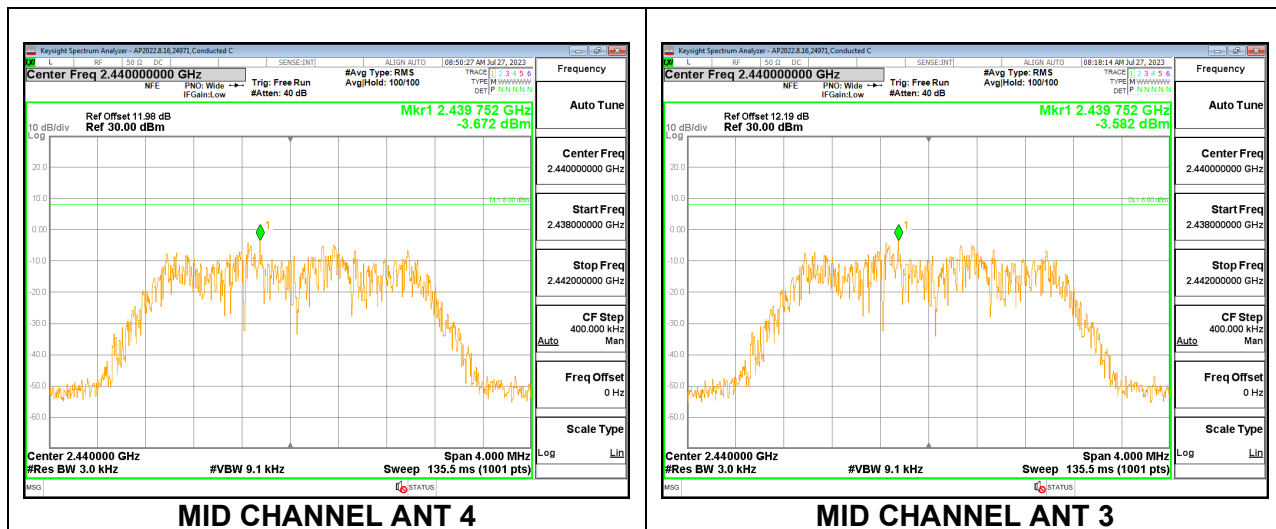

9.7.3. HIGH POWER HDR (HDR8)

ANT 4

Channel	Frequency (MHz)	PSD (dBm/3kHz)	Limit (dBm/3kHz)	Margin (dB)
Low	2404	-5.402	8	-13.40
Middle	2440	-5.497	8	-13.50
High	2476	-5.337	8	-13.34

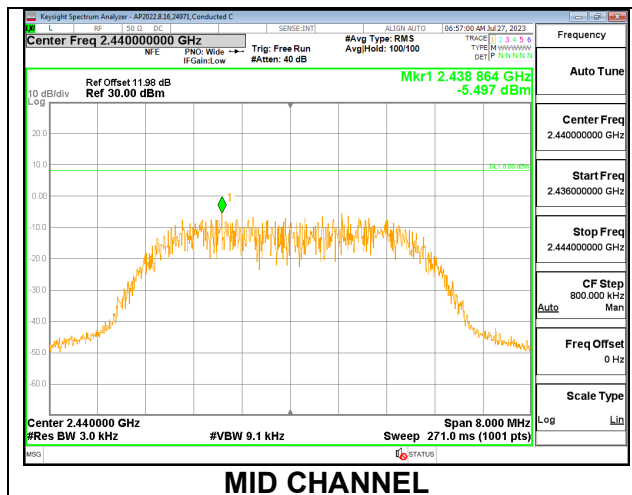

ANT 3

Channel	Frequency (MHz)	PSD (dBm/3kHz)	Limit (dBm/3kHz)	Margin (dB)
Low	2404	-5.311	8	-13.31
Middle	2440	-5.643	8	-13.64
High	2476	-5.322	8	-13.32

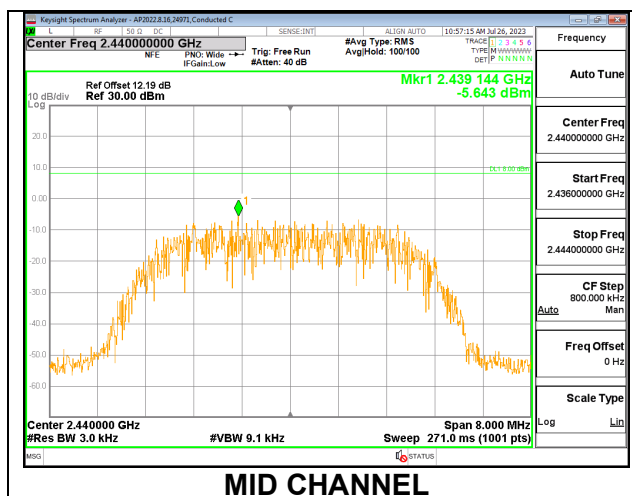

9.7.4. HIGH POWER HDR TXBF (HDR8)

Note: Test procedures and setting are same as HDR normal mode.

PSD Results

Channel	Frequency (MHz)	ANT 4 Meas (dBm/3kHz)	ANT 3 Meas (dBm/3kHz)	Total Corr'd PSD (dBm/3kHz)	Limit (dBm/3kHz)	Margin (dB)
Low	2404	-5.448	-5.507	-2.47	8.0	-10.5
Mid	2440	-5.301	-5.080	-2.18	8.0	-10.2
High	2476	-5.612	-4.923	-2.24	8.0	-10.2

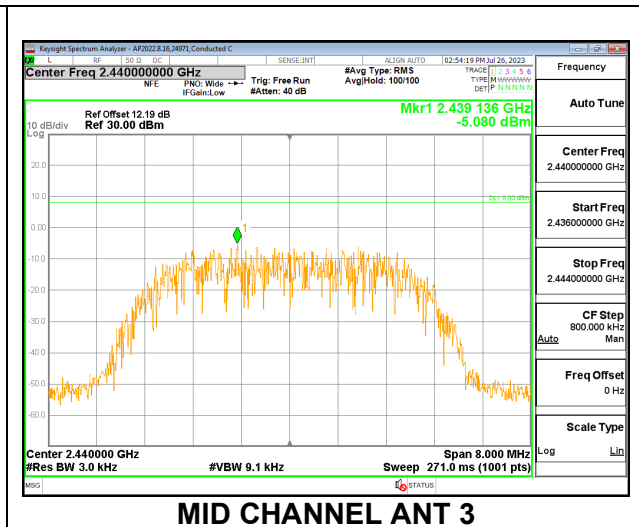
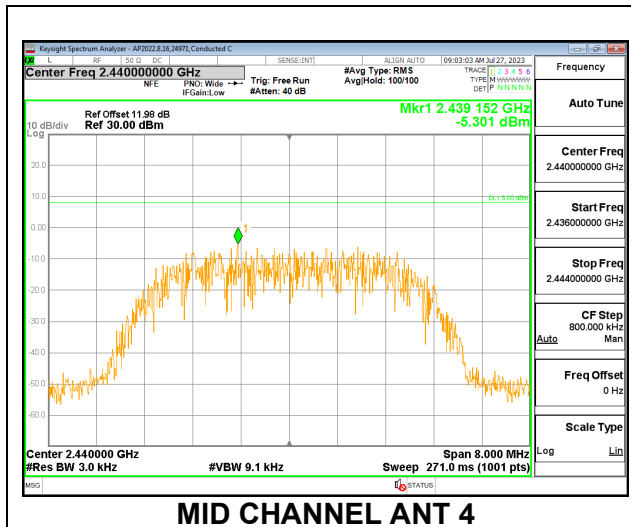

9.8. CONDUCTED SPURIOUS EMISSIONS**LIMITS**

FCC §15.247 (d)

RSS-247 5.5

Output power was measured based on the use of a peak measurement, therefore the required attenuation is 20 dBc.

RESULTS

9.8.1. HIGH POWER HDR (HDR4)

ANT 4

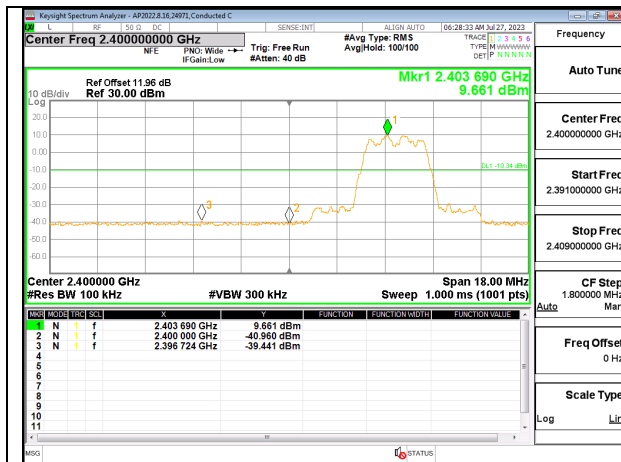

LOW CHANNEL BANDEDGE

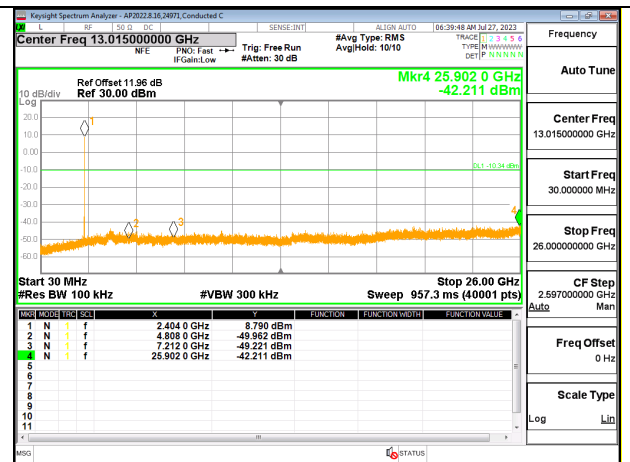

OUT-OF-BAND LOW CHANNEL

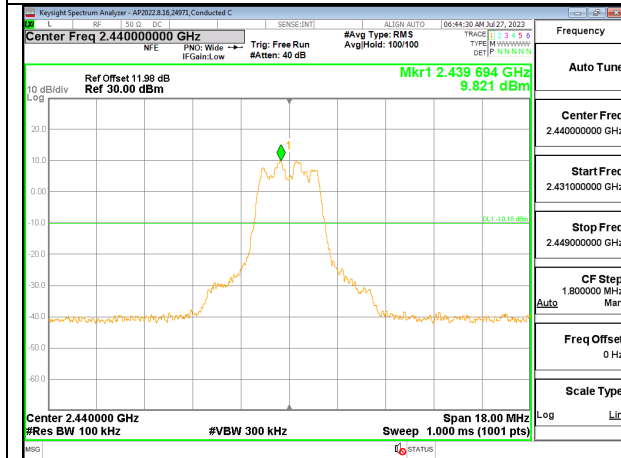

IN-BAND REFERENCE LEVEL

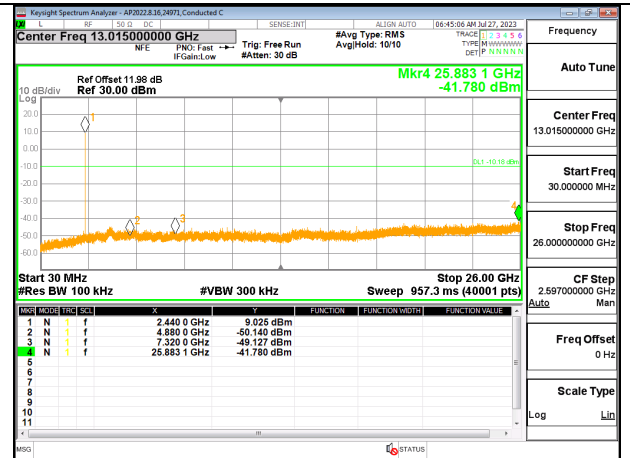

OUT-OF-BAND MID CHANNEL

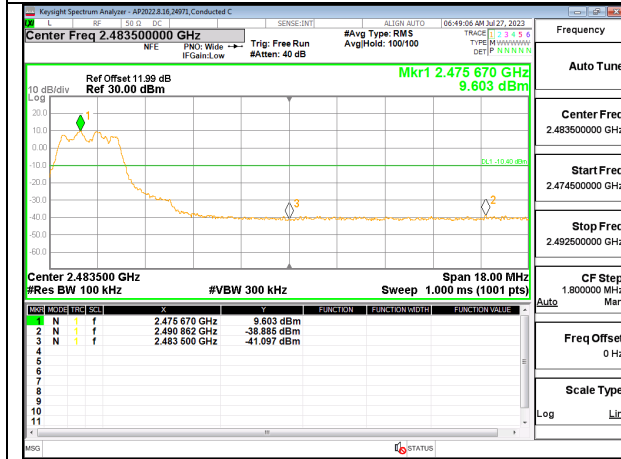

HIGH CHANNEL BANDEDGE

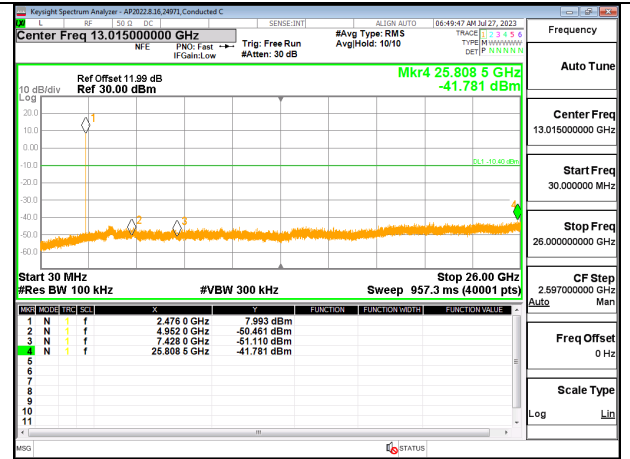

OUT-OF-BAND HIGH CHANNEL

ANT 3

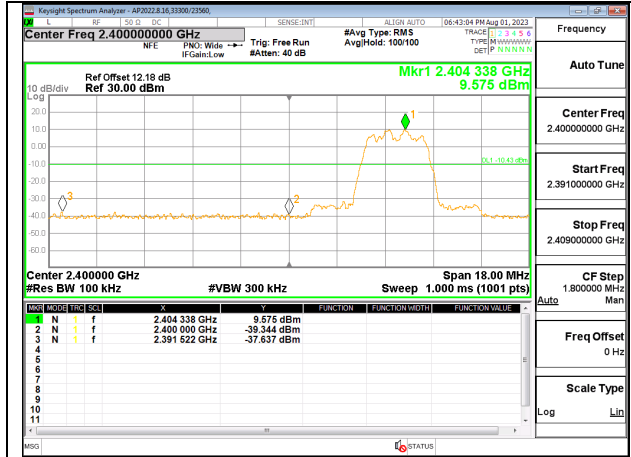

LOW CHANNEL BANDEDGE

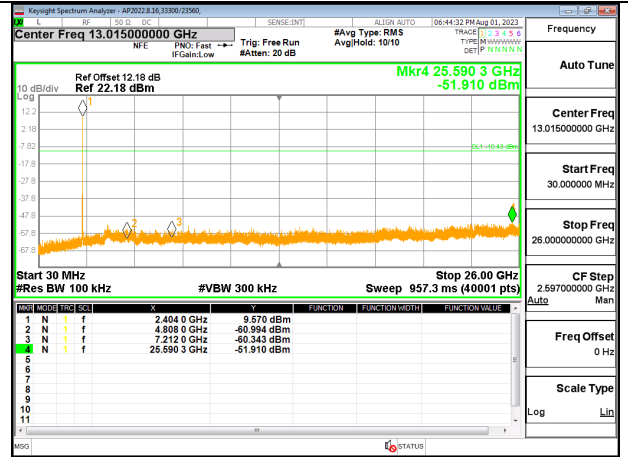

OUT-OF-BAND LOW CHANNEL

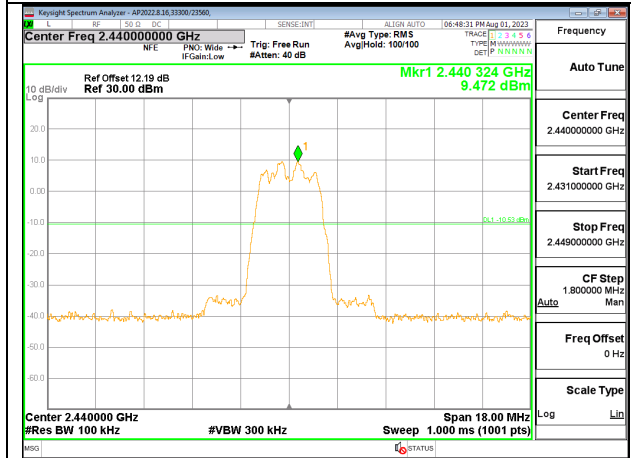

IN-BAND REFERENCE LEVEL

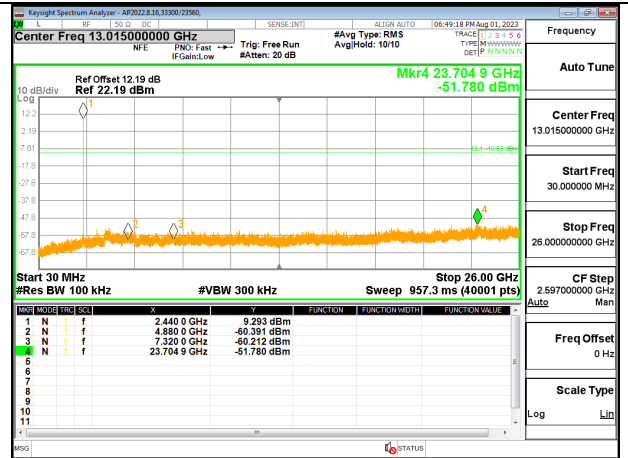

OUT-OF-BAND MID CHANNEL

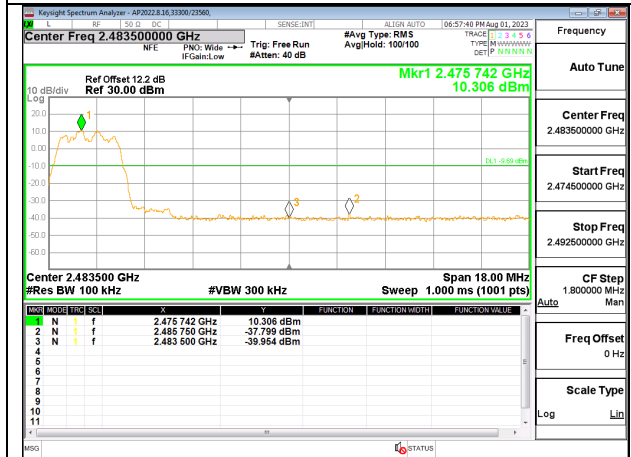

HIGH CHANNEL BANDEDGE

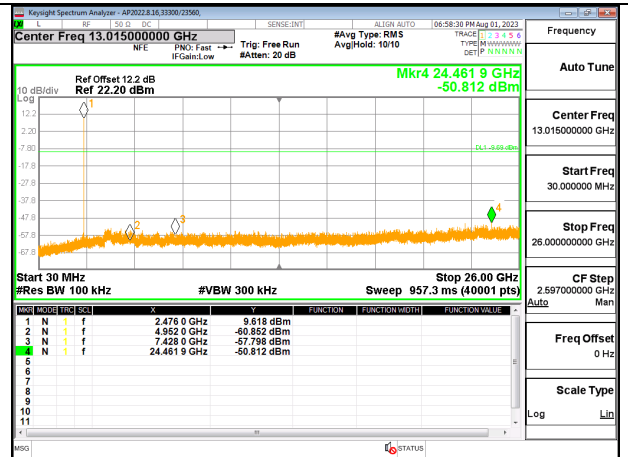

OUT-OF-BAND HIGH CHANNEL

9.8.2. HIGH POWER HDR TXBF (HDR4)

ANT 4

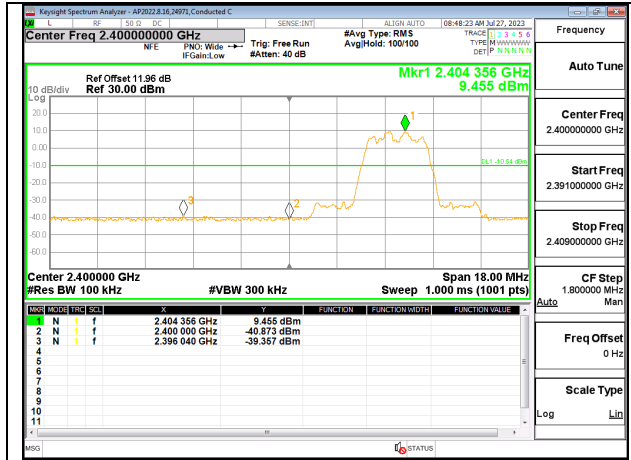

LOW CHANNEL BANDEDGE ANT 4

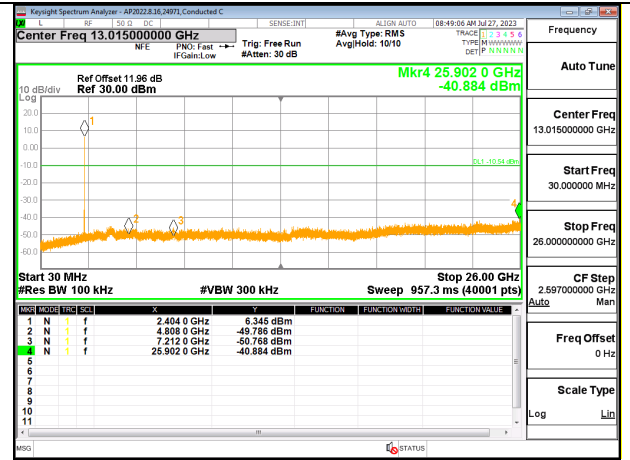

OUT-OF-BAND LOW CHANNEL ANT 4

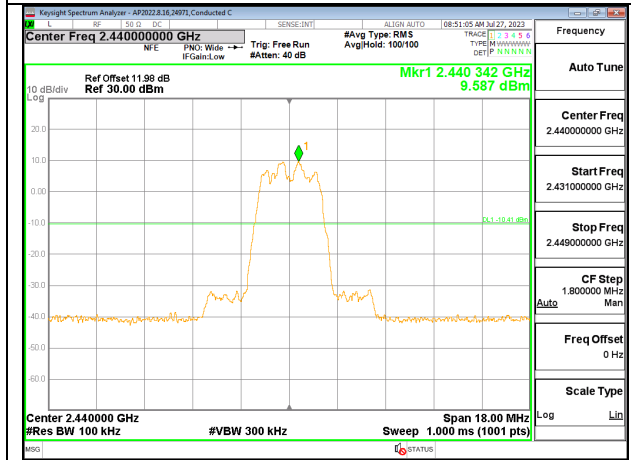

IN-BAND REFERENCE LEVEL ANT 4

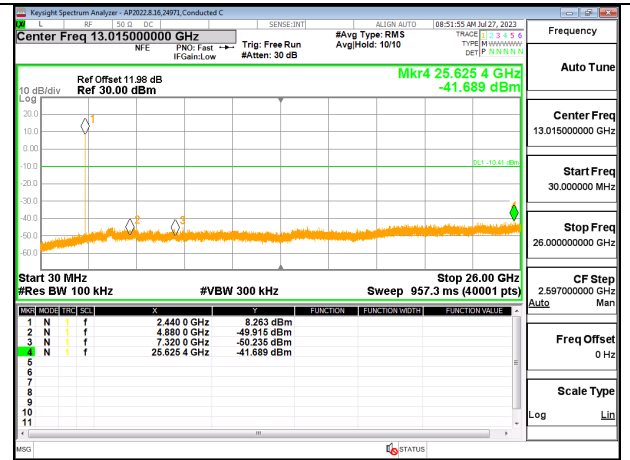

OUT-OF-BAND MID CHANNEL ANT 4

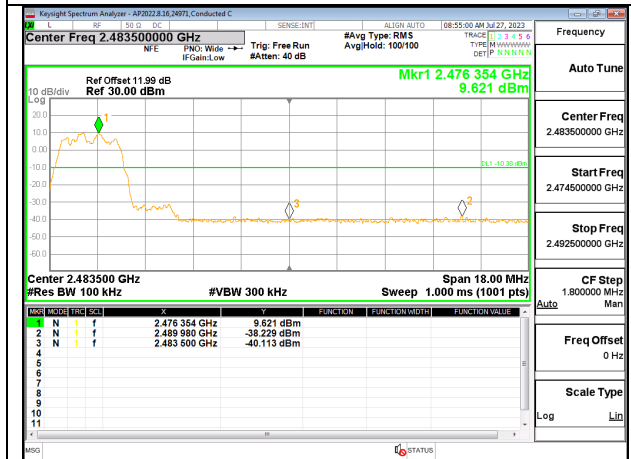

HIGH CHANNEL BANDEDGE ANT 4

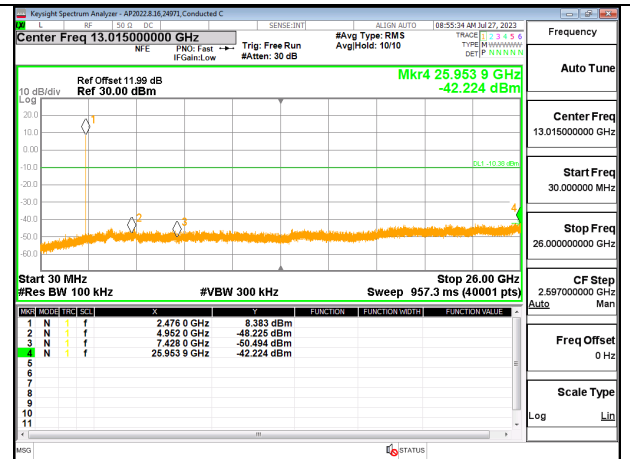

OUT-OF-BAND HIGH CHANNEL ANT 4

ANT 3

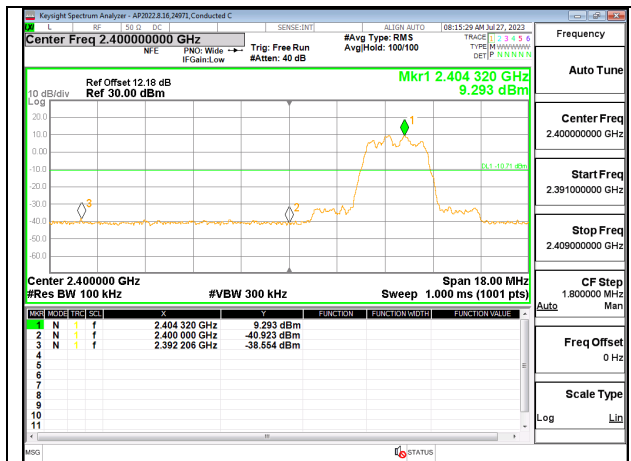

LOW CHANNEL BANDEDGE ANT 3

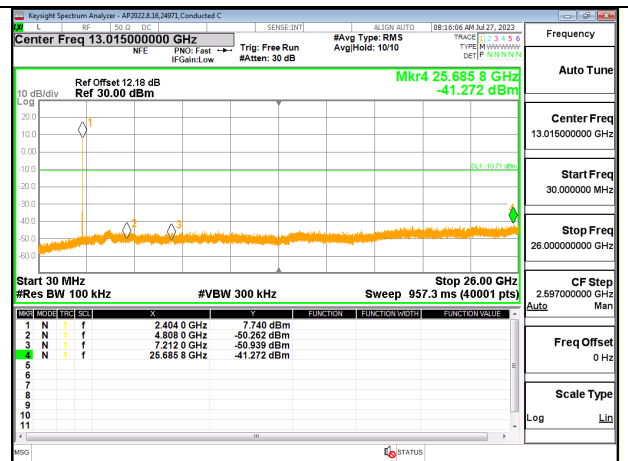

OUT-OF-BAND LOW CHANNEL ANT 3

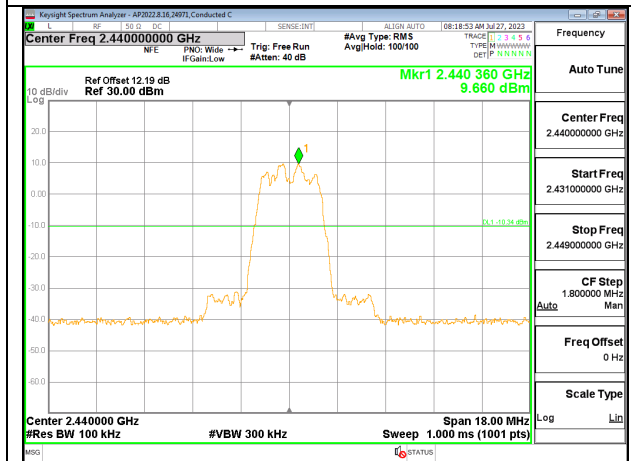

IN-BAND REFERENCE LEVEL ANT 3

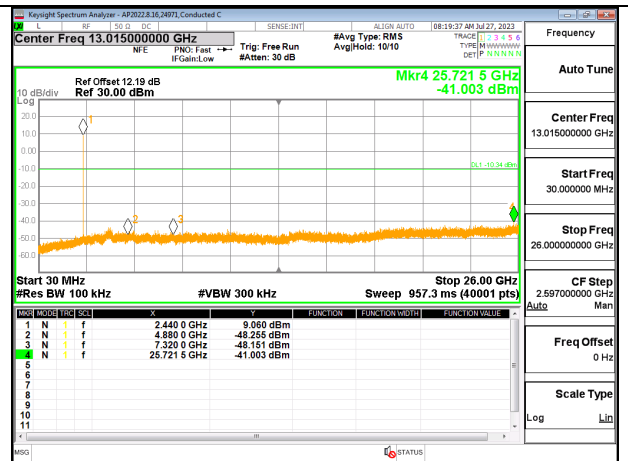

OUT-OF-BAND MID CHANNEL ANT 3

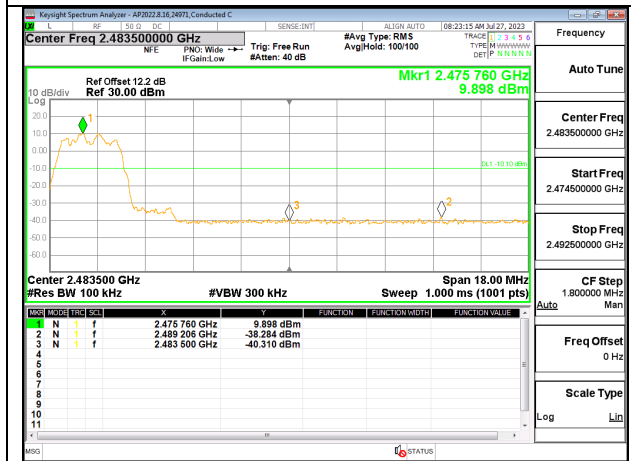

HIGH CHANNEL BANDEDGE ANT 3

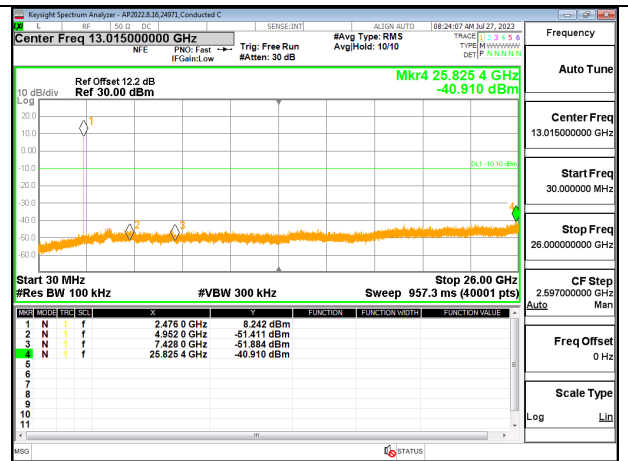

OUT-OF-BAND HIGH CHANNEL ANT 3

9.8.3. HIGH POWER HDR (HDR8)

ANT 4

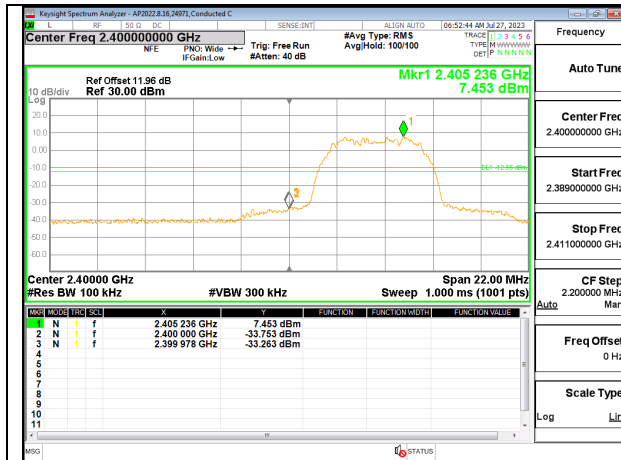

LOW CHANNEL BANDEDGE

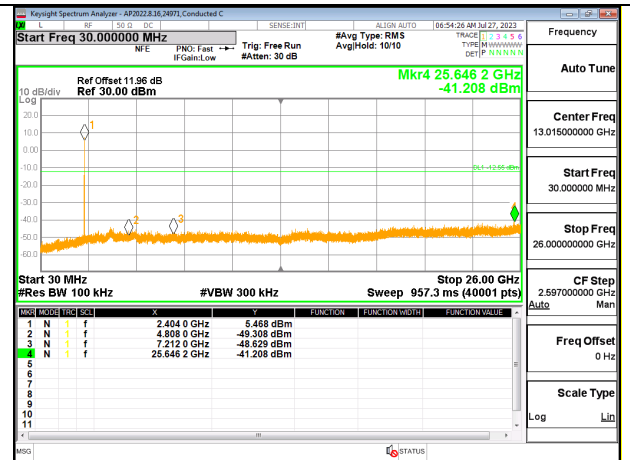

OUT-OF-BAND LOW CHANNEL

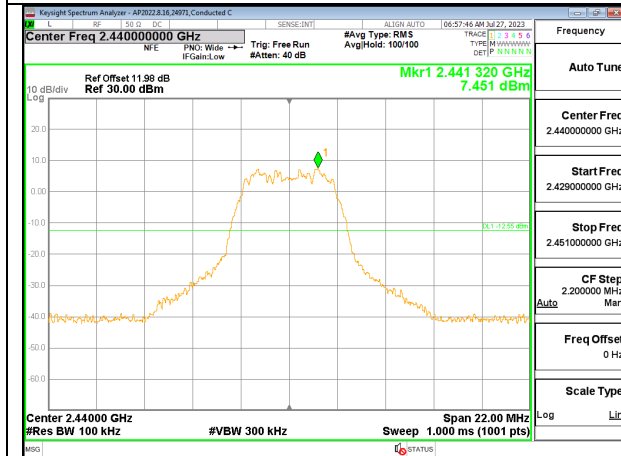

IN-BAND REFERENCE LEVEL

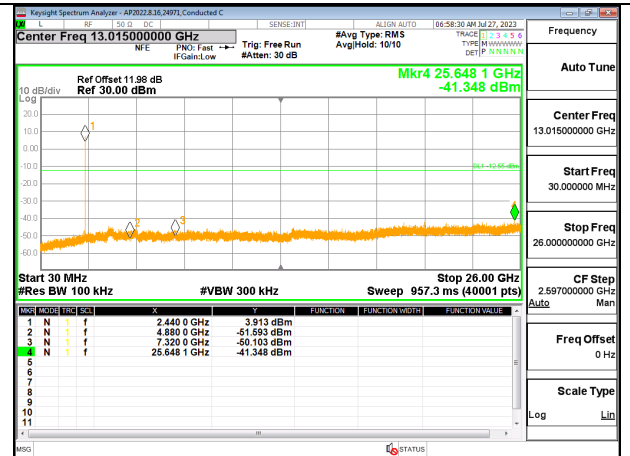

OUT-OF-BAND MID CHANNEL

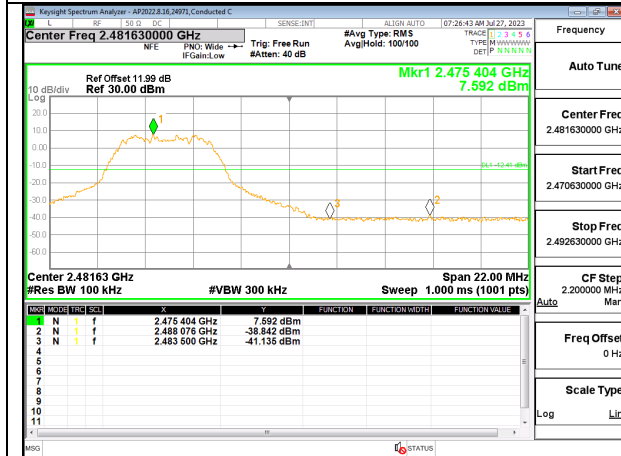

HIGH CHANNEL BANDEDGE

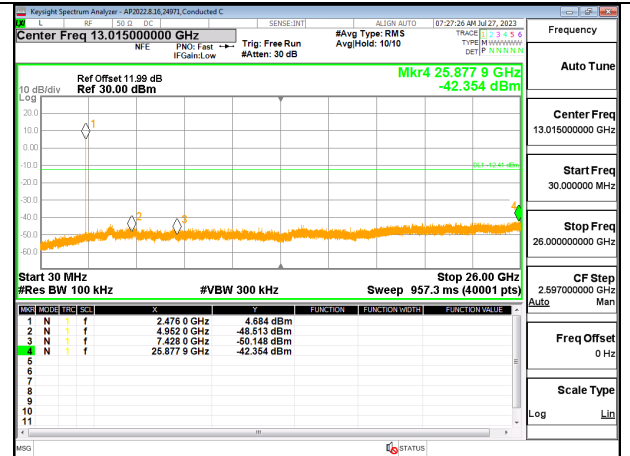

OUT-OF-BAND HIGH CHANNEL

ANT 3

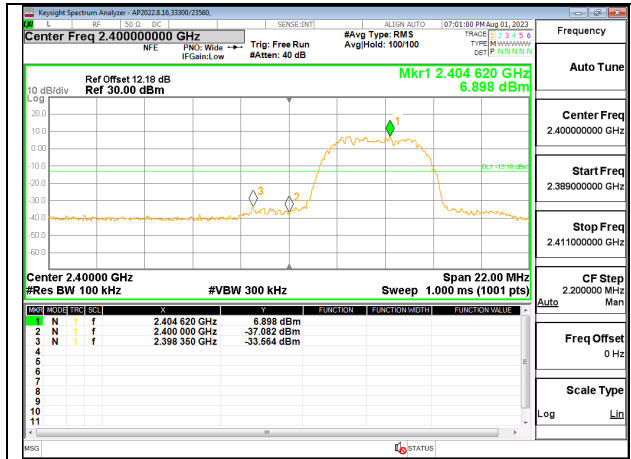

LOW CHANNEL BANDEDGE

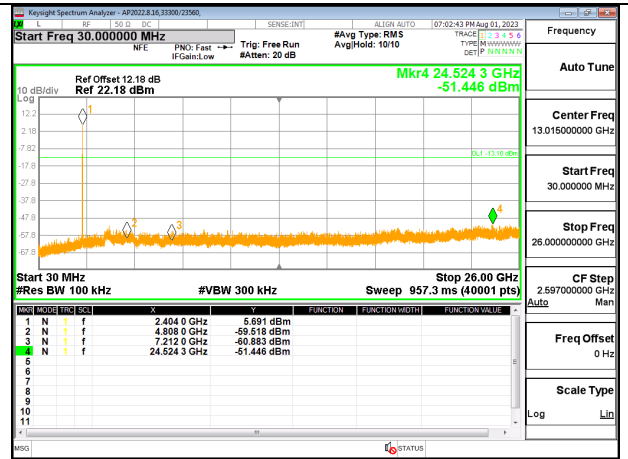

OUT-OF-BAND LOW CHANNEL

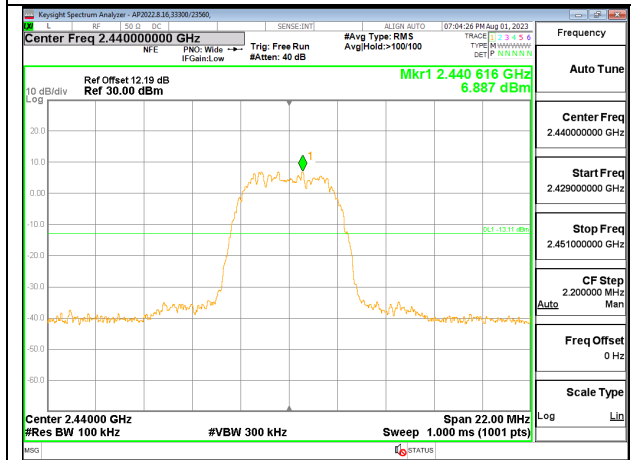

IN-BAND REFERENCE LEVEL

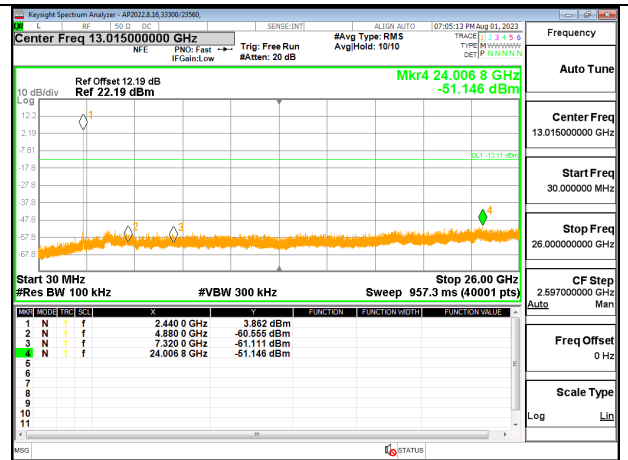

OUT-OF-BAND MID CHANNEL

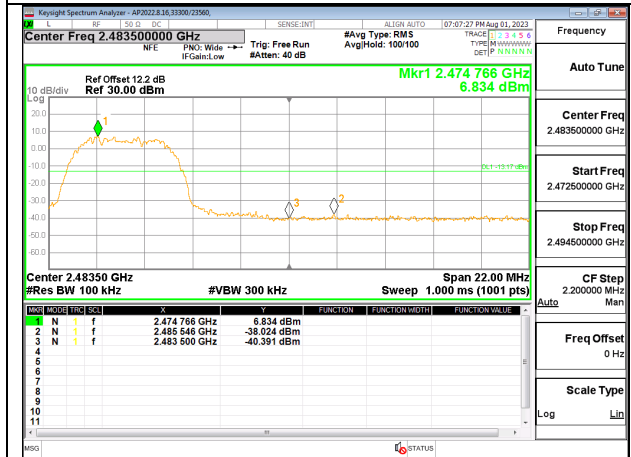

HIGH CHANNEL BANDEDGE

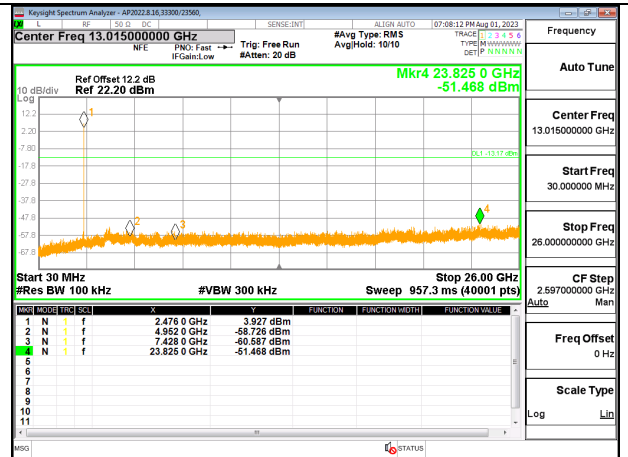

OUT-OF-BAND HIGH CHANNEL

9.8.4. HIGH POWER HDR TXBF (HDR8)

ANT 4

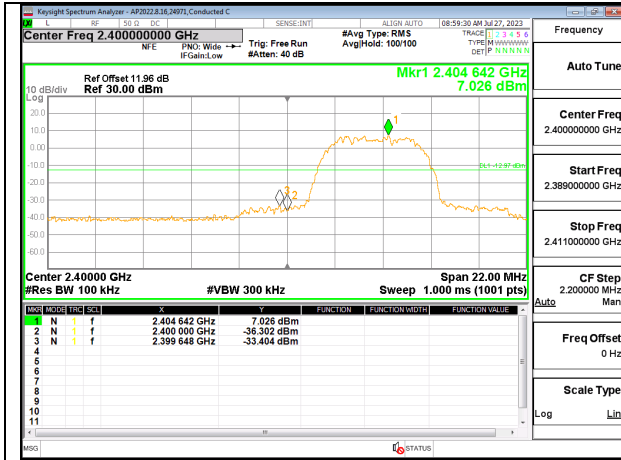

LOW CHANNEL BANDEDGE ANT 4

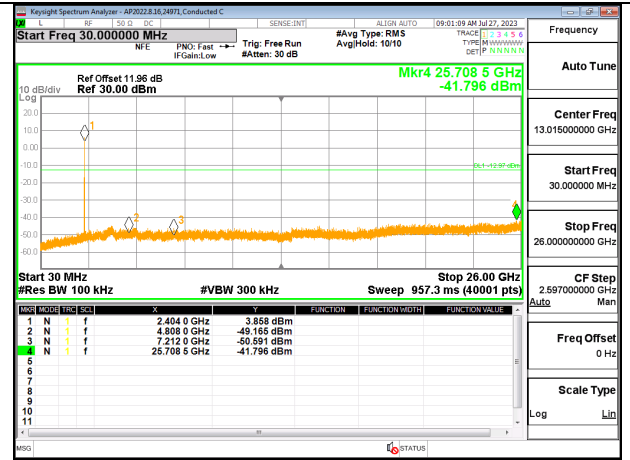

OUT-OF-BAND LOW CHANNEL ANT 4

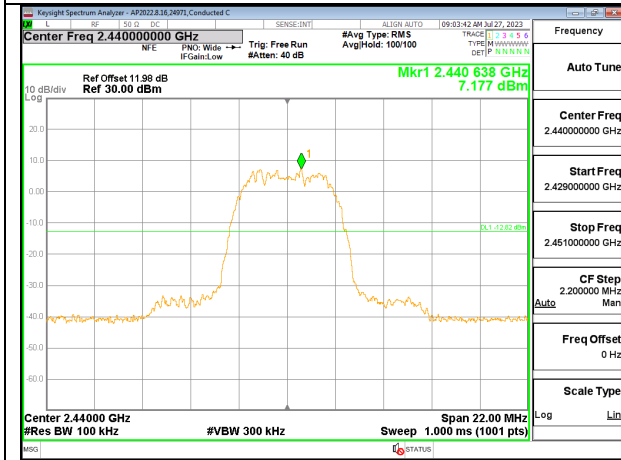

IN-BAND REFERENCE LEVEL ANT 4

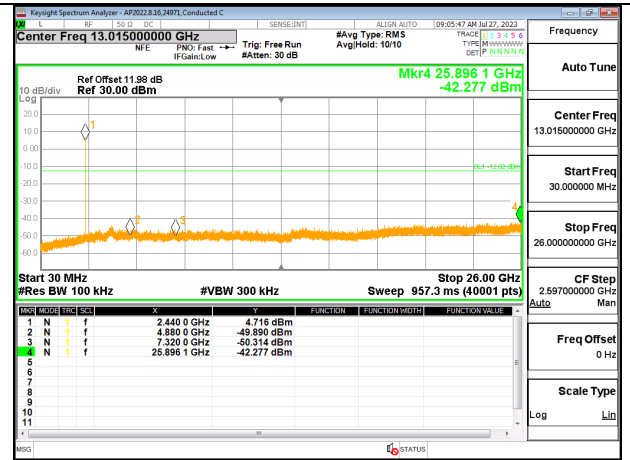

OUT-OF-BAND MID CHANNEL ANT 4

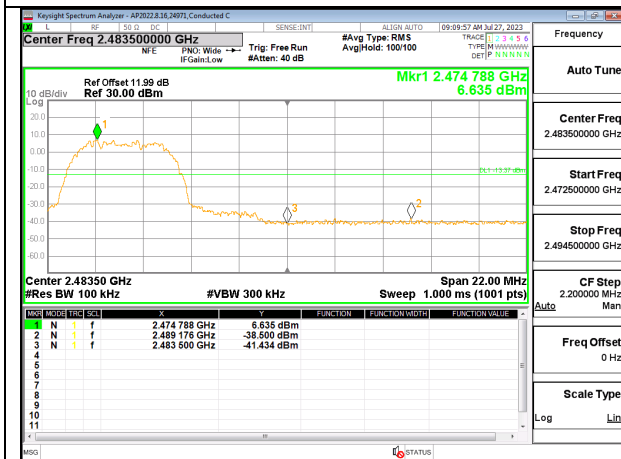

HIGH CHANNEL BANDEDGE ANT 4

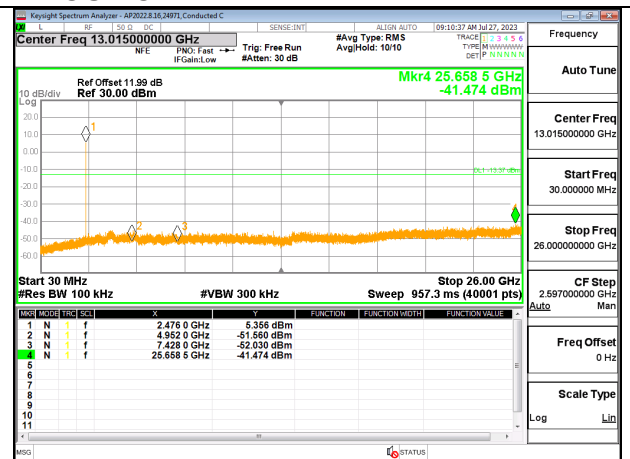

OUT-OF-BAND HIGH CHANNEL ANT 4

ANT 3

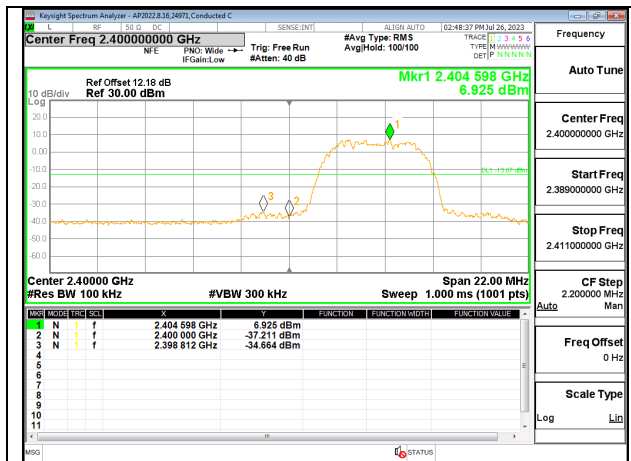

LOW CHANNEL BANDEDGE ANT 3

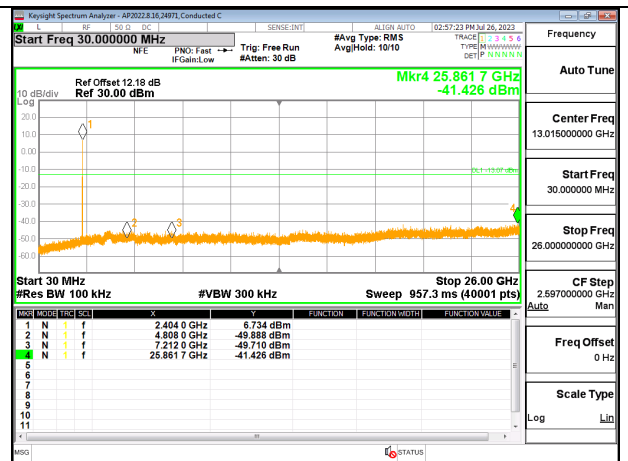

OUT-OF-BAND LOW CHANNEL ANT 3

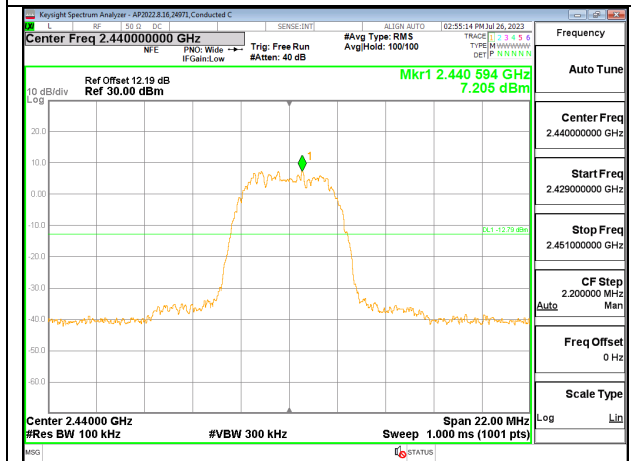

IN-BAND REFERENCE LEVEL ANT 3

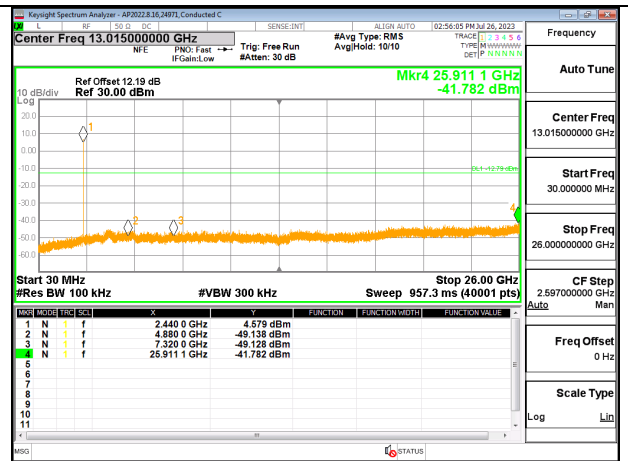

OUT-OF-BAND MID CHANNEL ANT 3

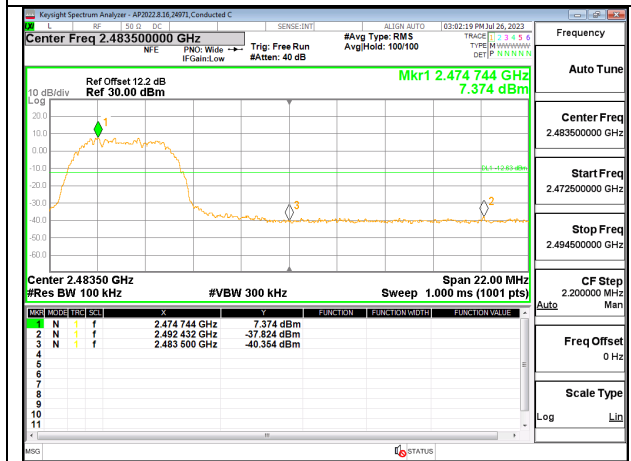

HIGH CHANNEL BANDEDGE ANT 3

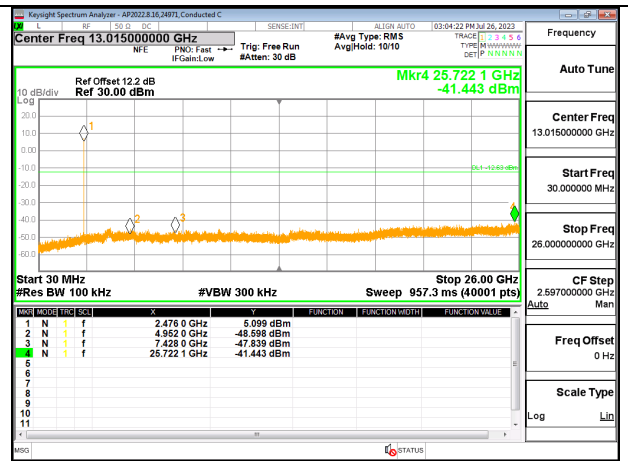

OUT-OF-BAND HIGH CHANNEL ANT 3

9.8.5. LOW POWER HDR (HDR4)

ANT 4

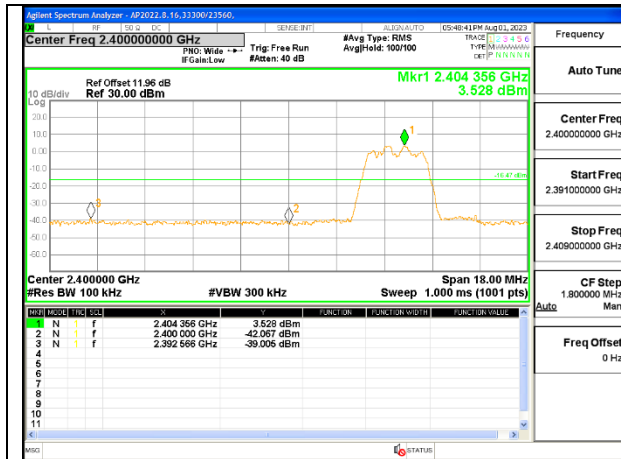

LOW CHANNEL BANDEDGE

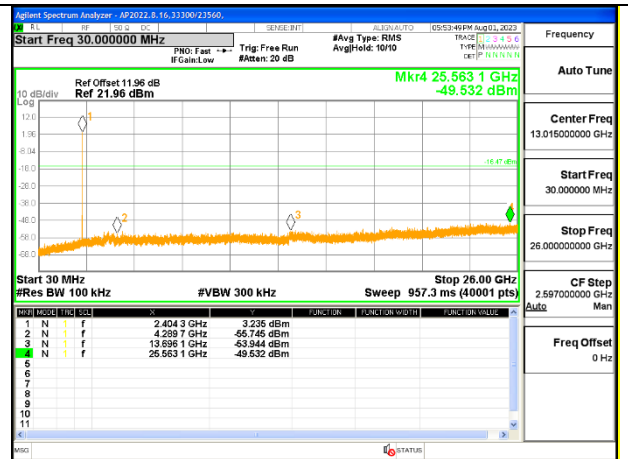

OUT-OF-BAND LOW CHANNEL

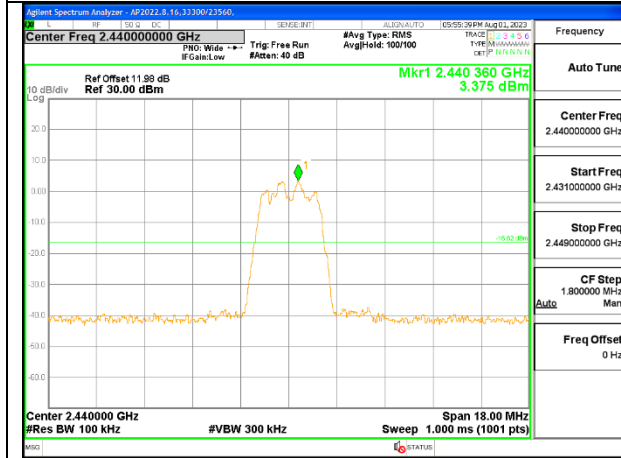

IN-BAND REFERENCE LEVEL

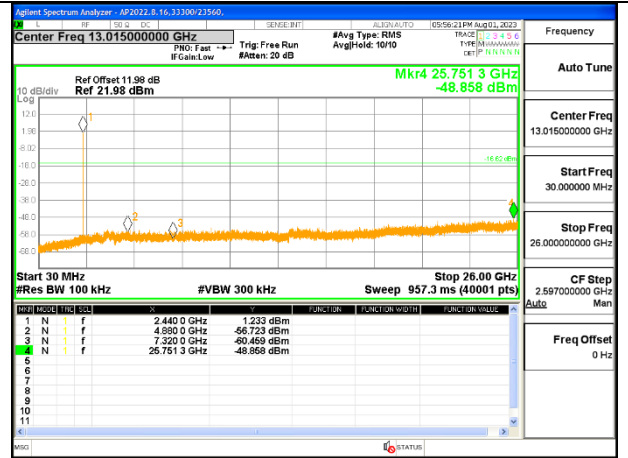

OUT-OF-BAND MID CHANNEL

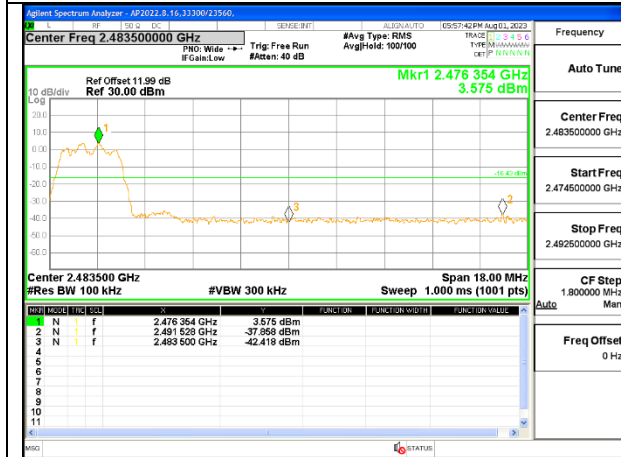

HIGH CHANNEL BANDEDGE

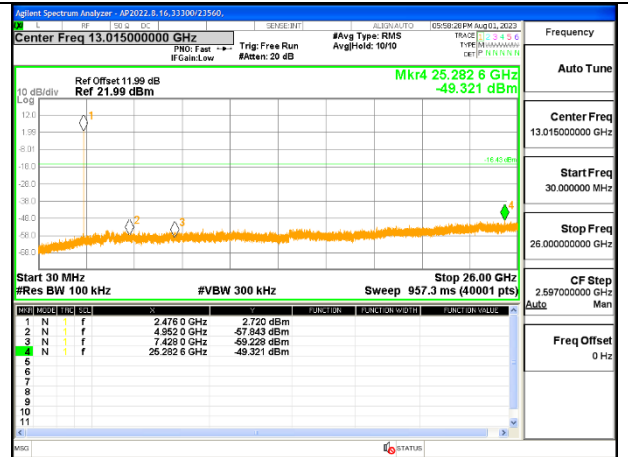

OUT-OF-BAND HIGH CHANNEL

ANT 3

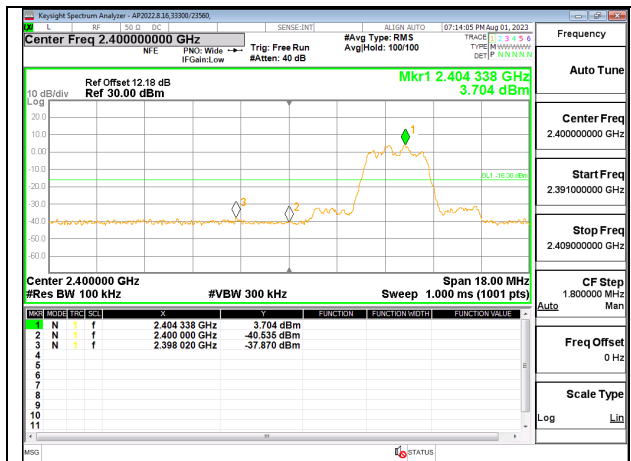

LOW CHANNEL BANDEDGE

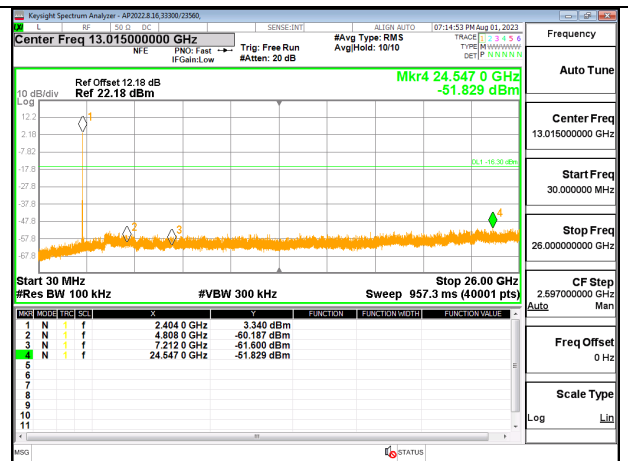

OUT-OF-BAND LOW CHANNEL

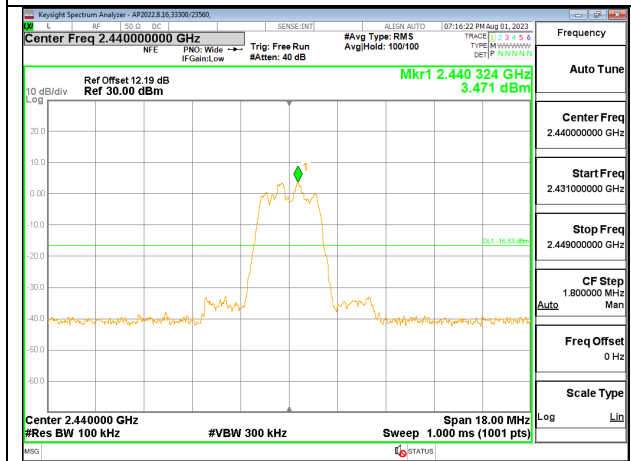

IN-BAND REFERENCE LEVEL

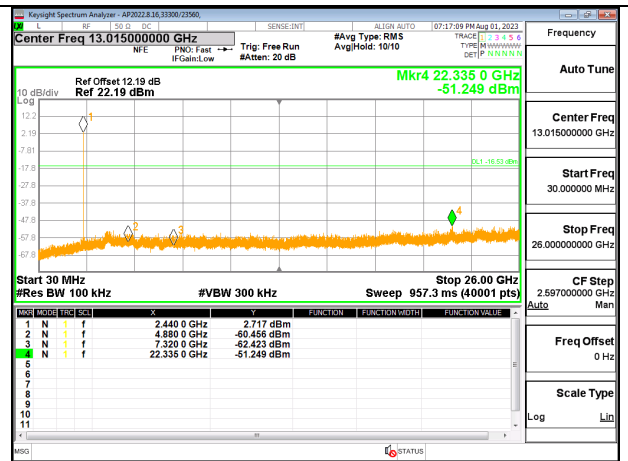

OUT-OF-BAND MID CHANNEL

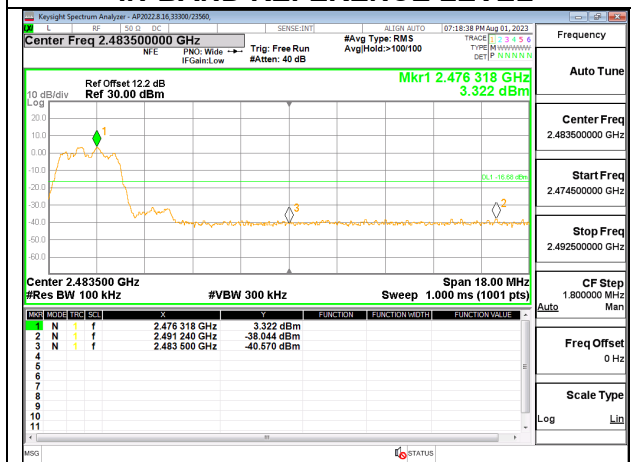

HIGH CHANNEL BANDEDGE

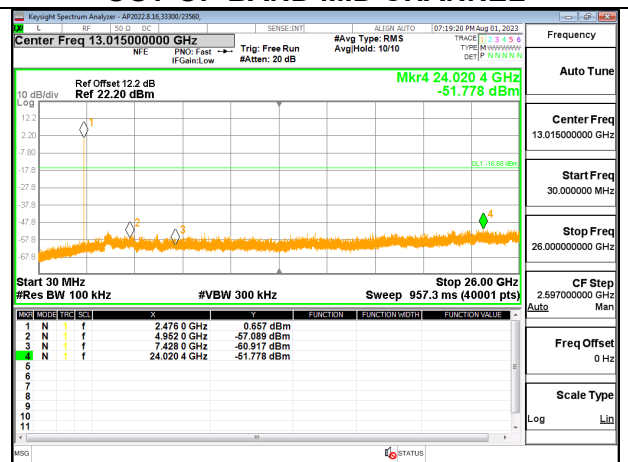

OUT-OF-BAND HIGH CHANNEL

9.8.6. LOW POWER HDR TXBF (HDR4)

ANT 4

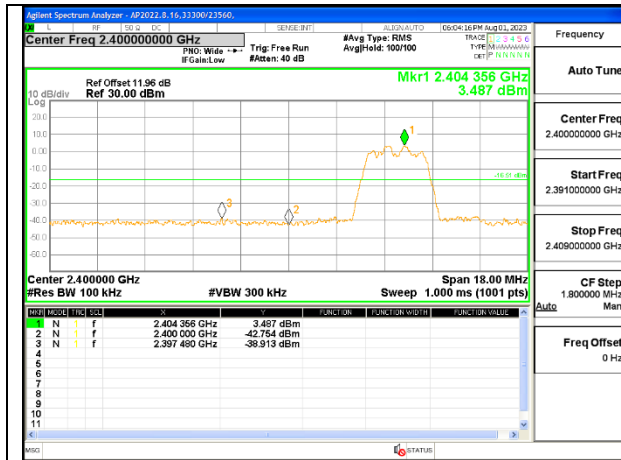

LOW CHANNEL BANDEDGE ANT 4

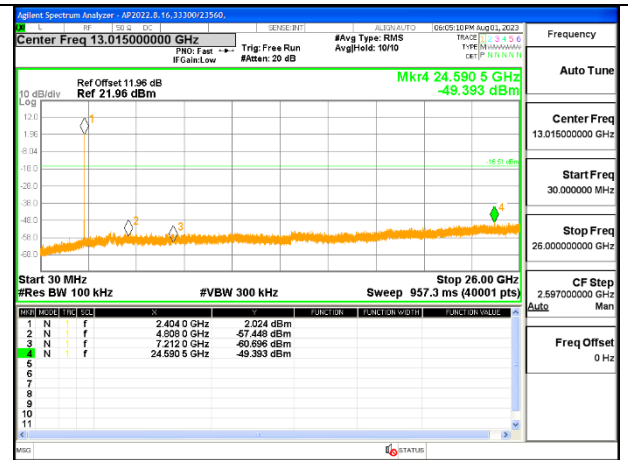

OUT-OF-BAND LOW CHANNEL ANT 4

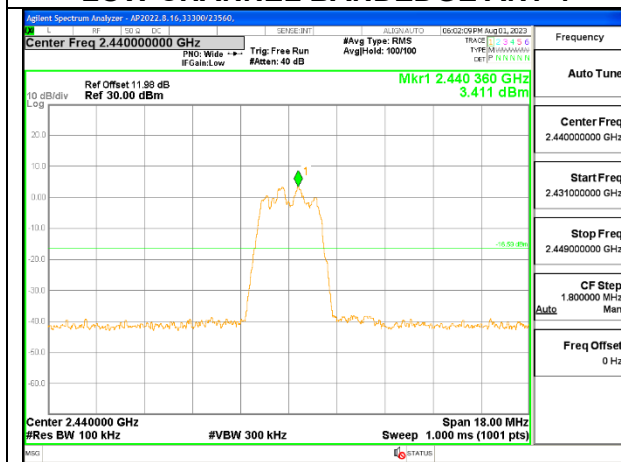

IN-BAND REFERENCE LEVEL ANT 4

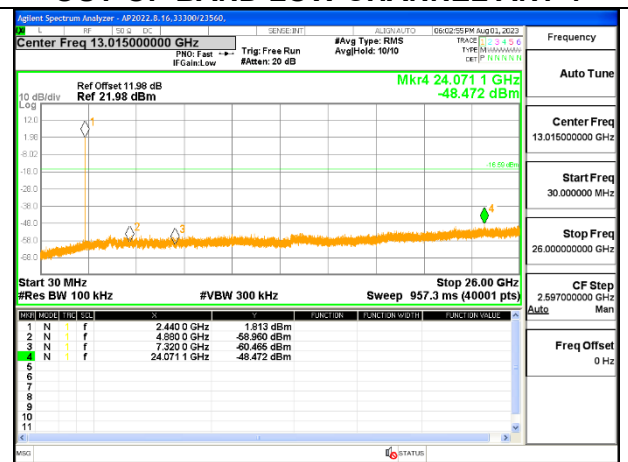

OUT-OF-BAND MID CHANNEL ANT 4

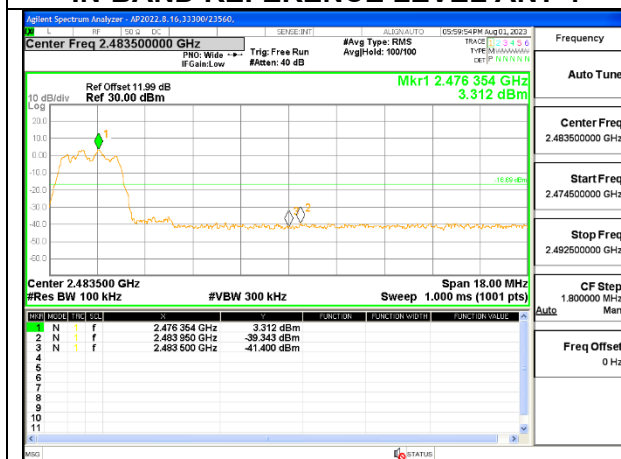

HIGH CHANNEL BANDEDGE ANT 4

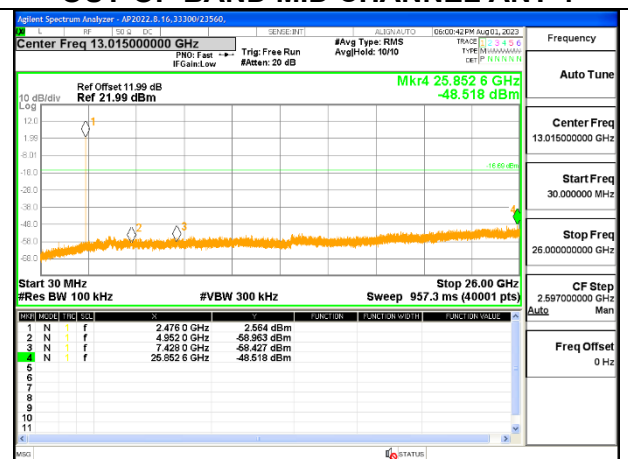

OUT-OF-BAND HIGH CHANNEL ANT 4