



**Part 2: Test Under Dynamic Transmission Condition**

*For*  
**SMARTPHONE**

**FCC ID: BCG-E8141A**  
**Model Name: A2651**

**Report Number: 14040866-S4V3**  
**Issue Date: 8/11/2022**

*Prepared for*  
**APPLE INC.**  
**1 APPLE PARK WAY**  
**CUPERTINO, CA 95014-2084**

*Prepared by*  
**UL VERIFICATION SERVICES INC.**  
**47173 BENICIA STREET**  
**FREMONT, CA 94538, U.S.A.**  
**TEL: (510) 319-4000**  
**FAX: (510) 661-0888**



**Revision History**

Rev.	Date	Revisions	Revised By
V1	8/5/2022	Initial Issue	--
V2	8/9/2022	Updated Table 5-1 with the correct power for n66 for ANT 4	Nathan Sousa
V3	8/11/2022	Updated Tables 5-2 and 6-1 with the correct test information	Nathan Sousa

## Table of Contents

<b>1.</b>	<b>Introduction .....</b>	<b>5</b>
<b>2.</b>	<b>Varying Transmission Test Cases and Test Proposal .....</b>	<b>5</b>
<b>3.</b>	<b>SAR Time Averaging Validation Test Procedures .....</b>	<b>7</b>
3.1.	Test Sequence Determination for Validation .....	7
3.2.	Test Configuration Selection Criteria for Validating Smart Transmit Feature .....	7
3.2.1.	Test Configuration Selection for Time-varying Transmission Power .....	7
3.2.2.	Test Configuration Selection for Change in Call .....	8
3.2.3.	Test Configuration Selection for Change in Technology/Band .....	8
3.2.4.	Test Configuration Selection for Change in Antenna .....	9
3.2.5.	Test Configuration Selection for Change in DSI .....	9
3.2.6.	Test Configuration Selection for Change in Time Window .....	10
3.2.7.	Test Configuration Selection for SAR Exposure Switching .....	10
3.3.	Test Procedures for Conducted Power Measurements .....	11
3.3.1.	Time-varying Transmission Power Scenario .....	11
3.3.2.	Change in Call Scenario .....	12
3.3.3.	Change in Technology and Band .....	13
3.3.4.	Change in Antenna .....	14
3.3.5.	Change in DSI .....	14
3.3.6.	Change in Time Window .....	14
3.3.7.	SAR Exposure Switching .....	15
3.4.	Test Procedure for Time-varying SAR Measurements .....	16
<b>4.</b>	<b>PD Time Averaging Validation Test Procedures .....</b>	<b>17</b>
4.1.	Test Sequence for Validation in mmW NR Transmission .....	17
4.2.	Test Configuration Selection Criteria for Validating Smart Transmit Feature .....	17
4.2.1.	Test Configuration Selection for Time-varying Transmission Power .....	17
4.2.2.	Test Configuration Selection for Change in Antenna Configuration (Beam) .....	17
4.2.3.	Test Configuration Selection for SAR versus PD Exposure Switch during Transmission .....	17
4.3.	Test Procedures for mmW Radiated Power Measurements .....	17
4.3.1.	Time-varying Transmission Power Scenario .....	18
4.3.2.	Switch in SAR vs. PD Exposure during Transmission .....	18
4.3.3.	Change in Antenna Configuration (Beam) .....	19
4.4.	Test Procedure for Time-varying PD Measurements .....	20
<b>5.</b>	<b>Test Configurations .....</b>	<b>22</b>
5.1.	WWAN (Sub-6 GHz) Transmission .....	22
5.2.	LTE + mmW NR Transmission .....	25
<b>6.</b>	<b>Conducted Power Test Results for Sub-6 GHz Smart Transmit Feature Validation .....</b>	<b>26</b>
6.1.	Measurement Setup .....	26
6.2.	$P_{limit}$ and $P_{max}$ Measurement Results .....	26
6.3.	Time-varying Transmission Power Measurement Results .....	28

6.3.1. GPRS PCS Antenna 1 (Test case 1 in Table 5-2).....29

6.3.2. W-CDMA Band IV Antenna 1 (Test Case 3 in Table 5-2).....30

6.3.3. LTE Band 66 Antenna 1 (Test Case 5 in Table 5-2).....31

6.3.4. NR Band n41 Antenna 3 (Test Case 8 in Table 5-2).....32

6.4. Call Drop Test Results (Test Case 9 in Table 5-2).....33

6.5. Change in Technology/Band Test Results (Test Case 10 in Table 5-2) .....34

6.6. Change in DSI Test Results (Test Case 11 in Table 5-2).....35

6.7. Change in Time Window/Antenna Switch Test Results (Test Case 12 in Table 5-2) .....36

6.7.1. Transition from LTE 66 to LTE 48 (i.e., 100 seconds to 60 seconds), then Back to LTE 66.....36

6.8. Switch in SAR Exposure Test Results.....37

6.8.1. Test Case 1: EN-DC Switch between LTE 66/4 and NR n25 (Test Case 13 in Table 5-2).....37

6.8.2. Test Case 2: Uplink CA Switch between LTE 5 Antenna 1 and LTE 66/4 Antenna 4 (Test Case 14 in Table 5-2).....38

**7. SAR Test Results for Sub-6 GHz Smart Transmit Feature Validation .....39**

**8. Radiated Power Test Results for mmW Smart Transmit Feature Validation .....39**

**9. PD Test Results for mmW Smart Transmit Feature Validation .....39**

**Appendices.....40**

A Test Sequences .....40

B Test Procedures for Sub-6 GHz NR + Sub-6 GHz Radio.....42

B.1 Time-varying Transmission Power Test for Sub-6 GHz NR in NSA Mode.....42

B.2 Switch in SAR Exposure Between Sub-6 GHz vs. Sub-6 GHz NR during Transmission.....42

C Test Setup Photos .....43

**Figures**

Figure 3-1: 100 seconds running average illustration.....12

Figure 6-1a – 6-1c: Conducted power measurement setup .....27

Figure A-1: Test Sequence 1 waveform .....40

Figure A-2: Test Sequence 2 waveform .....41

**Tables**

Table 5-1: Plimit for supported technologies and bands (Plimit in EFS file).....23

Table 5-2: Radio configurations selected for Part 2 .....24

Table 5-3: Selections for LTE + mmW NR validation measurements .....25

Table 5-4: Test configuration for LTE + mmW NR validation .....25

Table 6-1: Measured  $P_{limit}$  and  $P_{max}$  Of Selected Radio Configurations .....26

Table 9-1: Test Sequence 2.....41

## 1. Introduction

The equipment under test (EUT) contains the Qualcomm SDX-65 modem supporting 2G/3G/4G/5G technologies as well as supporting mmW 5G NR bands. Both WWAN modems are enabled with Qualcomm's Smart Transmit feature with algorithms to control and manage transmitting power in real time and to ensure the time-averaged RF exposure from the WWAN modems are always in compliance with FCC requirements.

In addition to these WWAN modems, the EUT contains a different modem to support WLAN.

The purpose of this Part 2 report is to demonstrate that the EUT complies with the FCC RF exposure requirement under varying transmission scenarios, thereby validating the Qualcomm Smart Transmit feature.

The  $P_{limit}$  and *input.power.limit* used in this report are determined and listed in the Part 0 and Part 1 reports.

Refer to Compliance Summary report for product description and terminology used in this report.

## 2. Varying Transmission Test Cases and Test Proposal

To validate time averaging feature and demonstrate the compliance in varying transmission conditions, the following transmission scenarios are covered in Part 2 tests:

1. During a time-varying Tx power transmission: Prove that the Smart Transmit feature accounts for Tx power variations in time accurately.
2. During a call disconnect and re-establish scenario: Prove that the Smart Transmit feature accounts for history of past Tx power transmissions accurately.
3. During technology/band handover: Prove that the Smart Transmit feature functions correctly during transitions in technology/band.
4. During DSI (Device State Index) change: Prove that the Smart Transmit feature functions correctly during transition from one DSI to another.
5. During antenna (or beam) switch: Prove that the Smart Transmit feature functions correctly during transitions in antenna (such as AsDiv scenario) or beams (different antenna array configurations).
6. SAR vs. PD exposure switching during Sub-6 + mmW transmission: Prove that the Smart Transmit feature functions correctly and ensures total RF exposure compliance during transitions in SAR dominant exposure, SAR + PD exposure, and PD dominant exposure scenarios.
7. During time window switch: Prove that the Smart Transmit feature correctly handles the transition from one time window to another specified by FCC while maintaining the normalized time-averaged RF exposure to be less than the design limit of 1.0 W/kg at all times.
8. SAR exposure switching between two active radios (*radio1* and *radio2*): Prove that the Smart Transmit feature functions correctly and ensures total RF exposure compliance when exposure varies among *SAR\_radio1* only, *SAR\_radio1* + *SAR\_radio2*, and *SAR\_radio2* only scenarios.

As described in the Part 0 report, the RF exposure is proportional to the transmission power for a SAR- and PD-characterized wireless device. Thus, feature validation in Part 2 can be effectively performed through conducted (for  $f < 6\text{GHz}$ ) and radiated (for  $f \geq 6\text{GHz}$ ) power measurement. Therefore, the compliance demonstration under dynamic transmission conditions and feature validation are done in conducted/radiated power measurement setups for transmission scenarios 1 through 8.

To add confidence in the feature validation, the time-averaged SAR and PD measurements are also performed but only performed for transmission scenario 1 to avoid the complexity in SAR and PD measurement (such as, for scenario 3, requiring change in SAR probe calibration file to accommodate different bands and/or tissue simulating liquid).

The strategy for testing in varying transmission conditions are outlined as follows:

- Demonstrate the total RF exposure averaged over FCC's defined time windows do not exceed FCC's SAR and PD limits through time-averaged power measurements.
  - Measure conducted Tx power (for  $f < 6\text{GHz}$ ) versus time, and radiated Tx power (EIRP for  $f > 10\text{GHz}$ ) versus time.
  - Convert the conducted Tx power into RF exposure and divide by the respective FCC limits to get the normalized exposure versus time.

- Perform the running time-averaging over the FCC's defined time windows.
- Demonstrate that the total normalized time-averaged RF exposure is less than 1 W/kg for all transmission scenarios (i.e., transmission scenarios 1 through 8), always.

Mathematical expression:

- For Sub-6 GHz transmission scenarios only:

$$1g \text{ or } 10g \text{ SAR}(t) = \frac{\text{conducted Tx power}(t)}{\text{conducted Tx power } P_{limit}} * 1g \text{ or } 10g \text{ SAR } P_{limit} \text{ (1a)}$$

$$\frac{\frac{1}{T_{SAR}} \int_{t-T_{SAR}}^t 1g \text{ or } 10g \text{ SAR}(t) dt}{FCC \text{ SAR limit}} \leq 1 \text{ (1b)}$$

- For Sub-6 GHz + mmW transmission:

$$1g \text{ or } 10g \text{ SAR}(t) = \frac{\text{conducted Tx power}(t)}{\text{conducted Tx power } P_{limit}} * 1g \text{ or } 10g \text{ SAR } P_{limit} \text{ (2a)}$$

$$4 \text{ cm}^2 \text{ PD}(t) = \frac{\text{radiated Tx power}(t)}{\text{radiated Tx power input.power.limit}} * 4 \text{ cm}^2 \text{ PD input.power.limit} \text{ (2b)}$$

$$\frac{\frac{1}{T_{SAR}} \int_{t-T_{SAR}}^t 1g \text{ or } 10g \text{ SAR}(t) dt}{FCC \text{ SAR limit}} + \frac{\frac{1}{T_{PD}} \int_{t-T_{PD}}^t 4 \text{ cm}^2 \text{ PD}(t) dt}{FCC 4 \text{ cm}^2 \text{ PD limit}} \leq 1 \text{ (2c)}$$

where, *conducted Tx power(t)*, *conducted Tx power P<sub>limit</sub>*, and *1gSAR P<sub>limit</sub>* correspond to the measured instantaneous conducted Tx power, measured conducted Tx power at P<sub>limit</sub>, and measured 1g SAR values at P<sub>limit</sub> corresponding to Sub-6 GHz transmission. Similarly, *radiated Tx power(t)*, *radiated Tx power input.power.limit*, and *4 cm<sup>2</sup> PD input.power.limit* correspond to the measured instantaneous radiated Tx power, radiated Tx power at *input.power.limit* (i.e., radiated power limit), and 4 cm<sup>2</sup> PD value at *input.power.limit* corresponding to mmW transmission. Both P<sub>limit</sub> and *input.power.limit* are the parameters pre-defined in Part 0 and loaded via *Embedded File System* (EFS) onto the EUT. T<sub>SAR</sub> is the FCC defined time window for Sub-6 GHz radio; T<sub>PD</sub> is the FCC defined time window for mmW radio.

- Demonstrate the total RF exposure averaged over FCC's defined time windows do not exceed FCC's SAR and PD limits through time-averaged SAR and PD measurements. Note, as mentioned earlier, this measurement is performed for transmission scenario 1 only.
  - For Sub-6 GHz transmission only: Measure instantaneous SAR versus time; for LTE + Sub-6 GHz NR transmission: Request low power (or all-down bits) on LTE so that measured SAR predominantly corresponds to Sub-6 GHz NR.
  - For LTE + mmW transmission: Measure instantaneous E-field versus time for mmW radio and instantaneous conducted power versus time for the LTE radio.
  - Convert the result into RF exposure and divide by the respective FCC limits to obtain the normalized exposure versus time.
  - Perform time averaging over FCC defined time window.
  - Demonstrate that the total normalized time-average RF exposure is less than 1 W/kg for transmission scenario 1, always.

Mathematical expression:

- For Sub-6 GHz transmission only:

$$1g \text{ or } 10g \text{ SAR}(t) = \frac{\text{pointSAR}(t)}{\text{pointSAR } P_{limit}} * 1g \text{ or } 10g \text{ SAR}(t) P_{limit} \text{ (3a)}$$

$$\frac{\frac{1}{T_{SAR}} \int_{t-T_{SAR}}^t 1g \text{ or } 10g \text{ SAR}(t) dt}{FCC \text{ SAR limit}} \leq 1 \text{ (3b)}$$

- For LTE + mmW transmission:

$$1g \text{ or } 10g \text{ SAR}(t) = \frac{\text{conducted Tx power}(t)}{\text{conducted Tx power } P_{limit}} * 1g \text{ or } 10g \text{ SAR } P_{limit} \text{ (4a)}$$

$$4 \text{ cm}^2 \text{ PD}(t) = \frac{[\text{pointE}(t)]^2}{[\text{pointE input.power.limit}]^2} * 4 \text{ cm}^2 \text{ PD input.power.limit} \text{ (4b)}$$

$$\frac{\frac{1}{T_{SAR}} \int_{t-T_{SAR}}^t 1g \text{ or } 10g \text{ SAR}(t) dt}{FCC \text{ SAR limit}} + \frac{\frac{1}{T_{PD}} \int_{t-T_{PD}}^t 4 \text{ cm}^2 \text{ PD}(t) dt}{FCC 4 \text{ cm}^2 \text{ PD limit}} \leq 1 \text{ (4c)}$$

where,  $\text{pointSAR}(t)$ ,  $\text{pointSAR } P_{limit}$ , and  $1g\text{SAR } P_{limit}$  correspond to the measured instantaneous point SAR, measured point SAR at  $P_{limit}$ , and measured 1g SAR values at  $P_{limit}$  corresponding to Sub-6 GHz transmission. Similarly,  $\text{pointE}(t)$ ,  $\text{pointE input.power.limit}$ , and  $4 \text{ cm}^2 \text{ PD input.power.limit}$  correspond to the measured instantaneous E-field, E-field at  $\text{input.power.limit}$ , and  $4 \text{ cm}^2 \text{ PD}$  value at  $\text{input.power.limit}$  corresponding to mmW transmission.<sup>1</sup>

### 3. SAR Time Averaging Validation Test Procedures

This chapter provides the test plan and test procedures for validating Qualcomm Smart Transmit feature for Sub-6 GHz transmission. The 100 seconds time window for operating  $f < 3$  GHz is used as an example to detail the test procedures in this chapter. The same test plan and test procedures described in this chapter apply to 60 seconds time window for operating  $f \geq 3$ GHz.

#### 3.1. Test Sequence Determination for Validation

Following the FCC recommendation, two test sequences<sup>2</sup> having time-variation in Tx power are predefined for sub-6 GHz ( $f < 6$  GHz) validation:

- Test sequence 1: Request EUT's Tx power to be at maximum power, measured  $P_{max}$ , for 80s, then requesting for half of the maximum power, i.e., measured  $P_{max}/2$ , for the rest of the time.
- Test sequence 2: Request EUT's Tx power to vary with time. This sequence is generated relative to measured  $P_{max}$ , measured  $P_{limit}$  and calculated  $P_{reserve}$  (= measured  $P_{limit}$  in dBm – Reserve power margin in dB) of the EUT based on measured  $P_{limit}$ .

The details for generating these two test sequences are described and listed in Appendix A.

#### 3.2. Test Configuration Selection Criteria for Validating Smart Transmit Feature

For validating the Smart Transmit feature, this section provides a general guidance to select test cases. In practice, an adjustment can be made in test case selection. The justification/clarification may be provided.

##### 3.2.1. Test Configuration Selection for Time-varying Transmission Power

The Smart Transmit time averaging feature operation is independent of bands, modes, and channels for a given technology. Hence, validation of Smart Transmit in one band/mode/channel per technology is sufficient. Two bands per technology are proposed and selected for this testing to provide high confidence in this validation.

<sup>1</sup> cDASY6 measurement system by Schmid & Partner Engineering AG (SPEAG) of Zurich, Switzerland measures relative E-field, and provides ratio of  $\frac{[\text{pointE}(t)]^2}{[\text{pointE input.power.limit}]^2}$  versus time.

<sup>2</sup> For test sequence generation, “measured  $P_{limit}$ ” and “measured  $P_{max}$ ” are used instead of the “ $P_{limit}$ ” specified in EFS entry and “ $P_{max}$ ” specified for the device, because Smart Transmit feature operates against the actual power level of the “ $P_{limit}$ ” that was calibrated for the EUT. The “measured  $P_{limit}$ ” accurately reflects what the feature is referencing to, therefore, it should be used during feature validation testing. The RF tune-up and device-to-device variation are already considered in the Part 0 report prior to determining  $P_{limit}$ .

The criteria for the selection are based on the  $P_{limit}$  values determined in the Part 0 report. Select two bands<sup>3</sup> in each supported technology that correspond to approximately the least<sup>4</sup> and highest<sup>5</sup>  $P_{limit}$  values that are less than  $P_{max}$  based on pre-testing for validating Smart Transmit, where  $P_{limit} < P_{max}$ .

1.  $P_{max}$  refers to maximum Tx power configured for this device in this technology/band (not rated  $P_{max}$ ). This  $P_{max}$  definition applies throughout this Part 2 report.
2. If  $P_{limit} > P_{max}$ , the validation test with time-varying test sequences is not needed as no power enforcement will be required in this condition.
- 3.

### 3.2.2. Test Configuration Selection for Change in Call

The criteria to select a test configuration for call-drop measurement is:

- Select the technology/band with the least  $P_{limit}$  among all supported technologies/bands and select the radio configuration (e.g., # of RBs, channel#) in this technology/band that corresponds to the highest measured 1g SAR at  $P_{limit}$  listed in the Part 1 report.
- In case of multiple bands having the same least  $P_{limit}$ , select the band having the highest measured 1g SAR at  $P_{limit}$  in the Part 1 report.
- Test for change in call is not required if all  $P_{limit} > P_{max}$ .

This test is performed with the EUT's Tx power requested to be at maximum power, the above band selection will result in Tx power enforcement (i.e., EUT forced to have Tx power at  $P_{reserve}$ ) for its longest duration in one FCC defined time window. The call change (call drop/reestablish) is performed during the Tx power enforcement duration (i.e., during the time when EUT is forced to have Tx power at  $P_{reserve}$ ). One test is sufficient as the feature operation is independent of technology and band.

### 3.2.3. Test Configuration Selection for Change in Technology/Band

The selection criteria for this measurement is to have EUT switch from a technology/band with lowest (or highest)  $P_{limit}$  within the technology group to a technology/band with highest (or lowest)  $P_{limit}$  within the technology group, or vice versa. The selection order is:

- First select both technology/band configurations having  $P_{limit} < P_{max}$ . In case of multiple bands having the same  $P_{limit}$ , select one band/radio configuration for this test. If this cannot be found, then,
- Select at least one technology/band configuration having  $P_{limit} < P_{max}$ . If all  $P_{limit} > P_{max}$ , then, test for change in technology/band is not required.
- The antennas corresponding to the selected technologies/bands should be in the same antenna group if EUT is configured with GEN2\_SUB6 or GEN2\_SUB6\_MMW.

Use the highest measured 1g\_or\_10g SAR at  $P_{limit}$  ( $P_{limit} < P_{max}$ ) shown in the Part 1 report for the selected tech/band/antenna/DSI out of all radio configurations and device positions in Equation (3a), (4a), (5a) and (6a) to calculate time-varying SAR. However, in the case of  $P_{limit} > P_{max}$ , the SAR measured in Part 1 report for the corresponding radio configuration selected and tested in Part 2 should be applied in Equation (3a), (4a), (5a) and (6a).

<sup>3</sup> If one  $P_{limit}$  level applies to all the bands within a technology or if only one band within a technology has  $P_{limit} < P_{max}$ , then only one band needs to be tested. In this case, select one band/radio configuration for this test. Use the highest measured 1g\_or\_10gSAR shown in the Part 1 report for the selected tech/band/antenna/DSI out of all radio configurations and device positions in Equation (3a), (4a), (5a) and (6a) to calculate time-varying SAR.

<sup>4</sup> In case of multiple bands having the same least  $P_{limit}$  within the technology, then select any one band out of these bands. The "least  $P_{limit}$ " term also implies that the technology/band with the largest difference between  $P_{max}$  and  $P_{limit}$  ( $P_{limit} < P_{max}$ ) should be considered in the selection.

<sup>5</sup> The band having a higher  $P_{limit}$  (meaning lower SAR at  $P_{max}$ ) needs to be properly selected so that the power limiting enforced by Smart Transmit can be validated using the pre-defined test sequences. If the highest  $P_{limit}$  in a technology is too high (i.e.,  $> P_{max}$ ) where the power limiting enforcement is not needed when testing with the pre-defined test sequences, then the next highest level should be checked. This process should be continued within the technology until the second band for validation testing is determined. If possible for this selection, delta ( $P_{max} - P_{limit}$ ) should be 1 dB or higher.



This test is performed with the EUT's Tx power requested to be at maximum power, the technology/band switch is performed during Tx power enforcement duration (i.e., during the time when EUT is forced to have Tx power at  $P_{reserve}$ ). One test is sufficient as the feature operation is independent of technology and band.

### 3.2.4. Test Configuration Selection for Change in Antenna

The criteria to select a test configuration for antenna switch (between primary and diversity antennas) measurement is:

- Whenever possible and supported by the EUT, first select antenna switch configuration within the same technology/band/DSI (i.e., same technology, band and DSI combination), and having different  $P_{limit}$ , and having both  $P_{limit} < P_{max}$  where possible. Otherwise, select at least one antenna having  $P_{limit} < P_{max}$ .
- If the EUT does not support antenna switch within the same technology/band but has multiple transmitting antennas to support different frequency bands, then antenna switch test should be performed in combination with technology and/or band switch. Note in this case, if possible, antenna switch test may be included as part of either change in technology and band (Section 3.2.3) or change in time window (Section 3.2.6).
- Test for change in antenna is not required if all  $P_{limit} > P_{max}$ . The antennas selected for this test should be in the same antenna group if EUT is configured with GEN2\_SUB6 or GEN2\_SUB6\_MMW.

Use the highest measured 1g\_or\_10g SAR at  $P_{limit}$  ( $P_{limit} < P_{max}$ ) shown in the Part 1 report for the selected tech/band/antenna/DSI out of all radio configurations and device positions in Equation (3a), (4a), (5a) and (6a) to calculate time-varying SAR. However, in the case of  $P_{limit} > P_{max}$ , the SAR measured in the Part 1 report for the corresponding radio configuration selected and tested in Part 2 should be applied in Equation (3a), (4a), (5a) and (6a).

This test is performed with the EUT being requested to transmit in selected technology/band at maximum power out of antenna, the antenna switch is performed during Tx power enforcement (i.e., EUT forced to transmit at a sustainable level). One test is sufficient as the feature operation is independent of technology and band.

### 3.2.5. Test Configuration Selection for Change in DSI

The criteria to select a test configuration for device state switch measurement is:

- Select a technology/band/antenna having the  $P_{limit} < P_{max}$  within any technology and device state index (DSI) group, and for the same technology/band/antenna having a different  $P_{limit}$  ( $P_{limit} < P_{max}$ ) in any other DSI group. Both the selected DSIs should have  $P_{limit} < P_{max}$  where possible. Otherwise, select at least one DSI having  $P_{limit} < P_{max}$ . Note that the selected DSI transition need to be supported by the device.
- Test for change in device state is not required if all  $P_{limit} > P_{max}$ . The antennas corresponding to the selected DSIs should be in the same antenna group if EUT is configured with GEN2\_SUB6 or GEN2\_SUB6\_MMW, and selected DSIs should be under the same exposure category (i.e., both selected DSIs are either under head exposure category or under non-head exposure category) if EUT is enabled with Smart Transmit version 18 or higher.

Use the highest measured 1g\_or\_10g SAR at  $P_{limit}$  ( $P_{limit} < P_{max}$ ) shown in Part 1 report for the selected tech/band/antenna/DSI out of all radio configurations and device positions in Equation (3a), (4a), (5a) and (6a) to calculate time-varying SAR. However, in the case of  $P_{limit} > P_{max}$ , the SAR measured in Part 1 report for the corresponding radio configuration selected and tested in Part 2 should be applied in Equation (3a), (4a), (5a) and (6a).

This test is performed with the EUT being requested to transmit at maximum power in selected technology/band/antenna/device-state. The change in device state is performed during Tx power enforcement (i.e., EUT forced to transmit at a sustainable level). One test is sufficient as the feature operation is independent of technology, band, antenna, and device state.

### 3.2.6. Test Configuration Selection for Change in Time Window

FCC specifies different time window for time averaging based on operation frequency. The criteria to select a test configuration for validating Smart Transmit feature and demonstrating the compliance during the change in time window is:

- Select any technology/band that has operation frequency classified in one time window defined by FCC (such as 100s time window), and its corresponding  $P_{limit}$  is less than  $P_{max}$  if possible.
- Select the 2nd technology/band that has operation frequency classified in a different time window defined by FCC (such as 60s time window), and its corresponding  $P_{limit}$  is less than  $P_{max}$  if possible.
- It is preferred both  $P_{limit}$  values of two selected technology/bands are less than corresponding  $P_{max}$ , but if not possible or due to limitation of test setup, then at least one of technologies/bands has its  $P_{limit}$  less than  $P_{max}$ .
- Else, if all  $P_{limit} > P_{max}$ , then (the antennas corresponding to the selected radio configurations for this test should be in the same antenna group if EUT is configured with GEN2\_SUB6 or GEN2\_SUB6\_MMW):
  - First select both technologies/bands (one is in 100s time window, another is in 60s time window) having  $(P_{limit} - P_{max}) < 2.2\text{dB}$ ; if it is not available, then
  - Select at least one technology/band in 60s time window having  $(P_{limit} - P_{max}) < 2.2\text{dB}$ ; if it is not available, then
  - Test for change in time window is not required.

Use the highest measured 1g\_or\_10g SAR at  $P_{limit}$  ( $P_{limit} < P_{max}$ ) shown in Part 1 report for the selected tech/band/antenna/DSI out of all radio configurations and device positions in Equation (3a), (4a), (5a) and (6a) to calculate time-varying SAR. However, in the case of  $P_{limit} > P_{max}$ , the SAR measured in Part 1 report for the corresponding radio configuration selected and tested in Part 2 should be applied in Equation (3a), (4a), (5a) and (6a).

This test is performed with the EUT being requested to transmit at maximum power in selected technology/band. Test for one pair of time windows selected is sufficient as the feature operation is the same.

### 3.2.7. Test Configuration Selection for SAR Exposure Switching

If supported, the test configuration for SAR exposure switching should cover:

1. SAR exposure switch when two active radios are in the same time window. The following radio configurations need to be covered if the device supports:
  - a. LTE + Sub-6 GHz NR.
  - b. Interband ULCA
    - i. Smart Transmit treats intraband ULCA as single Tx, so, this test is not needed for intraband ULCA.
2. SAR exposure switch when two active radios are in different time windows. Note that one test with two active radios in any two different time windows is sufficient as Smart Transmit operation is the same for RF exposure switch in any combination of two different time windows. For device supporting LTE + mmW NR, this test (i.e., Scenario 2) is covered in SAR vs PD exposure switch validation.

The Smart Transmit time averaging operation is independent of the source of SAR exposure (for example, LTE vs. Sub-6 GHz NR) and ensures total time-averaged RF exposure compliance. Hence, validation of Smart Transmit in any one simultaneous SAR transmission scenario (i.e., one combination for LTE + Sub-6 GHz NR transmission) is sufficient, where the SAR exposure varies among  $SAR_{radio1}$  only,  $SAR_{radio1} + SAR_{radio2}$ , and  $SAR_{radio2}$  only scenarios.

The criteria to select a test configuration for validating the Smart Transmit feature during SAR exposure switching scenario is:

- Select any two < 6 GHz technologies/bands that the EUT supports simultaneous transmission (for example, LTE + Sub-6 GHz NR).
- Among all supported simultaneous transmission configurations, the selection order is:
  1. Select one configuration where both  $P_{limit}$  of radio1 and radio2 is less than their corresponding  $P_{max}$ , preferably, with different  $P_{limits}$ . If this configuration is not available, then,
  2. Select one configuration that has  $P_{limit}$  less than its  $P_{max}$  for at least one radio. If this cannot be found, then,
  3. The test for SAR exposure switch when two active radios are in the same time window is not required. For SAR exposure switch when two active radios are in the different time windows, the selection order

is (The antennas corresponding to the selected radio configurations for this test should be in the same antenna group if EUT is configured with GEN2\_SUB6 or GEN2\_SUB6\_MMW.):

- Select both configurations that has  $P_{limit}$  of radio1 and radio2 greater than  $P_{max}$  but having  $(P_{limit} - P_{max}) < 2.2\text{dB}$ . If this cannot be found, then,
- Select at least one configuration in 60s window that has  $(P_{limit} - P_{max}) < 2.2\text{dB}$ . If all  $(P_{limit} - P_{max}) > 2.2\text{dB}$ , then,
- Test for SAR exposure switch when two active radios are in the different time windows is not required.

Use the highest measured 1g\_or\_10g SAR at  $P_{limit}$  ( $P_{limit} < P_{max}$ ) shown in Part 1 report for the selected tech/band/antenna/DSI out of all radio configurations and device positions in Equation (3a), (4a), (5a) and (6a) to calculate time-varying SAR. However, in the case of  $P_{limit} > P_{max}$ , the SAR measured in Part 1 report for the corresponding radio configuration selected and tested in Part 2 should be applied in Equation (3a), (4a), (5a) and (6a).

Test for one band combination per each simultaneous transmission technology (for example, one band combination for LTE + Sub6 NR transmission, and one band combination for interband ULCA) is sufficient as the feature operation is the same.

### 3.3. Test Procedures for Conducted Power Measurements

This section provides general conducted power measurement procedures to perform compliance test under dynamic transmission scenarios described in §2. In practice, an adjustment can be made in these procedures. The justification/clarification may be provided.<sup>6</sup>

For  $P_{limit}$  conducted power test and SAR test at  $P_{limit}$ , the measurement under Smart Transmit Peak exposure mode is effectively the same as the measurement with Reserve\_power\_margin set to 0 dB, therefore, all  $P_{limit}$  tests can be performed under Peak exposure mode condition. For devices with Smart Transmit EFS version 18, due to the changes in Reserve\_power\_margin,  $P_{limit}$  tests should be conducted with Peak exposure mode.

#### 3.3.1. Time-varying Transmission Power Scenario

This test is performed with the two pre-defined test sequences described in §3.1 for all the technologies and bands selected in §3.2.1. The purpose of the test is to demonstrate the effectiveness of power limiting enforcement and that the time-averaged SAR (corresponding time-averaged Tx power) does not exceed the FCC limit at all times (see Eq. (1a) and (1b)).

##### Test Procedure:

1. Measure  $P_{max}$ , measure  $P_{limit}$ , and calculate  $P_{reserve}$  (= measured  $P_{limit}$  in dBm – Reserve\_power\_margin in dB) and follow §3.1 to generate the test sequences for all the technologies and bands selected in §3.2.1. Both test sequence 1 and test sequence 2 are created based on measured  $P_{max}$  and measured  $P_{limit}$  of the EUT. Test conditions to measure  $P_{max}$  and  $P_{limit}$  are:
  - a. Measure  $P_{max}$  with Smart Transmit **disabled** and the callbox set to request maximum power.
  - b. Measure  $P_{limit}$  with Smart Transmit Peak exposure mode **enabled**, Reserve\_power\_margin set to 0 dB, and the callbox set to request maximum power.
  - c. Measure  $P_{reserve}$  via test sequence 1 measurement.
2. Set the EUT to the intended Smart Transmit exposure mode, then set callbox to request the EUT to transmit at pre-defined test sequence 1 (generated in Step 1), measure and record Tx power versus time. Once the measurement is done, extract instantaneous Tx power versus time, and convert the conducted Tx power into 1g\_or\_10g SAR value (see Eq. (1a)) using Step 1.b result, and then perform 100s running average to determine time-averaged 1g\_or\_10gSAR versus time as illustrated in below Figure 3-1.

<sup>6</sup> For  $P_{limit}$  conducted power test and SAR test at  $P_{limit}$ , the measurement under Smart Transmit Peak exposure mode is effectively the same as the measurement with Reserve\_power\_margin set to 0 dB, therefore, all  $P_{limit}$  tests can be performed under Peak exposure mode condition. For devices with Smart Transmit EFS version 18, due to the changes in Reserve\_power\_margin,  $P_{limit}$  tests should be conducted with Peak exposure mode.

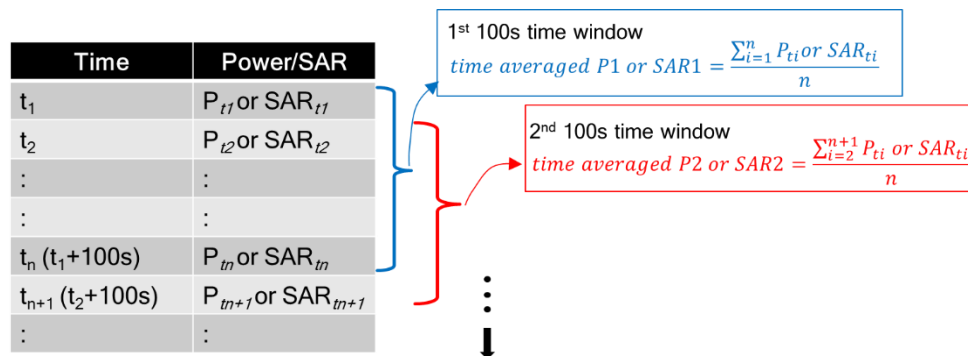

Figure 3-1: 100 seconds running average illustration

3. Make one plot containing:
  - a. Computed time-averaged 1g\_or\_10gSAR versus time determined in Step 2
  - b. Corresponding regulatory 1g\_or\_10gSAR<sub>limit</sub> limit.
4. Repeat Steps 2~3 for pre-defined test sequence 2.
5. Repeat Steps 2~4 for all the selected technologies and bands.

The validation criteria is, at all times, the time-averaged 1g\_or\_10g AR versus time determined in Step 2 (and plotted in Step 4) shall not exceed the regulatory 1g\_or\_10gSAR<sub>limit</sub> limit.

### 3.3.2. Change in Call Scenario

This test is to demonstrate that the Smart Transmit feature accurately accounts for the past transmission powers during time-averaging when a new call is established.

The call drop and re-establishment needs to be performed during power limit enforcement to demonstrate the continuity of RF exposure management and limiting in call change scenario. In other words, the RF exposure averaged over any 100s-time window (including the time windows containing the call change) doesn't exceed the corresponding regulatory 1g\_or\_10gSAR<sub>limit</sub> limit.

#### Test Procedure

1. Measure  $P_{limit}$  for the technology/band selected in §3.2.2. Measure  $P_{limit}$  with Smart Transmit Peak exposure mode enabled, and callbox set to request maximum power.
2. Set EUT to the intended Smart Transmit exposure mode.
3. Establish radio link with callbox in technology/band selected in §3.2.2.
4. Request EUT to transmit at 0 dBm for at least 100 seconds, followed by requesting EUT to transmit at maximum Tx power for about ~60 seconds, and drop the call then reestablish another call in the same radio configuration (i.e., same technology/band/channel) and continue callbox requesting EUT to transmit at maximum Tx power for the remaining time for a total test time of ~360 seconds. Measure and record Tx power versus time.
5. Once the measurement is done, extract instantaneous Tx power versus time, and convert the conducted Tx power into 1g\_or\_10gSAR value (see Eq. (1a)) using Step 1 result, and then perform 100s running average to determine time-averaged 1g\_or\_10gSAR versus time as illustrated in Figure 3-1.<sup>7</sup>
6. Make one plot containing: (a) computed time-averaged 1g\_or\_10gSAR versus time determined in Step 4 for the 1<sup>st</sup> call, (b) computed time-averaged 1g\_or\_10gSAR versus time determined in Step 4 for the 2<sup>nd</sup> call, (c) combined time-averaged 1g\_or\_10gSAR of the 1st call and 2nd call versus time and (d) corresponding regulatory 1g\_or\_10gSAR<sub>limit</sub> limit.

The validation criteria is, at all times, the combined time-averaged 1g\_or\_10gSAR versus time determined in Step 6c shall not exceed the regulatory 1g\_or\_10gSAR<sub>limit</sub> limit.

<sup>7</sup> In Eq.(1a), instantaneous Tx power is converted into instantaneous 1g\_or\_10gSAR value by applying the worst-case 1g\_or\_10gSAR value of the technology/band at  $P_{limit}$  as reported in the Part 1 report.

### 3.3.3. Change in Technology and Band

This test is to demonstrate the correct power control by Smart Transmit during technology switches and/or band handovers.

Similar to the change in call test in §3.3.2, the technology and band handover needs to be performed to validate the continuity of RF exposure limiting during the transition. The  $P_{limit}$  could vary with technology and band, but the instantaneous Tx power for a given band could be converted in 1g\_or\_10gSAR exposure using Eq. (1a). Thus, the equations (2a) and (2b) in §2 can be written as follows for transmission scenario having change in technology/band:

$$1g \text{ or } 10g SAR_1(t) = \frac{\text{conducted}_{Tx \text{ power } 1(t)}}{\text{conducted}_{Tx \text{ power } P_{limit \ 1}}} * 1g \text{ or } 10g SAR P_{limit \ 1} \quad (6a)$$

$$1g \text{ or } 10g SAR_2(t) = \frac{\text{conducted}_{Tx \text{ power } 2(t)}}{\text{conducted}_{Tx \text{ power } P_{limit \ 2}}} * 1g \text{ or } 10g SAR P_{limit \ 2} \quad (6b)$$

$$\frac{\frac{1}{T_{SAR}} \left[ \int_{t-T_{SAR}}^{t_1} 1g \text{ or } 10g SAR_1(t) dt + \int_{t-T_{SAR}}^t 1g \text{ or } 10g SAR_2(t) dt \right]}{1g \text{ or } 10g SAR_{limit}} \leq 1 \quad (6c)$$

where,  $\text{conducted\_Tx\_power\_1}(t)$ ,  $\text{conducted\_Tx\_power\_Plimit\_1}$ , and  $1g\_or\_10gSAR\_Plimit\_1$  correspond to the instantaneous Tx power, conducted Tx power at  $P_{limit}$ , and compliance 1g\_or\_10gSAR values of technology1/band1 at  $P_{limit\_1}$ ;  $\text{conducted\_Tx\_power\_2}(t)$ ,  $\text{conducted\_Tx\_power\_Plimit\_2}$ , and  $1g\_or\_10gSAR\_Plimit\_2$  correspond to the instantaneous Tx power, conducted Tx power at  $P_{limit}$ , and compliance 1g\_or\_10gSAR values of technology2/band2 at  $P_{limit\_2}$ . Transition from the technology1/band1 to the technology2/band2 happens at time-instant 't1'.

#### Test Procedure

1. Measure  $P_{limit}$  for both the technologies and bands selected in §3.2.3. Measure  $P_{limit}$  with Smart Transmit Peak exposure mode enabled, and callbox set to request maximum power. Set *Reserve\_power\_margin* to actual (intended) value and reset power on the EUT to enable Smart Transmit.
2. Set EUT to intended Smart Transmit exposure mode.
3. Establish radio link with callbox in first technology/band selected in §3.2.3.
4. Request EUT to transmit at 0 dBm for at least 100 seconds, followed by requesting EUT to transmit at maximum Tx power for about ~60 seconds, and then switch to second technology/band selected in Section 5.2.3. Continue with callbox requesting EUT to transmit at maximum Tx power for the remaining time for a total test time of ~360 seconds. Measure and record Tx power versus time for the entire duration of the test.
5. Once the measurement is done, extract instantaneous Tx power versus time, and convert the conducted Tx power into 1g\_or\_10gSAR value (see Eq. (5a) and (5b)) using corresponding technology/band Step 1 result, and then perform 100s running average to determine time-averaged 1gSAR versus time as illustrated in Figure 3-1. Note that in Eq.(5a) & (5b), instantaneous Tx power is converted into instantaneous 1g\_or\_10gSAR value by applying the worst-case 1gSAR value for the selected technologies/bands at  $P_{limit}$  as reported in the Part 1 report.
6. Make one plot containing: (a) computed time-averaged 1g\_or\_10gSAR of the 1st technology/band versus time determined in Step 5, (b) computed time-averaged 1g\_or\_10gSAR of the 2nd technology/band versus time determined in Step 5, (c) combined time-averaged 1g\_or\_10gSAR of the 1st technology/band and 2nd technology/band versus time determined in Step 5 and (d) corresponding regulatory 1g\_or\_10gSAR<sub>limit</sub> limit.

The validation criteria is, at all times, the combined time-averaged 1g\_or\_10gSAR versus time shall not exceed the regulatory 1g\_or\_10gSAR<sub>limit</sub> limit.

### 3.3.4. Change in Antenna

This test is to demonstrate the correct power control by Smart Transmit during antenna switches from primary to diversity. The test procedure is identical to §3.3.3, with switching antenna instead of technology/band. The validation criteria is, at all times, the time-averaged 1g\_or\_10gSAR versus time shall not exceed the regulatory 1g\_or\_10gSARlimit limit.

### 3.3.5. Change in DSI

This test is to demonstrate the correct power control by Smart Transmit during device state transitions from one device state (say, body-worn or hotspot or extremity) to another. The test procedure is identical to §3.3.3, with changing device state instead of technology/band. The validation criteria is, at all times, the time-averaged 1g\_or\_10gSAR versus time shall not exceed the regulatory 1g\_or\_10gSARlimit limit.

### 3.3.6. Change in Time Window

This test is to demonstrate the correct power control by Smart Transmit during the change in averaging time window when a specific band handover occurs. The FCC specifies time-averaging windows of 100 seconds for transmission frequencies < 3 GHz, and 60 seconds for transmission frequencies between 3 GHz and 6 GHz.

Similar to the change in technology and band test in §3.3.3, to validate the continuity of RF exposure limiting during the transition, the band handover test needs to be performed when EUT handovers from operation band less than 3GHz to greater than 3GHz or vice versa. The equations (2a) and (22b) in §2 can be written as follows for transmission scenario having change in time window:

$$1g\ SAR_1(t) = \frac{\text{conducted}_{Tx\ power\ 1(t)}}{\text{conducted}_{Tx\ power\ P_{limit\ 1}}} * 1g\ or\ 10g\ SAR\ P_{limit\ 1} \quad (7a)$$

$$1g\ SAR_2(t) = \frac{\text{conducted}_{Tx\ power\ 2(t)}}{\text{conducted}_{Tx\ power\ P_{limit\ 2}}} * 1g\ or\ 10g\ SAR\ P_{limit\ 2} \quad (7b)$$

$$\frac{\frac{1}{T_{1SAR}} \left[ \int_{t-T_{1SAR}}^{t_1} 1g\ or\ 10g\ SAR_1(t) dt \right] + \frac{1}{T_{2SAR}} \left[ \int_{t-T_{2SAR}}^t 1g\ or\ 10g\ SAR_2(t) dt \right]}{1g\ or\ 10g\ SAR_{limit}} \leq 1 \quad (7c)$$

where,  $\text{conducted}_{Tx\ power\ 1(t)}$ ,  $\text{conducted}_{Tx\ power\ P_{limit\ 1(t)}}$ , and  $1gSAR\ P_{limit\ 1}$  correspond to the instantaneous transmission power, conducted transmission power at  $P_{limit}$ , and compliance  $1gSAR$  values at  $P_{limit\ 1}$  of band1 with the time-averaging window ' $T_{1SAR}$ ';  $\text{conducted}_{Tx\ power\ 2(t)}$ ,  $\text{conducted}_{Tx\ power\ P_{limit\ 2(t)}}$ , and  $1gSAR\ P_{limit\ 2}$  correspond to the instantaneous transmission power, conducted transmission power at  $P_{limit}$ , and compliance  $1gSAR$  values at  $P_{limit\ 2}$  of band2 with the time-averaging window ' $T_{2SAR}$ '. One of the two bands is less than 3 GHz, another is greater than 3 GHz. Transition from first band with time-averaging window ' $T_{1SAR}$ ' to the second band with time-averaging window ' $T_{2SAR}$ ' happens at time-instant ' $t_1$ '.

#### Test Procedure

1. Measure  $P_{limit}$  for both the technologies and bands selected in §3.2.6. Measure  $P_{limit}$  with Smart Transmit Peak exposure mode enabled, and callbox set to request maximum power.
2. Set EUT to intended Smart Transmit exposure mode.

#### Transition from 100 seconds time window to 60 seconds time window, and vice versa

3. Establish radio link with the callbox in the technology/band having 100 seconds time window selected in §3.2.6.
4. Request the EUT's transmission power to be at 0 dBm for at least 100 seconds, followed by requesting the EUT's transmission power to be at maximum power for about ~140 seconds, and then switch to the second technology/band (having 60 seconds time window) selected in §3.2.6. Continue with the callbox requesting the EUT's transmission power to be at maximum power for about ~60 seconds in this second technology/band, and then switch back to the first technology/band. Continue with the callbox requesting the EUT's transmission power to be at maximum power for at least another 100 seconds. Measure and record the transmission power versus time for the entire duration of the test.

5. Once the measurement is done, extract the instantaneous transmission power versus time and convert the conducted transmission power into 1g SAR value (see Eq. (7a) and (7b)) using the corresponding technology/band in Step 1's result, then perform 100 seconds running average to determine time-averaged 1g SAR versus time.<sup>8</sup>
6. Make one plot containing: (a) computed time-averaged 1g\_or\_10gSAR of the 1st technology/band (having 100s time window) versus time determined in Step 5, (b) computed time-averaged 1g\_or\_10gSAR of the 2nd technology/band (having 60s time window) versus time determined in Step 5, (c) combined time-averaged 1g\_or\_10gSAR of (a) and (b), and (d) corresponding regulatory 1g\_or\_10gSAR<sub>limit</sub> limit.

#### Transition from 60 seconds time window to 100 seconds time window, and vice versa

7. Establish radio link with the callbox in the technology/band having a 60 second time window selected in §3.2.6.
8. Request the EUT's transmission power to be at 0 dBm for at least 60 seconds, followed by requesting the EUT's transmission power to be at maximum power for about ~80 seconds, and then switch to the second technology/band (having 100 seconds time window) selected in §3.2.6. Continue with the callbox requesting the EUT's transmission power to be at maximum power for about ~100 seconds in this second technology/band, and then switch back to the first technology/band. Continue with the callbox requesting the EUT's transmission power to be at maximum power for the remaining time for a total test time of 500 seconds. Measure and record the transmission power versus time for the entire duration of the test.
9. Repeat Step 5~6 to generate the plots.

The validation criteria is, at all times, the combined time-averaged 1g\_or\_10gSAR versus time shall not exceed the regulatory 1g\_or\_10gSAR<sub>limit</sub> limit.

### 3.3.7. SAR Exposure Switching

This test is to demonstrate that Smart Transmit feature is accurately accounts for switching in exposures among SAR from radio1 only, SAR from both radio1 and radio2, and SAR from radio2 only scenarios, and ensures total time-averaged RF exposure complies with the FCC limit. The detailed test procedure for SAR exposure switching in the case of LTE+Sub-6 GHz NR non-standalone mode transmission scenario is provided in Appendix B.2.

#### Test Procedure

1. Measure the conducted transmission power corresponding to  $P_{limit}$  for radio1 and radio2 in the selected band. The test conditions to measure conducted  $P_{limit}$  are:
  - a. Establish device in call with the callbox for radio1 technology/band. Measure conducted Tx power corresponding to radio1  $P_{limit}$  with Smart Transmit Peak exposure mode enabled and callbox set to request maximum power.
  - b. Repeat above step to measure conducted Tx power corresponding to radio2  $P_{limit}$ . If radio2 is dependent on radio1 (for example, non-standalone mode of Sub-6 GHz NR requiring radio1 LTE as anchor), then establish radio1 + radio2 call with callbox, and request all down bits for radio1 LTE. In this scenario, with callbox requesting maximum power from radio2 Sub-6 GHz NR, measured conducted Tx power corresponds to radio2  $P_{limit}$  (as radio1 LTE is at all-down bits)
2. Set EUT to intended Smart Transmit exposure mode for radio1 + radio2. In this description, it is assumed that radio2 has lower priority than radio1. Established device in radio1+radio2 call, and request all-down bits or low power on radio1, with callbox requesting UE to transmit at maximum power in radio2 for at least one time window. After one time window, set callbox to request UE to transmit at maximum power on radio1, i.e., all-up bits. Continue radio1+radio2 call with both radios at maximum power for at least one time window, and drop (or request all-down bits) radio2. Continue radio1 at maximum power for at least one time window. Record the conducted Tx power for both radio1 and radio2 for the entire duration of this test.
3. Once the measurement is done, extract instantaneous Tx power versus time for both radio1 and radio2 links. Similar to technology/band switch test in §3.3.3, convert the conducted Tx power for both these radios into 1g\_or\_10gSAR value (see Eq. (6a) and (6b)) using corresponding technology/band  $P_{limit}$  measured in Step 1, and then perform 100s running average to determine time-averaged 1g\_or\_10gSAR versus time as illustrated in Figure 3-1. Note that here it is assumed both radios have Tx frequencies < 3GHz, otherwise, 60s running average should be performed for radios having Tx frequency between 3GHz and 6GHz.

<sup>8</sup> In Eq.(7a) & (7b), instantaneous transmission power is converted into instantaneous 1g SAR or 10g SAR value by applying the worst-case 1g SAR or 10g SAR value tested in Part 1 for the selected technologies/bands at  $P_{limit}$ .

4. Make one plot containing: (a) computed time-averaged 1g\_or\_10gSAR versus time determined in Step 3 and combined time-averaged 1g\_or\_10gSAR versus time (see Appendix B for details), and (b) corresponding regulatory 1g\_or\_10gSAR<sub>limit</sub> limit.

The validation criteria is, at all times, the combined time-averaged 1g\_or\_10gSAR versus time shall not exceed the regulatory 1g\_or\_10gSAR<sub>limit</sub> limit.

### 3.4. Test Procedure for Time-varying SAR Measurements

This section provides general time-varying SAR measurement procedures to perform compliance test under dynamic transmission scenarios described in §2. In practice, an adjustment can be made in these procedures. The justification/clarification may be provided.

To perform the validation through SAR measurement for transmission scenario 1 described in §2, the “path loss” between callbox, antenna, and EUT need to be calibrated to ensure that the EUT’s transmission power reacts to the requested power from the callbox in a radiated call. It should be noted that when signaling in closed loop mode, protocol-level power control is in play, resulting in the EUT not solely following the callbox’s TPC (transmit power control) commands. In other words, the EUT response has many dependencies (RSSI, quality of signal, path loss variation, fading, etc.) other than just TPC commands. These dependencies have less impact in conducted setup (as it is a controlled environment and the path loss can be very well calibrated) but have significant impact on radiated testing in an uncontrolled environment, such as a SAR test setup. Therefore, the deviation in EUT transmit power from the callbox’s requested power is expected, however the time-averaged SAR should not exceed the FCC SAR requirements as Smart Transmit controls the transmission power at the EUT.

The following steps are for time averaging feature validation through SAR measurement:

1. “Path Loss” calibration: Place the EUT against the phantom in the worst-case position determined based on §3.2.1. For each band selected, prior to SAR measurement, perform the “path loss” calibration between callbox, antenna, and EUT. Since the SAR test environment is not controlled and well calibrated for OTA (Over the Air) test, extreme care needs to be taken to avoid the influence of reflections. The test setup is described in §8.1.
2. Time averaging feature validation:
  - a. For a given radio configuration (technology/band) selected in §3.2.1, enable Smart Transmit Peak exposure mode, with callbox to request maximum power, perform area scan, conduct pointSAR measurement at peak location of the area scan. This pointSAR value, pointSAR\_<sub>P<sub>limit</sub></sub> corresponds to pointSAR at the measured <sub>P<sub>limit</sub></sub> obtained in Step 1 of §3.3.1.
  - b. Set EUT to intended Smart Transmit exposure mode, with callbox requesting the EUT to transmit at power levels described by test sequence 1 in Step 1 of §3.3.1, conduct pointSAR measurement versus time at peak location of the area scan determined in this section Step 2.i. Once the measurement is done, extract instantaneous pointSAR vs time data, pointSAR(t), and convert it into instantaneous 1gSAR vs. time by using equation (3a):

$$1g \text{ or } 10gSAR(t) = \frac{pointSAR(t)}{pointSAR_{P_{limit}}} * 1g \text{ or } 10gSAR P_{limit} \text{ (3a)}$$

where, pointSAR\_<sub>P<sub>limit</sub></sub> corresponds to the value determined in Step 2.i, and pointSAR(t) corresponds to instantaneous pointSAR determined in Step 2.ii.

- c. Perform 100 seconds running average to determine time-averaged 1g SAR versus time.
- d. Make one plot containing (a) computed time-averaged 1g\_or\_10gSAR versus time determined in this section Step 2.iii, (b) regulatory 1g\_or\_10gSAR<sub>limit</sub> limit.



- e. Repeat 2b ~ 2d for test sequence 2 generated in Step 1 of §3.3.1.
- f. Repeat 2a ~ 2e for all the technologies and bands selected in §3.2.1.

The time-averaging validation criteria for SAR measurement is that, at all times, the time-averaged 1g\_or\_10gSAR versus time shall not exceed the regulatory 1g\_or\_10gSARlimit limit.

## 4. PD Time Averaging Validation Test Procedures

This chapter provides the test plan and test procedures for validating Qualcomm's Smart Transmit feature for mmW transmission. For this EUT, millimeter wave (mmW) transmission is only in non-standalone mode, i.e., it requires an LTE link as anchor.

### 4.1. Test Sequence for Validation in mmW NR Transmission

In 5G mmW NR transmission, the test sequence for validation is with the callbox always requesting the EUT's transmission power in 5G mmW NR at maximum power.

### 4.2. Test Configuration Selection Criteria for Validating Smart Transmit Feature

#### 4.2.1. Test Configuration Selection for Time-varying Transmission Power

The Smart Transmit time averaging feature operation is independent of bands, modes, channels, and antenna configurations (beams) for a given technology. Hence, validation of Smart Transmit in any one band/mode/channel per technology that approximately correspond to least and highest P<sub>limit</sub> values that are less than P<sub>max</sub> based on pretesting is sufficient.

The selection criteria for this measurement is to test EUT transmit in a beam containing highest number of elements (as it has lower input.power.limit). Additionally, for EUT enabled with Smart Transmit EFS version 18 (or higher) utilizing DSI applicability feature, since this test is performed in non-standalone (NSA) mode with a Sub-6 GHz anchor, perform this test in a DSI that has DSI\_PD\_ratio < 1 in the EFS for the selected beam.

#### 4.2.2. Test Configuration Selection for Change in Antenna Configuration (Beam)

The Smart Transmit time averaging feature operation is independent of bands, modes, channels, and antenna configurations (beams) for a given technology. Hence, validation of Smart Transmit with beam switch between any two beams is sufficient.

#### 4.2.3. Test Configuration Selection for SAR versus PD Exposure Switch during Transmission

The Smart Transmit time averaging feature operation is independent of the nature of exposure (SAR vs. PD) and ensures total time-averaged RF exposure compliance. Hence, validation of Smart Transmit in any one band/mode/channel/beam for mmW + sub-6 GHz (LTE) transmission is sufficient, where the exposure varies among SAR dominant scenarios, SAR+PD scenarios, and PD dominant scenarios.

The selection criteria for this measurement is to test EUT transmit in a beam containing highest number of elements (as it has lower input.power.limit).

### 4.3. Test Procedures for mmW Radiated Power Measurements

Perform conducted power measurement (for  $f < 6$  GHz) and radiated power measurement (for  $f > 6$  GHz) for LTE + mmW transmission to validate Smart Transmit time averaging feature in the various transmission scenarios described in §2.

This section provides general conducted power measurement procedures to perform compliance test under dynamic transmission scenarios described in §2. In practice, an adjustment can be made in these procedures. The justification/clarification may be provided.

### 4.3.1. Time-varying Transmission Power Scenario

The purpose of the test is to demonstrate the effectiveness of power limiting enforcement and that the time averaged transmit power when converted into RF exposure values does not exceed the regulatory limit at all times (see Eq. (7a), (7b) & (7c)). The maximum power tests are performed with the callbox requesting EUT to transmit in mmW NR 5G at maximum power all the time.

#### Test Procedure

1. Measure conducted Tx power corresponding to P<sub>limit</sub> for LTE in selected band, and measure radiated Tx power corresponding to input.power.limit in desired mmW band/channel/beam. Test condition to measure conducted P<sub>limit</sub> and radiated input.power.limit is:
  - a. Measure radiated.power corresponding to mmW input.power.limit by setting up the UE to transmit in desired band/channel/beam at input.power.limit in Factory Test Mode. Do not disturb the position of the EUT inside the anechoic chamber for the rest of this test.
  - b. Measure conducted Tx power corresponding to LTE P<sub>limit</sub> with Smart Transmit Peak exposure mode enabled and callbox set to request maximum power.
2. Set EUT to intended Smart Transmit exposure mode for LTE (sub6) + mmW call. First, establish LTE (sub6) connection with the callbox, and then mmW connection is added with callbox requesting UE to transmit at maximum mmW power. As soon as the mmW connection is established, request all-down bits on LTE link (otherwise, mmW will not have sufficient RF exposure margin to sustain the call with LTE in high power). Continue LTE (all-down bits)+mmW transmission for more than 100s duration to test predominantly PD exposure scenario (as SAR exposure is negligible from all-down bits in LTE). After 120s, request LTE to go all-up bits, mmW transmission should gradually run out of RF exposure margin and seize mmW transmission. Record the conducted Tx power of LTE and radiated Tx power of mmW for the entire duration of this test of ~380s.
3. Once the measurement is done, extract instantaneous Tx power versus time for both LTE and mmW links. Convert the conducted Tx power for LTE into 1gSAR value (see Eq. (7a)) using Step 1.b result, and then divide this by regulatory 1gSAR limit of 1.6W/kg to obtain instantaneous normalized 1gSAR versus time. Perform 100s running average to determine normalized 100s-averaged 1gSAR versus time as illustrated in Figure 3-1. Note that in Eq.(2a), instantaneous Tx power is converted into instantaneous 1gSAR value by applying the worst-case 1gSAR value of the technology/band at P<sub>limit</sub> as reported in the Part 1 report.
4. Similarly, convert the radiated Tx power for mmW into 4cm2PD value (see Eq. (7b)) using Step 1.a result, and then divide this by FCC 4cm2PD limit of 10W/m<sup>2</sup> to obtain instantaneous normalized 4cm2PD versus time. Perform 4s running average to determine normalized 4s-averaged 4cm2PD versus time as illustrated in Figure 3-1. Note that in Eq.(7b), instantaneous Tx power is converted into instantaneous 4cm2PD by applying the worst-case 4cm2PD value for the selected band/beam at input.power.limit as reported in the Part 1 report.
5. Make one plot containing: (a) computed normalized 100s-averaged 1gSAR versus time determined in Step 3, (b) computed normalized 4s-averaged 4cm2PD versus time determined in Step 4, and (c) corresponding total normalized time-averaged RF exposure (sum of steps (a) and (b)) versus time.

The validation criteria is, at all times, the total normalized time-averaged RF exposure versus time determined in Step 5.c shall not exceed the normalized limit of 1.0.

### 4.3.2. Switch in SAR vs. PD Exposure during Transmission

This test is to demonstrate that Smart Transmit feature is independent of the nature of exposure (SAR vs. PD), accurately accounts for switching in exposures among SAR only, SAR+PD, and PD only scenarios, and ensures total time-averaged RF exposure compliance (see Eq. (2a), (2b) & (2c)).

#### Test Procedure

1. Measure conducted Tx power corresponding to P<sub>limit</sub> for LTE in selected band, and measure radiated Tx power corresponding to input.power.limit in desired mmW band/channel/beam. Test condition to measure conducted P<sub>limit</sub> and radiated input.power.limit is:
  - a. Measure radiated.power corresponding to mmW input.power.limit by setting up the UE to transmit in desired band/channel/beam at input.power.limit in Factory Test Mode. Do not disturb the position of the EUT inside the anechoic chamber for the rest of this test.

- b. Measure conducted Tx power corresponding to LTE P<sub>limit</sub> with Smart Transmit Peak exposure mode enabled and callbox set to request maximum power.
2. Set EUT to intended Smart Transmit exposure mode for LTE (sub6) + mmW call. First, establish LTE (sub6) connection with the callbox, and then mmW connection is added with callbox requesting UE to transmit at maximum mmW power. As soon as the mmW connection is established, request all-down bits on LTE link (otherwise, mmW will not have sufficient RF exposure margin to sustain the call with LTE in all-up bits). Continue LTE (all-down bits)+mmW transmission for more than 100s duration to test predominantly PD exposure scenario (as SAR exposure is negligible from all-down bits in LTE). After 120s, request LTE to go all-up bits, mmW transmission should gradually run out of RF exposure margin and seize mmW transmission (SAR only scenario). After 120s, request LTE to go all-down bits, mmW transmission should get back RF exposure margin and start transmission again. Record the conducted Tx power of LTE and radiated Tx power of mmW for the entire duration of this test of ~360s.<sup>9</sup>
3. Once the measurement is done, extract instantaneous Tx power versus time for both LTE and mmW links. Convert the conducted Tx power for LTE into 1gSAR value (see Eq. (7a)) using Step 1.b result, and then divide this by regulatory 1gSAR limit of 1.6W/kg to obtain instantaneous normalized 1gSAR versus time. Perform 100s running average to determine normalized 100s-averaged 1gSAR versus time as illustrated in Figure 3-1. Note that in Eq.(7a), instantaneous Tx power is converted into instantaneous 1gSAR value by applying the worst-case 1gSAR value of the technology/band at P<sub>limit</sub> as reported in the Part 1 report.
4. Similarly, convert the radiated Tx power for mmW into 4cm<sup>2</sup>PD value (see Eq. (7b)) using Step 1.a result, and then divide this by regulatory 4cm<sup>2</sup>PD limit of 10W/m<sup>2</sup> to obtain instantaneous normalized 4cm<sup>2</sup>PD versus time. Perform 4s running average to determine normalized 4s-averaged 4cm<sup>2</sup>PD versus time as illustrated in Figure 3-1. Note that in Eq.(7b), instantaneous Tx power is converted into instantaneous 4cm<sup>2</sup>PD by applying the worst-case 4cm<sup>2</sup>PD value for the selected band/beam at input.power.limit as reported in the Part 1 report.
5. Make another plot containing: (a) computed normalized 100s-averaged 1gSAR versus time determined in Step 3, (b) computed normalized 4s-averaged 4cm<sup>2</sup>PD versus time determined in Step 4, and (c) corresponding total normalized time-averaged RF exposure (sum of steps (a) and (b)) versus time.

The validation criteria is, at all times, the total normalized time-averaged RF exposure versus time determined in Step 5.c shall not exceed the normalized limit of 1.0.

### 4.3.3. Change in Antenna Configuration (Beam)

This test is to demonstrate the correct power control by Smart Transmit during changes in antenna configuration (beam). Since the *input.power.limit* varies with beam, the Eq. (2a), (2b) and (2c) in §2 are written as below for transmission scenarios having change in beam:

$$1g \text{ or } 10gSAR(t) = \frac{\text{conducted Tx power}(t)}{\text{conducted Tx power } P_{limit}} * 1g \text{ or } 10g SAR P_{limit} \quad (8a)$$

$$4 \text{ cm}^2 PD_1(t) = \frac{\text{radiated Tx power } 1(t)}{\text{radiated Tx power input.power.limit}_1} * 4 \text{ cm}^2 PD \text{ input.power.limit}_1 \quad (8b)$$

$$4 \text{ cm}^2 PD_2(t) = \frac{\text{radiated Tx power } 2(t)}{\text{radiated Tx power input.power.limit}_2} * 4 \text{ cm}^2 PD \text{ input.power.limit}_2 \quad (8c)$$

$$\frac{\frac{1}{T_{SAR}} \int_{t-T_{SAR}}^t 1g \text{ or } 10g SAR(t) dt}{FCC SAR limit} + \frac{\frac{1}{T_{PD}} \left[ \int_{t-T_{PD}}^{t_1} 4 \text{ cm}^2 PD_1(t) dt + \int_{t_1}^t 4 \text{ cm}^2 PD_2(t) dt \right]}{FCC 4 \text{ cm}^2 PD limit} \leq 1 \quad (8d)$$

where, *conducted Tx power(t)*, *conducted Tx power P<sub>limit</sub>*, and *1gSAR P<sub>limit</sub>* correspond to the measured instantaneous conducted transmission power, measured conducted transmission power at *P<sub>limit</sub>*, and measured 1g SAR values at *P<sub>limit</sub>* corresponding to Sub-6 GHz transmission. Similarly, *radiated Tx power 1(t)*, *radiated Tx power input.power.limit<sub>1</sub>*, and *4 cm<sup>2</sup> PD input.power.limit<sub>1</sub>* correspond to the measured instantaneous radiated transmission power, radiated Tx power at *input.power.limit*, and 4 cm<sup>2</sup> PD value at *input.power.limit* of beam 1; *radiated Tx power 2(t)*, *radiated Tx power input.power.limit<sub>2</sub>*, and *4 cm<sup>2</sup> PD input.power.limit<sub>2</sub>* correspond to the measured instantaneous radiated transmission power, radiated Tx power at *input.power.limit*, and 4 cm<sup>2</sup> PD value at *input.power.limit* of beam 2 corresponding to mmW transmission.

<sup>9</sup> The purpose of this test in §4.3.2 is to cover three exposure scenarios (SAR only, SAR+PD, and PD only scenarios) and demonstrate total time-averaged RF exposure is compliant when switching among these exposure scenarios. In some cases, it is possible that LTE all-up bits for 40s may not be sufficient for mmW to drop to simulate SAR-only exposure scenario. In those cases, the test timing should be adjusted to serve the purpose of the test.

## Test Procedure

1. Set EUT to intended Smart Transmit exposure mode for LTE + mmW call. First, establish mmW NR call with callbox requesting UE to transmit at maximum mmW power. As soon as the mmW connection is established, request all-down bits on LTE link. After 100s, request the UE to change from beam 1 to beam 2. Record the conducted Tx power of LTE and radiated Tx power of mmW for the entire duration of this test of ~200s. Do not disturb the position of the EUT inside the anechoic chamber to perform Step 2.a measurement below.
2. Measure conducted Tx power corresponding to P<sub>limit</sub> for LTE in selected band, and measure radiated Tx power corresponding to input.power.limit in desired mmW band/channel/beam. Test condition to measure conducted P<sub>limit</sub> and radiated input.power.limit is:
  - a. At the tested angle in Step 1, measure radiated power corresponding to mmW input.power.limit by setting up the UE to transmit in desired band/channel/beam1 at input.power.limit in Factory Test Mode. Repeat this Step for beam 2 as well.
  - b. Rotate the UE to the peak angle to measure maximum radiated power (i.e., peak EIRP) corresponding to mmW input.power.limit by setting up the UE to transmit in desired band/channel/beam\_1 at input.power.limit in Factory Test Mode. This value corresponds to *radiated\_Tx\_power\_input.power.limit\_1* in Eq.(8b). Repeat this Step for beam\_2 as well.
  - c. Measure conducted Tx power corresponding to LTE P<sub>limit</sub> with Smart Transmit Peak exposure mode enabled and callbox set to request maximum power.
3. From the measurement in Step 1, extract instantaneous Tx power versus time for both LTE and mmW links. Convert the conducted Tx power for LTE into 1g\_or\_10gSAR value (see Eq. (8a)) using Step 2.c result, and then divide this by 1g\_or\_10gSAR limit to obtain instantaneous normalized 1g\_or\_10gSAR versus time. Perform 100s running average to determine normalized 100s-averaged 1g\_or\_10gSAR versus time as illustrated in Figure 3-1. Note that in Eq.(8a), instantaneous Tx power is converted into instantaneous 1g\_or\_10gSAR value by applying the worst-case 1g\_or\_10gSAR value of the technology/band at P<sub>limit</sub> as reported in the Part 1 report.
4. Similarly, convert instantaneous radiated Tx power versus time for beam 1 in Step 1 at tested angle into peak angle by dividing with measured value in Step 2.a and multiplying by value in Step 2.b corresponding to beam\_1 to determine "*radiated\_Tx\_power\_1(t)*" versus time. Similarly, repeat this Step for beam 2 to determine "*radiated\_Tx\_power\_2(t)*".
5. Convert the *radiated\_Tx\_power* for beam 1 and beam 2 in Step 4 into 4cm2PD value (see Eq. (8b) & (8c)) using corresponding Step 2.b results, and then divide this by regulatory 4cm2PD limit of 10W/m<sup>2</sup> to obtain instantaneous normalized 4cm2PD versus time. Perform 4s running average to determine normalized 4s-averaged 4cm2PD versus time as illustrated in Figure 5-1. Note that in Eq.(8b) & (8c), instantaneous Tx power is converted into instantaneous 4cm2PD by applying the worst-case 4cm2PD value for the selected band/beams at input.power.limit as reported in the Part 1 report.
6. Make one plot containing: (a) computed normalized 100s-averaged 1g\_or\_10gSAR versus time determined in Step 3, (b) computed normalized 4s-averaged 4cm2PD versus time determined in Step 5, and (c) corresponding total normalized time-averaged RF exposure (sum of steps (a) and (b)) versus time.

The validation criteria is, at all times, the total normalized time-averaged RF exposure versus time determined in Step 6.c shall not exceed the normalized limit of 1.0.

### 4.4. Test Procedure for Time-varying PD Measurements

The following steps are used to perform the validation through PD measurement for transmission scenario 1, as described in §2:

1. "Path Loss" calibration: Place the EUT on the DASY platform to perform PD measurement in the worst-case position/surface for the selected mmW band/beam. For all the tests, the callbox is set to request maximum Tx power from EUT all the time. Hence, "path loss" calibration between callbox antenna and EUT is not needed here.
2. Time averaging feature validation:
  - a. Measure conducted Tx power corresponding to P<sub>limit</sub> for LTE in selected band, and measure point E-field corresponding to input.power.limit in desired mmW band/channel/beam. Test condition to measure conducted P<sub>limit</sub> and PD at input.power.limit is:
    - i. Measure conducted Tx power corresponding to LTE P<sub>limit</sub> with Smart Transmit Peak exposure mode enabled and callbox set to request maximum power.
    - ii. Measure pointE corresponding to mmW input.power.limit by setting up the UE to transmit in desired mmW band/channel/beam at input.power.limit in Factory Test Mode. Do not disturb the position of EUT and mmW DASY probe.

- b. Set EUT to intended Smart Transmit exposure mode for LTE (sub6) + mmW call. First, establish LTE (sub6) connection with the callbox, and then mmW connection is added with callbox requesting UE to transmit at maximum mmW power. As soon as the mmW connection is established, request all-down bits on LTE link (otherwise, mmW will not have sufficient RF exposure margin to sustain the call with LTE in high power). Continue LTE (all-down bits)+mmW transmission for more than 100s duration to test predominantly PD exposure scenario (as SAR exposure is negligible from all-down bits in LTE). After 120s, request LTE to go all-up bits, mmW transmission should gradually run out of RF exposure margin and cease mmW transmission. Record the conducted Tx power of LTE and point E-field of mmW for the entire duration of this test of ~500s.
- c. Once the measurement is done, extract instantaneous Tx power versus time for LTE and point E-field versus time from DASY system for mmW. Convert the conducted Tx power for LTE into  $1g\_or\_10gSAR$  value (see Eq. (4a)) using Step 2.a.i result, and then divide this by  $1g\_or\_10gSAR$  limit to obtain instantaneous normalized  $1g\_or\_10gSAR$  versus time. Perform 100s running average to determine normalized 100s-averaged  $1g\_or\_10gSAR$  versus time as illustrated in Figure 3-1. Note that in Eq.(4a), instantaneous Tx power is converted into instantaneous  $1g\_or\_10gSAR$  value by applying the worst-case  $1g\_or\_10gSAR$  value of the technology/band at P<sub>limit</sub> as reported in the Part 1 report.
- d. Similarly, convert the point E-field for mmW into  $4cm2PD$  value (see Eq. (4b)) using Step 2.a.ii result, and then divide this by regulatory  $4cm2PD$  limit of  $10W/m^2$  to obtain instantaneous normalized  $4cm2PD$  versus time. Perform 4s running average to determine normalized 4s-averaged  $4cm2PD$  versus time as illustrated in Figure 3-1.
- e. Make one plot containing: (i) computed normalized 100s-averaged  $1g\_or\_10gSAR$  versus time determined in Step 2.c, (ii) computed normalized 4s-averaged  $4cm2PD$  versus time determined in Step 2.d, and (iii) corresponding total normalized time-averaged RF exposure (sum of steps (2.e.i) and (2.e.ii)) versus time.

The validation criteria is, at all times, the total normalized time-averaged RF exposure versus time determined in Step 2.e.iii shall not exceed the normalized limit of 1.0.

## 5. Test Configurations

### 5.1. WWAN (Sub-6 GHz) Transmission

The  $P_{limit}$  values for technologies and bands supported by the EUT are derived in the Part 0 report and summarized in Table 5-1.<sup>10, 11</sup>

Based on the selection criteria described in §3.2.1, the selected technologies/bands for testing time-varying test sequences are shaded in Table 5-1. As per the Part 1 report, the *Reserve\_power\_margin* (dB) is set to 3 dB in the device EFS and is used in the Part 2 test.

The radio configurations used in the Part 2 test for selected technologies/bands/DSI states/antennas are listed in Table 5-2<sup>12</sup>. The corresponding worst-case radio configuration 1g SAR values for selected technology/band/DSI are extracted from the Part 1 report and are listed in the last column of Table 5-2.

Based on equations (1a), (2a), (3a) and (4a), Part 2 testing outcome is the normalized quantity, which implies that it can be applied to any radio configuration within a selected technology/band/DSI. Thus, applying the worst-case SAR obtained from the worst radio configuration in Part 1 testing to calculate time-varying SAR exposure in equations (1a), (2a), (3a) and (4a), the accuracy in compliance demonstration remains the same.<sup>13</sup>

---

<sup>10</sup> All  $P_{limit}$  power levels entered in Table 5-1 correspond to average power levels after accounting for duty cycle in the case of TDD modulation schemes, e.g., GSM, LTE TDD & Sub-6 GHz NR TDD.

<sup>11</sup> Maximum tune up target power,  $P_{max}$ , is configured in the NV settings within the EUT to limit maximum transmitting power. This power is converted into peak power in the NV settings for TDD schemes. The EUT's maximum allowed output power is equal to  $P_{max}$  + device uncertainty (dB).

<sup>12</sup> The head exposure can be distinguished through audio receiver mode, represented as DSI state 0. DSI state 1 represents all other exposures which cannot be distinguished; thus, in this case, the maximum 1g SAR and/or 10g SAR among all remaining exposure scenarios or the minimum  $P_{limit}$  among all remaining exposure scenarios (i.e., body worn 1g SAR evaluation at 5 mm spacing) is used in the Smart Transmit feature for time averaging operation.

<sup>13</sup> If wireless device supports Smart Transmit GEN2 Sub-6 GHz antenna groups, then Sub-6 GHz antenna grouping table should also be listed here in addition to the  $P_{limit}$  table above for the technologies/bands/antennas/DSI selected for Part 2 test.

**Table 5-1: Plimit for supported technologies and bands (Plimit in EFS file)**

Tech/Band	Antenna			Worst-case SAR (W/kg)			P <sub>limit</sub> Max Tune-up Power (dBm) + Uncertainty (dBm)		
	Head	Body & Hotspot	Hotspot	Head	Body & Hotspot	Hotspot	Head	Body & Hotspot	Hotspot
	DSI: 0	DSI: 1	DSI: 1	DSI: 0	DSI: 1	DSI: 1	DSI: 0	DSI: 1	DSI: 1
GSM 850 2 slots	ANT 2	ANT 1	ANT 1	0.894	0.895	0.895	29.00	30.20	30.20
GSM 1900 2 slots	ANT 4	ANT 2	ANT 2	0.931	0.939	0.939	25.40	26.70	26.70
W-CDMA B2	ANT 2	ANT 2	ANT 4	0.932	0.898	0.919	20.60	20.70	20.20
W-CDMA B4	ANT 2	ANT 4	ANT 1	0.903	0.854	0.937	22.60	20.10	19.10
W-CDMA B5	ANT 2	ANT 1	ANT 1	0.822	0.886	0.886	23.00	24.20	24.20
LTE Band 5	ANT 2	ANT 2	ANT 2	0.882	0.849	0.849	23.00	24.50	24.50
LTE Band 7	ANT 2	ANT 2	ANT 1	0.922	0.925	0.943	18.90	20.20	20.00
LTE Band 12/17	ANT 2	ANT 1	ANT 1	0.885	0.886	0.886	23.50	24.90	24.90
LTE Band 13	ANT 2	ANT 1	ANT 1	0.868	0.862	0.862	22.80	24.10	24.10
LTE Band 14	ANT 2	ANT 2	ANT 2	0.889	0.865	0.865	22.80	24.70	24.70
LTE Band 25/2	ANT 2	ANT 2	ANT 3	0.935	0.930	0.940	20.60	20.70	19.90
LTE Band 26	ANT 2	ANT 2	ANT 2	0.944	0.879	0.879	23.00	24.50	24.50
LTE Band 30	ANT 4	ANT 4	ANT 4	0.893	0.940	0.940	20.30	19.90	19.90
LTE Band 41	ANT 4	ANT 2	ANT 1	0.939	0.932	0.946	19.50	21.40	22.00
LTE Band 48	ANT 8	ANT 7	ANT 7	0.927	0.880	0.940	23.40	22.40	22.40
LTE Band 53	ANT 2	ANT 2	ANT 1	0.723	0.638	0.834	20.70	20.70	20.70
LTE Band 66/4	ANT 2	ANT 2	ANT 1	0.936	0.933	0.936	22.60	23.00	19.10
LTE Band 71	ANT 2	ANT 2	ANT 1	0.759	0.696	0.824	22.70	24.70	25.70
NR n5	ANT 2	ANT 1	ANT 1	0.878	0.824	0.824	23.00	24.20	24.20
NR n7	ANT 4	ANT 2	ANT 3	0.932	0.921	0.935	17.80	20.20	19.20
NR n12	ANT 2	ANT 1	ANT 1	0.859	0.859	0.859	23.50	24.90	24.90
NR n14	ANT 2	ANT 2	ANT 2	0.815	0.812	0.812	22.80	24.70	24.70
NR n25/2	ANT 2	ANT 1	ANT 1	0.921	0.919	0.919	20.60	20.90	20.90
NR n26	ANT 2	ANT 1	ANT 1	0.719	0.848	0.848	23.00	24.20	24.20
NR n30	ANT 2	ANT 2	ANT 2	0.829	0.924	0.924	17.00	18.60	18.60
NR n41	ANT 4	ANT 2	ANT 4	0.888	0.896	0.937	17.50	19.40	17.70
NR n53	ANT 2	ANT 1	ANT 1	0.742	0.921	0.938	18.70	19.20	19.20
NR n66	ANT 4	ANT 2	ANT 3	0.902	0.885	0.928	19.80	23.00	21.30
NR n70	ANT 4	ANT 4	ANT 1	0.924	0.899	0.921	19.80	20.10	19.10
NR n71	ANT 2	ANT 2	ANT 1	0.848	0.620	0.824	22.70	24.70	25.70
NR n77	ANT 4	ANT 4	ANT 7	0.927	0.940	0.941	19.50	19.10	19.50

**Table 5-2: Radio configurations selected for Part 2**

Part 2 Test Configurations											Part 1 worst-case radio config 1g SAR measured at P <sub>lim</sub> (W/kg)
Test Case	Test Scenario	Tech	Band	ANT	DSI	Channel	Freq	RB/Offset	Mode	Detail	
1	time-varying Tx power transmission (Seq1/Seq2) for conducted power	GSM	1900	1	1	512	1850.2	N/A	B	GSM   Rear   1-g   5mm	0.661
3		WCDMA	BIV	1	1	1513	1752.6	N/A	B	UMTS   Edge 3   1-g   5mm	0.895
5		LTE	B66/4	1	1	132072	1720.0	50/24	B	LTE   Edge 3   1-g   5mm	0.815
7		sub6 NR	n41	3	1	518598	2593.0	1/136	B	NR   Edge 4   1-g   5mm	0.747
9	call drop for conducted power test	LTE	B66/4	1	1	132072	1720.0	50/24	B	LTE   Edge 3   1-g   5mm	0.815
10	tech/band for conducted power test	WCDMA	BIV	1	1	1513	1752.6	N/A	B	UMTS   Edge 3   1-g   5mm	0.895
		LTE	B66/4	1	1	132072	1720.0	50/24	B	LTE   Edge 3   1-g   5mm	0.815
11	DSI switch for conducted power test	LTE	B66/4	1	0	132322	1745.0	1/49	A	LTE   Right Touch   1-g   0mm	0.235
		LTE	B66/4	1	1	132072	1720.0	50/24	B	LTE   Edge 3   1-g   5mm	0.815
12	Time-window/Ant switch for conducted power test	LTE	B66/4	1	1	132072	1720.0	50/24	B	LTE   Edge 3   1-g   5mm	0.815
		LTE	B48	7	1	55340	3560.0	50/24	B	LTE   Edge 2   1-g   5mm	0.874
13	SAR exposure switch for conducted power test	ENDC	n25	3	1	376500	1882.5	1/107	B	NR   Edge 4   1-g   5mm	0.727
			B66/4	3	1	132322	1745.0	100/0	B	LTE   Edge 4   1-g   5mm	0.778
14		interband ULCA	B5	1	1	20525	836.5	25/12	B	LTE   Rear   1-g   5mm	0.735
			B66/4	4	1	132572	1770.0	1/49	B	LTE   Rear   1-g   5mm	0.748



Based on the selection criteria described in §3.2, the radio configurations for the transmission varying test cases listed in §2 are:

1. Technologies and bands for time-varying Tx power transmission: The test case 1~10 listed in Table 5-2 are selected to test with the test sequences defined in §3.1 in both time-varying conducted power measurements and time-varying SAR measurements.
2. Technology and band for change in call test: Select the technology and frequency band having the lowest  $P_{limit}$  among all technologies and bands (test case 11 in Table 5-2) for performing the call drop test in conducted power setup.
3. Technologies and bands for change in technology/band test: Following the guidelines in §3.2.3 and 4.2.4, test case 12 in Table 5-2 is selected for handover test from a technology/band/antenna with approximately the highest  $P_{limit}$  within one technology group, to a technology/band in the same DSI state with approximately the lowest  $P_{limit}$  within another technology group in a conducted power setup.
4. Technologies and bands for change in DSI: Based on selection criteria in §3.2.5, for a given technology and band, test case 13 in Table 5-2 is selected for DSI switch test by establishing a call in one technology and DSI state and then handing over to another DSI state/exposure scenario in a conducted power setup.
5. Technologies and bands for change in time-window/antenna: Based on selection criteria in §3.2.6, for a given DSI state, test case 14 in Table 5-2 is selected for time window switch between 60 seconds window and 100 seconds window in a conducted power setup.
6. Technologies and bands for switch in SAR exposure: Based on selection criteria in §3.2.7 Scenario 1, test case 15 in Table 5-2 is selected for SAR exposure switching test in one of the supported simultaneous WWAN transmission scenario, i.e., LTE + Sub6 NR active in the same 100 seconds time window, in a conducted power setup. Since this device supports Sub-6 GHz + mmW NR, test for §3.2.7 Scenario 2 for RF exposure switch is covered in §9.2.3 and 9.2.4 between Sub-6 GHz (100 seconds window) and mmW NR (4 seconds window).

## 5.2. LTE + mmW NR Transmission

Based on the selection criteria described in §4.2, the selections for LTE and mmW NR validation test are listed in Table 5-3. The radio configurations used in this test are listed in Table 5-4.<sup>14</sup>

**Table 5-3: Selections for LTE + mmW NR validation measurements**

Transmission Scenario	Test	Technology and Band	mmW Beam
Time-varying Tx power test	1. Cond. & Rad. Power meas.	LTE B25/2 and n261	Beam ID 38
Switch in SAR vs. PD	1. Cond. & Rad. Power meas.	LTE B25/2 and n261	Beam ID 38
Beam switch test	1. Cond. & Rad. Power meas.	LTE B25/2 and n261	Beam ID 38 to Beam ID 5

**Table 5-4: Test configuration for LTE + mmW NR validation**

Tech	Band	Antenna	DSI	Channel	RB Size	RB Offset	Freq (MHz)	Mode	UL Duty Cycle
LTE	25/2	1	1	MID	1	49	1880	QPSK	100%
mmW NR	N261	M3	--	MID	1		27925	CW	100% <sup>1</sup>

<sup>14</sup> mmW NR callbox UL duty cycle should be configured to be greater than 75% for all LTE + mmW NR Part 2 tests.

## 6. Conducted Power Test Results for Sub-6 GHz Smart Transmit Feature Validation

### 6.1. Measurement Setup

The Rohde & Schwarz CMW500 callbox is used in this test. The test setup picture and schematic are shown in Figures 7-1a and 7-1b for measurements with a single antenna and in Figure 6-1c for measurements involving antenna switching (see Appendix E for missing figures). For single antenna measurements, one port (RF1 COM) of the callbox is connected to the RF port of the EUT using a directional coupler. For antenna & technology switch measurement, two ports (RF1 COM and RF3 COM) of the callbox are used for signaling two different technologies are connected to a combiner, which is, in turn, connected to a directional coupler. The other end of the directional coupler is connected to a splitter to connect to two RF ports of the EUT corresponding to the two antennas of interest. In both the setups, a power meter is used to tap the directional coupler for measuring the conducted output power of the EUT. For time averaging validation test (§3.3.1), call drop test (§3.3.2), and DSI switch test (§3.3.4), only RF1 COM port of the callbox is used to communicate with the EUT. For technology/band switch measurement (§3.3.3), both RF1 COM and RF3 COM ports of the callbox are used to switch from one technology communicating on RF1 COM port to another technology communicating on RF3 COM port.<sup>15</sup> All the path losses from the RF port of the EUT to the callbox RF COM port and to the power meter are calibrated and automatically entered as offsets in the callbox and the power meter via test scripts on the PC used to control callbox and power meter.

### 6.2. $P_{limit}$ and $P_{max}$ Measurement Results

The measured  $P_{limit}$  for all the selected radio configurations given in Table 5-2 are listed in Table 6-1.  $P_{max}$  was also measured for radio configurations selected for testing time-varying power transmission scenarios to generate test sequences following the test procedures in §3.1.

**Table 6-1: Measured  $P_{limit}$  and  $P_{max}$  of Selected Radio Configurations**

Test Scenario	Tech	Band	ANT	DSI	Channel	Freq	RB/Offset	Mode	Detail(s)	$P_{lim}$ EFS Setting <sup>1</sup> (Burst)	Tune-up Target Power $P_{max}$ (Burst)	Measured $P_{lim}$
time-varying Tx power transmission (Seq1/Seq2) for conducted power	GSM	1900	1	1	512	1850.2	N/A	B	GSM   Rear   1-g   5mm	25.90	31.00	24.80
	WCDMA	BIV	1	1	1513	1752.6	N/A	B	UMTS   Edge 3   1-g   5mm	18.40	25.70	18.20
	LTE	B66/4	1	1	132072	1720.0	50/24	B	LTE   Edge 3   1-g   5mm	18.40	25.70	17.80
	sub6 NR	n41	3	1	518598	2593.0	1/136	B	NR   Edge 4   1-g   5mm	18.30	25.70	17.60
call drop for conducted power test	LTE	B66/4	1	1	132072	1720.0	50/24	B	LTE   Edge 3   1-g   5mm	18.40	25.70	17.80
tech/band for conducted power test	LTE	BIV	1	1	1513	1752.6	N/A	B	UMTS   Edge 3   1-g   5mm	18.40	25.70	18.20
	LTE	B66/4	1	1	132072	1720.0	50/24	B	LTE   Edge 3   1-g   5mm	18.40	25.70	17.80
DSI switch for conducted power test	LTE	B66/4	1	0	132322	1745.0	1/49	A	LTE   Right Touch   1-g   0mm	24.50	25.70	24.30
	LTE	B66/4	1	1	132072	1720.0	50/24	B	LTE   Edge 3   1-g   5mm	18.40	25.70	17.80
Time-window/Ant switch for conducted power test	LTE	B66/4	1	1	132072	1720.0	50/24	B	LTE   Edge 3   1-g   5mm	18.40	25.70	17.80
	LTE	B48	7	1	55340	3560.0	50/24	B	LTE   Edge 2   1-g   5mm	21.40	25.30	21.10
SAR exposure switch for conducted power test	ENDC	n25	3	1	376500	1882.5	1/107	B	NR   Edge 4   1-g   5mm	19.20	25.50	18.50
		B66/4	3	1	132322	1745.0	100/0	B	LTE   Edge 4   1-g   5mm	20.60	25.50	19.80
	interband ULCA	B5	1	1	20525	836.5	25/12	B	LTE   Rear   1-g   5mm	23.50	25.70	23.30
		B66/4	4	1	132572	1770.0	1/49	B	LTE   Rear   1-g   5mm	19.40	25.20	18.60

<sup>1</sup> Lists the target power without manufacturer tolerance (uncertainty) per specified configuration.

<sup>15</sup> For this EUT, antenna switch test (§3.3.4) is included within time-window switch test (§3.3.6) as the selected technology/band combinations for the time-window switch test are on two different antennas.

LTE + Sub-6 GHz NR Test Setup:

If the LTE conducted port and Sub-6 GHz NR conducted port are same on this EUT (i.e., they share the same antenna), then low-/high-pass filters are used to separate the LTE and Sub-6 GHz NR signals for power meter measurement via directional couplers, as shown in below Figures 7-1b and 7-1c.

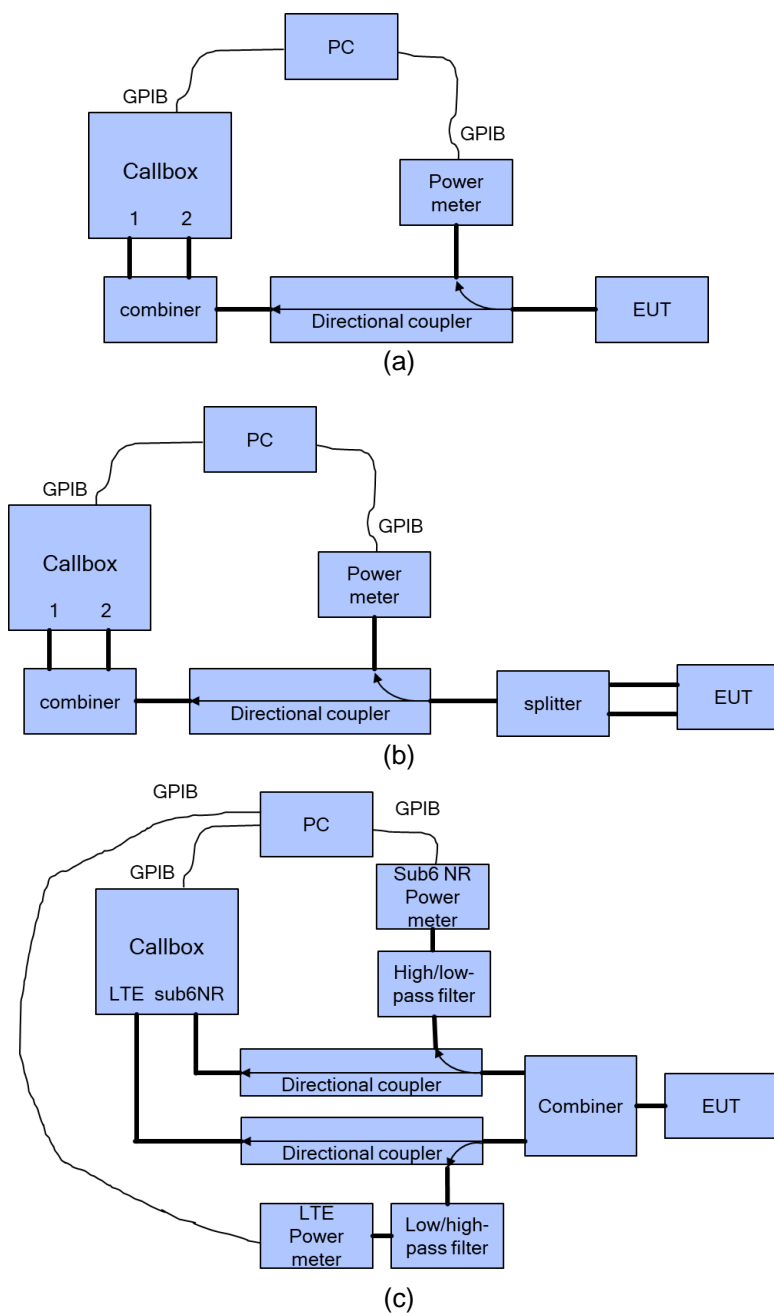

**Figure 6-1a – 6-1c: Conducted power measurement setup**

Both the callbox and power meter are connected to the PC using GPIB cables. Two test scripts are custom made for automation and the test duration set in the test scripts is 500 seconds.

For time-varying transmission power measurement, the PC runs the first test script to send GPIB commands to control the callbox’s requested power versus time, while, at the same time, recording the conducted power measured at the EUT’s RF port using the power meter. The commands sent to the callbox to request power are:

- 0 dBm for 100 seconds.

- Test sequence 1 or test sequence 2 (defined in §3.1 and generated in §3.2.1) for 360 seconds.
- Stay at the last power level of test sequence 1 or test sequence 2 for the remaining time.

Power meter readings are periodically recorded every 0.1s for sub6 technologies. A running average of this measured Tx power over 100 seconds (i.e., 1000 data points collected at 0.1s sampling rate) is performed in the post-data processing to determine the 100s-time averaged power.

For call drop and technology/band switch tests, the callbox is set to request maximum power all the time. When the call is established, the 2nd test script runs at the same time to start recording the Tx power measured at EUT RF port using the power meter, the call drop/re-establish, or technology/band switch is performed when the Tx power of EUT is at sustainable power level. See Section 5.3.2 for detailed test procedure of call drop test, and Section 5.3.3 for detailed test procedure of technology/band switch test.

To demonstrate compliance, all the conducted Tx power measurement results were converted into 1g\_or\_10gSAR values by using equation (3a) listed below:

$$1g\_or\_10gSAR(t) = \text{conducted\_Tx\_power}(t) / \text{conducted\_Tx\_power\_Plimit} * 1g\_or\_10gSAR\_Plimit \quad (3a)$$

and by applying the worst-case 1g\_or\_10gSAR value for each technology/band at Plimit as reported in the Part 1 report.

### 6.3. Time-varying Transmission Power Measurement Results

The measured Pmax and measured Plimit of each selected radio configuration are used for generation of test sequences following the test plan in §3.3.1. The purpose of the time-varying transmit power measurement is to demonstrate the effectiveness of power limiting enforcement and that the time averaged transmit power when converted into 1gSAR values does not exceed the regulatory limit.

The conducted Tx power measurement results after following the test procedure in §3.3.1 for all technologies and bands listed in Table 5-2 are reported in this section. In all the 1gSAR plots, the green curve represents the 100s-time averaged 1gSAR value calculated based on conducted Tx power measurement; and the red line limit represents the regulatory limit of 1.6W/kg.

As can be seen, the power limiting enforcement is effective in all the tests, and the time-averaged 1gSAR does not exceed the regulatory limit of 1.6W/kg for all the tested technologies/bands. Therefore, Smart Transmit time averaging feature is validated.

### 6.3.1. GPRS PCS Antenna 1 (Test case 1 in Table 5-2)

Test results for Test Sequence 1:

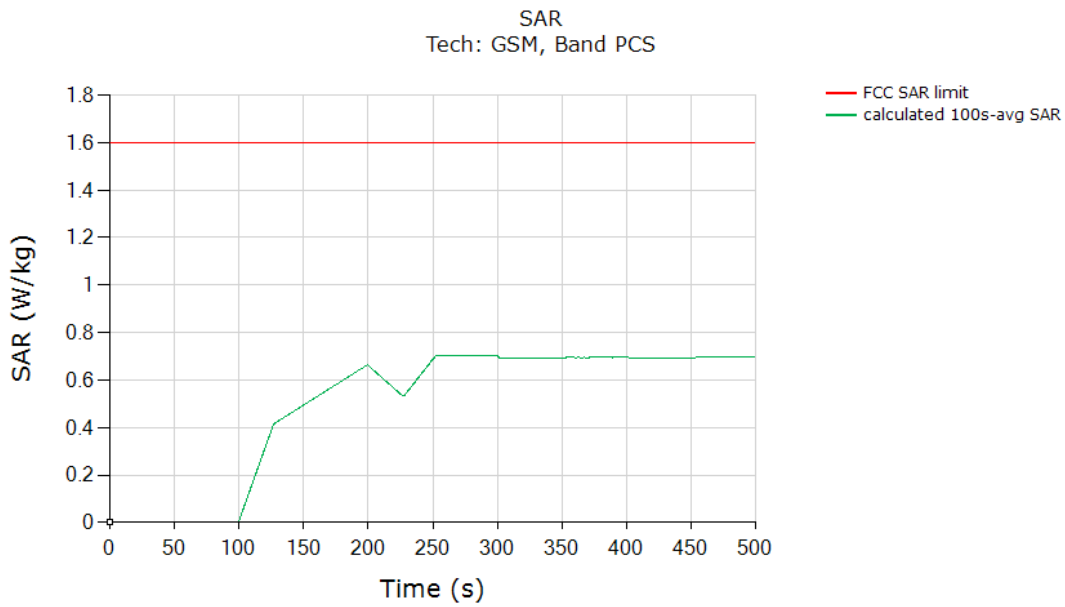

	(W/kg)
FCC 1-g SAR Limit	1.6
Max 100 seconds-time averaged 1-g SAR (green curve)	0.703
<b>Validated:</b> Max time averaged SAR (green curve) is within 0.268 dB device uncertainty of measured SAR at $P_{limit}$ (last column in Table 5-2).	

Test Result for Test Sequence 2:

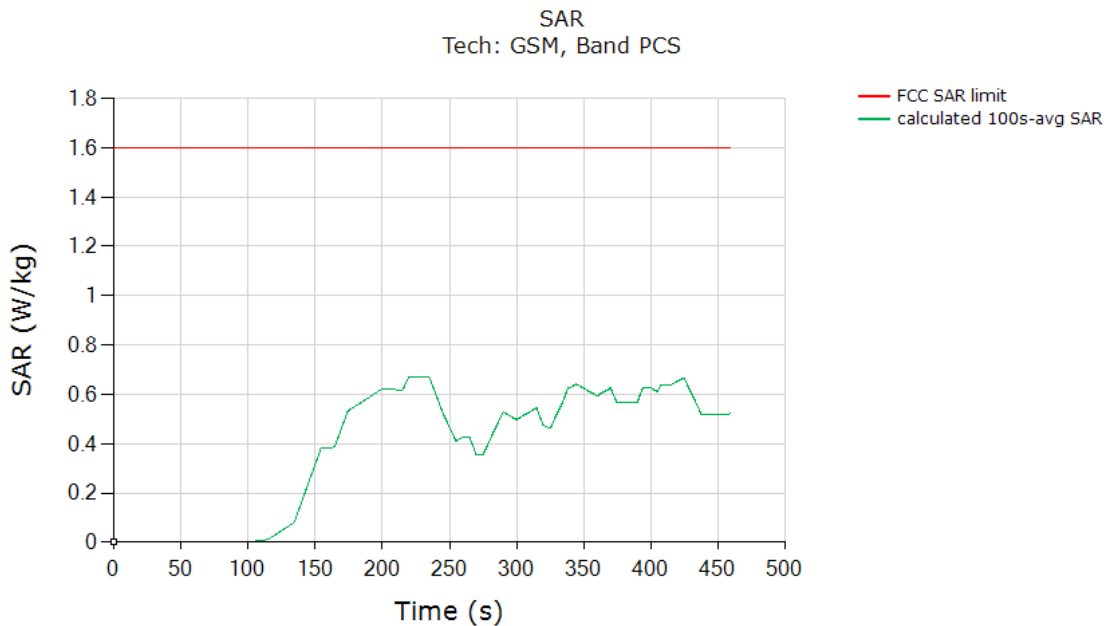

	(W/kg)
FCC 1-g SAR Limit	1.6
Max 100 seconds-time averaged 1-g SAR (green curve)	0.671
<b>Validated:</b> Max time averaged SAR (green curve) is within 0.065 dB device uncertainty of measured SAR at $P_{limit}$ (last column in Table 5-2).	

### 6.3.2. W-CDMA Band IV Antenna 1 (Test Case 3 in Table 5-2)

Test Result for Test Sequence 1:

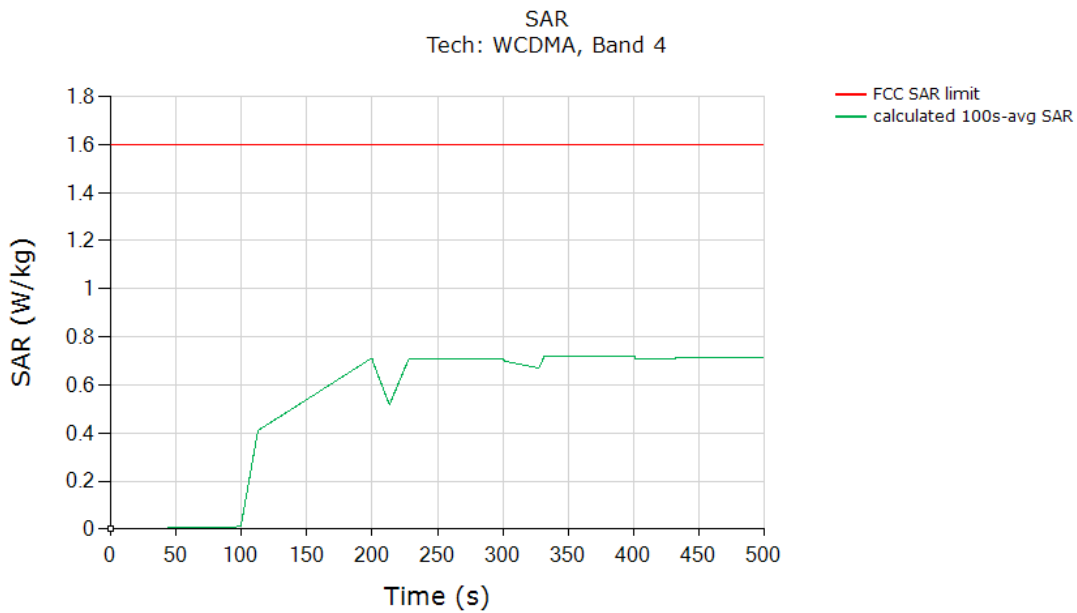

	(W/kg)
FCC 1-g SAR Limit	1.6
Max 100 seconds-time averaged 1-g SAR (green curve)	0.717
<b>Validated:</b> Max time averaged SAR (green curve) is within -0.963 dB device uncertainty of measured SAR at $P_{limit}$ (last column in Table 5-2).	

Test Result for Test Sequence 2:

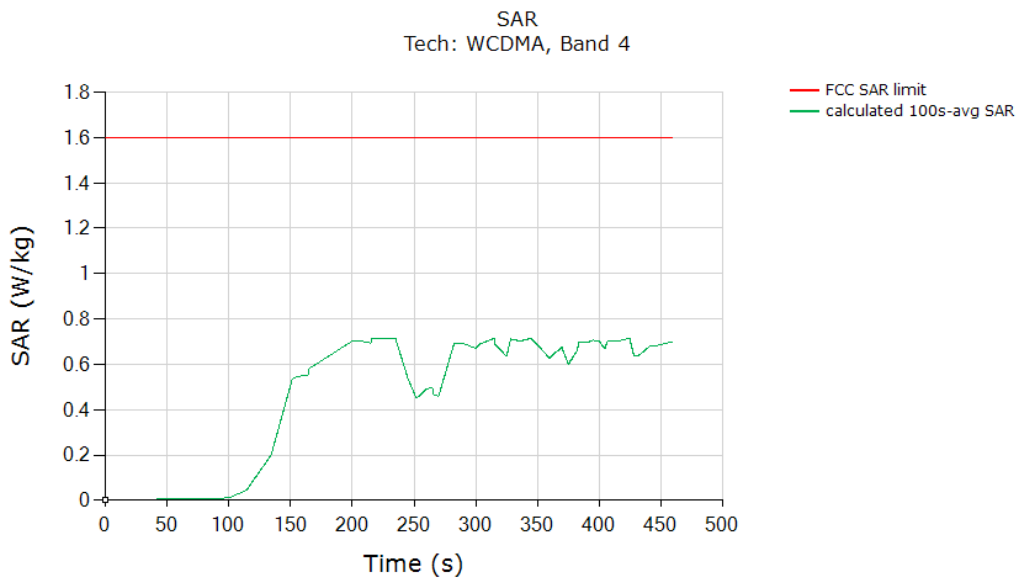

	(W/kg)
FCC 1-g SAR Limit	1.6
Max 100 seconds-time averaged 1-g SAR (green curve)	0.716
<b>Validated:</b> Max time averaged SAR (green curve) is within -0.969 dB device uncertainty of measured SAR at $P_{limit}$ (last column in Table 5-2).	

### 6.3.3. LTE Band 66 Antenna 1 (Test Case 5 in Table 5-2)

Test results for Test Sequence 1:

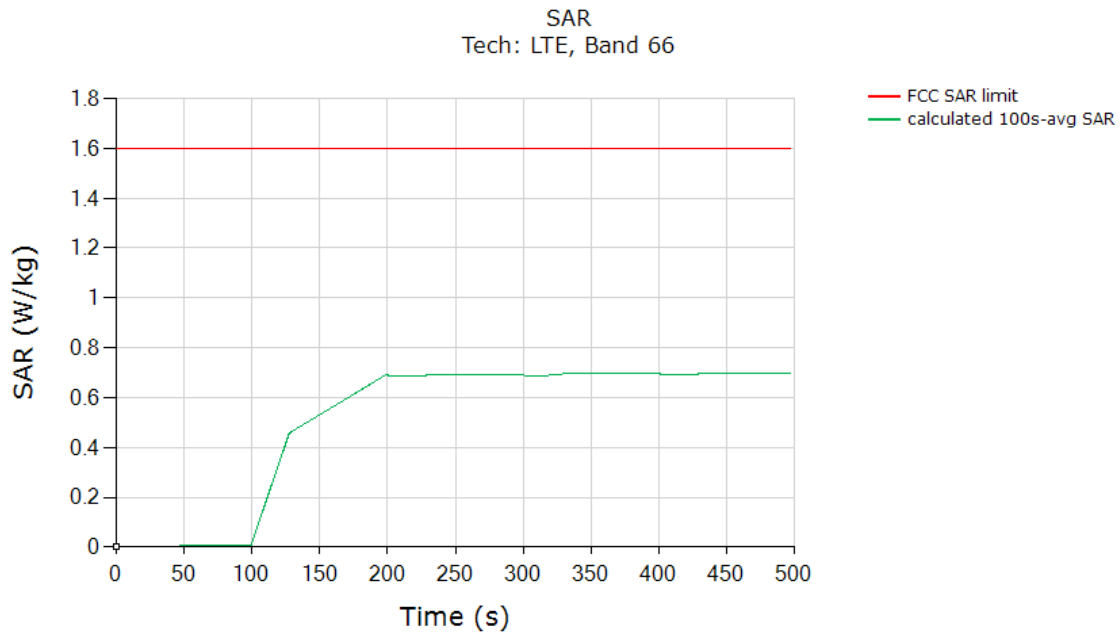

	(W/kg)
FCC 1-g SAR Limit	1.6
Max 100 seconds-time averaged 1-g SAR (green curve)	0.699
Validated: Max time averaged SAR (green curve) is within -0.667 dB device uncertainty of measured SAR at $P_{limit}$ (last column in Table 5-2).	

Test Result for Test Sequence 2:

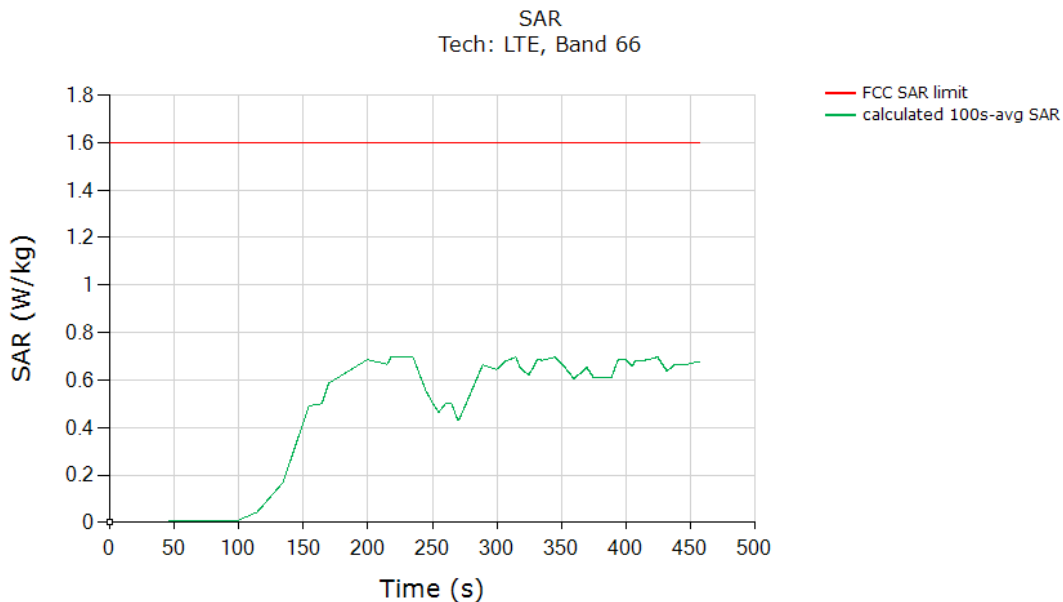

	(W/kg)
FCC 1-g SAR Limit	1.6
Max 100 seconds-time averaged 1-g SAR (green curve)	0.698
Validated: Max time averaged SAR (green curve) is within -0.673 dB device uncertainty of measured SAR at $P_{limit}$ (last column in Table 5-2).	

### 6.3.4. NR Band n41 Antenna 3 (Test Case 8 in Table 5-2)

Test results for Test Sequence 1:

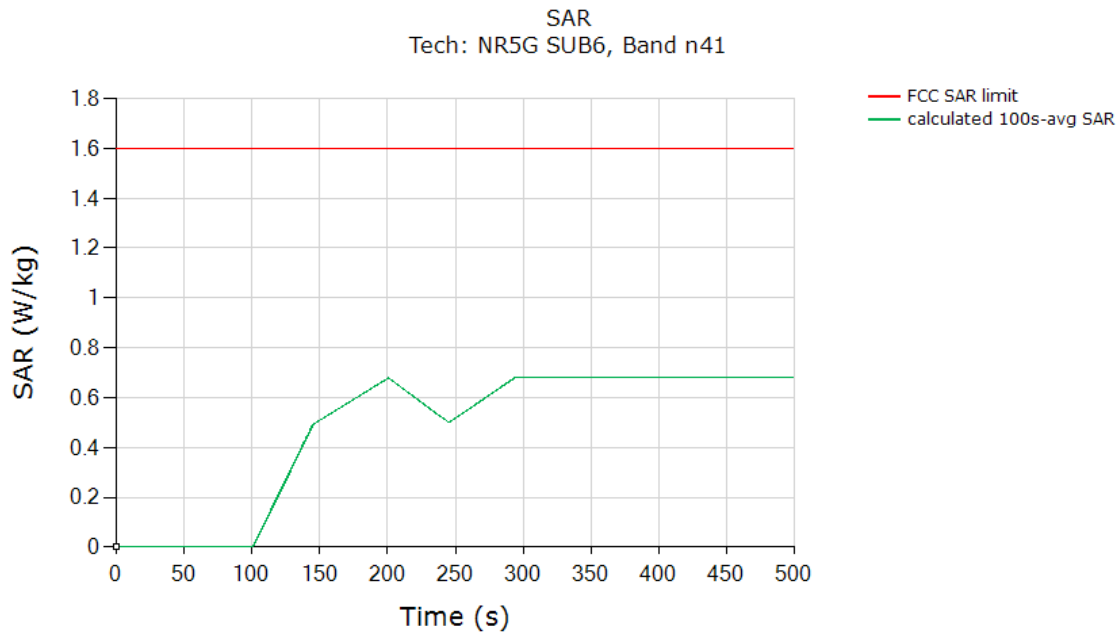

	(W/kg)
FCC 1-g SAR Limit	1.6
Max 100 seconds-time averaged 1-g SAR (green curve)	0.682
Validated: Max time averaged SAR (green curve) is within -0.395 dB device uncertainty of measured SAR at $P_{limit}$ (last column in Table 5-2).	

Test results for Test Sequence 2:

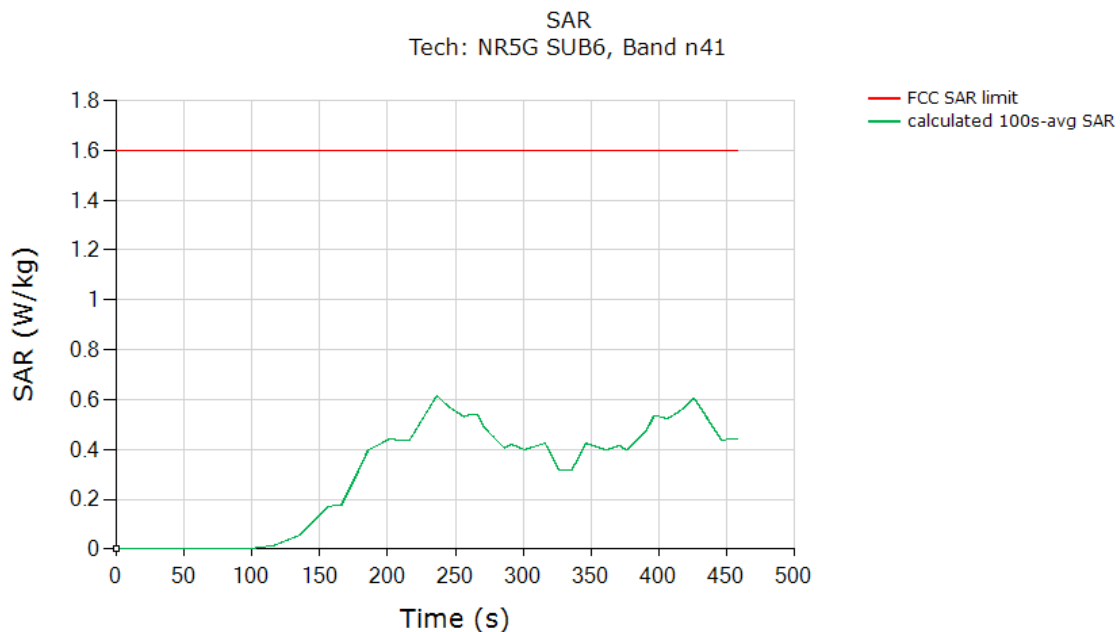

	(W/kg)
FCC 1-g SAR Limit	1.6
Max 100 seconds-time averaged 1-g SAR (green curve)	0.615
Validated: Max time averaged SAR (green curve) is within -0.844 dB device uncertainty of measured SAR at $P_{limit}$ (last column in Table 5-2).	



### 6.4. Call Drop Test Results (Test Case 9 in Table 5-2)

This test was measured with LTE Band 66 and with callbox requesting maximum power. The call drop was performed around  $t = \sim 210s$  and a second call was initiated few seconds later. The measurement setup is shown in Figure 6-1(a) and (c). The detailed test procedure is described in §3.3.2.

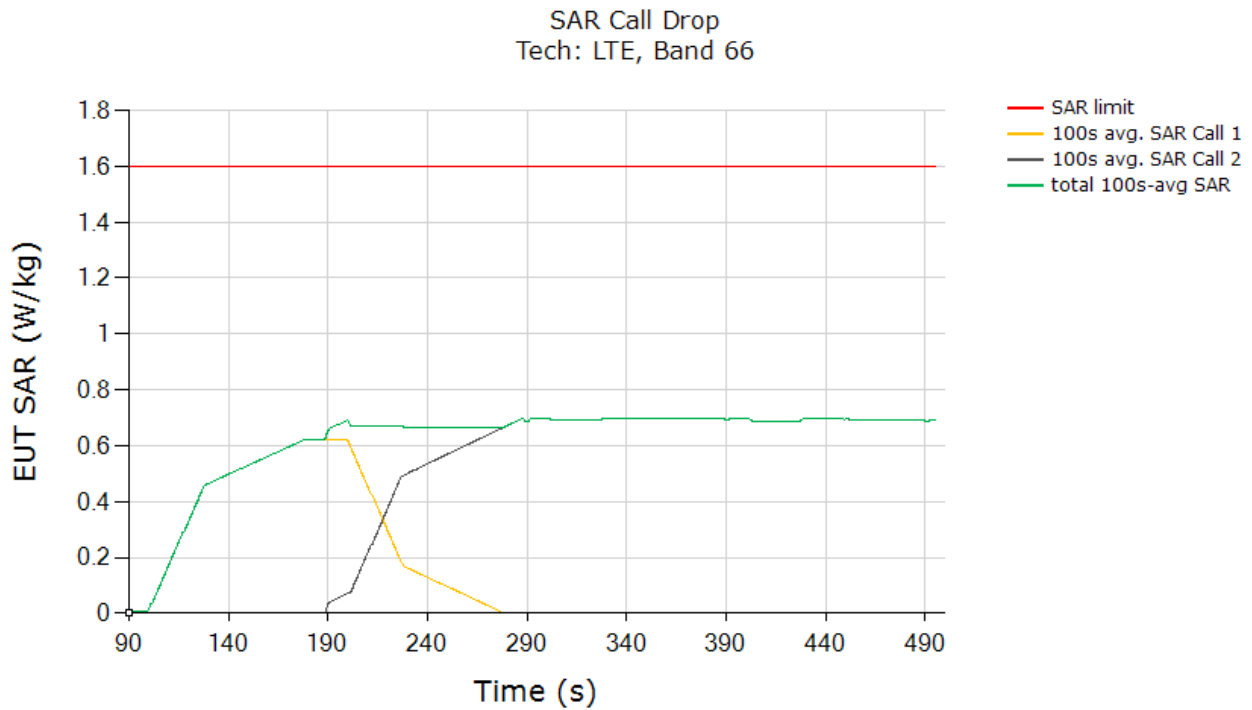

	(W/kg)
FCC 1-g SAR Limit	1.6
Max 100 seconds-time averaged 1-g SAR (green curve)	0.699
Validated	

The test result validated the continuity of power limiting in the call change scenario.

### 6.5. Change in Technology/Band Test Results (Test Case 10 in Table 5-2)

This test was conducted with the callbox requesting maximum power and with an antenna and technology switch from LTE 25/2, Antenna 1, DSI state 1 to W-CDMA IV, Antenna 1, DSI state 1. Following the procedure detailed in §3.3.3 and using the measurement setup shown in Figure 6-1(a) and (c), the technology/band switch was performed around t = ~180 seconds into the test.

Test Result for Change in Technology/Band:

All the time-averaged conducted transmission power measurement results were converted into time-averaged normalized SAR values using Equation (6a), (6b) and (6c), and plotted below to demonstrate that the time-averaged normalized SAR versus time does not exceed the normalized FCC limit of 1.0:

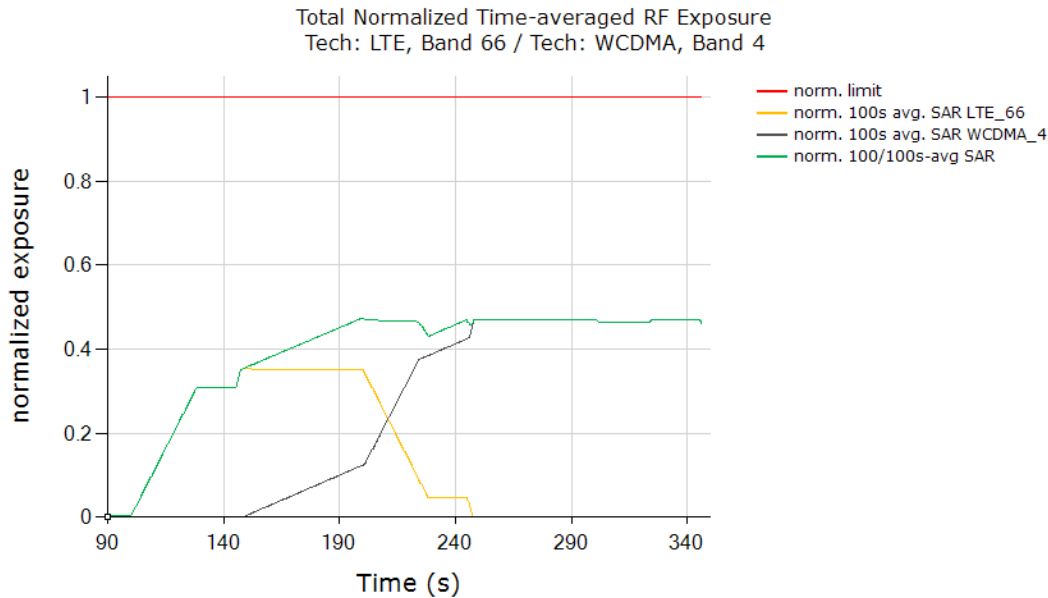

	(W/kg)
FCC normalized SAR Limit	1.0
Max 100 seconds-time averaged normalized 1-g SAR (green curve)	0.475
Validated	

The test result validated the continuity of power limiting in technology/band switch scenario.

### 6.6. Change in DSI Test Results (Test Case 11 in Table 5-2)

This test was conducted with the callbox requesting maximum power, and with the DSI switching states. Following the procedure detailed in §3.3.5 using the measurement setup shown in Figure 6-1(a) and (c), the DSI switch was performed when the EUT is transmitting around t = ~190 seconds into the test.

Test Result for Change in DSI:

All the time-averaged conducted transmission power measurement results were converted into time-averaged normalized SAR values using Equation (6a), (6b) and (6c), and plotted below to demonstrate that the time-averaged normalized SAR versus time does not exceed the normalized FCC limit of 1.0:

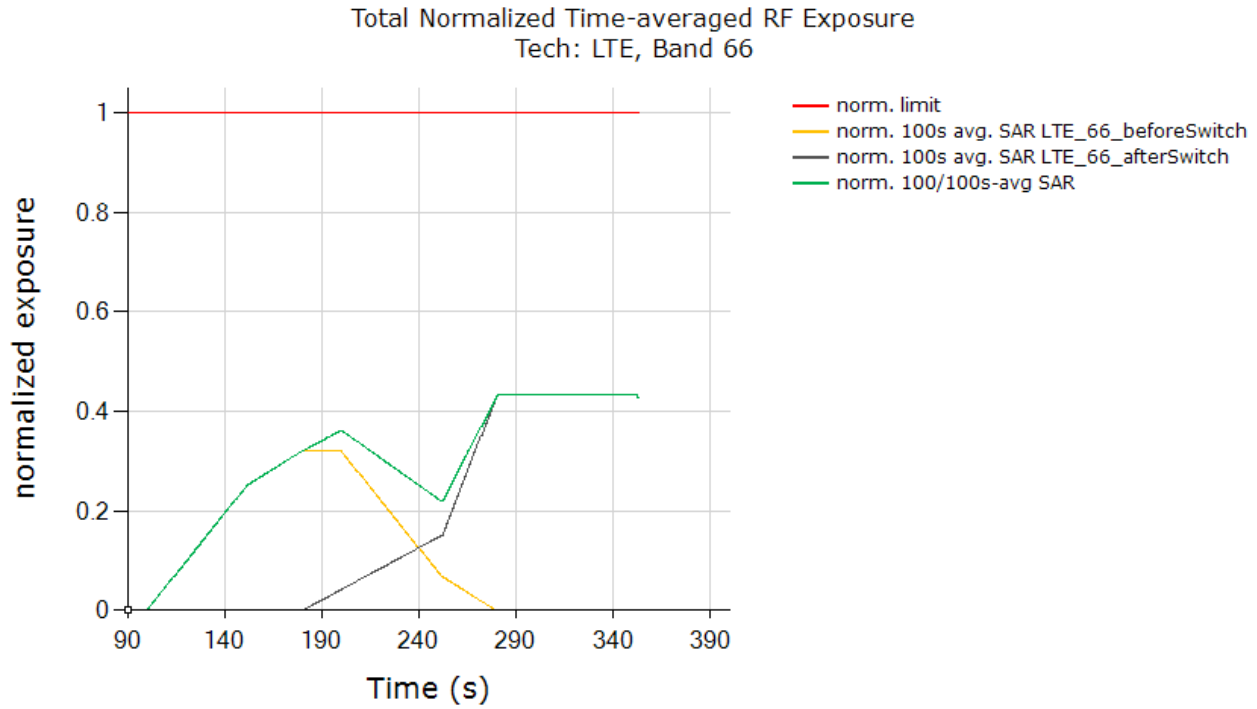

	(W/kg)
FCC normalized SAR Limit	1.0
Max 100 seconds-time averaged normalized 1-g SAR (green curve)	0.433
<b>Validated</b>	

The test result validated the continuity of power limiting in technology/band switch scenario.

### 6.7. Change in Time Window/Antenna Switch Test Results (Test Case 12 in Table 5-2)

This test was conducted with the callbox requesting maximum power and with time-window/antenna switch between LTE 66/4, Antenna 1, DSI = 1 (100 seconds window) and LTE 48, Antenna 7, DSI = 1 (60 seconds window). Following the procedure detailed in §3.3.6 and using the measurement setup shown in Figure 6-1(b) and (d), the time-window switch via tech/band/antenna switch was performed when the EUT is transmitting at  $P_{reserve}$  level.

#### 6.7.1. Transition from LTE 66 to LTE 48 (i.e., 100 seconds to 60 seconds), then Back to LTE 66

Test Result for Change in Time Window (from 100 seconds to 60 seconds to 100 seconds):

All the conducted transmission power measurement results were converted into time-averaged normalized SAR values using Equation (7a), (7b) and (7c) and plotted below to demonstrate that the time-averaged normalized SAR versus time does not exceed the FCC limit of 1 unit. Equation (7a) is used to convert the transmission power of the device to obtain the 60 seconds-averaged normalized SAR for LTE 48 as shown with the black curve. Similarly, equation (7b) is used to obtain the 100 seconds-averaged normalized SAR for LTE 66/4 as shown with the orange curve. Equation (7c) is used to obtain the total time-averaged normalized SAR as shown with the green curve (i.e., the sum of both the black and orange curves).

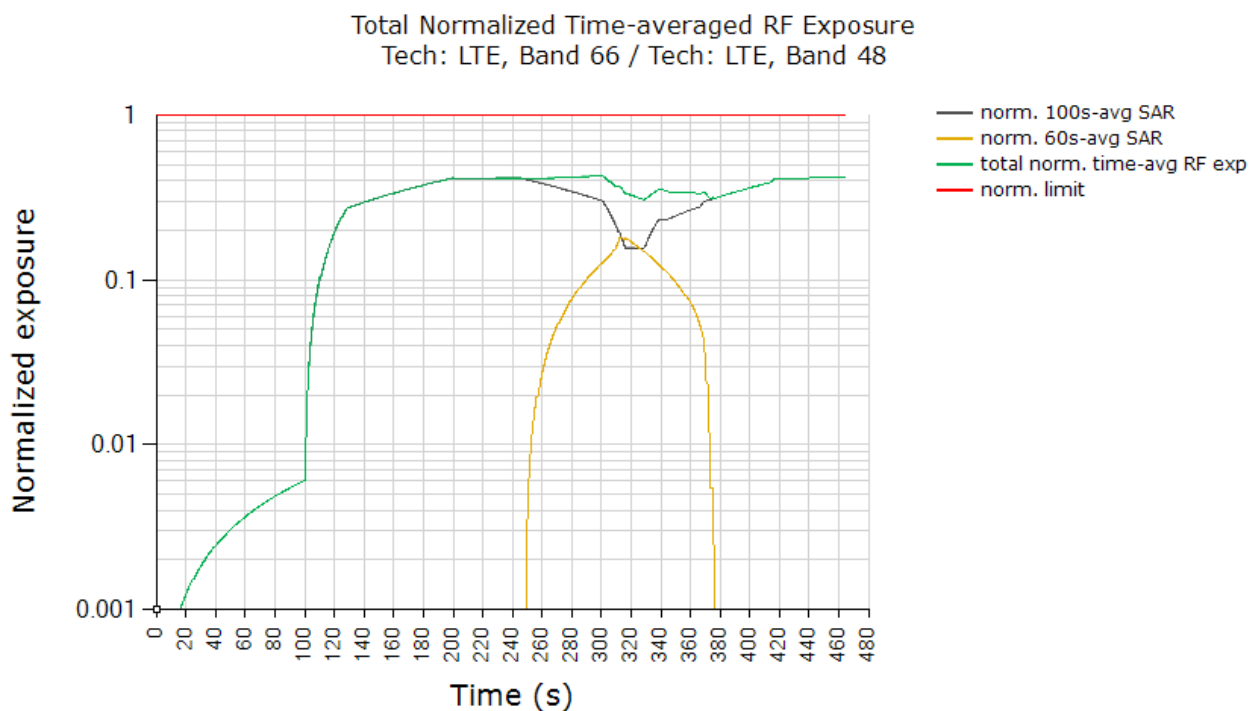

	(W/kg)
FCC normalized SAR Limit	1.0
Max 100 seconds-time averaged normalized 1-g SAR (green curve)	0.427
Validated	

The test result validated the continuity of power limiting in technology/band switch scenario.

## 6.8. Switch in SAR Exposure Test Results

### 6.8.1. Test Case 1: EN-DC Switch between LTE 66/4 and NR n25 (Test Case 13 in Table 5-2)

This test was conducted with the callbox requesting maximum power and with the EUT in LTE 66/4 + Sub-6 GHz NR Band n25 call. Following the procedure detailed in §3.3.7 and Appendix B.2, and using the measurement setup shown in Figure 6-1(a) and (c), since LTE and Sub-6 GHz NR are sharing the same antenna port (otherwise, it should be Figure 6-1(b) and (d) for different antenna ports), the SAR exposure switch measurement is performed with the EUT in various SAR exposure scenarios, i.e., in SAR<sub>Sub-6 GHz NR</sub> only scenario (t =0s ~120s), SAR<sub>Sub-6 GHz NR</sub> + SAR<sub>LTE</sub> scenario (t =120s ~ 240s) and SAR<sub>LTE</sub> only scenario (t > 240s)

All the conducted transmission power measurement results were converted into time-averaged normalized SAR values using Equation (7a), (7b) and (7c) and plotted below to demonstrate that the time-averaged normalized SAR versus time does not exceed the FCC limit of 1 unit. Equation (7a) is used to convert the LTE transmission power of the device to obtain the 100 seconds-averaged normalized SAR in LTE 66/4 as shown with the black curve. Similarly, equation (7b) is used to obtain the 100 seconds-averaged normalized SAR in Sub-6 GHz NR n25 as shown with the orange curve. Equation (7c) is used to obtain the total time-averaged normalized SAR as shown with the green curve (i.e., sum of both the black and orange curves).

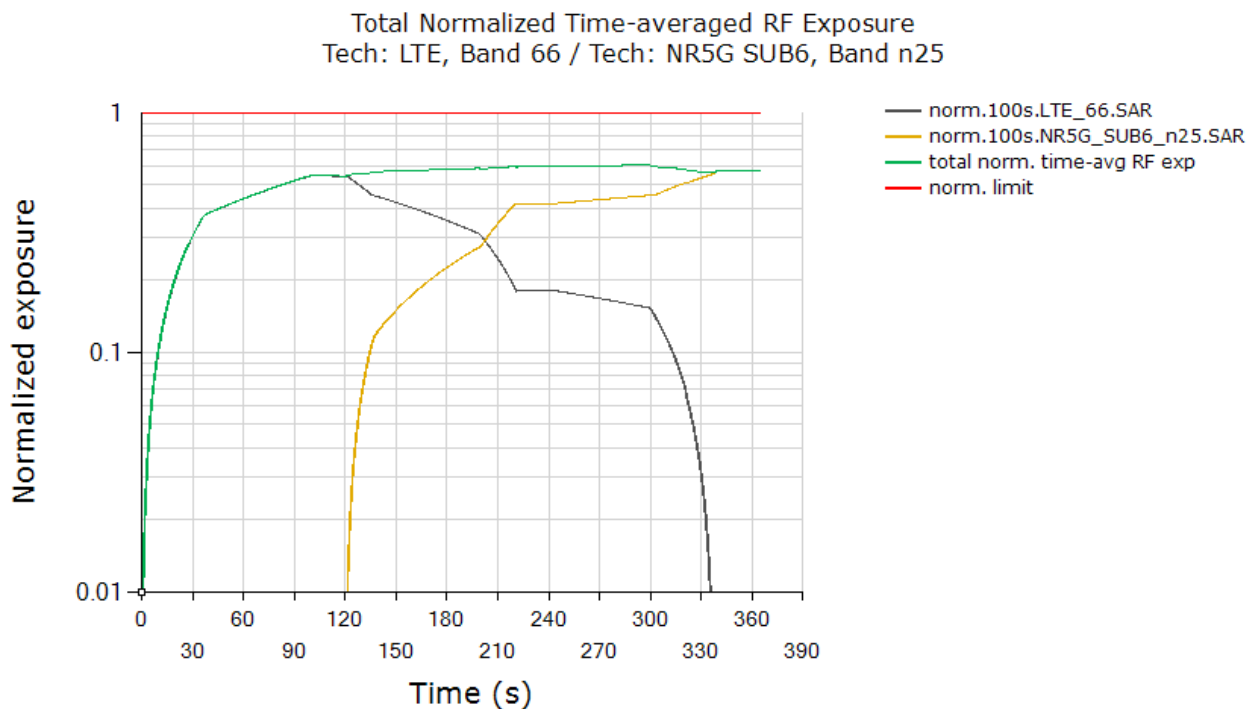

	(W/kg)
FCC normalized SAR Limit	1.0
Max 100 seconds-time averaged normalized 1-g SAR (green curve)	0.606
Validated	

The test result validated the continuity of power limiting in technology/band switch scenario.

### 6.8.2. Test Case 2: Uplink CA Switch between LTE 5 Antenna 1 and LTE 66/4 Antenna 4 (Test Case 14 in Table 5-2)

This test was conducted with the callbox requesting maximum power and with the EUT in an LTE Uplink Carrier Aggregation call in combination CA\_5A-66A. Following the procedure detailed in §3.3.7 and Appendix B.2, and using the measurement setup shown in Figure 6-1(a) and (c), since LTE and Sub-6 GHz NR are sharing the same antenna port (otherwise, it should be Figure 6-1(b) and (d) for different antenna ports), the SAR exposure switch measurement is performed with the EUT in various SAR exposure scenarios, i.e., in SAR<sub>Sub-6 GHz NR</sub> only scenario (t =0s ~120s), SAR<sub>Sub-6 GHz NR</sub> + SAR<sub>LTE</sub> scenario (t =120s ~ 240s) and SAR<sub>LTE</sub> only scenario (t > 240s)

All the conducted transmission power measurement results were converted into time-averaged normalized SAR values using Equation (7a), (7b) and (7c) and plotted below to demonstrate that the time-averaged normalized SAR versus time does not exceed the FCC limit of 1 unit. Equation (7a) is used to convert the LTE transmission power of the device to obtain the 100 seconds-averaged normalized SAR in LTE 5 as shown with the black curve. Similarly, equation (7b) is used to obtain the 100 seconds-averaged normalized SAR in LTE 66 as shown with the orange curve. Equation (7c) is used to obtain the total time-averaged normalized SAR as shown with the green curve (i.e., sum of both the black and orange curves).

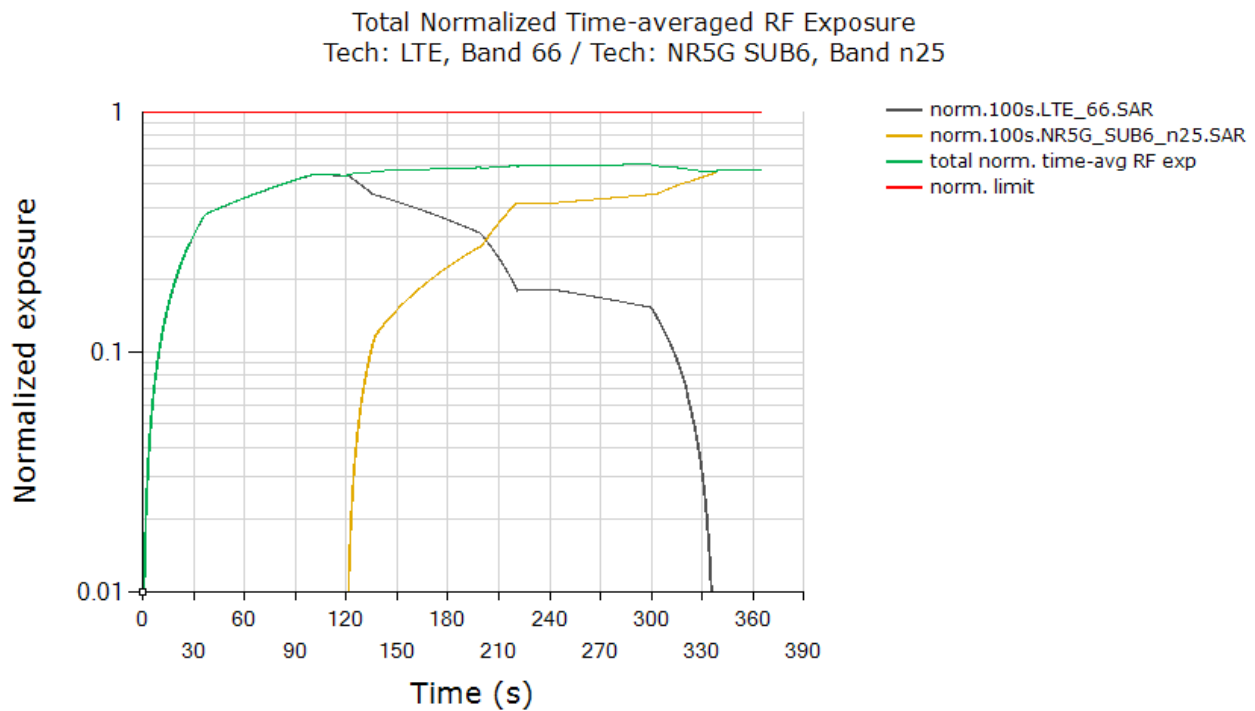

	(W/kg)
FCC normalized SAR Limit	1.0
Max 100 seconds-time averaged normalized 1-g SAR (green curve)	0.557
Validated	

The test result validated the continuity of power limiting in technology/band switch scenario.

## **7. SAR Test Results for Sub-6 GHz Smart Transmit Feature Validation**

Given the use of the same modem chipset as other models, test case reduction has been implemented per Qualcomm guidance. Measured SAR results shall be reused from reference model A2650 (FCC: BCG-E8140A).

## **8. Radiated Power Test Results for mmW Smart Transmit Feature Validation**

Given the use of the same modem chipset as other models, test case reduction has been implemented per Qualcomm guidance. Measured SAR results shall be reused from reference model A2650 (FCC: BCG-E8140A).

## **9. PD Test Results for mmW Smart Transmit Feature Validation**

Given the use of the same modem chipset as other models, test case reduction has been implemented per Qualcomm guidance. Measured SAR results shall be reused from reference model A2650 (FCC: BCG-E8140A).

## Appendices

### A Test Sequences

1. Test sequence is generated based on the following parameters of the EUT:
  - a. Measured maximum power ( $P_{max}$ )
  - b. Measured transmission power at SAR<sub>Design Target</sub> ( $P_{limit}$ )
  - c. Reserve\_power\_margin (dB)
    - i.  $P_{reserve}$  (dBm) = measured  $P_{limit}$  (dBm) - Reserve\_power\_margin (dB)
  - d. SAR time window (100 seconds for FCC)
2. Test Sequence 1 Waveform: Based on the parameters above, Test Sequence 1 is generated with one transition between high and low transmission powers. Here, high power =  $P_{max}$ ; low power =  $P_{max}/2$ , and the transition occurs after 80 seconds at high power ( $P_{max}$ ). If the power enforcement is taking into effective during one 100 seconds/60 seconds time window, the validation test with this defined Test Sequence 1 is valid; otherwise, select other radio configurations (band/DSI within the same technology group) having lower  $P_{limit}$  for this test. The Test Sequence 1 waveform is shown below:

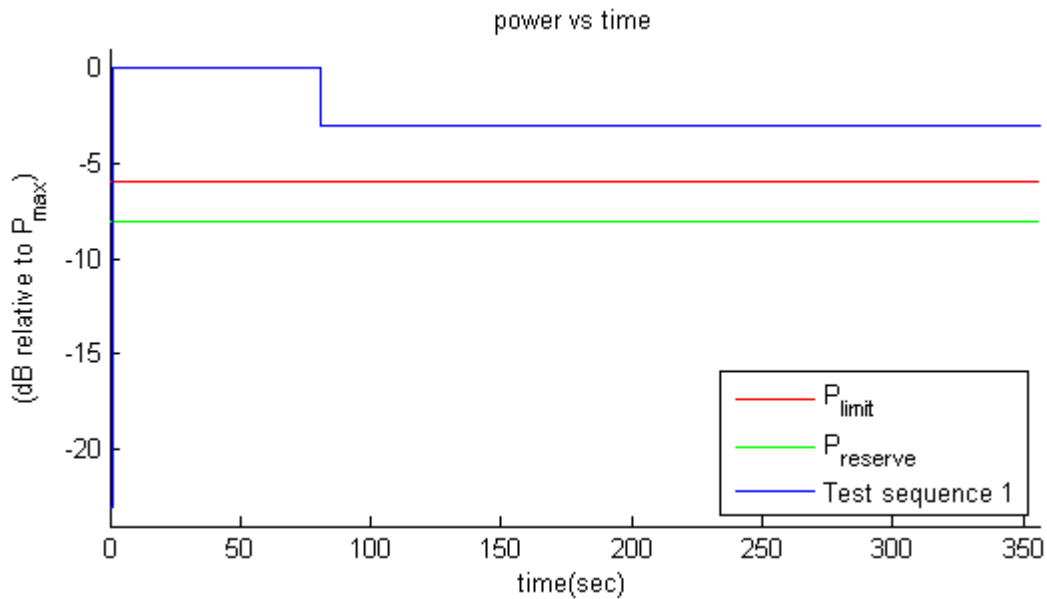

**Figure A-1: Test Sequence 1 waveform**

3. Test Sequence 2 Waveform: Based on the parameters in A-1, the Test Sequence 2 is generated as described in Table A-1 and pictured in Figure A-2, which contains two 170 seconds-long sequences (yellow and green highlighted rows) that are mirrored around the center row of 20 seconds, resulting in a total duration of 360 seconds:



**Table 9-1: Test Sequence 2**

Time duration (seconds)	dB relative to $P_{limit}$ or $P_{reserve}$
15	$P_{reserve} - 2$
20	$P_{limit}$
20	$(P_{limit} + P_{max})/2$ averaged in mW and rounded to nearest 0.1 dB step
10	$P_{reserve} - 6$
20	$P_{max}$
15	$P_{limit}$
15	$P_{reserve} - 5$
20	$P_{max}$
10	$P_{reserve} - 3$
15	$P_{limit}$
10	$P_{reserve} - 4$
20	$(P_{limit} + P_{max})/2$ averaged in mW and rounded to nearest 0.1 dB step
10	$P_{reserve} - 4$
15	$P_{limit}$
10	$P_{reserve} - 3$
20	$P_{max}$
15	$P_{reserve} - 5$
15	$P_{limit}$
20	$P_{max}$
10	$P_{reserve} - 6$
20	$(P_{limit} + P_{max})/2$ averaged in mW and rounded to nearest 0.1 dB step
20	$P_{limit}$
15	$P_{reserve} - 2$

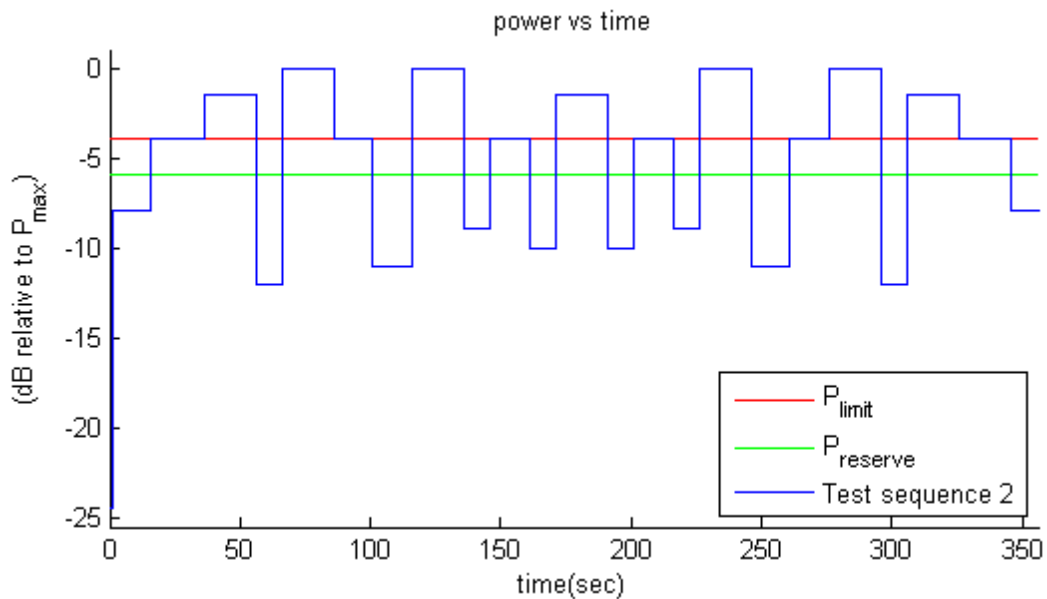

**Figure A-2: Test Sequence 2 waveform**

## B Test Procedures for Sub-6 GHz NR + Sub-6 GHz Radio

Appendix B provides the test procedures for validating the Smart Transmit feature for Sub-6 GHz + Sub-6 GHz NR non-standalone (NSA) mode transmission scenario, where Sub-6 GHz link acts as an anchor.

### B.1 Time-varying Transmission Power Test for Sub-6 GHz NR in NSA Mode

Following §3.2.1 to select the test configurations for time-varying tests, these tests are performed with two pre-defined test sequences (as described in §3.1) and applied to Sub-6 GHz NR (with Sub-6 GHz on all-down bits or low power for the entire test after establishing the Sub-6 GHz + Sub-6 GHz NR call with the callbox). Follow the test procedures described in §3.3.1 to demonstrate the effectiveness of power limiting enforcement and that the time averaged transmission power of Sub-6 GHz NR when converted into 1g SAR values do not exceed the regulatory limit (see Eq. (1a) and (1b)). Sub-6 GHz NR response to Test Sequence 1 and Test Sequence 2 will be similar to other technologies (say, LTE), and are shown in §6.3.7 and §6.3.8.

### B.2 Switch in SAR Exposure Between Sub-6 GHz vs. Sub-6 GHz NR during Transmission

This test is to demonstrate that the Smart Transmit feature accurately accounts for switching in exposures among SAR for Sub-6 GHz radio only, SAR from both Sub-6 GHz radio and Sub-6 GHz NR, and SAR from Sub-6 GHz NR only scenarios, and ensures total time-averaged RF exposure compliance with FCC limit.

#### Test Procedure:

1. Measure the conducted transmission power corresponding to  $P_{limit}$  for Sub-6 GHz and Sub-6 GHz NR in selected bands. Test conditions to measure conducted  $P_{limit}$  are:
  - a. Establish the device in a call with the callbox for Sub-6 GHz in a desired band. Measure the conducted transmission power corresponding to Sub-6 GHz  $P_{limit}$  with Smart Transmit enabled and *Reserve\_power\_margin* set to 0 dB, and the callbox set to request maximum power.
  - b. Repeat Step 1a to measure the conducted transmission power corresponding to Sub-6 GHz NR  $P_{limit}$ . If testing Sub-6 GHz + Sub-6 GHz NR in non-standalone mode (NSA), then establish a Sub-6 GHz + Sub-6 GHz NR call with the callbox and request all down bits for radio1 Sub-6 GHz. In this scenario, with the callbox requesting maximum power from the Sub-6 GHz NR radio, measure the conducted transmission power corresponding to radio2  $P_{limit}$  (as radio1 Sub-6 GHz is at all-down bits).
2. Set *Reserve\_power\_margin* to actual (intended) value with the EUT setup for Sub-6 GHz + Sub-6 GHz NR call. First, establish a Sub-6 GHz connection in all-up bits with the callbox and then a Sub-6 GHz NR connection is added with the callbox requesting the EUT to transmit at maximum power in Sub-6 GHz NR. When the Sub-6 GHz NR connection is established, request all-down bits on the Sub-6 GHz link (otherwise, Sub-6 GHz NR will not have sufficient RF exposure margin to sustain the call with Sub-6 GHz in all-up bits). Continue the Sub-6 GHz (all-down bits) + Sub-6 GHz NR transmission for more than one time-window duration to test, predominantly, the Sub-6 GHz NR SAR exposure scenario (as SAR exposure is negligible from all-down bits in Sub-6 GHz). After at least one time-window, request Sub-6 GHz to go all-up bits to test Sub-6 GHz SAR and Sub-6 GHz NR SAR exposure scenario. After at least one more time-window, drop (or request all-down bits) Sub-6 GHz NR transmission to test predominantly the Sub-6 GHz SAR exposure scenario. Continue the test for at least one more time-window. Record the conducted transmission powers for both Sub-6 GHz and Sub-6 GHz NR for the entire duration of this test.
3. Once the measurement is done, extract the instantaneous transmission power versus time for both Sub-6 GHz and Sub-6 GHz NR links. Like the technology/band switch test in §3.3.3, convert the conducted transmission power for both these radios into 1g SAR value (see Eq. (6a) and (6b)) using corresponding technology/band  $P_{limit}$  measured in Step 1 and then perform 100 seconds running average to determine time-averaged 1g SAR versus time as illustrated in Figure 3-1.<sup>16</sup>
4. Make one plot containing: (a) Instantaneous transmission power versus time measured in Step 2.
5. Make another plot containing: (a) Instantaneous 1g SAR versus time determined in Step 3, (b) computed time-averaged 1g SAR versus time determined in Step 3, and (c) corresponding regulatory 1g SAR<sub>limit</sub> of 1.6 W/kg. The validation criterion is the time-averaged 1g SAR versus time shall not exceed the regulatory 1g SAR<sub>limit</sub> of 1.6 W/kg.

<sup>16</sup> It is assumed both radios have transmission frequencies < 3 GHz; otherwise, 60 seconds running average should be performed for radios having transmission frequencies between 3 GHz and 6 GHz.

## **C Test Setup Photos**

End of Report