



TEST REPORT

Report Number: 14040863-E3V4

Applicant : APPLE, INC.
1 APPLE PARK WAY
CUPERTINO, CA 95014, U.S.A

Model : A2650 (Parent Model, Full Test)
A2889, A2890, A2891, A2892 (Variant Models)

FCC ID : BCG-E8140A (Parent Model)
BCG-E8150A, BCG-E8151A, BCG-E8152A (Variant Models)

IC : 579C-E8140A (Parent Model)
579C-E8150A, 579C-E8151A, 579C-E8152A (Variant Models)

EUT Description : SMARTPHONE

Test Standard(s) : FCC 47 CFR PART 15 SUBPART C
ISED RSS-247 ISSUE 2
ISED RSS-GEN ISSUE 5 + A1 + A2

Date Of Issue:
AUGUST 08, 2022

Prepared by:
UL LLC
47173 Benicia Street
Fremont, CA 94538 U.S.A.
TEL: (510) 319-4000
FAX: (510) 661-0888



REPORT REVISION HISTORY

Rev.	Issue Date	Revisions	Revised By
V1	6/22/2022	Initial Issue	Tony Li
V2	6/29/2022	Address TCB Questions	Francisco Guarnero
V3	7/8/2022	Address 2 nd level TCB's questions on section 5.4 and 9.4	Chin Pang
V4	8/8/2022	Addressed TCB question on section 10.2, updated vertical plots with proper labeling	Alejandro Martinez

TABLE OF CONTENTS

1. ATTESTATION OF TEST RESULTS	5
2. TEST SUMMARY	7
3. TEST METHODOLOGY	7
4. FACILITIES AND ACCREDITATION	7
5. DECISION RULES AND MEASUREMENT UNCERTAINTY	7
5.1. METROLOGICAL TRACEABILITY	7
5.2. DECISION RULES.....	8
5.3. MEASUREMENT UNCERTAINTY.....	8
5.4. SAMPLE CALCULATION	8
6. EQUIPMENT UNDER TEST.....	9
6.1. EUT DESCRIPTION.....	9
6.2. MAXIMUM OUTPUT POWER.....	9
6.3. DESCRIPTION OF AVAILABLE ANTENNAS.....	9
6.4. SOFTWARE AND FIRMWARE.....	10
6.5. WORST-CASE CONFIGURATION AND MODE.....	10
6.6. DESCRIPTION OF TEST SETUP.....	11
7. MEASUREMENT METHOD.....	14
8. TEST AND MEASUREMENT EQUIPMENT	15
9. ANTENNA PORT TEST RESULTS.....	16
9.1. ON TIME AND DUTY CYCLE.....	16
9.2. 99% BANDWIDTH.....	18
9.2.1. HIGH POWER HDR (HDR4).....	19
9.2.2. HIGH POWER HDR TXBF (HDR4).....	20
9.2.3. HIGH POWER HDR (HDR8).....	21
9.2.4. HIGH POWER HDR TXBF (HDR8).....	22
9.3. 6 dB BANDWIDTH.....	23
9.3.1. HIGH POWER HDR (HDR4).....	24
9.4. OUTPUT POWER.....	25
9.4.1. HIGH POWER HDR (HDR4).....	26
9.4.2. HIGH POWER HDR TXBF (HDR4).....	26
9.4.3. HIGH POWER HDR (HDR8).....	27
9.4.4. HIGH POWER HDR TXBF (HDR8).....	27
9.4.5. LOW POWER HDR (HDR4)	28
9.4.6. LOW POWER HDR TXBF (HDR4)	28
9.4.7. LOW POWER HDR (HDR8)	29
9.4.8. LOW POWER HDR TXBF (HDR8)	29

9.5. AVERAGE POWER	30
9.5.1. HIGH POWER HDR (HDR4).....	31
9.5.2. HIGH POWER HDR TXBF (HDR4).....	31
9.5.3. HIGH POWER HDR (HDR8).....	32
9.5.4. HIGH POWER HDR TXBF (HDR8).....	32
9.5.5. LOW POWER HDR (HDR4).....	33
9.5.6. LOW POWER HDR TXBF (HDR4).....	33
9.5.7. LOW POWER HDR (HDR8).....	34
9.5.8. LOW POWER HDR TXBF (HDR8).....	34
9.6. POWER SPECTRAL DENSITY	35
9.6.1. HIGH POWER HDR (HDR4).....	36
9.6.2. HIGH POWER HDR TXBF (HDR4).....	37
9.6.3. HIGH POWER HDR (HDR8).....	38
9.6.4. HIGH POWER HDR TXBF (HDR8).....	39
9.7. CONDUCTED SPURIOUS EMISSIONS	40
9.7.1. HIGH POWER HDR (HDR4).....	41
9.7.2. HIGH POWER HDR TXBF (HDR4).....	43
9.7.3. HIGH POWER HDR (HDR8).....	45
9.7.4. HIGH POWER HDR TXBF (HDR8).....	47
9.7.5. LOW POWER HDR (HDR4).....	49
9.7.6. LOW POWER HDR TXBF (HDR4).....	51
9.7.7. LOW POWER HDR (HDR8).....	53
9.7.8. LOW POWER HDR TXBF (HDR8).....	55
10. RADIATED TEST RESULTS	57
10.1. LIMITS AND PROCEDURE.....	57
10.2. TRANSMITTER ABOVE 1 GHz.....	59
10.2.1. HIGH POWER HDR (HDR4).....	59
10.2.2. HIGH POWER HDR TXBF (HDR4).....	67
10.2.3. HIGH POWER HDR (HDR8).....	71
10.2.4. HIGH POWER HDR TXBF (HDR8).....	79
10.2.5. HARMONICS AND SPURIOUS EMISSIONS.....	83
10.2.6. LOW POWER HDR (HDR4).....	89
10.2.7. LOW POWER HDR TXBF (HDR4).....	97
10.2.8. LOW POWER HDR (HDR8).....	101
10.2.9. LOW POWER HDR TXBF (HDR8).....	109
10.3. WORST CASE BELOW 1 GHz.....	113
10.4. WORST CASE 18-26 GHz.....	115
11. AC POWER LINE CONDUCTED EMISSIONS	117
11.1. AC Power Line With AC/DC Adapter.....	118
11.2. AC Power Line With Laptop.....	120
12. SETUP PHOTOS	122

1. ATTESTATION OF TEST RESULTS

COMPANY NAME: APPLE INC.
1 APPLE PARK WAY
CUPERTINO, CA 95014, U.S.A

EUT DESCRIPTION: SMARTPHONE

MODEL: A2650 (Parent Model)
A2889, A2890, A2891, A2892 (Variant Models)

BRAND: APPLE

FCC ID: BCG-E8140A (Parent Model)
BCG-E8150A, BCG-E8151A, BCG-E8152A (Variant Models)

IC: 579C-E8140A (Parent Model)
579C-E8150A, 579C-E8151A, 579C-E8152A (Variant Models)

SERIAL NUMBER: R9VD6JPQTY

SAMPLE RECEIPT DATE: MARCH 07, 2022

DATE TESTED: MARCH 10 -JUNE 29, 2022

APPLICABLE STANDARDS	
STANDARD	TEST RESULTS
CFR 47 Part 15 Subpart C	Complies
ISED RSS-247 Issue 2	Complies
ISED RSS-GEN Issue 5 + A1 + A2	Complies

UL LLC tested the above equipment in accordance with the requirements set forth in the above standards. The test results show that the equipment tested is capable of demonstrating compliance with the requirements as documented in this report.

The results documented in this report apply only to the tested sample, under the conditions and modes of operation as described herein. It is the manufacturer's responsibility to assure that additional production units of this model are manufactured with identical electrical and mechanical components. All samples tested were in good operating condition throughout the entire test program. Measurement Uncertainties are published for informational purposes only and were not taken into account unless noted otherwise.

This document may not be altered or revised in any way unless done so by UL LLC and all revisions are duly noted in the revisions section. Any alteration of this document not carried out by UL LLC will constitute fraud and shall nullify the document. This report must not be used by the client to claim product certification, approval, or endorsement by A2LA, NIST, any agency of the Federal Government, or any agency of the U.S. government.

Approved & Released For
UL LLC By:



Chin Pang
Senior Lab Engineer
Consumer Technology Division
UL LLC

Prepared By:



Tony Li
Test Engineer
Consumer Technology Division
UL LLC

2. TEST SUMMARY

This report contains data provided by the customer which can impact the validity of results. UL LLC is only responsible for the validity of results after the integration of the data provided by the customer

FCC Clause	ISED Clause	Requirement	Result	Comment
See Comment		Duty Cycle	Reporting purposes only	ANSI C63.10 Section 11.6.
	RSS-GEN 6.7	99% OBW	Reporting purposes only	ANSI C63.10 Section 6.9.3.
15.247 (a) (2)	RSS-247 5.2 (a)	6dB BW	complies	None.
15.247 (b) (3)	RSS-247 5.4 (d)	Output Power	complies	None.
See Comment		Average power	Reporting purposes only	Per ANSI C63.10, Section 11.9.2.3.2.
15.247 (e)	RSS-247 5.2 (b)	PSD	complies	None.
15.247 (d)	RSS-247 5.5	Conducted Spurious Emissions	complies	None.
15.209, 15.205	RSS-GEN 8.9, 8.10	Radiated Emissions	complies	None.
15.207	RSS-Gen 8.8	AC Mains Conducted Emissions	complies	None.

3. TEST METHODOLOGY

The tests documented in this report were performed in accordance with FCC CFR 47 Part 2, FCC CFR 47 Part 15, ANSI C63.10-2013, KDB 558074 D01 15.247 Meas Guidance v05r02, KDB 414788 D01 Radiated Test Site v01r01, KDB662911, RSS-GEN Issue 5 +A1 +A2, and RSS-247 Issue 2.

4. FACILITIES AND ACCREDITATION

UL LLC is accredited by A2LA, certification #0751.05, for all testing performed within the scope of this report. Testing was performed at the locations noted below.

Location	Address	ISED CABID	ISED Company Number	FCC Registration
<input type="checkbox"/>	Building 1: 47173 Benicia Street, Fremont, CA 94538, USA	US0104	2324A	550739
<input checked="" type="checkbox"/>	Building 2: 47266 Benicia Street, Fremont, CA 94538, USA	US0104	22541	550739
<input checked="" type="checkbox"/>	Building 4: 47658 Kato Rd, Fremont, CA 94538, USA	US0104	2324B	550739

5. DECISION RULES AND MEASUREMENT UNCERTAINTY

5.1. METROLOGICAL TRACEABILITY

All test and measuring equipment utilized to perform the tests documented in this report are calibrated on a regular basis, with a maximum time between calibrations of one year or the manufacturers' recommendation, whichever is less, and where applicable is traceable to recognized national standards.

5.2. DECISION RULES

The Decision Rule is based on Simple Acceptance in accordance with ISO Guide 98-4:2012 Clause 8.2. (Measurement uncertainty is not taken into account when stating conformity with a specified requirement.)

5.3. MEASUREMENT UNCERTAINTY

Where relevant, the following measurement uncertainty levels have been estimated for tests performed on the apparatus:

PARAMETER	U_{Lab}
Worst Case Conducted Disturbance, 9KHz to 0.15 MHz	3.78 dB
Worst Case Conducted Disturbance, 0.15 to 30 MHz	3.40 dB
Worst Case Radiated Disturbance, 9KHz to 30 MHz	2.87 dB
Worst Case Radiated Disturbance, 30 to 1000 MHz	6.01 dB
Worst Case Radiated Disturbance, 1000 to 18000 MHz	4.73 dB
Worst Case Radiated Disturbance, 18000 to 26000 MHz	4.51 dB
Worst Case Radiated Disturbance, 26000 to 40000 MHz	5.29 dB

Uncertainty figures are valid to a confidence level of 95%.

5.4. SAMPLE CALCULATION

RADIATED EMISSIONS

Where relevant, the following sample calculation is provided:

$$\begin{aligned} \text{Field Strength (dBuV/m)} &= \text{Measured Voltage (dBuV)} + \text{Antenna Factor (dB/m)} + \text{Cable} \\ &\text{Loss (dB)} - \text{Preamp Gain (dB)} \\ 36.5 \text{ dBuV} + 18.7 \text{ dB/m} + 0.6 \text{ dB} - 26.9 \text{ dB} &= 28.9 \text{ dBuV/m} \end{aligned}$$

MAINS CONDUCTED EMISSIONS

Where relevant, the following sample calculation is provided:

$$\begin{aligned} \text{Final Voltage (dBuV)} &= \text{Measured Voltage (dBuV)} + \text{Cable Loss (dB)} + \text{Limiter Factor (dB)} + \\ &\text{LISN Insertion Loss.} \\ 36.5 \text{ dBuV} + 0 \text{ dB} + 10.1 \text{ dB} + 0 \text{ dB} &= 46.6 \text{ dBuV} \end{aligned}$$

6. EQUIPMENT UNDER TEST

6.1. EUT DESCRIPTION

The Apple iPhone is a smartphone with multimedia functions (music, application support, and video), cellular GSM, GPRS, EGPRS, UMTS, LTE, 5G, IEEE 802.11a/b/g/n/ac/ax, Bluetooth, Ultra-Wideband, GPS, NFC and MSS. All models except reference model support at least one UICC based SIM. The second SIM is either an UICC based p-SIM (physical SIM) or e-SIM (electronic SIM). The device supports a built-in inductive charging transmitter and receiver. The rechargeable battery is not user accessible.

Testing was performed on the parent model and is used to support the application for the parent and variants identified in this report based on the test plan submitted and approved via KDB inquiry by the FCC and by ISED-Canada.

The Model and FCC IDs / ISED covered by this report includes:

Parent Model: A2650, FCC ID: BCG-E8140A, IC: 579C-E8140A

Variant Models: A2889, FCC ID: BCG-E8150A, IC: 579C-E8150A
 A2890; FCC ID: BCG-E8151A, IC: 579C-E8151A
 A2891 & A2892, FCC ID: BCG-E8152A, IC: 579C-E8152A

6.2. MAXIMUM OUTPUT POWER

The transmitter has a maximum peak conducted output power as follows:

Antenna	Configuration	Frequency Range (MHz)	Mode	Output Power (dBm)	Output Power (mW)
ANT 4	High Power	2404 - 2476	HDR4	14.62	28.97
	Low Power			9.15	8.22
	High Power		HDR8	15.55	35.89
	Low Power			9.93	9.84
ANT 3	High Power	2404 - 2476	HDR4	14.44	27.80
	Low Power			9.11	8.15
	High Power		HDR8	15.66	36.81
	Low Power			9.55	9.02
BF, ANT 4 + ANT 3	High Power	2404 - 2476	HDR4	17.41	55.08
	Low Power			12.02	15.92
	High Power		HDR8	18.36	68.55
	Low Power			12.79	19.01

6.3. DESCRIPTION OF AVAILABLE ANTENNAS

The antenna(s) gain and type, as provided by the manufacturer' are as follows:

Frequency Range (GHz)	ANT 4 (dBi)	ANT 3 (dBi)
2.4	-1.8	0.6

6.4. SOFTWARE AND FIRMWARE

The EUT firmware version installed during testing was 20.1.467.5699.

6.5. WORST-CASE CONFIGURATION AND MODE

The EUT was investigated in three orthogonal orientations X, Y and Z on ANT 4, ANT 3 and 2TX beamforming. It was determined that X (Flatbed) orientation was the worst-case orientation for ANT 3, beamforming 2TX and Z (Portrait) for ANT 4.

Radiated band edge, harmonic and spurious emissions from 1GHz to 18GHz were performed with the EUT set to transmit at highest power on Low/Middle/High channels.

High power HDR4 and HDR8 TXBF harmonic spurious 1-18GHz were investigated to determine the worst case and results showed HDR4 was the worst case. Therefore, High Power Beamforming HDR4 mode was set to maximum power based on SISO to cover both SISO and MIMO modes to comply with radiated spurious emissions limits in the restricted bands between 1GHz and 18GHz low/mid/high channel (except the band edge).

Radiated emissions below 30MHz, below 1GHz, 18-26GHz and power line conducted emissions were performed with the EUT transmits at the channel with the highest output power as worst-case scenario. There were no emissions found below 30MHz within 20dB of the limit.

For below 1GHz tests were performed with EUT connected to AC power adapter as the worst case; and for above 1GHz, the worst-case configuration reported was tested with EUT only. For AC line conducted emission, test was investigated with AC power adapter and with laptop.

There are three vendors of the Wi-Fi/Bluetooth radio modules: variant 1, 2 and 3.. The WiFi/BT radio modules have the same mechanical outline (e.g., the same package dimension and pin-out layout), use the same on-board antenna matching circuit, have an identical antenna structure, and are built and tested to conform to the same specifications and to operate within the same tolerances.

Baseline testing was performed on the three variants to determine the worst case on all conducted power and radiated emissions.

6.6. DESCRIPTION OF TEST SETUP

SUPPORT TEST EQUIPMENT						
Description	Manufacturer	Model	Serial Number	FCC ID/ DoC		
Laptop	Apple	Macbook Pro	C02VD7SAHV22	BCGA1708		
Laptop AC/DC adapter	Liteon Technology	A1424	NSW25679	DoC		
EUT AC/DC adapter	Apple	A1720	C3D8417A7R93KVPA8	DoC		
I/O CABLES (RF CONDUCTED TEST)						
Cable No.	Port	# of Identical Ports	Connector Type	Cable Type	Cable Length (m)	Remarks
1	Antenna	1	SMA	Un-shielded	0.2	To spectrum Analyzer
2	USB	1	USB	Shielded	1.0	N/A
3	AC	1	AC	Un-shielded	2	N/A
I/O CABLES (RF RADIATED AND AC LINE CONDUCTED TEST)						
Cable No.	Port	# of Identical Ports	Connector Type	Cable Type	Cable Length (m)	Remarks
1	AC	1	AC	Un-shielded	2	N/A
2	USB	1	USB	shielded	1	N/A

TEST SETUP

The EUT setup is shown as below. Test software exercised the radio card.

SETUP DIAGRAM FOR CONDUCTED TESTS

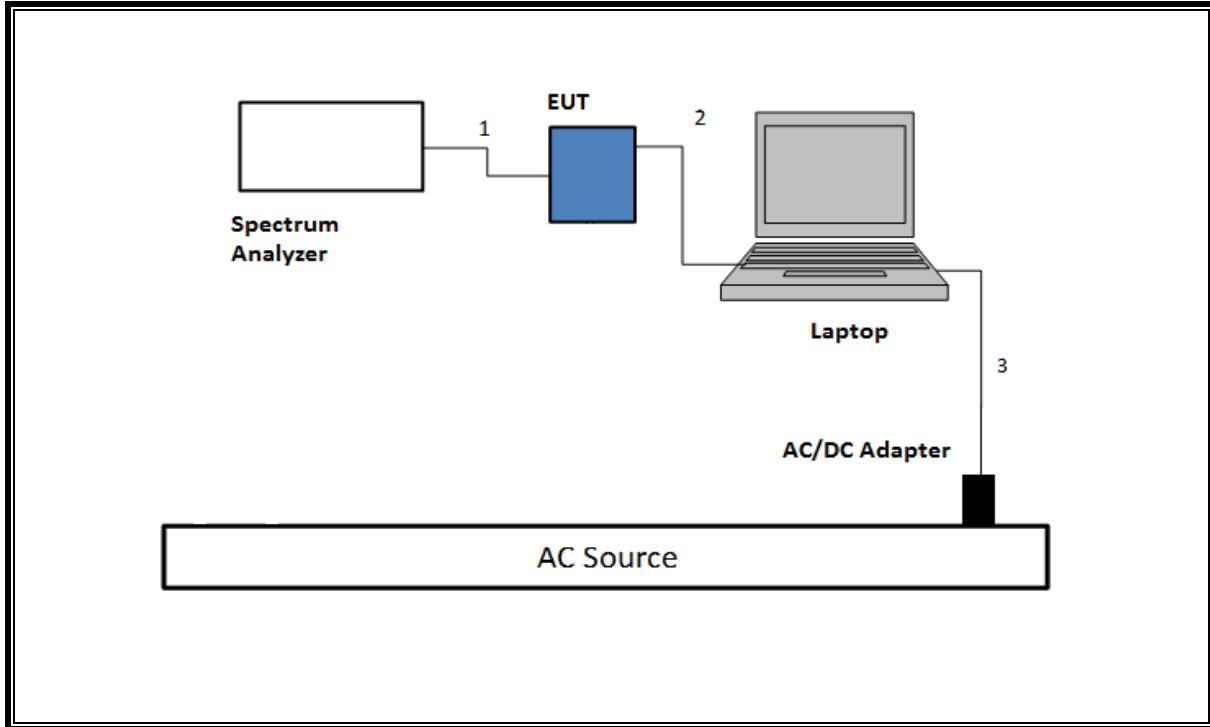

SETUP DIAGRAM FOR RADIATED TESTS Above 1 GHz

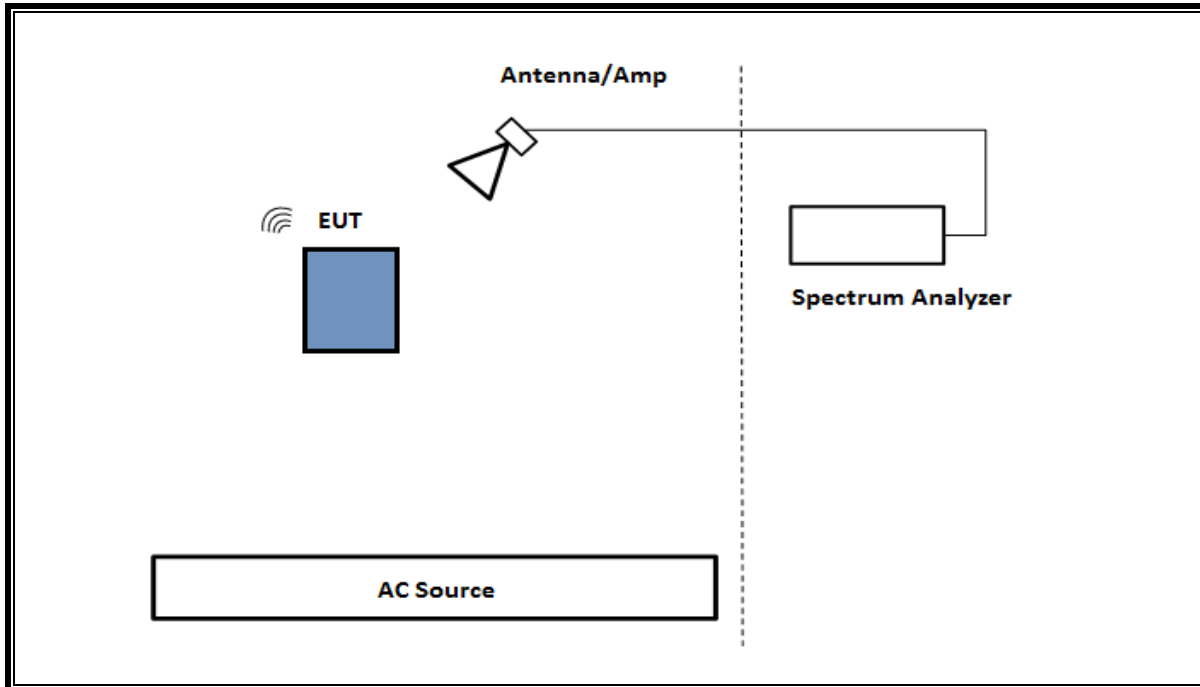

SETUP DIAGRAM FOR Below 1GHz and AC LINE CONDUCTED TEST

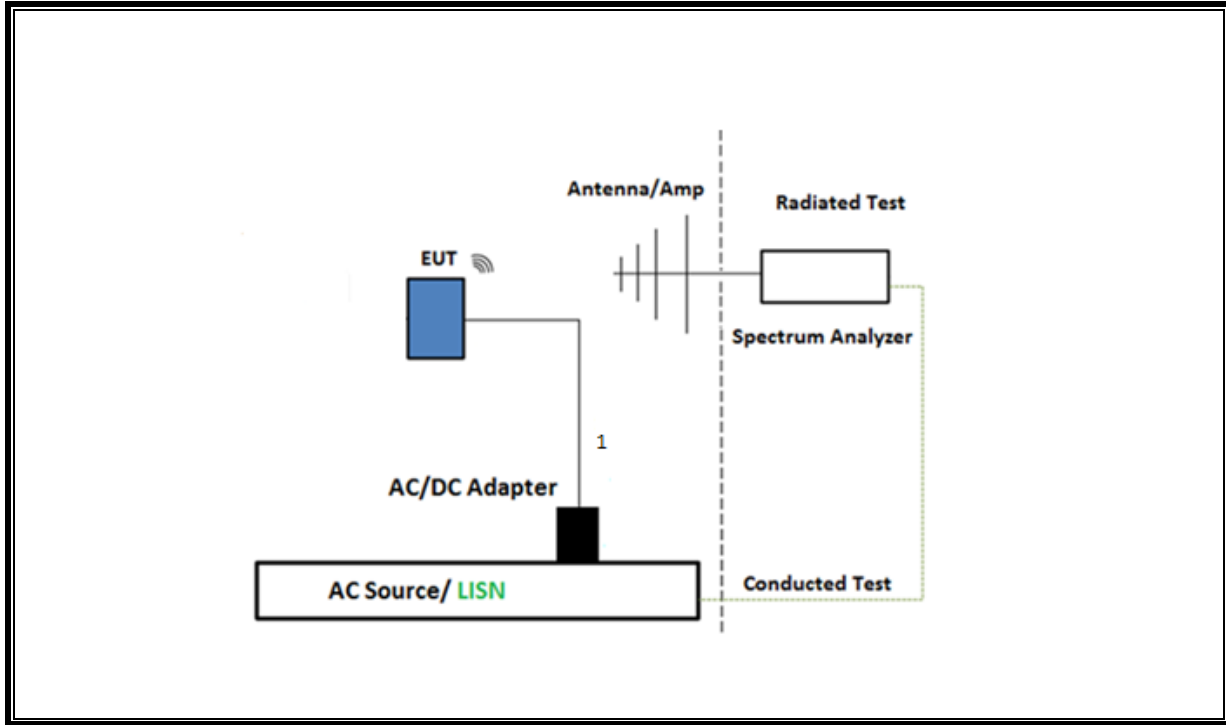

TEST SETUP- AC LINE CONDUCTED: LAPTOP CONFIGURATION

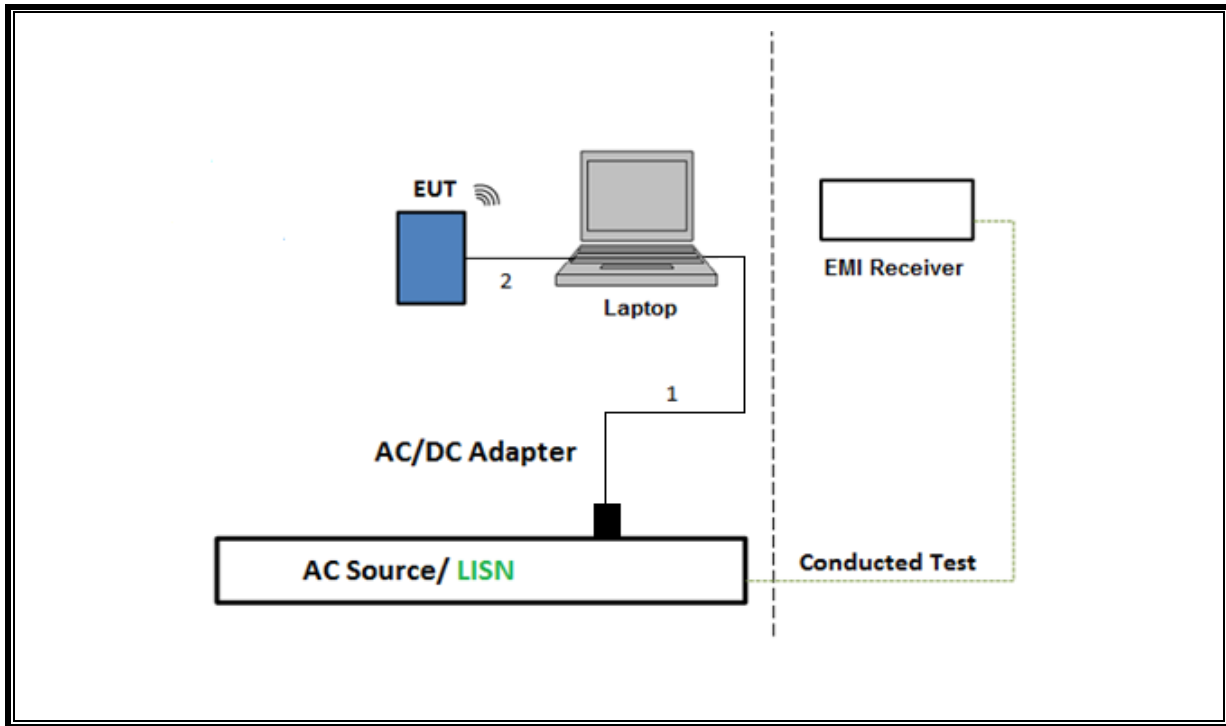

7. MEASUREMENT METHOD

On Time and Duty Cycle: KDB 558074 D01 v05r02, Section 6.

6 dB BW: ANSI C63.10 Subclause -11.8.1 RBW \geq DTS BW

Occupied BW (99%): ANSI C63.10-2013 Section 6.9.3

Output Power: ANSI C63.10 Subclause -11.9.1.3 Method PKPM1 Peak-reading power meter

Output Power: ANSI C63.10 Subclause -11.9.2.3.2 Measurement using gated average power meter.

PSD: ANSI C63.10 Subclause -11.10.2 Method PKPSD (peak PSD)

Radiated emissions restricted frequency bands: ANSI C63.10 Subclause -11.12.1 & Clause 13

Conducted emissions in restricted frequency bands: ANSI C63.10 Subclause -11.12.2

Band-edge: ANSI C63.10 Subclause -11.13.3.2 & Clause 13: Integration method -Peak detection

Band-edge: ANSI C63.10 Subclause -11.13.3.3 & Clause 13: Integration method -Trace averaging with continuous transmission at full power

AC Power Line Conducted Emissions: ANSI C63.10-2013, Section 6.2.

Radiated emissions non-restricted frequency bands ANSI C63.10 Subclause – 11.11 & Clause 13

Radiated Spurious Emissions Below 30MHz: ANSI C63.10-2013 Section 6.4 & 13

NOTE: All conducted antenna port tests for Beamforming applied the same test procedures as HDR normal modes.

8. TEST AND MEASUREMENT EQUIPMENT

The following test and measurement equipment was utilized for the tests documented in this report:

Description	Manufacturer	Model	ID Num	Cal Due	Last Cal
EMI Test Receiver	Rohde & Schwarz	ESW44	191429	02/20/2023	02/20/2022
Antenna, Horn 1-18GHz	ETS-Lindgren	3117	81887	03/16/2023	03/16/2022
RF Filter Box	UL-FR1	NA	PRE0183207	10/23/2022	10/23/2021
Amplifier, 9KHz to 1GHz, 32dB	SONOMA INSTRUMENT	310	202989	12/29/2022	12/29/2021
Antenna, Broadband Hybrid, 30MHz to 2000MHz	Sunol Sciences	JB3	174373	12/14/2022	12/14/2021
*Antenna Horn 18 to 26.5GHz	ARA	MWH-1826/B	81140	04/22/2022	04/22/2021
Amplifier 18-26.5GHz, +5Vdc, 60dB min	AMPLICAL	AMP18G26.5-60	215705	02/26/2023	02/26/2022
Power Meter, P-series single channel	Keysight	N1911A	T1244	01/24/2023	01/24/2022
Power Sensor	Keysight	N1921A	90419	02/03/2023	02/03/2022
*Antenna, Horn 1-18GHz	ETS Lindgren	3117	T120	04/07/2022	04/07/2021
RF Filter Box 1-18GHz	UL-FR	NA	171389	11/01/2022	11/01/2021
Spectrum Analyzer, PXA 3Hz to 44GHz	Keysight	N9030A	125179	02/01/2023	02/01/2022
RF Filter Box	UL-FR1	NA	173233	10/23/2022	10/23/2021
Antenna, Horn 1-18GHz	ETS Lindgren	3117	200785	10/13/2022	10/13/2021
RF filter Box 1-18GHz	UL-FR1	SAC 6 port rf box	207182	02/11/2023	02/11/2022
EMI Receiver	Rohde & Schwarz	ESW44	201499	02/20/2023	02/20/2022
Antenna, Active Loop 9KHz to 30MHz	ETS-Lindgren	6502	T757	01/28/2023	01/28/2022
Antenna	ETS-Lindgren	3117	200897	02/24/2023	02/24/2022
*RF Filter Box	UL-FR1	N/A	PRE0182865	03/30/2022	03/30/2021

AC Line Conducted					
Description	Manufacturer	Model	ID Num	Cal Due	Last Cal
EMI Test Receiver 9kHz-7GHz	Rohde & Schwarz	ESR	T1436	02/21/2023	02/21/2022
Power Cable, Line Conducted Emissions	UL	PR1	T861	10/27/2022	10/27/2021
LISN for Conducted Emissions CISPR-16	FISCHER CUSTOM COMMUNICATIONS	FCC-LISN-50/250-25-2-01-480V	175765	01/26/2023	01/26/2022
UL AUTOMATION SOFTWARE					
Radiated Software	UL	UL EMC	Ver 9.5, Mar 6, 2020		
Conducted Software	UL	UL EMC	2020.2.26		
AC Line Conducted Software	UL	UL EMC	Ver 9.5, February 21, 2020		

*Testing is completed before equipment expiration date.

9. ANTENNA PORT TEST RESULTS

9.1. ON TIME AND DUTY CYCLE

LIMITS

None; for reporting purposes only.

PROCEDURE

KDB 558074 Zero-Span Spectrum Analyzer Method.

ON TIME AND DUTY CYCLE RESULTS

Mode	ON Time B (msec)	Period (msec)	Duty Cycle x (linear)	Duty Cycle (%)	Duty Cycle Correction Factor (dB)	1/B Minimum VBW (kHz)
2.4GHz Band						
HDR4	0.4	0.4	1.000	100.00%	0.00	0.010
HDR8	0.4	0.4	1.000	100.00%	0.00	0.010
HDR4, TXBF	0.4	0.4	1.000	100.00%	0.00	0.010
HDR8, TXBF	1.929	1.929	1.000	100.00%	0.00	0.010

DUTY CYCLE PLOTS

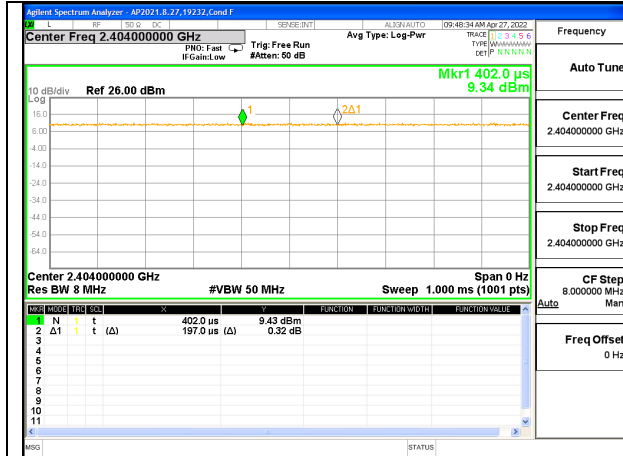

DUTY CYCLE HDR4

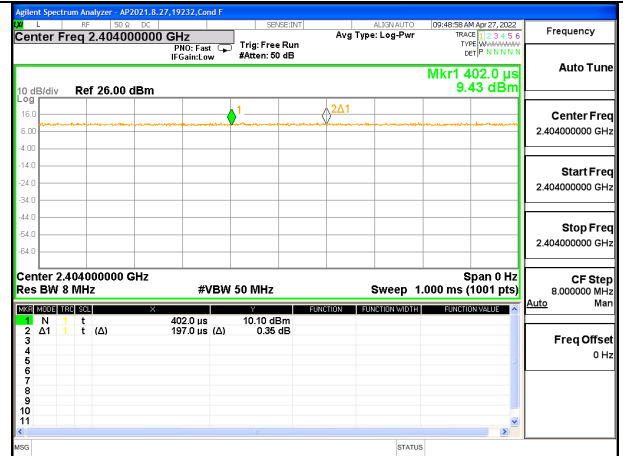

DUTY CYCLE HDR8

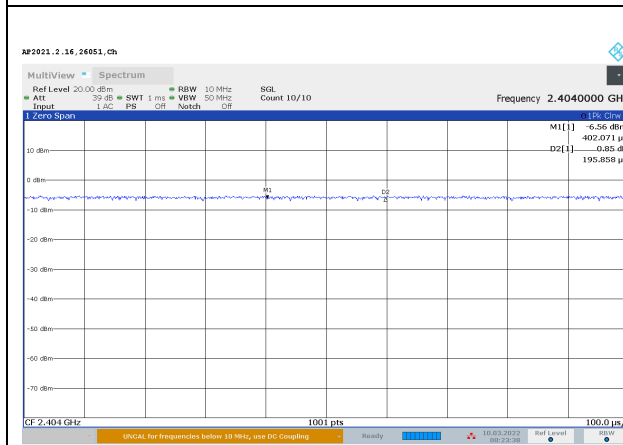

DUTY CYCLE HDR4 TXBF

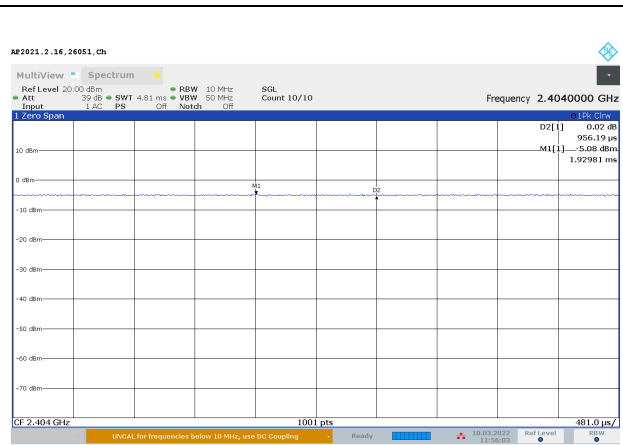

DUTY CYCLE HDR8 TXBF

9.2. 99% BANDWIDTH

LIMITS

None; for reporting purposes only.

RESULTS

Only High Power modes result is reported, it covers all Low Power modes. Only Mid channel plot is reported to show setting parameter complies with testing method/procedure.

9.2.1. HIGH POWER HDR (HDR4)

ANT 4

Channel	Frequency (MHz)	99% Bandwidth (MHz)
Low	2404	2.312
Middle	2440	2.333
High	2476	2.363

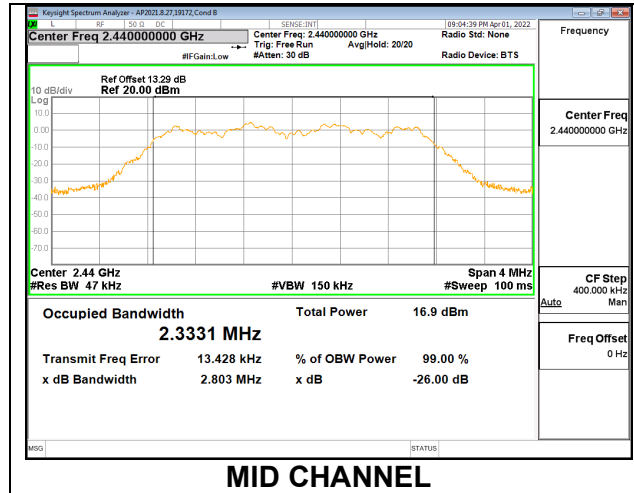

ANT 3

Channel	Frequency (MHz)	99% Bandwidth (MHz)
Low	2404	2.313
Middle	2440	2.315
High	2476	2.314

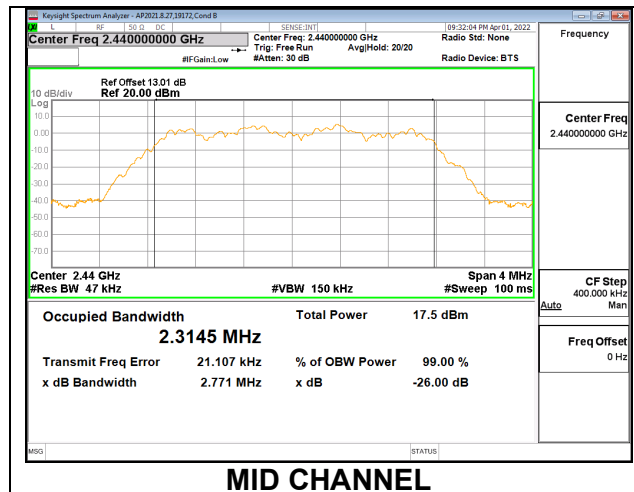

9.2.2. HIGH POWER HDR TXBF (HDR4)

Channel	Frequency (MHz)	99% Bandwidth ANT 4 (MHz)	99% Bandwidth ANT 3 (MHz)
Low	2404	2.312	2.313
Middle	2440	2.313	2.314
High	2476	2.315	2.313

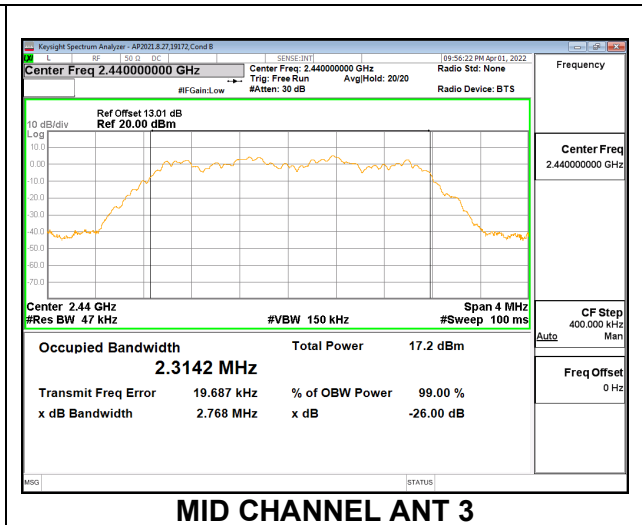
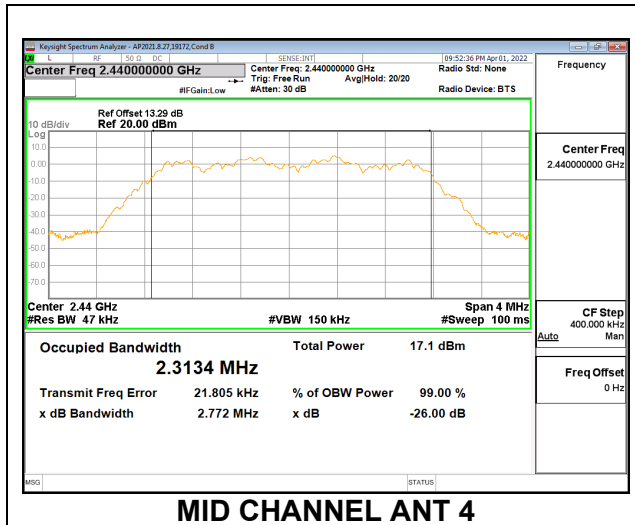

9.2.4. HIGH POWER HDR TXBF (HDR8)

Channel	Frequency (MHz)	99% Bandwidth ANT 4 (MHz)	99% Bandwidth ANT 3 (MHz)
Low	2404	4.725	4.647
Middle	2440	4.659	4.652
High	2476	4.653	4.657

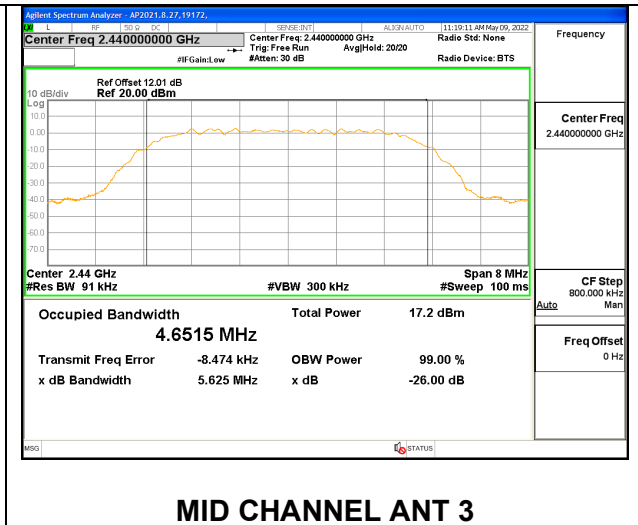
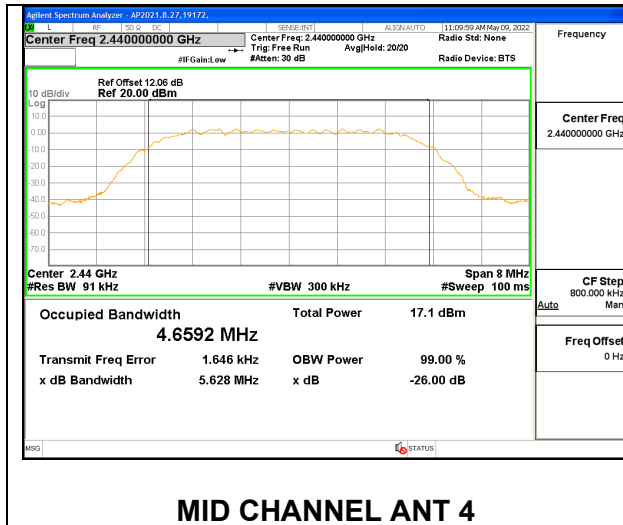

9.3. 6 dB BANDWIDTH

LIMITS

FCC §15.407 (e)

RSS-247 5.2 (a)

The minimum 6 dB bandwidth shall be at least 500 kHz.

RESULTS

The 6dB bandwidth was measured for the narrowest bandwidth mode, HDR4, to demonstrate compliance with the minimum required bandwidth of 500 kHz. Other modes were not tested as their bandwidth is greater than the HDR4 mode, as demonstrated by the 99% bandwidth measurements performed on all modes.

Only Mid channel plot is reported to show setting parameter complies with testing method/procedure.

Only High Power modes result is reported, it covers all Low Power modes.

9.3.1. HIGH POWER HDR (HDR4)

ANT 4

Channel	Frequency (MHz)	6 dB Bandwidth (MHz)	Minimum Limit (MHz)
Low	2404	2.080	0.5
Middle	2440	2.072	0.5
High	2476	2.084	0.5

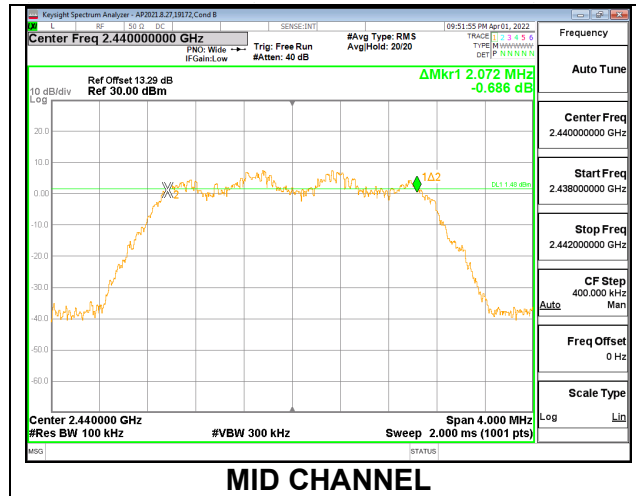

ANT 3

Channel	Frequency (MHz)	6 dB Bandwidth (MHz)	Minimum Limit (MHz)
Low	2404	2.100	0.5
Middle	2440	2.092	0.5
High	2476	2.116	0.5

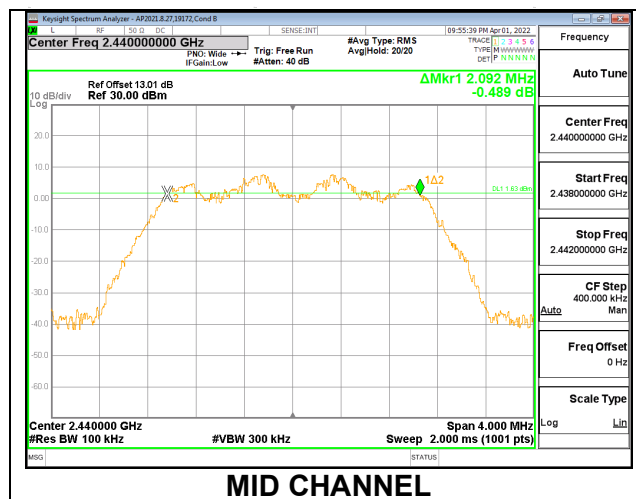

9.4. OUTPUT POWER

LIMITS

FCC §15.247 (b) (3)

RSS-247 5.4 (d)

The maximum antenna gain is less than or equal to 6 dBi, therefore the limit is 30 dBm.

TEST PROCEDURE

The power output was measured on the EUT antenna port using SMA cable with 10dB attenuator connected to a power meter via wideband peak power sensor. Peak output power was read directly from power meter.

DIRECTIONAL ANTENNA GAIN

For 1 TX:

There is only one transmitter output therefore the directional gain is equal to the antenna gain.

For 2 TX:

Tx chains are correlated for power and PSD due to the device supporting Beamforming mode. The directional gains are as follows:

Band (GHz)	ANT 4 Gain (dBi)	ANT 3 Gain (dBi)	Correlated Chains Directional Gain (dBi)
2.4	-1.80	0.60	2.49

Directional Gain Calculation:

ANSI C63.10-2013 section 14.4.3

Uncorrelated directional gain= $10 \cdot \text{LOG}((10^{(\text{Ant1}/10)} + 10^{(\text{Ant2}/10)})/2)$

Correlated directional Gain= $10 \cdot \text{LOG}(((10^{(\text{Ant1}/20)} + 10^{(\text{Ant2}/20)})^2)/2)$

Sample Calculation:

Ant1=-1.80, Ant2=0.6

Uncorrelated Antenna gain= $10 \log[(10^{(-1.8/10)} + 10^{(0.6/10)})/2] = -0.44 \text{dBi}$

Correlated Antenna gain= $10 \log[(10^{(-1.8/20)} + 10^{(0.6/20)})^2/2] = 2.49$

RESULTS

9.4.1. HIGH POWER HDR (HDR4)

ANT 4

Tested By:	50820
Date:	6/6/2022

Channel	Frequency (MHz)	Peak Power Reading (dBm)	Limit (dBm)	Margin (dB)
Low	2404	14.52	30	-15.48
Middle	2440	14.62	30	-15.38
High	2476	14.40	30	-15.60

ANT 3

Tested By:	50820
Date:	6/6/2022

Channel	Frequency (MHz)	Peak Power Reading (dBm)	Limit (dBm)	Margin (dB)
Low	2404	14.39	30	-15.61
Middle	2440	14.42	30	-15.58
High	2476	14.44	30	-15.56

9.4.2. HIGH POWER HDR TXBF (HDR4)

Tested By:	50820
Date:	6/6/2022

Channel	Frequency (MHz)	Peak Power Reading ANT 4 (dBm)	Peak Power Reading ANT 3 (dBm)	Total Corr'd Power (dBm)	Limit (dBm)	Margin (dB)
Low	2404	14.46	14.12	17.30	30.00	-12.70
Middle	2440	14.39	14.30	17.36	30.00	-12.64
High	2476	14.38	14.42	17.41	30.00	-12.59

9.4.3. HIGH POWER HDR (HDR8)**ANT 4**

Tested By:	50820
Date:	6/6/2022

Channel	Frequency (MHz)	Peak Power Reading (dBm)	Limit (dBm)	Margin (dB)
Low	2404	15.40	30	-14.60
Middle	2440	15.55	30	-14.45
High	2476	15.48	30	-14.52

ANT 3

Tested By:	50820
Date:	6/6/2022

Channel	Frequency (MHz)	Peak Power Reading (dBm)	Limit (dBm)	Margin (dB)
Low	2404	15.54	30	-14.46
Middle	2440	15.66	30	-14.34
High	2476	15.59	30	-14.41

9.4.4. HIGH POWER HDR TXBF (HDR8)

Tested By:	50820
Date:	6/6/2022

Channel	Frequency (MHz)	Peak Power Reading ANT 4 (dBm)	Peak Power Reading ANT 3 (dBm)	Total Corr'd Power (dBm)	Limit (dBm)	Margin (dB)
Low	2404	15.18	15.25	18.23	30.00	-11.77
Middle	2440	15.35	15.34	18.36	30.00	-11.64
High	2476	15.26	15.33	18.31	30.00	-11.69

9.4.5. LOW POWER HDR (HDR4)**ANT 4**

Tested By:	50820
Date:	6/6/2022

Channel	Frequency (MHz)	Peak Power Reading (dBm)	Limit (dBm)	Margin (dB)
Low	2404	9.13	30	-20.87
Middle	2440	9.15	30	-20.85
High	2476	9.09	30	-20.91

ANT 3

Tested By:	50820
Date:	6/6/2022

Channel	Frequency (MHz)	Peak Power Reading (dBm)	Limit (dBm)	Margin (dB)
Low	2404	9.08	30	-20.92
Middle	2440	9.09	30	-20.91
High	2476	9.11	30	-20.89

9.4.6. LOW POWER HDR TXBF (HDR4)

Tested By:	50820
Date:	6/6/2022

Channel	Frequency (MHz)	Peak Power Reading ANT 4 (dBm)	Peak Power Reading ANT 3 (dBm)	Total Corr'd Power (dBm)	Limit (dBm)	Margin (dB)
Low	2404	9.00	9.00	12.01	30.00	-17.99
Middle	2440	9.02	9.00	12.02	30.00	-17.98
High	2476	8.85	8.87	11.87	30.00	-18.13

9.4.7. LOW POWER HDR (HDR8)

ANT 4

Tested By:	50820
Date:	6/6/2022

Channel	Frequency (MHz)	Peak Power Reading (dBm)	Limit (dBm)	Margin (dB)
Low	2404	9.90	30	-20.10
Middle	2440	9.93	30	-20.07
High	2476	9.87	30	-20.13

ANT 3

Tested By:	50820
Date:	6/6/2022

Channel	Frequency (MHz)	Peak Power Reading (dBm)	Limit (dBm)	Margin (dB)
Low	2404	9.51	30	-20.49
Middle	2440	9.55	30	-20.45
High	2476	9.54	30	-20.46

9.4.8. LOW POWER HDR TXBF (HDR8)

Tested By:	50820
Date:	6/6/2022

Channel	Frequency (MHz)	Peak Power Reading ANT 4 (dBm)	Peak Power Reading ANT 3 (dBm)	Total Corr'd Power (dBm)	Limit (dBm)	Margin (dB)
Low	2404	9.73	9.75	12.75	30.00	-17.25
Middle	2440	9.76	9.78	12.78	30.00	-17.22
High	2476	9.75	9.80	12.79	30.00	-17.21

9.5. AVERAGE POWER

LIMITS

None; for reporting purposes only.

TEST PROCEDURE

The power output was measured on the EUT antenna port using SMA cable with 10dB attenuator connected to a power meter via wideband average power sensor. Gated average output power was read directly from power meter.

RESULTS

9.5.1. HIGH POWER HDR (HDR4)

ANT 4

Tested By:	50820
Date:	6/6/2022

Channel	Frequency (MHz)	Average power (dBm)
Low	2404	12.41
Middle	2440	12.47
High	2476	12.43

ANT 3

Tested By:	50820
Date:	6/6/2022

Channel	Frequency (MHz)	Average power (dBm)
Low	2404	12.39
Middle	2440	12.44
High	2476	12.45

9.5.2. HIGH POWER HDR TXBF (HDR4)

Tested By:	50820
Date:	6/6/2022

Channel	Frequency (MHz)	Average Power ANT 4 (dBm)	Average Power ANT 3 (dBm)	Total Power (dBm)
Low	2404	12.45	12.21	15.34
Middle	2440	12.42	12.30	15.37
High	2476	12.43	12.45	15.45

9.5.3. HIGH POWER HDR (HDR8)

ANT 4

Tested By:	50820
Date:	6/6/2022

Channel	Frequency (MHz)	Average power (dBm)
Low	2404	13.27
Middle	2440	13.46
High	2476	13.35

ANT 3

Tested By:	50820
Date:	6/6/2022

Channel	Frequency (MHz)	Average power (dBm)
Low	2404	13.31
Middle	2440	13.45
High	2476	13.37

9.5.4. HIGH POWER HDR TXBF (HDR8)

Tested By:	50820
Date:	6/6/2022

Channel	Frequency (MHz)	Average Power ANT 4 (dBm)	Average Power ANT 3 (dBm)	Total Power (dBm)
Low	2404	13.25	13.31	16.29
Middle	2440	13.45	13.43	16.45
High	2476	13.32	13.43	16.39

9.5.5. LOW POWER HDR (HDR4)

ANT 4

Tested By:	50820
Date:	6/6/2022

Channel	Frequency (MHz)	Average power (dBm)
Low	2404	6.92
Middle	2440	6.94
High	2476	6.88

ANT 3

Tested By:	50820
Date:	6/6/2022

Channel	Frequency (MHz)	Average power (dBm)
Low	2404	6.85
Middle	2440	6.95
High	2476	6.96

9.5.6. LOW POWER HDR TXBF (HDR4)

Tested By:	50820
Date:	6/6/2022

Channel	Frequency (MHz)	Average Power ANT 4 (dBm)	Average Power ANT 3 (dBm)	Total Power (dBm)
Low	2404	6.94	6.93	9.95
Middle	2440	6.95	6.93	9.95
High	2476	6.82	6.85	9.85

9.5.7. LOW POWER HDR (HDR8)

ANT 4

Tested By:	50820
Date:	6/6/2022

Channel	Frequency (MHz)	Average power (dBm)
Low	2404	7.43
Middle	2440	7.45
High	2476	7.40

ANT 3

Tested By:	50820
Date:	4/26/2022

Channel	Frequency (MHz)	Average power (dBm)
Low	2404	7.42
Middle	2440	7.45
High	2476	7.44

9.5.8. LOW POWER HDR TXBF (HDR8)

Tested By:	50820
Date:	6/6/2022

Channel	Frequency (MHz)	Average Power ANT 4 (dBm)	Average Power ANT 3 (dBm)	Total Power (dBm)
Low	2404	7.43	7.45	10.45
Middle	2440	7.45	7.47	10.47
High	2476	7.44	7.48	10.47

9.6. POWER SPECTRAL DENSITY

LIMITS

FCC §15.247 (e)

RSS-247 (5.2) (b)

The power spectral density conducted from the transmitter to the antenna shall not be greater than 8 dBm in any 3 kHz band during any time interval of continuous transmission.

RESULTS

Only High-Power modes result is reported, it covers all Low Power modes

9.6.1. HIGH POWER HDR (HDR4)

ANT 4

Channel	Frequency (MHz)	PSD (dBm/3kHz)	Limit (dBm/3kHz)	Margin (dB)
Low	2404	-4.044	8	-12.04
Middle	2440	-3.992	8	-11.99
High	2476	-3.840	8	-11.84

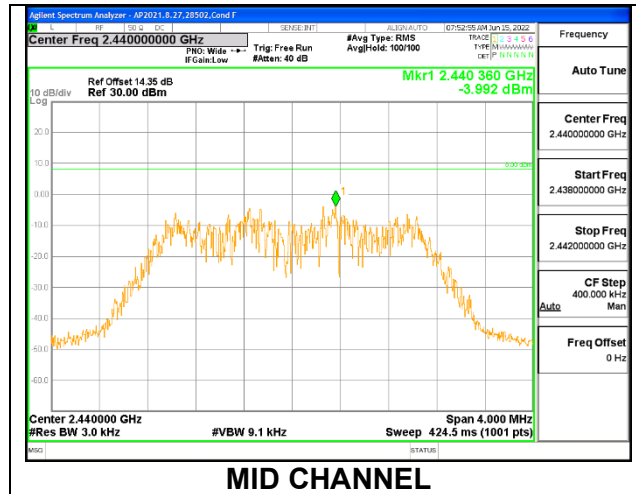

ANT 3

Channel	Frequency (MHz)	PSD (dBm/3kHz)	Limit (dBm/3kHz)	Margin (dB)
Low	2404	-4.182	8	-12.18
Middle	2440	-3.946	8	-11.95
High	2476	-3.868	8	-11.87

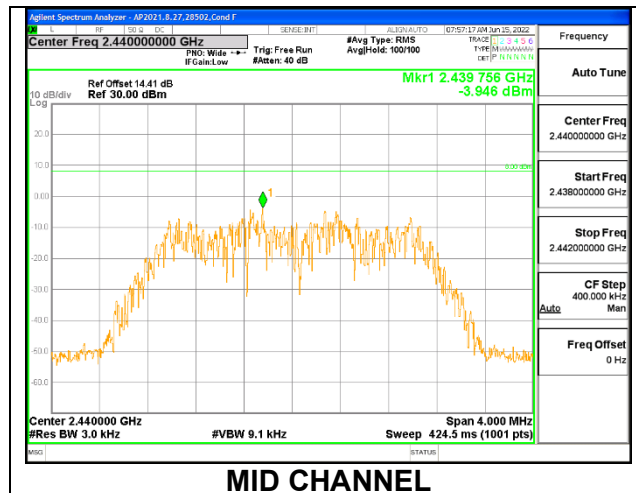

9.6.2. HIGH POWER HDR TXBF (HDR4)

Note: Test procedures and setting are same as HDR normal mode.

PSD Results

Channel	Frequency (MHz)	ANT 4 Meas (dBm/ 3kHz)	ANT 3 Meas (dBm/ 3kHz)	Total Corr'd PSD (dBm/ 3kHz)	Limit (dBm/ 3kHz)	Margin (dB)
Low	2404	-3.886	-4.173	-1.02	8.0	-9.0
Mid	2441	-4.175	-4.162	-1.16	8.0	-9.2
High	2476	-4.147	-3.919	-1.02	8.0	-9.0

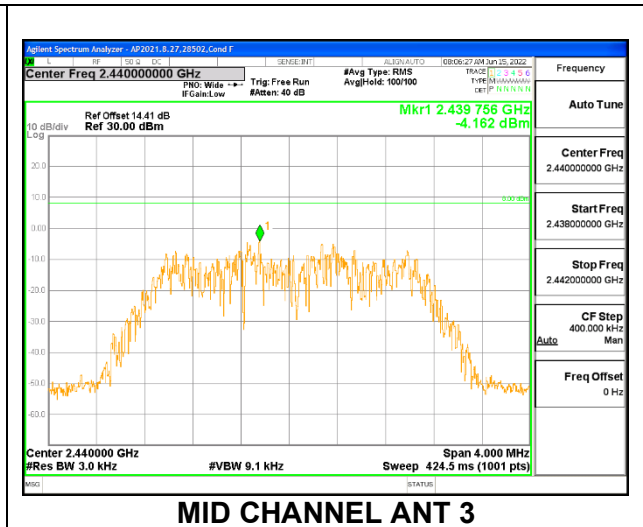
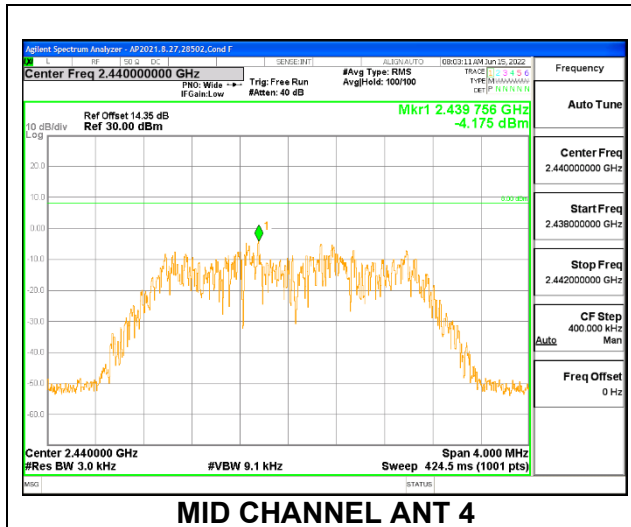

9.6.3. HIGH POWER HDR (HDR8)

ANT 4

Channel	Frequency (MHz)	PSD (dBm/3kHz)	Limit (dBm/3kHz)	Margin (dB)
Low	2404	-5.487	8	-13.49
Middle	2440	-5.558	8	-13.56
High	2476	-5.651	8	-13.65

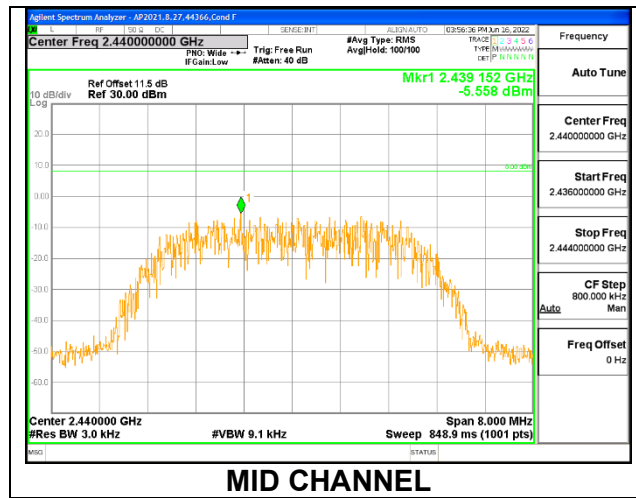

ANT 3

Channel	Frequency (MHz)	PSD (dBm/3kHz)	Limit (dBm/3kHz)	Margin (dB)
Low	2404	-5.652	8	-13.65
Middle	2441	-5.603	8	-13.60
High	2476	-5.564	8	-13.56

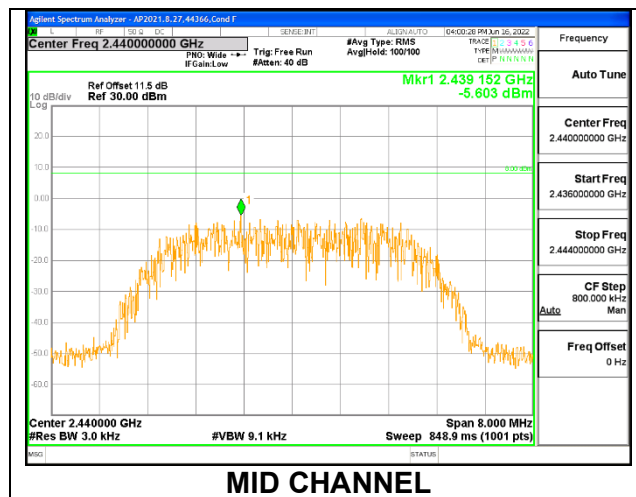

9.6.4. HIGH POWER HDR TXBF (HDR8)

Note: Test procedures and setting are same as HDR normal mode.

PSD Results

Channel	Frequency (MHz)	ANT 4 Meas (dBm/ 3kHz)	ANT 3 Meas (dBm/ 3kHz)	Total Corr'd PSD (dBm/ 3kHz)	Limit (dBm/ 3kHz)	Margin (dB)
Low	2404	-5.606	-5.678	-2.63	8.0	-10.6
Mid	2440	-5.714	-5.730	-2.71	8.0	-10.7
High	2476	-5.653	-5.575	-2.60	8.0	-10.6

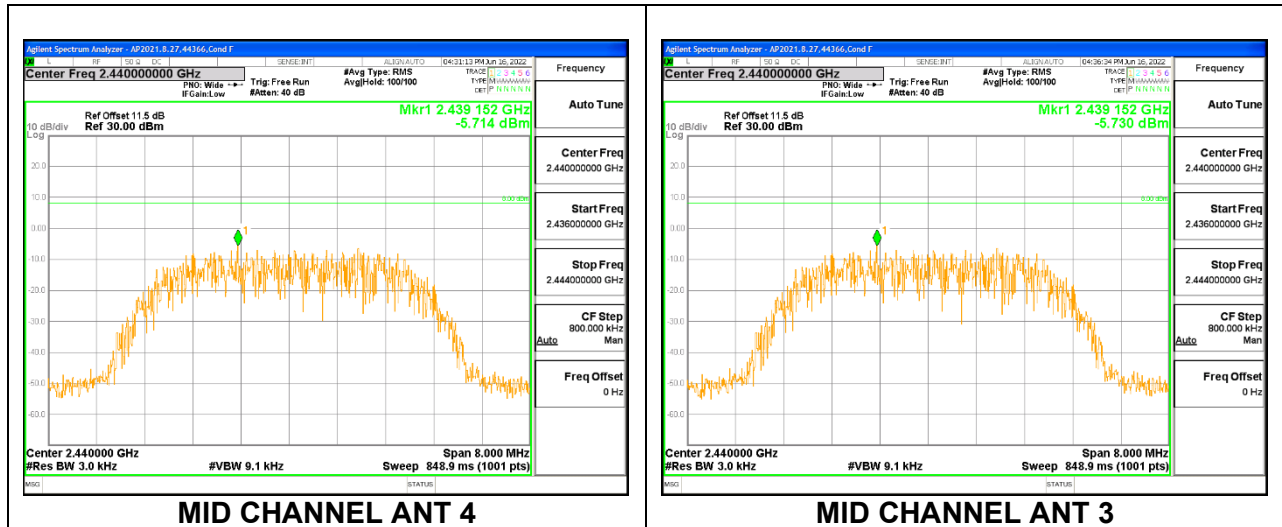

9.7. CONDUCTED SPURIOUS EMISSIONS

LIMITS

FCC §15.247 (d)

RSS-247 5.5

Output power was measured based on the use of a peak measurement, therefore the required attenuation is 20 dB.

RESULTS

9.7.1. HIGH POWER HDR (HDR4)

ANT 4

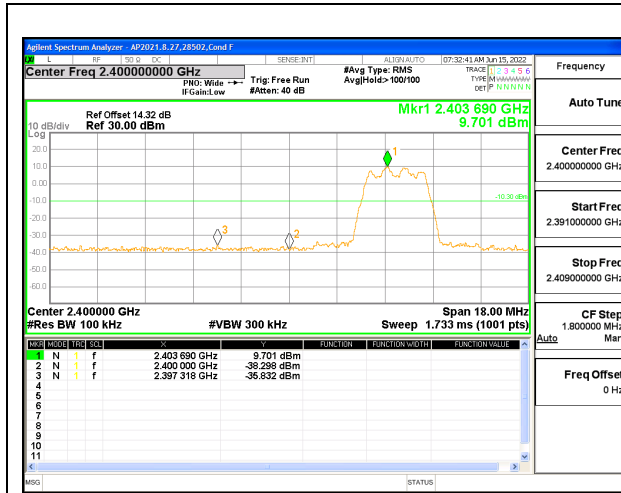

LOW CHANNEL BANDEDGE

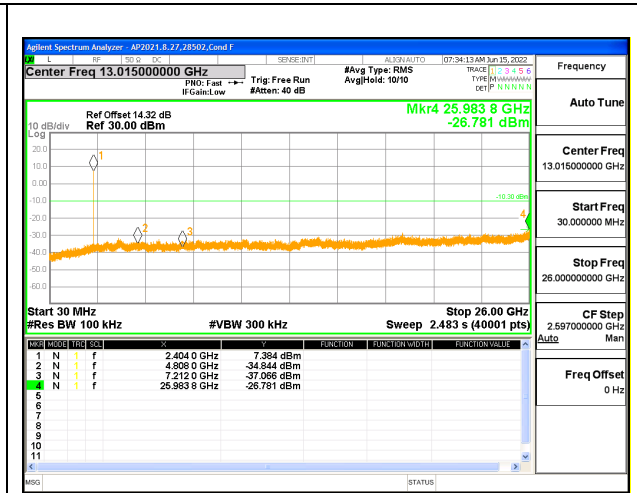

OUT-OF-BAND LOW CHANNEL

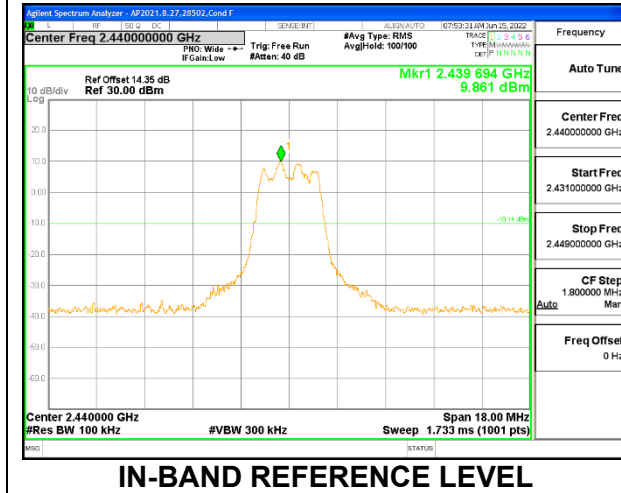

IN-BAND REFERENCE LEVEL

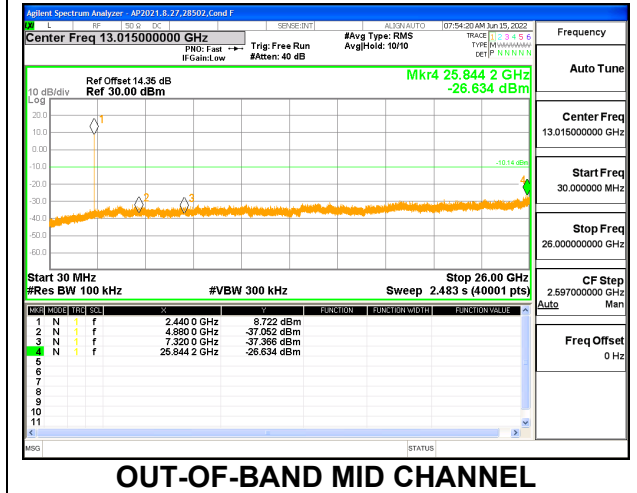

OUT-OF-BAND MID CHANNEL

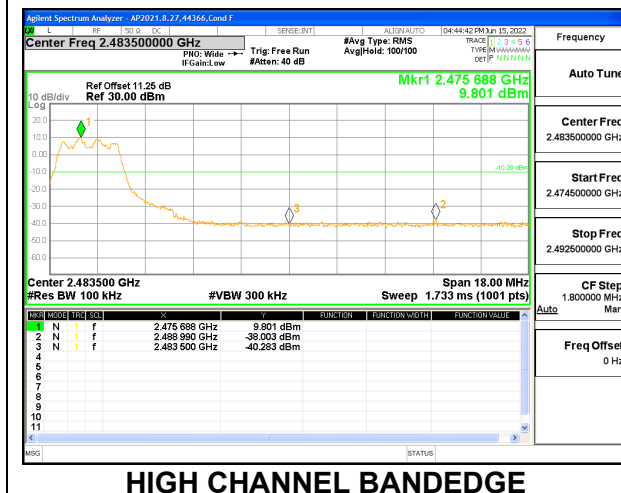

HIGH CHANNEL BANDEDGE

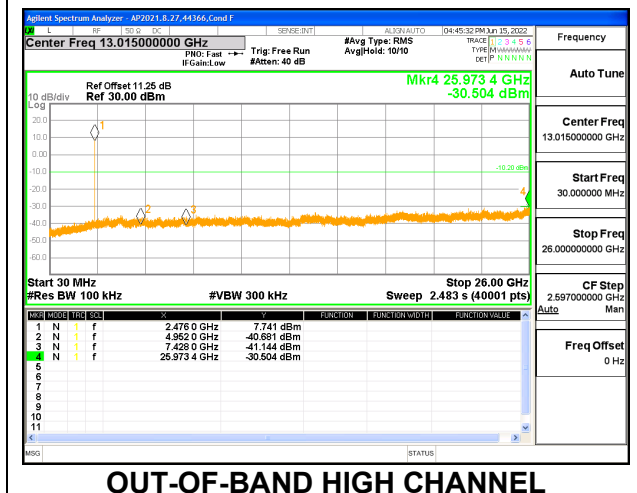

OUT-OF-BAND HIGH CHANNEL

ANT 3

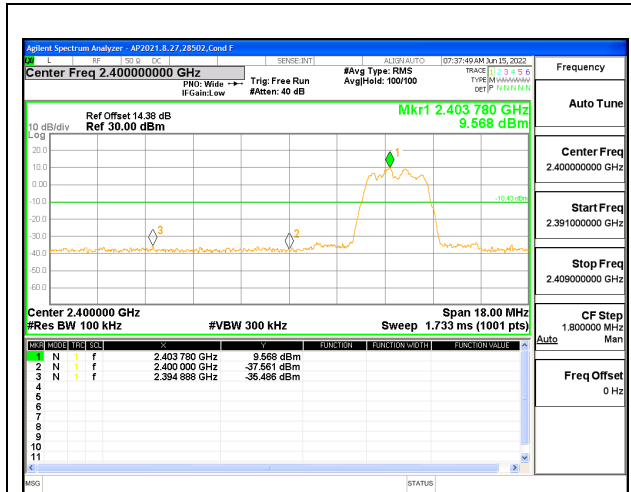

LOW CHANNEL BANDEDGE

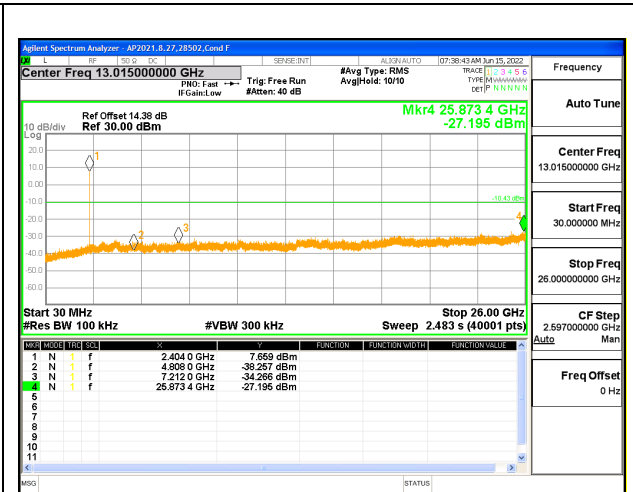

OUT-OF-BAND LOW CHANNEL

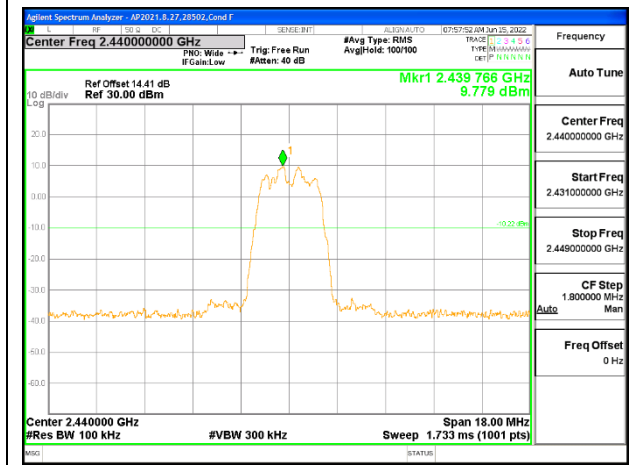

IN-BAND REFERENCE LEVEL

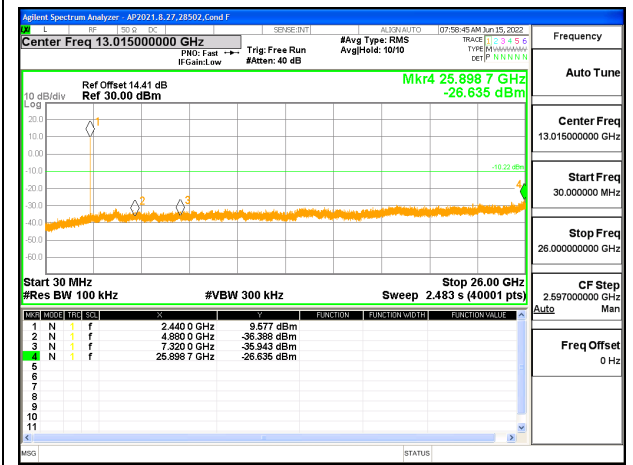

OUT-OF-BAND MID CHANNEL

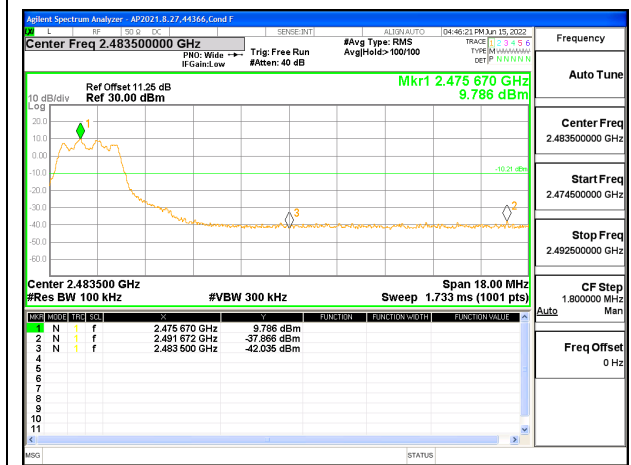

HIGH CHANNEL BANDEDGE

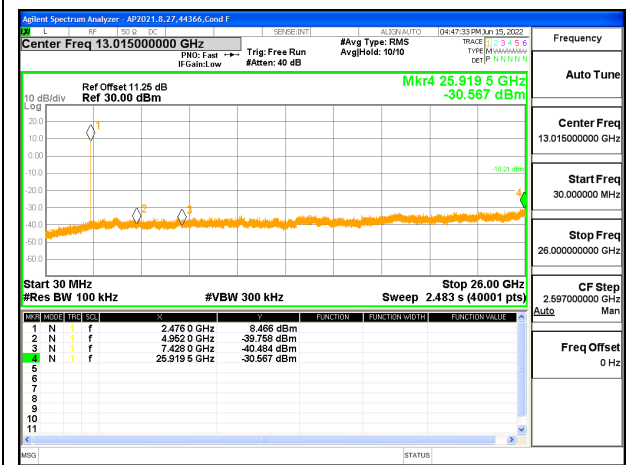

OUT-OF-BAND HIGH CHANNEL

9.7.2. HIGH POWER HDR TXBF (HDR4)

ANT 4

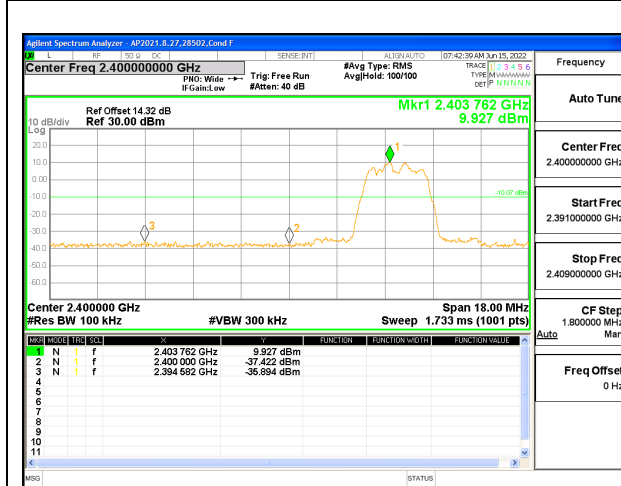

LOW CHANNEL BANDEDGE ANT 4

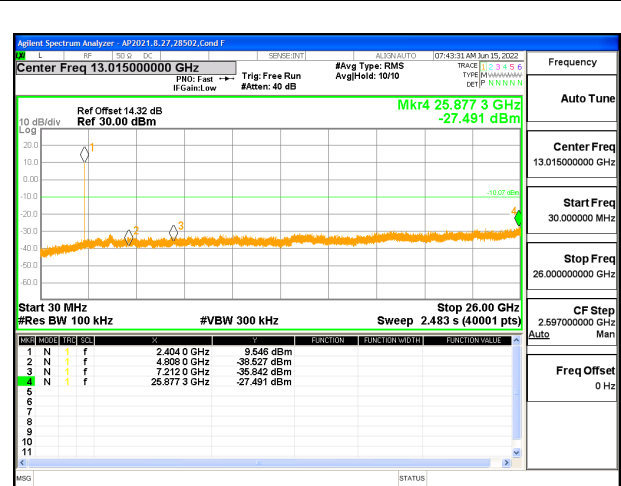

OUT-OF-BAND LOW CHANNEL ANT 4

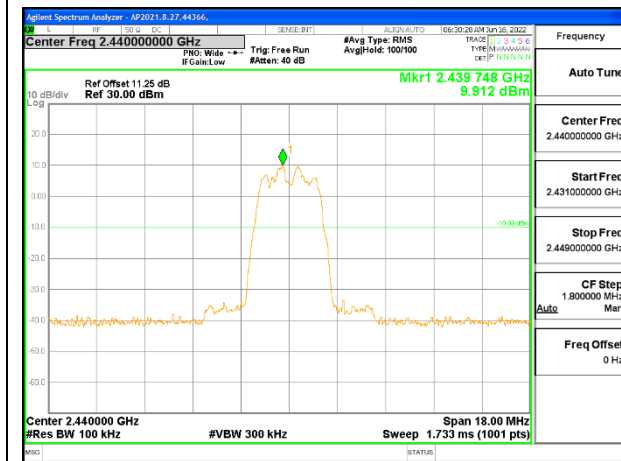

IN-BAND REFERENCE LEVEL ANT 4

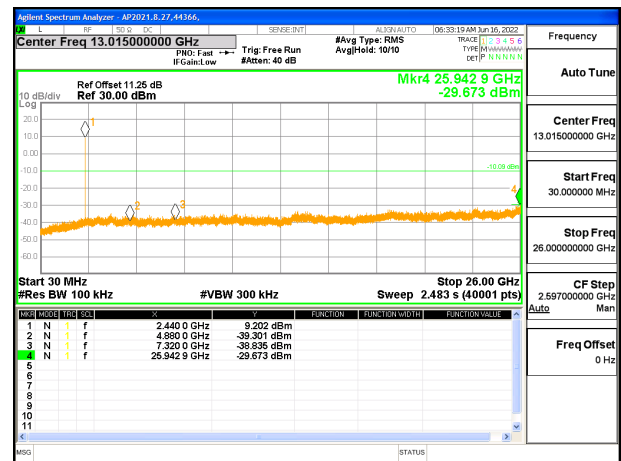

OUT-OF-BAND MID CHANNEL ANT 4

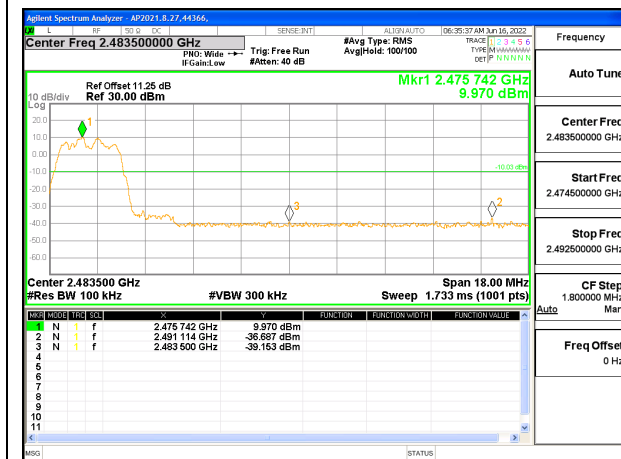

HIGH CHANNEL BANDEDGE ANT 4

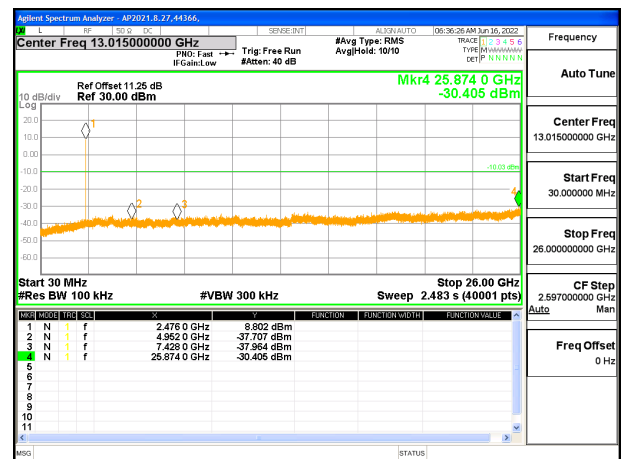

OUT-OF-BAND HIGH CHANNEL ANT 4

ANT 3

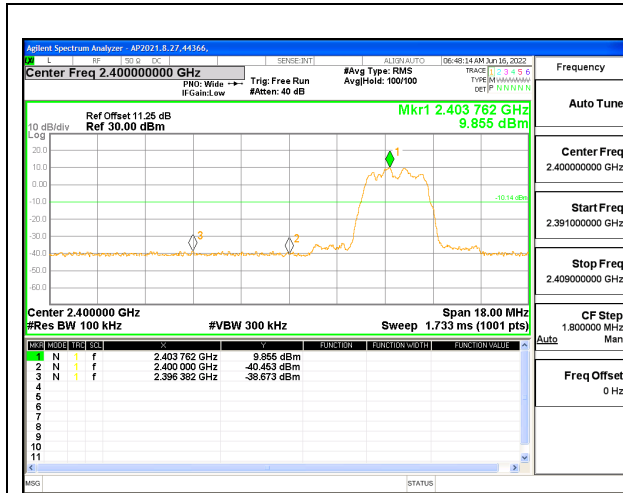

LOW CHANNEL BANDEDGE ANT 3

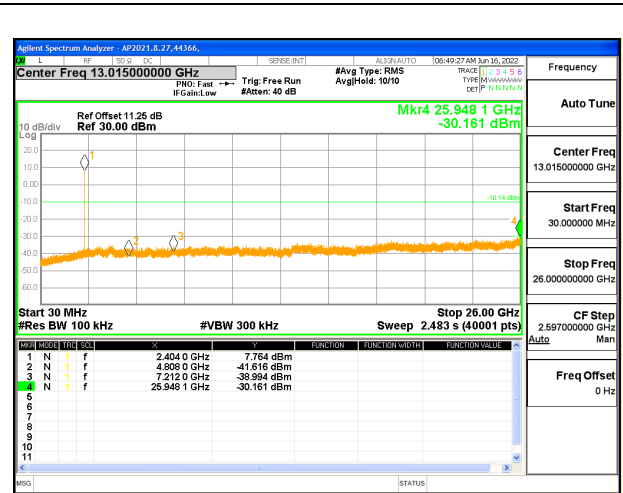

OUT-OF-BAND LOW CHANNEL ANT 3

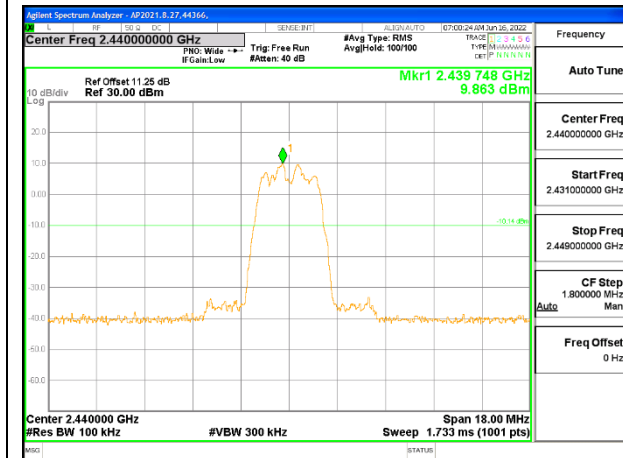

IN-BAND REFERENCE LEVEL ANT 3

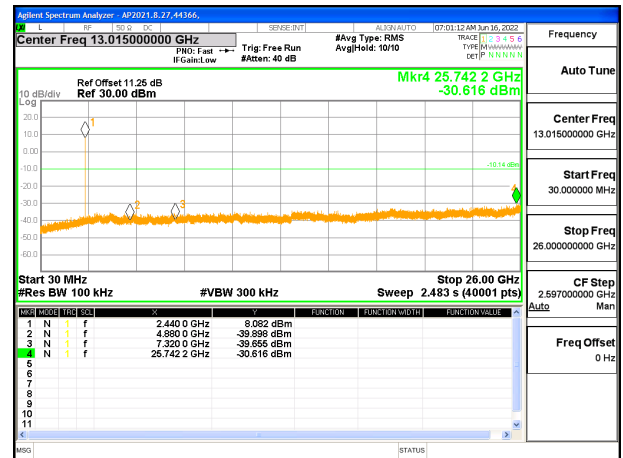

OUT-OF-BAND MID CHANNEL ANT 3

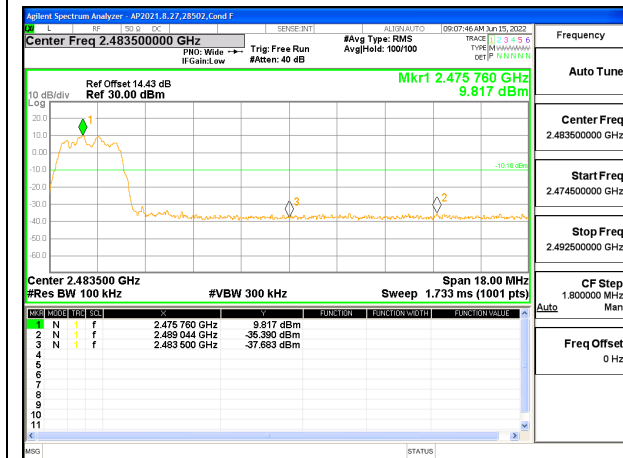

HIGH CHANNEL BANDEDGE ANT 3

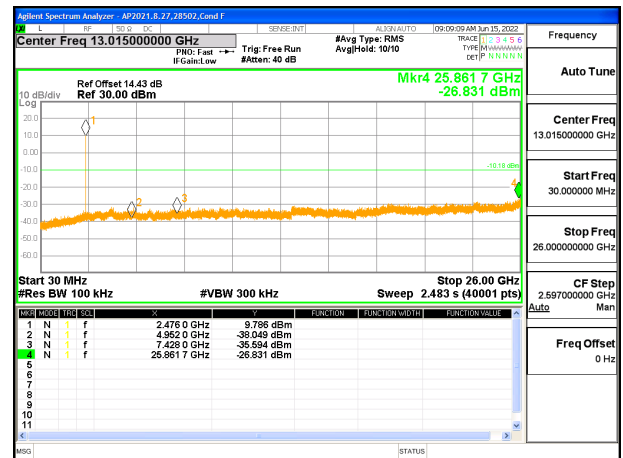

OUT-OF-BAND HIGH CHANNEL ANT 3

9.7.3. HIGH POWER HDR (HDR8)

ANT 4

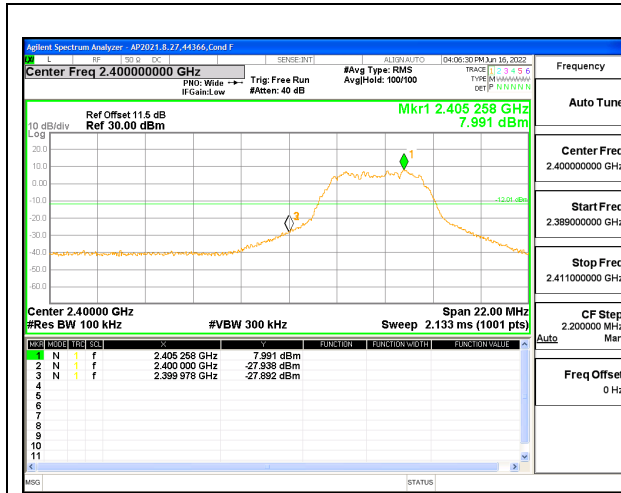

LOW CHANNEL BANDEDGE

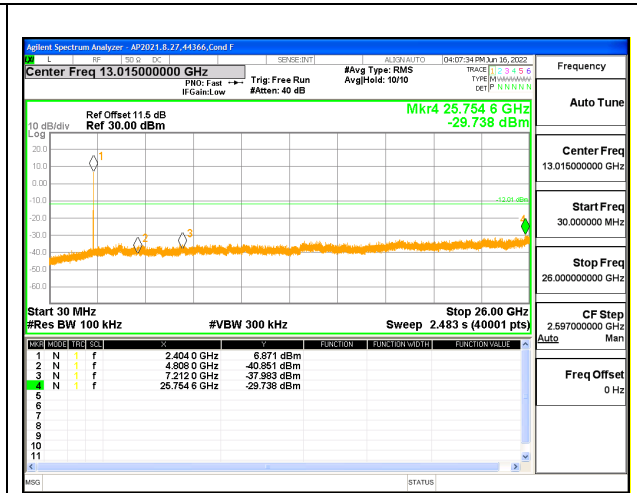

OUT-OF-BAND LOW CHANNEL

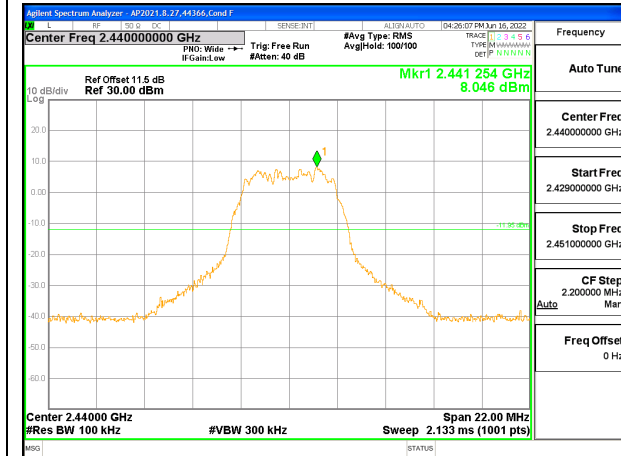

IN-BAND REFERENCE LEVEL

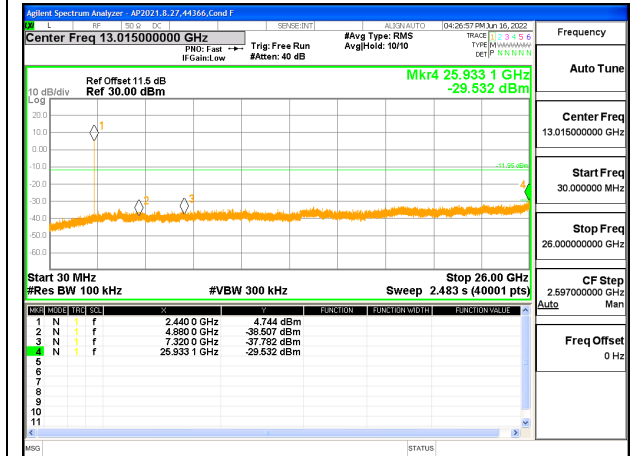

OUT-OF-BAND MID CHANNEL

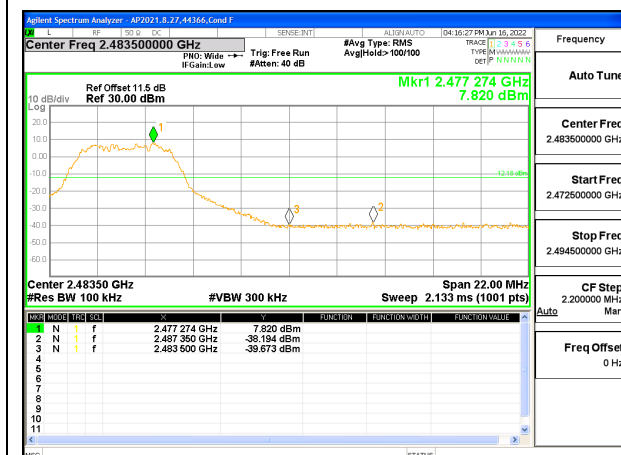

HIGH CHANNEL BANDEDGE

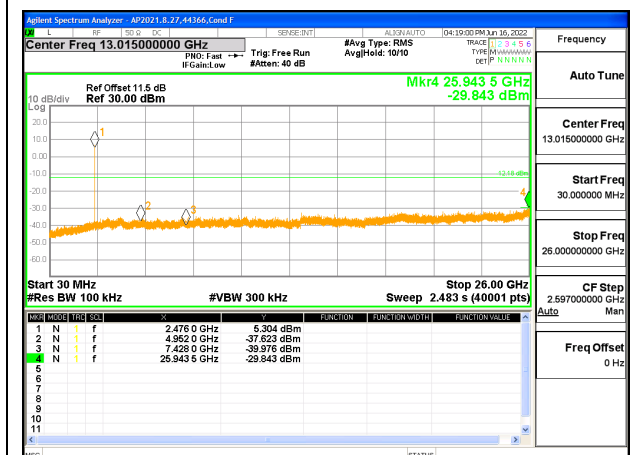

OUT-OF-BAND HIGH CHANNEL

ANT 3

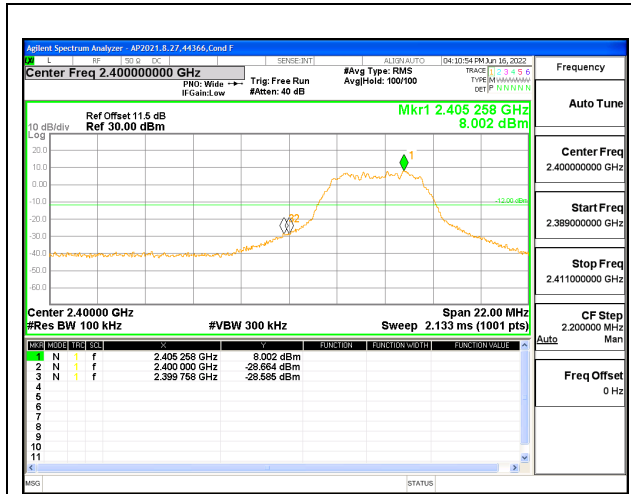

LOW CHANNEL BANDEDGE

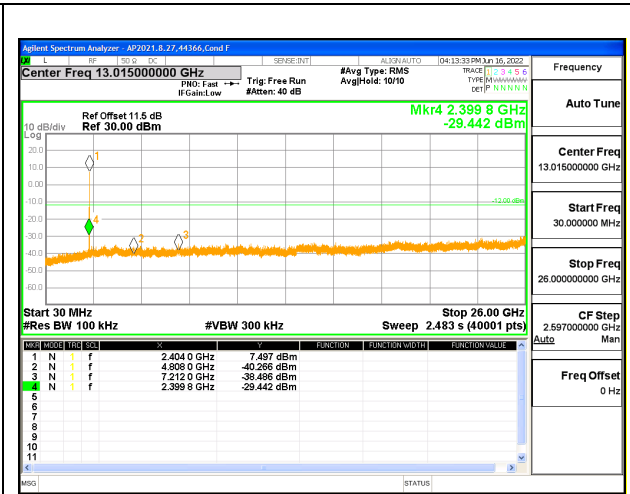

OUT-OF-BAND LOW CHANNEL

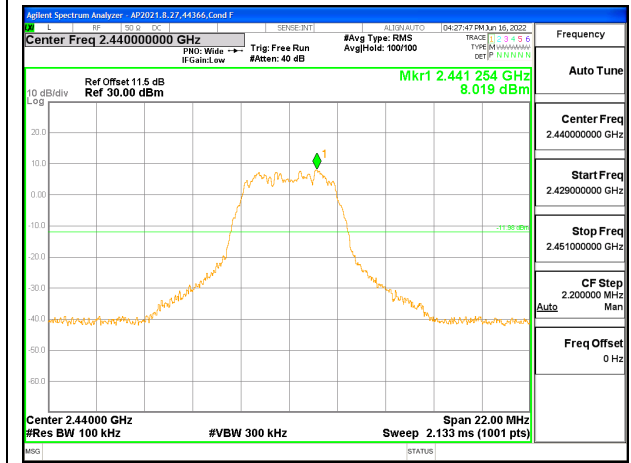

IN-BAND REFERENCE LEVEL

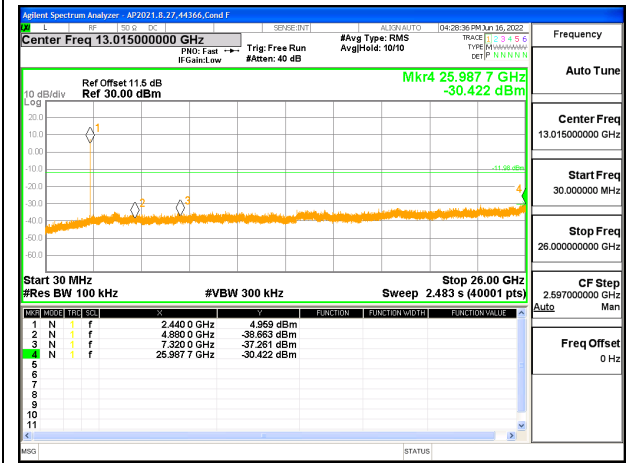

OUT-OF-BAND MID CHANNEL

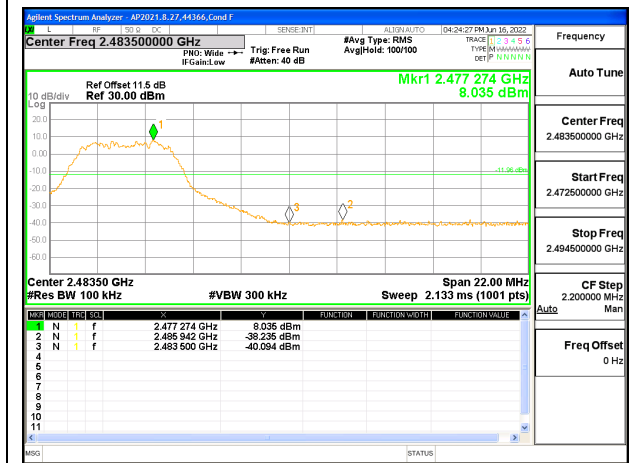

HIGH CHANNEL BANDEDGE

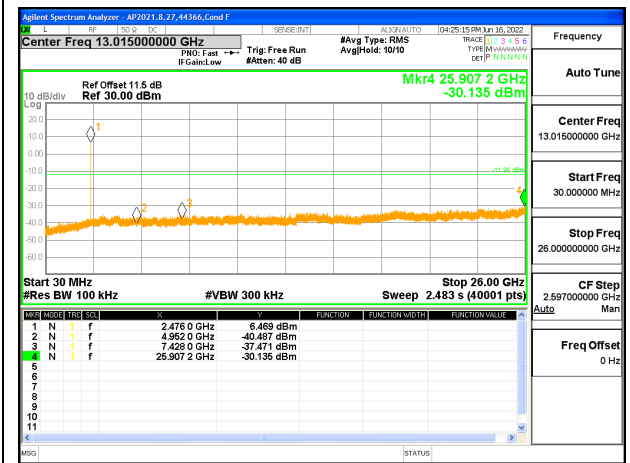

OUT-OF-BAND HIGH CHANNEL

9.7.4. HIGH POWER HDR TXBF (HDR8)

ANT 4

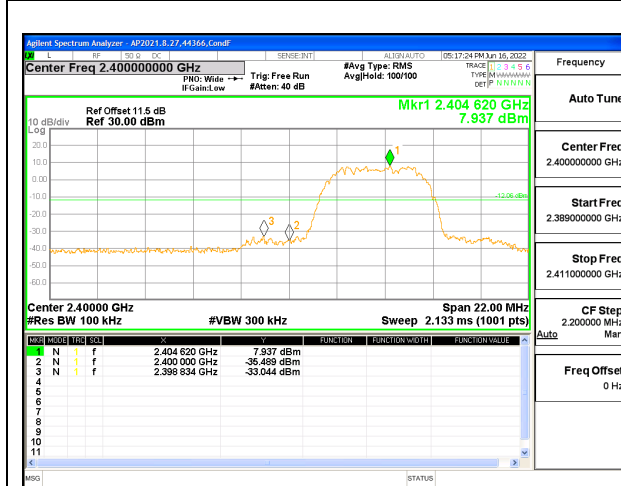

LOW CHANNEL BANDEDGE ANT 4

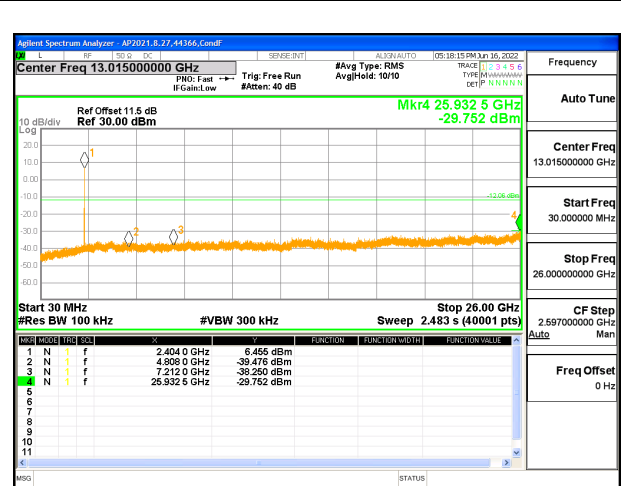

OUT-OF-BAND LOW CHANNEL ANT 4

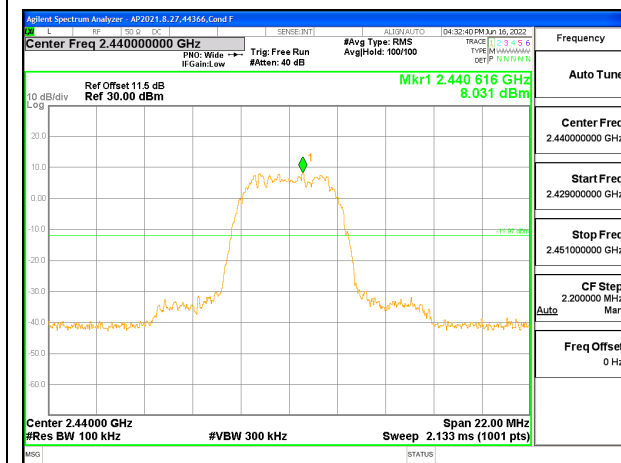

IN-BAND REFERENCE LEVEL ANT 4

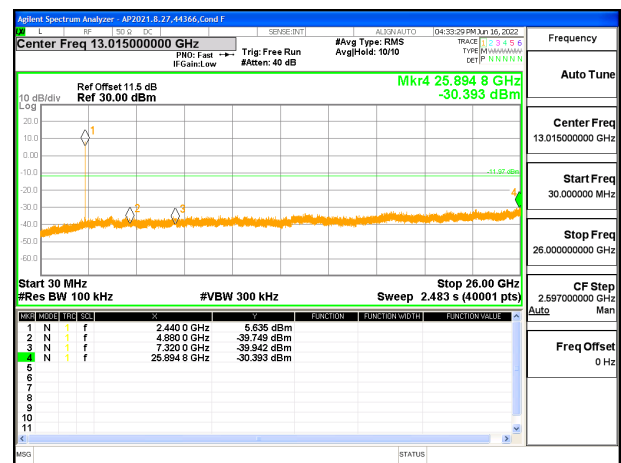

OUT-OF-BAND MID CHANNEL ANT 4

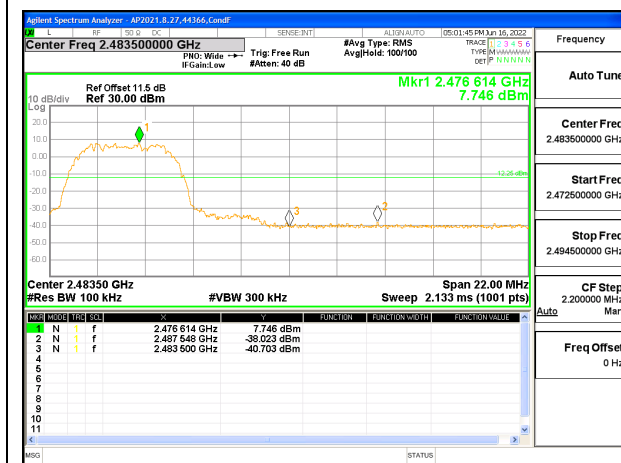

HIGH CHANNEL BANDEDGE ANT 4

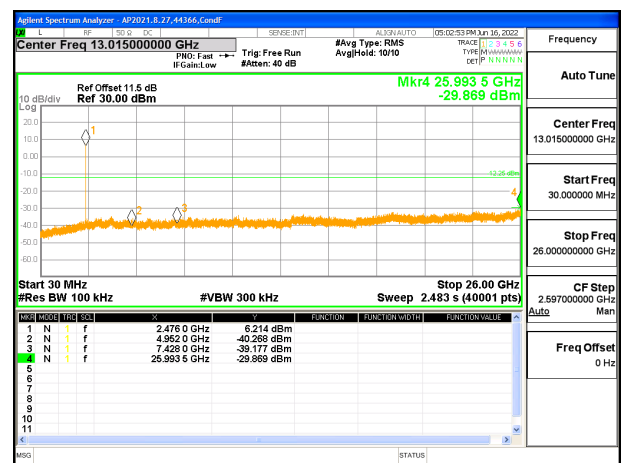

OUT-OF-BAND HIGH CHANNEL ANT 4

ANT 3

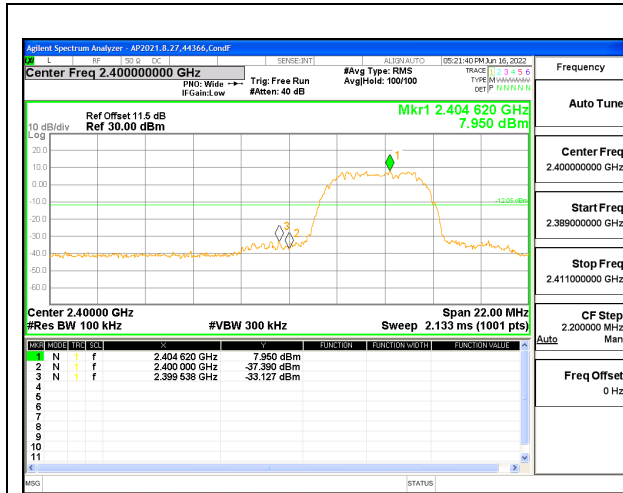

LOW CHANNEL BANDEDGE ANT 3

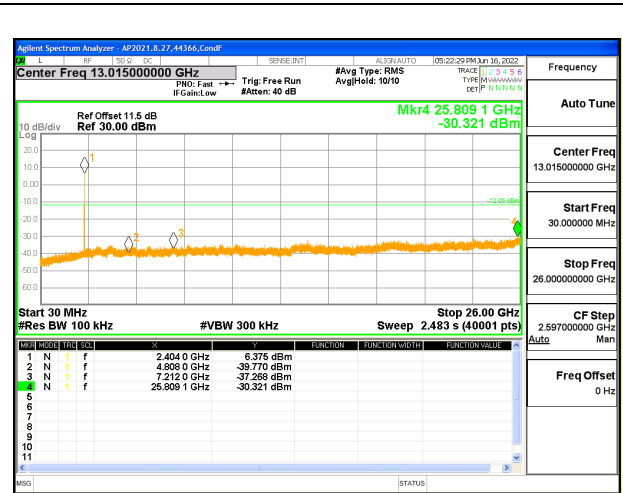

OUT-OF-BAND LOW CHANNEL ANT 3

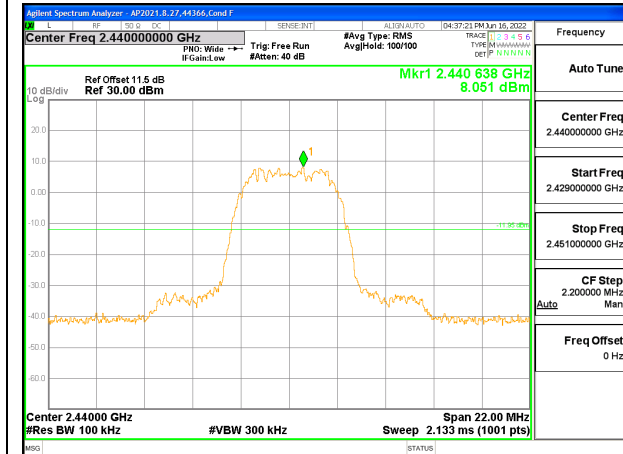

IN-BAND REFERENCE LEVEL ANT 3

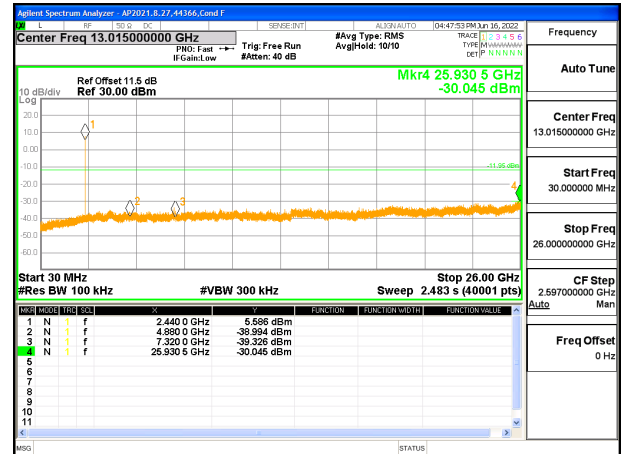

OUT-OF-BAND MID CHANNEL ANT 3

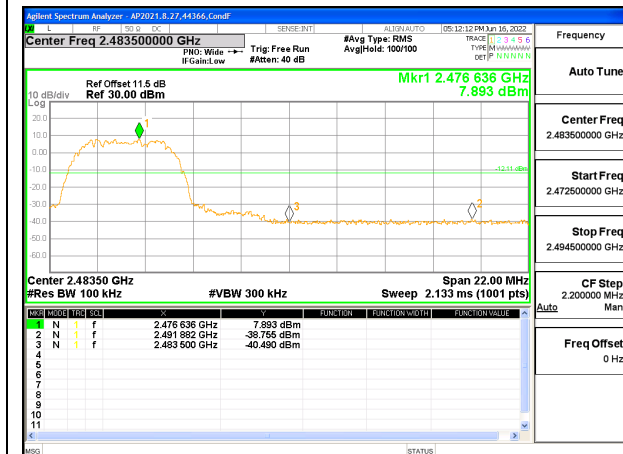

HIGH CHANNEL BANDEDGE ANT 3

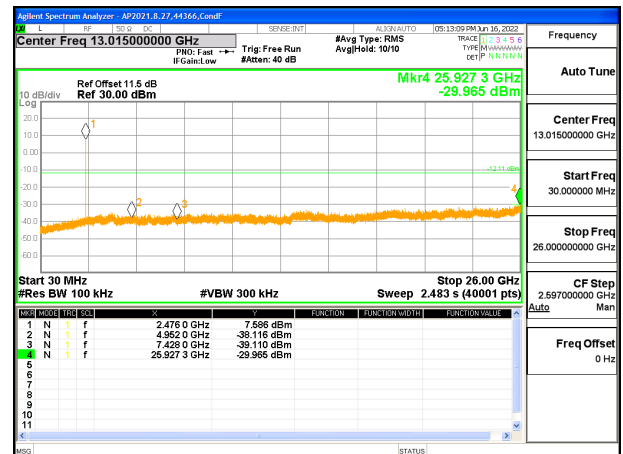

OUT-OF-BAND HIGH CHANNEL ANT 3

9.7.5. LOW POWER HDR (HDR4)

ANT 4

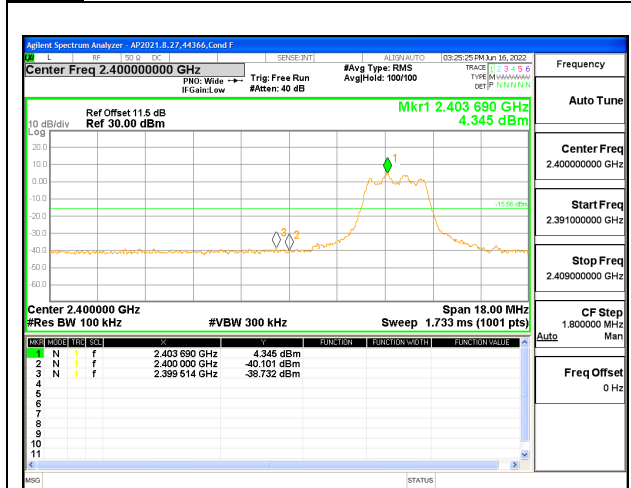

LOW CHANNEL BANDEDGE

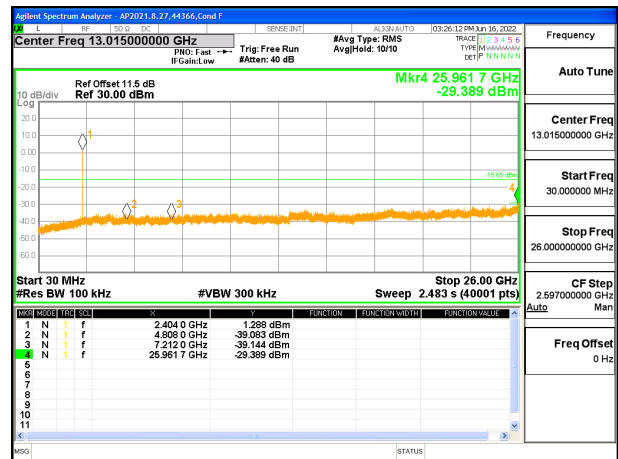

OUT-OF-BAND LOW CHANNEL

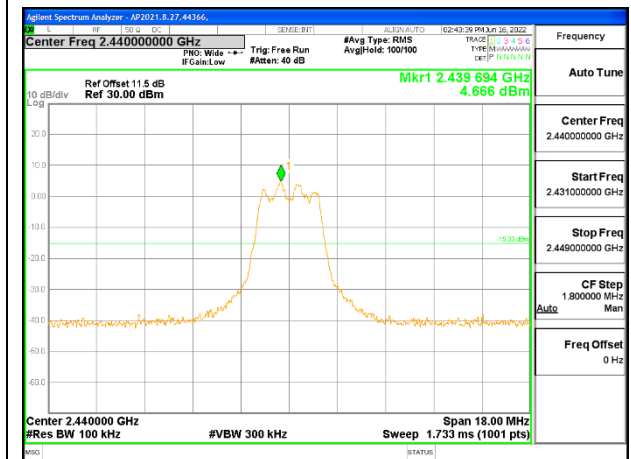

IN-BAND REFERENCE LEVEL

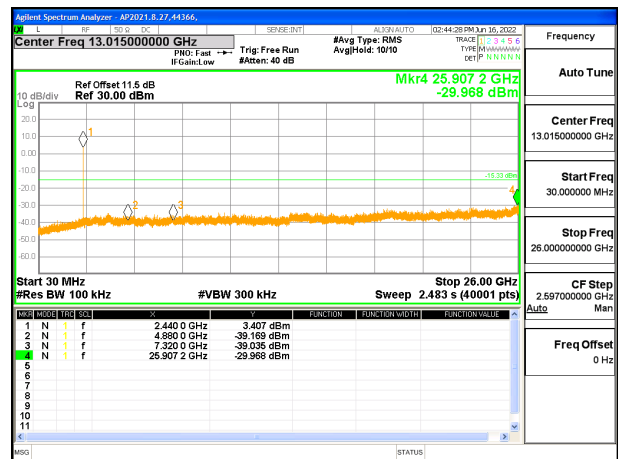

OUT-OF-BAND MID CHANNEL

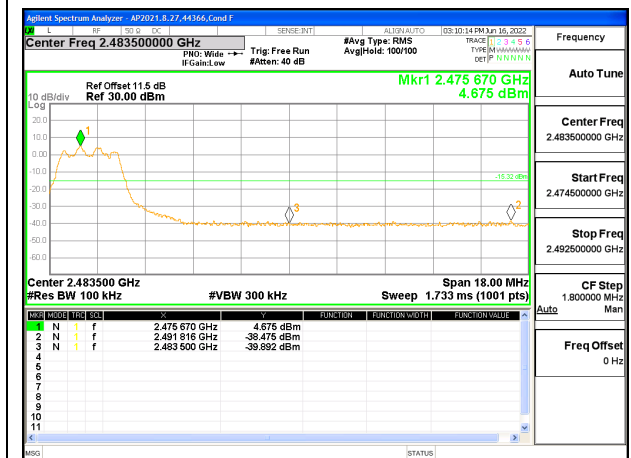

HIGH CHANNEL BANDEDGE

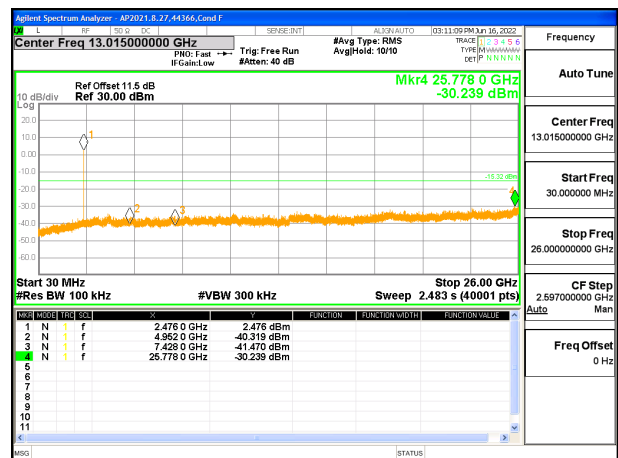

OUT-OF-BAND HIGH CHANNEL

ANT 3

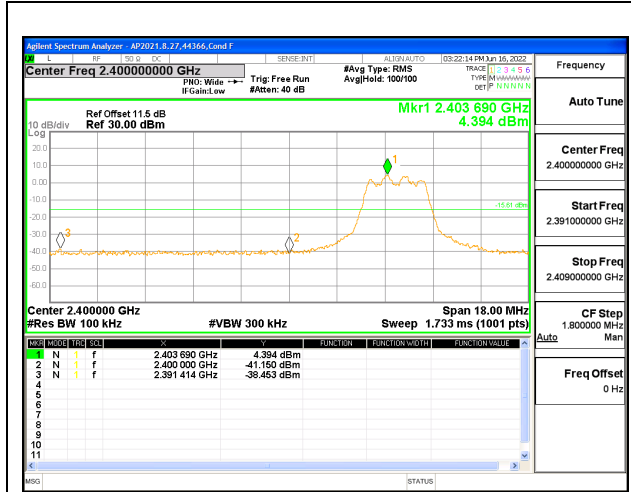

LOW CHANNEL BANDEDGE

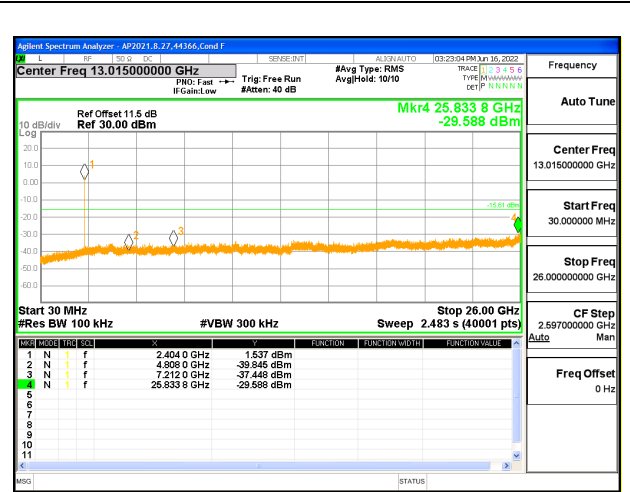

OUT-OF-BAND LOW CHANNEL

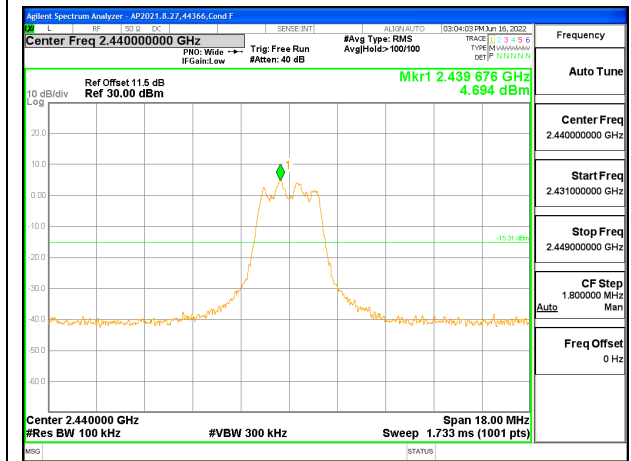

IN-BAND REFERENCE LEVEL

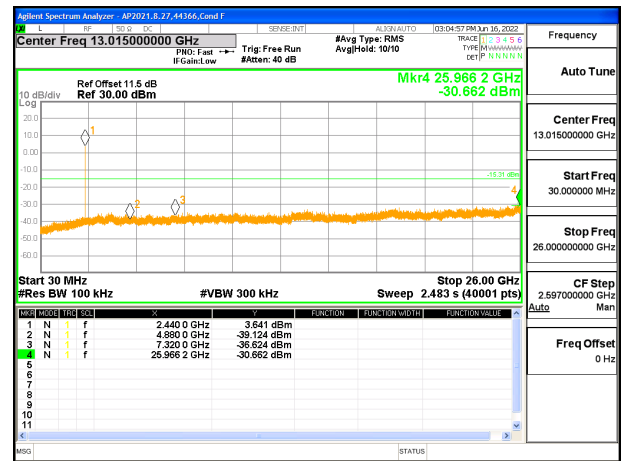

OUT-OF-BAND MID CHANNEL

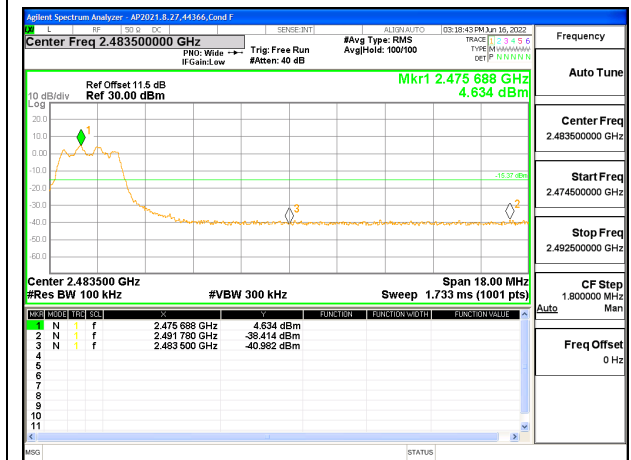

HIGH CHANNEL BANDEDGE

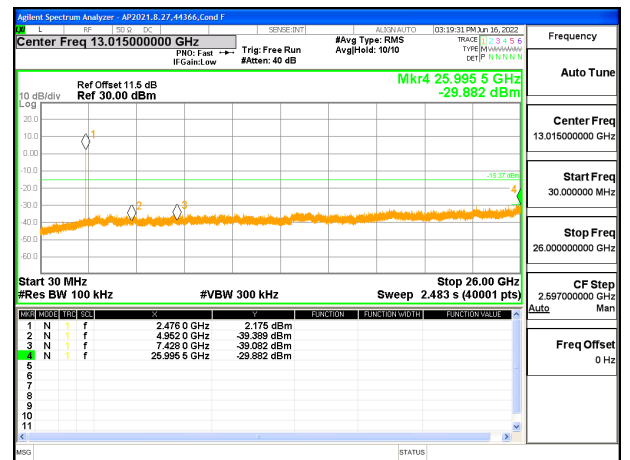

OUT-OF-BAND HIGH CHANNEL

9.7.6. LOW POWER HDR TXBF (HDR4)

ANT 4

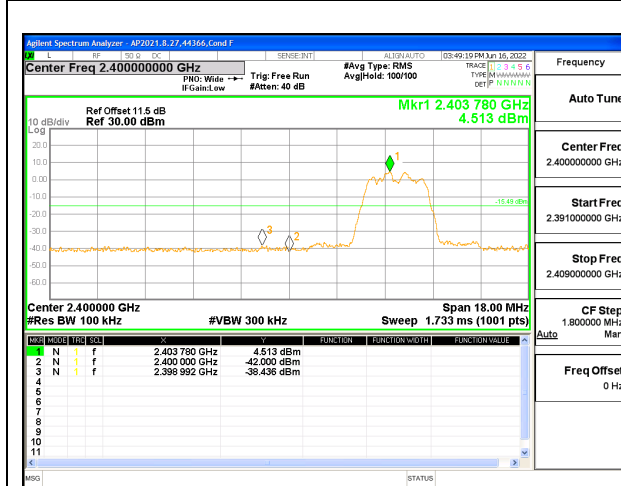

LOW CHANNEL BANDEDGE ANT 4

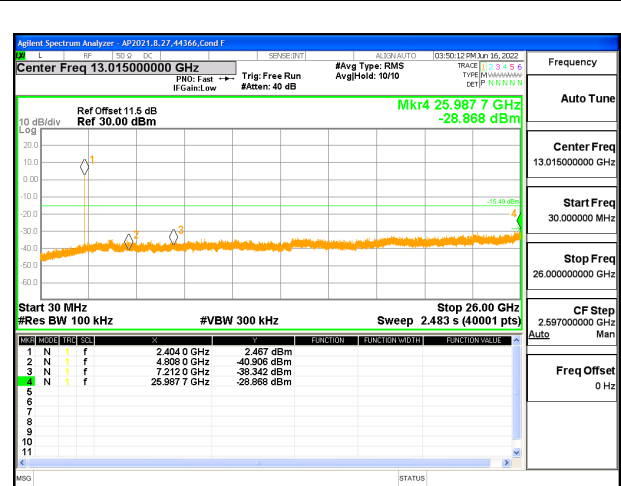

OUT-OF-BAND LOW CHANNEL ANT 4

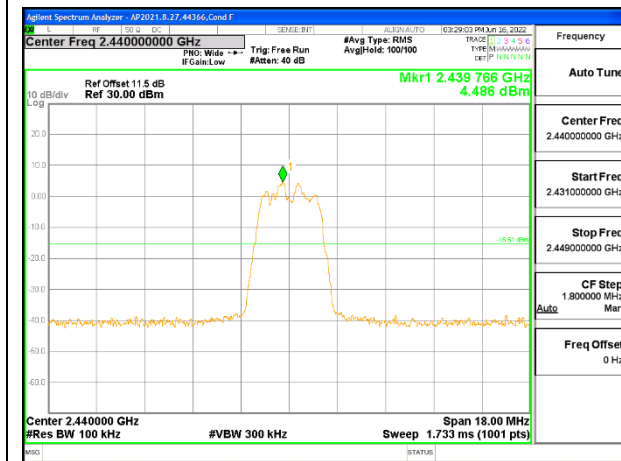

IN-BAND REFERENCE LEVEL ANT 4

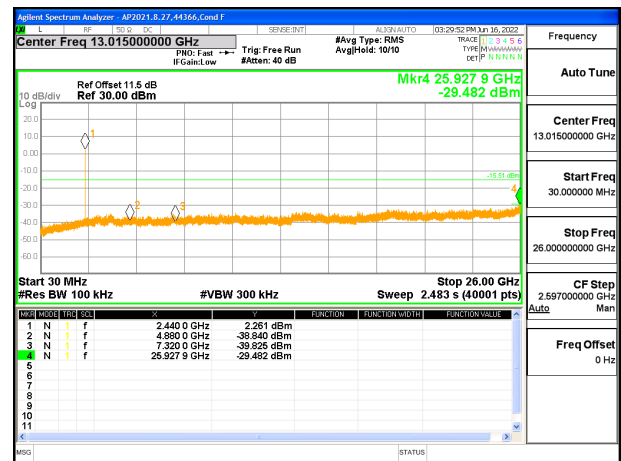

OUT-OF-BAND MID CHANNEL ANT 4

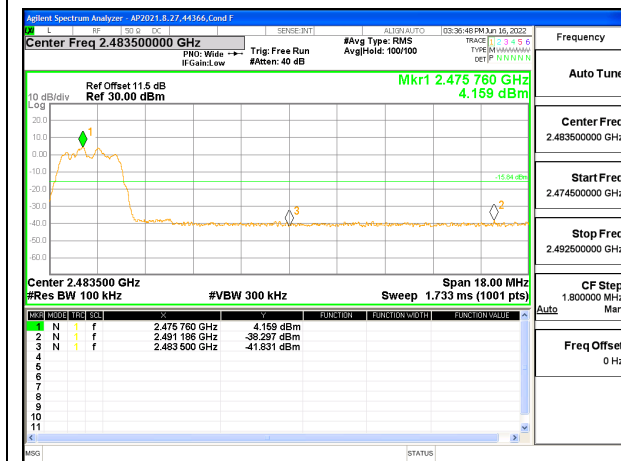

HIGH CHANNEL BANDEDGE ANT 4

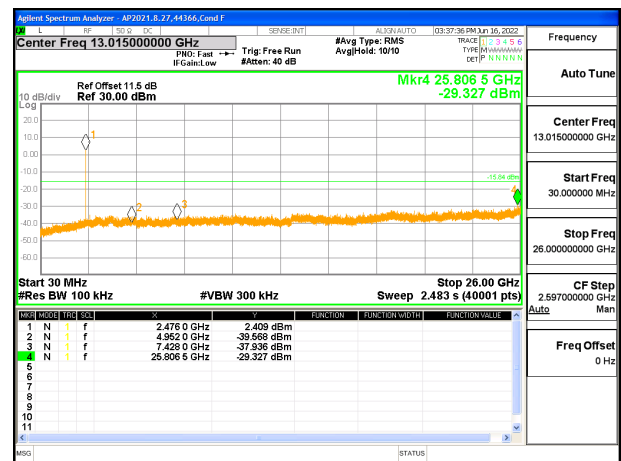

OUT-OF-BAND HIGH CHANNEL ANT 4