



TEST REPORT

Report Number: 14040868-E4V3

Applicant : APPLE, INC.
1 APPLE PARK WAY
CUPERTINO, CA 95014, U.S.A

Model : A2632 (Parent Model, Full Test)
A2885, A2886, A2887, A2888 (Variant Models)

FCC ID : BCG-E8139A (Parent Model)
BCG-E8146A, BCG-E8147A, BCG-E8148A
(Variant Models)

IC : 579C-E8139A (Parent Model)
579C-E8146A, 579C-E8147A, 579C-E8148A
(Variant Models)

EUT Description : SMARTPHONE

Test Standard(s) : FCC 47 CFR PART 15 SUBPART C
ISED RSS-247 ISSUE 2
ISED RSS-GEN ISSUE 5 + A1 + A2

Date Of Issue:
August 10, 2022

Prepared by:
UL VERIFICATIONS SERVICES INC.
47173 Benicia Street
Fremont, CA 94538 U.S.A.
TEL: (510) 319-4000
FAX: (510) 661-0888



REPORT REVISION HISTORY

Rev.	Issue Date	Revisions	Revised By
V1	7/25/2022	Initial Issue	Chris Xiong
V2	8/2/2022	Address TCB's questions section 8and 10.1	Chin Pang
V3	8/10/2022	Address TCB's Question on page 233	Chin Pang

TABLE OF CONTENTS

1. ATTESTATION OF TEST RESULTS	5
2. TEST RESULTS SUMMARY.....	7
3. TEST METHODOLOGY	7
4. FACILITIES AND ACCREDITATION	7
5. DECISION RULES AND MEASUREMENT UNCERTAINTY	8
5.1. <i>METROLOGICAL TRACEABILITY</i>	<i>8</i>
5.2. <i>DECISION RULES.....</i>	<i>8</i>
5.3. <i>MEASUREMENT UNCERTAINTY.....</i>	<i>8</i>
5.4. <i>SAMPLE CALCULATION</i>	<i>8</i>
6. EQUIPMENT UNDER TEST.....	9
6.1. <i>EUT DESCRIPTION.....</i>	<i>9</i>
6.2. <i>MAXIMUM OUTPUT POWER.....</i>	<i>9</i>
6.3. <i>DESCRIPTION OF AVAILABLE ANTENNAS.....</i>	<i>10</i>
6.4. <i>SOFTWARE AND FIRMWARE.....</i>	<i>10</i>
6.5. <i>WORST-CASE CONFIGURATION AND MODE.....</i>	<i>11</i>
6.6. <i>DESCRIPTION OF TEST SETUP.....</i>	<i>12</i>
7. MEASUREMENT METHOD.....	15
8. TEST AND MEASUREMENT EQUIPMENT	16
9. ANTENNA PORT TEST RESULTS.....	18
9.1. <i>ON TIME AND DUTY CYCLE.....</i>	<i>18</i>
9.2. <i>99% BANDWIDTH.....</i>	<i>21</i>
9.2.1. <i>802.11b MODE 1TX.....</i>	<i>22</i>
9.2.2. <i>802.11n HT20 MODE 1TX.....</i>	<i>24</i>
9.2.3. <i>802.11n HT20 CDD MODE 2TX</i>	<i>26</i>
9.2.4. <i>802.11ax HE20 MODE 1TX.....</i>	<i>27</i>
9.2.5. <i>802.11ax HE20 OFDMA MODE 2TX</i>	<i>35</i>
9.3. <i>6dB BANDWIDTH.....</i>	<i>39</i>
9.3.1. <i>802.11b MODE 1TX.....</i>	<i>40</i>
9.3.2. <i>802.11n HT20 MODE 1TX.....</i>	<i>42</i>
9.3.3. <i>802.11n HT20 CDD MODE 2TX</i>	<i>44</i>
9.3.4. <i>802.11ax HE20 MODE 1TX.....</i>	<i>45</i>
9.3.5. <i>802.11ax HE20 OFDMA MODE 2TX</i>	<i>53</i>
9.4. <i>OUTPUT POWER.....</i>	<i>57</i>
9.4.1. <i>802.11b MODE 1TX.....</i>	<i>58</i>
9.4.2. <i>802.11n HT20 MODE 1TX.....</i>	<i>60</i>
9.4.3. <i>802.11n HT20 CDD MODE 2TX</i>	<i>62</i>
9.4.4. <i>802.11ax HE20 MODE 1TX.....</i>	<i>63</i>

9.4.5. 802.11ax HE20 OFDMA MODE 2TX71

9.5. POWER SPECTRAL DENSITY75

9.5.1. 802.11b MODE 1TX.....76

9.5.2. 802.11n HT20 MODE 1TX.....78

9.5.3. 802.11n HT20 CDD MODE 2TX80

9.5.4. 802.11ax HE20 MODE 1TX.....81

9.5.5. 802.11ax HE20 OFDMA MODE 2TX89

9.6. CONDUCTED SPURIOUS EMISSIONS.....93

9.6.1. 802.11b MODE 1TX.....94

9.6.2. 802.11n HT20 MODE 1TX.....98

9.6.3. 802.11n HT20 CDD MODE 2TX104

9.6.4. 802.11ax HE20 MODE 1TX.....110

9.6.5. 802.11ax HE20 OFDMA MODE 2TX128

10. RADIATED TEST RESULTS.....148

10.1. TRANSMITTER ABOVE 1 GHz.....150

10.1.1. 802.11b ANT 4 MODE IN THE 2.4 GHz BAND (BANDEDGE).....150

10.1.2. 802.11b ANT 4 MODE (HARMONICS AND SPURIOUS EMISSIONS).....158

10.1.3. 802.11b ANT 3 MODE IN THE 2.4 GHz BAND (BANDEDGE).....164

10.1.4. 802.11b ANT 3 MODE (HARMONICS AND SPURIOUS EMISSIONS).....172

10.1.5. 802.11n HT20 ANT 4 MODE IN THE 2.4 GHz BAND (BANDEDGE)178

10.1.6. 802.11n HT20 ANT 3 MODE IN THE 2.4 GHz BAND (BANDEDGE)190

10.1.7. 802.11n HT20 2TX MODE IN THE 2.4 GHz BAND (BANDEDGE).....202

10.1.8. 802.11n HT20 2TX MODE (HARMONICS AND SPURIOUS EMISSIONS).....218

10.1.9. 802.11ax HE20 ANT 4 MODE IN THE 2.4 GHz BAND (BANDEDGE)224

10.1.10. 802.11ax HE20 ANT 3 MODE IN THE 2.4 GHz BAND (BANDEDGE)256

10.1.11. 802.11ax HE20 2TX MODE IN THE 2.4 GHz BAND (BANDEDGE).....288

10.1.12. 802.11ax HE20 2TX MODE (HARMONICS AND SPURIOUS EMISSIONS).....324

10.2. WORST CASE BELOW 1 GHz336

10.3. WORST CASE 18-26 GHz.....338

11. AC POWER LINE CONDUCTED EMISSIONS.....339

11.1. AC POWER LINE WITH CHARGER.....340

11.2. AC POWER LINE WITH LAPTOP.....342

12. SETUP PHOTOS.....344

1. ATTESTATION OF TEST RESULTS

COMPANY NAME: APPLE INC.
1 APPLE PARK WAY
CUPERTINO, CA 95014, U.S.A

EUT DESCRIPTION: Smartphone

MODEL: A2632 (Parent Model, Full Test)
A2885, A2886, A2887, A2888 (Variant Models)

BRAND: APPLE

FCC ID: BCG-E8139A (Parent Model)
BCG-E8146A, BCG-E8147A, BCG-E8148A (Variant Models)

IC ID: 579C-E8139A (Parent Model)
579C-E8146A, 579C-E8147A, 579C-E8148A (Variant Models)

SERIAL NUMBER: XW0VV55QG3(Conducted), KCF16NH2M0 (Radiated)

SAMPLE RECEIPT DATE: MARCH 18, 2022

DATE TESTED: MARCH 22, 2022 TO AUGUST 02, 2022

APPLICABLE STANDARDS	
STANDARD	TEST RESULTS
CFR 47 Part 15 Subpart C	Complies
ISED RSS-247 Issue 2	Complies
ISED RSS-GEN Issue 5 + A1 + A2	Complies

UL LLC tested the above equipment in accordance with the requirements set forth in the above standards. The test results show that the equipment tested is capable of demonstrating compliance with the requirements as documented in this report.

The results documented in this report apply only to the tested sample, under the conditions and modes of operation as described herein. It is the manufacturer's responsibility to assure that additional production units of this model are manufactured with identical electrical and mechanical components. All samples tested were in good operating condition throughout the entire test program. Measurement Uncertainties are published for informational purposes only and were not taken into account unless noted otherwise.

This document may not be altered or revised in any way unless done so by UL LLC and all revisions are duly noted in the revisions section. Any alteration of this document not carried out by UL LLC will constitute fraud and shall nullify the document. This report must not be used by the client to claim product certification, approval, or endorsement by A2LA, NIST, any agency of the Federal Government, or any agency of the U.S. government.

Approved & Released For
UL VERIFICATIONS SERVICES INC. By:



Prepared By:

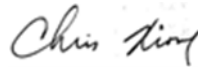

Frank Ibrahim
Staff Engineer
Consumer Technology Division
UL VERIFICATIONS SERVICES INC.

Chris Xiong
Senior Test Engineer
Consumer Technology Division
UL VERIFICATIONS SERVICES INC.

2. TEST RESULTS SUMMARY

This report contains data provided by the customer which can impact the validity of results. UL VERIFICATIONS SERVICES INC. is only responsible for the validity of results after the integration of the data provided by the customer.

FCC Clause	ISED Clause	Requirement	Result	Comment
See Comment		Duty Cycle	Reporting purposes only	ANSI C63.10 Section 11.6.
-	RSS-GEN 6.7	99% OBW	Reporting purposes only	ANSI C63.10 Section 6.9.3.
15.247 (a) (2)	RSS-247 5.2 (a)	6dB BW	Complies	None.
15.247 (b) (3)	RSS-247 5.4 (d)	Output Power	Complies	None.
15.247 (e)	RSS-247 5.2 (b)	PSD	Complies	None.
15.247 (d)	RSS-247 5.5	Conducted Spurious Emissions	Complies	None.
15.209, 15.205	RSS-GEN 8.9, 8.10	Radiated Emissions	Complies	None.
15.207	RSS-Gen 8.8	AC Mains Conducted Emissions	Complies	None.

3. TEST METHODOLOGY

The tests documented in this report were performed in accordance with:

- FCC CFR 47 Part 2
- FCC CFR 47 Part 15
- FCC KDB 558074 D01 v05r02 15.247 Meas Guidance
- ANSI C63.10-2013
- RSS-GEN Issue 5 + A1 + A2
- KDB 414788 D01 Radiated Test Site v01r01
- RSS-247 Issue 2

4. FACILITIES AND ACCREDITATION

UL VERIFICATIONS SERVICES INC. is accredited by A2LA, certification #0751.05, for all testing performed within the scope of this report. Testing was performed at the locations noted below.

Location	Address	ISED CABID	ISED Company Number	FCC Registration
<input checked="" type="checkbox"/>	Building 1: 47173 Benicia Street, Fremont, CA 94538, USA	US0104	2324A	550739
<input checked="" type="checkbox"/>	Building 2: 47266 Benicia Street, Fremont, CA 94538, USA	US0104	22541	550739
<input checked="" type="checkbox"/>	Building 4: 47658 Kato Rd, Fremont, CA 94538, USA	US0104	2324B	550739

5. DECISION RULES AND MEASUREMENT UNCERTAINTY

5.1. METROLOGICAL TRACEABILITY

All test and measuring equipment utilized to perform the tests documented in this report are calibrated on a regular basis, with a maximum time between calibrations of one year or the manufacturers' recommendation, whichever is less, and where applicable is traceable to recognized national standards.

5.2. DECISION RULES

The Decision Rule is based on Simple Acceptance in accordance with ISO Guide 98-4:2012 Clause 8.2. (Measurement uncertainty is not taken into account when stating conformity with a specified requirement.)

5.3. MEASUREMENT UNCERTAINTY

Where relevant, the following measurement uncertainty levels have been estimated for tests performed on the apparatus:

PARAMETER	U_{Lab}
Worst Case Conducted Disturbance, 9KHz to 0.15 MHz	3.78 dB
Worst Case Conducted Disturbance, 0.15 to 30 MHz	3.40 dB
Worst Case Radiated Disturbance, 9KHz to 30 MHz	2.87 dB
Worst Case Radiated Disturbance, 30 to 1000 MHz	6.01 dB
Worst Case Radiated Disturbance, 1000 to 18000 MHz	4.73 dB
Worst Case Radiated Disturbance, 18000 to 26000 MHz	4.51 dB
Worst Case Radiated Disturbance, 26000 to 40000 MHz	5.29 dB

Uncertainty figures are valid to a confidence level of 95%.

5.4. SAMPLE CALCULATION

RADIATED EMISSIONS

Where relevant, the following sample calculation is provided:

$$\text{Field Strength (dBuV/m)} = \text{Measured Voltage (dBuV)} + \text{Antenna Factor (dB/m)} + \text{Cable Loss (dB)} - \text{Preamp Gain (dB)}$$

$$36.5 \text{ dBuV} + 18.7 \text{ dB/m} + 0.6 \text{ dB} - 26.9 \text{ dB} = 28.9 \text{ dBuV/m}$$

MAINS CONDUCTED EMISSIONS

Where relevant, the following sample calculation is provided:

$$\text{Final Voltage (dBuV)} = \text{Measured Voltage (dBuV)} + \text{Cable Loss (dB)} + \text{Limiter Factor (dB)} + \text{LISN Insertion Loss.}$$

$$36.5 \text{ dBuV} + 0 \text{ dB} + 10.1 \text{ dB} + 0 \text{ dB} = 46.6 \text{ dBuV}$$

6. EQUIPMENT UNDER TEST

6.1. EUT DESCRIPTION

The Apple iPhone is a smartphone with multimedia functions (music, application support, and video), cellular GSM, GPRS, EGPRS, UMTS, LTE, 5G, IEEE 802.11a/b/g/n/ac/ax, Bluetooth, Ultra-Wideband, GPS, NFC and MSS. All models except reference model support at least one UICC based SIM. The second SIM is either an UICC based p-SIM (physical SIM) or e-SIM (electronic SIM). The device supports a built-in inductive charging transmitter and receiver. The rechargeable battery is not user accessible.

Testing was performed on the parent model and is used to support the application for the parent and variants identified in this report based on the test plan submitted and approved via KDB inquiry by the FCC and by ISED-Canada.

Parent Model: A2632, FCC ID: BCG-E8139A, IC: 579C-E8139A

Variant Models: A2885, FCC ID: BCG-E8146A, IC: 579C-E8146A
 A2886; FCC ID: BCG-E8147A, IC: 579C-E8147A
 A2887 & A2888, FCC ID: BCG-E8148A, IC: 579C-E8148A

6.2. MAXIMUM OUTPUT POWER

The transmitter has a maximum conducted output power as follows:

Frequency Range (MHz)	Mode	Output Power (dBm)	Output Power (mW)
1Tx 2412 - 2472	802.11b	21.23	132.74
	802.11g	Covered by 802.11n HT20 1TX	
	802.11n HT20	21.24	133.05
	802.11ax HE20	21.24	133.05
2Tx 2412 - 2472	802.11n HT20 CDD	24.25	266.07
	802.11g SDM/STBC	Covered by 802.11n HT20 2TX CDD	
	802.11ax HE20 OFDMA	24.24	265.46

6.3. DESCRIPTION OF AVAILABLE ANTENNAS

The antenna(s) gain, as provided by the manufacturer' are as follows:

Frequency Range (GHz)	ANT 4 (dBi)	ANT 3 (dBi)
2.4	-2.3	-1.9

6.4. SOFTWARE AND FIRMWARE

The EUT firmware installed during testing was Wi-Fi FW Version: 20_94_1_15.

6.5. WORST-CASE CONFIGURATION AND MODE

EUT was investigated in three orthogonal orientations X (Flatbed), Y (Landscape), and Z (Portrait) on ANT 4 (Core 0), ANT 3 (Core 1) and 2TX. It was determined that X (Flatbed) orientation was worst-case orientation for both ANT 4 and 2TX, and Z (Portrait) orientation for ANT 3.

Radiated band edge, harmonic, and spurious emissions from 1GHz to 18GHz were performed with the EUT set to transmit at highest power on Low/Middle/High channels.

Radiated emissions below 1GHz, 18-26GHz and power line conducted emissions were performed with the EUT transmits at the channel with the highest output power as worst-case scenario. There were no emissions found below 30MHz within 20dB of the limit.

For radiated harmonics spurious below 1GHz, 1-18GHz L/M/H channels, 18-26GHz, and power line conducted emissions were performed with the EUT set at the 2TX CDD mode among the CDD/SDM modes and 2TX HE mode with power setting equal or higher than SISO modes as worst-case scenario. G mode covered by HT20 mode since it has the same power as HT20.

Below 1GHz tests were performed with EUT connected to AC power adapter as the worst case; and for above 1GHz tests, the worst-case configuration reported was with EUT only. For AC line conducted emission, test was investigated with AC power adapter and with laptop.

With same power on Full RU and SU higher data rate, investigation was performed on both bandedge to determine the worst case, and SU mode was determined to be the worst case.

The output power and psd for the 802.11 ax mode were investigated among all different tones; SU mode turned out to have the highest output power and the lowest tone had the highest PSD readings.

Lowest data rate for each mode was used to conduct antenna port testing and radiated spurious emissions since it has the highest maximum power.

802.11b mode: 1 Mbps
802.11n HT20 mode: MCS0
802.11ax RU26 HE20 mode: MCS0
802.11ax HE20 SU mode: MCS0

However, for radiated bandedge, the following data rates were used as worst-case data rates:

802.11b mode: 1 Mbps
802.11n HT20 mode: MCS7
802.11ax HE20 RU26 mode: MCS9
802.11ax HE20 SU mode: MCS9

There are three vendors of the Wi-Fi/Bluetooth radio modules: variant 1, 2 and 3. The Wi-Fi/BT radio modules have the same mechanical outline (e.g., the same package dimension and pin-out layout), use the same on-board antenna matching circuit, have an identical antenna structure, and are built and tested to conform to the same specifications and to operate within the same tolerances.

Baseline testing was performed on the three variants to determine the worst case on all conducted power and radiated emissions.

6.6. DESCRIPTION OF TEST SETUP

SUPPORT TEST EQUIPMENT						
Description	Manufacturer	Model	Serial Number	FCC ID/ DoC		
Laptop	Apple	Macbook Pro	C02VD7SAHV22	BCGA1708		
Laptop AC/DC adapter	Liteon Technology	A1424	NSW25679	DoC		
EUT AC/DC adapter	Apple	A1720	C3D8417A7R93KVPA8	DoC		
I/O CABLES (RF CONDUCTED TEST)						
Cable No.	Port	# of Identical Ports	Connector Type	Cable Type	Cable Length (m)	Remarks
1	Antenna	1	SMA	Un-shielded	0.2	To spectrum Analyzer
2	USB	1	USB	Shielded	1.0	N/A
3	AC	1	AC	Un-shielded	2	N/A
I/O CABLES (RF RADIATED AND AC LINE CONDUCTED TEST)						
Cable No.	Port	# of Identical Ports	Connector Type	Cable Type	Cable Length (m)	Remarks
1	AC	1	AC	Un-shielded	2	N/A
2	USB	1	USB	shielded	1	N/A

TEST SETUP

The EUT setup is shown as below. Test software exercised the radio card.

SETUP DIAGRAM FOR CONDUCTED TESTS

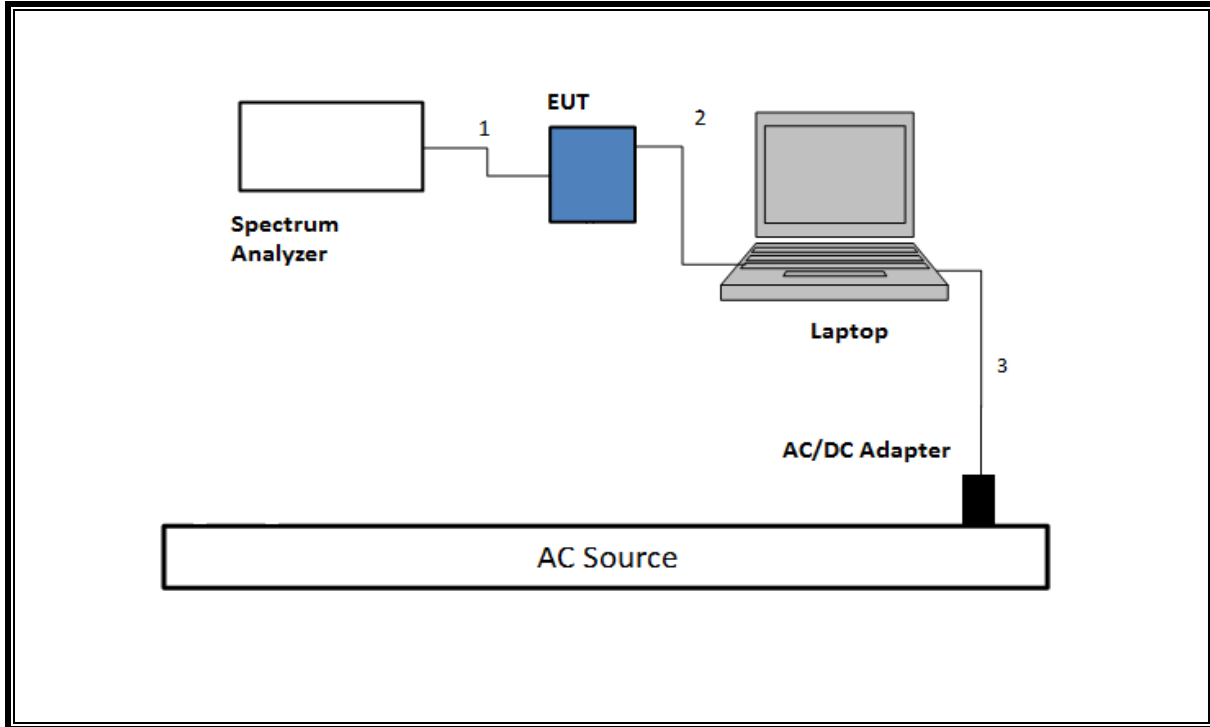

SETUP DIAGRAM FOR RADIATED TESTS Above 1 GHz

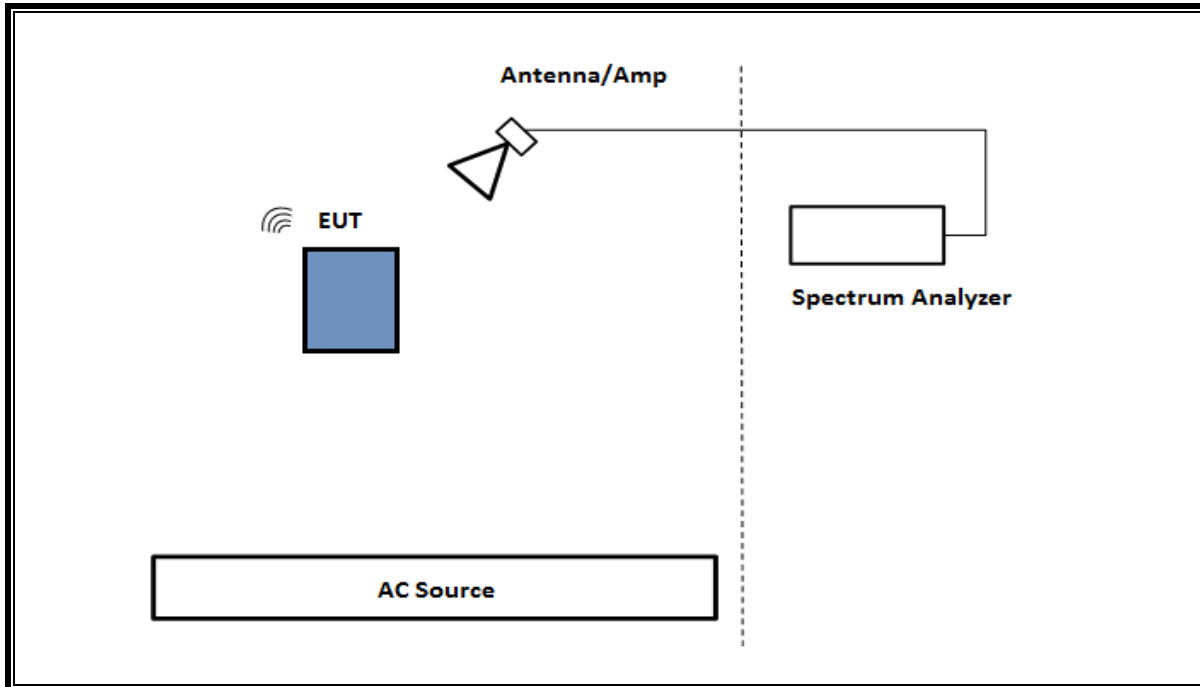

SETUP DIAGRAM FOR Below 1GHz and AC LINE CONDUCTED TEST

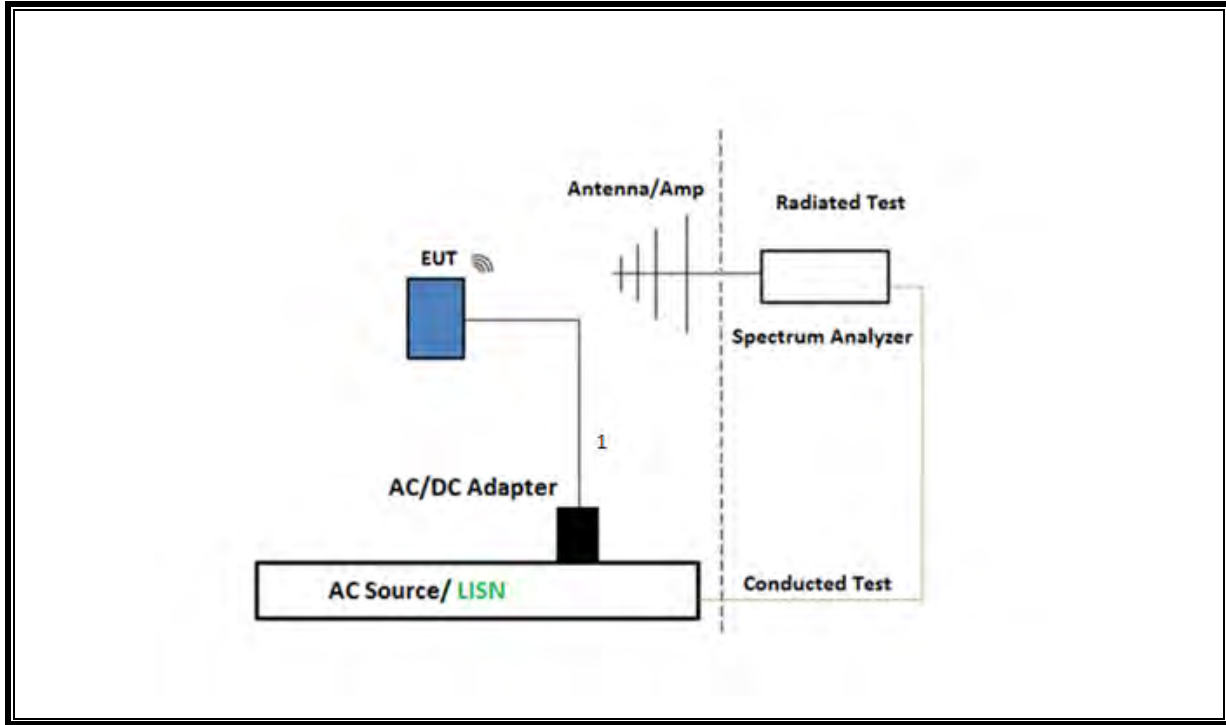

TEST SETUP- AC LINE CONDUCTED: LAPTOP CONFIGURATION

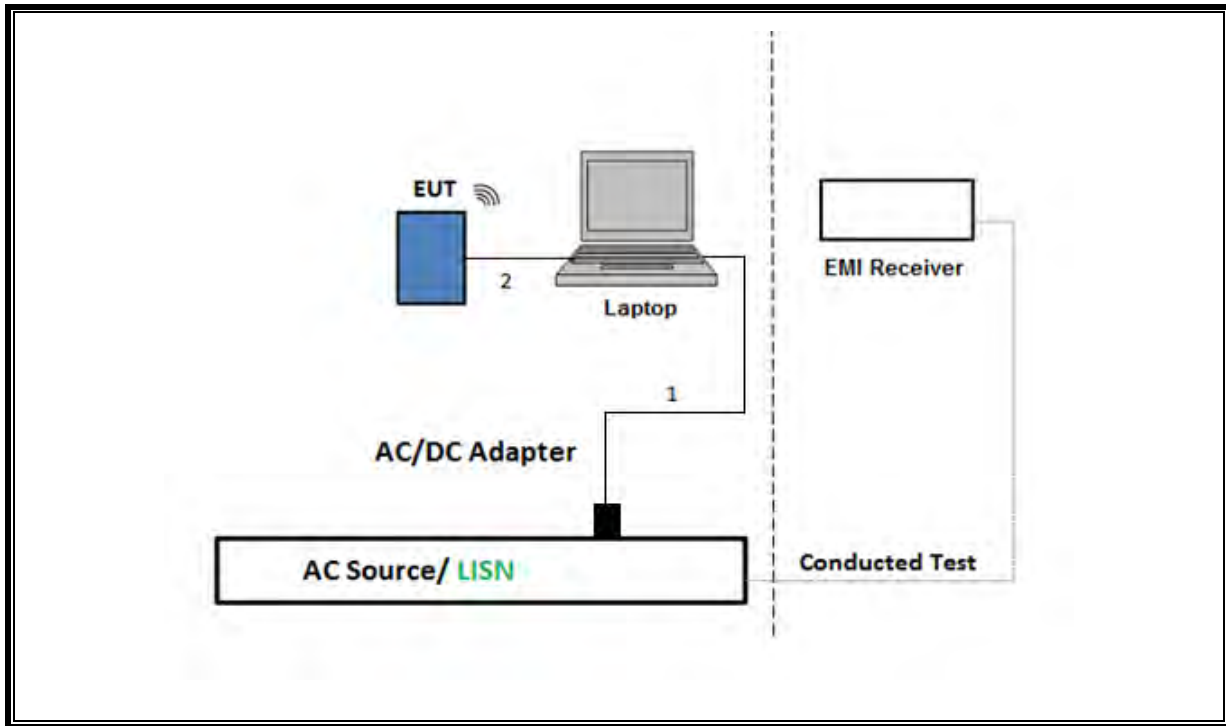

7. MEASUREMENT METHOD

Test Item	Test Method
6 dB BW	ANSI C63.10: 2013 Subclause 11.8.1 (Option 1)
99% BW	ANSI C63.10: 2013 Subclause 6.9.3
Output Power	ANSI C63.10: 2013 Subclause 11.9.2.3.2 (Method AVGPM-G: Measurement using a gated RF average power meter)
PSD	ANSI C63.10: 2013 Subclause 11.10.3 (Method AVGPSD-1) Subclause 11.10.5 (Method AVGPSD-2)
Conducted emissions in restricted frequency bands	ANSI C63.10: 2013 Subclause 11.12.2 (Antenna-port measurements)
Radiated emissions non-restricted frequency bands	ANSI C63.10: 2013 Subclause 11.11 & Clause 13
Radiated emissions restricted frequency bands	ANSI C63.10: 2013 Subclause 11.12.1 & Clause 13
Radiated Band-edge	ANSI C63.10: 2013 <ul style="list-style-type: none"> • Subclause 11.13.3.2 Peak Detection • Subclause 11.13.3.3 Trace averaging with continuous EUT transmission at full power • Subclause 11.13.3.4 Trace averaging across ON and OFF times of the EUT transmissions followed by duty cycle correction
Radiated Spurious Emissions Below 30MHz	ANSI C63.10: 2013 Subclause 6.4 & Clause 13
AC Power Line Conducted Emissions	ANSI C63.10: 2013 Subclause 6.2

8. TEST AND MEASUREMENT EQUIPMENT

The following test and measurement equipment was utilized for the tests documented in this report:

TEST EQUIPMENT LIST					
Description	Manufacturer	Model	ID Num	Cal Due	Last Cal
Antenna, Horn 1-18GHz	ETS Lindgren	3117	200897	02/24/2023	02/24/2022
Spectrum Analyzer, PXA 3Hz to 44GHz	Keysight	N9030A	125188	01/30/2023	01/30/2022
RF Filter Box 1-18GHz	UL-FR1	NA	PRE0183530	11/17/2022	02/24/2022
Spectrum Analyzer, PSA, 3Hz to 44GHz	Agilent (Keysight) Technologies	E4446A	81450	02/02/2023	02/02/2022
Power Meter, P-series single channel	Keysight	N1911A	T1271	01/24/2023	01/24/2022
*Power Sensor	Keysight	N1921A	T1228	06/17/2022	06/17/2021
Antenna, Horn 1-18GHz	ETS-Lindgren	3117	81887	03/16/2023	03/16/2022
RF Filter Box 1-18GHz	UL-FR	NA	171389	11/01/2022	11/01/2021
EMI Test Receiver	Rohde & Schwarz	ESW44	201497	02/18/2023	02/18/2022
Antenna, Broadband Hybrid, 30MHz to 2000MHz	Sunol Sciences	JB3	204044	01/31/2023	01/31/2022
Antenna, Horn 1-18GHz	ETS-Lindgren	3117	206807	02/09/2023	02/09/2022
RF Filter Box	UL-FR1	NA	173233	10/23/2022	10/23/2021
EMI Receiver	Rohde & Schwarz	ESW44	201500	02/17/2023	02/17/2022
*Amplifier 10KHz to 1GHz 32dB	Sonoma	310N	79145	07/21/2022	07/21/2021
Spectrum Analyzer, PXA 3Hz to 44GHz	Keysight	N9030A	125179	02/01/2023	02/01/2022
*Antenna Horn 18 to 26.5GHz	ARA	MWH-1826/B	81140	04/22/2022	04/22/2021
Antenna, Horn 1-18GHz	ETS-Lindgren	3117	200895	10/13/2022	10/13/2021
RF Filter 1-18GHz	UL-FR1	SAC 6 port rf box	203957	02/12/2023	02/12/2022
EMI Receiver	Rohde & Schwarz	ESW44	201498	02/20/2023	02/20/2022
Antenna, Horn 1-18GHz	ETS-Lindgren	3117	41112	09/21/2022	09/21/2021
RF Filter Box 1-18GHz	UL-FR1	SAC 6 Port rf Box	203984	02/12/2023	04/07/2022
*Pre-Amp 18-26GHz	Agilent Technology	8449B	T404	04/19/2022	04/19/2021
Antenna, Active Loop 9KHz to 30MHz	EMCO	6502	T35	10/05/2022	10/05/2021
*Spectrum Analyzer, PXA, 3Hz to 44GHz	Agilent (Keysight) Technologies	N9030A	T459	02/11/2022	02/11/2021
Antenna, Horn 1-18GHz	ETS Lindgren	3117	200786	02/24/2023	02/24/2022
Antenna	ETS-Lindgren	3117	206806	09/22/2022	09/22/2021
RF Filter Box, 1-18GHz	UL-FR1	N/A	171875	01/15/2023	01/15/2022
EMI Test Receiver	Rohde & Schwarz	ESW44	201501	02/19/2023	02/19/2022
*RF Filter Box 1-18GHz	UL-FR1	NA	168535	06/26/2022	06/26/2021
Spectrum Analyzer, PXA 3Hz to 44GHz	Keysight	N9030A	206415	03/17/2023	03/17/2022
Antenna, Horn 1-18GHz	ETS-Lindgren	3117	200785	10/13/2022	10/13/2021
RF Filter Box, 1-18GHz	UL-FR1	NA	207182	02/11/2023	02/11/2022
EMI Receiver	Rohde & Schwarz	ESW44	201499	02/17/2023	02/17/2022

*Testing is completed before equipment expiration date.

AC Line Conducted					
EMI Test Receiver 9kHz-7GHz	Rohde & Schwarz	ESR	T1436	02/21/2023	02/21/2022
Power Cable, Line Conducted Emissions	UL	PR1	T861	10/27/2022	10/27/2021
LISN for Conducted Emissions CISPR-16	FISCHER CUSTOM COMMUNICATIONS	FCC-LISN-50/250-25-2-01-480V	175765	01/26/2023	01/26/2022
UL AUTOMATION SOFTWARE					
Radiated Software	UL	UL EMC	Ver 9.5, Mar 6, 2020		
Conducted Software	UL	UL EMC	2020.2.26		
AC Line Conducted Software	UL	UL EMC	Ver 9.5, February 21, 2020		

9. ANTENNA PORT TEST RESULTS

9.1. ON TIME AND DUTY CYCLE

LIMITS

None; for reporting purposes only.

PROCEDURE

KDB 558074 Zero-Span Spectrum Analyzer Method.

Test Engineer:	26118
Test Date:	5/19/2022 – 7/5/2022

ON TIME AND DUTY CYCLE RESULTS

Mode	ON Time B (msec)	Period (msec)	Duty Cycle x (linear)	Duty Cycle (%)	Duty Cycle Correction Factor (dB)	1/B Minimum VBW (kHz)
2.4GHz Band						
802.11b 1TX	1.000	1.000	1.000	100.00%	0.00	0.010
802.11n HT20, MCS 0	0.982	1.004	0.978	97.81%	0.10	1.018
802.11n HT20, MCS 7	0.228	0.248	0.919	91.92%	0.37	4.394
802.11ax HE20 26T, MCS0	3.975	4.055	0.980	98.03%	0.00	0.010
802.11ax HE20 26T, MCS9	0.350	0.392	0.893	89.29%	0.49	2.857
802.11ax HE20 SU, MCS0	1.487	1.507	0.987	98.67%	0.00	0.010
802.11ax HE20 SU, MCS9	0.168	0.189	0.888	88.80%	0.52	5.958

Duty cycle for 2TX is the same as 1TX.

DUTY CYCLE PLOTS

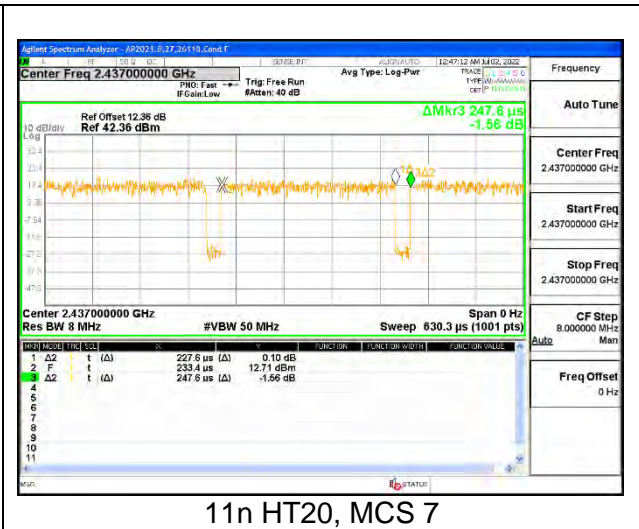
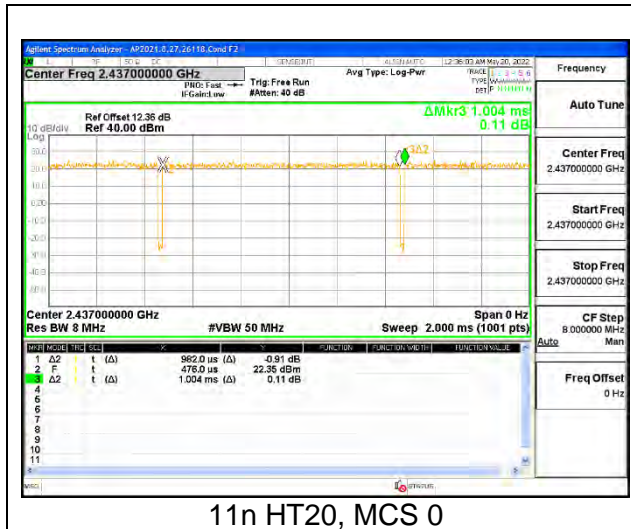
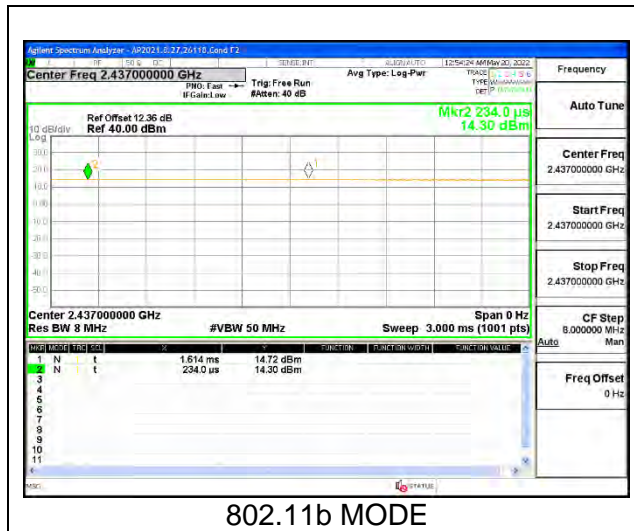



11ax HE20 26T, MCS0



11ax HE20 26, MCS9



11ax HE20 SU Mode, MCS0



11ax HE20 SU Mode, MCS9

9.2. 99% BANDWIDTH

LIMITS

None; for reporting purposes only.

RESULTS

Only Mid channel plot is reported to show analyzer settings.

9.2.1. 802.11b MODE 1TX

1TX ANT 4 MODE

Channel	Frequency (MHz)	99% Bandwidth (MHz)
Low 1	2412	12.787
Mid 6	2437	12.783
High 11	2462	12.834
High 12	2467	12.853
High 13	2472	12.618

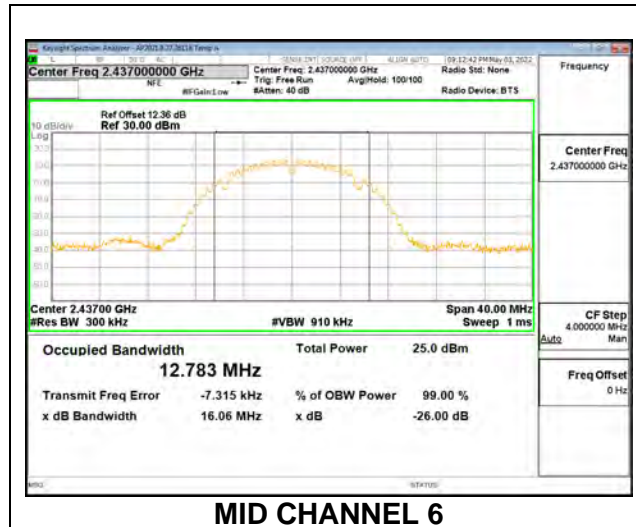

1TX ANT 3 MODE

Channel	Frequency (MHz)	99% Bandwidth (MHz)
Low 1	2412	12.746
Mid 6	2437	12.789
High 11	2462	12.828
High 12	2467	12.818
High 13	2472	12.704

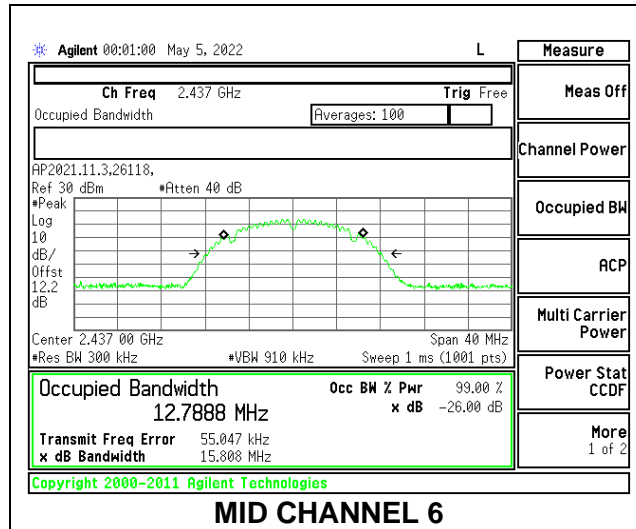

9.2.2. 802.11n HT20 MODE 1TX

1TX ANT 4 MODE

Channel	Frequency (MHz)	99% Bandwidth (MHz)
Low 1	2412	17.726
Low 2	2417	17.622
Mid 6	2437	17.688
High 10	2457	17.793
High 11	2462	17.661
High 12	2467	17.632
High 13	2472	17.615

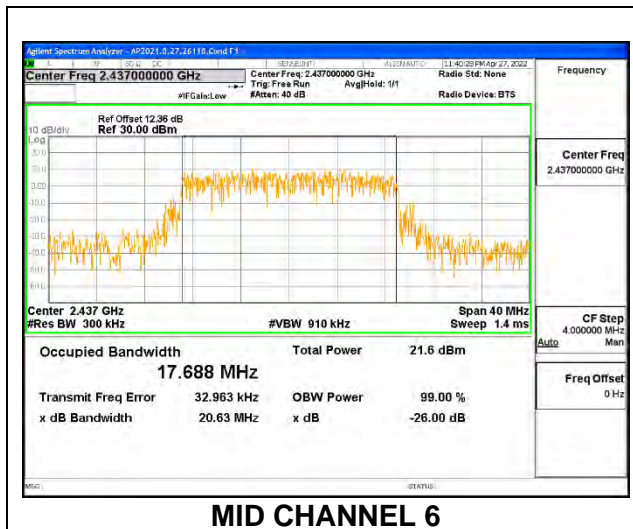

1TX ANT 3 MODE

Channel	Frequency (MHz)	99% Bandwidth (MHz)
Low 1	2412	17.837
Low 2	2417	17.842
Mid 6	2437	17.758
High 10	2457	17.807
High 11	2462	17.851
High 12	2467	17.868
High 13	2472	17.645

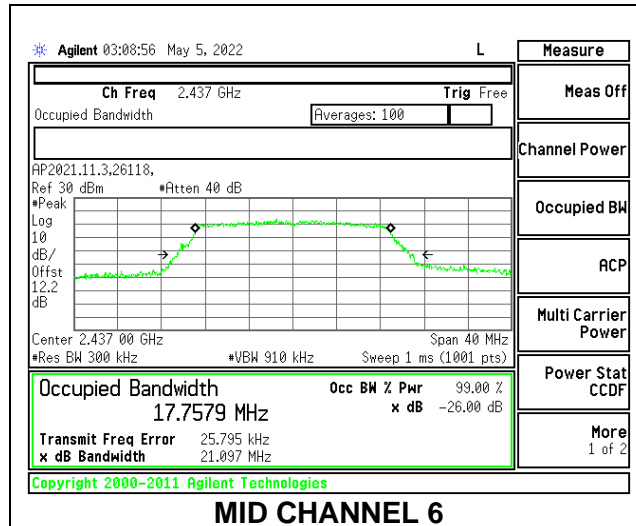

9.2.3. 802.11n HT20 CDD MODE 2TX

ANT 4 + ANT 3 2TX MODE

Channel	Frequency (MHz)	99% Bandwidth (MHz) ANT 4	99% Bandwidth (MHz) ANT 3
Low 1	2412	17.861	17.729
Low 2	2417	17.806	17.708
Low 3	2422	17.837	17.806
Mid 6	2437	17.848	17.756
High 9	2452	17.848	17.791
High 10	2457	17.880	17.799
High 11	2462	17.798	17.781
High 12	2467	17.890	17.846
High 13	2472	17.637	17.656

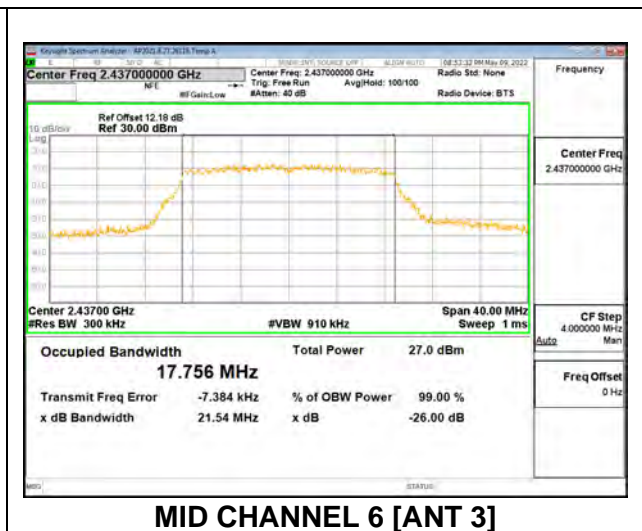
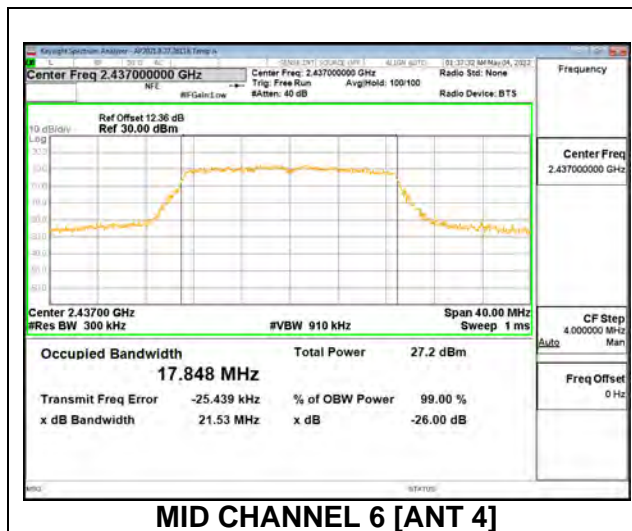

9.2.4. 802.11ax HE20 MODE 1TX

ANT 4 SISO MODE: 26-Tones, RU index 0

Channel	Frequency (MHz)	99% Bandwidth (MHz)
Low 1	2412	18.424
Mid 6	2437	18.386
High 11	2462	18.380
High 12	2467	18.448
High 13	2472	18.381

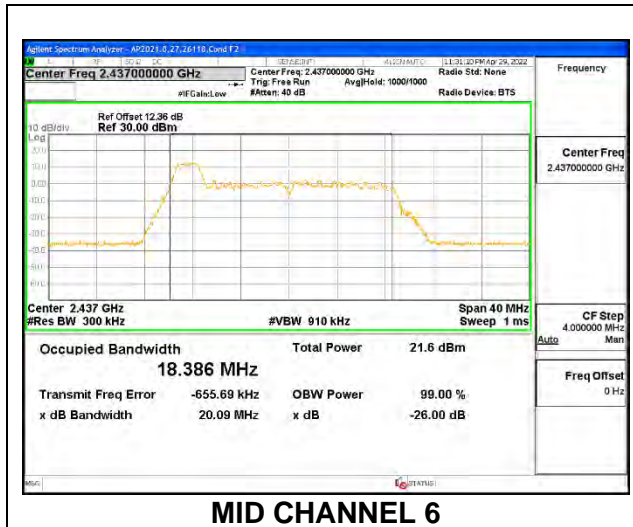

ANT 4 SISO MODE: 26-Tones, RU Index 4

Channel	Frequency (MHz)	99% Bandwidth (MHz)
Low 1	2412	17.135
Mid 6	2437	16.919
High 11	2462	16.918
High 12	2467	17.118
High 13	2472	17.071

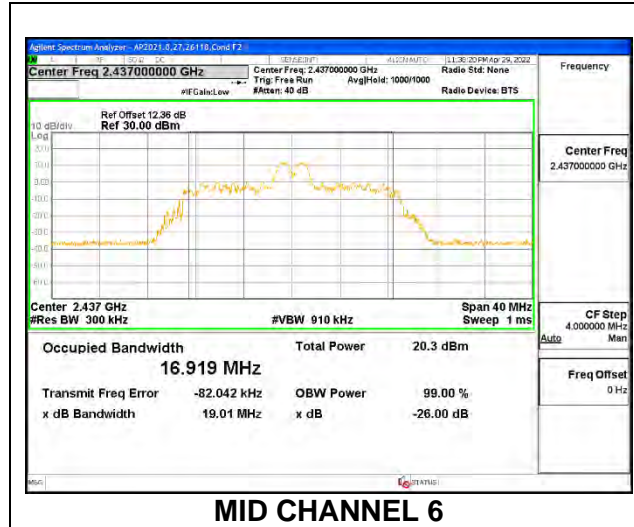

ANT 4 SISO MODE: 26-Tones, RU Index 8

Channel	Frequency (MHz)	99% Bandwidth (MHz)
Low 1	2412	18.655
Mid 6	2437	18.680
High 11	2462	18.587
High 12	2467	18.684
High 13	2472	18.820

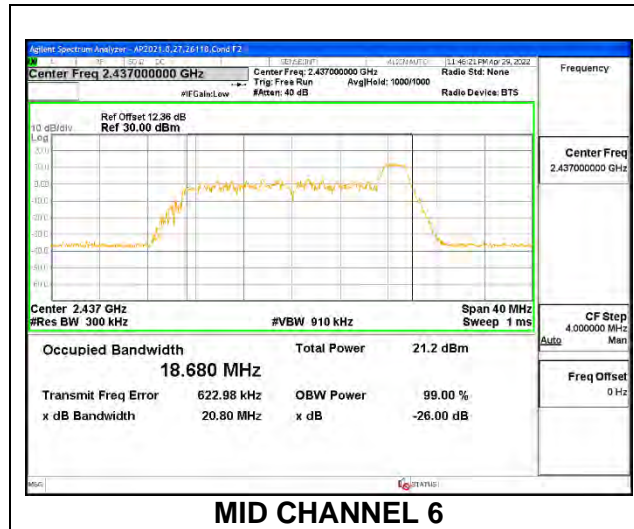

ANT 4 SISO MODE: SU Mode

Channel	Frequency (MHz)	99% Bandwidth (MHz)
Low 1	2412	19.022
Low 2	2417	18.945
Low 3	2422	18.938
Mid 6	2437	18.553
High 9	2452	18.770
High 10	2457	18.814
High 11	2462	19.010
High 12	2467	18.821
High 13	2472	18.785

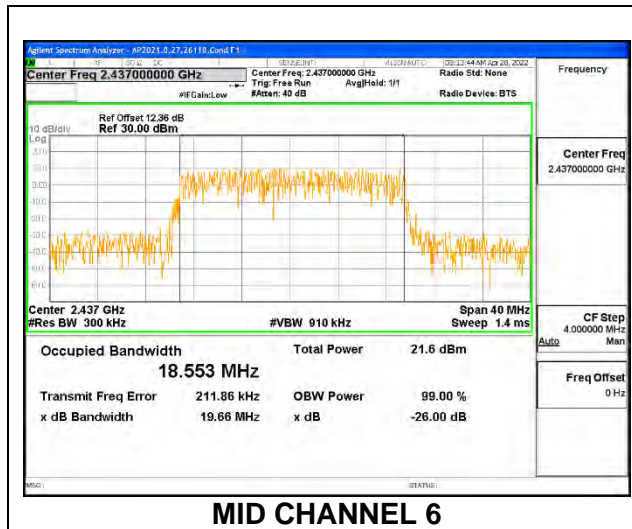

ANT 3 SISO MODE: 26-Tones, RU Index 0

Channel	Frequency (MHz)	99% Bandwidth (MHz)
Low 1	2412	18.456
Mid 6	2437	18.337
High 11	2462	18.325
High 12	2467	18.297
High 13	2472	18.260

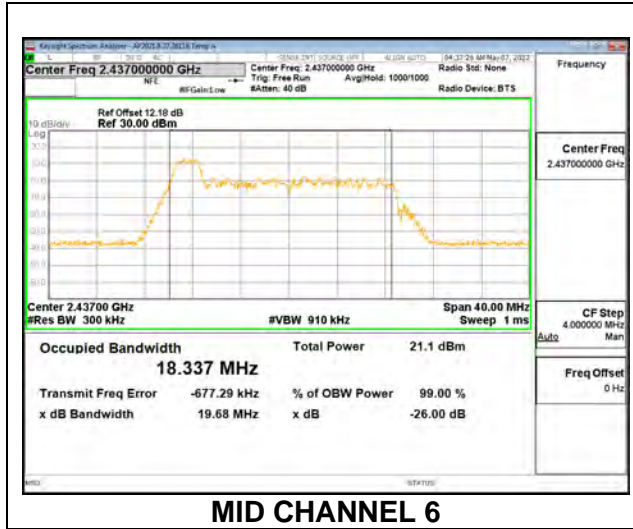

ANT 3 SISO MODE: 26-Tones, RU Index 4

Channel	Frequency (MHz)	99% Bandwidth (MHz)
Low 1	2412	16.883
Mid 6	2437	16.949
High 11	2462	16.696
High 12	2467	16.975
High 13	2472	17.009

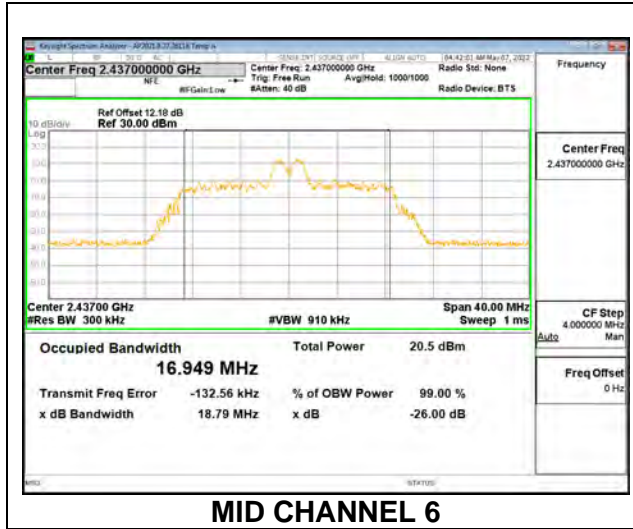

ANT 3 SISO MODE: 26-Tones, RU Index 8

Channel	Frequency (MHz)	99% Bandwidth (MHz)
Low 1	2412	18.586
Mid 6	2437	18.550
High 11	2462	18.655
High 12	2467	18.794
High 13	2472	18.863

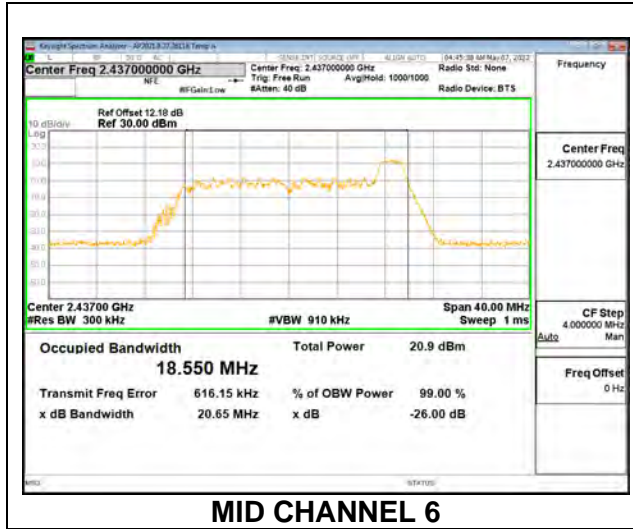

ANT 3 SISO MODE: SU Mode

Channel	Frequency (MHz)	99% Bandwidth (MHz)
Low 1	2412	18.946
Low 2	2417	18.891
Low 3	2422	18.965
Mid 6	2437	18.977
High 9	2452	19.017
High 10	2457	18.962
High 11	2462	18.948
High 12	2467	18.916
High 13	2472	18.872

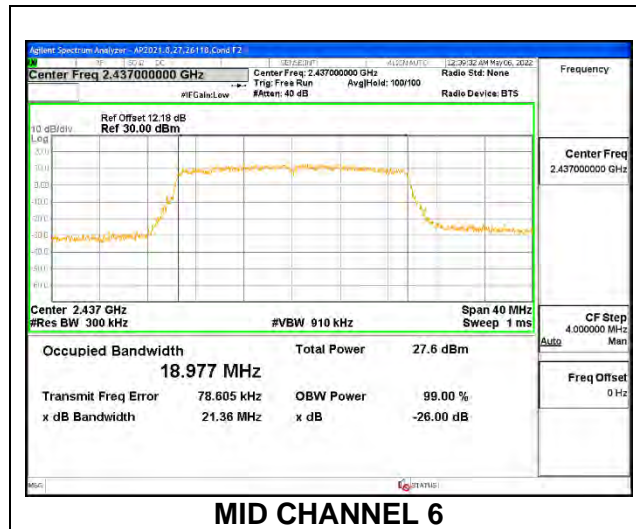

9.2.5. 802.11ax HE20 OFDMA MODE 2TX

ANT 4 + ANT 3 2TX MODE: 26-Tones, RU Index 0

Channel	Frequency (MHz)	99% Bandwidth (MHz) ANT 4	99% Bandwidth (MHz) ANT 3
Low 1	2412	18.506	18.385
Mid 6	2437	18.420	18.364
High 11	2462	17.428	18.228
High 12	2467	17.877	18.207
High 13	2472	17.558	18.227

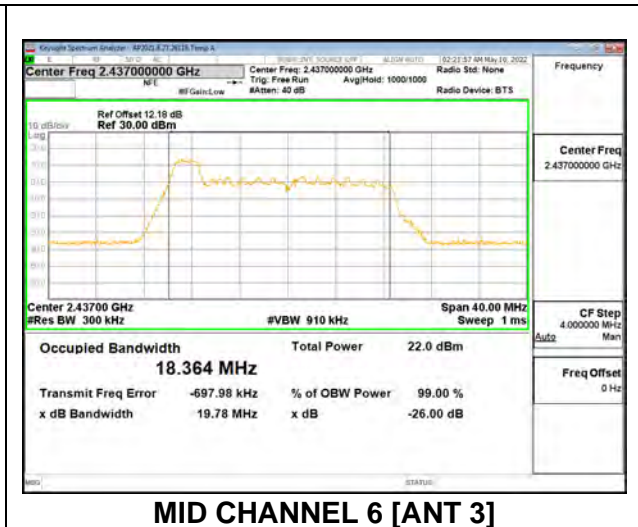
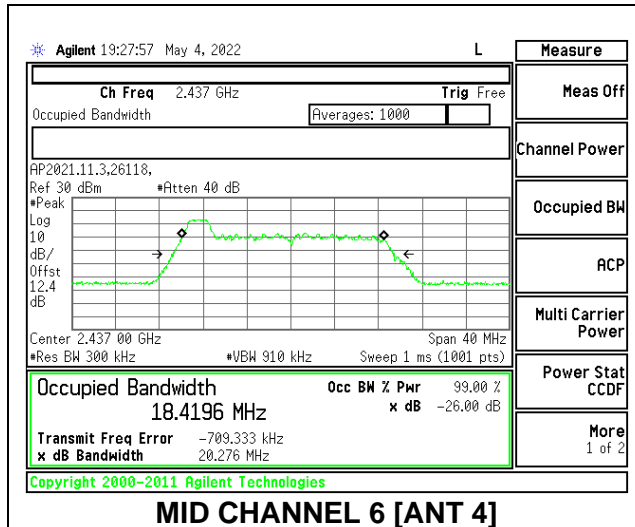

ANT 4 + ANT 3 2TX MODE: 26-Tones, RU Index 4

Channel	Frequency (MHz)	99% Bandwidth (MHz) ANT 4	99% Bandwidth (MHz) ANT 3
Low 1	2412	17.197	16.393
Mid 6	2437	16.678	16.687
High 11	2462	18.383	16.724
High 12	2467	17.210	16.755
High 13	2472	16.985	16.687

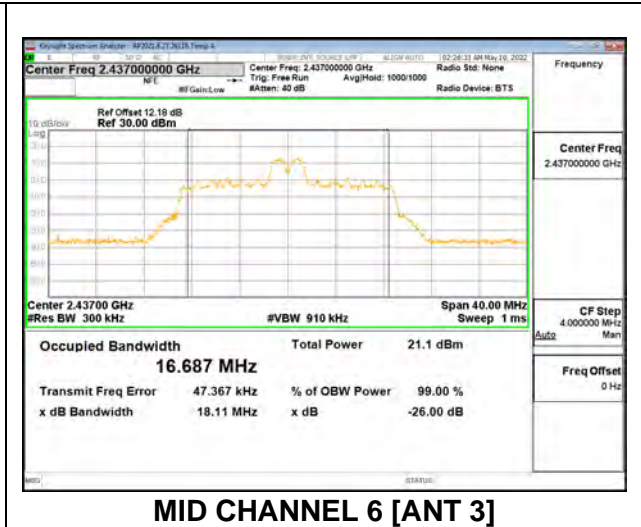
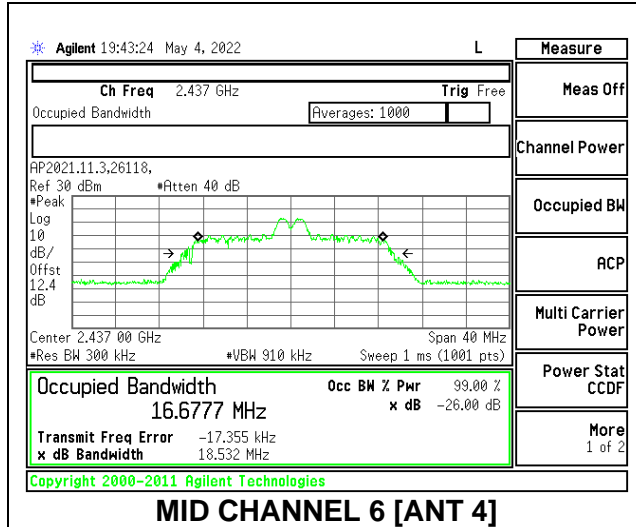

ANT 4 + ANT 3 2TX MODE: 26-Tones, RU Index 8

Channel	Frequency (MHz)	99% Bandwidth (MHz) ANT 4	99% Bandwidth (MHz) ANT 3
Low 1	2412	18.624	18.174
Mid 6	2437	18.608	18.323
High 11	2462	18.744	18.460
High 12	2467	18.757	18.427
High 13	2472	18.119	18.518

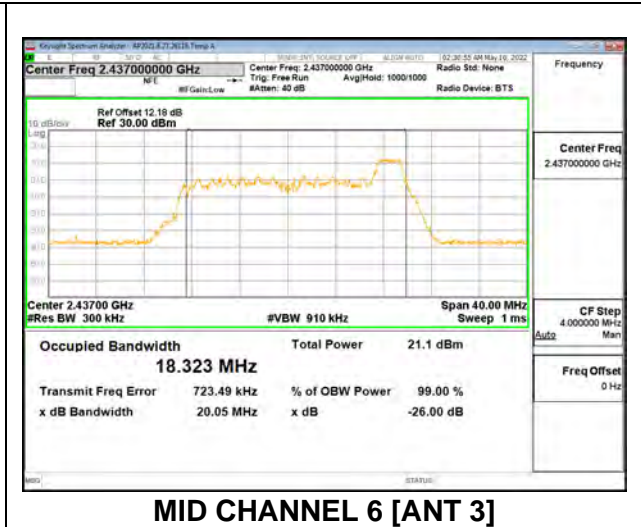
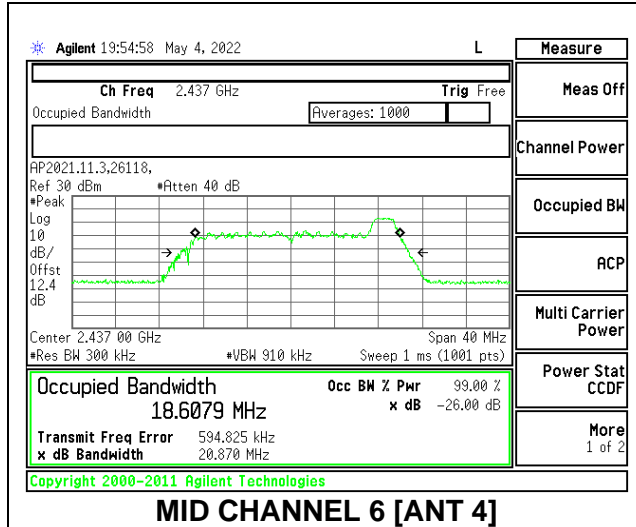

9.3. 6dB BANDWIDTH

LIMITS

FCC §15.247 (a) (2)

RSS-247 5.2 (a)

The minimum 6 dB bandwidth shall be at least 500 kHz.

RESULTS

The 6dB bandwidth was measured for the narrowest bandwidth mode, b Mode and ax HE20 Mode 26-Tone as worst case to demonstrate compliance with the minimum required bandwidth of 500 kHz to cover all OFDMA modes.

Only Mid channel plot is reported to show analyzer setting.

9.3.1. 802.11b MODE 1TX

1TX ANT 4 MODE

Channel	Frequency (MHz)	6dB Bandwidth (MHz)	Minimum Limit (MHz)
Low 1	2412	8.64	0.5
Mid 6	2437	8.16	0.5
High 11	2462	7.92	0.5
High 12	2467	7.80	0.5
High 13	2472	8.60	0.5

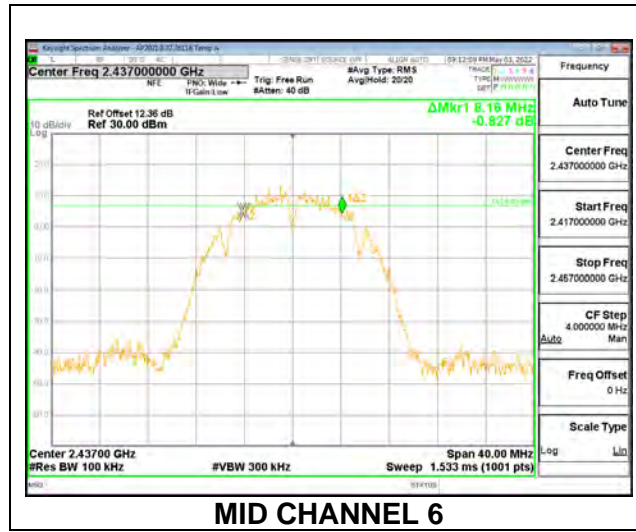

1TX ANT 3 MODE

Channel	Frequency (MHz)	6dB Bandwidth (MHz)	Minimum Limit (MHz)
Low 1	2412	8.20	0.5
Mid 6	2437	7.20	0.5
High 11	2462	7.12	0.5
High 12	2467	8.08	0.5
High 13	2472	8.64	0.5

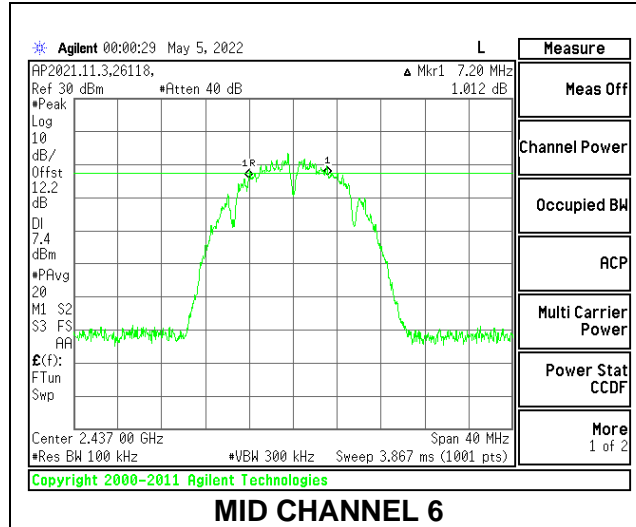

9.3.2. 802.11n HT20 MODE 1TX

1TX ANT 4 MODE

Channel	Frequency (MHz)	6dB Bandwidth (MHz)	Minimum Limit (MHz)
Low 1	2412	17.72	0.5
Low 2	2417	16.80	0.5
Mid 6	2437	17.64	0.5
High 10	2457	17.48	0.5
High 11	2462	16.96	0.5
High 12	2467	17.68	0.5
High 13	2472	17.44	0.5

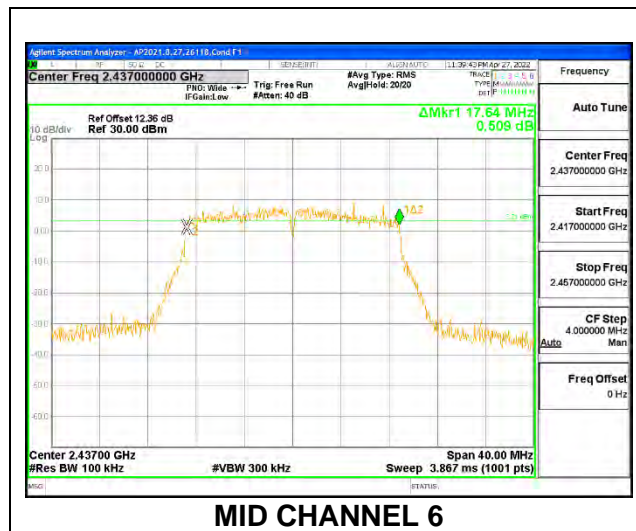

1TX ANT 3 MODE

Channel	Frequency (MHz)	6dB Bandwidth (MHz)	Minimum Limit (MHz)
Low 1	2412	17.72	0.5
Low 2	2417	17.00	0.5
Mid 6	2437	17.72	0.5
High 10	2457	17.80	0.5
High 11	2462	17.72	0.5
High 12	2467	16.64	0.5
High 13	2472	17.68	0.5

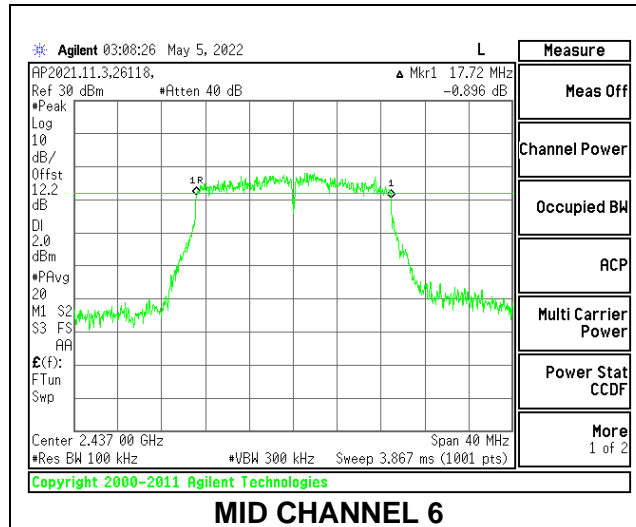

9.3.3. 802.11n HT20 CDD MODE 2TX

ANT 4 + ANT 3

Channel	Frequency (MHz)	6dB Bandwidth (MHz) ANT 4	6dB Bandwidth (MHz) ANT 3	Minimum Limit (MHz)
Low 1	2412	17.64	17.68	0.5
Low 2	2417	17.64	17.00	0.5
Low 3	2422	17.64	17.64	0.5
Mid 6	2437	17.68	17.68	0.5
High 9	2452	17.64	16.96	0.5
High 10	2457	17.28	17.72	0.5
High 11	2462	17.64	17.04	0.5
High 12	2467	17.68	17.72	0.5
High 13	2472	17.36	17.24	0.5

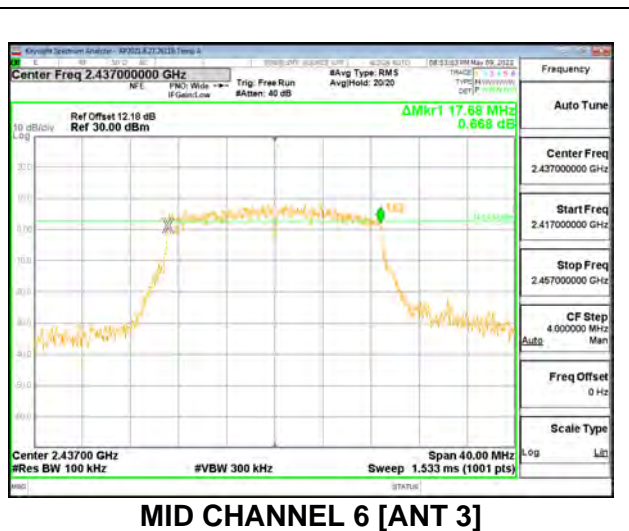
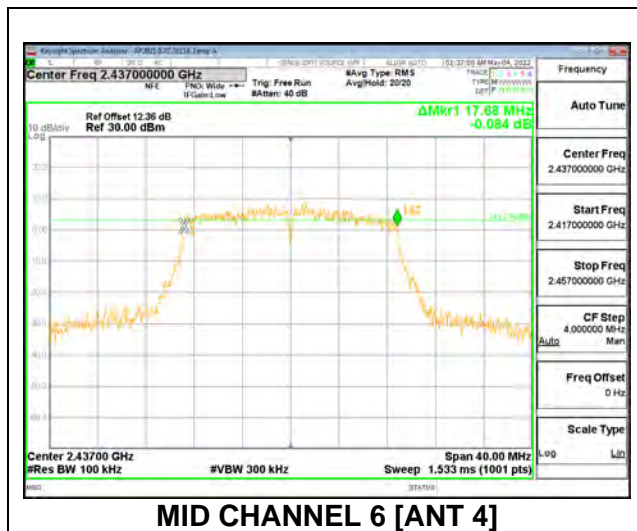

9.3.4. 802.11ax HE20 MODE 1TX

ANT 4 SISO MODE: 26-Tones, RU index 0

Channel	Frequency (MHz)	6dB Bandwidth (MHz)	Minimum Limit (MHz)
Low 1	2412	2.08	0.5
Mid 6	2437	2.12	0.5
High 11	2462	2.12	0.5
High 12	2467	2.12	0.5
High 13	2472	2.12	0.5

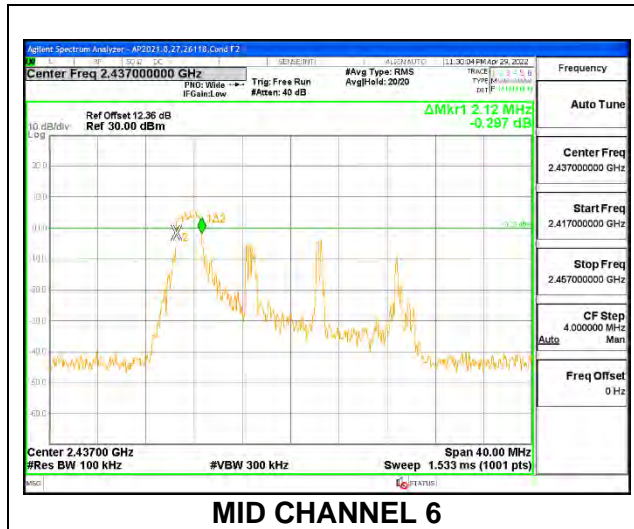

ANT 4 SISO MODE: 26-Tones, RU Index 4

Channel	Frequency (MHz)	6dB Bandwidth (MHz)	Minimum Limit (MHz)
Low 1	2412	2.68	0.5
Mid 6	2437	2.68	0.5
High 11	2462	2.68	0.5
High 12	2467	2.60	0.5
High 13	2472	2.76	0.5

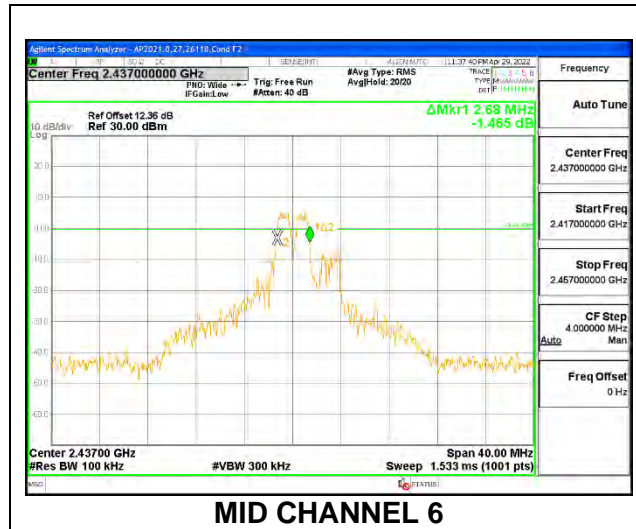

ANT 4 SISO MODE: 26-Tones, RU Index 8

Channel	Frequency (MHz)	6dB Bandwidth (MHz)	Minimum Limit (MHz)
Low 1	2412	2.12	0.5
Mid 6	2437	2.24	0.5
High 11	2462	2.08	0.5
High 12	2467	2.12	0.5
High 13	2472	2.00	0.5

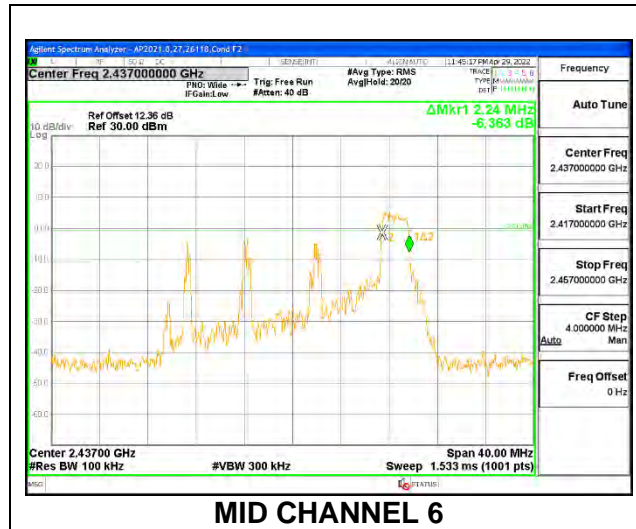

ANT 4 SISO MODE: SU Mode

Channel	Frequency (MHz)	6dB Bandwidth (MHz)	Minimum Limit (MHz)
Low 1	2412	18.32	0.5
Low 2	2417	17.92	0.5
Low 3	2422	18.56	0.5
Mid 6	2437	18.88	0.5
High 9	2452	18.92	0.5
High 10	2457	18.28	0.5
High 11	2462	18.96	0.5
High 12	2467	18.00	0.5
High 13	2472	18.60	0.5

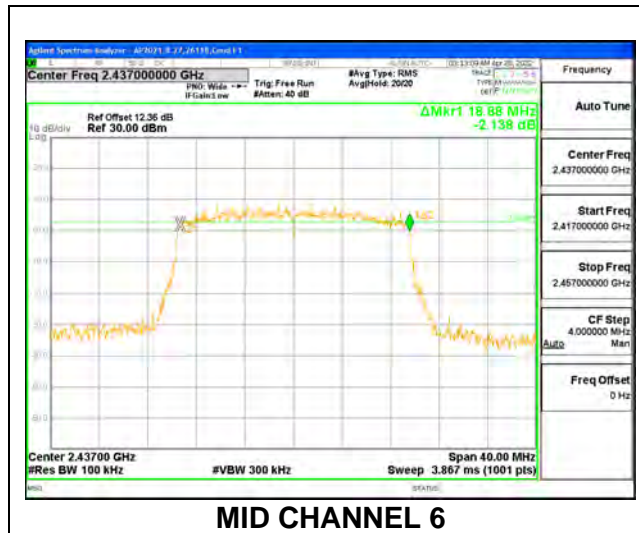

ANT 3 SISO MODE: 26-Tones, RU Index 0

Channel	Frequency (MHz)	6dB Bandwidth (MHz)	Minimum Limit (MHz)
Low 1	2412	2.08	0.5
Mid 6	2437	2.16	0.5
High 11	2462	2.12	0.5
High 12	2467	2.12	0.5
High 13	2472	2.08	0.5

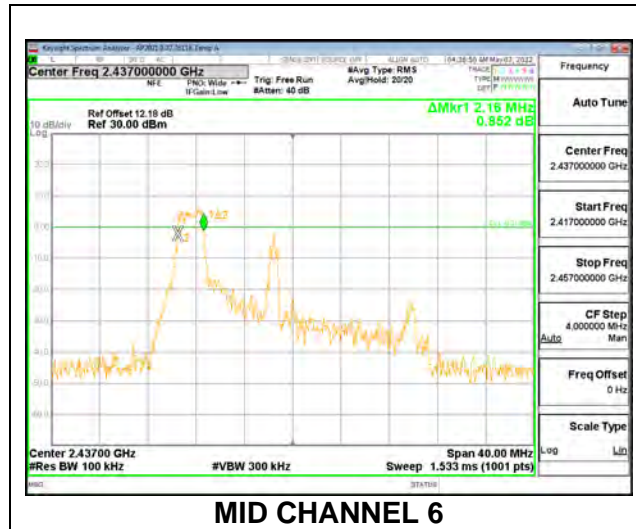

ANT 3 SISO MODE: 26-Tones, RU Index 4

Channel	Frequency (MHz)	6dB Bandwidth (MHz)	Minimum Limit (MHz)
Low 1	2412	2.64	0.5
Mid 6	2437	2.68	0.5
High 11	2462	2.68	0.5
High 12	2467	2.60	0.5
High 13	2472	2.72	0.5

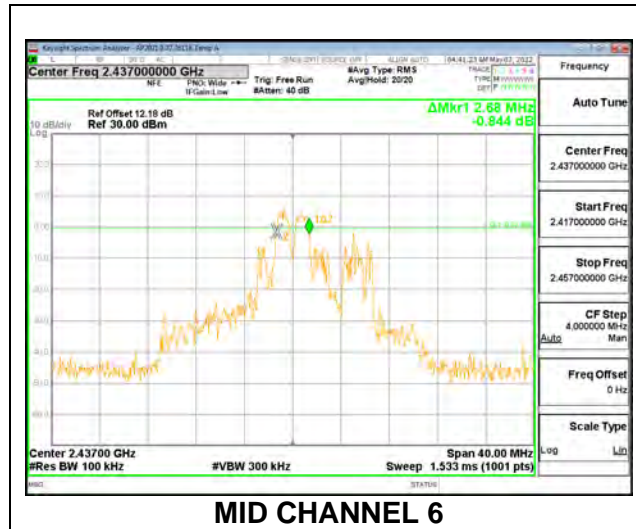

ANT 3 SISO MODE: 26-Tones, RU Index 8

Channel	Frequency (MHz)	6dB Bandwidth (MHz)	Minimum Limit (MHz)
Low 1	2412	2.16	0.5
Mid 6	2437	2.08	0.5
High 11	2462	2.12	0.5
High 12	2467	2.12	0.5
High 13	2472	2.12	0.5

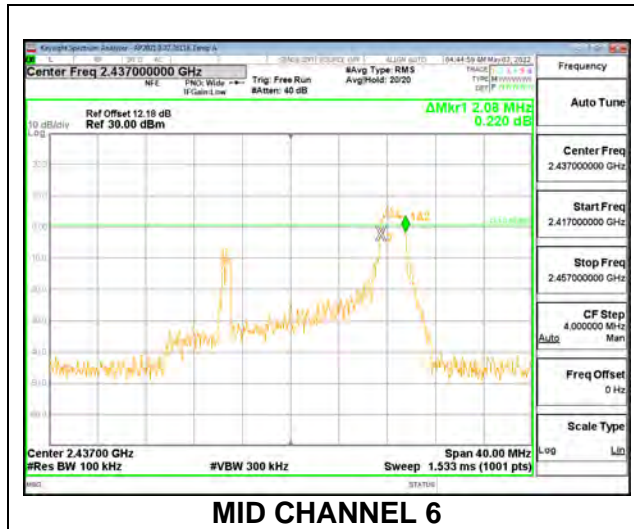

ANT 3 SISO MODE: SU Mode

Channel	Frequency (MHz)	6dB Bandwidth (MHz)	Minimum Limit (MHz)
Low 1	2412	19.12	0.5
Low 2	2417	18.20	0.5
Low 3	2422	17.92	0.5
Mid 6	2437	18.48	0.5
High 9	2452	18.48	0.5
High 10	2457	17.64	0.5
High 11	2462	18.44	0.5
High 12	2467	18.88	0.5
High 13	2472	18.80	0.5

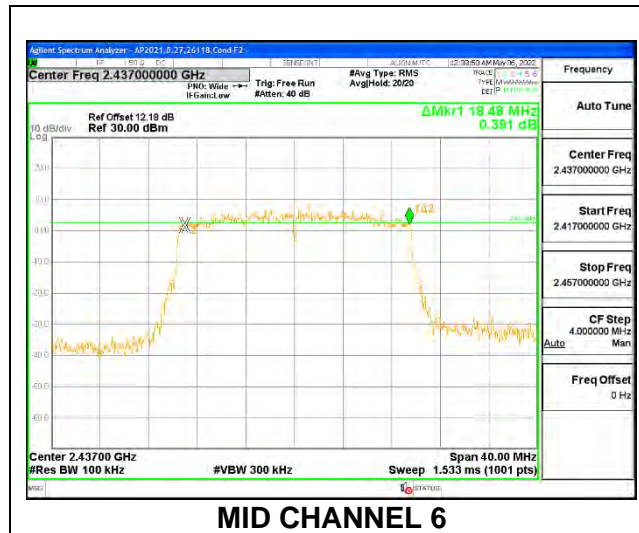

9.3.5. 802.11ax HE20 OFDMA MODE 2TX

ANT 4 + ANT 3 2TX MODE: 26-Tones, RU Index 0

Channel	Frequency (MHz)	6dB Bandwidth (MHz) ANT 4	6dB Bandwidth (MHz) ANT 3	Minimum Limit (MHz)
Low 1	2412	2.16	2.16	0.5
Mid 6	2437	2.12	2.20	0.5
High 11	2462	2.12	2.12	0.5
High 12	2467	2.12	2.16	0.5
High 13	2472	2.12	2.08	0.5

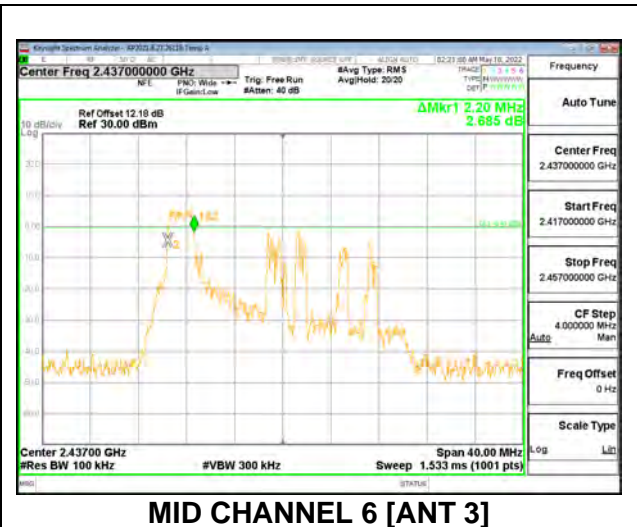
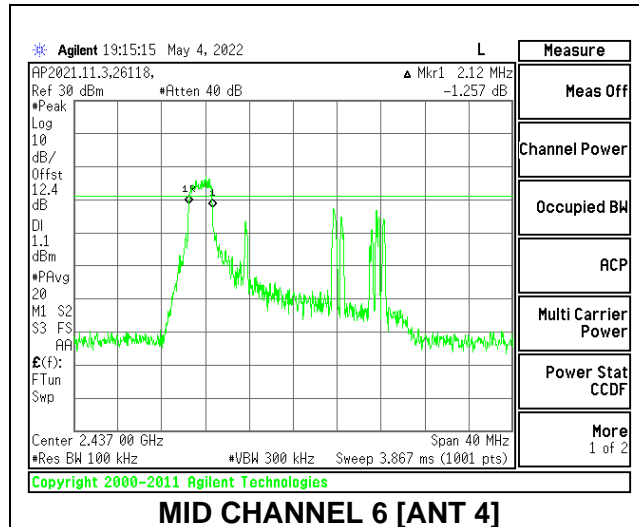

ANT 4 + ANT 3 2TX MODE: 26-Tones, RU Index 4

Channel	Frequency (MHz)	6dB Bandwidth (MHz) ANT 4	6dB Bandwidth (MHz) ANT 3	Minimum Limit (MHz)
Low 1	2412	2.68	2.64	0.5
Mid 6	2437	2.64	2.68	0.5
High 11	2462	2.68	2.68	0.5
High 12	2467	2.64	2.68	0.5
High 13	2472	2.72	2.68	0.5

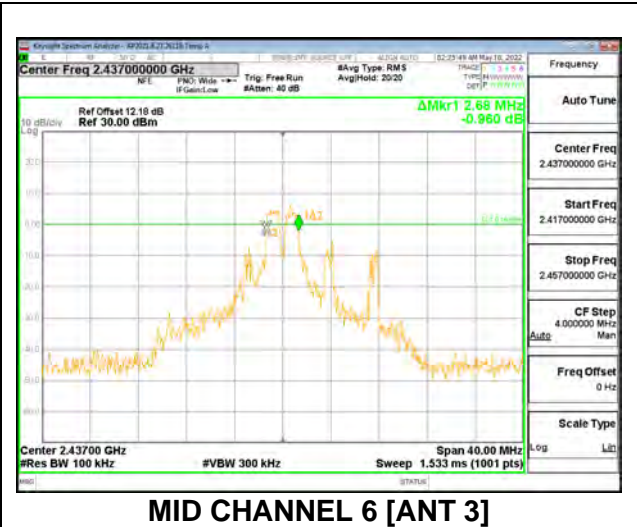
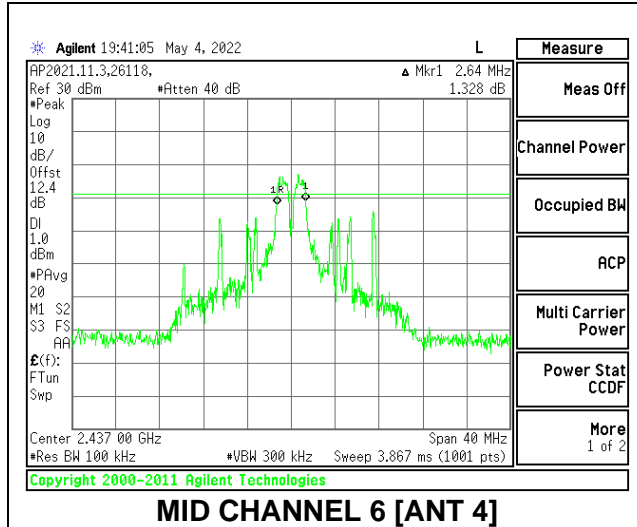

ANT 4 + ANT 3 2TX MODE: 26-Tones, RU Index 8

Channel	Frequency (MHz)	6dB Bandwidth (MHz) ANT 4	6dB Bandwidth (MHz) ANT 3	Minimum Limit (MHz)
Low 1	2412	2.16	2.08	0.5
Mid 6	2437	2.08	2.00	0.5
High 11	2462	2.00	2.20	0.5
High 12	2467	2.12	2.08	0.5
High 13	2472	2.12	2.12	0.5

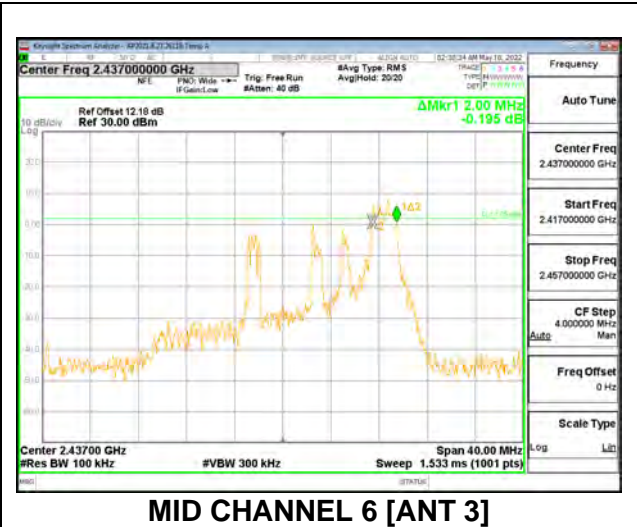
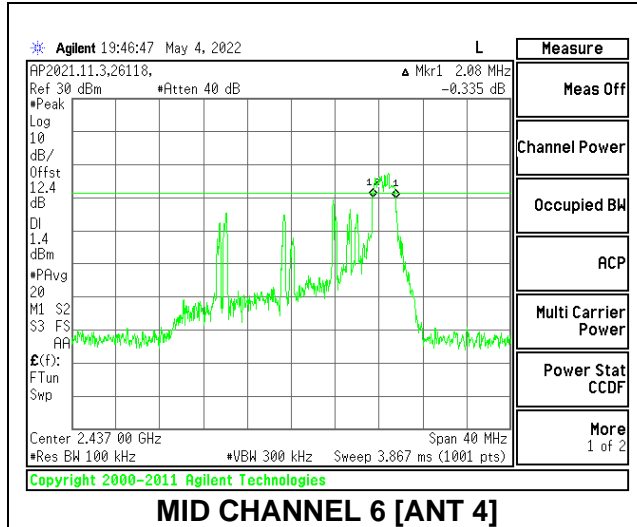

ANT 4 + ANT 3 2TX MODE: SU Mode

Channel	Frequency (MHz)	6dB Bandwidth (MHz) ANT 4	6dB Bandwidth (MHz) ANT 3	Minimum Limit (MHz)
Low 1	2412	19.12	18.72	0.5
Low 2	2417	19.12	18.88	0.5
Low 3	2422	18.56	19.12	0.5
Mid 6	2437	18.92	18.52	0.5
High 8	2447	19.04	19.00	0.5
High 9	2452	18.36	19.04	0.5
High 10	2457	18.84	18.52	0.5
High 11	2462	19.00	18.60	0.5
High 12	2467	19.12	18.92	0.5
High 13	2472	18.48	18.40	0.5

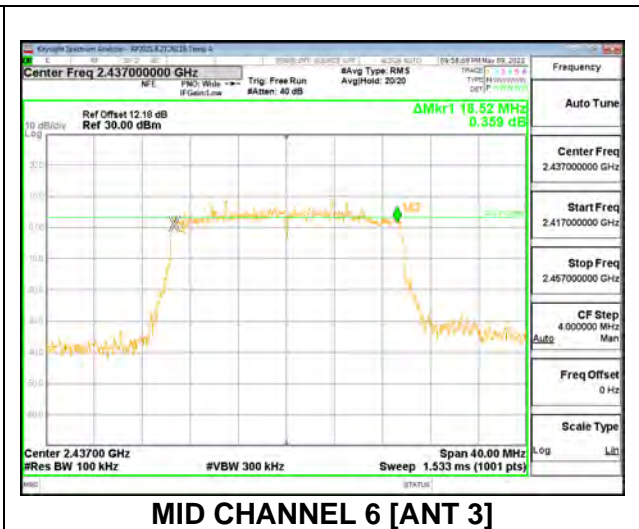
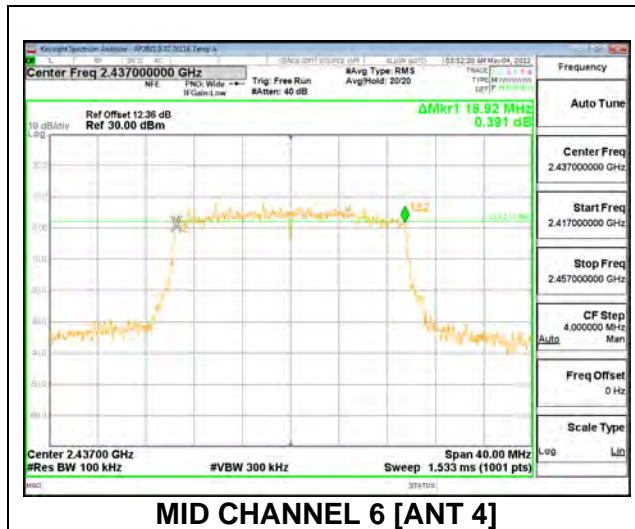

9.4. OUTPUT POWER

LIMITS

FCC §15.247 (b) (3)

RSS-247 5.4 (d)

For systems using digital modulation in the 902–928 MHz, 2400–2483.5 MHz, and 5725–5850 MHz bands: 1 Watt, based on the use of antennas with directional gains that do not exceed 6 dBi. If transmitting antennas of directional gain greater than 6 dBi are used, the conducted output power from the intentional radiator shall be reduced by the amount in dB that the directional gain of the antenna exceeds 6 dBi.

TEST PROCEDURE

Measurements perform using a wideband RF power meter.

The power output was measured on the EUT antenna port using SMA cable with 10dB attenuator connected to a power meter. Gated average power was read directly from the power meter.

DIRECTIONAL ANTENNA GAIN

For 1 TX:

There is only one transmitter output therefore the directional gain is equal to the antenna gain.

For 2 TX:

Tx chains are uncorrelated for power and correlated for PSD due to the device supporting CDD in all MIMO modes. The directional gains are as follows:

Band (GHz)	ANT 4 Gain (dBi)	ANT 3 Gain (dBi)	Uncorrelated Chains Directional Gain (dBi)	Correlated Chains Directional Gain (dBi)
2.4	-2.30	-1.90	-2.10	0.91

DIRECTIONAL GAIN CALCULATION:

ANSI C63.10-2013 section 14.4.3

Uncorrelated directional gain = $10 \cdot \text{LOG}((10^{\text{Ant1}/10}) + 10^{\text{Ant2}/10})/2$

Correlated directional Gain = $10 \cdot \text{LOG}(((10^{\text{Ant1}/20}) + 10^{\text{Ant2}/20})^2/2)$

Sample Calculation:

Ant1=-2.30, Ant2=-1.90

Uncorrelated Antenna gain = $10 \log[(10^{(-2.30/10)} + 10^{(-1.90/10)})/2] = -2.10$

Correlated Antenna gain = $10 \log[(10^{(-2.30/20)} + 10^{(-1.90/20)})^2/2] = 0.91$

RESULTS**9.4.1. 802.11b MODE 1TX**

Test Engineer:	26118
Test Date:	7/13/2022

1TX ANT 4 MODE**Limits**

Channel	Frequency (MHz)	Directional Gain (dBi)	FCC Power Limit (dBm)	ISED Power Limit (dBm)	ISED EIRP Limit (dBm)	Max Power (dBm)
Low 1	2412	-2.30	30.00	30.00	36.00	30.00
Mid 6	2437	-2.30	30.00	30.00	36.00	30.00
High 11	2462	-2.30	30.00	30.00	36.00	30.00
High 12	2467	-2.30	30.00	30.00	36.00	30.00
High 13	2472	-2.30	30.00	30.00	36.00	30.00

Results

Channel	Frequency (MHz)	Meas Power (dBm)	Total Corr'd Power (dBm)	Power Limit (dBm)	Margin (dB)
Low 1	2412	21.20	21.20	30.00	-8.80
Mid 6	2437	21.22	21.22	30.00	-8.78
High 11	2462	21.19	21.19	30.00	-8.81
High 12	2467	21.20	21.20	30.00	-8.80
High 13	2472	21.18	21.18	30.00	-8.82

1TX ANT 3 MODE**Limits**

Channel	Frequency (MHz)	Directional Gain (dBi)	FCC Power Limit (dBm)	ISED Power Limit (dBm)	ISED EIRP Limit (dBm)	Max Power (dBm)
Low 1	2412	-1.90	30.00	30.00	36.00	30.00
Mid 6	2437	-1.90	30.00	30.00	36.00	30.00
High 11	2462	-1.90	30.00	30.00	36.00	30.00
High 12	2467	-1.90	30.00	30.00	36.00	30.00
High 13	2472	-1.90	30.00	30.00	36.00	30.00

Results

Channel	Frequency (MHz)	Meas Power (dBm)	Total Corr'd Power (dBm)	Power Limit (dBm)	Margin (dB)
Low 1	2412	21.18	21.18	30.00	-8.82
Mid 6	2437	21.23	21.23	30.00	-8.77
High 11	2462	21.20	21.20	30.00	-8.80
High 12	2467	21.19	21.19	30.00	-8.81
High 13	2472	21.22	21.22	30.00	-8.78

9.4.2. 802.11n HT20 MODE 1TX

Test Engineer:	26118
Test Date:	7/13/2022

1TX ANT 4 MODE**Limits**

Channel	Frequency (MHz)	Directional Gain (dBi)	FCC Power Limit (dBm)	ISED Power Limit (dBm)	ISED EIRP Limit (dBm)	Max Power (dBm)
Low 1	2412	-2.30	30.00	30.00	36.00	30.00
Low 2	2417	-2.30	30.00	30.00	36.00	30.00
Mid 6	2437	-2.30	30.00	30.00	36.00	30.00
High 10	2457	-2.30	30.00	30.00	36.00	30.00
High 11	2462	-2.30	30.00	30.00	36.00	30.00
High 12	2467	-2.30	30.00	30.00	36.00	30.00
High 13	2472	-2.30	30.00	30.00	36.00	30.00

Results

Channel	Frequency (MHz)	Meas Power (dBm)	Total Corr'd Power (dBm)	Power Limit (dBm)	Margin (dB)
Low 1	2412	17.23	17.23	30.00	-12.77
Low 2	2417	20.19	20.19	30.00	-9.81
Mid 6	2437	21.24	21.24	30.00	-8.76
High 10	2457	20.40	20.40	30.00	-9.60
High 11	2462	18.18	18.18	30.00	-11.82
High 12	2467	16.23	16.23	30.00	-13.77
High 13	2472	14.69	14.69	30.00	-15.31

1TX ANT 3 MODE**Limits**

Channel	Frequency (MHz)	Directional Gain (dBi)	FCC Power Limit (dBm)	ISED Power Limit (dBm)	ISED EIRP Limit (dBm)	Max Power (dBm)
Low 1	2412	-1.90	30.00	30.00	36.00	30.00
Low 2	2417	-1.90	30.00	30.00	36.00	30.00
Mid 6	2437	-1.90	30.00	30.00	36.00	30.00
High 10	2457	-1.90	30.00	30.00	36.00	30.00
High 11	2462	-1.90	30.00	30.00	36.00	30.00
High 12	2467	-1.90	30.00	30.00	36.00	30.00
High 13	2472	-1.90	30.00	30.00	36.00	30.00

Results

Channel	Frequency (MHz)	Meas Power (dBm)	Total Corr'd Power (dBm)	Power Limit (dBm)	Margin (dB)
Low 1	2412	17.20	17.20	30.00	-12.80
Low 2	2417	20.18	20.18	30.00	-9.82
Mid 6	2437	21.22	21.22	30.00	-8.78
High 10	2457	20.17	20.17	30.00	-9.83
High 11	2462	18.21	18.21	30.00	-11.79
High 12	2467	16.19	16.19	30.00	-13.81
High 13	2472	14.69	14.69	30.00	-15.31

9.4.3. 802.11n HT20 CDD MODE 2TX

Test Engineer:	26118
Test Date:	7/17/2022

Limits

Channel	Frequency (MHz)	Directional Gain (dBi)	FCC Power Limit (dBm)	ISED Power Limit (dBm)	ISED EIRP Limit (dBm)	Max Power (dBm)
Low 1	2412	-2.10	30.00	36	36	30.00
Low 2	2417	-2.10	30.00	36	36	30.00
Low 3	2422	-2.10	30.00	36	36	30.00
Mid 6	2437	-2.10	30.00	36	36	30.00
High 9	2452	-2.10	30.00	36	36	30.00
High 10	2457	-2.10	30.00	36	36	30.00
High 11	2462	-2.10	30.00	36	36	30.00
High 12	2467	-2.10	30.00	36	36	30.00
High 13	2472	-2.10	30.00	36	36	30.00

Results

Channel	Frequency (MHz)	ANT4 Meas Power (dBm)	ANT3 Meas Power (dBm)	Total Corr'd Power (dBm)	Power Limit (dBm)	Margin (dB)
Low 1	2412	16.72	16.69	19.72	30.00	-10.28
Low 2	2417	19.19	19.20	22.21	30.00	-7.79
Low 3	2422	20.70	20.68	23.70	30.00	-6.30
Mid 6	2437	21.22	21.25	24.25	30.00	-5.75
High 9	2452	20.16	20.21	23.20	30.00	-6.80
High 10	2457	19.18	19.20	22.20	30.00	-7.80
High 11	2462	17.23	17.22	20.24	30.00	-9.76
High 12	2467	14.68	14.65	17.68	30.00	-12.32
High 13	2472	14.24	14.25	17.26	30.00	-12.74

9.4.4. 802.11ax HE20 MODE 1TX

Test Engineer:	26118
Test Date:	7/17/2022

1TX ANT 4 MODE: 26-Tones, RU Index 0**Limits**

Channel	Frequency (MHz)	Directional Gain (dBi)	FCC Power Limit (dBm)	ISED Power Limit (dBm)	ISED EIRP Limit (dBm)	Max Power (dBm)
Low 1	2412	-2.30	30.00	30.00	36.00	30.00
Mid 6	2437	-2.30	30.00	30.00	36.00	30.00
High 11	2462	-2.30	30.00	30.00	36.00	30.00
High 12	2467	-2.30	30.00	30.00	36.00	30.00
High 13	2472	-2.30	30.00	30.00	36.00	30.00

Results

Channel	Frequency (MHz)	Meas Power (dBm)	Total Corr'd Power (dBm)	Power Limit (dBm)	Margin (dB)
Low 1	2412	11.69	11.69	30.00	-18.31
Mid 6	2437	11.72	11.72	30.00	-18.28
High 11	2462	11.74	11.74	30.00	-18.26
High 12	2467	11.67	11.67	30.00	-18.33
High 13	2472	0.75	0.75	30.00	-29.25

1TX ANT 4 MODE: 26-Tones, RU Index 4**Limits**

Channel	Frequency (MHz)	Directional Gain (dBi)	FCC Power Limit (dBm)	ISED Power Limit (dBm)	ISED EIRP Limit (dBm)	Max Power (dBm)
Low 1	2412	-2.30	30.00	30.00	36.00	30.00
Mid 6	2437	-2.30	30.00	30.00	36.00	30.00
High 11	2462	-2.30	30.00	30.00	36.00	30.00
High 12	2467	-2.30	30.00	30.00	36.00	30.00
High 13	2472	-2.30	30.00	30.00	36.00	30.00

Results

Channel	Frequency (MHz)	Meas Power (dBm)	Total Corr'd Power (dBm)	Power Limit (dBm)	Margin (dB)
Low 1	2412	11.68	11.68	30.00	-18.32
Mid 6	2437	11.73	11.73	30.00	-18.27
High 11	2462	11.70	11.70	30.00	-18.30
High 12	2467	11.67	11.67	30.00	-18.33
High 13	2472	0.72	0.72	30.00	-29.28

1TX ANT 4 MODE: 26-Tones, RU Index 8**Limits**

Channel	Frequency (MHz)	Directional Gain (dBi)	FCC Power Limit (dBm)	ISED Power Limit (dBm)	ISED EIRP Limit (dBm)	Max Power (dBm)
Low 1	2412	-2.30	30.00	30.00	36.00	30.00
Mid 6	2437	-2.30	30.00	30.00	36.00	30.00
High 11	2462	-2.30	30.00	30.00	36.00	30.00
High 12	2467	-2.30	30.00	30.00	36.00	30.00
High 13	2472	-2.30	30.00	30.00	36.00	30.00

Results

Channel	Frequency (MHz)	Meas Power (dBm)	Total Corr'd Power (dBm)	Power Limit (dBm)	Margin (dB)
Low 1	2412	11.69	11.69	30.00	-18.31
Mid 6	2437	11.72	11.72	30.00	-18.28
High 11	2462	11.74	11.74	30.00	-18.26
High 12	2467	11.68	11.68	30.00	-18.32
High 13	2472	0.70	0.70	30.00	-29.30

1TX ANT 4 MODE: SU Mode**Limits**

Channel	Frequency (MHz)	Directional Gain (dBi)	FCC Power Limit (dBm)	ISED Power Limit (dBm)	ISED EIRP Limit (dBm)	Max Power (dBm)
Low 1	2412	-2.30	30.00	30.00	36.00	30.00
Low 2	2417	-2.30	30.00	30.00	36.00	30.00
Low 3	2422	-2.30	30.00	30.00	36.00	30.00
Mid 6	2437	-2.30	30.00	30.00	36.00	30.00
High 9	2452	-2.30	30.00	30.00	36.00	30.00
High 10	2457	-2.30	30.00	30.00	36.00	30.00
High 11	2462	-2.30	30.00	30.00	36.00	30.00
High 12	2467	-2.30	30.00	30.00	36.00	30.00
High 13	2472	-2.30	30.00	30.00	36.00	30.00

Results

Channel	Frequency (MHz)	Meas Power (dBm)	Total Corr'd Power (dBm)	Power Limit (dBm)	Margin (dB)
Low 1	2412	16.67	16.67	30.00	-13.33
Low 2	2417	18.70	18.70	30.00	-11.30
Low 3	2422	20.72	20.72	30.00	-9.28
Mid 6	2437	21.24	21.24	30.00	-8.76
High 9	2452	20.69	20.69	30.00	-9.31
High 10	2457	18.69	18.69	30.00	-11.31
High 11	2462	16.71	16.71	30.00	-13.29
High 12	2467	14.68	14.68	30.00	-15.32
High 13	2472	9.70	9.70	30.00	-20.30

1TX ANT 3 MODE: 26-Tones, RU Index 0**Limits**

Channel	Frequency (MHz)	Directional Gain (dBi)	FCC Power Limit (dBm)	ISED Power Limit (dBm)	ISED EIRP Limit (dBm)	Max Power (dBm)
Low 1	2412	-1.90	30.00	30.00	36.00	30.00
Mid 6	2437	-1.90	30.00	30.00	36.00	30.00
High 11	2462	-1.90	30.00	30.00	36.00	30.00
High 12	2467	-1.90	30.00	30.00	36.00	30.00
High 13	2472	-1.90	30.00	30.00	36.00	30.00

Results

Channel	Frequency (MHz)	Meas Power (dBm)	Total Corr'd Power (dBm)	Power Limit (dBm)	Margin (dB)
Low 1	2412	11.66	11.66	30.00	-18.34
Mid 6	2437	11.70	11.70	30.00	-18.30
High 11	2462	11.68	11.68	30.00	-18.32
High 12	2467	11.71	11.71	30.00	-18.29
High 13	2472	0.71	0.71	30.00	-29.29

1TX ANT 3 MODE: 26-Tones, RU Index 4**Limits**

Channel	Frequency (MHz)	Directional Gain (dBi)	FCC Power Limit (dBm)	ISED Power Limit (dBm)	ISED EIRP Limit (dBm)	Max Power (dBm)
Low 1	2412	-1.90	30.00	30.00	36.00	30.00
Mid 6	2437	-1.90	30.00	30.00	36.00	30.00
High 11	2462	-1.90	30.00	30.00	36.00	30.00
High 12	2467	-1.90	30.00	30.00	36.00	30.00
High 13	2472	-1.90	30.00	30.00	36.00	30.00

Results

Channel	Frequency (MHz)	Meas Power (dBm)	Total Corr'd Power (dBm)	Power Limit (dBm)	Margin (dB)
Low 1	2412	11.70	11.70	30.00	-18.30
Mid 6	2437	11.74	11.74	30.00	-18.26
High 11	2462	11.69	11.69	30.00	-18.31
High 12	2467	11.65	11.65	30.00	-18.35
High 13	2472	0.69	0.69	30.00	-29.31

1TX ANT 3 MODE: 26-Tones, RU Index 8**Limits**

Channel	Frequency (MHz)	Directional Gain (dBi)	FCC Power Limit (dBm)	ISED Power Limit (dBm)	ISED EIRP Limit (dBm)	Max Power (dBm)
Low 1	2412	-1.90	30.00	30.00	36.00	30.00
Mid 6	2437	-1.90	30.00	30.00	36.00	30.00
High 11	2462	-1.90	30.00	30.00	36.00	30.00
High 12	2467	-1.90	30.00	30.00	36.00	30.00
High 13	2472	-1.90	30.00	30.00	36.00	30.00

Results

Channel	Frequency (MHz)	Meas Power (dBm)	Total Corr'd Power (dBm)	Power Limit (dBm)	Margin (dB)
Low 1	2412	11.68	11.68	30.00	-18.32
Mid 6	2437	11.71	11.71	30.00	-18.29
High 11	2462	11.70	11.70	30.00	-18.30
High 12	2467	11.69	11.69	30.00	-18.31
High 13	2472	0.70	0.70	30.00	-29.30

1TX ANT 3 MODE: SU Mode**Limits**

Channel	Frequency (MHz)	Directional Gain (dBi)	FCC Power Limit (dBm)	ISED Power Limit (dBm)	ISED EIRP Limit (dBm)	Max Power (dBm)
Low 1	2412	-1.90	30.00	30.00	36.00	30.00
Low 2	2417	-1.90	30.00	30.00	36.00	30.00
Low 3	2422	-1.90	30.00	30.00	36.00	30.00
Mid 6	2437	-1.90	30.00	30.00	36.00	30.00
High 9	2452	-1.90	30.00	30.00	36.00	30.00
High 10	2457	-1.90	30.00	30.00	36.00	30.00
High 11	2462	-1.90	30.00	30.00	36.00	30.00
High 12	2467	-1.90	30.00	30.00	36.00	30.00
High 13	2472	-1.90	30.00	30.00	36.00	30.00

Results

Channel	Frequency (MHz)	Meas Power (dBm)	Total Corr'd Power (dBm)	Power Limit (dBm)	Margin (dB)
Low 1	2412	16.70	16.70	30.00	-13.30
Low 2	2417	18.72	18.72	30.00	-11.28
Low 3	2422	20.70	20.70	30.00	-9.30
Mid 6	2437	21.22	21.22	30.00	-8.78
High 9	2452	20.68	20.68	30.00	-9.32
High 10	2457	18.71	18.71	30.00	-11.29
High 11	2462	16.69	16.69	30.00	-13.31
High 12	2467	14.70	14.70	30.00	-15.30
High 13	2472	9.73	9.73	30.00	-20.27

9.4.5. 802.11ax HE20 OFDMA MODE 2TX

Test Engineer:	26118
Test Date:	7/17/2022

ANT 4 + ANT 3 2TX MODE: 26-Tones, RU Index 0**Limits**

Channel	Frequency (MHz)	Directional Gain (dBi)	FCC Power Limit (dBm)	ISED Power Limit (dBm)	ISED EIRP Limit (dBm)	Max Power (dBm)
Low 1	2412	-2.10	30.00	36.00	36.00	30.00
Mid 6	2437	-2.10	30.00	36.00	36.00	30.00
High 11	2462	-2.10	30.00	36.00	36.00	30.00
High 12	2467	-2.10	30.00	36.00	36.00	30.00
High 13	2472	-2.10	30.00	36.00	36.00	30.00

Results

Channel	Frequency (MHz)	ANT4 Meas Power (dBm)	ANT3 Meas Power (dBm)	Total Corr'd Power (dBm)	Power Limit (dBm)	Margin (dB)
Low 1	2412	11.69	11.71	14.71	30.00	-15.29
Mid 6	2437	11.67	11.72	14.71	30.00	-15.29
High 11	2462	11.70	11.68	14.70	30.00	-15.30
High 12	2467	11.66	11.71	14.70	30.00	-15.30
High 13	2472	-0.28	-0.30	2.72	30.00	-27.28

ANT 4 + ANT 3 2TX MODE: 26-Tones, RU Index 4

Limits

Channel	Frequency (MHz)	Directional Gain (dBi)	FCC Power Limit (dBm)	ISED Power Limit (dBm)	ISED EIRP Limit (dBm)	Max Power (dBm)
Low 1	2412	-2.10	30.00	36.00	36.00	30.00
Mid 6	2437	-2.10	30.00	36.00	36.00	30.00
High 11	2462	-2.10	30.00	36.00	36.00	30.00
High 12	2467	-2.10	30.00	36.00	36.00	30.00
High 13	2472	-2.10	30.00	36.00	36.00	30.00

Results

Channel	Frequency (MHz)	ANT4 Meas Power (dBm)	ANT3 Meas Power (dBm)	Total Corr'd Power (dBm)	Power Limit (dBm)	Margin (dB)
Low 1	2412	11.70	11.72	14.72	30.00	-15.28
Mid 6	2437	11.74	11.73	14.75	30.00	-15.25
High 11	2462	11.69	11.71	14.71	30.00	-15.29
High 12	2467	11.72	11.68	14.71	30.00	-15.29
High 13	2472	-0.25	-0.27	2.75	30.00	-27.25

ANT 4 + ANT 3 2TX MODE: 26-Tones, RU Index 8**Limits**

Channel	Frequency (MHz)	Directional Gain (dBi)	FCC Power Limit (dBm)	ISED Power Limit (dBm)	ISED EIRP Limit (dBm)	Max Power (dBm)
Low 1	2412	-2.10	30.00	36.00	36.00	30.00
Mid 6	2437	-2.10	30.00	36.00	36.00	30.00
High 11	2462	-2.10	30.00	36.00	36.00	30.00
High 12	2467	-2.10	30.00	36.00	36.00	30.00
High 13	2472	-2.10	30.00	36.00	36.00	30.00

Results

Channel	Frequency (MHz)	ANT4 Meas Power (dBm)	ANT3 Meas Power (dBm)	Total Corr'd Power (dBm)	Power Limit (dBm)	Margin (dB)
Low 1	2412	11.69	11.70	14.71	30.00	-15.29
Mid 6	2437	11.74	11.72	14.74	30.00	-15.26
High 11	2462	11.72	11.73	14.74	30.00	-15.26
High 12	2467	11.70	11.73	14.73	30.00	-15.27
High 13	2472	-0.32	-0.30	2.70	30.00	-27.30

ANT 4 + ANT 3 2TX MODE: SU Mode**Limits**

Channel	Frequency (MHz)	Directional Gain (dBi)	FCC Power Limit (dBm)	ISED Power Limit (dBm)	ISED EIRP Limit (dBm)	Max Power (dBm)
Low 1	2412	-2.10	30.00	36.00	36.00	30.00
Low 2	2417	-2.10	30.00	36.00	36.00	30.00
Low 3	2422	-2.10	30.00	36.00	36.00	30.00
Mid 6	2437	-2.10	30.00	36.00	36.00	30.00
High 8	2447	-2.10	30.00	36.00	36.00	30.00
High 9	2452	-2.10	30.00	36.00	36.00	30.00
High 10	2457	-2.10	30.00	36.00	36.00	30.00
High 11	2462	-2.10	30.00	36.00	36.00	30.00
High 12	2467	-2.10	30.00	36.00	36.00	30.00
High 13	2472	-2.10	30.00	36.00	36.00	30.00

Results

Channel	Frequency (MHz)	ANT2 Meas Power (dBm)	ANT3 Meas Power (dBm)	Total Corr'd Power (dBm)	Power Limit (dBm)	Margin (dB)
Low 1	2412	15.71	15.73	18.73	30.00	-11.27
Low 2	2417	17.69	17.71	20.71	30.00	-9.29
Low 3	2422	19.70	19.72	22.72	30.00	-7.28
Mid 6	2437	21.23	21.20	24.23	30.00	-5.77
High 8	2447	21.22	21.24	24.24	30.00	-5.76
High 9	2452	19.19	19.21	22.21	30.00	-7.79
High 10	2457	17.71	17.69	20.71	30.00	-9.29
High 11	2462	15.73	15.72	18.74	30.00	-11.26
High 12	2467	13.22	13.20	16.22	30.00	-13.78
High 13	2472	8.68	8.70	11.70	30.00	-18.30

9.5. POWER SPECTRAL DENSITY

LIMITS

FCC §15.247 (e)

RSS-247 (5.2) (b)

The power spectral density conducted from the transmitter to the antenna shall not be greater than 8 dBm in any 3 kHz band during any time interval of continuous transmission.

RESULTS

Only Mid channel plot is reported to show analyzer settings.

Note: RBW setting is used greater than 3KHz on PSD measurement

9.5.1. 802.11b MODE 1TX

1TX ANT 4 MODE

Duty Cycle CF (dB)		0.00	Included in Calculations of Corr'd PSD		
Channel	Frequency (MHz)	Meas (dBm/3kHz)	Total Corr'd PSD (dBm/3kHz)	Limit (dBm/3kHz)	Margin (dB)
Low 1	2412	0.080	0.080	8.000	-7.920
Mid 6	2437	-0.055	-0.055	8.000	-8.055
High 11	2462	-0.067	-0.067	8.000	-8.067
High 12	2467	0.010	0.010	8.000	-7.990
High 13	2472	-0.043	-0.043	8.000	-8.043

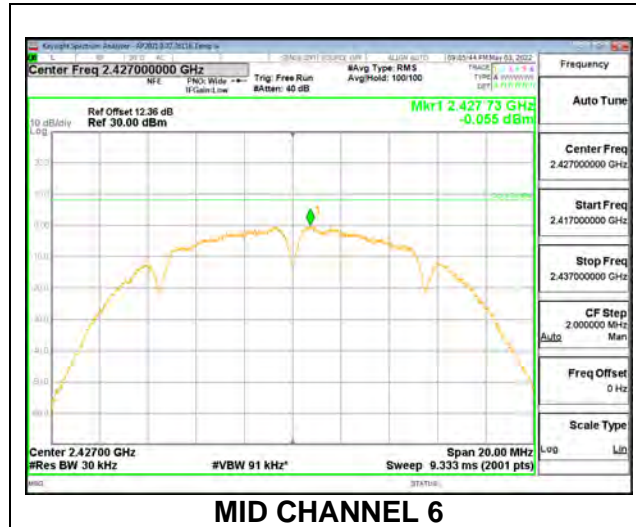

1TX ANT 3 MODE

Duty Cycle CF (dB)		0.10	Included in Calculations of Corr'd PSD		
Channel	Frequency (MHz)	Meas (dBm/3kHz)	Total Corr'd PSD (dBm/3kHz)	Limit (dBm/3kHz)	Margin (dB)
Low 1	2412	0.074	0.174	8.000	-7.826
Mid 6	2437	-0.037	0.063	8.000	-7.937
High 11	2462	-0.106	-0.006	8.000	-8.006
High 12	2467	-0.152	-0.052	8.000	-8.052
High 13	2472	-0.113	-0.013	8.000	-8.013

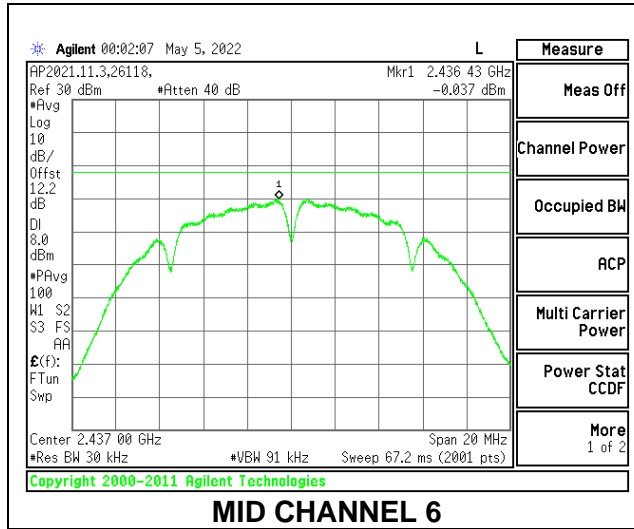

9.5.2. 802.11n HT20 MODE 1TX

1TX ANT 4 MODE

Duty Cycle CF (dB)		0.10	Included in Calculations of Corr'd PSD		
Channel	Frequency (MHz)	Meas (dBm/3kHz)	Total Corr'd PSD (dBm/3kHz)	Limit (dBm/3kHz)	Margin (dB)
Low 1	2412	-6.693	-6.593	8.000	-14.593
Low 2	2417	-3.399	-3.299	8.000	-11.299
Mid 6	2437	-2.683	-2.583	8.000	-10.583
High 10	2457	-3.243	-3.143	8.000	-11.143
High 11	2462	-5.589	-5.489	8.000	-13.489
High 12	2467	-7.354	-7.254	8.000	-15.254
High 13	2472	-7.907	-7.807	8.000	-15.807

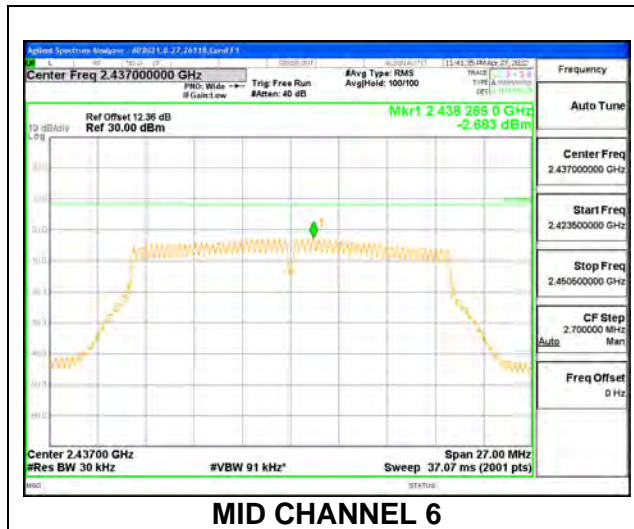

1TX ANT 3 MODE

Duty Cycle CF (dB)	0.10	Included in Calculations of Corr'd PSD			
Channel	Frequency (MHz)	Meas (dBm/3kHz)	Total Corr'd PSD (dBm/3kHz)	Limit (dBm/3kHz)	Margin (dB)
Low 1	2412	-6.435	-6.335	8.000	-14.335
Low 2	2417	-3.572	-3.472	8.000	-11.472
Mid 6	2437	-2.585	-2.485	8.000	-10.485
High 10	2457	-3.523	-3.423	8.000	-11.423
High 11	2462	-5.665	-5.565	8.000	-13.565
High 12	2467	-7.331	-7.231	8.000	-15.231
High 13	2472	-8.228	-8.128	8.000	-16.128

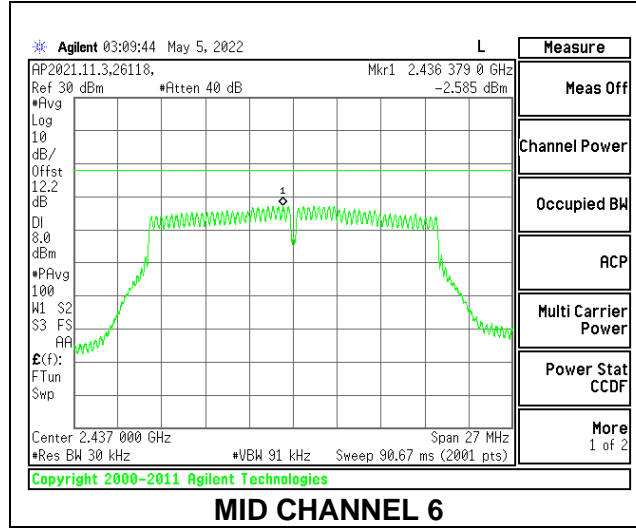

9.5.3. 802.11n HT20 CDD MODE 2TX

Duty Cycle CF (dB)		0.10		Included in Calculations of Corr'd PSD		
Channel	Frequency (MHz)	ANT4 Meas (dBm/3kHz)	ANT3 Meas (dBm/3kHz)	Total Corr'd PSD (dBm/3kHz)	Limit (dBm/3kHz)	Margin (dB)
Low 1	2412	-6.747	-7.357	-3.931	8.000	-11.931
Low 2	2417	-4.166	-4.257	-1.101	8.000	-9.101
Low 3	2422	-2.425	-2.957	0.427	8.000	-7.573
Mid 6	2437	-2.137	-2.006	1.039	8.000	-6.961
High 9	2452	-3.935	-3.418	-0.559	8.000	-8.559
High 10	2457	-4.098	-4.139	-1.008	8.000	-9.008
High 11	2462	-6.690	-6.709	-3.589	8.000	-11.589
High 12	2467	-8.543	-8.784	-5.552	8.000	-13.552
High 13	2472	-8.791	-8.839	-5.705	8.000	-13.705

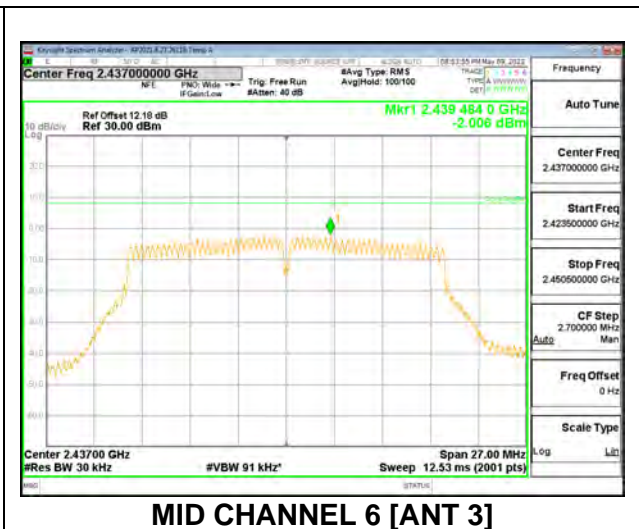
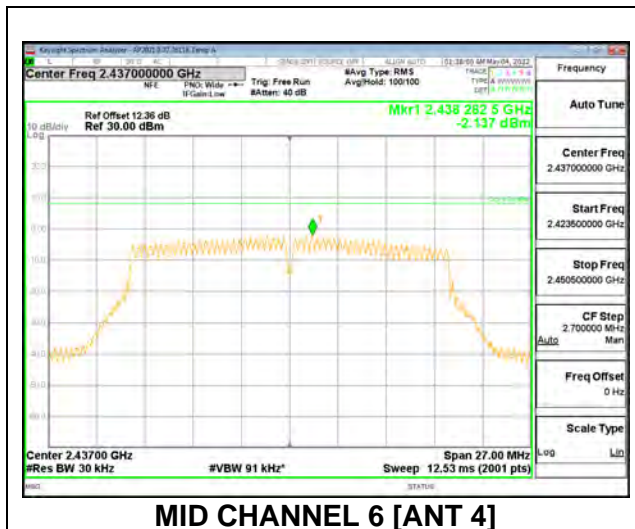

9.5.4. 802.11ax HE20 MODE 1TX

1TX ANT 4 MODE , 26-Tone RU Index 0

Duty Cycle CF (dB)		Included in Calculations of Corr'd PSD			
Channel	Frequency (MHz)	Meas (dBm/3kHz)	Total Corr'd PSD (dBm/3kHz)	Limit (dBm/3kHz)	Margin (dB)
Low 1	2412	-4.976	-4.976	8.000	-12.976
Mid 6	2437	-4.776	-4.776	8.000	-12.776
High 11	2462	-4.626	-4.626	8.000	-12.626
High 12	2467	-4.936	-4.936	8.000	-12.936
High 13	2472	-16.555	-16.555	8.000	-24.555

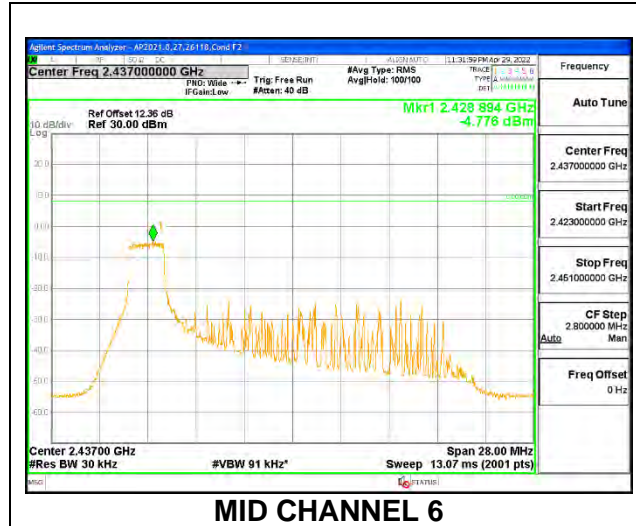

1TX ANT 4 MODE , 26-Tone RU Index 4

Duty Cycle CF (dB)		0.00	Included in Calculations of Corr'd PSD		
Channel	Frequency (MHz)	Meas (dBm/3kHz)	Total Corr'd PSD (dBm/3kHz)	Limit (dBm/3kHz)	Margin (dB)
Low 1	2412	-5.220	-5.220	8.000	-13.220
Mid 6	2437	-5.391	-5.391	8.000	-13.391
High 11	2462	-5.187	-5.187	8.000	-13.187
High 12	2467	-5.110	-5.110	8.000	-13.110
High 13	2472	-16.842	-16.842	8.000	-24.842

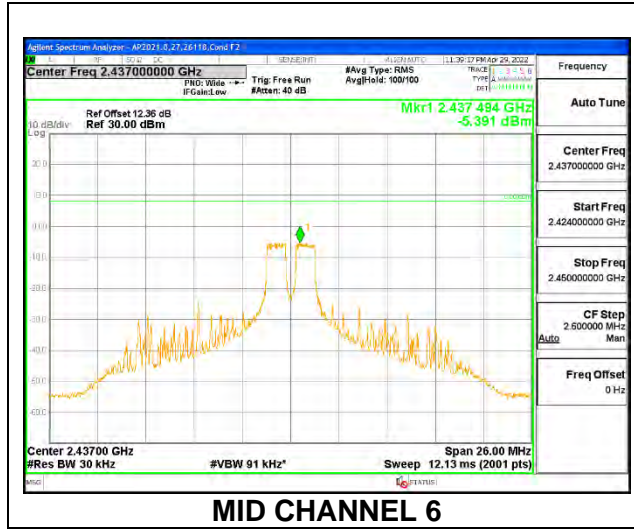

1TX ANT 4 MODE , 26-Tone RU Index 8

Duty Cycle CF (dB)		0.00	Included in Calculations of Corr'd PSD		
Channel	Frequency (MHz)	Meas (dBm/3kHz)	Total Corr'd PSD (dBm/3kHz)	Limit (dBm/3kHz)	Margin (dB)
Low 1	2412	-5.006	-5.006	8.000	-13.006
Mid 6	2437	-4.960	-4.960	8.000	-12.960
High 11	2462	-4.984	-4.984	8.000	-12.984
High 12	2467	-4.845	-4.845	8.000	-12.845
High 13	2472	-16.358	-16.358	8.000	-24.358

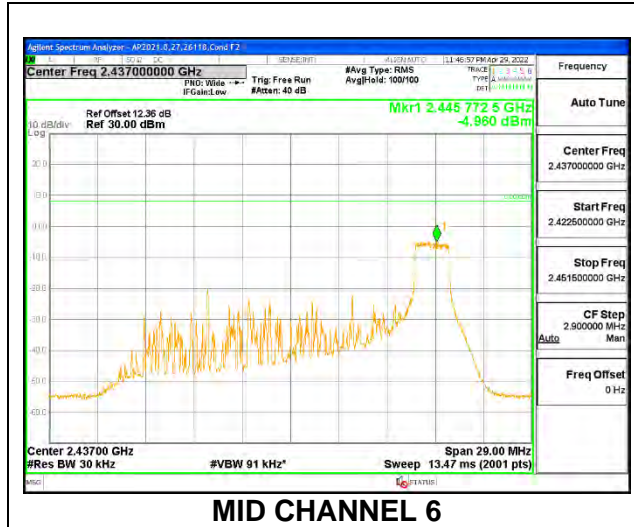

MID CHANNEL 6

1TX ANT 4 MODE , SU Mode

Duty Cycle CF (dB)		0.00	Included in Calculations of Corr'd PSD		
Channel	Frequency (MHz)	Meas (dBm/3kHz)	Total Corr'd PSD (dBm/3kHz)	Limit (dBm/3kHz)	Margin (dB)
Low 1	2412	-8.496	-8.496	8.000	-16.496
Low 2	2417	-6.521	-6.521	8.000	-14.521
Low 3	2422	-4.986	-4.986	8.000	-12.986
Mid 6	2437	-4.201	-4.201	8.000	-12.201
High 9	2452	-4.307	-4.307	8.000	-12.307
High 10	2457	-6.409	-6.409	8.000	-14.409
High 11	2462	-8.817	-8.817	8.000	-16.817
High 12	2467	-10.822	-10.822	8.000	-18.822
High 13	2472	-15.550	-15.550	8.000	-23.550

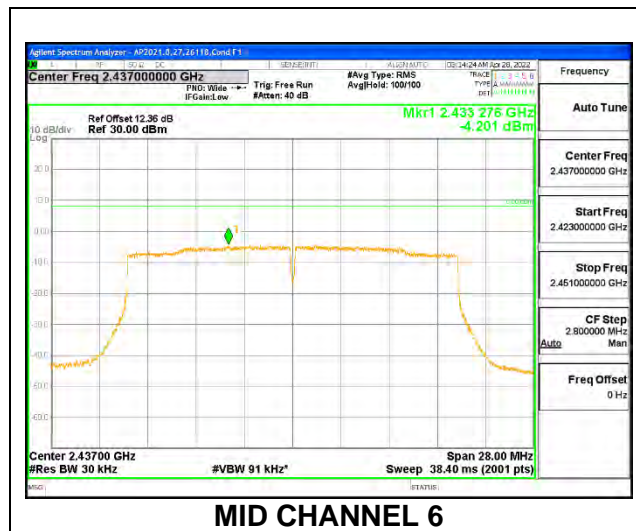

1TX ANT 3 MODE , 26-Tone RU Index 0

Duty Cycle CF (dB)		0.00	Included in Calculations of Corr'd PSD		
Channel	Frequency (MHz)	Meas (dBm/3kHz)	Total Corr'd PSD (dBm/3kHz)	Limit (dBm/3kHz)	Margin (dB)
Low 1	2412	-5.001	-5.001	8.000	-13.001
Mid 6	2437	-5.060	-5.060	8.000	-13.060
High 11	2462	-4.665	-4.665	8.000	-12.665
High 12	2467	-5.025	-5.025	8.000	-13.025
High 13	2472	-16.076	-16.076	8.000	-24.076

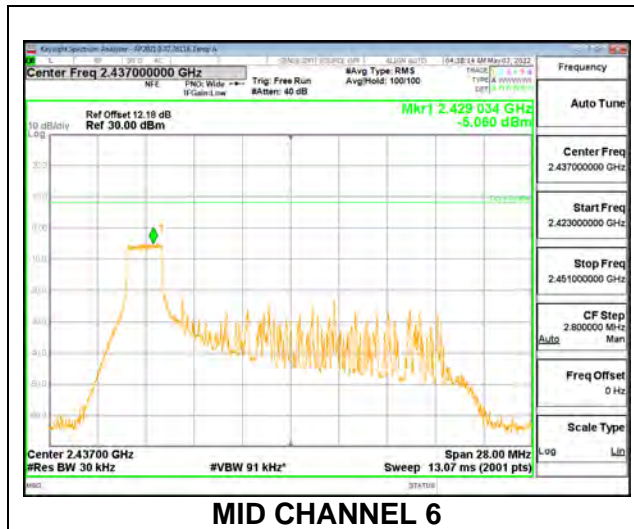

1TX ANT 3 MODE , 26-Tone RU Index 4

Duty Cycle CF (dB)		0.00	Included in Calculations of Corr'd PSD		
Channel	Frequency (MHz)	Meas (dBm/3kHz)	Total Corr'd PSD (dBm/3kHz)	Limit (dBm/3kHz)	Margin (dB)
Low 1	2412	-5.098	-5.098	8.000	-13.098
Mid 6	2437	-4.989	-4.989	8.000	-12.989
High 11	2462	-5.314	-5.314	8.000	-13.314
High 12	2467	-4.741	-4.741	8.000	-12.741
High 13	2472	-16.359	-16.359	8.000	-24.359

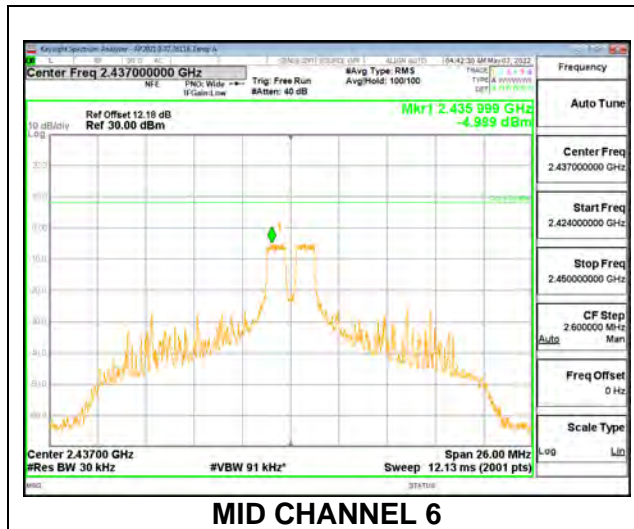

1TX ANT 3 MODE , 26-Tone RU Index 8

Duty Cycle CF (dB)		0.00	Included in Calculations of Corr'd PSD		
Channel	Frequency (MHz)	Meas (dBm/3kHz)	Total Corr'd PSD (dBm/3kHz)	Limit (dBm/3kHz)	Margin (dB)
Low 1	2412	-4.911	-4.911	8.000	-12.911
Mid 6	2437	-5.148	-5.148	8.000	-13.148
High 11	2462	-5.107	-5.107	8.000	-13.107
High 12	2467	-5.033	-5.033	8.000	-13.033
High 13	2472	-15.919	-15.919	8.000	-23.919

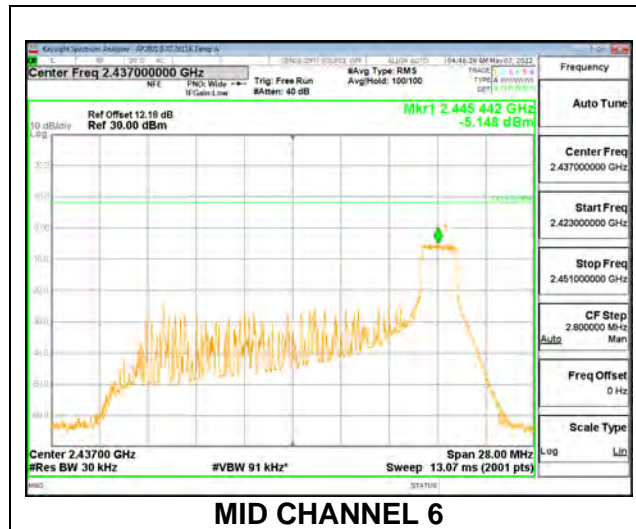

1TX ANT 3 MODE , SU Mode

Duty Cycle CF (dB)		0.00	Included in Calculations of Corr'd PSD		
Channel	Frequency (MHz)	Meas (dBm/3kHz)	Total Corr'd PSD (dBm/3kHz)	Limit (dBm/3kHz)	Margin (dB)
Low 1	2412	-8.657	-8.657	8.000	-16.657
Low 2	2417	-6.415	-6.415	8.000	-14.415
Low 3	2422	-4.207	-4.207	8.000	-12.207
Mid 6	2437	-4.214	-4.214	8.000	-12.214
High 9	2452	-4.633	-4.633	8.000	-12.633
High 10	2457	-6.413	-6.413	8.000	-14.413
High 11	2462	-8.542	-8.542	8.000	-16.542
High 12	2467	-10.433	-10.433	8.000	-18.433
High 13	2472	-15.801	-15.801	8.000	-23.801

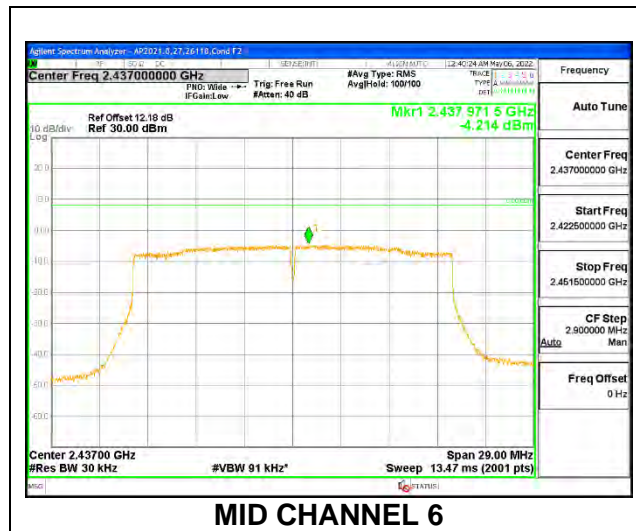

9.5.5. 802.11ax HE20 OFDMA MODE 2TX

ANT 4 + ANT 3 2TX MODE: 26-Tones, RU Index 0

Duty Cycle CF (dB)		Included in Calculations of Corr'd PSD				
Channel	Frequency (MHz)	ANT4 Meas (dBm/3kHz)	ANT3 Meas (dBm/3kHz)	Total Corr'd PSD (dBm/3kHz)	Limit (dBm/3kHz)	Margin (dB)
Low 1	2412	-4.895	-4.649	-1.760	8.000	-9.760
Mid 6	2437	-5.232	-4.682	-1.938	8.000	-9.938
High 11	2462	-5.201	-4.923	-2.049	8.000	-10.049
High 12	2467	-5.077	-4.724	-1.887	8.000	-9.887
High 13	2472	-17.022	-16.755	-13.876	8.000	-21.876

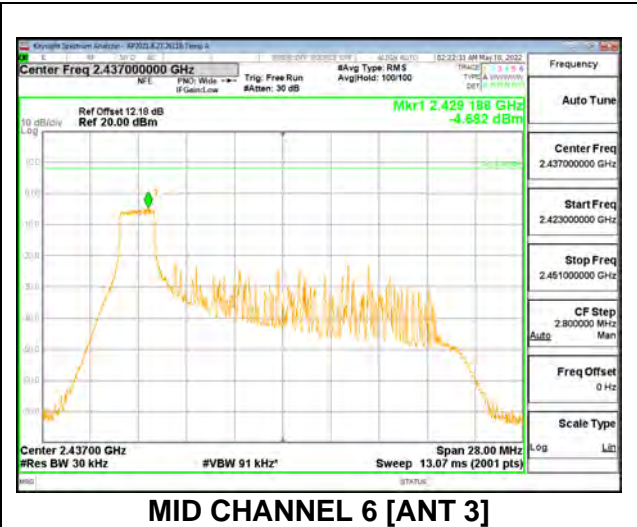
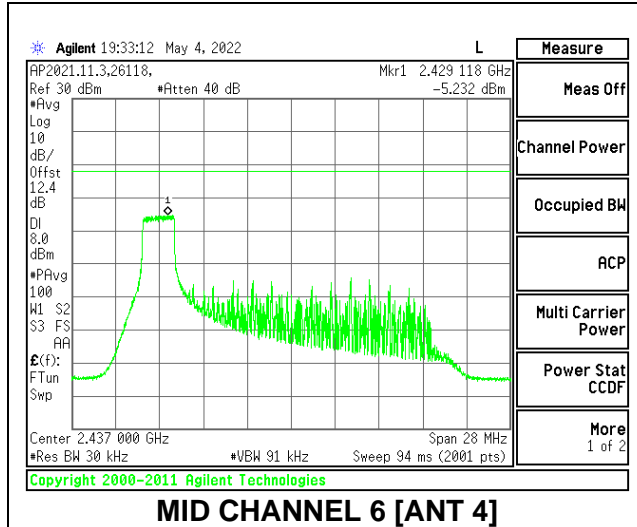

ANT 4 + ANT 3 2TX MODE: 26-Tones, RU Index 4

Duty Cycle CF (dB)		0.00		Included in Calculations of Corr'd PSD		
Channel	Frequency (MHz)	ANT4 Meas (dBm/3kHz)	ANT3 Meas (dBm/3kHz)	Total Corr'd PSD (dBm/3kHz)	Limit (dBm/3kHz)	Margin (dB)
Low 1	2412	-5.040	-5.017	-2.018	8.000	-10.018
Mid 6	2437	-5.351	-5.132	-2.230	8.000	-10.230
High 11	2462	-4.998	-4.933	-1.955	8.000	-9.955
High 12	2467	-5.156	-5.023	-2.079	8.000	-10.079
High 13	2472	-17.091	-16.726	-13.894	8.000	-21.894

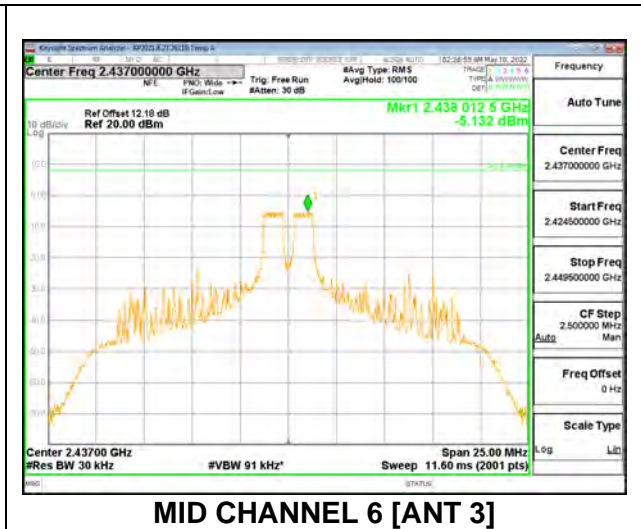
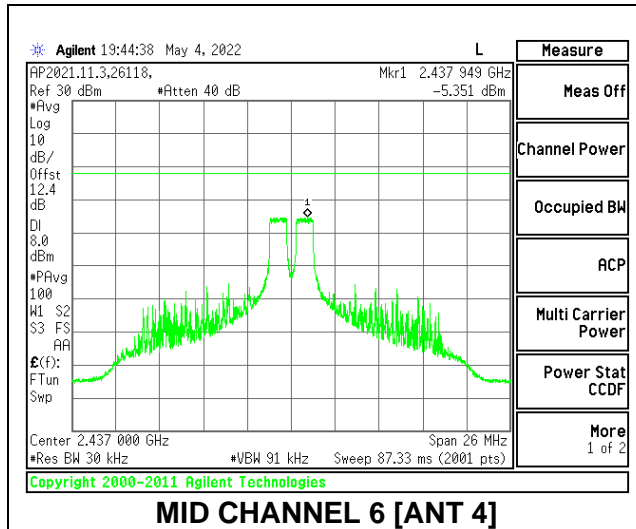

ANT 4 + ANT 3 2TX MODE: 26-Tones, RU Index 8

Duty Cycle CF (dB)		0.00		Included in Calculations of Corr'd PSD		
Channel	Frequency (MHz)	ANT4 Meas (dBm/3kHz)	ANT3 Meas (dBm/3kHz)	Total Corr'd PSD (dBm/3kHz)	Limit (dBm/3kHz)	Margin (dB)
Low 1	2412	-4.976	-4.922	-1.939	8.000	-9.939
Mid 6	2437	-4.957	-4.969	-1.953	8.000	-9.953
High 11	2462	-4.957	-5.094	-2.015	8.000	-10.015
High 12	2467	-5.164	-4.975	-2.058	8.000	-10.058
High 13	2472	-16.872	-16.431	-13.636	8.000	-21.636

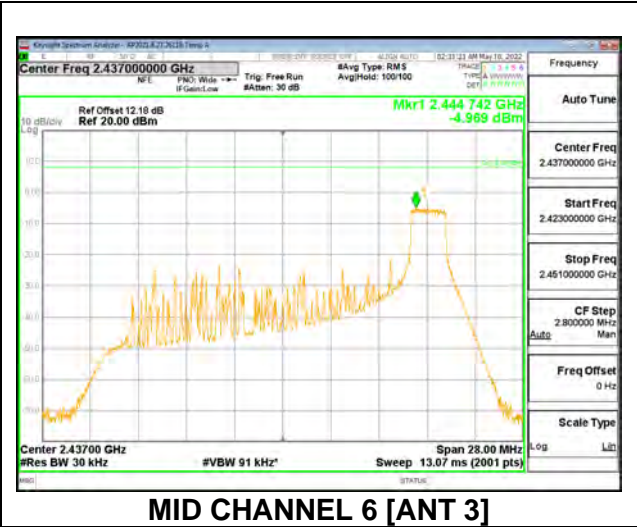
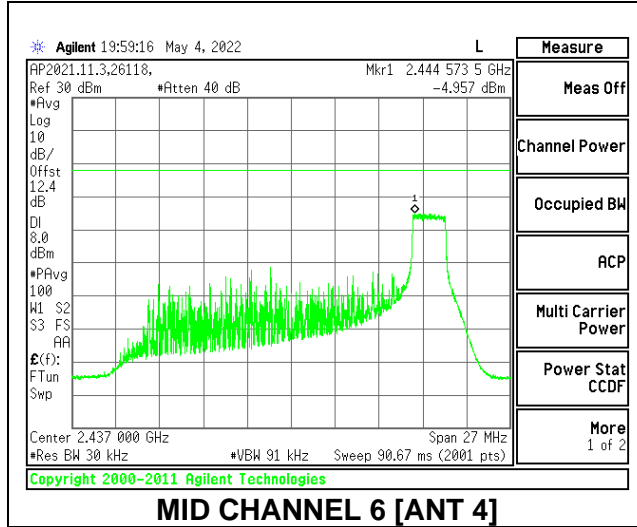

ANT 4 + ANT 3 2TX MODE: SU Mode

Duty Cycle CF (dB)		0.00		Included in Calculations of Corr'd PSD		
Channel	Frequency (MHz)	ANT4 Meas (dBm/3kHz)	ANT3 Meas (dBm/3kHz)	Total Corr'd PSD (dBm/3kHz)	Limit (dBm/3kHz)	Margin (dB)
Low 1	2412	-9.788	-9.609	-6.687	8.000	-14.687
Low 2	2417	-7.189	-7.978	-4.555	8.000	-12.555
Low 3	2422	-5.827	-5.546	-2.674	8.000	-10.674
Mid 6	2437	-4.353	-4.589	-1.459	8.000	-9.459
High 8	2447	-4.244	-4.006	-1.113	8.000	-9.113
High 9	2452	-6.200	-6.171	-3.175	8.000	-11.175
High 10	2457	-7.444	-7.424	-4.424	8.000	-12.424
High 11	2462	-9.185	-9.512	-6.335	8.000	-14.335
High 12	2467	-12.168	-12.451	-9.297	8.000	-17.297
High 13	2472	-16.821	-16.857	-13.829	8.000	-21.829

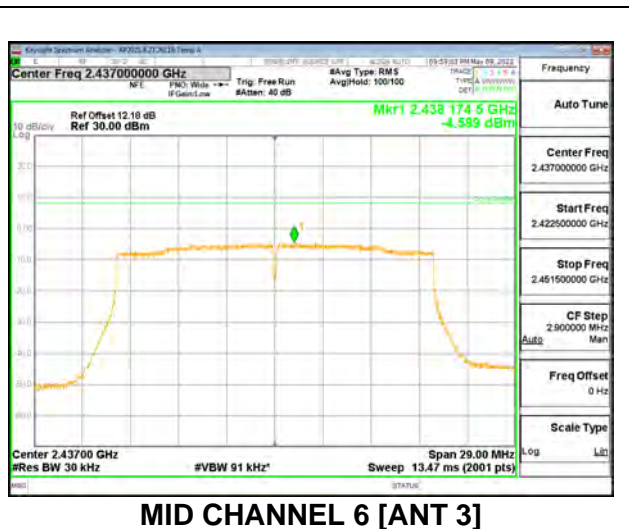
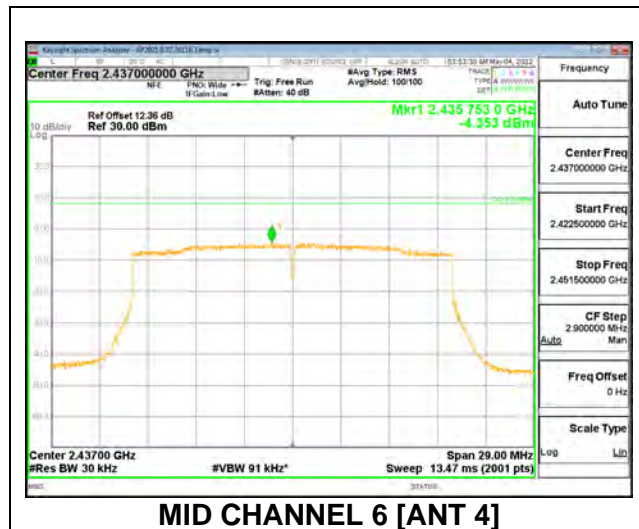

9.6. CONDUCTED SPURIOUS EMISSIONS

LIMITS

In any 100 kHz bandwidth outside the frequency band in which the spread spectrum or digitally modulated intentional radiator is operating, the radio frequency power that is produced by the intentional radiator shall be at least 20 dB below that in the 100 kHz bandwidth within the band that contains the highest level of the desired power, based on either an RF conducted or a radiated measurement, provided the transmitter demonstrates compliance with the peak conducted power limits. If the transmitter complies with the conducted power limits based on the use of RMS averaging over a time interval, as permitted under paragraph (b)(3) of this section, the attenuation required under this paragraph shall be 30 dB instead of 20 dB. Attenuation below the general limits specified in §15.209(a) is not required. In addition, radiated emissions which fall in the restricted bands, as defined in §15.205(a), must also comply with the radiated emission limits specified in §15.209(a) (see §15.205(c)).

Attenuated by 30dB since average power was measured

RESULTS

9.6.1. 802.11b MODE 1TX

1TX ANT 4 MODE

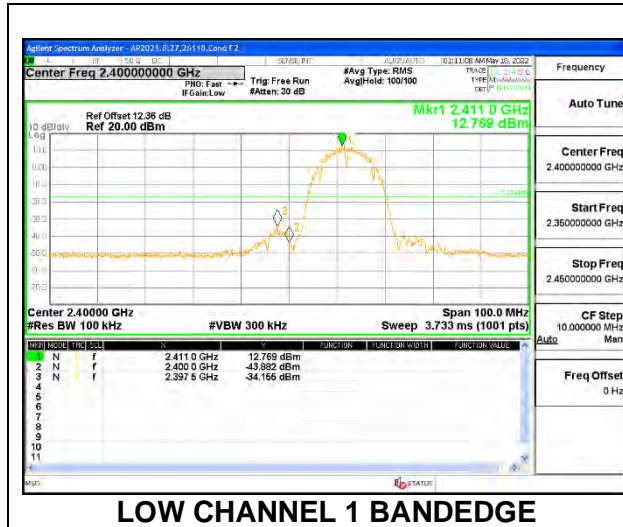

LOW CHANNEL 1 BANDEDGE

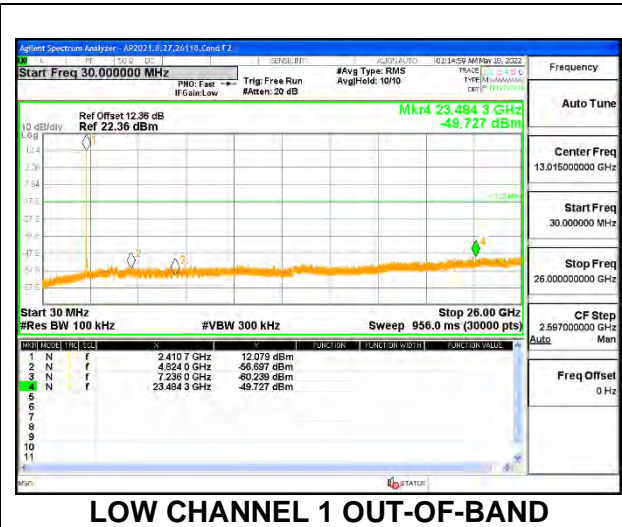

LOW CHANNEL 1 OUT-OF-BAND

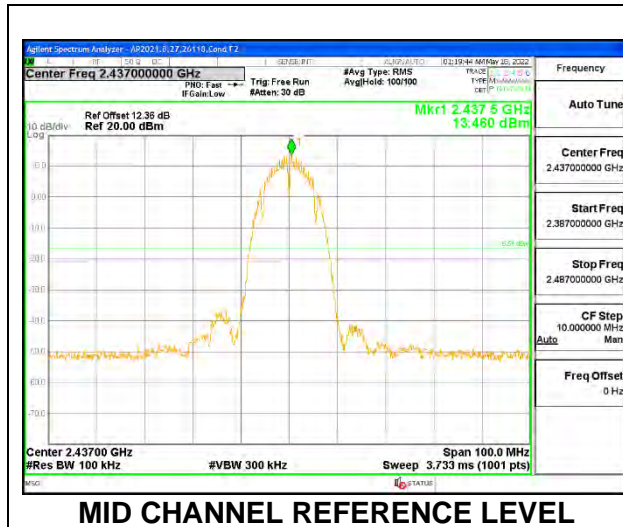

MID CHANNEL REFERENCE LEVEL

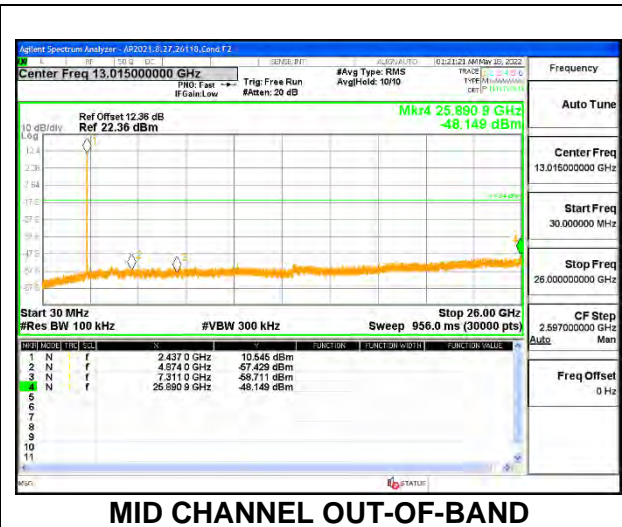

MID CHANNEL OUT-OF-BAND

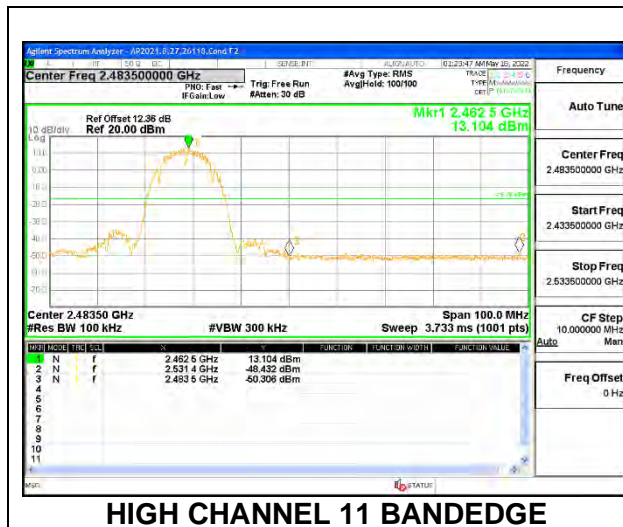

HIGH CHANNEL 11 BANDEDGE

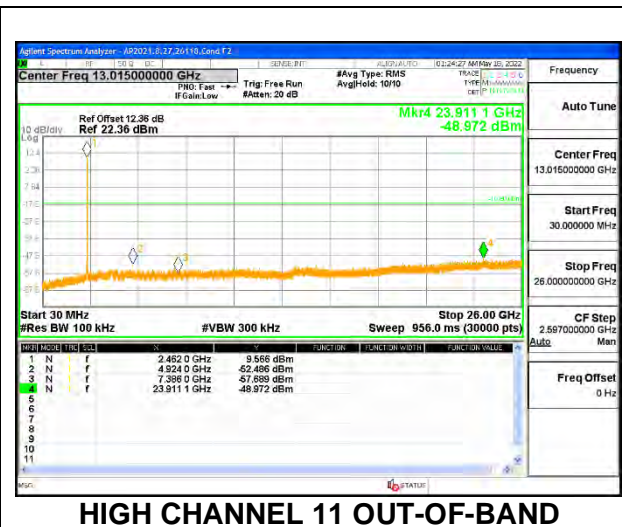

HIGH CHANNEL 11 OUT-OF-BAND

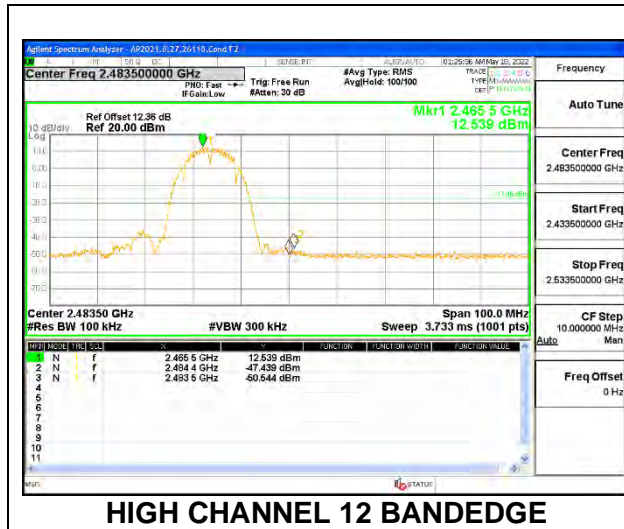

HIGH CHANNEL 12 BANDEDGE

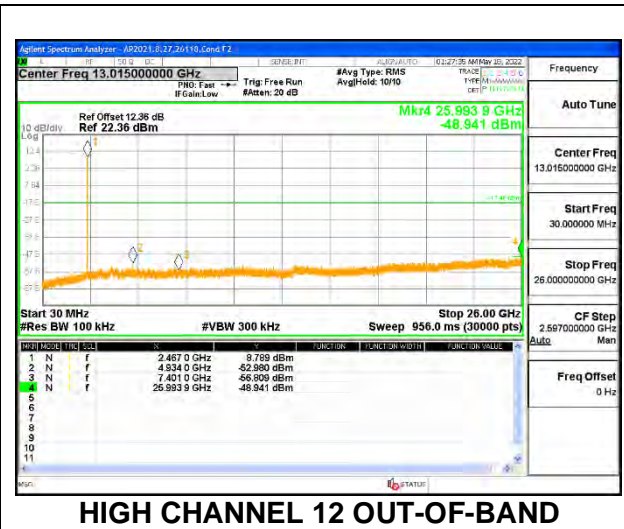

HIGH CHANNEL 12 OUT-OF-BAND

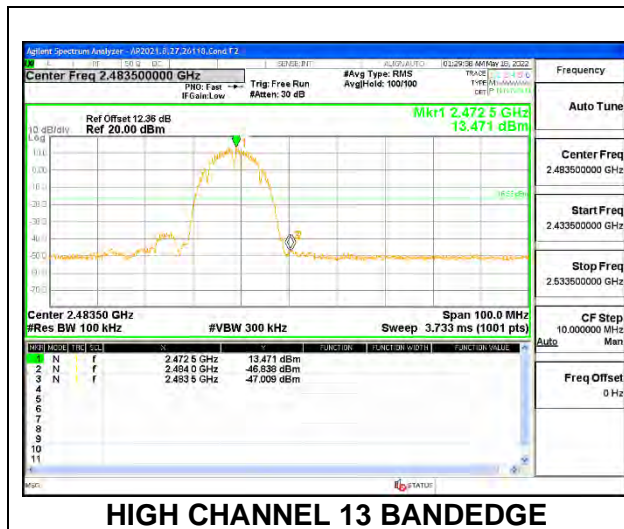

HIGH CHANNEL 13 BANDEDGE

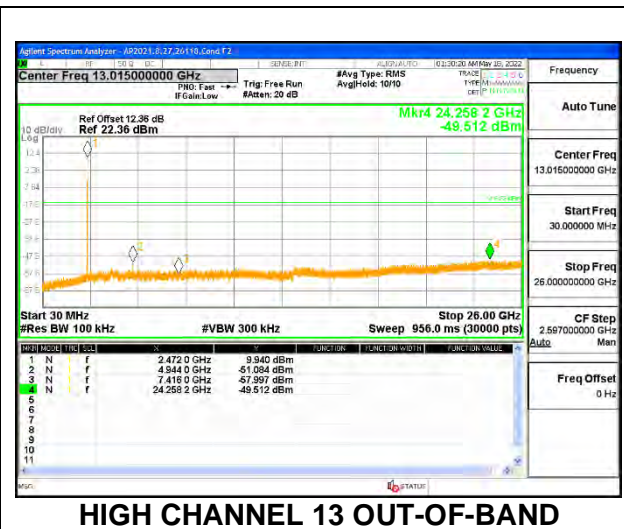

HIGH CHANNEL 13 OUT-OF-BAND

1TX ANT 3 MODE

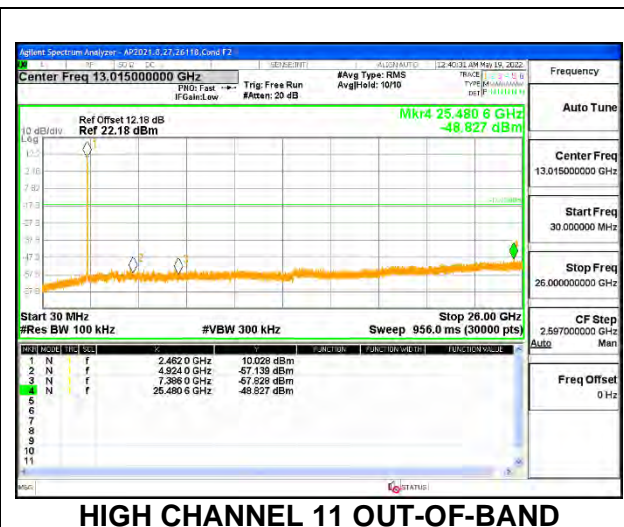
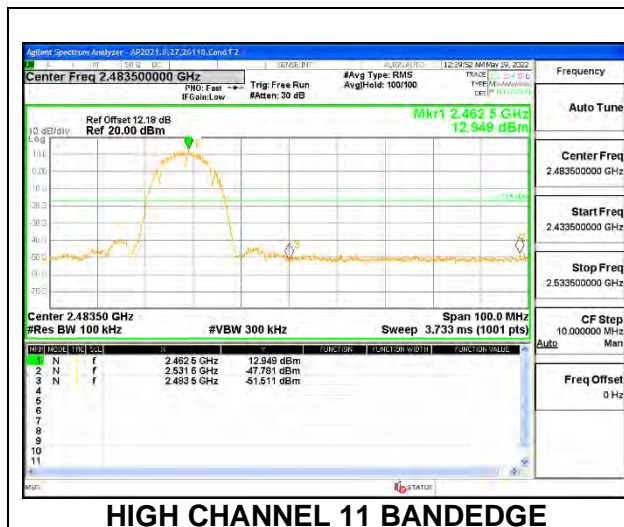
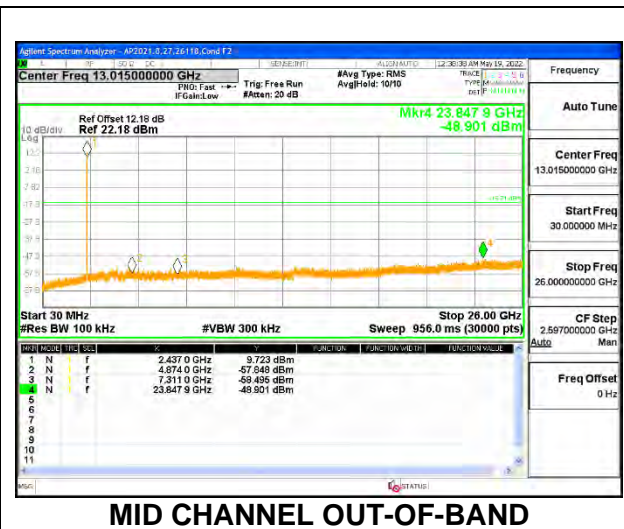
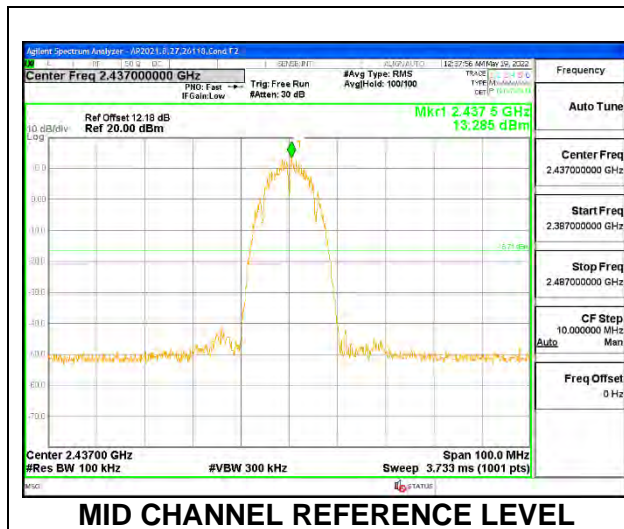
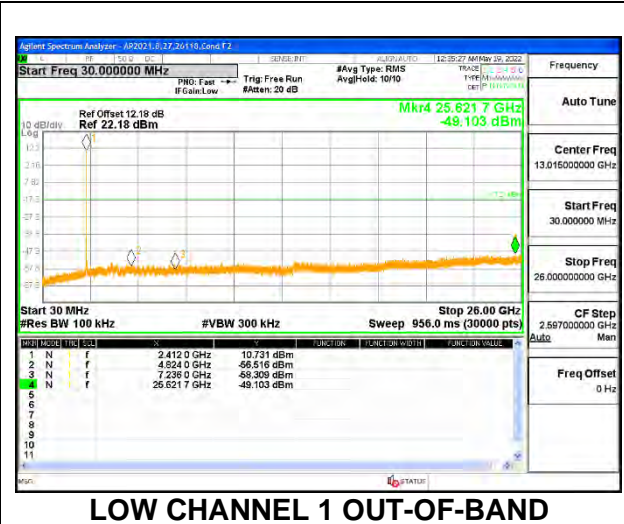
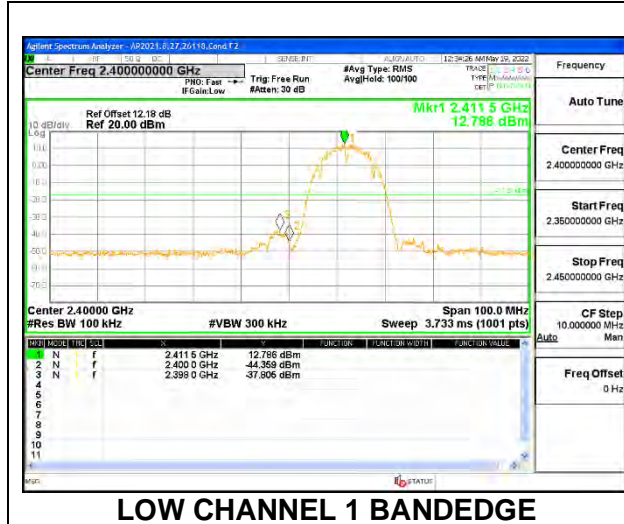

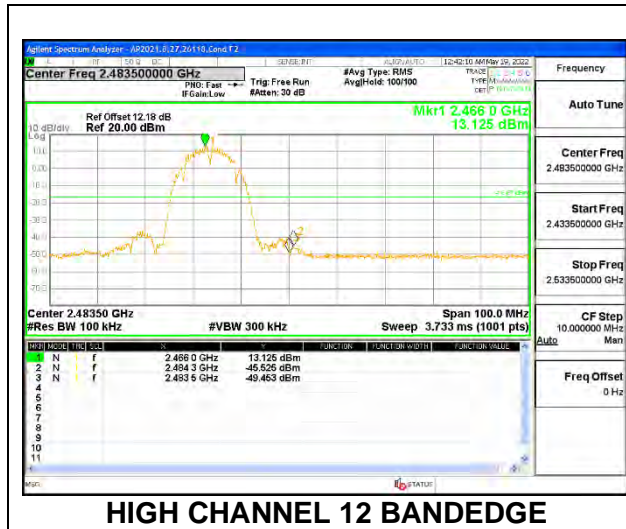

HIGH CHANNEL 12 BANDEDGE

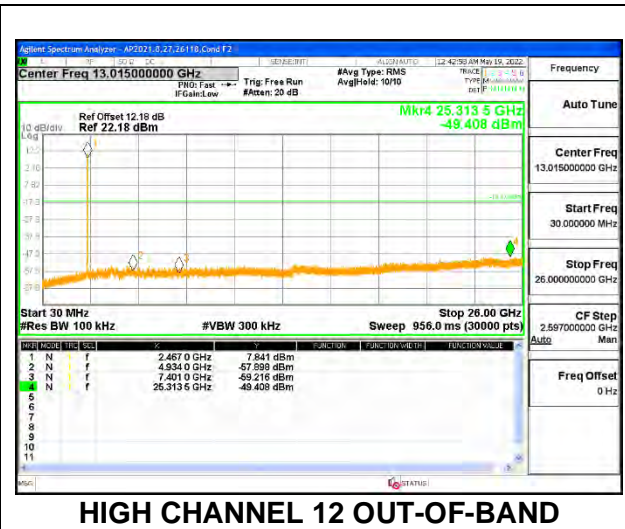

HIGH CHANNEL 12 OUT-OF-BAND

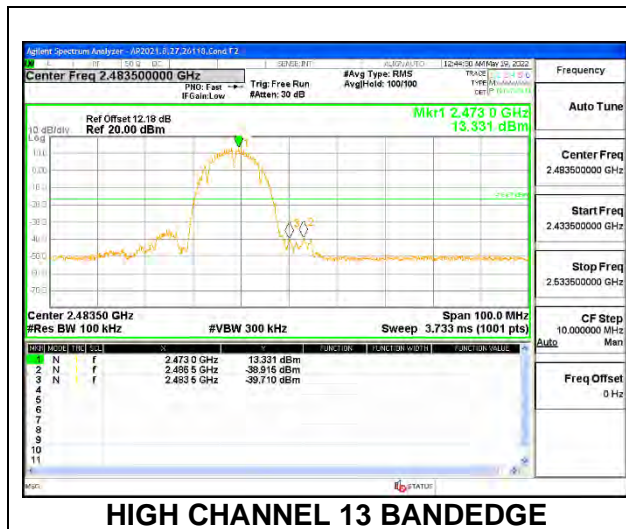

HIGH CHANNEL 13 BANDEDGE

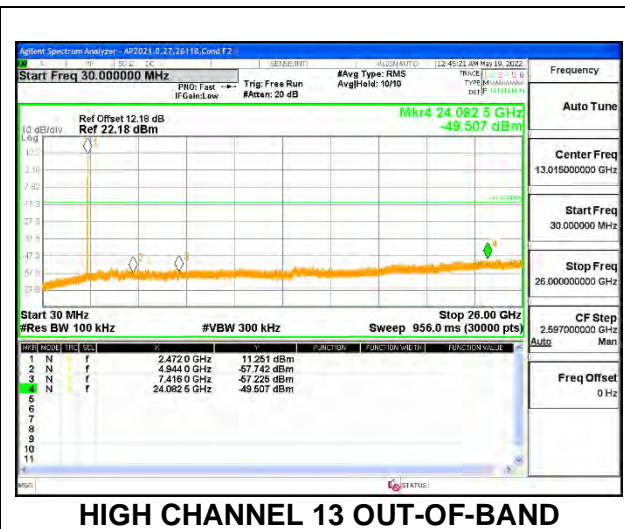

HIGH CHANNEL 13 OUT-OF-BAND

9.6.2. 802.11n HT20 MODE 1TX

1TX ANT 4 MODE

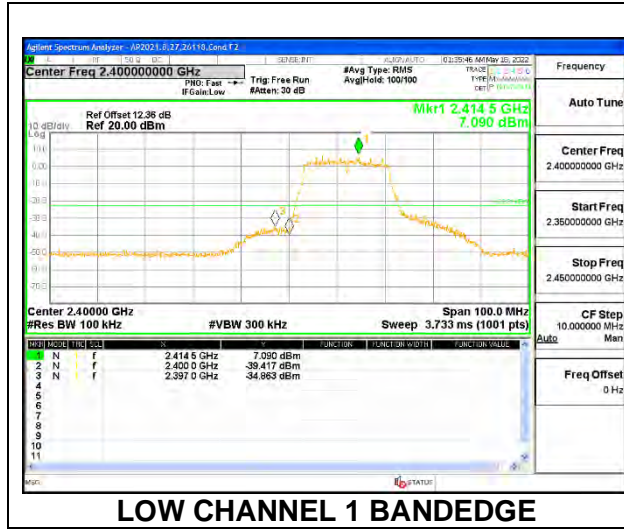

LOW CHANNEL 1 BANDEDGE

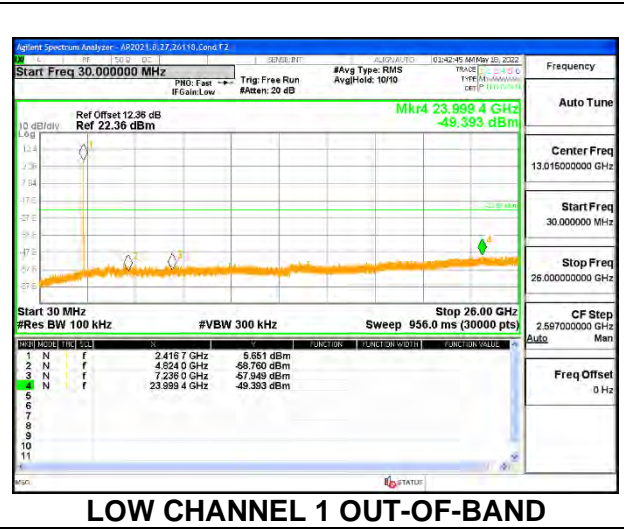

LOW CHANNEL 1 OUT-OF-BAND

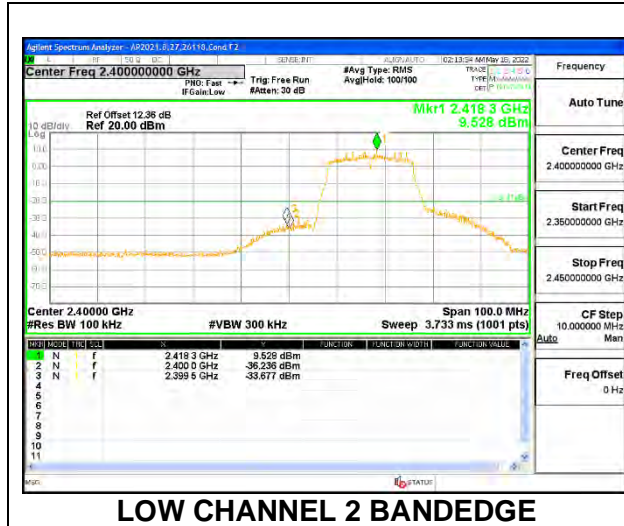

LOW CHANNEL 2 BANDEDGE

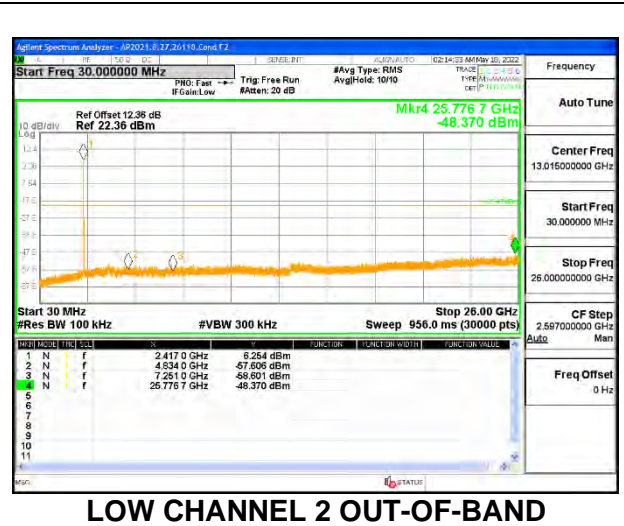

LOW CHANNEL 2 OUT-OF-BAND

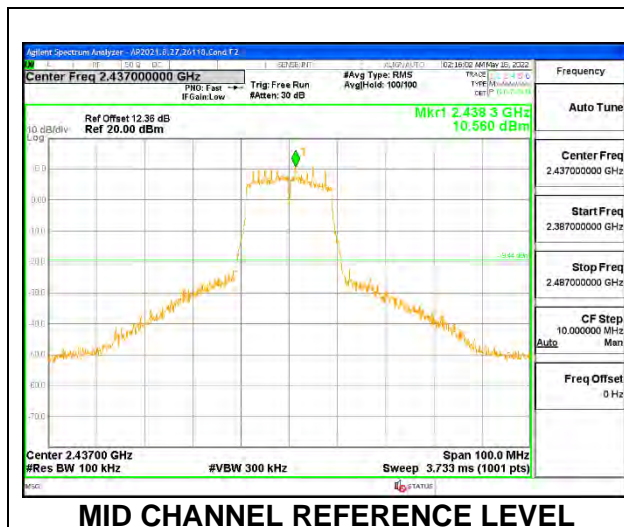

MID CHANNEL REFERENCE LEVEL

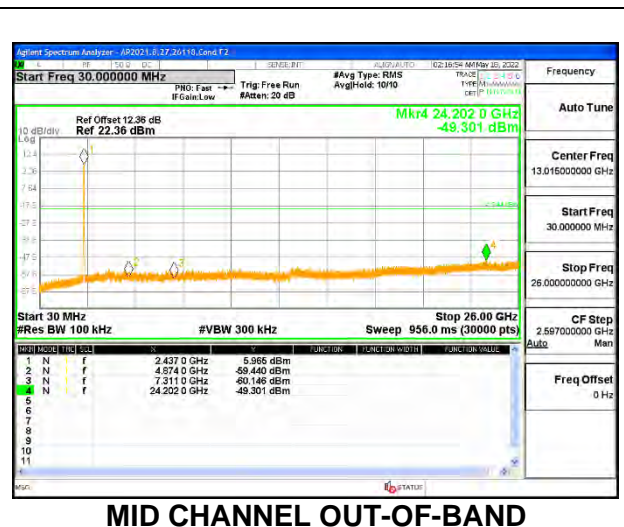

MID CHANNEL OUT-OF-BAND

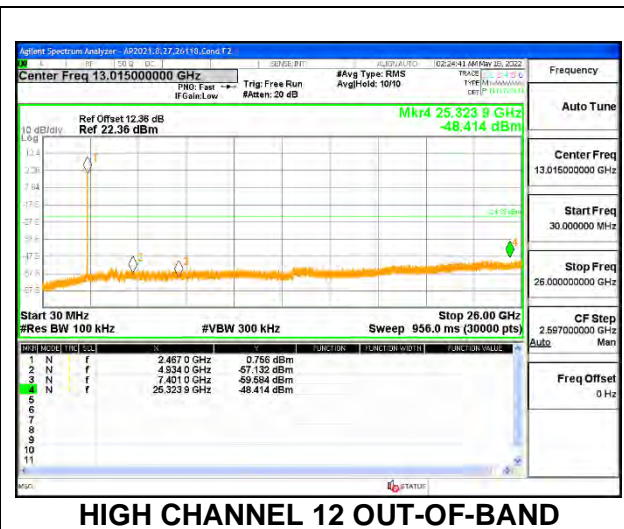
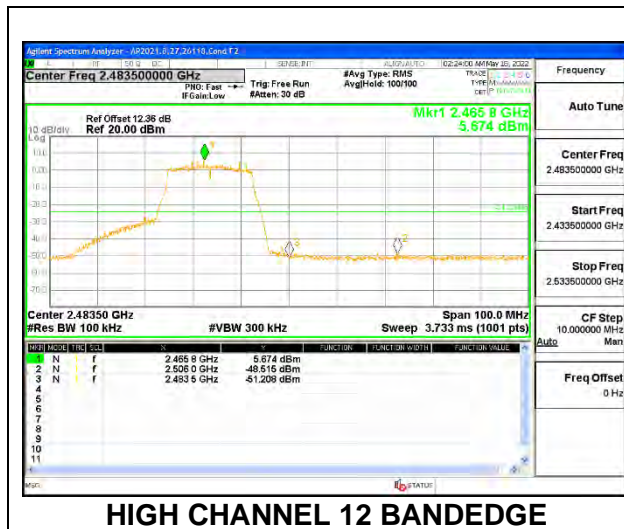
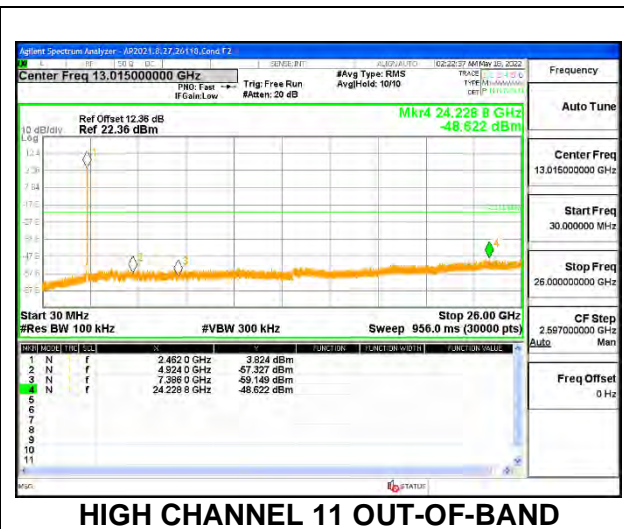
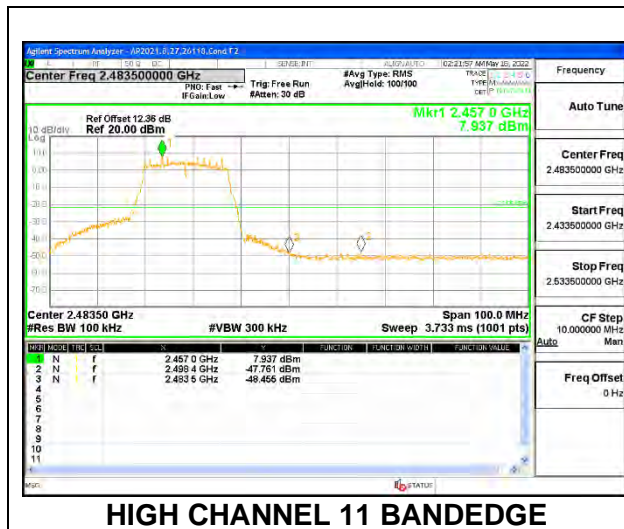
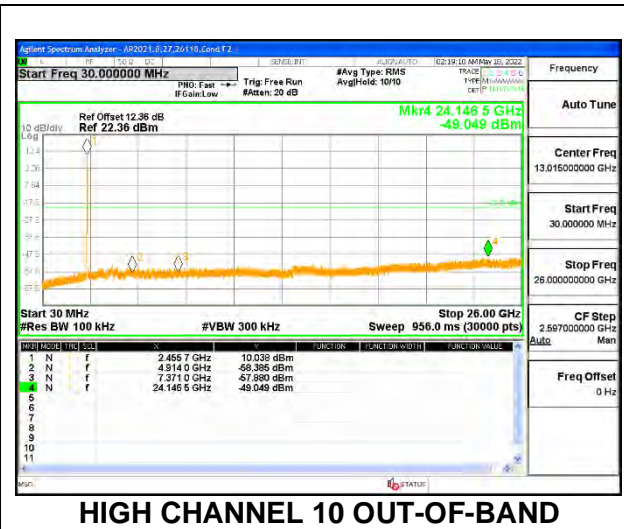
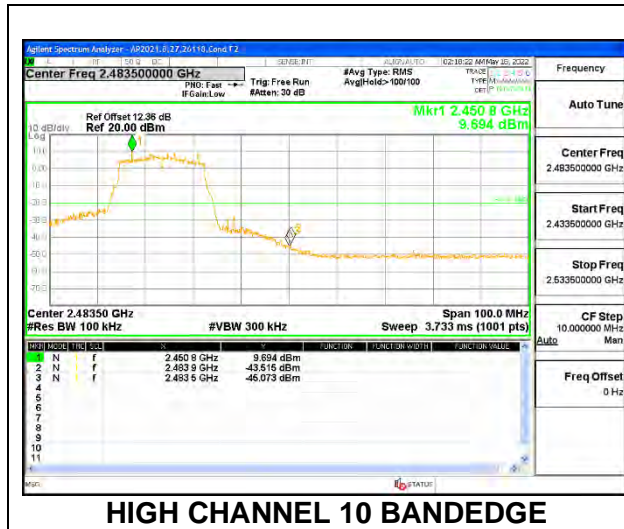

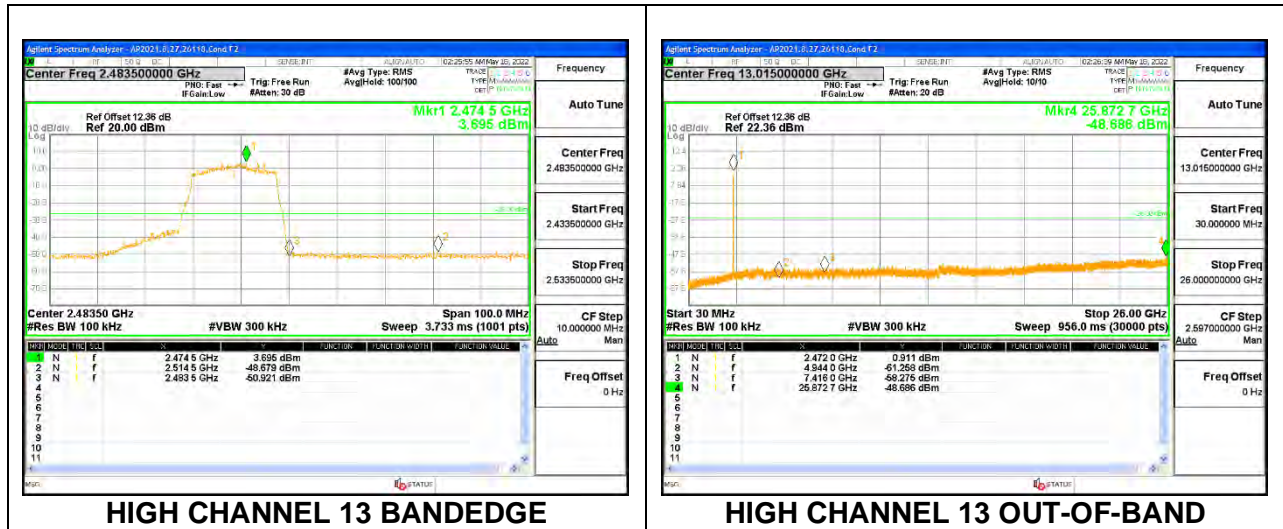

1TX ANT 3 MODE

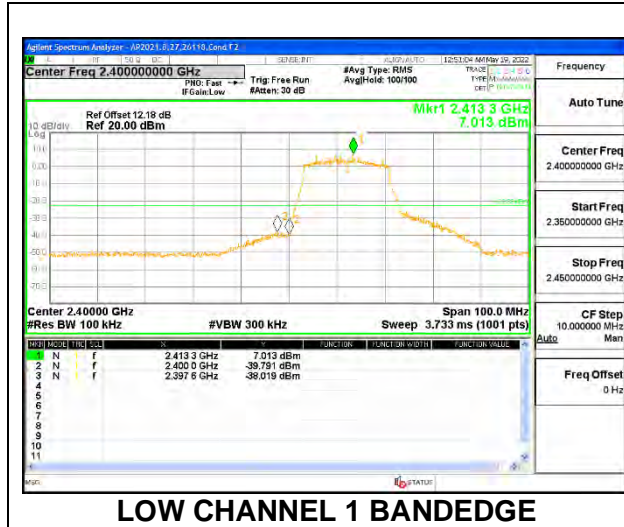

LOW CHANNEL 1 BANDEDGE

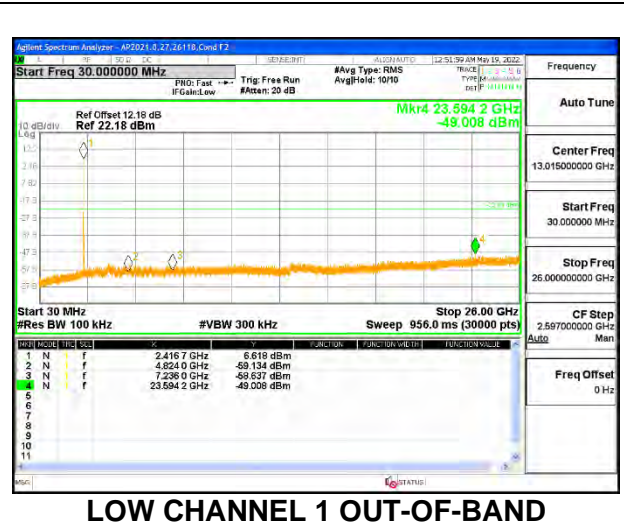

LOW CHANNEL 1 OUT-OF-BAND

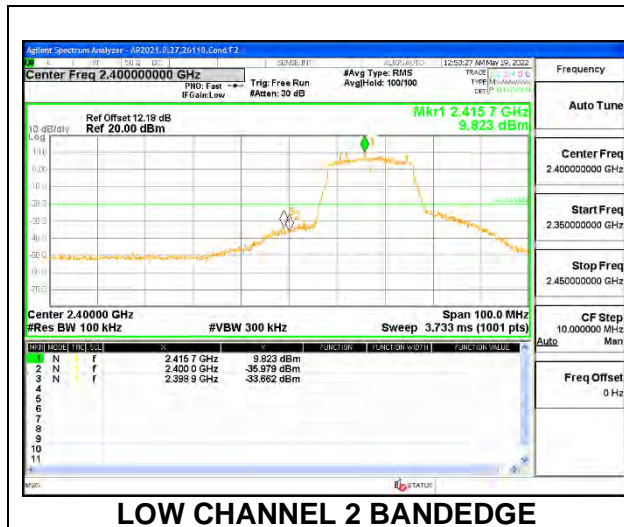

LOW CHANNEL 2 BANDEDGE

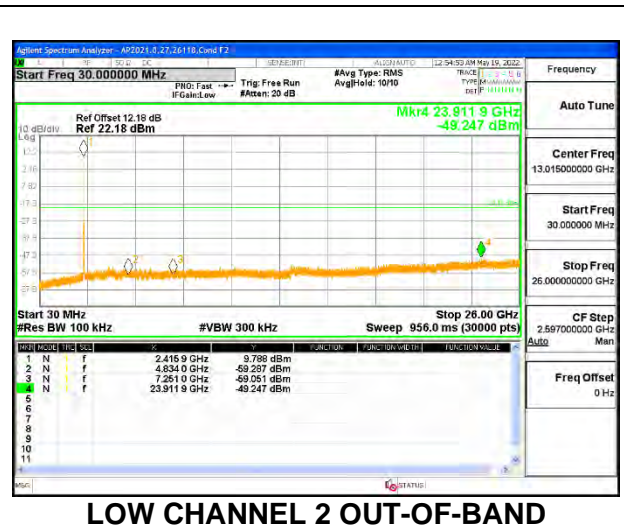

LOW CHANNEL 2 OUT-OF-BAND

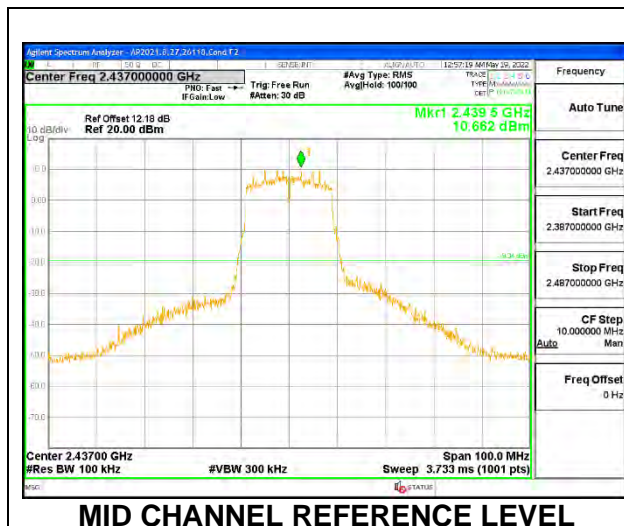

MID CHANNEL REFERENCE LEVEL

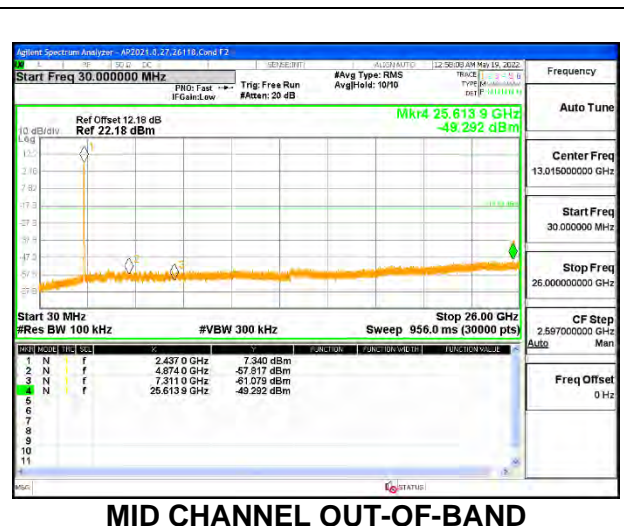

MID CHANNEL OUT-OF-BAND

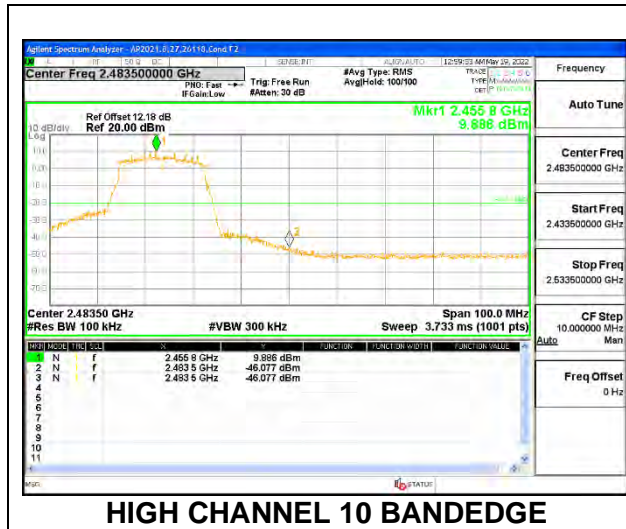

HIGH CHANNEL 10 BANDEDGE

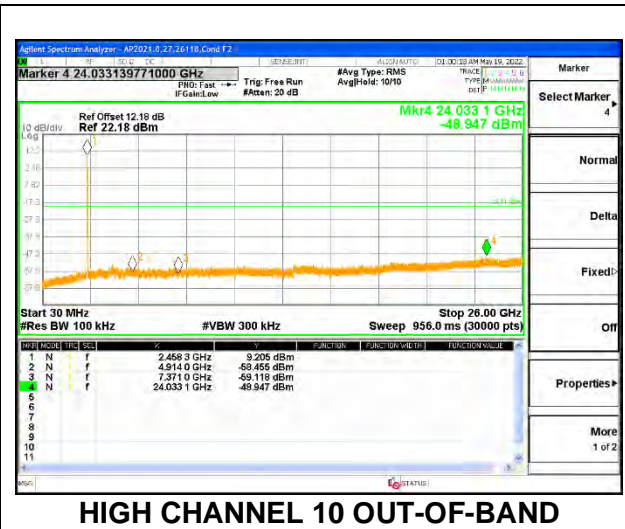

HIGH CHANNEL 10 OUT-OF-BAND

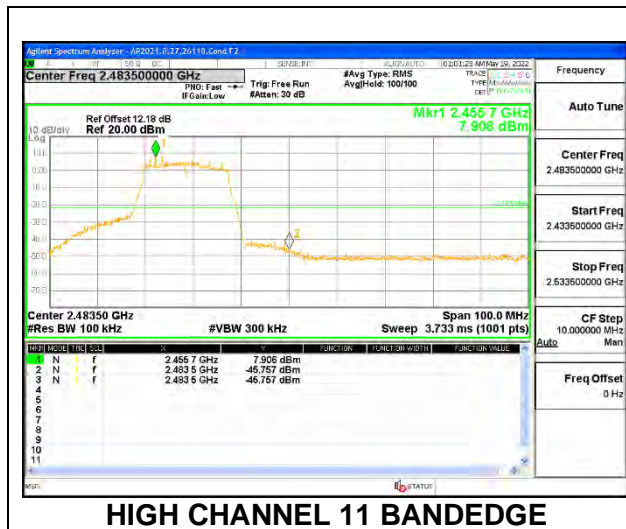

HIGH CHANNEL 11 BANDEDGE

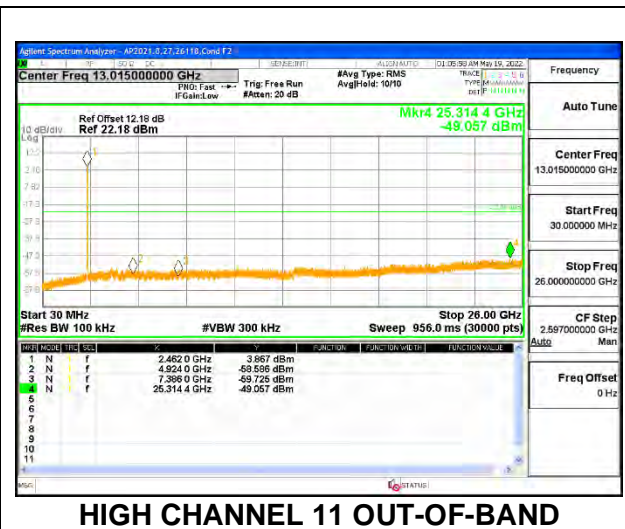

HIGH CHANNEL 11 OUT-OF-BAND

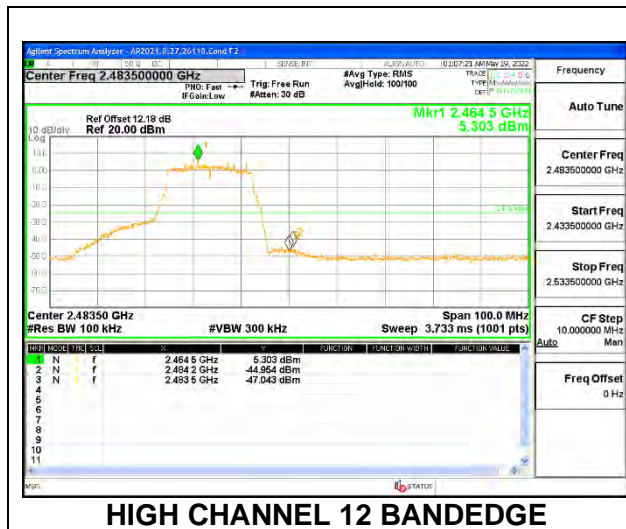

HIGH CHANNEL 12 BANDEDGE

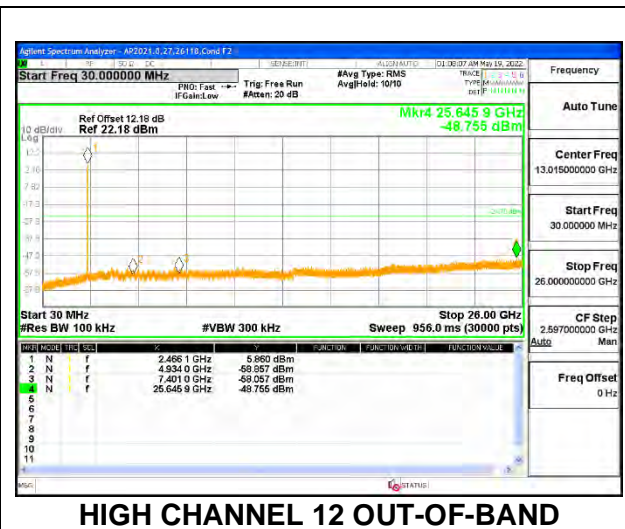

HIGH CHANNEL 12 OUT-OF-BAND

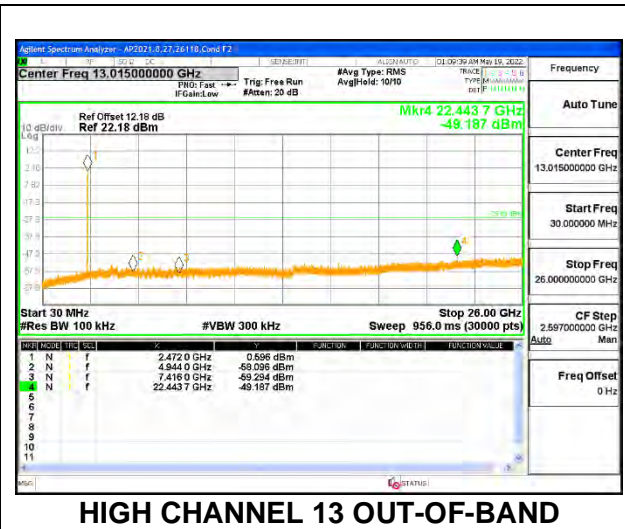
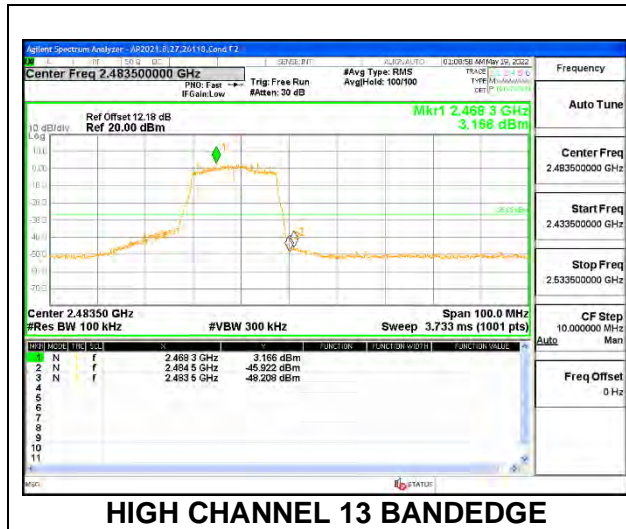

9.6.3. 802.11n HT20 CDD MODE 2TX

2TX ANT 4 + ANT 3 CDD MODE



LOW CHANNEL 1 BANDEDGE [ANT 4]



LOW CHANNEL 1 OUT-OF-BAND [ANT 4]

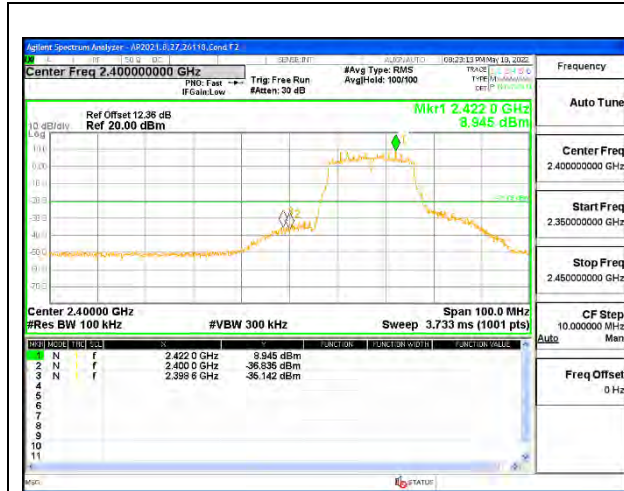

LOW CHANNEL 2 BANDEDGE [ANT 4]



LOW CHANNEL 2 OUT-OF-BAND [ANT 4]



LOW CHANNEL 3 BANDEDGE [ANT 4]



LOW CHANNEL 3 OUT-OF-BAND [ANT 4]

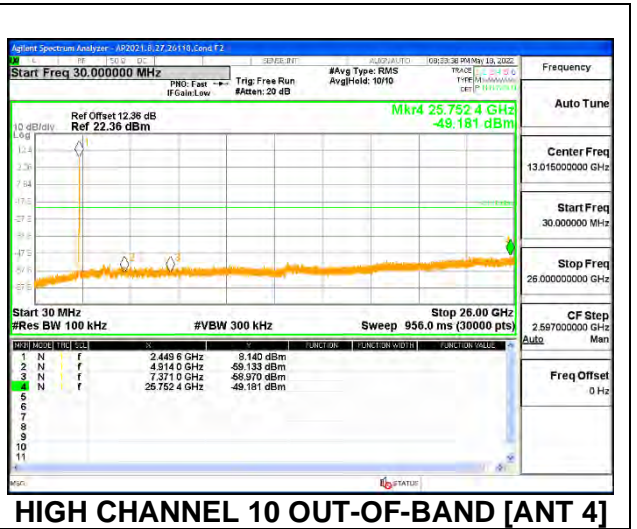
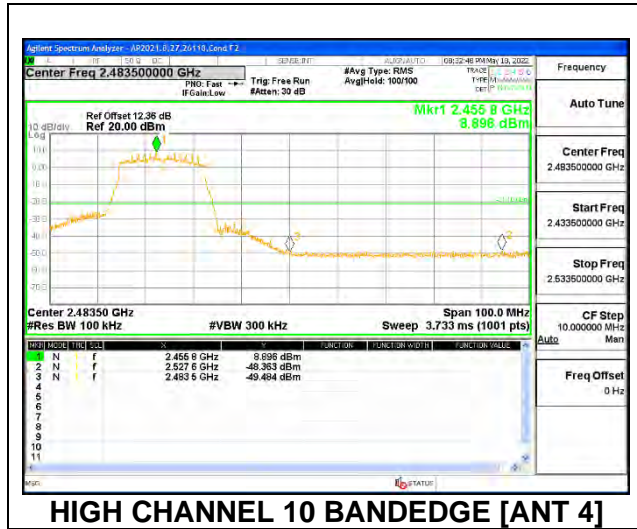
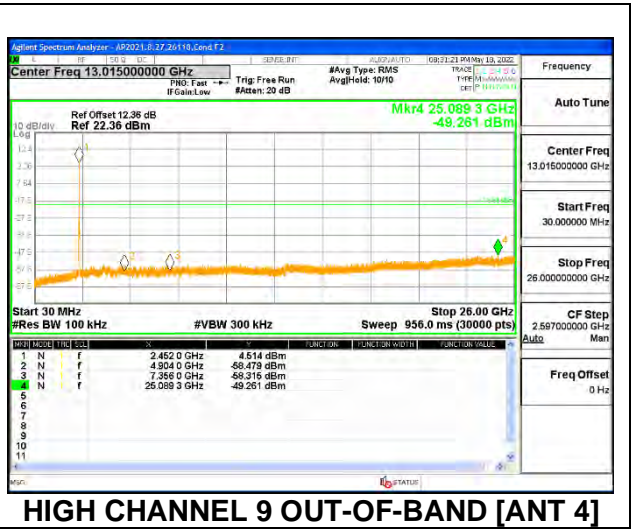
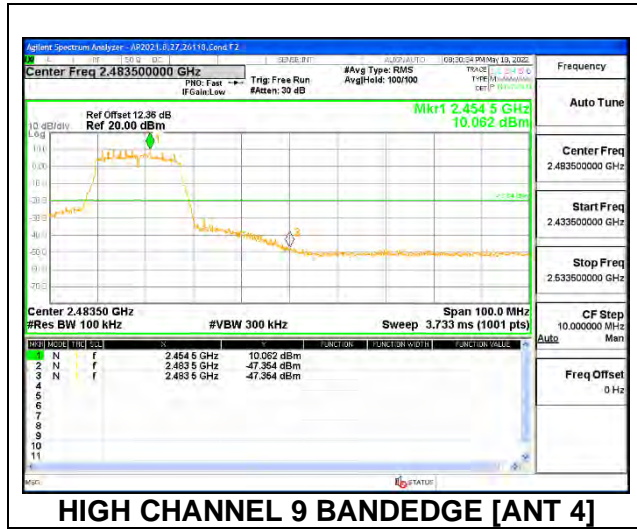
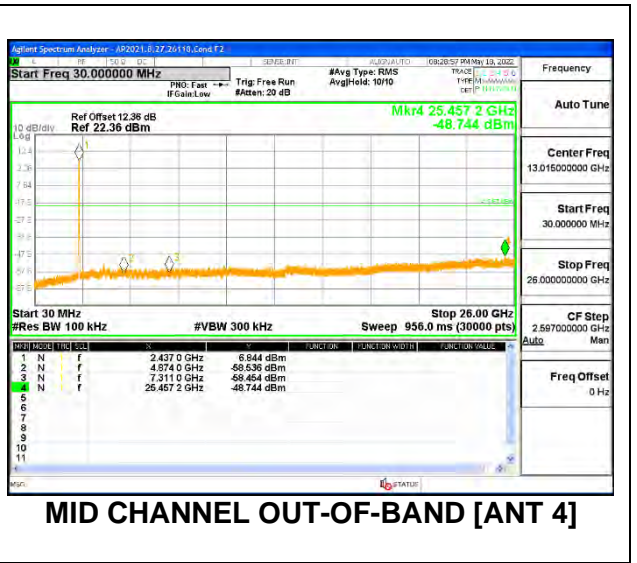
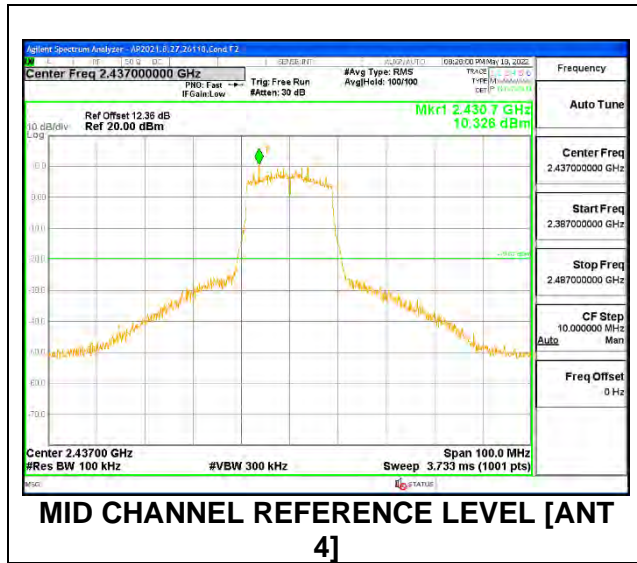

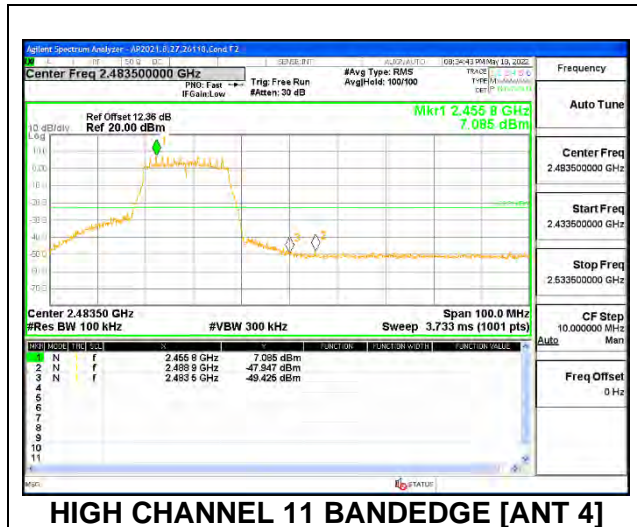

HIGH CHANNEL 11 BANDEDGE [ANT 4]

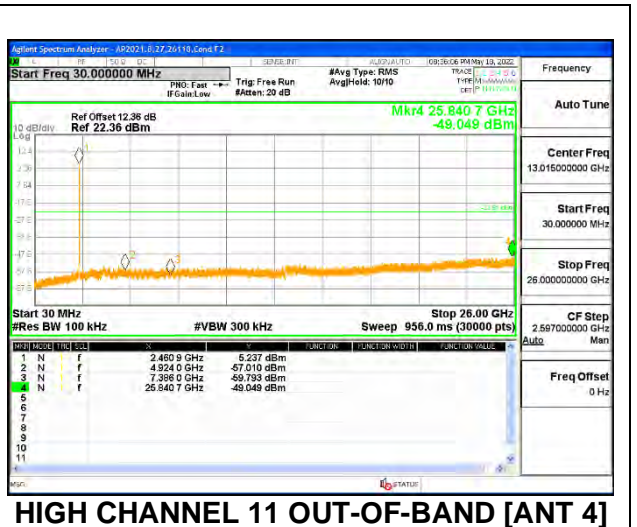

HIGH CHANNEL 11 OUT-OF-BAND [ANT 4]

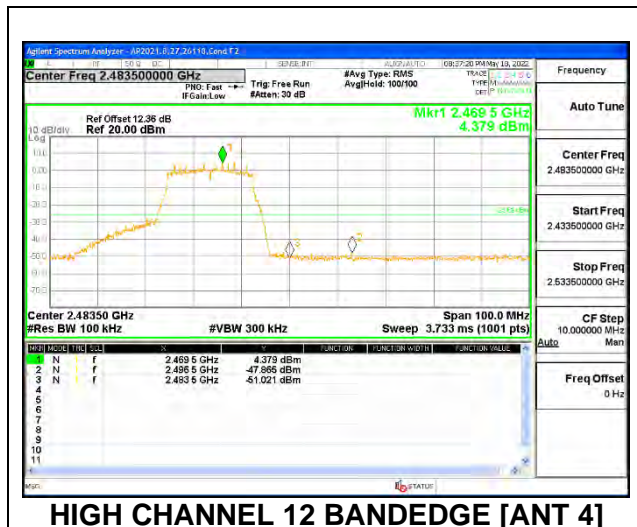

HIGH CHANNEL 12 BANDEDGE [ANT 4]

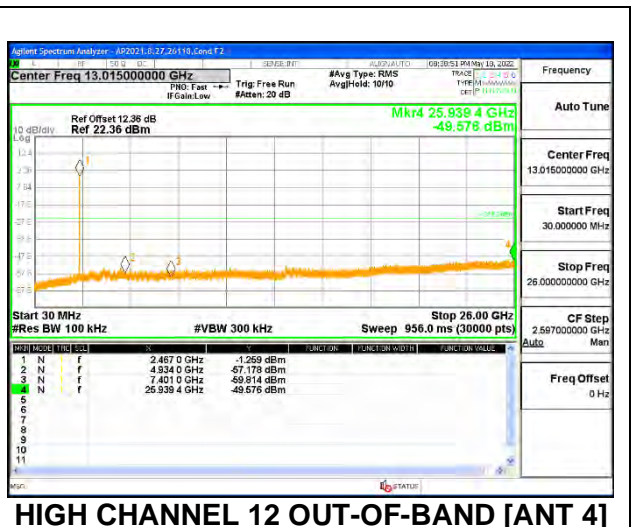

HIGH CHANNEL 12 OUT-OF-BAND [ANT 4]

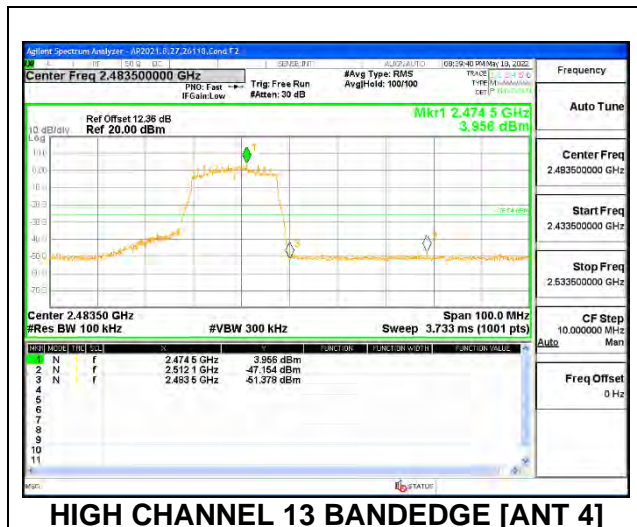

HIGH CHANNEL 13 BANDEDGE [ANT 4]

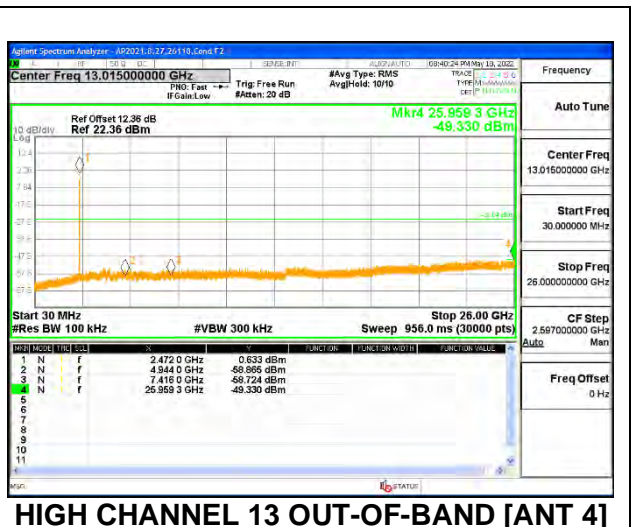

HIGH CHANNEL 13 OUT-OF-BAND [ANT 4]

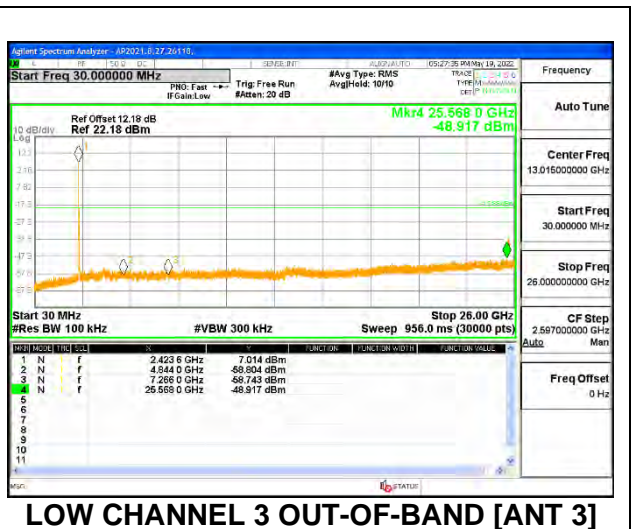
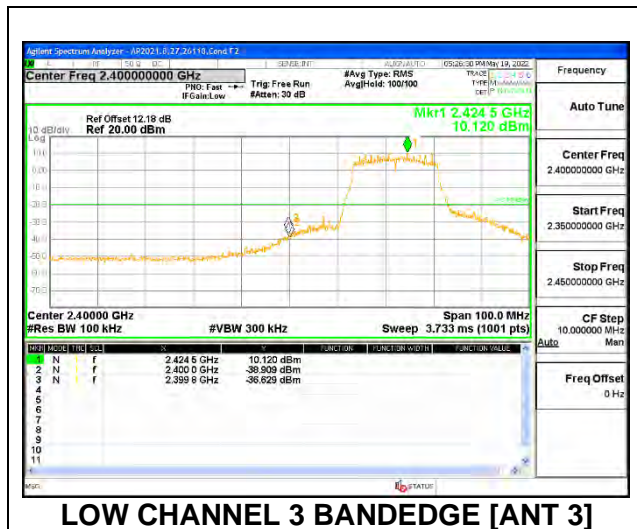
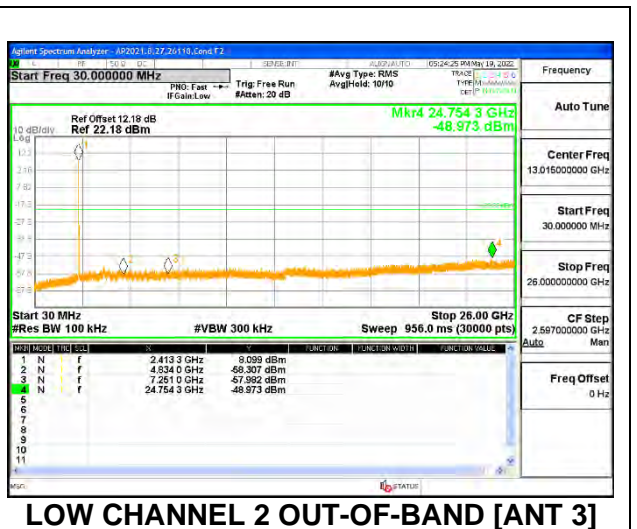
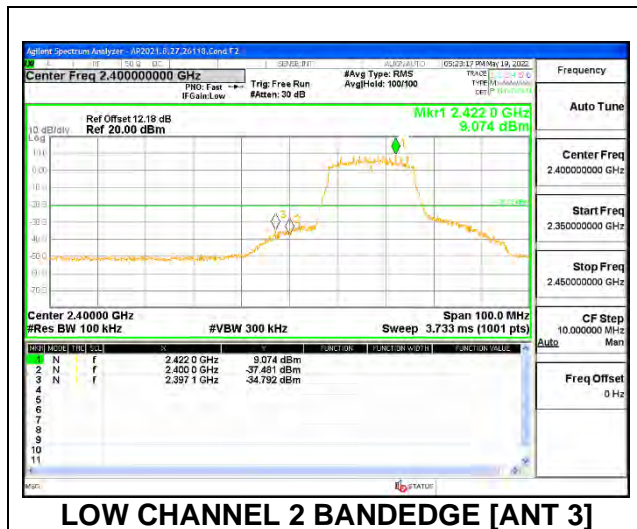
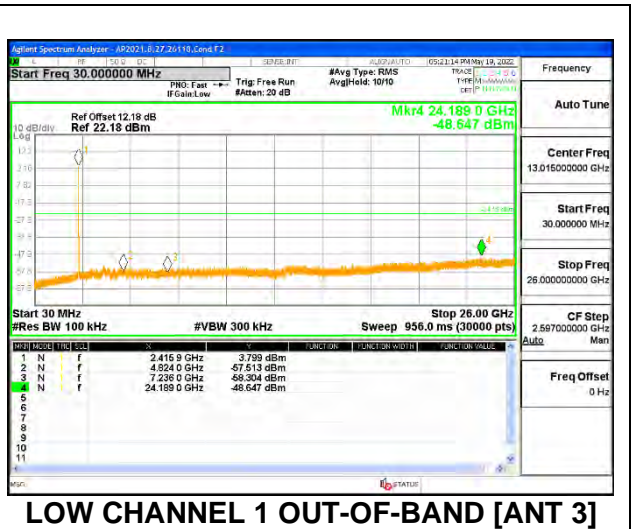
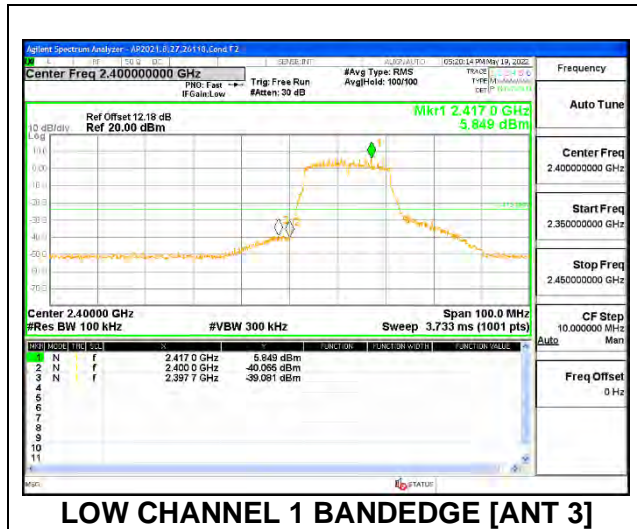

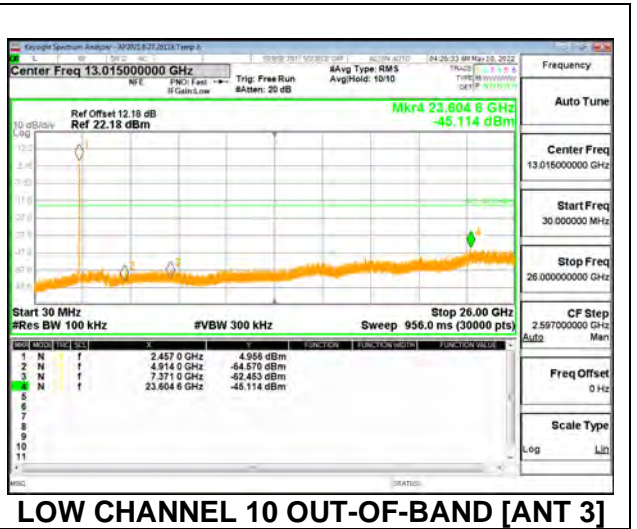
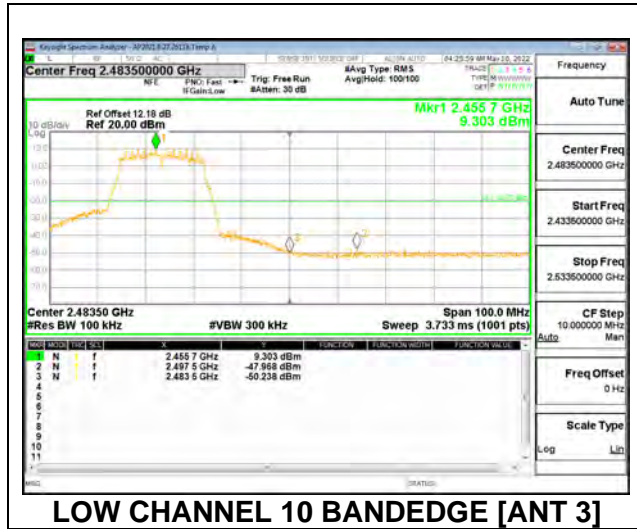
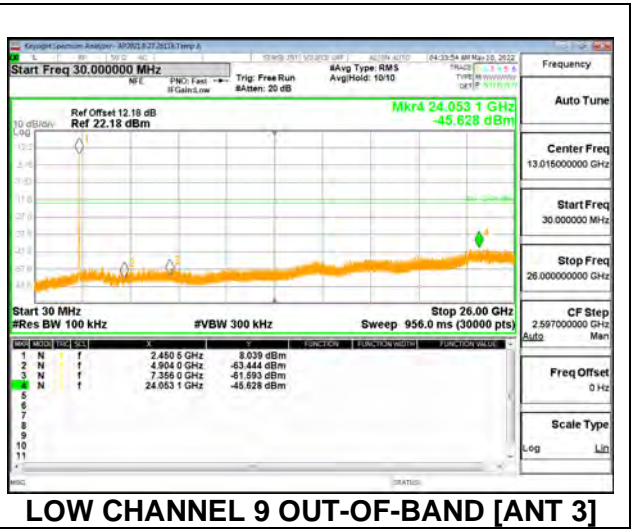
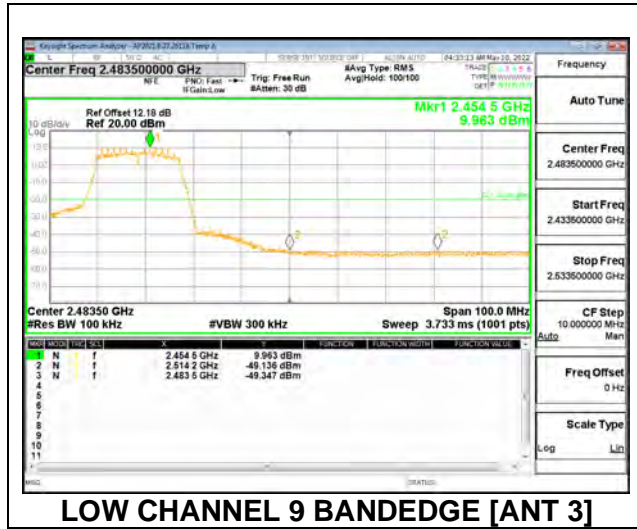
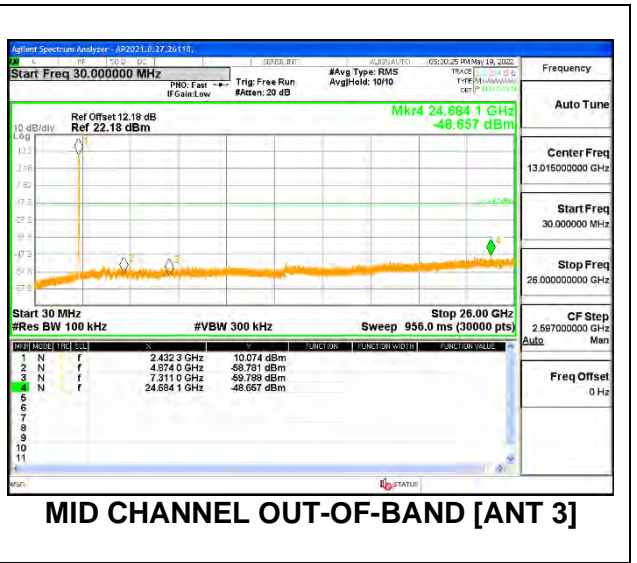
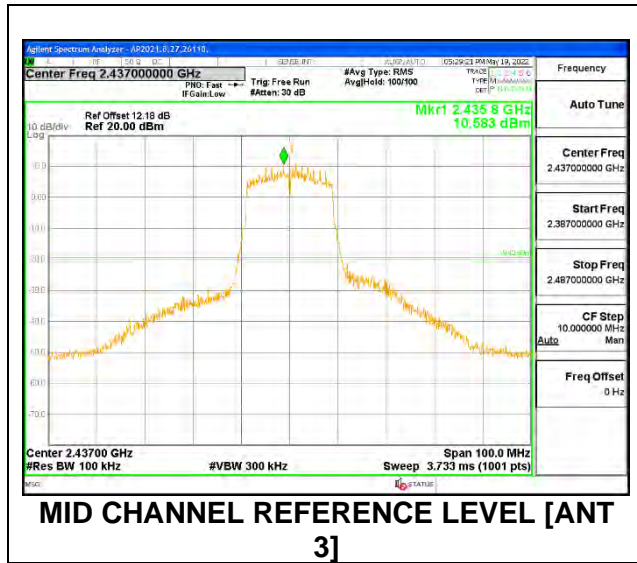

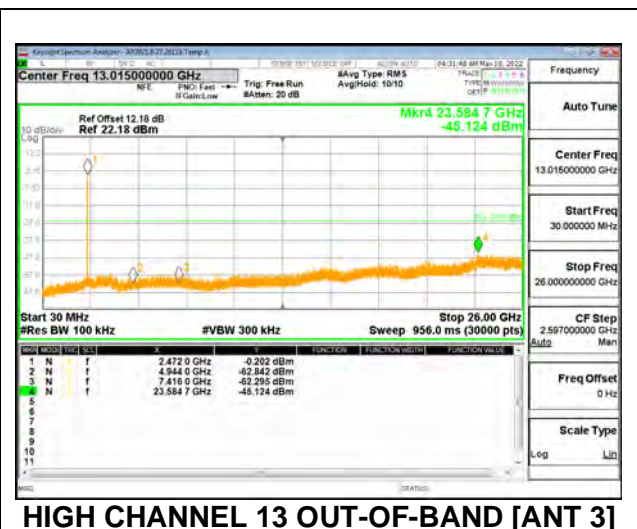
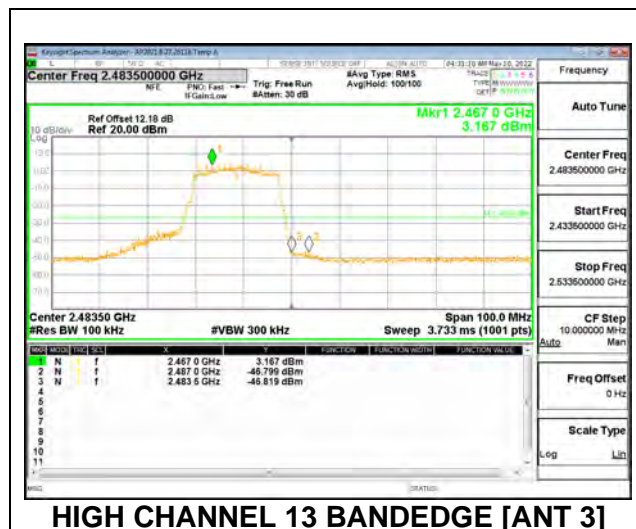
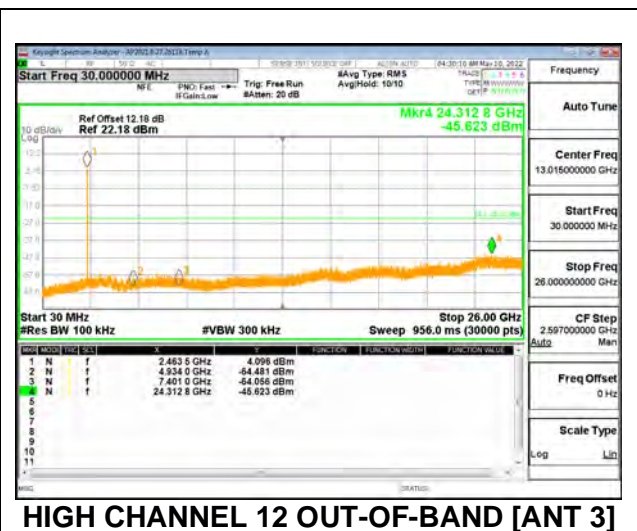
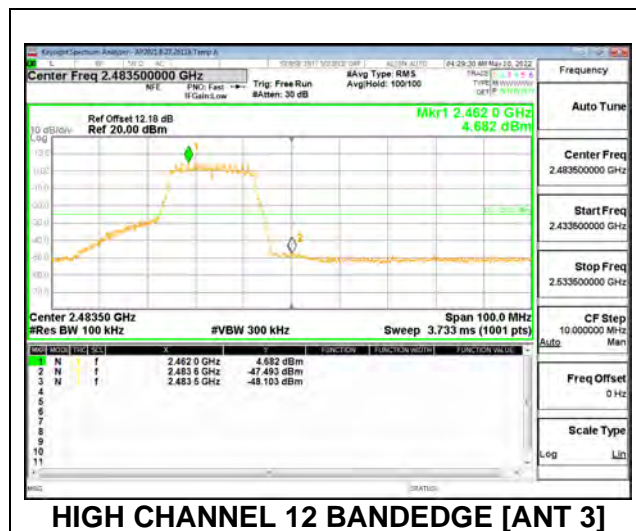
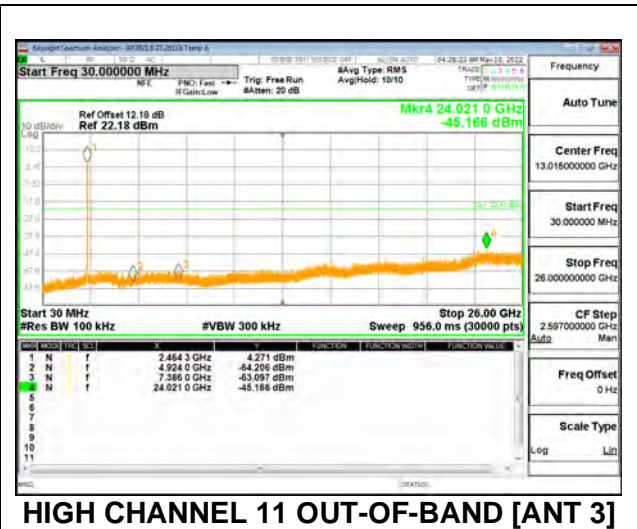
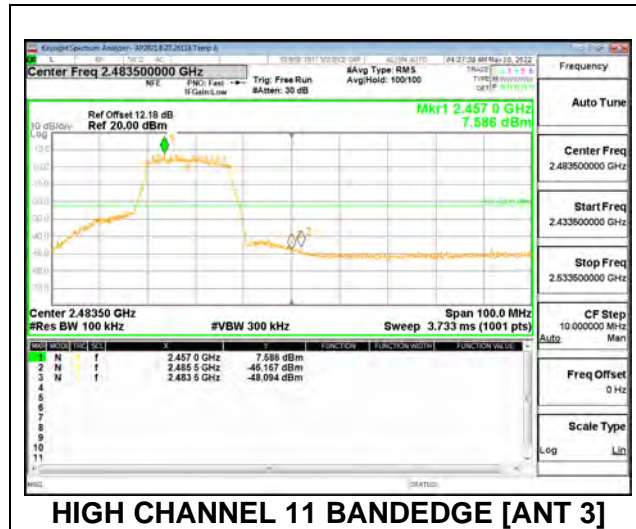

9.6.4. 802.11ax HE20 MODE 1TX

1TX ANT 4 MODE, 26-Tone RU Index 0

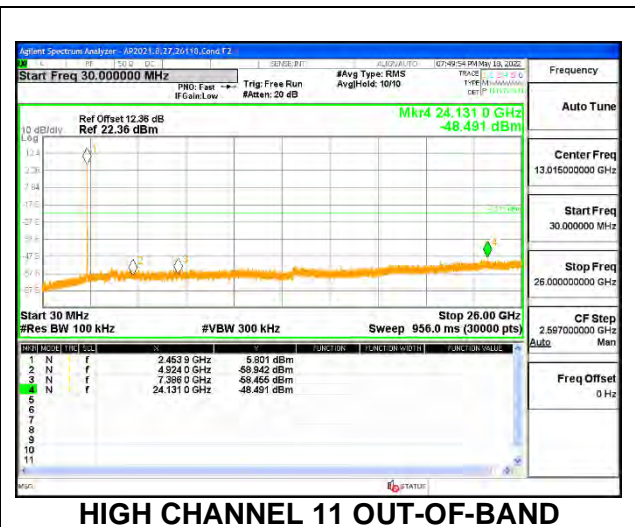
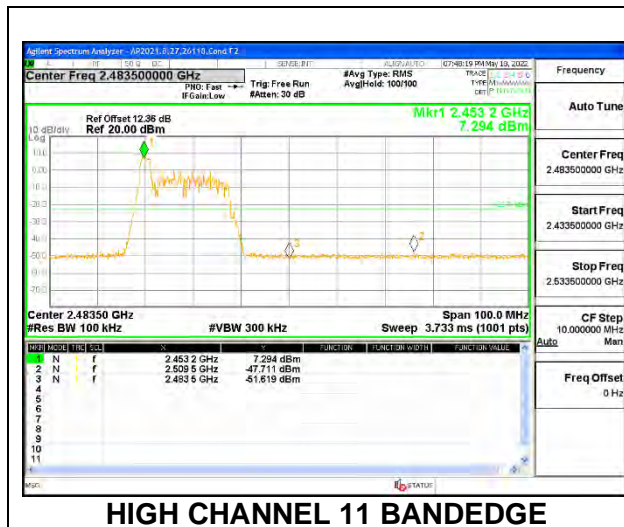
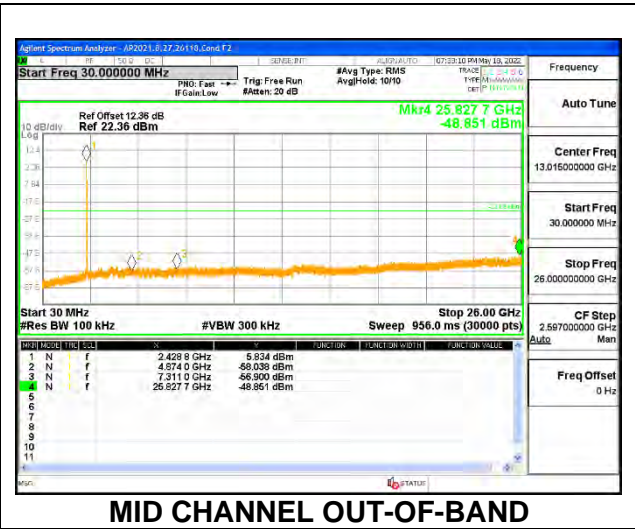
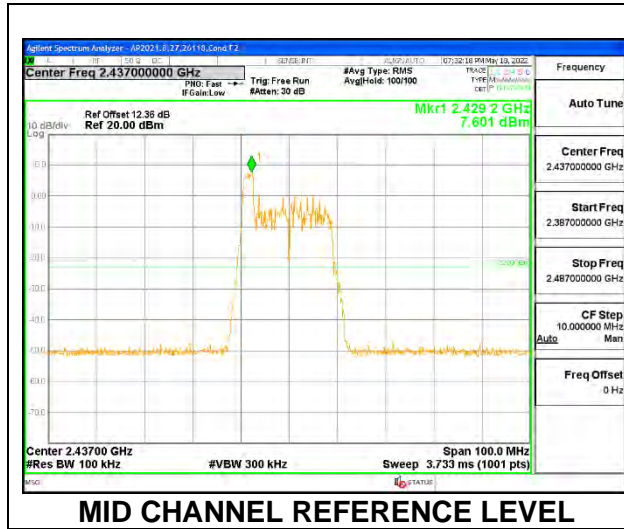
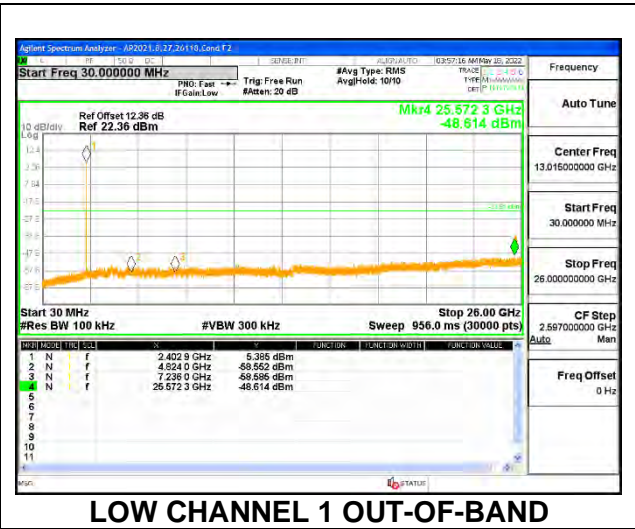
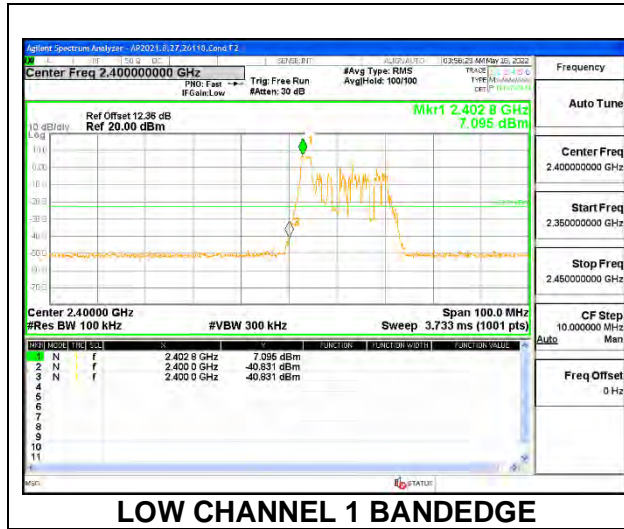

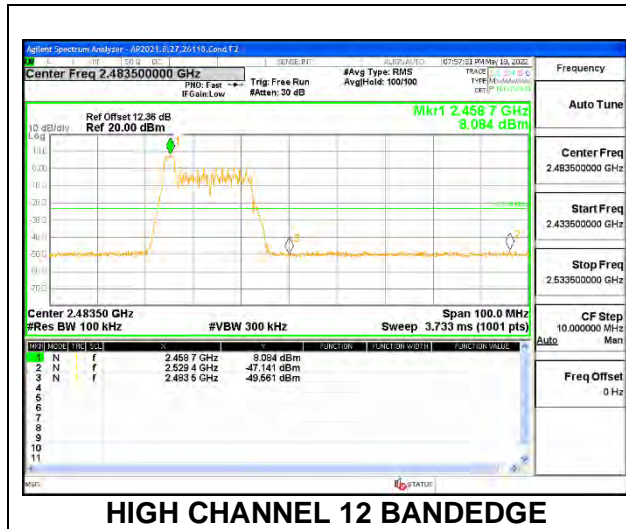

HIGH CHANNEL 12 BANDEDGE

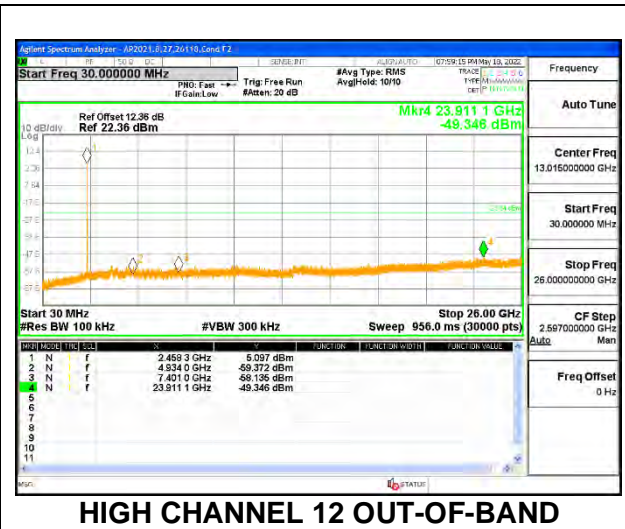

HIGH CHANNEL 12 OUT-OF-BAND

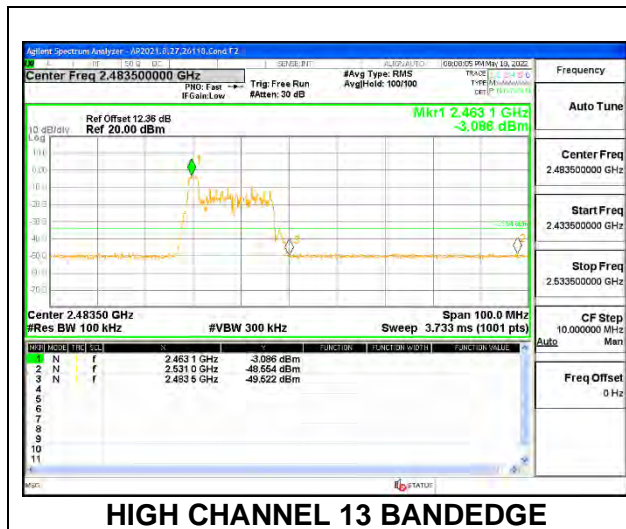

HIGH CHANNEL 13 BANDEDGE

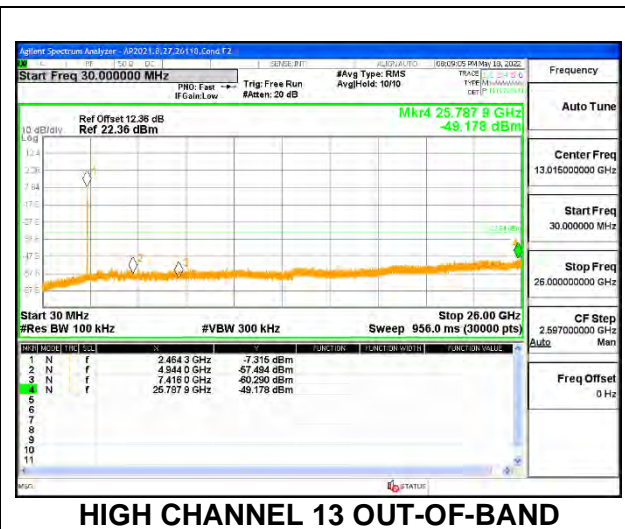

HIGH CHANNEL 13 OUT-OF-BAND

1TX ANT 4 MODE, 26-Tone RU Index 4

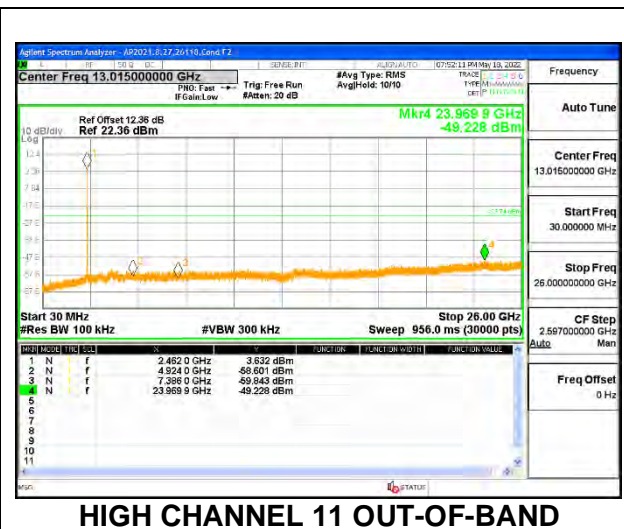
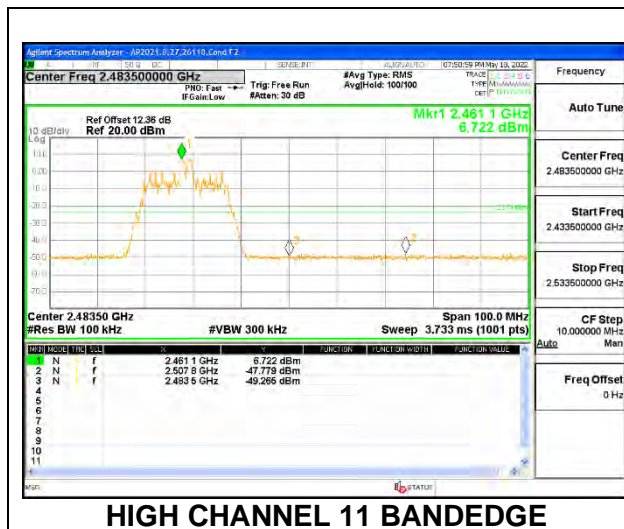
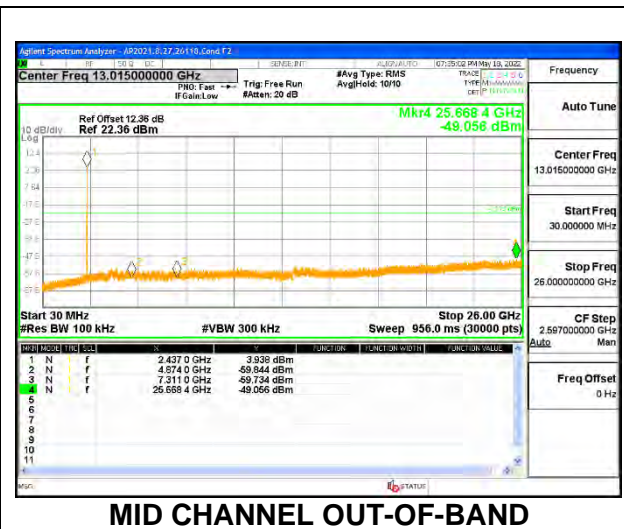
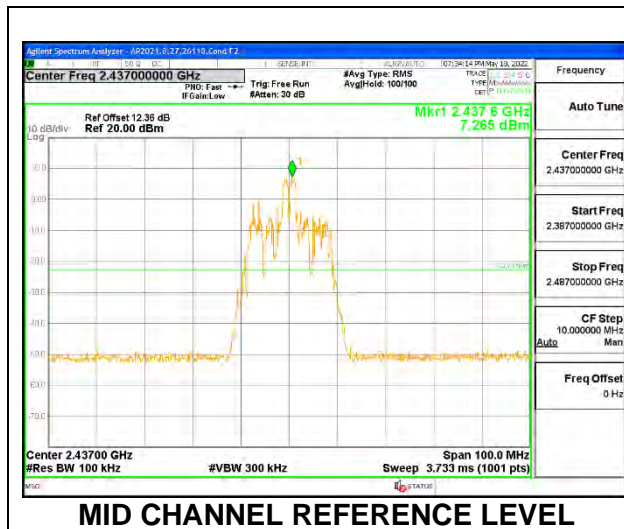
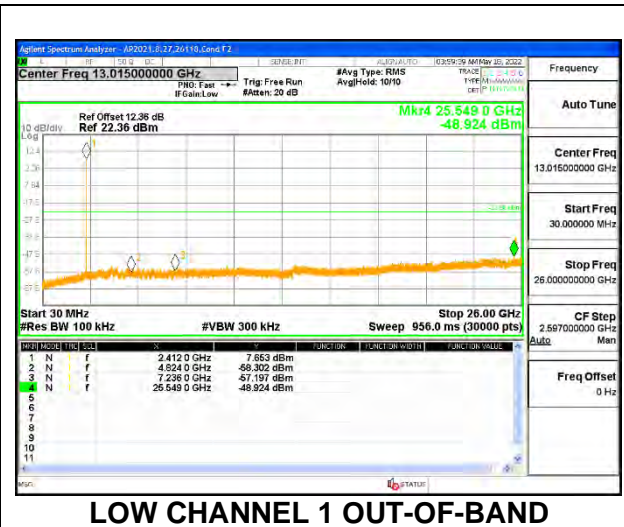
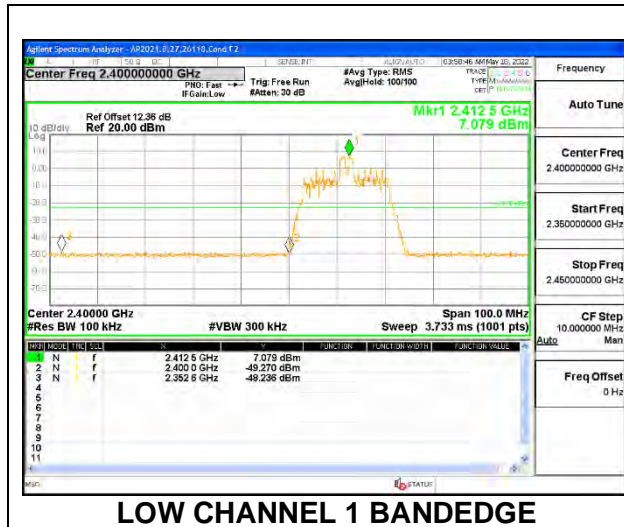

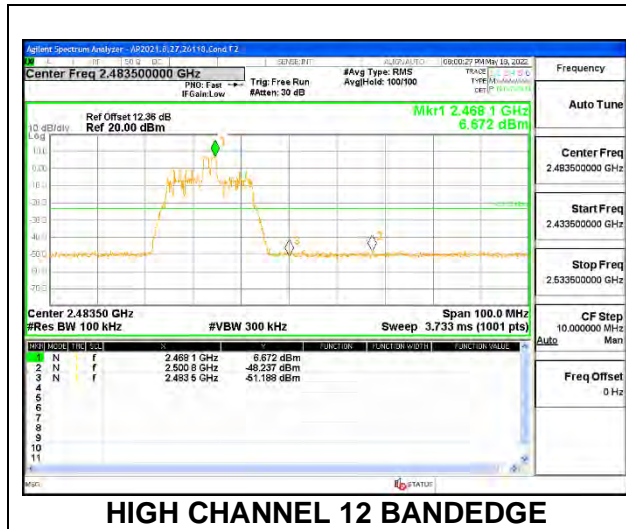

HIGH CHANNEL 12 BANDEDGE

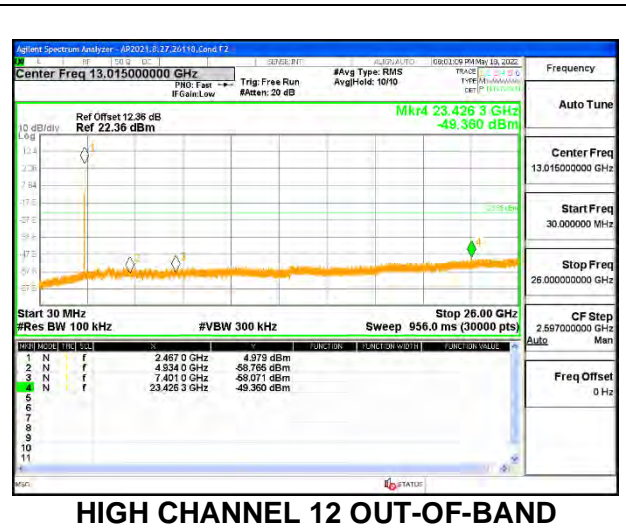

HIGH CHANNEL 12 OUT-OF-BAND

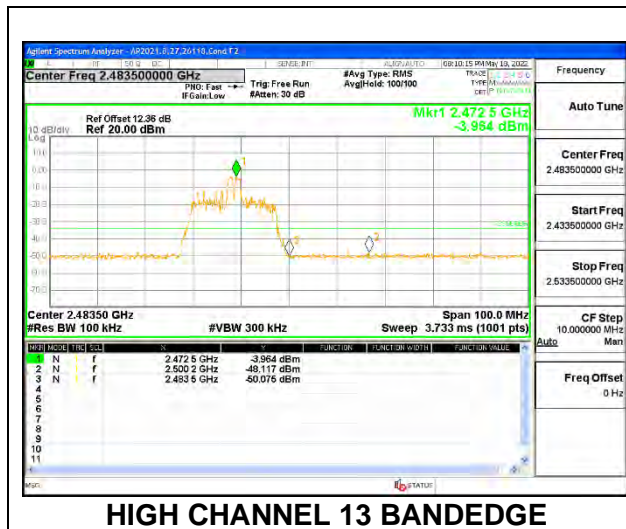

HIGH CHANNEL 13 BANDEDGE

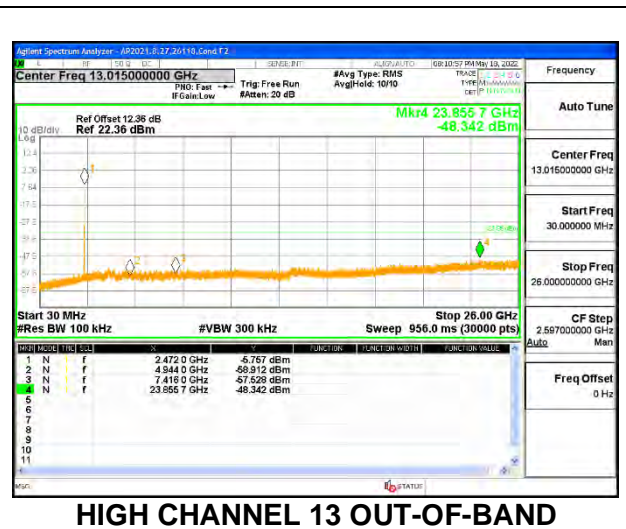

HIGH CHANNEL 13 OUT-OF-BAND

1TX ANT 4 MODE, 26-Tone RU Index 8

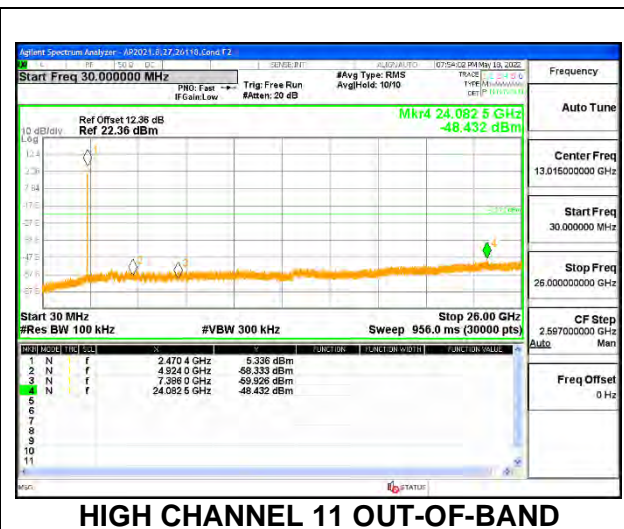
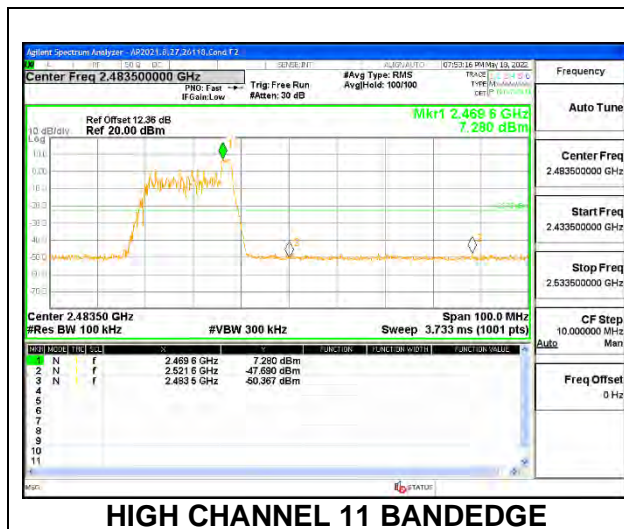
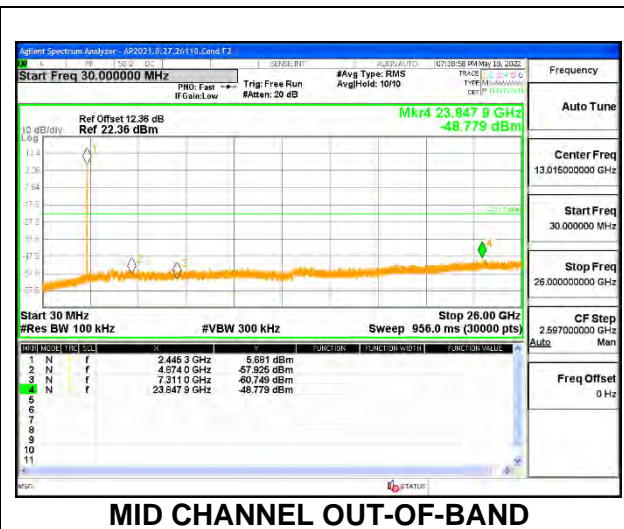
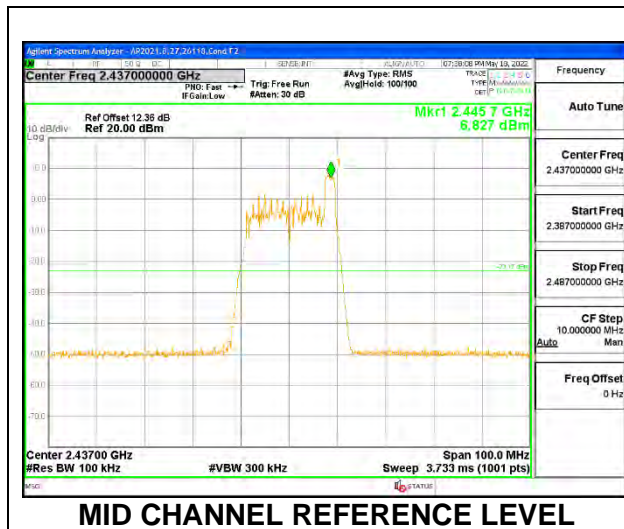
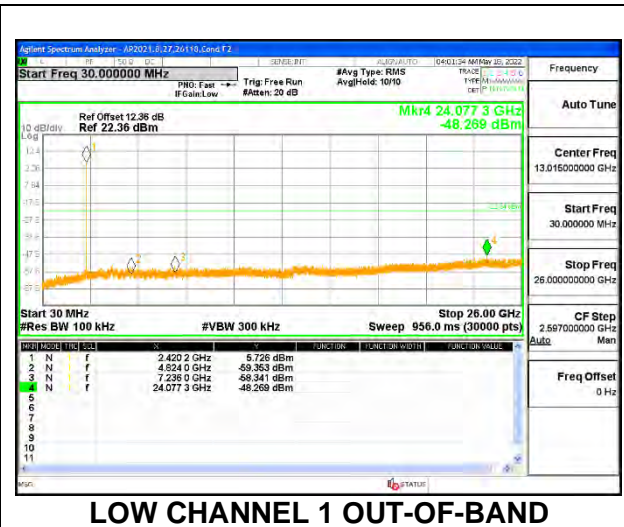
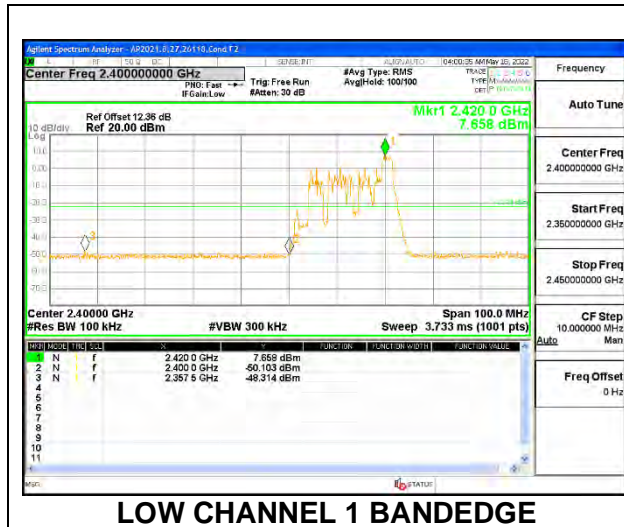

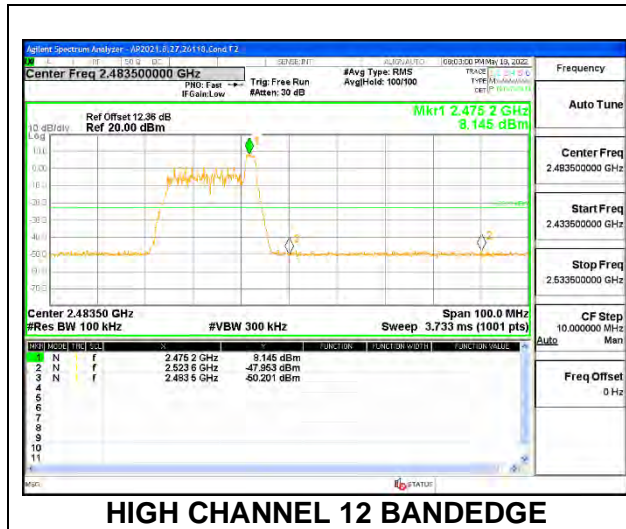

HIGH CHANNEL 12 BANDEDGE

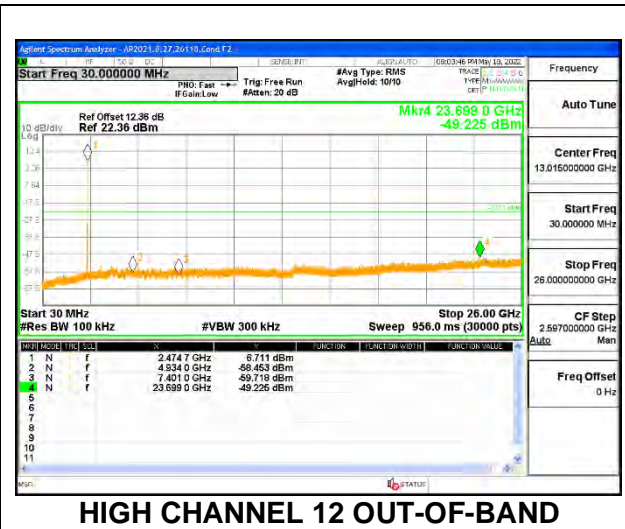

HIGH CHANNEL 12 OUT-OF-BAND

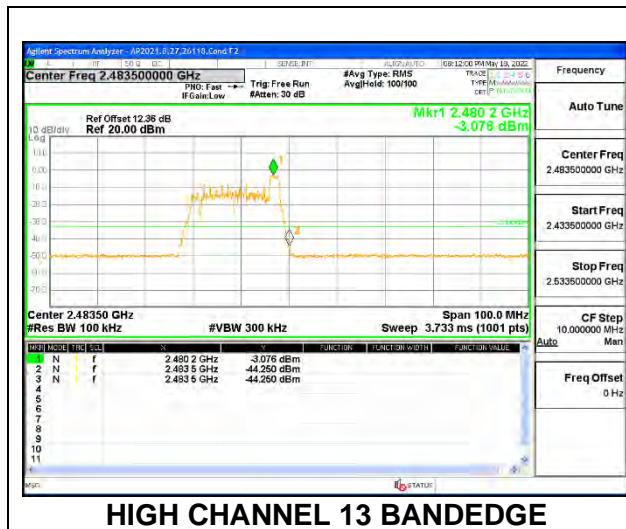

HIGH CHANNEL 13 BANDEDGE

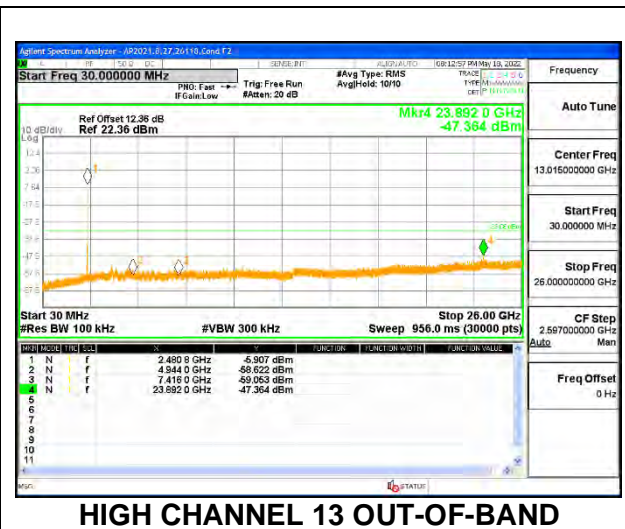

HIGH CHANNEL 13 OUT-OF-BAND

1TX ANT 4 MODE, SU Mode

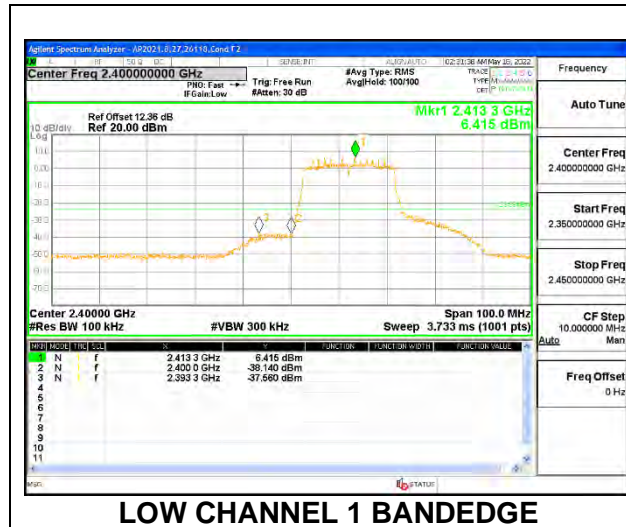

LOW CHANNEL 1 BANDEDGE

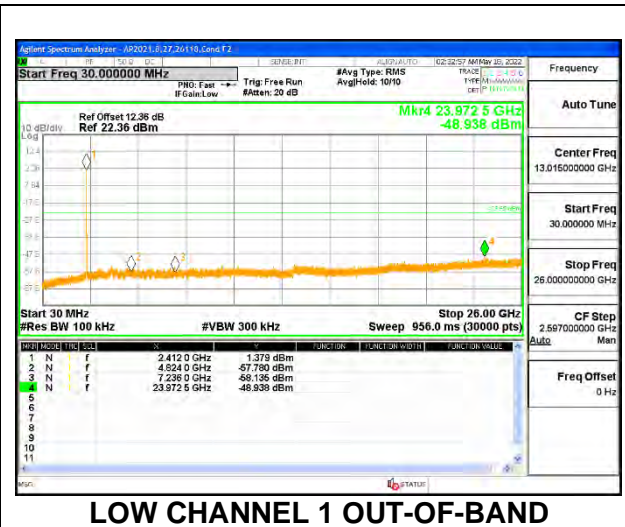

LOW CHANNEL 1 OUT-OF-BAND

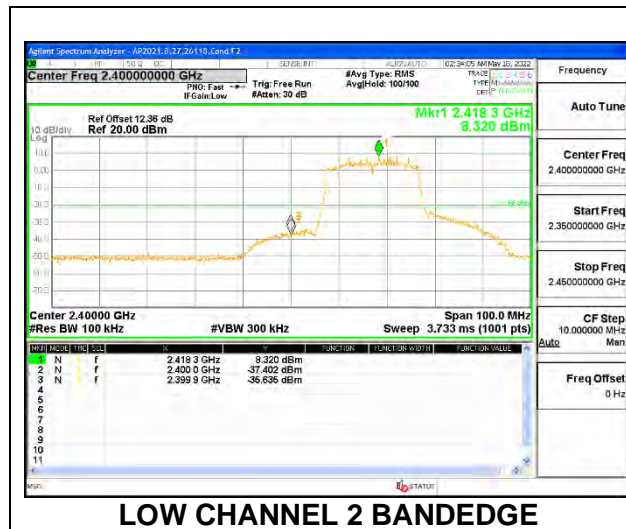

LOW CHANNEL 2 BANDEDGE

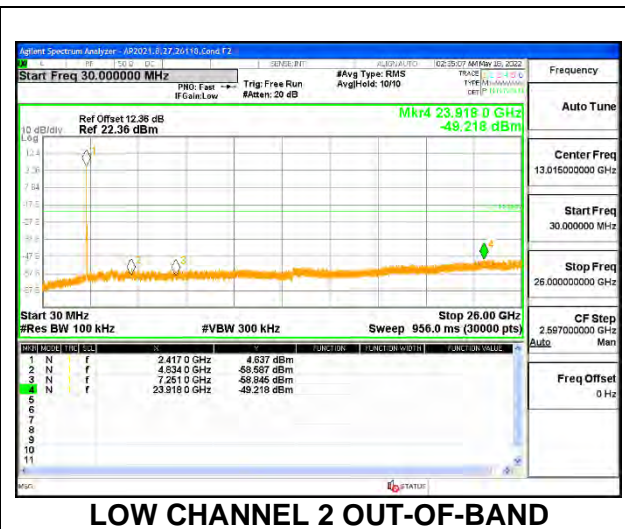

LOW CHANNEL 2 OUT-OF-BAND

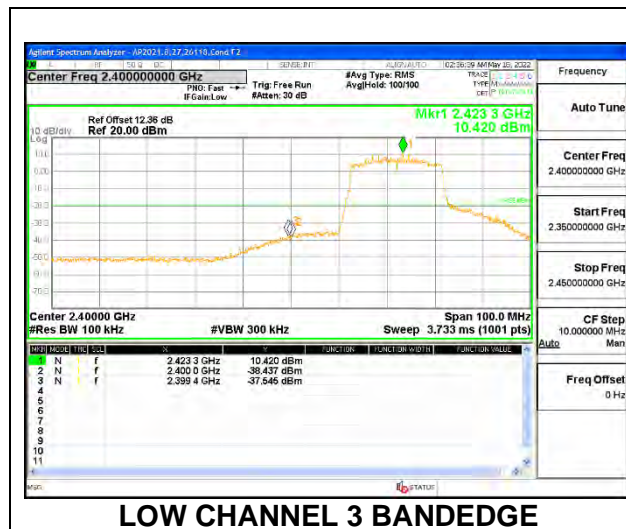

LOW CHANNEL 3 BANDEDGE

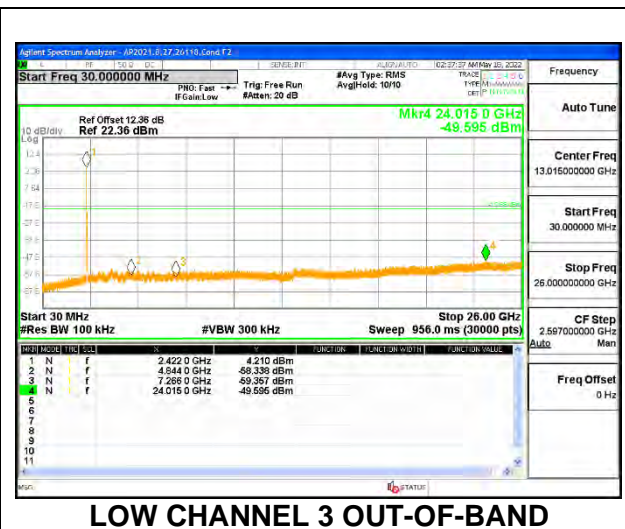

LOW CHANNEL 3 OUT-OF-BAND

