



TEST REPORT

Report Number : 13573771-E4V2

Applicant : APPLE, INC.
1 APPLE PARK WAY
CUPERTINO, CA 95014, U.S.A

Model : A2484 (Parent Model, Full Test)
A2641, A2643, A2644, A2645 (Variant Models)

FCC ID : BCG-E4003A (Parent Model)
BCG-E4005A, BCG-E4035A, BCG-E4036A (Variant Models)

IC : 579C-E4003A (Parent Model)
579C-E4005A, 579C-E4035A, 579C-E4036A (Variant Models)

EUT Description : SMARTPHONE

Test Standard(s) : FCC 47 CFR PART 15 SUBPART C
ISED RSS-247 ISSUE 2
ISED RSS-GEN ISSUE 5 + A1 + A2

Date Of Issue:

August 05, 2021

Prepared by:

UL Verification Services Inc.
47173 Benicia Street
Fremont, CA 94538 U.S.A.
TEL: (510) 319-4000
FAX: (510) 661-0888



REPORT REVISION HISTORY

Rev.	Issue Date	Revisions	Revised By
V1	7/30/2021	Initial Issue	Chin Pang
V2	8/5/2021	Address TCB's question on page 64/65	Chin Pang

REPORT REVISION HISTORY	2
1. ATTESTATION OF TEST RESULTS	5
2. TEST RESULTS SUMMARY	7
3. TEST METHODOLOGY	7
4. FACILITIES AND ACCREDITATION	7
5. DECISION RULES AND MEASUREMENT UNCERTAINTY	8
5.1. METROLOGICAL TRACEABILITY	8
5.2. DECISION RULES.....	8
5.3. MEASUREMENT UNCERTAINTY.....	8
6. EQUIPMENT UNDER TEST	9
6.1. EUT DESCRIPTION	9
6.2. MAXIMUM OUTPUT POWER.....	9
6.3. DESCRIPTION OF AVAILABLE ANTENNAS	9
6.4. SOFTWARE AND FIRMWARE.....	10
6.5. WORST-CASE CONFIGURATION AND MODE.....	10
6.6. DESCRIPTION OF TEST SETUP.....	11
7. MEASUREMENT METHOD.....	14
8. TEST AND MEASUREMENT EQUIPMENT	15
9. ANTENNA PORT TEST RESULTS	16
9.1. ON TIME AND DUTY CYCLE.....	16
9.2. 99% BANDWIDTH.....	19
9.2.1. 802.11b MODE 1TX.....	20
9.2.2. 802.11n HT20 MODE	22
9.2.3. 802.11n HT20 CDD MODE	24
9.2.4. 802.11ax HE20 MODE	25
9.2.5. 802.11ax HE20 OFDMA MODE 2TX	33
9.3. 6dB BANDWIDTH.....	37
9.3.1. 802.11b MODE 1TX.....	38
9.3.2. 802.11ax HE20 MODE	40
9.3.3. 802.11ax HE20 OFDMA MODE 2TX	46
9.4. OUTPUT POWER.....	49
9.4.1. 802.11b MODE 1TX.....	50
9.4.2. 802.11n HT20 MODE	52
9.4.3. 802.11n HT20 CDD MODE 2TX	54
9.4.4. 802.11ax HE20 MODE	55
9.4.5. 802.11ax HE20 OFDMA MODE 2TX	63

9.5. *POWER SPECTRAL DENSITY*67

 9.5.1. 802.11b MODE 1TX.....68

 9.5.2. 802.11n HT20 MODE70

 9.5.3. 802.11n HT20 CDD MODE 2TX72

 9.5.4. 802.11ax HE20 MODE73

 9.5.5. 802.11ax HE20 OFDMA MODE 2TX81

9.6. *CONDUCTED SPURIOUS EMISSIONS*.....85

 9.6.1. 802.11b MODE 1TX.....86

 9.6.2. 802.11n HT20 MODE90

 9.6.3. 802.11n HT20 MODE 2TX.....96

 9.6.4. 802.11ax HE20 MODE104

 9.6.5. 802.11ax HE20 OFDMA MODE 2TX122

10. RADIATED TEST RESULTS.....142

 10.1. *TRANSMITTER ABOVE 1 GHz*.....144

 10.1.1. 802.11b MODE144

 10.1.2. 802.11n HT20 SISO MODE172

 10.1.3. 802.11n 2TX ANT 4 + ANT 3 CDD MODE204

 10.1.4. 802.11ax HE20 SISO MODE230

 10.1.5. 802.11ax HE20 2TX OFDMA MODE294

 10.2. *WORST CASE BELOW 1 GHz*338

 10.3. *WORST CASE 18-26 GHz*.....340

11. AC POWER LINE CONDUCTED EMISSIONS.....342

 11.1. *AC POWER LINE WITH AC/DC ADAPTER*343

 11.2. *AC POWER LINE WITH LAPTOP*.....345

12. SETUP PHOTOS.....347

1. ATTESTATION OF TEST RESULTS

COMPANY NAME: APPLE INC.
1 APPLE PARK WAY
CUPERTINO, CA 95014, U.S.A.

EUT DESCRIPTION: SMARTPHONE

MODEL: A2484 (PARENT MODEL)
A2641, A2643, A2644, A2645 (VARIANT MODELS)

BRAND: APPLE

FCC IC: BCG-E4003A (PARENT MODEL)
BCG-E4005A, BCG-E4035A, BCG-E4036A (VARIANT MODELS)

IC: 579C-E4003A (PARENT MODEL)
579C-E4005A, 579C-E4035A, 579C-E4036A (VARIANT MODELS)

SERIAL NUMBER: C0740600960G3C1, Q7X92R9C06

RECEIPT DATE: 11/05/2020, 6/28/2021

DATE TESTED: NOVEMBER 18, 2020 – JULY 10, 2021

APPLICABLE STANDARDS	
STANDARD	TEST RESULTS
CFR 47 Part 15 Subpart C	Complies
ISED RSS-247 Issue 2	Complies
ISED RSS-GEN Issue 5 + A1 + A2	Complies

UL Verification Services Inc. tested the above equipment in accordance with the requirements set forth in the above standards. The test results show that the equipment tested is capable of demonstrating compliance with the requirements as documented in this report.

The results documented in this report apply only to the tested sample, under the conditions and modes of operation as described herein. It is the manufacturer's responsibility to assure that additional production units of this model are manufactured with identical electrical and mechanical components. All samples tested were in good operating condition throughout the entire test program. Measurement Uncertainties are published for informational purposes only and were not taken into account unless noted otherwise.

This document may not be altered or revised in any way unless done so by UL Verification Services Inc. and all revisions are duly noted in the revisions section. Any alteration of this document not carried out by UL Verification Services Inc. will constitute fraud and shall nullify the document. This report must not be used by the client to claim product certification, approval, or endorsement by A2LA, NIST, any agency of the Federal Government, or any agency of the U.S. government.

Approved & Released For
UL Verification Services Inc. By:



Chin Pang
Senior Engineer
Consumer Technology Division
UL Verification Services Inc.

Prepared By:



Tony Li
Test Engineer
Consumer Technology Division
UL Verification Services Inc.

2. TEST RESULTS SUMMARY

This report contains data provided by the customer which can impact the validity of results. UL Verification Services Inc. is only responsible for the validity of results after the integration of the data provided by the customer.

FCC Clause	ISED Clause	Requirement	Result	Comment
See Comment		Duty Cycle	Reporting purposes only	ANSI C63.10 Section 11.6.
-	RSS-GEN 6.7	99% OBW	Reporting purposes only	ANSI C63.10 Section 6.9.3.
15.247 (a) (2)	RSS-247 5.2 (a)	6dB BW	Complies	None.
15.247 (b) (3)	RSS-247 5.4 (d)	Output Power	Complies	None.
15.247 (e)	RSS-247 5.2 (b)	PSD	Complies	None.
15.247 (d)	RSS-247 5.5	Conducted Spurious Emissions	Complies	None.
15.209, 15.205	RSS-GEN 8.9, 8.10	Radiated Emissions	Complies	None.
15.207	RSS-Gen 8.8	AC Mains Conducted Emissions	Complies	None.

3. TEST METHODOLOGY

The tests documented in this report were performed in accordance with:

- FCC CFR 47 Part 2
- FCC CFR 47 Part 15
- ANSI C63.10-2013
- KDB 558074 D01 15.247 Meas Guidance v05r02
- KDB 414788 D01 Radiated Test Site v01r01
- RSS-GEN Issue 5 + A1 + A2
- RSS-247 Issue 2

4. FACILITIES AND ACCREDITATION

UL Verification Services Inc. is accredited by A2LA, certification #0751.05, for all testing performed within the scope of this report. Testing was performed at the locations noted below.

	Address	ISED CABID	ISED Company Number	FCC Registration
<input type="checkbox"/>	Building 1: 47173 Benicia Street, Fremont, CA 94538, USA	US0104	2324A	208313
<input checked="" type="checkbox"/>	Building 2: 47266 Benicia Street, Fremont, CA 94538, USA	US0104	22541	208313
<input checked="" type="checkbox"/>	Building 4: 47658 Kato Rd, Fremont, CA 94538, USA	US0104	2324B	208313

5. DECISION RULES AND MEASUREMENT UNCERTAINTY

5.1. METROLOGICAL TRACEABILITY

All test and measuring equipment utilized to perform the tests documented in this report are calibrated on a regular basis, with a maximum time between calibrations of one year or the manufacturers' recommendation, whichever is less, and where applicable is traceable to recognized national standards.

5.2. DECISION RULES

The Decision Rule is based on Simple Acceptance in accordance with ISO Guide 98-4:2012 Clause 8.2. (Measurement uncertainty is not taken into account when stating conformity with a specified requirement.)

5.3. MEASUREMENT UNCERTAINTY

Where relevant, the following measurement uncertainty levels have been estimated for tests performed on the apparatus:

PARAMETER	U_{Lab}
Worst Case Conducted Disturbance, 9KHz to 0.15 MHz	3.78 dB
Worst Case Conducted Disturbance, 0.15 to 30 MHz	3.40 dB
Worst Case Radiated Disturbance, 9KHz to 30 MHz	2.87 dB
Worst Case Radiated Disturbance, 30 to 1000 MHz	6.01 dB
Worst Case Radiated Disturbance, 1000 to 18000 MHz	4.73 dB
Worst Case Radiated Disturbance, 18000 to 26000 MHz	4.51 dB
Worst Case Radiated Disturbance, 26000 to 40000 MHz	5.29 dB

Uncertainty figures are valid to a confidence level of 95%.

6. EQUIPMENT UNDER TEST

6.1. EUT DESCRIPTION

The Apple iPhone is a smartphone with multimedia functions (music, application support, and video), cellular GSM, GPRS, EGPRS, UMTS, LTE, 5G, CDMA, IEEE 802.11a/b/g/n/ac/ax, Bluetooth, Ultra-Wideband, GPS, NFC and WPT. All models support at least one UICC based SIM. The second SIM is either an UICC based p-SIM (physical SIM) or e-SIM (electronic SIM). The device supports a built-in inductive charging transmitter and receiver. The rechargeable battery is not user accessible.

Testing was performed on the parent model and is used to support the application for the parent and variants identified in this report based on the test plan submitted and approved via KDB inquiry by the FCC and by ISED-Canada.

The Model and FCC/IC ID covered by this report includes:

Parent Model: A2484; FCC ID: BCG-E4003A, IC ID: 579C-E4003A

Variant Models: A2641; FCC ID: BCG-E4005A, IC ID: 579C-E4005A
 A2643; FCC ID: BCG-E4035A, IC ID: 579C-E4035A
 A2644; FCC ID: BCG-E4036A, IC ID: 579C-E4036A
 A2645; FCC ID: BCG-E4036A, IC ID: 579C-E4036A

6.2. MAXIMUM OUTPUT POWER

The transmitter has a maximum conducted output power as follows:

Frequency Range (MHz)	Mode	Output Power (dBm)	Output Power (mW)
1Tx			
2412 - 2472	802.11b	21.49	140.93
	802.11g	Covered by 802.11n HT20 1TX	
	802.11n HT20	21.48	140.60
	802.11ax HE20	21.46	139.96

2Tx			
2412 - 2472	802.11n HT20 CDD	24.37	273.53
	802.11g SDM/STBC	Covered by 802.11n HT20 2TX CDD	
	802.11ax HE20	24.40	275.42

6.3. DESCRIPTION OF AVAILABLE ANTENNAS

The antennas gain and IFA type, as provided by the manufacturer' are as follows:

Frequency Range (GHz)	ANT 4 (dBi)	ANT 3 (dBi)
2.4	0.1	-0.6

6.4. SOFTWARE AND FIRMWARE

The EUT firmware installed during testing was WiFi FW Version: WiFi: 20_10_745_15

6.5. WORST-CASE CONFIGURATION AND MODE

EUT was investigated in three orthogonal orientations X, Y and Z on ANT4 (Core 0), ANT3 (Core 1) and 2TX. It was determined that X (Flatbed) orientation was worst-case orientation for both ANT4 and 2TX and Y (Landscape) orientation for ANT 3.

Radiated band edge, harmonic, and spurious emissions from 1GHz to 18GHz were performed with the EUT set to transmit at highest power on Low/Middle/High channels.

Radiated emissions below 1GHz, 18-26GHz and power line conducted emissions were performed with the EUT transmits at the channel with the highest output power as worst-case scenario. There were no emissions found below 30MHz within 20dB of the limit.

For radiated harmonics spurious below 1GHz, 1-18GHz L/M/H channels, 18-26GHz, and power line conducted emissions were performed with the EUT set at the 2TX CDD mode among the CDD/SDM modes and 2TX HE mode with power setting equal or higher than SISO modes as worst-case scenario. G mode covered by HT20 mode since it has the same power as HT20.

Below 1GHz tests were performed with EUT connected to AC power adapter as the worst case; and for above 1GHz tests, the worst-case configuration reported was with EUT only. For AC line conducted emission, test was investigated with AC power adapter and with laptop.

The output power and psd for the 802.11 ax mode were investigated between all different tones, and we found that SU mode had the highest output power and the lowest tone had the highest PSD readings. And after investigation, antenna port conducted tests were performed on both SU and lowest tones; radiated spurious emission and radiated band edge tests were performed on full RU and lowest tones.

Low data rate was used to test on antenna port conducted tests and radiated spurious emissions since it has the highest maximum power. For radiated bandedge, following are the worst-case data rates set for test:

802.11b mode: 1 Mbps
802.11n HT20mode: MCS7
802.11ax HE20mode: MCS9
802.11ax HE20 FULL RU & RU26: MCS09

There are two vendors of the WiFi/Bluetooth radio modules: variant 1 and variant 2. The Wi-Fi/Bluetooth radio modules have the same mechanical outline (e.g., the same package dimension and pin-out layout), use the same on-board antenna matching circuit, have an identical antenna structure, and are built and tested to conform to the same specifications and to operate within the same tolerances.

Baseline testing was performed on the two variants to determine the worst case on all conducted power and radiated emissions.

6.6. DESCRIPTION OF TEST SETUP

SUPPORT TEST EQUIPMENT						
Description	Manufacturer	Model	Serial Number	FCC ID/ DoC		
Laptop	Apple	Macbook Pro	C02VD7SAHV22	BCGA1708		
Laptop AC/DC adapter	Liteon Technology	A1424	NSW25679	DoC		
EUT AC/DC adapter	Apple	A1720	C3D8417A7R93KVPA8	DoC		
I/O CABLES (RF CONDUCTED TEST)						
Cable No.	Port	# of Identical Ports	Connector Type	Cable Type	Cable Length (m)	Remarks
1	Antenna	1	SMA	Un-shielded	0.2	To spectrum Analyzer
2	USB	1	USB	Shielded	1.0	N/A
3	AC	1	AC	Un-shielded	2	N/A
I/O CABLES (RF RADIATED TEST)						
Cable No.	Port	# of Identical Ports	Connector Type	Cable Type	Cable Length (m)	Remarks
1	AC	1	AC	Un-shielded	2	N/A
2	USB	1	USB	Un-shielded	1	N/A

TEST SETUP

The EUT setup is shown as below. Test software exercised the radio card.

SETUP DIAGRAM FOR CONDUCTED TESTS

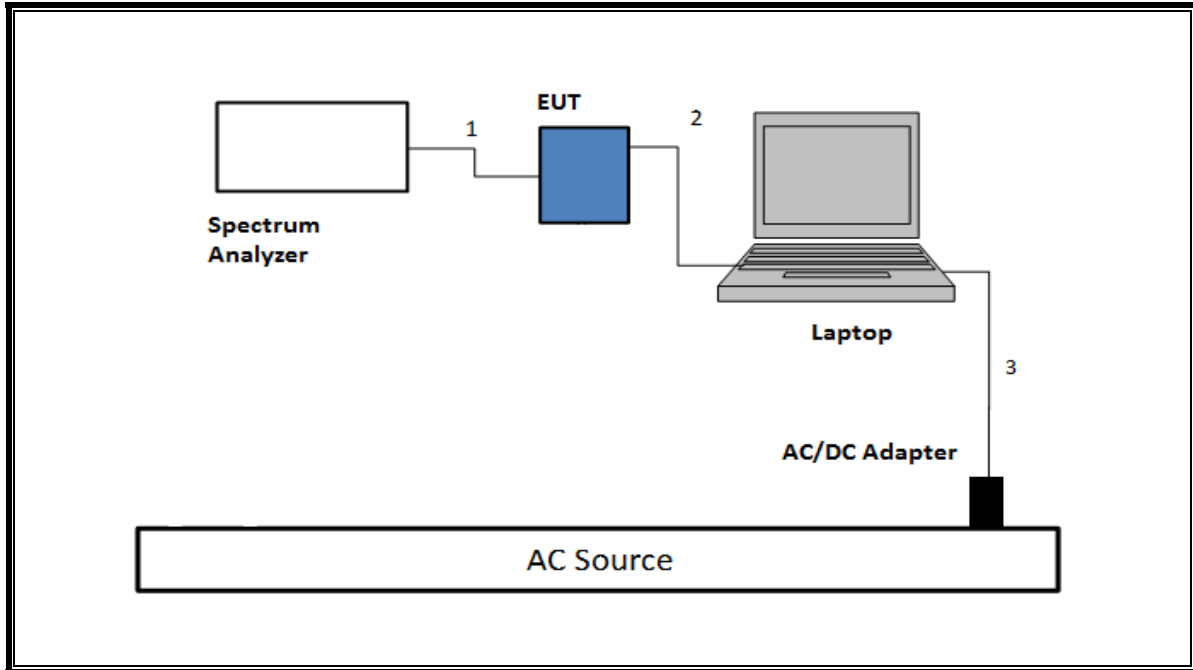

SETUP DIAGRAM FOR RADIATED TESTS Above 1 GHz

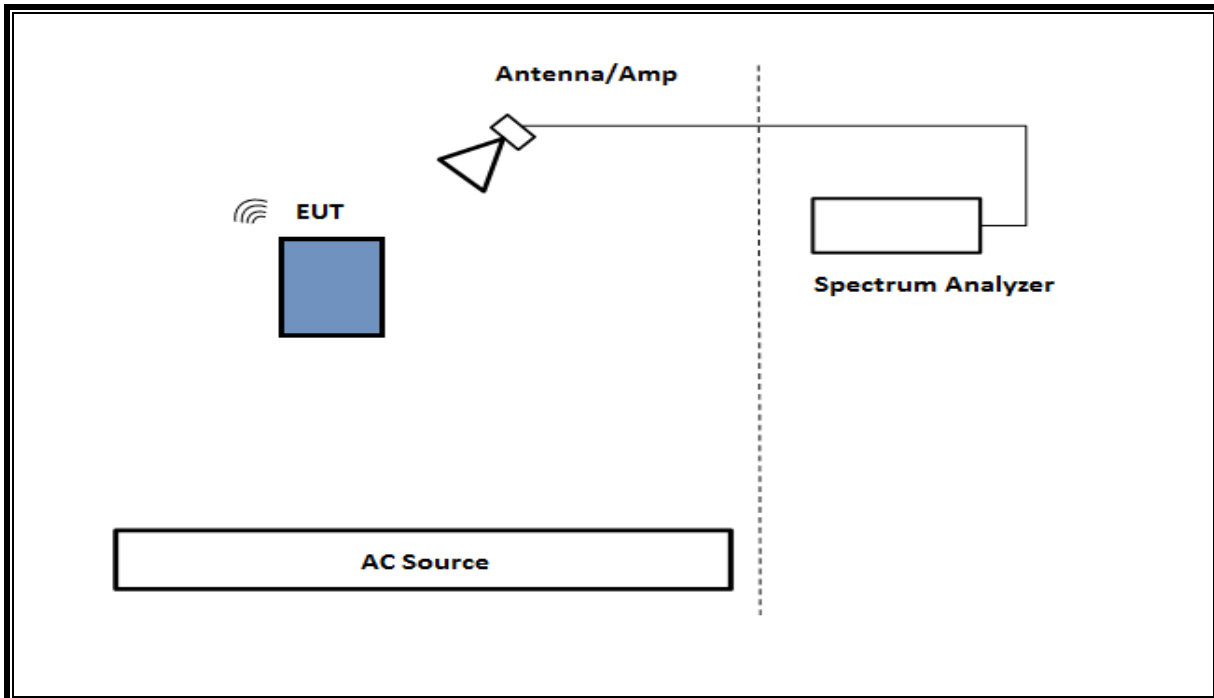

SETUP DIAGRAM FOR Below 1GHz and AC LINE TEST

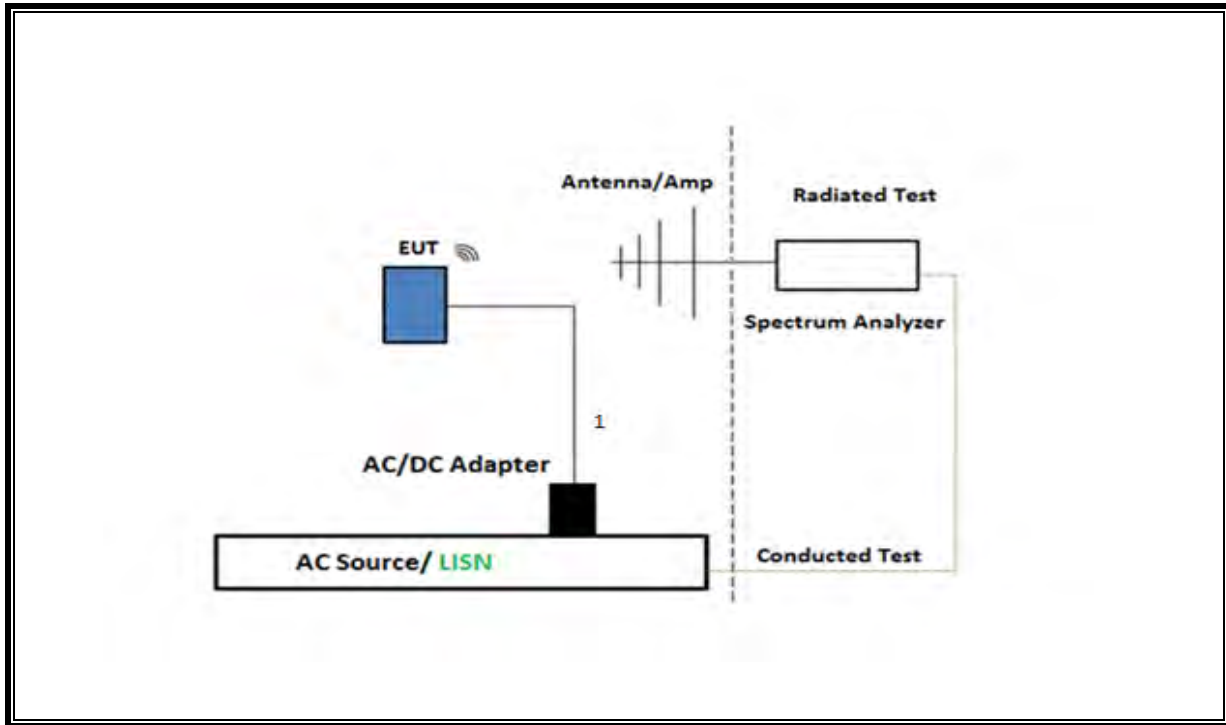

TEST SETUP- AC LINE WITH: LAPTOP CONFIGURATION

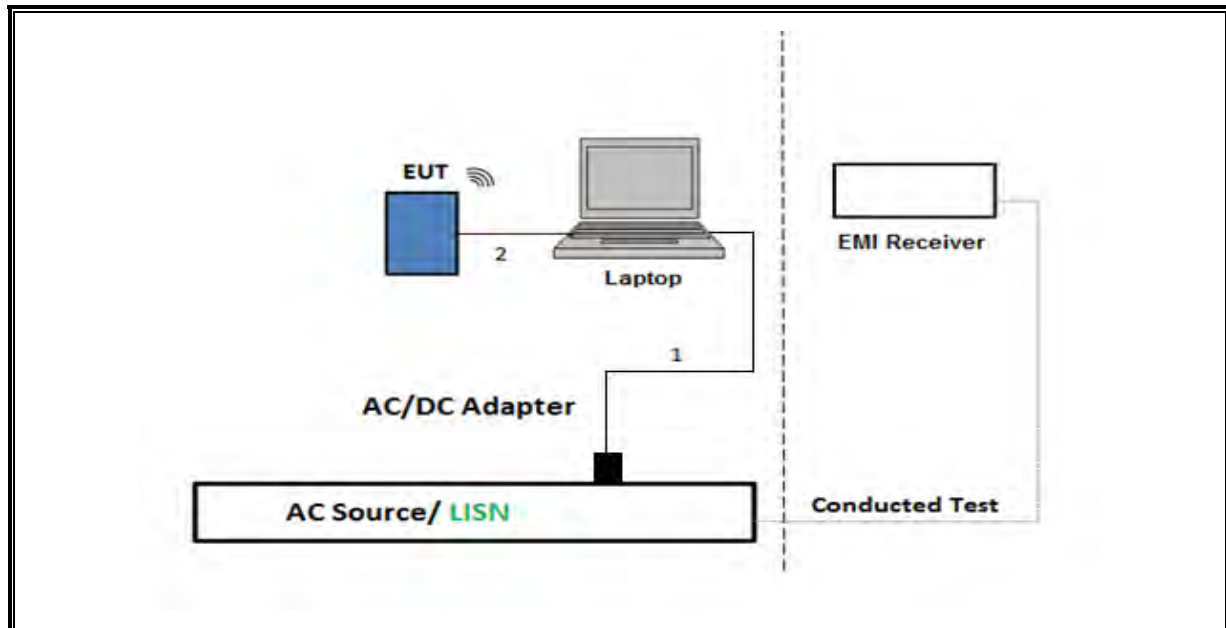

7. MEASUREMENT METHOD

Test Item	Test Method
6 dB BW	ANSI C63.10 Subclause -11.8.1 RBW \geq DTS BW
99% BW	ANSI C63.10-2013, Subclause 6.9.3.
Output Power	ANSI C63.10 Subclause -11.9.2.3.1 Method AVGPM (Measurement using an RF average-reading power meter)
PSD	ANSI C63.10 Subclause -11.10.3 Method AVGPSD-1
Radiated emissions non-restricted frequency bands	ANSI C63.10 Subclause -11.11 & Clause 13
Radiated emissions restricted frequency bands	ANSI C63.10 Subclause -11.12.1 & Clause 13
Conducted emissions in restricted frequency bands	ANSI C63.10 Subclause -11.12.2
Band-edge	ANSI C63.10 Subclause -11.13.3.2 & Clause 13: Integration method -Peak detection
Band-edge	ANSI C63.10 Subclause -11.13.3.3 & Clause 13: Integration method -Trace averaging with continuous transmission at full power
Radiated Spurious Emissions Below 30MHz	ANSI C63.10-2013 Subclause 6.4 & Clause 13
AC Power Line Conducted Emissions	ANSI C63.10-2013, Subclause 6.2

8. TEST AND MEASUREMENT EQUIPMENT

The following test and measurement equipment was utilized for the tests documented in this report:

TEST EQUIPMENT LIST					
Description	Manufacturer	Model	ID Num	Cal Due	Last Cal
Antenna, Horn 1-18GHz	ETS Lindgren	3117	PRE0078107	03/01/2022	03/01/2021
Amplifier, 1 to 18GHz	Amplical	AMP1G18-35	138301	03/30/2022	03/30/2021
EMI Receiver	Rohde & Schwarz	ESW44	201500	02/26/2022	02/26/2021
RF Amplifier, 1-18GHz	AMPLICAL	AMP0.1G18-47-20	206055	05/13/2022	05/13/2021
Antenna, Horn 1-18GHz	ETS-Lindgren	3117	PRE0213833	09/25/2021	09/25/2020
RF Amplifier, 1-18GHz	AMPLICAL	AMP0.1G18-47-20	172123	01/23/2022	01/23/2021
Antenna, Horn 1-18GHz	ETS-Lindgren	3117	200896	08/20/2021	08/20/2020
Antenna, BroadBand Hybrid, 30MHz to 3GHz	Sunol Sciences Corp.	JB3	202329	10/27/2021	10/27/2020
Amplifier, 9KHz to 1GHz, 32dB	SONOMA INSTRUMENT	310	202992	11/22/2021	11/22/2020
*Pre-Amp 18-26GHz	Agilent Technology	8449B	T404	04/08/2021	04/08/2020
*Antenna Horn, 18 to 26GHz	ARA	SWH-28	T125	04/17/2021	04/17/2020
Spectrum Analyzer, PXA, 3Hz to 44GHz	Agilent (Keysight) Technologies	N9030A	T1454	01/27/2022	01/27/2021
EMI Receiver	Rohde & Schwarz	ESW44	201497	02/25/2022	02/25/2021
Power Meter, P-series single channel	Keysight	N1912A	T1273	01/21/2022	01/21/2021
Power Sensor	Keysight	N1921A	T1226	02/19/2022	02/19/2021
Antenna, Active Loop 9KHz to 30MHz	EMCO	6502	T35	11/23/2021	11/23/2020
Spectrum Analyzer, PXA, 3Hz to 44GHz	Agilent (Keysight) Technologies	N9030A	T339	12/17/2021	12/17/2020

AC Line Conducted					
EMI Test Receiver 9kHz-7GHz	Rohde & Schwarz	ESR	T1436	02/19/2022	02/19/2021
Power Cable, Line Conducted Emissions	UL	PR1	T861	10/27/2021	10/27/2020
LISN for Conducted Emissions CISPR-16	FISCHER CUSTOM COMMUNICATIO NS	FCC-LISN-50/250-25-2-01	PRE0186446	01/20/2022	01/20/2021
UL AUTOMATION SOFTWARE					
Radiated Software	UL	UL EMC	Ver 9.5, April 26, 2016		
Conducted Software	UL	UL EMC	Ver 5.4, October 13, 2016		
AC Line Conducted Software	UL	UL EMC	Ver 9.5, May 26, 2015		

Note: *Testing is completed before equipment expiration date.

9. ANTENNA PORT TEST RESULTS

9.1. ON TIME AND DUTY CYCLE

LIMITS

None; for reporting purposes only.

PROCEDURE

KDB 558074 Zero-Span Spectrum Analyzer Method.

ON TIME AND DUTY CYCLE RESULTS

Mode	ON Time B (msec)	Period (msec)	Duty Cycle x (linear)	Duty Cycle (%)	Duty Cycle Correction Factor (dB)	1/B Minimum VBW (kHz)
2.4GHz Band						
802.11b	1.560	1.560	1.000	100.00%	0.00	0.010
802.11n HT20 1TX MCS0	1.914	1.938	0.988	98.76%	0.00	0.010
802.11n HT20 1TX MCS7	0.228	0.250	0.911	91.13%	0.40	4.386
802.11n HT20 2TX MCS0	1.920	1.941	0.989	98.92%	0.00	0.010
802.11n HT20 2TX MCS7	0.228	0.248	0.918	91.79%	0.37	4.386
802.11ax HE20 1TX MCS0	3.995	4.035	0.990	99.01%	0.00	0.010
802.11ax HE20 1TX MCS9	3.995	4.035	0.990	99.01%	0.00	0.010
802.11ax HE20 2TX MCS0	3.995	4.040	0.989	98.89%	0.00	0.010
802.11ax HE20 2TX MCS9	3.995	4.035	0.990	99.01%	0.00	0.010

DUTY CYCLE PLOTS

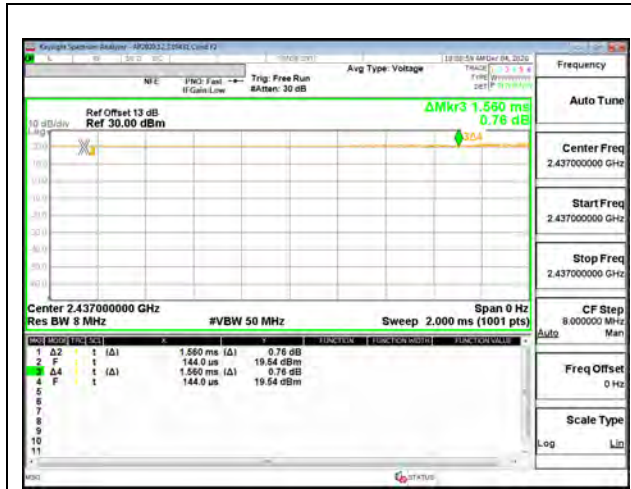

DUTY CYCLE 802.11b MODE



DUTY CYCLE 802.11n HT20 1TX MCS0



DUTY CYCLE 802.11n HT20 1TX MCS7



DUTY CYCLE 802.11n HT20 2TX MCS0



DUTY CYCLE 802.11n HT20 2TX MCS7



DUTY CYCLE 802.11ax HE20 1TX MCS0

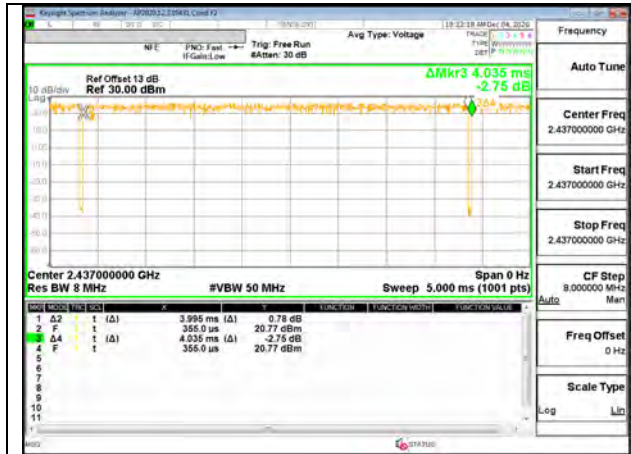

DUTY CYCLE 802.11ax HE20 1TX MCS9



DUTY CYCLE 802.11ax HE20 2TX MCS0



DUTY CYCLE 802.11ax HE20 2TX MCS9

9.2. 99% BANDWIDTH

LIMITS

None; for reporting purposes only.

RESULTS

Only Mid channel plot is reported to show setting parameter complies with testing method/procedure.

9.2.1. 802.11b MODE 1TX

1TX ANT 4 MODE

Channel	Frequency (MHz)	99% Bandwidth (MHz)
Low 1	2412	12.925
Low 2	2417	12.714
Mid 6	2437	13.046
High 9	2452	13.064
High 10	2457	12.759
High 11	2462	13.062
High 12	2467	12.973
High 13	2472	13.038

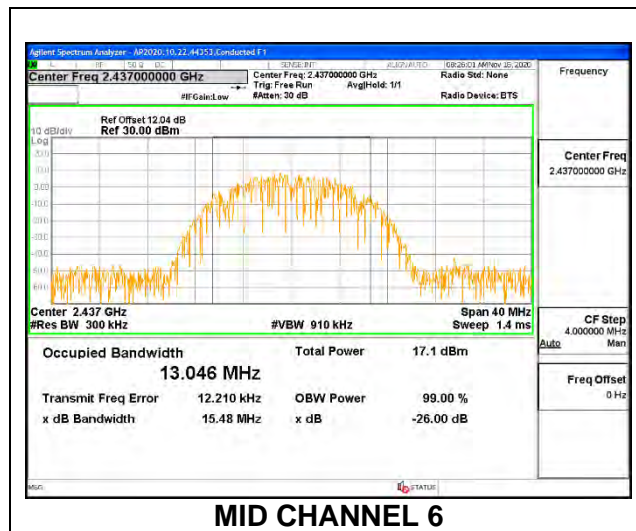

1TX ANT 3 MODE

Channel	Frequency (MHz)	99% Bandwidth (MHz)
Low 1	2412	12.812
Low 2	2417	12.945
Mid 6	2437	12.936
High 9	2452	12.960
High 10	2457	13.037
High 11	2462	13.026
High 12	2467	12.876
High 13	2472	12.767

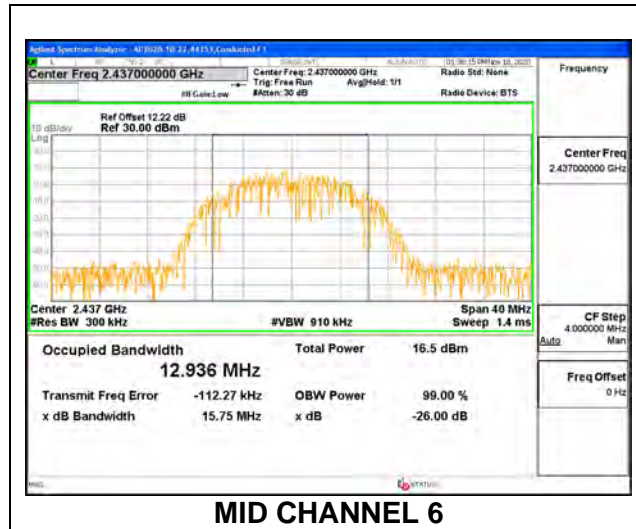

9.2.2. 802.11n HT20 MODE

1TX ANT 4 MODE

Channel	Frequency (MHz)	99% Bandwidth (MHz)
Low 1	2412	17.762
Low 2	2417	17.612
Low 3	2422	17.668
Mid 6	2437	17.623
High 9	2452	17.625
High 10	2457	17.642
High 11	2462	17.717
High 12	2467	17.672
High 13	2472	17.656

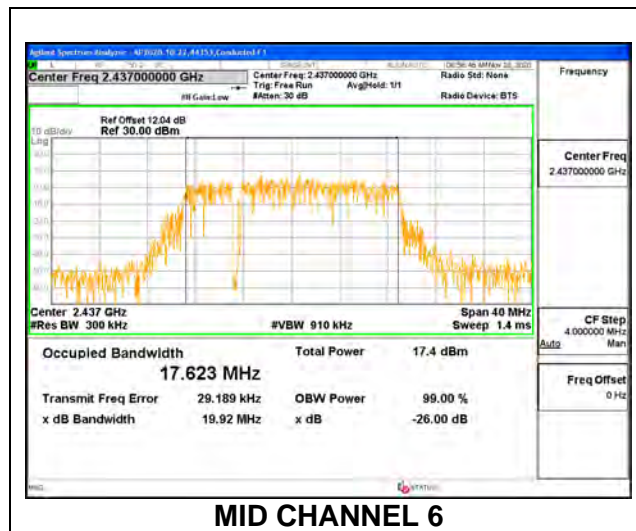

1TX ANT 3 MODE

Channel	Frequency (MHz)	99% Bandwidth (MHz)
Low 1	2412	17.631
Low 2	2417	17.674
Low 3	2422	17.706
Mid 6	2437	17.651
High 9	2452	17.739
High 10	2457	17.668
High 11	2462	17.700
High 12	2467	17.626
High 13	2472	17.731

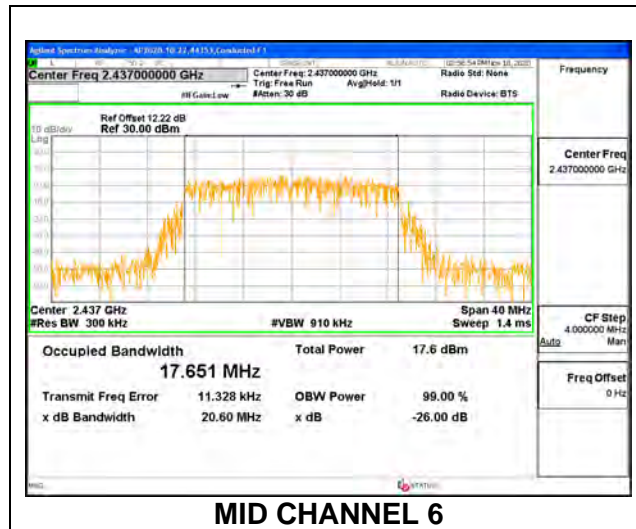

9.2.3. 802.11n HT20 CDD MODE

ANT 4 + ANT 3 2TX MODE

Channel	Frequency (MHz)	99% Bandwidth (MHz) ANT 4	99% Bandwidth (MHz) ANT 3
Low 1	2412	17.591	17.788
Low 2	2417	17.601	17.778
Low 3	2422	17.735	17.730
Low 4	2427	17.721	17.630
Mid 6	2437	17.746	17.774
High 8	2447	17.630	17.670
High 9	2452	17.655	17.728
High 10	2457	17.581	17.657
High 11	2462	17.615	17.697
High 12	2467	17.735	17.654
High 13	2472	17.650	17.625

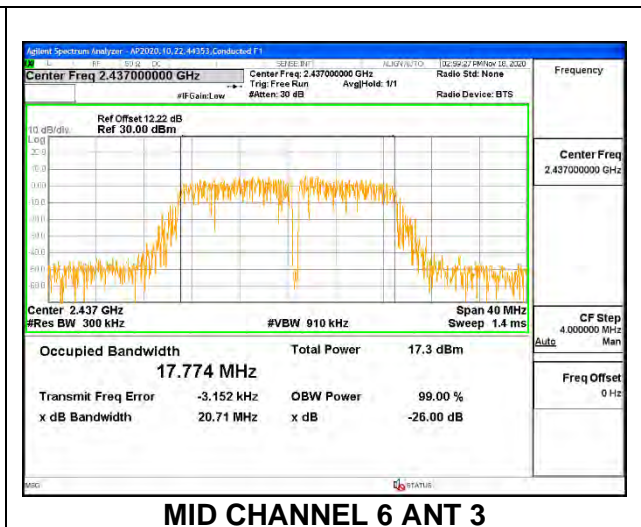
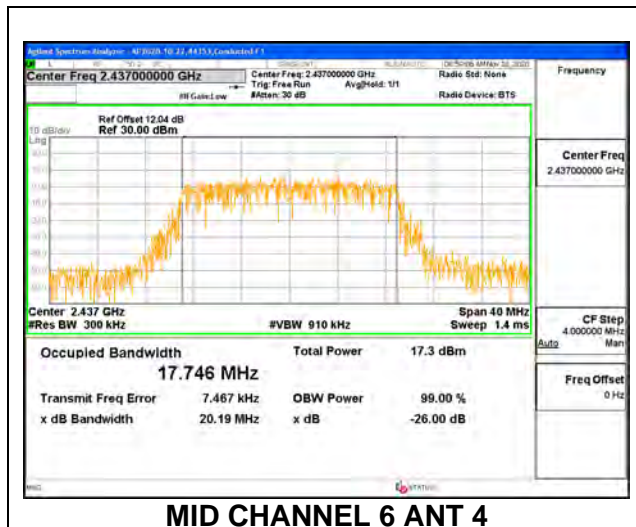

9.2.4. 802.11ax HE20 MODE

ANT 4 LEGACY SISO MODE: 26-Tones, RU index 0

Channel	Frequency (MHz)	99% Bandwidth (MHz)
Low 1	2412	18.559
Low 2	2417	18.425
Low 3	2422	18.563
Low 4	2427	18.479
Mid 6	2437	18.425
High 8	2447	18.386
High 9	2452	18.405
High 10	2457	18.127
High 11	2462	18.419
High 12	2467	18.398
High 13	2472	18.358

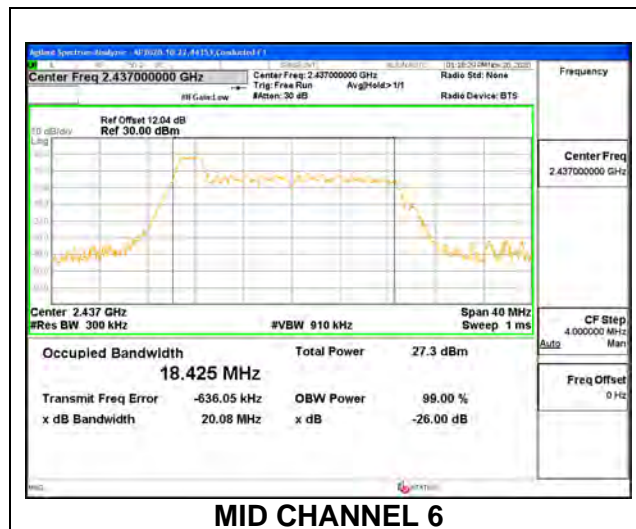

ANT 4 LEGACY SISO MODE: 26-Tones, RU Index 4

Channel	Frequency (MHz)	99% Bandwidth (MHz)
Low 1	2412	17.170
Low 2	2417	17.099
Low 3	2422	17.122
Low 4	2427	17.125
Mid 6	2437	17.046
High 8	2447	17.091
High 9	2452	17.056
High 10	2457	17.195
High 11	2462	16.894
High 12	2467	17.035
High 13	2472	17.224

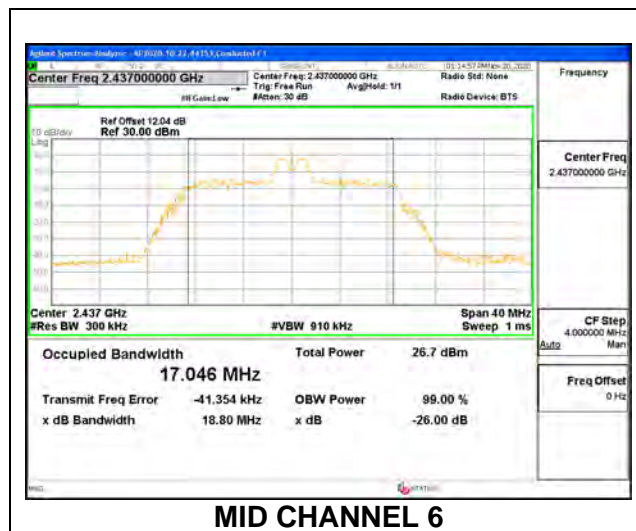

ANT 4 LEGACY SISO MODE: 26-Tones, RU Index 8

Channel	Frequency (MHz)	99% Bandwidth (MHz)
Low 1	2412	18.545
Low 2	2417	18.665
Low 3	2422	18.687
Low 4	2427	18.699
Mid 6	2437	18.735
High 8	2447	18.871
High 9	2452	18.807
High 10	2457	18.737
High 11	2462	18.759
High 12	2467	18.626
High 13	2472	18.669

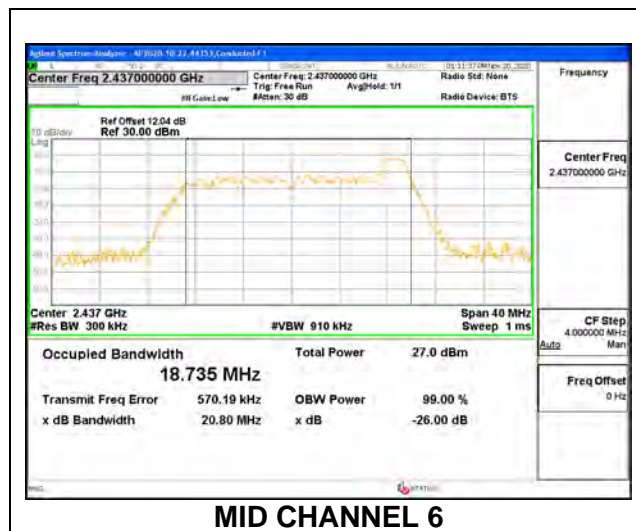

ANT 4 LEGACY SISO MODE: SU Tones

Channel	Frequency (MHz)	99% Bandwidth (MHz)
Low 1	2412	18.987
Low 2	2417	18.760
Low 3	2422	18.782
Low 4	2427	18.908
Mid 6	2437	18.885
High 8	2447	18.779
High 9	2452	18.967
High 10	2457	18.933
High 11	2462	18.890
High 12	2467	19.072
High 13	2472	18.888

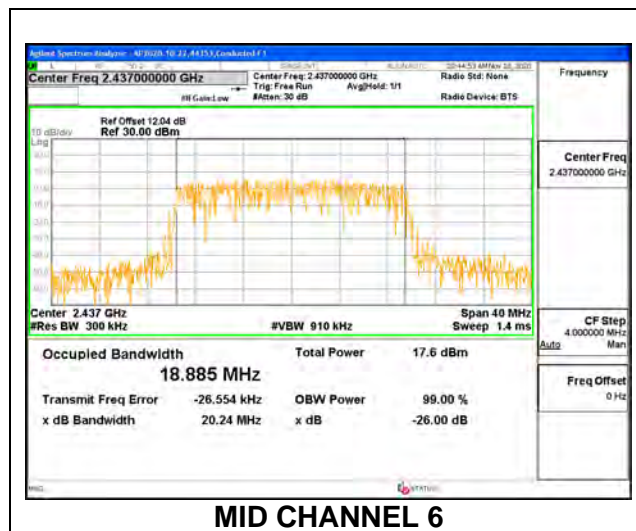

ANT 3 LEGACY SISO MODE: 26-Tones, RU Index 0

Channel	Frequency (MHz)	99% Bandwidth (MHz)
Low 1	2412	18.528
Low 2	2417	18.545
Low 3	2422	18.512
Low 4	2427	18.499
Mid 6	2437	18.432
High 8	2447	18.412
High 9	2452	18.241
High 10	2457	18.362
High 11	2462	18.454
High 12	2467	18.449
High 13	2472	18.305

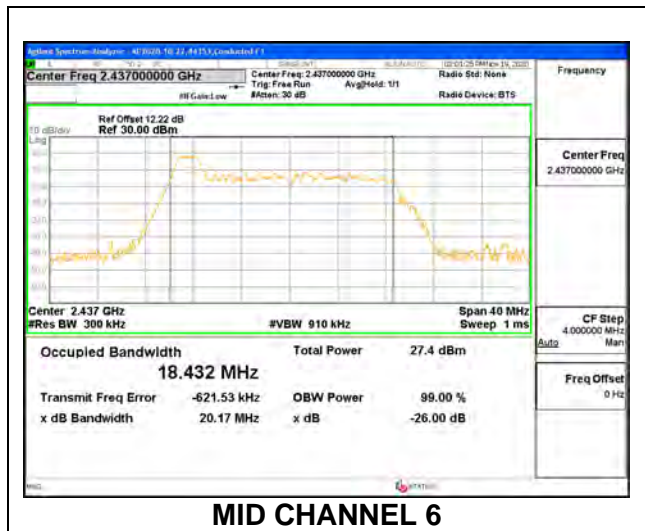

ANT 3 LEGACY SISO MODE: 26-Tones, RU Index 4

Channel	Frequency (MHz)	99% Bandwidth (MHz)
Low 1	2412	17.235
Low 2	2417	17.121
Low 3	2422	17.075
Low 4	2427	17.090
Mid 6	2437	17.077
High 8	2447	17.107
High 9	2452	17.070
High 10	2457	16.985
High 11	2462	17.196
High 12	2467	17.307
High 13	2472	17.069

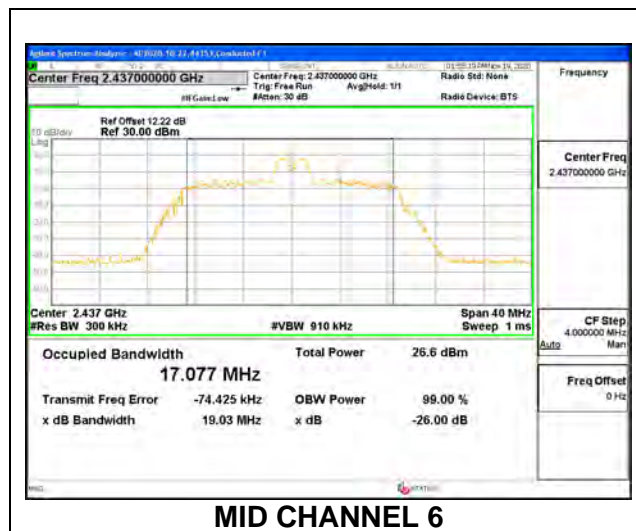

ANT 3 LEGACY SISO MODE: 26-Tones, RU Index 8

Channel	Frequency (MHz)	99% Bandwidth (MHz)
Low 1	2412	18.607
Low 2	2417	18.692
Low 3	2422	18.635
Low 4	2427	18.639
Mid 6	2437	18.730
High 8	2447	18.924
High 9	2452	18.819
High 10	2457	18.846
High 11	2462	18.826
High 12	2467	18.735
High 13	2472	18.749

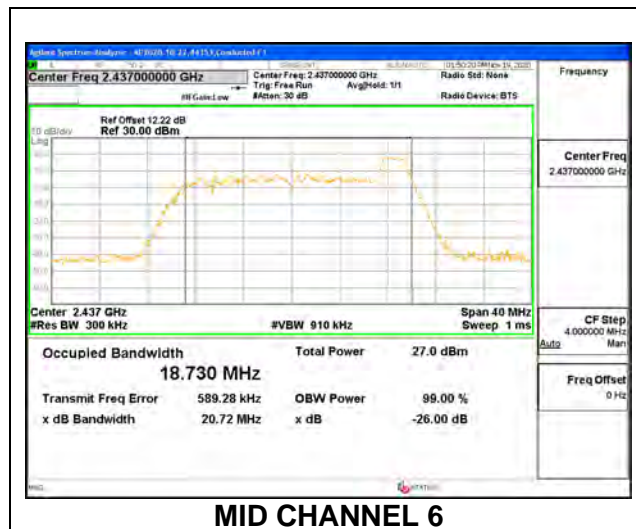

ANT 3 LEGACY SISO MODE: SU Tones

Channel	Frequency (MHz)	99% Bandwidth (MHz)
Low 1	2412	18.953
Low 2	2417	18.945
Low 3	2422	18.876
Low 4	2427	18.999
Mid 6	2437	18.789
High 8	2447	18.942
High 9	2452	18.893
High 10	2457	18.935
High 11	2462	18.931
High 12	2467	18.798
High 13	2472	18.853

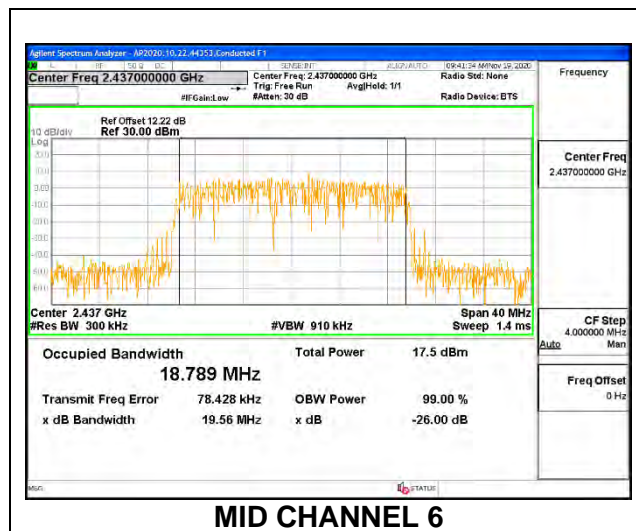

9.2.5. 802.11ax HE20 OFDMA MODE 2TX

ANT 4 + ANT 3 2TX MODE: 26-Tones, RU Index 0

Channel	Frequency (MHz)	99% Bandwidth (MHz) ANT 4	99% Bandwidth (MHz) ANT 3
Low 1	2412	18.520	18.547
Low 2	2417	18.400	18.539
Low 3	2422	18.510	18.490
Low 4	2427	18.533	18.520
Mid 6	2437	18.434	18.434
High 8	2447	18.394	18.404
High 9	2452	18.362	18.375
High 10	2457	18.379	18.455
High 11	2462	18.502	18.384
High 12	2467	18.444	18.385
High 13	2472	18.389	18.307

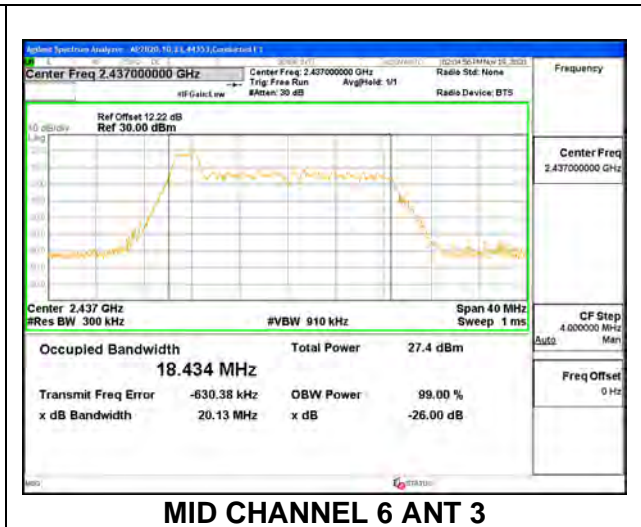
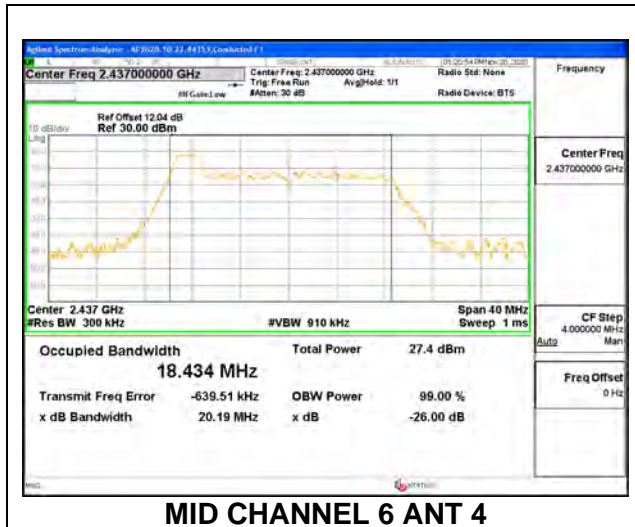

ANT 4 + ANT 3 2TX MODE: 26-Tones, RU Index 4

Channel	Frequency (MHz)	99% Bandwidth (MHz)	99% Bandwidth (MHz)
		ANT 4	ANT 3
Low 1	2412	17.222	17.264
Low 2	2417	16.969	17.123
Low 3	2422	17.075	16.862
Low 4	2427	17.090	17.133
Mid 6	2437	17.092	17.021
High 8	2447	17.196	17.171
High 9	2452	17.208	17.207
High 10	2457	17.161	17.217
High 11	2462	17.073	17.128
High 12	2467	17.199	17.231
High 13	2472	17.172	16.959

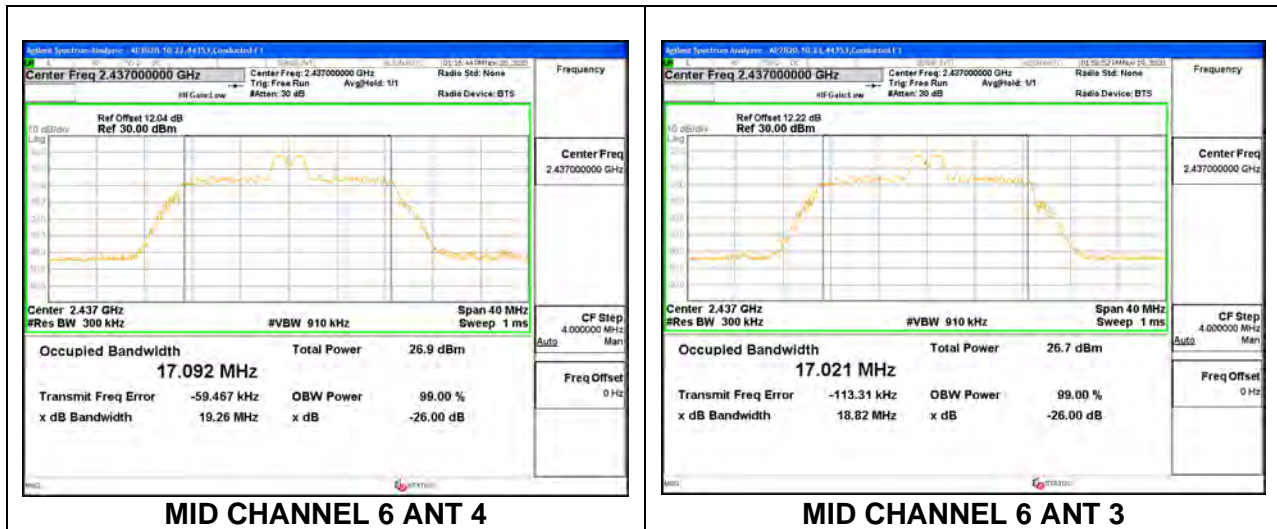

ANT 4 + ANT 3 2TX MODE: 26-Tones, RU Index 8

Channel	Frequency (MHz)	99% Bandwidth (MHz)	99% Bandwidth (MHz)
		ANT 4	ANT 3
Low 1	2412	18.422	18.540
Low 2	2417	18.605	18.548
Low 3	2422	18.646	18.659
Low 4	2427	18.662	18.645
Mid 6	2437	18.736	18.716
High 8	2447	18.749	18.786
High 9	2452	18.831	18.743
High 10	2457	18.837	18.788
High 11	2462	18.784	18.654
High 12	2467	18.784	18.634
High 13	2472	18.780	18.802

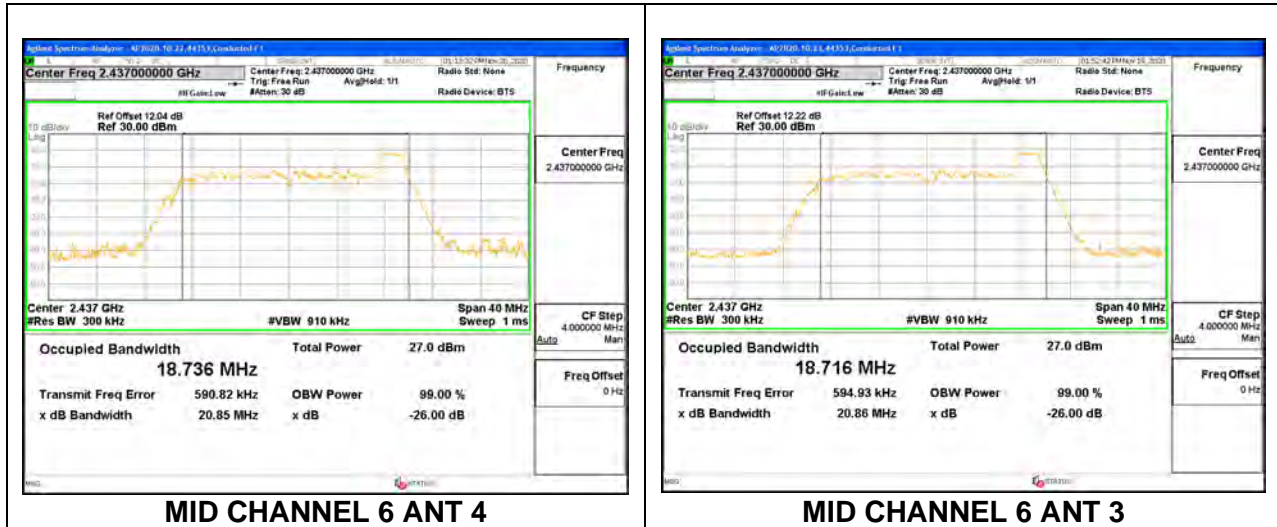

ANT 4 + ANT 3 2TX MODE: SU Tones

Channel	Frequency (MHz)	99% Bandwidth (MHz)	99% Bandwidth (MHz)
		ANT 4	ANT 3
Low 1	2412	18.909	18.902
Low 2	2417	18.821	18.995
Low 3	2422	18.797	18.905
Low 4	2427	18.923	18.868
Mid 6	2437	18.883	18.789
High 8	2447	18.890	18.882
High 9	2452	19.019	18.835
High 10	2457	19.055	18.920
High 11	2462	18.742	18.929
High 12	2467	18.920	18.954
High 13	2472	18.992	18.760

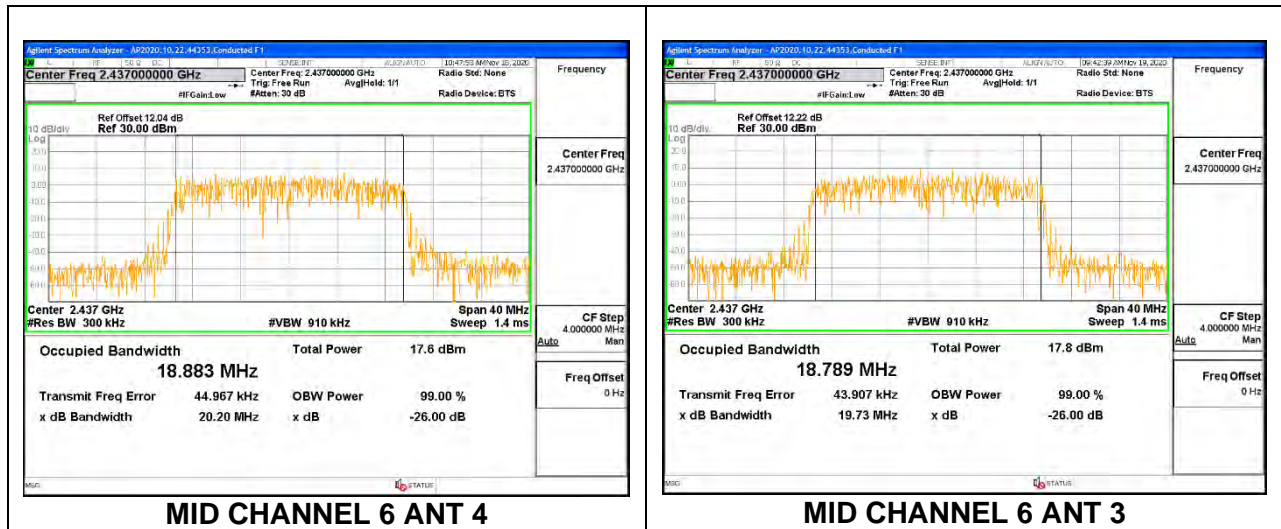

9.3. 6dB BANDWIDTH

LIMITS

FCC §15.247 (a) (2)

RSS-247 5.2 (a)

The minimum 6 dB bandwidth shall be at least 500 kHz.

RESULTS

The 6dB bandwidth was measured for the narrowest bandwidth mode, b Mode and ax HE20 Mode 26-Tones as worst case to demonstrate compliance with the minimum required bandwidth of 500 kHz to cover all OFDMA modes.

Only Mid channel plot is reported to show setting parameter complies with testing method/procedure.

9.3.1. 802.11b MODE 1TX

1TX ANT 4 MODE

Channel	Frequency (MHz)	6dB Bandwidth (MHz)	Minimum Limit (MHz)
Low 1	2412	8.68	0.5
Low 2	2417	8.28	0.5
Mid 6	2437	8.24	0.5
High 9	2452	8.44	0.5
High 10	2457	8.16	0.5
High 11	2462	7.56	0.5
High 12	2467	8.20	0.5
High 13	2472	8.04	0.5

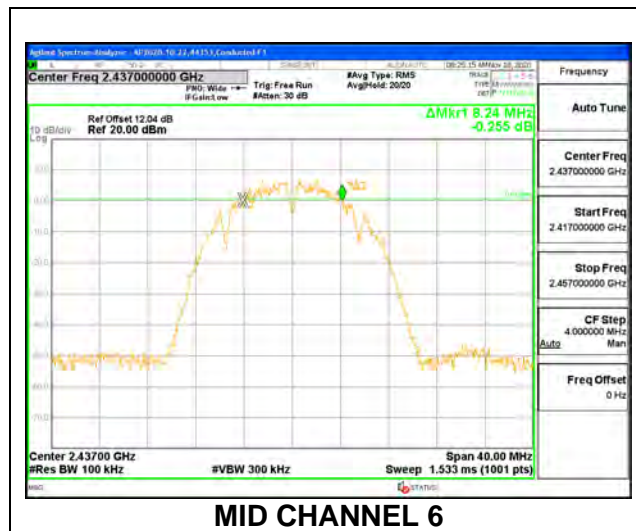

1TX ANT 3 MODE

Channel	Frequency (MHz)	6dB Bandwidth (MHz)	Minimum Limit (MHz)
Low 1	2412	7.40	0.5
Low 2	2417	8.36	0.5
Mid 6	2437	8.16	0.5
High 9	2452	8.24	0.5
High 10	2457	8.36	0.5
High 11	2462	8.16	0.5
High 12	2467	8.28	0.5
High 13	2472	8.72	0.5

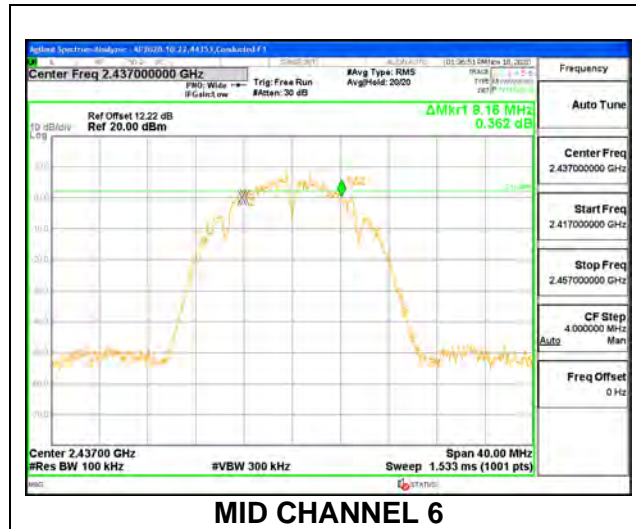

9.3.2. 802.11ax HE20 MODE

ANT 4 LEGACY SISO MODE: 26-Tones, RU index 0

Channel	Frequency (MHz)	6dB Bandwidth (MHz)	Minimum Limit (MHz)
Low 1	2412	2.20	0.5
Low 2	2417	2.08	0.5
Low 3	2422	2.08	0.5
Low 4	2427	2.12	0.5
Mid 6	2437	2.12	0.5
High 8	2447	2.08	0.5
High 9	2452	2.16	0.5
High 10	2457	2.16	0.5
High 11	2462	2.16	0.5
High 12	2467	2.16	0.5
High 13	2472	2.08	0.5

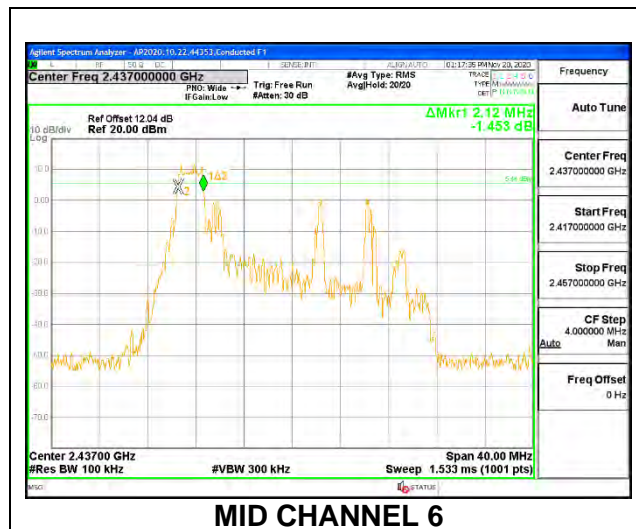

ANT 4 LEGACY SISO MODE: 26-Tones, RU Index 4

Channel	Frequency (MHz)	6dB Bandwidth (MHz)	Minimum Limit (MHz)
Low 1	2412	2.68	0.5
Low 2	2417	2.76	0.5
Low 3	2422	2.60	0.5
Low 4	2427	2.68	0.5
Mid 6	2437	2.68	0.5
High 8	2447	2.68	0.5
High 9	2452	2.68	0.5
High 10	2457	2.76	0.5
High 11	2462	2.68	0.5
High 12	2467	2.76	0.5
High 13	2472	2.68	0.5

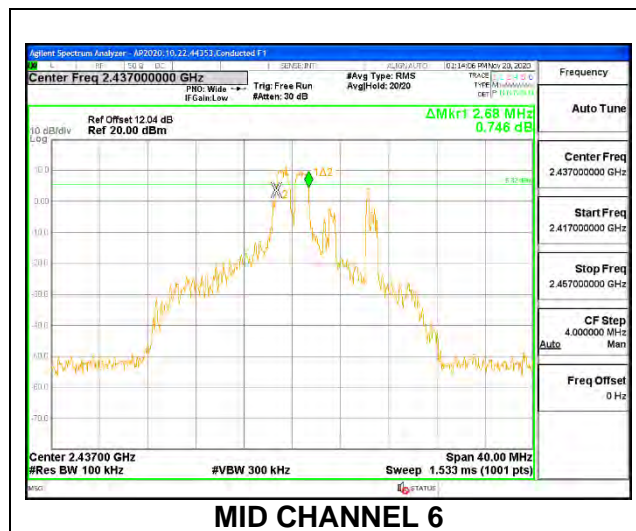

ANT 4 LEGACY SISO MODE: 26-Tones, RU Index 8

Channel	Frequency (MHz)	6dB Bandwidth (MHz)	Minimum Limit (MHz)
Low 1	2412	2.08	0.5
Low 2	2417	2.16	0.5
Low 3	2422	2.16	0.5
Low 4	2427	2.12	0.5
Mid 6	2437	2.12	0.5
High 8	2447	2.12	0.5
High 9	2452	2.12	0.5
High 10	2457	2.04	0.5
High 11	2462	2.12	0.5
High 12	2467	2.12	0.5
High 13	2472	2.12	0.5

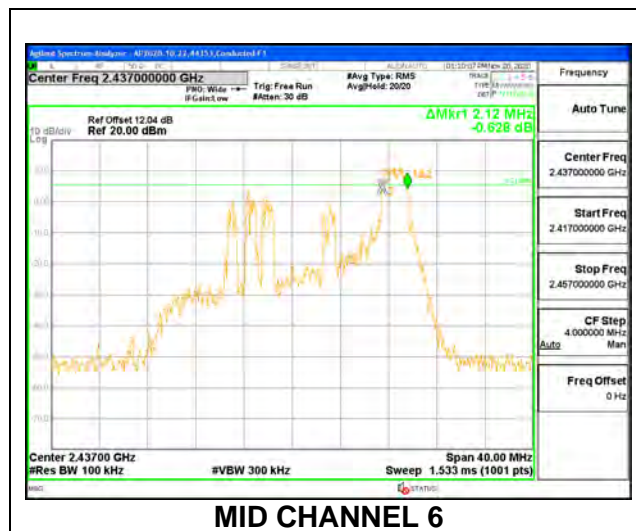

ANT 3 LEGACY SISO MODE: 26-Tones, RU Index 0

Channel	Frequency (MHz)	6dB Bandwidth (MHz)	Minimum Limit (MHz)
Low 1	2412	2.08	0.5
Low 2	2417	2.08	0.5
Low 3	2422	2.12	0.5
Low 4	2427	2.12	0.5
Mid 6	2437	2.20	0.5
High 8	2447	2.16	0.5
High 9	2452	2.08	0.5
High 10	2457	2.08	0.5
High 11	2462	2.20	0.5
High 12	2467	2.16	0.5
High 13	2472	2.16	0.5

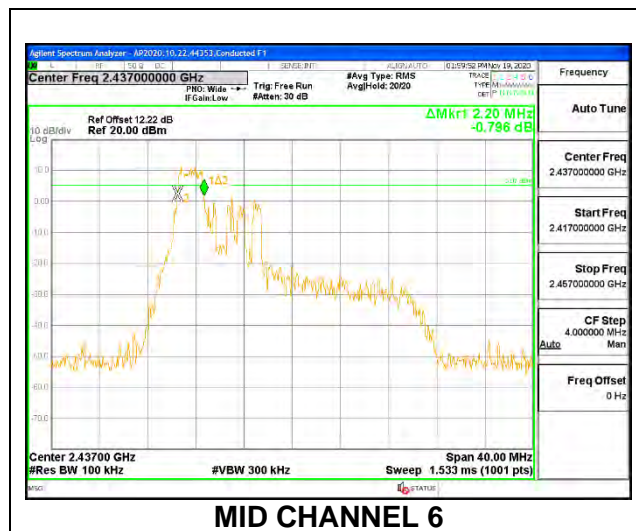

ANT 3 LEGACY SISO MODE: 26-Tones, RU Index 4

Channel	Frequency (MHz)	6dB Bandwidth (MHz)	Minimum Limit (MHz)
Low 1	2412	2.64	0.5
Low 2	2417	2.64	0.5
Low 3	2422	2.68	0.5
Low 4	2427	2.68	0.5
Mid 6	2437	2.68	0.5
High 8	2447	2.72	0.5
High 9	2452	2.76	0.5
High 10	2457	2.76	0.5
High 11	2462	2.68	0.5
High 12	2467	2.64	0.5
High 13	2472	2.64	0.5

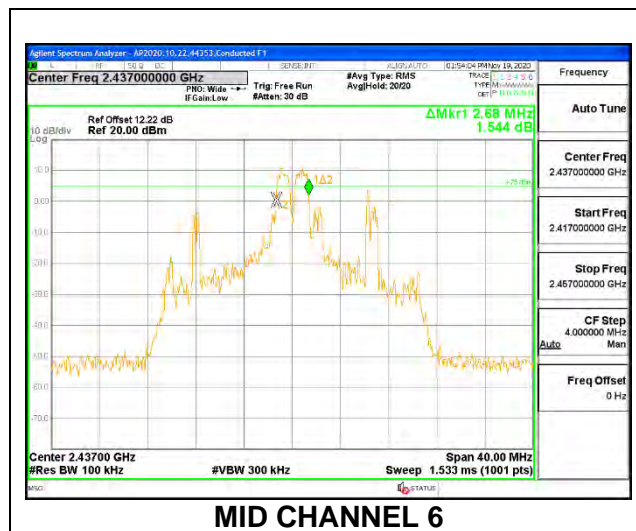

ANT 3 LEGACY SISO MODE: 26-Tones, RU Index 8

Channel	Frequency (MHz)	6dB Bandwidth (MHz)	Minimum Limit (MHz)
Low 1	2412	2.16	0.5
Low 2	2417	2.04	0.5
Low 3	2422	2.12	0.5
Low 4	2427	2.04	0.5
Mid 6	2437	2.08	0.5
High 8	2447	2.16	0.5
High 9	2452	2.08	0.5
High 10	2457	2.12	0.5
High 11	2462	2.16	0.5
High 12	2467	2.12	0.5
High 13	2472	2.12	0.5

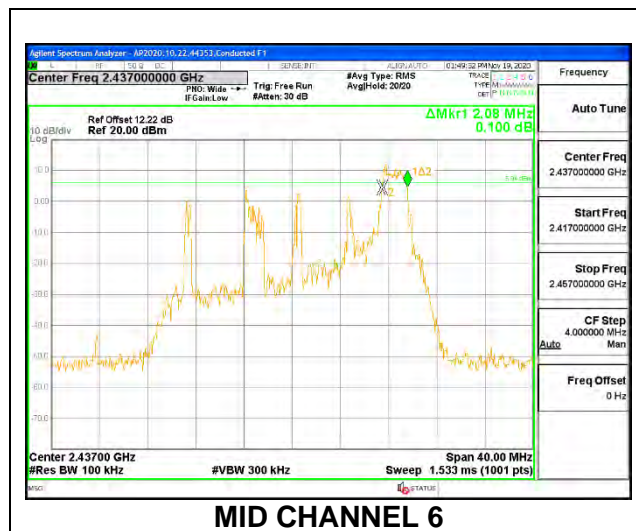

9.3.3. 802.11ax HE20 OFDMA MODE 2TX

ANT 4 + ANT 3 2TX MODE: 26-Tones, RU Index 0

Channel	Frequency (MHz)	6dB BW(MHz) ANT 4	6dB BW (MHz) ANT 3	Minimum Limit (MHz)
Low 1	2412	2.08	2.08	0.5
Low 2	2417	2.12	2.12	0.5
Low 3	2422	2.12	2.08	0.5
Low 4	2427	2.16	2.16	0.5
Mid 6	2437	2.08	2.08	0.5
High 8	2447	2.12	2.12	0.5
High 9	2452	2.12	2.12	0.5
High 10	2457	2.16	2.08	0.5
High 11	2462	2.08	2.12	0.5
High 12	2467	2.16	2.24	0.5
High 13	2472	2.16	2.04	0.5

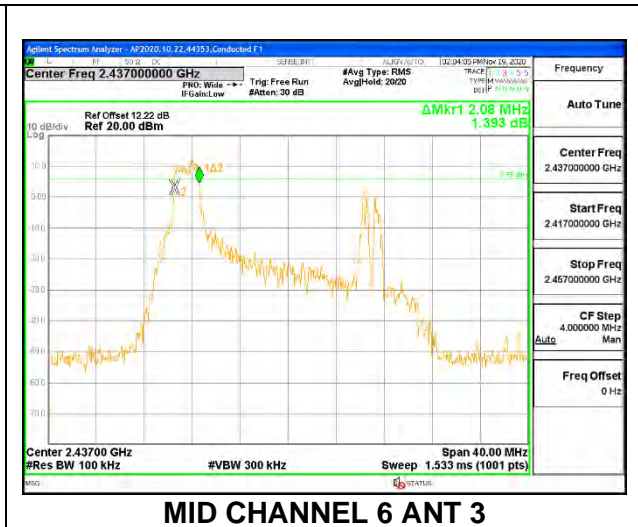
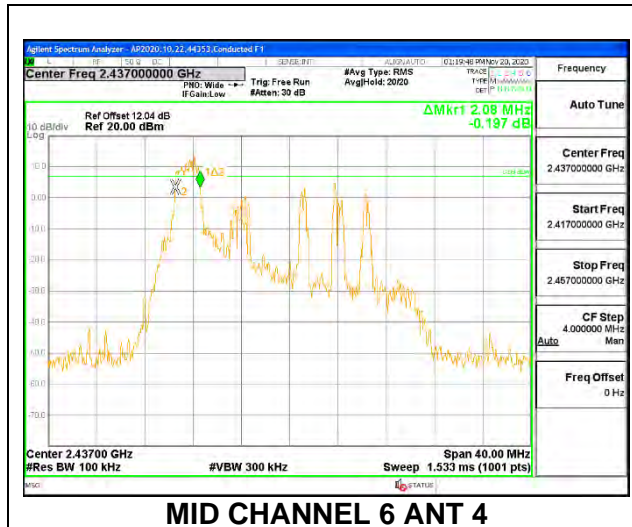

ANT 4 + ANT 3 2TX MODE: 26-Tones, RU Index 4

Channel	Frequency (MHz)	6dB BW(MHz) ANT 4	6dB BW (MHz) ANT 3	Minimum Limit (MHz)
Low 1	2412	2.64	2.72	0.5
Low 2	2417	2.68	2.68	0.5
Low 3	2422	2.72	2.64	0.5
Low 4	2427	2.68	2.68	0.5
Mid 6	2437	2.72	2.72	0.5
High 8	2447	2.68	2.60	0.5
High 9	2452	2.64	2.68	0.5
High 10	2457	2.64	2.68	0.5
High 11	2462	2.68	2.68	0.5
High 12	2467	2.72	2.64	0.5
High 13	2472	2.68	2.68	0.5

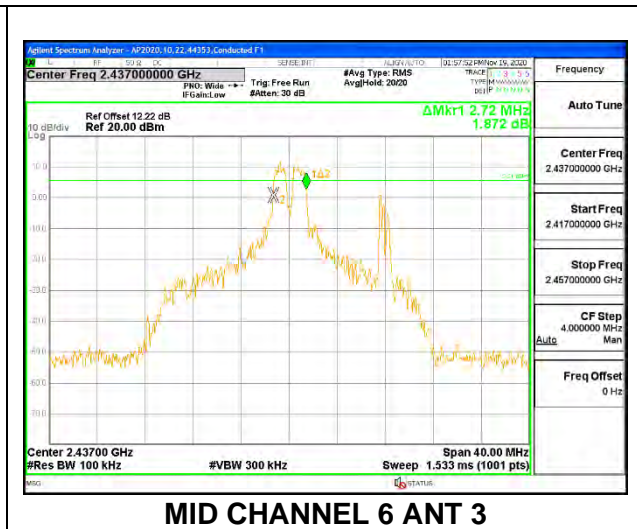
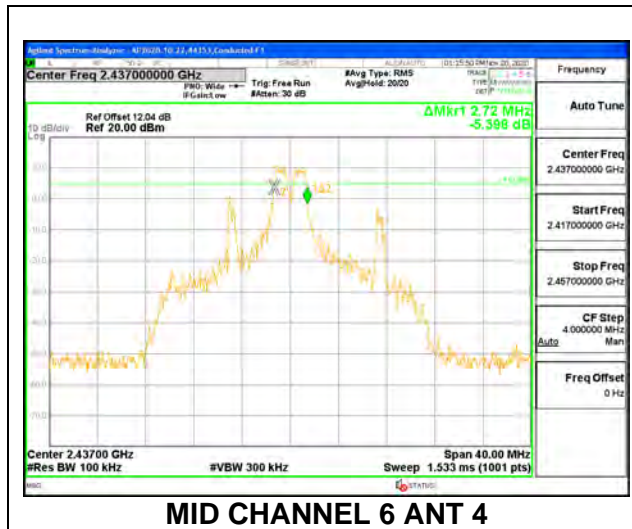

ANT 4 + ANT 3 2TX MODE: 26-Tones, RU Index 8

Channel	Frequency (MHz)	6dB BW(MHz) ANT 4	6dB BW (MHz) ANT 3	Minimum Limit (MHz)
Low 1	2412	2.20	2.12	0.5
Low 2	2417	2.08	2.12	0.5
Low 3	2422	2.12	2.12	0.5
Low 4	2427	2.16	2.12	0.5
Mid 6	2437	2.16	2.12	0.5
High 8	2447	2.20	2.16	0.5
High 9	2452	2.04	2.16	0.5
High 10	2457	2.12	2.16	0.5
High 11	2462	2.12	2.08	0.5
High 12	2467	2.12	2.12	0.5
High 13	2472	2.16	2.16	0.5

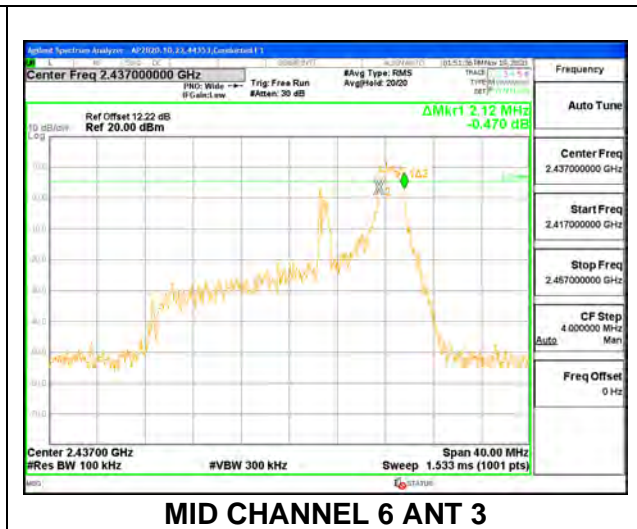
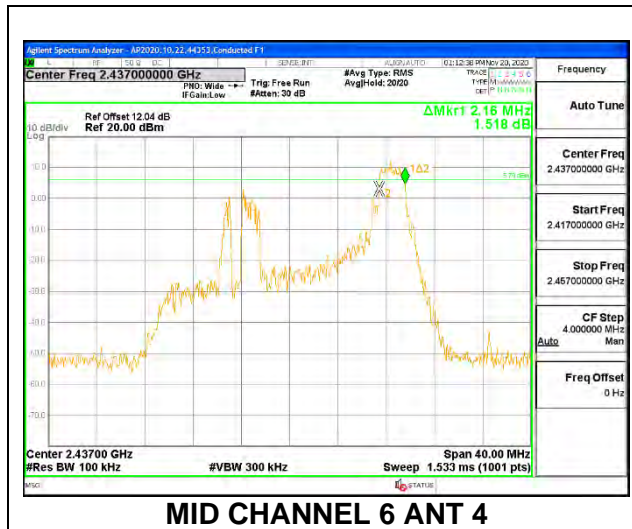

9.4. OUTPUT POWER

LIMITS

FCC §15.247 (b) (3)

RSS-247 5.4 (d)

For systems using digital modulation in the 902–928 MHz, 2400–2483.5 MHz, and 5725–5850 MHz bands: 1 Watt, based on the use of antennas with directional gains that do not exceed 6 dBi. If transmitting antennas of directional gain greater than 6 dBi are used, the conducted output power from the intentional radiator shall be reduced by the amount in dB that the directional gain of the antenna exceeds 6 dBi.

TEST PROCEDURE

The power output was measured on the EUT antenna port using SMA cable with 10dB attenuator connected to a power meter via wideband average power sensor. Gated average output power was read directly from power meter.

DIRECTIONAL ANTENNA GAIN

For 1 TX:

There is only one transmitter output therefore the directional gain is equal to the antenna gain.

For 2 TX:

Tx chains are uncorrelated for power and correlated for PSD due to the device supporting CDD in all MIMO modes. The directional gains are as follows:

Band (GHz)	ANT 4 Antenna Gain (dBi)	ANT 3 Antenna Gain (dBi)	Uncorrelated Chains Directional Gain (dBi)	Correlated Chains Directional Gain (dBi)
2.4	0.10	-0.60	-0.24	2.77

RESULTS

9.4.1. 802.11b MODE 1TX

Test Engineer:	44353
Test Date:	4/16/2021

1TX ANT 4 MODE**Limits**

Channel	Frequency (MHz)	Directional Gain (dBi)	FCC Power Limit (dBm)	ISED Power Limit (dBm)	ISED EIRP Limit (dBm)	Max Power (dBm)
Low 1	2412	0.10	30.00	30	36	30.00
Mid 6	2437	0.10	30.00	30	36	30.00
High 11	2462	0.10	30.00	30	36	30.00
High 12	2467	0.10	30.00	30	36	30.00
High 13	2472	0.10	30.00	30	36	30.00

Results

Channel	Frequency (MHz)	Meas Power (dBm)	Total Corr'd Power (dBm)	Power Limit (dBm)	Margin (dB)
Low 1	2412	21.41	21.41	30.00	-8.59
Mid 6	2437	21.37	21.37	30.00	-8.63
High 11	2462	21.30	21.30	30.00	-8.70
High 12	2467	21.31	21.31	30.00	-8.69
High 13	2472	21.39	21.39	30.00	-8.61

1TX ANT 3 MODE**Limits**

Channel	Frequency (MHz)	Directional Gain (dBi)	FCC Power Limit (dBm)	ISED Power Limit (dBm)	ISED EIRP Limit (dBm)	Max Power (dBm)
Low 1	2412	-0.60	30.00	30	36	30.00
Mid 6	2437	-0.60	30.00	30	36	30.00
High 11	2462	-0.60	30.00	30	36	30.00
High 12	2467	-0.60	30.00	30	36	30.00
High 13	2472	-0.60	30.00	30	36	30.00

Results

Channel	Frequency (MHz)	Meas Power (dBm)	Total Corr'd Power (dBm)	Power Limit (dBm)	Margin (dB)
Low 1	2412	21.31	21.31	30.00	-8.69
Mid 6	2437	21.38	21.38	30.00	-8.62
High 11	2462	21.49	21.49	30.00	-8.51
High 12	2467	21.48	21.48	30.00	-8.52
High 13	2472	21.44	21.44	30.00	-8.56

9.4.2. 802.11n HT20 MODE

Test Engineer:	44353
Test Date:	4/16/2021

1TX ANT 4 MODE**Limits**

Channel	Frequency (MHz)	Directional Gain (dBi)	FCC Power Limit (dBm)	ISED Power Limit (dBm)	ISED EIRP Limit (dBm)	Max Power (dBm)
Low 1	2412	0.10	30.00	30	36	30.00
Low 2	2417	0.10	30.00	30	36	30.00
Low 3	2422	0.10	30.00	30	36	30.00
Mid 6	2437	0.10	30.00	30	36	30.00
High 9	2452	0.10	30.00	30	36	30.00
High 10	2457	0.10	30.00	30	36	30.00
High 11	2462	0.10	30.00	30	36	30.00
High 12	2467	0.10	30.00	30	36	30.00
High 13	2472	0.10	30.00	30	36	30.00

Results

Channel	Frequency (MHz)	Meas Power (dBm)	Total Corr'd Power (dBm)	Power Limit (dBm)	Margin (dB)
Low 1	2412	17.47	17.47	30.00	-12.53
Low 2	2417	20.30	20.30	30.00	-9.70
Low 3	2422	21.48	21.48	30.00	-8.52
Mid 6	2437	21.31	21.31	30.00	-8.69
High 9	2452	21.32	21.32	30.00	-8.68
High 10	2457	20.46	20.46	30.00	-9.54
High 11	2462	18.25	18.25	30.00	-11.75
High 12	2467	16.34	16.34	30.00	-13.66
High 13	2472	14.87	14.87	30.00	-15.13

1TX ANT 3 MODE**Limits**

Channel	Frequency (MHz)	Directional Gain (dBi)	FCC Power Limit (dBm)	ISED Power Limit (dBm)	ISED EIRP Limit (dBm)	Max Power (dBm)
Low 1	2412	-0.60	30.00	30	36	30.00
Low 2	2417	-0.60	30.00	30	36	30.00
Low 3	2422	-0.60	30.00	30	36	30.00
Mid 6	2437	-0.60	30.00	30	36	30.00
High 9	2452	-0.60	30.00	30	36	30.00
High 10	2457	-0.60	30.00	30	36	30.00
High 11	2462	-0.60	30.00	30	36	30.00
High 12	2467	-0.60	30.00	30	36	30.00
High 13	2472	-0.60	30.00	30	36	30.00

Results

Channel	Frequency (MHz)	Meas Power (dBm)	Total Corr'd Power (dBm)	Power Limit (dBm)	Margin (dB)
Low 1	2412	17.44	17.44	30.00	-12.56
Low 2	2417	20.47	20.47	30.00	-9.53
Low 3	2422	21.39	21.39	30.00	-8.61
Mid 6	2437	21.28	21.28	30.00	-8.72
High 9	2452	21.35	21.35	30.00	-8.65
High 10	2457	20.37	20.37	30.00	-9.63
High 11	2462	18.40	18.40	30.00	-11.60
High 12	2467	16.36	16.36	30.00	-13.64
High 13	2472	14.90	14.90	30.00	-15.10

9.4.3. 802.11n HT20 CDD MODE 2TX

Test Engineer:	44353
Test Date:	4/16/2021

Limits

Channel	Frequency (MHz)	Directional Gain (dBi)	FCC/ISED Power Limit (dBm)	ISED EIRP Limit (dBm)	Max Power (dBm)
Low 1	2412	-0.24	30.00	36	30.00
Low 2	2417	-0.24	30.00	36	30.00
Low 3	2422	-0.24	30.00	36	30.00
Low 4	2427	-0.24	30.00	36	30.00
Mid 6	2437	-0.24	30.00	36	30.00
High 8	2447	-0.24	30.00	36	30.00
High 9	2452	-0.24	30.00	36	30.00
High 10	2457	-0.24	30.00	36	30.00
High 11	2462	-0.24	30.00	36	30.00
High 12	2467	-0.24	30.00	36	30.00
High 13	2472	-0.24	30.00	36	30.00

Results

Channel	Frequency (MHz)	ANT 4 Meas Power (dBm)	ANT 3 Meas Power (dBm)	Total Corr'd Power (dBm)	Power Limit (dBm)	Margin (dB)
Low 1	2412	16.78	16.91	19.86	30.00	-10.14
Low 2	2417	19.26	19.45	22.37	30.00	-7.63
Low 3	2422	20.80	20.94	23.88	30.00	-6.12
Low 4	2427	21.35	21.37	24.37	30.00	-5.63
Mid 6	2437	21.27	21.28	24.29	30.00	-5.71
High 8	2447	21.25	21.28	24.28	30.00	-5.72
High 9	2452	20.30	20.40	23.36	30.00	-6.64
High 10	2457	19.36	19.40	22.39	30.00	-7.61
High 11	2462	17.42	17.25	20.35	30.00	-9.65
High 12	2467	14.93	14.76	17.86	30.00	-12.14
High 13	2472	14.35	14.44	17.41	30.00	-12.59

9.4.4. 802.11ax HE20 MODE

Test Engineer:	44353
Test Date:	7/10/2021

1TX ANT 4 MODE: 26-Tones, RU Index 0**Limits**

Channel	Frequency (MHz)	Directional Gain (dBi)	FCC Power Limit (dBm)	ISED Power Limit (dBm)	ISED EIRP Limit (dBm)	Max Power (dBm)
Low 1	2412	0.10	30.00	30	36	30.00
Mid 6	2437	0.10	30.00	30	36	30.00
High 11	2462	0.10	30.00	30	36	30.00
High 12	2467	0.10	30.00	30	36	30.00
High 13	2472	0.10	30.00	30	36	30.00

Results

Channel	Frequency (MHz)	Meas Power (dBm)	Total Corr'd Power (dBm)	Power Limit (dBm)	Margin (dB)
Low 1	2412	11.82	11.82	30.00	-18.18
Mid 6	2437	11.85	11.85	30.00	-18.15
High 11	2462	11.84	11.84	30.00	-18.16
High 12	2467	11.83	11.83	30.00	-18.17
High 13	2472	0.99	0.99	30.00	-29.01

1TX ANT 4 MODE: 26-Tones, RU Index 4**Limits**

Channel	Frequency (MHz)	Directional Gain (dBi)	FCC Power Limit (dBm)	ISED Power Limit (dBm)	ISED EIRP Limit (dBm)	Max Power (dBm)
Low 1	2412	0.10	30.00	30	36	30.00
Mid 6	2437	0.10	30.00	30	36	30.00
High 11	2462	0.10	30.00	30	36	30.00
High 12	2467	0.10	30.00	30	36	30.00
High 13	2472	0.10	30.00	30	36	30.00

Results

Channel	Frequency (MHz)	Meas Power (dBm)	Total Corr'd Power (dBm)	Power Limit (dBm)	Margin (dB)
Low 1	2412	11.79	11.79	30.00	-18.21
Mid 6	2437	11.81	11.81	30.00	-18.19
High 11	2462	11.80	11.80	30.00	-18.20
High 12	2467	11.82	11.82	30.00	-18.18
High 13	2472	0.92	0.92	30.00	-29.08

1TX ANT 4 MODE: 26-Tones, RU Index 8**Limits**

Channel	Frequency (MHz)	Directional Gain (dBi)	FCC Power Limit (dBm)	ISED Power Limit (dBm)	ISED EIRP Limit (dBm)	Max Power (dBm)
Low 1	2412	0.10	30.00	30	36	30.00
Mid 6	2437	0.10	30.00	30	36	30.00
High 11	2462	0.10	30.00	30	36	30.00
High 12	2467	0.10	30.00	30	36	30.00
High 13	2472	0.10	30.00	30	36	30.00

Results

Channel	Frequency (MHz)	Meas Power (dBm)	Total Corr'd Power (dBm)	Power Limit (dBm)	Margin (dB)
Low 1	2412	11.81	11.81	30.00	-18.19
Mid 6	2437	11.77	11.77	30.00	-18.23
High 11	2462	11.79	11.79	30.00	-18.21
High 12	2467	11.86	11.86	30.00	-18.14
High 13	2472	0.87	0.87	30.00	-29.13

1TX ANT 4 MODE: SU Tones**Limits**

Channel	Frequency (MHz)	Directional Gain (dBi)	FCC Power Limit (dBm)	ISED Power Limit (dBm)	ISED EIRP Limit (dBm)	Max Power (dBm)
Low 1	2412	0.10	30.00	30	36	30.00
Low 2	2417	0.10	30.00	30	36	30.00
Low 3	2422	0.10	30.00	30	36	30.00
Mid 6	2437	0.10	30.00	30	36	30.00
High 9	2452	0.10	30.00	30	36	30.00
High 10	2457	0.10	30.00	30	36	30.00
High 11	2462	0.10	30.00	30	36	30.00
High 12	2467	0.10	30.00	30	36	30.00
High 13	2472	0.10	30.00	30	36	30.00

Results

Channel	Frequency (MHz)	Meas Power (dBm)	Total Corr'd Power (dBm)	Power Limit (dBm)	Margin (dB)
Low 1	2412	16.81	16.81	30.00	-13.19
Low 2	2417	18.95	18.95	30.00	-11.05
Low 3	2422	20.86	20.86	30.00	-9.14
Mid 6	2437	21.38	21.38	30.00	-8.62
High 9	2452	20.98	20.98	30.00	-9.02
High 10	2457	18.97	18.97	30.00	-11.03
High 11	2462	16.96	16.96	30.00	-13.04
High 12	2467	14.84	14.84	30.00	-15.16
High 13	2472	9.94	9.94	30.00	-20.06

1TX ANT 3 MODE: 26-Tones, RU Index 0**Limits**

Channel	Frequency (MHz)	Directional Gain (dBi)	FCC Power Limit (dBm)	ISED Power Limit (dBm)	ISED EIRP Limit (dBm)	Max Power (dBm)
Low 1	2412	-0.60	30.00	30	36	30.00
Mid 6	2437	-0.60	30.00	30	36	30.00
High 11	2462	-0.60	30.00	30	36	30.00
High 12	2467	-0.60	30.00	30	36	30.00
High 13	2472	-0.60	30.00	30	36	30.00

Results

Channel	Frequency (MHz)	Meas Power (dBm)	Total Corr'd Power (dBm)	Power Limit (dBm)	Margin (dB)
Low 1	2412	11.80	11.80	30.00	-18.20
Mid 6	2437	11.78	11.78	30.00	-18.22
High 11	2462	11.84	11.84	30.00	-18.16
High 12	2467	11.85	11.85	30.00	-18.15
High 13	2472	0.93	0.93	30.00	-29.07

1TX ANT 3 MODE: 26-Tones, RU Index 4**Limits**

Channel	Frequency (MHz)	Directional Gain (dBi)	FCC Power Limit (dBm)	ISED Power Limit (dBm)	ISED EIRP Limit (dBm)	Max Power (dBm)
Low 1	2412	-0.60	30.00	30	36	30.00
Mid 6	2437	-0.60	30.00	30	36	30.00
High 11	2462	-0.60	30.00	30	36	30.00
High 12	2467	-0.60	30.00	30	36	30.00
High 13	2472	-0.60	30.00	30	36	30.00

Results

Channel	Frequency (MHz)	Meas Power (dBm)	Total Corr'd Power (dBm)	Power Limit (dBm)	Margin (dB)
Low 1	2412	11.75	11.75	30.00	-18.25
Mid 6	2437	11.78	11.78	30.00	-18.22
High 11	2462	11.76	11.76	30.00	-18.24
High 12	2467	11.73	11.73	30.00	-18.27
High 13	2472	0.67	0.67	30.00	-29.33

1TX ANT 3 MODE: 26-Tones, RU Index 8**Limits**

Channel	Frequency (MHz)	Directional Gain (dBi)	FCC Power Limit (dBm)	ISED Power Limit (dBm)	ISED EIRP Limit (dBm)	Max Power (dBm)
Low 1	2412	-0.60	30.00	30	36	30.00
Mid 6	2437	-0.60	30.00	30	36	30.00
High 11	2462	-0.60	30.00	30	36	30.00
High 12	2467	-0.60	30.00	30	36	30.00
High 13	2472	-0.60	30.00	30	36	30.00

Results

Channel	Frequency (MHz)	Meas Power (dBm)	Total Corr'd Power (dBm)	Power Limit (dBm)	Margin (dB)
Low 1	2412	11.80	11.80	30.00	-18.20
Mid 6	2437	11.82	11.82	30.00	-18.18
High 11	2462	11.79	11.79	30.00	-18.21
High 12	2467	11.77	11.77	30.00	-18.23
High 13	2472	0.80	0.80	30.00	-29.20

1TX ANT 3 MODE: SU Tones**Limits**

Channel	Frequency (MHz)	Directional Gain (dBi)	FCC Power Limit (dBm)	ISED Power Limit (dBm)	ISED EIRP Limit (dBm)	Max Power (dBm)
Low 1	2412	-0.60	30.00	30	36	30.00
Low 2	2417	-0.60	30.00	30	36	30.00
Low 3	2422	-0.60	30.00	30	36	30.00
Mid 6	2437	-0.60	30.00	30	36	30.00
High 9	2452	-0.60	30.00	30	36	30.00
High 10	2457	-0.60	30.00	30	36	30.00
High 11	2462	-0.60	30.00	30	36	30.00
High 12	2467	-0.60	30.00	30	36	30.00
High 13	2472	-0.60	30.00	30	36	30.00

Results

Channel	Frequency (MHz)	Meas Power (dBm)	Total Corr'd Power (dBm)	Power Limit (dBm)	Margin (dB)
Low 1	2412	16.78	16.78	30.00	-13.22
Low 2	2417	18.84	18.84	30.00	-11.16
Low 3	2422	20.83	20.83	30.00	-9.17
Mid 6	2437	21.46	21.46	30.00	-8.54
High 9	2452	20.99	20.99	30.00	-9.01
High 10	2457	18.86	18.86	30.00	-11.14
High 11	2462	16.95	16.95	30.00	-13.05
High 12	2467	14.74	14.74	30.00	-15.26
High 13	2472	9.80	9.80	30.00	-20.20

9.4.5. 802.11ax HE20 OFDMA MODE 2TX

Test Engineer:	44353
Test Date:	7/10/2021

ANT 4 + ANT 3 2TX MODE: 26-Tones, RU Index 0**Limits**

Channel	Frequency (MHz)	Directional Gain (dBi)	FCC/ISED Power Limit (dBm)	ISED EIRP Limit (dBm)	Max Power (dBm)
Low 1	2412	-0.24	30.00	36	30.00
Mid 6	2437	-0.24	30.00	36	30.00
High 11	2462	-0.24	30.00	36	30.00
High 12	2467	-0.24	30.00	36	30.00
High 13	2472	-0.24	30.00	36	30.00

Results

Channel	Frequency (MHz)	ANT 4 Meas Power (dBm)	ANT 3 Meas Power (dBm)	Total Corr'd Power (dBm)	Power Limit (dBm)	Margin (dB)
Low 1	2412	11.88	11.9	14.90	30.00	-15.10
Mid 6	2437	11.84	11.86	14.86	30.00	-15.14
High 11	2462	11.84	11.85	14.86	30.00	-15.14
High 12	2467	11.8	11.87	14.85	30.00	-15.15
High 13	2472	-0.26	-0.05	2.86	30.00	-27.14

ANT 4 + ANT 3 2TX MODE: 26-Tones, RU Index 4**Limits**

Channel	Frequency (MHz)	Directional Gain (dBi)	FCC/ISED Power Limit (dBm)	ISED EIRP Limit (dBm)	Max Power (dBm)
Low 1	2412	-0.24	30.00	36	30.00
Mid 6	2437	-0.24	30.00	36	30.00
High 11	2462	-0.24	30.00	36	30.00
High 12	2467	-0.24	30.00	36	30.00
High 13	2472	-0.24	30.00	36	30.00

Results

Channel	Frequency (MHz)	ANT 4 Meas Power (dBm)	ANT 3 Meas Power (dBm)	Total Corr'd Power (dBm)	Power Limit (dBm)	Margin (dB)
Low 1	2412	11.74	11.80	14.78	30.00	-15.22
Mid 6	2437	11.78	11.81	14.81	30.00	-15.19
High 11	2462	11.79	11.76	14.79	30.00	-15.21
High 12	2467	11.78	11.80	14.80	30.00	-15.20
High 13	2472	-0.13	-0.17	2.86	30.00	-27.14

ANT 4 + ANT 3 2TX MODE: 26-Tones, RU Index 8**Limits**

Channel	Frequency (MHz)	Directional Gain (dBi)	FCC/ISED Power Limit (dBm)	ISED EIRP Limit (dBm)	Max Power (dBm)
Low 1	2412	-0.24	30.00	36	30.00
Mid 6	2437	-0.24	30.00	36	30.00
High 11	2462	-0.24	30.00	36	30.00
High 12	2467	-0.24	30.00	36	30.00
High 13	2472	-0.24	30.00	36	30.00

Results

Channel	Frequency (MHz)	ANT 4 Meas Power (dBm)	ANT 3 Meas Power (dBm)	Total Corr'd Power (dBm)	Power Limit (dBm)	Margin (dB)
Low 1	2412	11.82	11.92	14.88	30.00	-15.12
Mid 6	2437	11.77	11.88	14.84	30.00	-15.16
High 11	2462	11.85	11.83	14.85	30.00	-15.15
High 12	2467	11.81	11.84	14.84	30.00	-15.16
High 13	2472	-0.19	-0.01	2.91	30.00	-27.09

ANT 4 + ANT 3 2TX MODE: SU Tones**Limits**

Channel	Frequency (MHz)	Directional Gain (dBi)	FCC/ISED Power Limit (dBm)	ISED EIRP Limit (dBm)	Max Power (dBm)
Low 1	2412	-0.24	30.00	36	30.00
Low 2	2417	-0.24	30.00	36	30.00
Low 3	2422	-0.24	30.00	36	30.00
Mid 6	2437	-0.24	30.00	36	30.00
High 8	2447	-0.24	30.00	36	30.00
High 9	2452	-0.24	30.00	36	30.00
High 10	2457	-0.24	30.00	36	30.00
High 11	2462	-0.24	30.00	36	30.00
High 12	2467	-0.24	30.00	36	30.00
High 13	2472	-0.24	30.00	36	30.00

Results

Channel	Frequency (MHz)	ANT 4 Meas Power (dBm)	ANT 3 Meas Power (dBm)	Total Corr'd Power (dBm)	Power Limit (dBm)	Margin (dB)
Low 1	2412	15.86	15.91	18.90	30.00	-11.10
Low 2	2417	17.76	17.81	20.80	30.00	-9.20
Low 3	2422	19.89	19.89	22.90	30.00	-7.10
Mid 6	2437	21.40	21.28	24.35	30.00	-5.65
High 8	2447	21.37	21.40	24.40	30.00	-5.60
High 9	2452	19.36	19.26	22.32	30.00	-7.68
High 10	2457	17.76	17.80	20.79	30.00	-9.21
High 11	2462	15.95	15.77	18.87	30.00	-11.13
High 12	2467	13.35	13.36	16.37	30.00	-13.63
High 13	2472	8.99	8.84	11.93	30.00	-18.07

9.5. POWER SPECTRAL DENSITY

LIMITS

FCC §15.247 (e)

RSS-247 (5.2) (b)

The power spectral density conducted from the transmitter to the antenna shall not be greater than 8 dBm in any 3 kHz band during any time interval of continuous transmission.

RESULTS

Only Mid channel plot is reported to show analyzer settings.

9.5.1. 802.11b MODE 1TX

1TX ANT 4 MODE

Duty Cycle CF (dB)		0.00	Included in Calculations of Corr'd PSD		
Channel	Frequency (MHz)	Meas (dBm/ 3kHz)	Total Corr'd PSD (dBm/ 3kHz)	Limit (dBm/ 3kHz)	Margin (dB)
Low 1	2412	0.07	0.07	8.0	-7.9
Mid 6	2437	0.09	0.09	8.0	-7.9
High 11	2462	0.01	0.01	8.0	-8.0
High 12	2467	-0.06	-0.06	8.0	-8.1
High 13	2472	0.03	0.03	8.0	-8.0

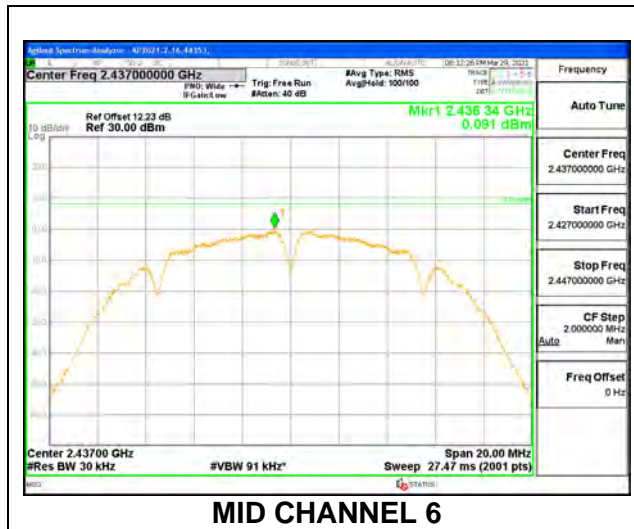

1TX ANT 3 MODE

Duty Cycle CF (dB)		0.00	Included in Calculations of Corr'd PSD		
Channel	Frequency (MHz)	Meas (dBm/ 3kHz)	Total Corr'd PSD (dBm/ 3kHz)	Limit (dBm/ 3kHz)	Margin (dB)
Low 1	2412	-0.23	-0.23	8.0	-8.2
Mid 6	2437	-0.14	-0.14	8.0	-8.1
High 11	2462	0.03	0.03	8.0	-8.0
High 12	2467	-0.07	-0.07	8.0	-8.1
High 13	2472	0.04	0.04	8.0	-8.0

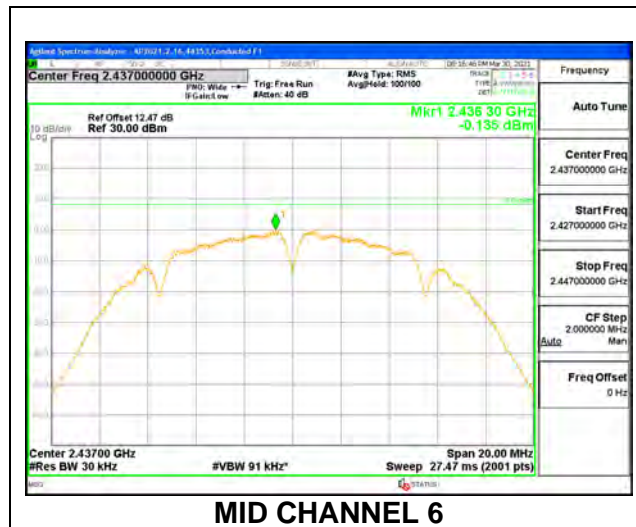

9.5.2. 802.11n HT20 MODE

1TX ANT 4 MODE

Duty Cycle CF (dB)		0.00	Included in Calculations of Corr'd PSD		
Channel	Frequency (MHz)	Meas (dBm/ 3kHz)	Total Corr'd PSD (dBm/ 3kHz)	Limit (dBm/ 3kHz)	Margin (dB)
Low 1	2412	-7.05	-7.05	8.0	-15.1
Low 2	2417	-3.93	-3.93	8.0	-11.9
Low 3	2422	-2.75	-2.75	8.0	-10.7
Mid 6	2437	-3.08	-3.08	8.0	-11.1
High 9	2452	-2.91	-2.91	8.0	-10.9
High 10	2457	-3.74	-3.74	8.0	-11.7
High 11	2462	-5.83	-5.83	8.0	-13.8
High 12	2467	-7.75	-7.75	8.0	-15.8
High 13	2472	-8.17	-8.17	8.0	-16.2

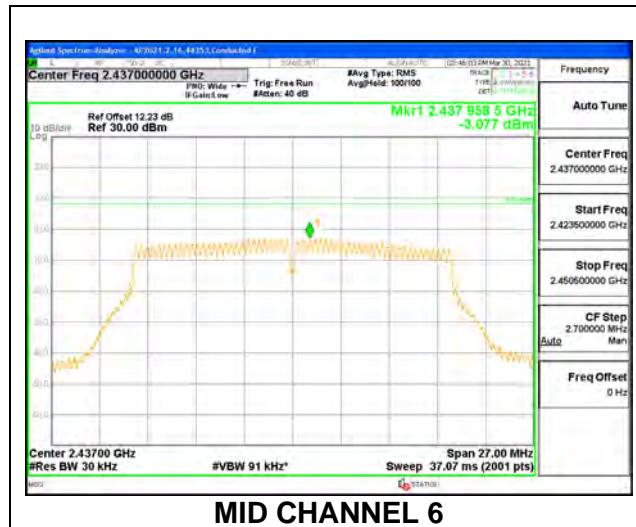

1TX ANT 3 MODE

Duty Cycle CF (dB)		0.00	Included in Calculations of Corr'd PSD		
Channel	Frequency (MHz)	Meas (dBm/ 3kHz)	Total Corr'd PSD (dBm/ 3kHz)	Limit (dBm/ 3kHz)	Margin (dB)
Low 1	2412	-6.99	-6.99	8.0	-15.0
Low 2	2417	-3.84	-3.84	8.0	-11.8
Low 3	2422	-2.84	-2.84	8.0	-10.8
Mid 6	2437	-3.00	-3.00	8.0	-11.0
High 9	2452	-3.00	-3.00	8.0	-11.0
High 10	2457	-3.87	-3.87	8.0	-11.9
High 11	2462	-5.85	-5.85	8.0	-13.9
High 12	2467	-8.06	-8.06	8.0	-16.1
High 13	2472	-7.58	-7.58	8.0	-15.6

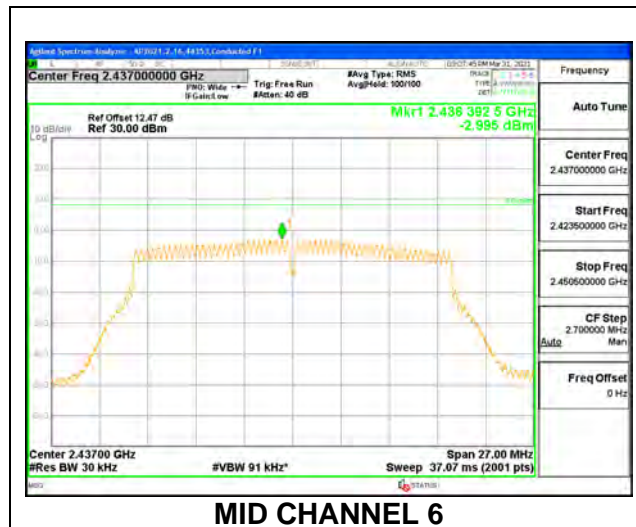

9.5.3. 802.11n HT20 CDD MODE 2TX

Duty Cycle CF (dB)		0.00		Included in Calculations of Corr'd PSD		
Channel	Frequency (MHz)	ANT 4 Meas (dBm/ 3kHz)	ANT 3 Meas (dBm/ 3kHz)	Total Corr'd PSD (dBm/ 30kHz)	Limit (dBm/ 3kHz)	Margin (dB)
Low 1	2412	-7.32	-7.60	-4.45	8.0	-12.4
Low 2	2417	-4.86	-4.80	-1.82	8.0	-9.8
Low 3	2422	-3.24	-3.31	-0.27	8.0	-8.3
Low 4	2427	-2.91	-3.03	0.04	8.0	-8.0
Mid 6	2437	-2.94	-2.77	0.15	8.0	-7.8
High 8	2447	-2.84	-3.00	0.09	8.0	-7.9
High 9	2452	-3.81	-3.82	-0.80	8.0	-8.8
High 10	2457	-4.78	-4.90	-1.83	8.0	-9.8
High 11	2462	-6.86	-6.83	-3.83	8.0	-11.8
High 12	2467	-9.33	-9.29	-6.30	8.0	-14.3
High 13	2472	-8.62	-7.99	-5.28	8.0	-13.3

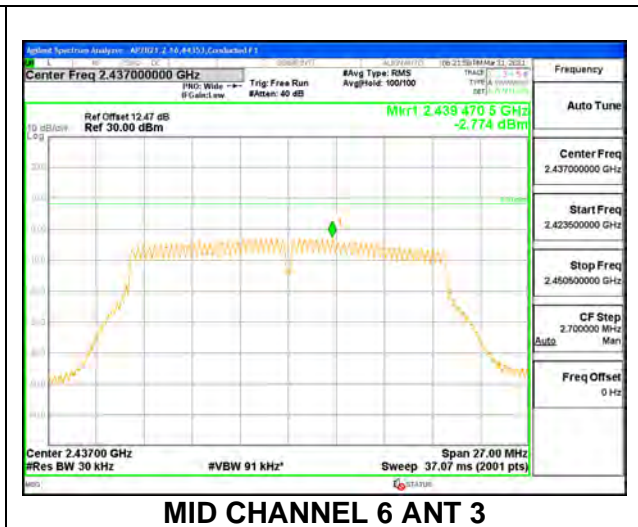
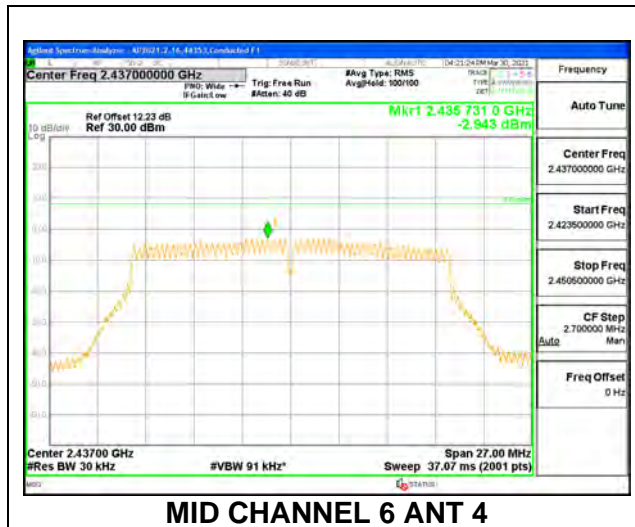

9.5.4. 802.11ax HE20 MODE

1TX ANT 4 MODE , 26-Tone RU Index 0

Duty Cycle CF (dB)		0.00	Included in Calculations of Corr'd PSD		
Channel	Frequency (MHz)	Meas (dBm/ 3kHz)	Total Corr'd PSD (dBm/ 3kHz)	Limit (dBm/ 3kHz)	Margin (dB)
Low 1	2412	-5.22	-5.22	8.0	-13.2
Mid 6	2437	-5.30	-5.30	8.0	-13.3
High 11	2462	-5.19	-5.19	8.0	-13.2
High 12	2467	-5.17	-5.17	8.0	-13.2
High 13	2472	-15.81	-15.81	8.0	-23.8

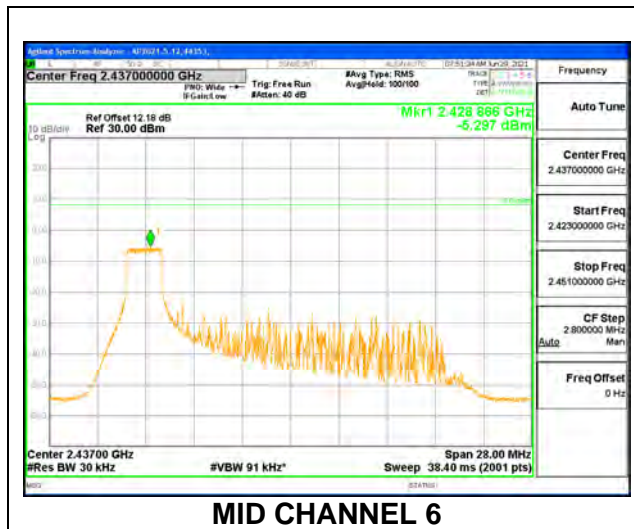

1TX ANT 4 MODE , 26-Tone RU Index 4

Duty Cycle CF (dB)		0.00	Included in Calculations of Corr'd PSD		
Channel	Frequency (MHz)	Meas (dBm/ 3kHz)	Total Corr'd PSD (dBm/ 3kHz)	Limit (dBm/ 3kHz)	Margin (dB)
Low 1	2412	-5.38	-5.38	8.0	-13.4
Mid 6	2437	-5.25	-5.25	8.0	-13.3
High 11	2462	-5.22	-5.22	8.0	-13.2
High 12	2467	-5.20	-5.20	8.0	-13.2
High 13	2472	-15.94	-15.94	8.0	-23.9

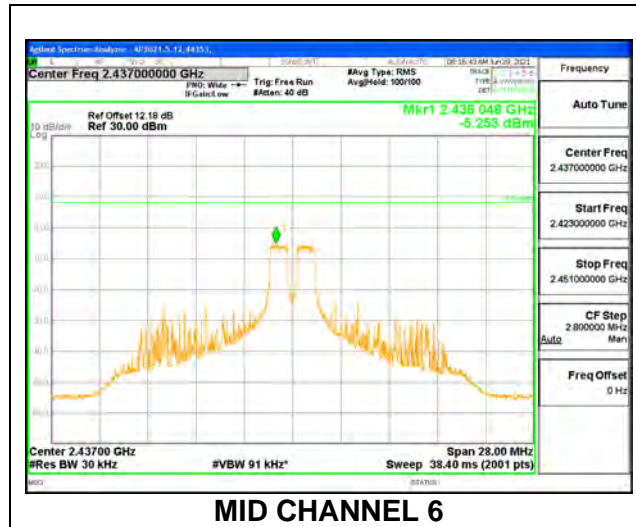

MID CHANNEL 6

TX ANT 4 MODE , 26-Tone RU Index 8

Duty Cycle CF (dB)		0.00	Included in Calculations of Corr'd PSD		
Channel	Frequency (MHz)	Meas (dBm/ 3kHz)	Total Corr'd PSD (dBm/ 3kHz)	Limit (dBm/ 3kHz)	Margin (dB)
Low 1	2412	-5.25	-5.25	8.0	-13.2
Mid 6	2437	-5.32	-5.32	8.0	-13.3
High 11	2462	-5.23	-5.23	8.0	-13.2
High 12	2467	-5.11	-5.11	8.0	-13.1
High 13	2472	-15.93	-15.93	8.0	-23.9

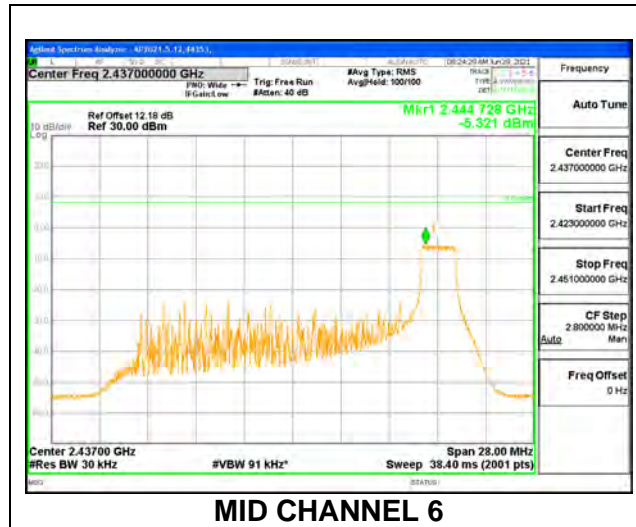

1TX ANT 4 MODE , SU Tones

Duty Cycle CF (dB)		0.00	Included in Calculations of Corr'd PSD		
Channel	Frequency (MHz)	Meas (dBm/ 3kHz)	Total Corr'd PSD (dBm/ 3kHz)	Limit (dBm/ 3kHz)	Margin (dB)
Low 1	2412	-8.57	-8.57	8.0	-16.6
Low 2	2417	-6.85	-6.85	8.0	-14.9
Low 3	2422	-4.76	-4.76	8.0	-12.8
Mid 6	2437	-4.41	-4.41	8.0	-12.4
High 9	2452	-4.82	-4.82	8.0	-12.8
High 10	2457	-6.56	-6.56	8.0	-14.6
High 11	2462	-8.33	-8.33	8.0	-16.3
High 12	2467	-10.68	-10.68	8.0	-18.7
High 13	2472	-15.80	-15.80	8.0	-23.8

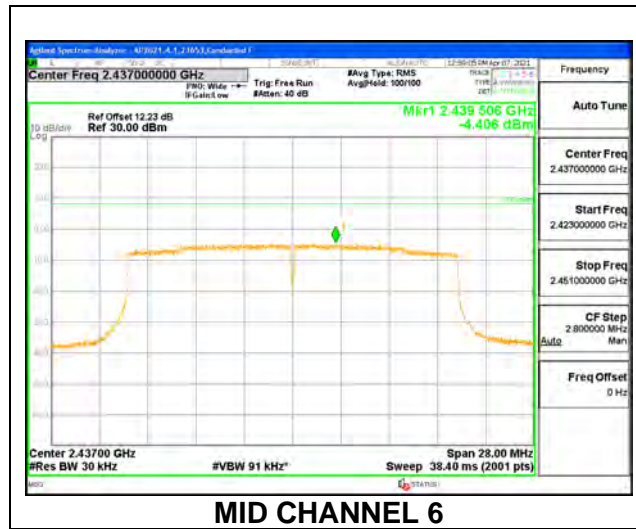

1TX ANT 3 MODE , 26-Tone RU Index 0

Duty Cycle CF (dB)		0.00	Included in Calculations of Corr'd PSD		
Channel	Frequency (MHz)	Meas (dBm/ 3kHz)	Total Corr'd PSD (dBm/ 3kHz)	Limit (dBm/ 3kHz)	Margin (dB)
Low 1	2412	-5.26	-5.26	8.0	-13.3
Mid 6	2437	-5.25	-5.25	8.0	-13.3
High 11	2462	-5.15	-5.15	8.0	-13.2
High 12	2467	-5.17	-5.17	8.0	-13.2
High 13	2472	-15.91	-15.91	8.0	-23.9

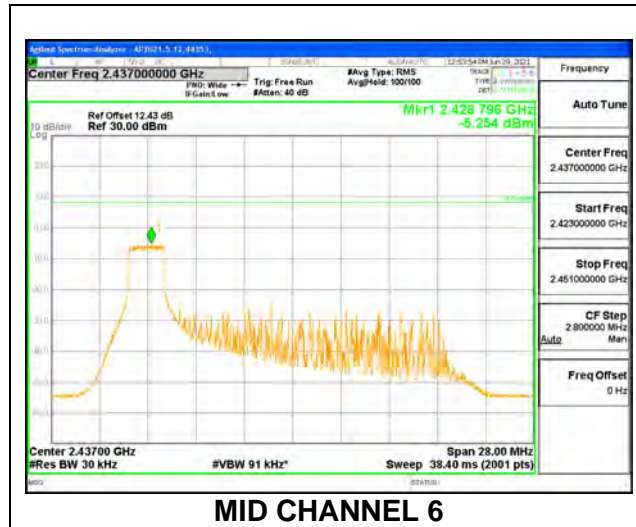

1TX ANT 3 MODE , 26-Tone RU Index 4

Duty Cycle CF (dB)		0.00	Included in Calculations of Corr'd PSD		
Channel	Frequency (MHz)	Meas (dBm/ 3kHz)	Total Corr'd PSD (dBm/ 3kHz)	Limit (dBm/ 3kHz)	Margin (dB)
Low 1	2412	-5.36	-5.36	8.0	-13.4
Mid 6	2437	-5.28	-5.28	8.0	-13.3
High 11	2462	-5.38	-5.38	8.0	-13.4
High 12	2467	-5.30	-5.30	8.0	-13.3
High 13	2472	-16.32	-16.32	8.0	-24.3

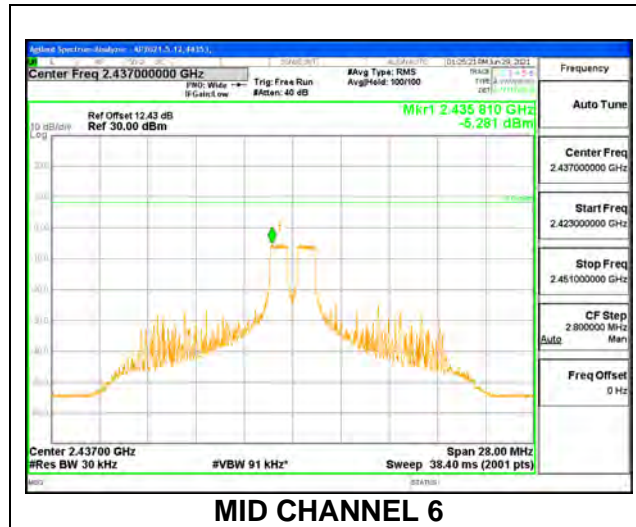

1TX ANT 3 MODE , 26-Tone RU Index 8

Duty Cycle CF (dB)		0.00	Included in Calculations of Corr'd PSD		
Channel	Frequency (MHz)	Meas (dBm/ 3kHz)	Total Corr'd PSD (dBm/ 3kHz)	Limit (dBm/ 3kHz)	Margin (dB)
Low 1	2412	-5.26	-5.26	8.0	-13.3
Mid 6	2437	-5.20	-5.20	8.0	-13.2
High 11	2462	-5.28	-5.28	8.0	-13.3
High 12	2467	-5.25	-5.25	8.0	-13.3
High 13	2472	-16.13	-16.13	8.0	-24.1

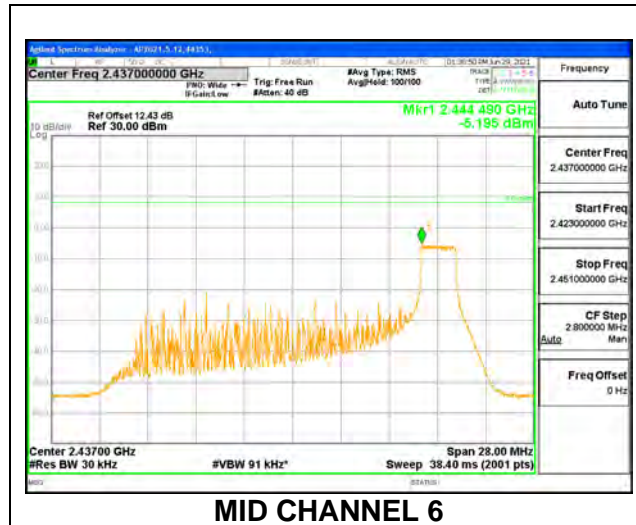

1TX ANT 3 MODE , SU Tones

Duty Cycle CF (dB)		0.00	Included in Calculations of Corr'd PSD		
Channel	Frequency (MHz)	Meas (dBm/ 3kHz)	Total Corr'd PSD (dBm/ 3kHz)	Limit (dBm/ 3kHz)	Margin (dB)
Low 1	2412	-8.92	-8.92	8.0	-16.9
Low 2	2417	-6.87	-6.87	8.0	-14.9
Low 3	2422	-4.72	-4.72	8.0	-12.7
Mid 6	2437	-4.31	-4.31	8.0	-12.3
High 9	2452	-4.77	-4.77	8.0	-12.8
High 10	2457	-6.99	-6.99	8.0	-15.0
High 11	2462	-8.76	-8.76	8.0	-16.8
High 12	2467	-10.86	-10.86	8.0	-18.9
High 13	2472	-16.01	-16.01	8.0	-24.0

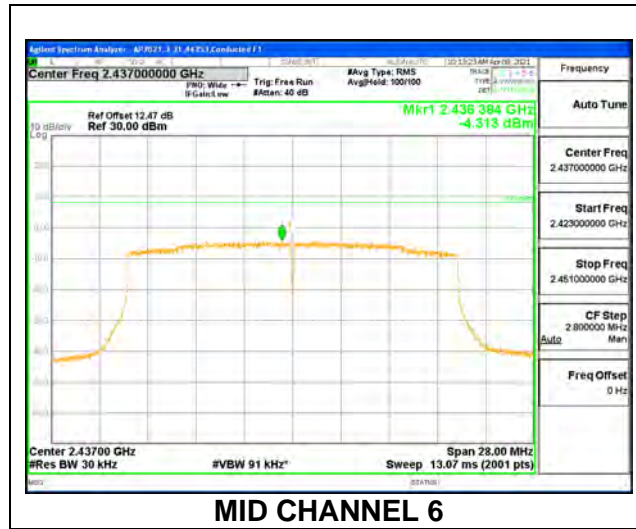

9.5.5. 802.11ax HE20 OFDMA MODE 2TX

ANT 4 + ANT 3 2TX MODE: 26-Tones, RU Index 0

Duty Cycle CF (dB)		0.00		Included in Calculations of Corr'd PSD		
Channel	Frequency (MHz)	ANT 4 Meas (dBm/ 3kHz)	ANT 3 Meas (dBm/ 30kHz)	Total Corr'd PSD (dBm/ 3kHz)	Limit (dBm/ 3kHz)	Margin (dB)
Low 1	2412	-5.13	-5.12	-2.12	8.0	-10.1
Mid 6	2437	-5.18	-5.18	-2.17	8.0	-10.2
High 11	2462	-5.19	-5.18	-2.17	8.0	-10.2
High 12	2467	-5.22	-5.15	-2.18	8.0	-10.2
High 13	2472	-17.10	-15.21	-13.04	8.0	-21.0

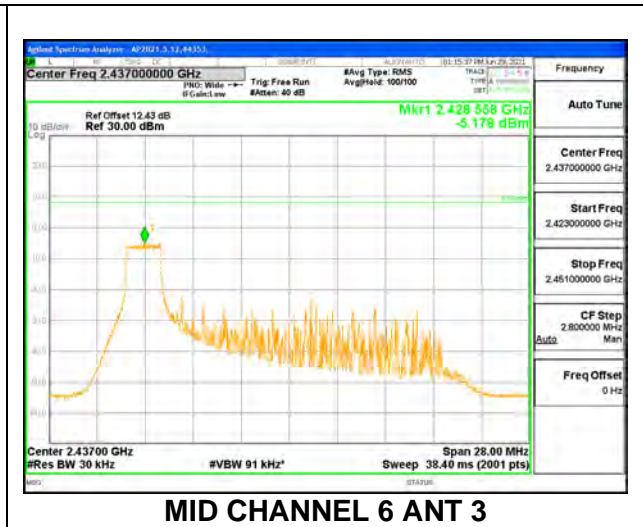
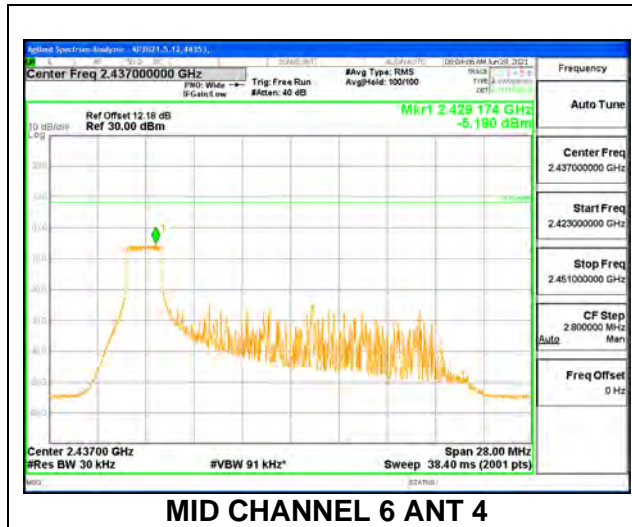

ANT 4 + ANT 3 2TX MODE: 26-Tones, RU Index 4

Duty Cycle CF (dB)		0.00		Included in Calculations of Corr'd PSD		
Channel	Frequency (MHz)	ANT 4 Meas (dBm/ 3kHz)	ANT 3 Meas (dBm/ 3kHz)	Total Corr'd PSD (dBm/ 3kHz)	Limit (dBm/ 3kHz)	Margin (dB)
Low 1	2412	-5.45	-5.24	-2.33	8.0	-10.3
Mid 6	2437	-5.30	-5.22	-2.25	8.0	-10.3
High 11	2462	-5.32	-5.35	-2.32	8.0	-10.3
High 12	2467	-5.31	-5.27	-2.28	8.0	-10.3
High 13	2472	-17.18	-16.46	-13.80	8.0	-21.8

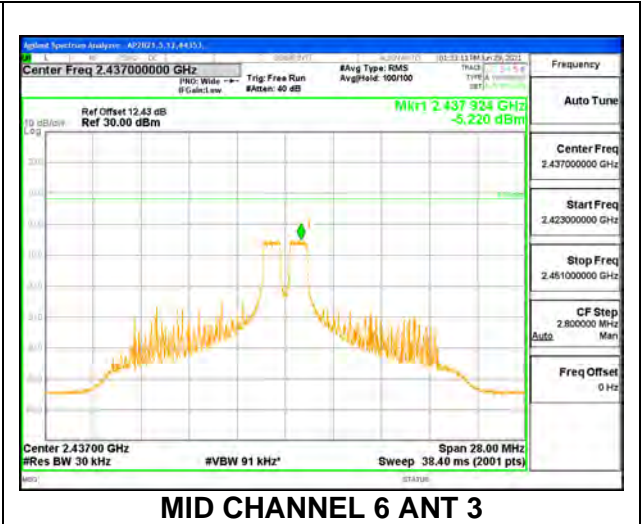
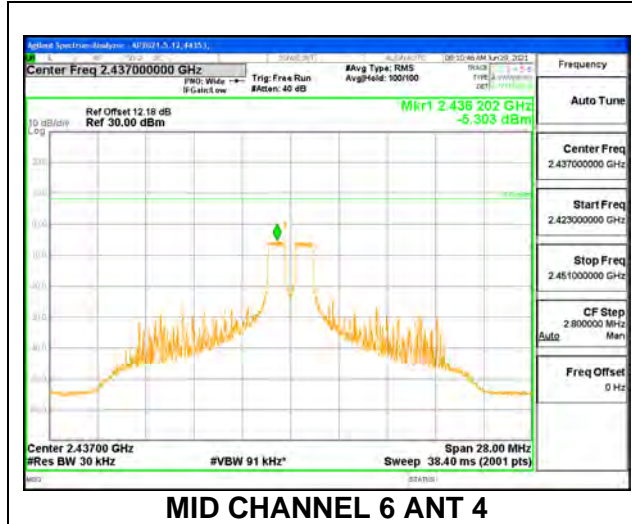

ANT 4 + ANT 3 2TX MODE: 26-Tones, RU Index 8

Duty Cycle CF (dB)		0.00		Included in Calculations of Corr'd PSD		
Channel	Frequency (MHz)	ANT 4 Meas (dBm/ 3kHz)	ANT 3 Meas (dBm/ 3kHz)	Total Corr'd PSD (dBm/ 3kHz)	Limit (dBm/ 3kHz)	Margin (dB)
Low 1	2412	-5.20	-5.13	-2.16	8.0	-10.2
Mid 6	2437	-5.26	-5.17	-2.20	8.0	-10.2
High 11	2462	-5.18	-5.25	-2.20	8.0	-10.2
High 12	2467	-5.23	-5.18	-2.19	8.0	-10.2
High 13	2472	-15.68	-16.54	-13.08	8.0	-21.1

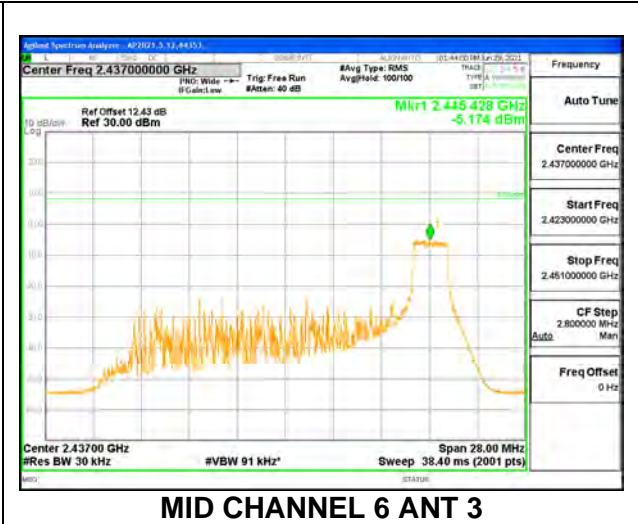
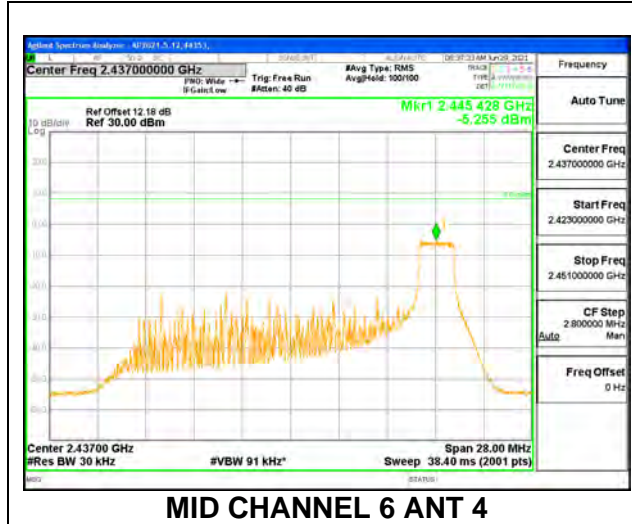

ANT 4 + ANT 3 2TX MODE: SU Tones

Duty Cycle CF (dB)		0.00		Included in Calculations of Corr'd PSD		
Channel	Frequency (MHz)	ANT 4 Meas (dBm/ 3kHz)	ANT 3 Meas (dBm/ 3kHz)	Total Corr'd PSD (dBm/ 3kHz)	Limit (dBm/ 3kHz)	Margin (dB)
Low 1	2412	-9.97	-10.00	-6.97	8.0	-15.0
Low 2	2417	-7.93	-7.88	-4.90	8.0	-12.9
Low 3	2422	-5.74	-6.03	-2.87	8.0	-10.9
Mid 6	2437	-4.57	4.35	4.87	8.0	-3.1
High 8	2447	-4.37	-4.45	-1.40	8.0	-9.4
High 9	2452	-6.56	-6.43	-3.48	8.0	-11.5
High 10	2457	-7.94	-7.94	-4.93	8.0	-12.9
High 11	2462	-9.71	-9.92	-6.80	8.0	-14.8
High 12	2467	-12.11	-12.41	-9.25	8.0	-17.2
High 13	2472	-16.78	-16.44	-13.59	8.0	-21.6

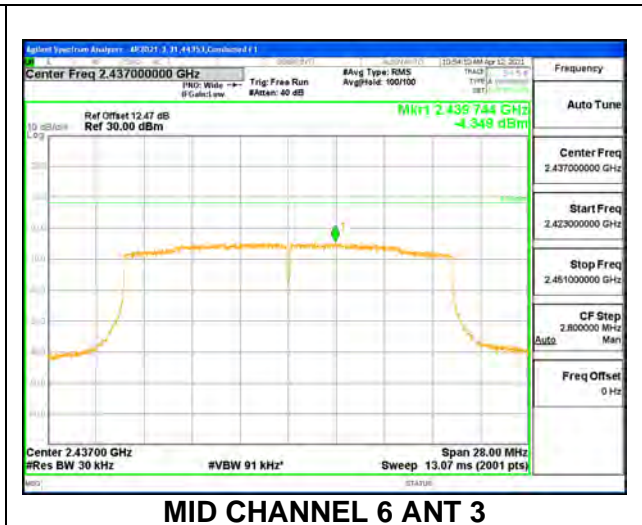
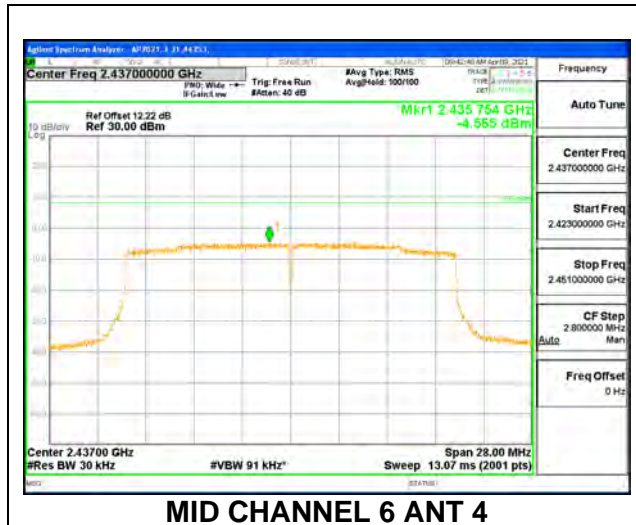

9.6. CONDUCTED SPURIOUS EMISSIONS

LIMITS

FCC §15.247 (d)

RSS-247 5.5

In any 100 kHz bandwidth outside the frequency band in which the spread spectrum or digitally modulated intentional radiator is operating, the radio frequency power that is produced by the intentional radiator shall be at least 20 dB below that in the 100 kHz bandwidth within the band that contains the highest level of the desired power, based on either an RF conducted or a radiated measurement, provided the transmitter demonstrates compliance with the peak conducted power limits. If the transmitter complies with the conducted power limits based on the use of RMS averaging over a time interval, as permitted under paragraph (b)(3) of this section, the attenuation required under this paragraph shall be 30 dB instead of 20 dB. Attenuation below the general limits specified in §15.209(a) is not required. In addition, radiated emissions which fall in the restricted bands, as defined in §15.205(a), must also comply with the radiated emission limits specified in §15.209(a) (see §15.205(c)).

Attenuated by 30dB since average power was measured.

RESULTS

9.6.1. 802.11b MODE 1TX

1TX ANT 4 MODE



LOW CHANNEL 1 BANDEDGE



OUT-OF-BAND LOW CHANNEL 1



MID CHANNEL 6 BANDEDGE



OUT-OF-BAND MID CHANNEL 6



HIGH CHANNEL 11 BANDEDGE



OUT-OF-BAND HIGH CHANNEL 11



HIGH CHANNEL 12 BANDEDGE



OUT-OF-BAND HIGH CHANNEL 12

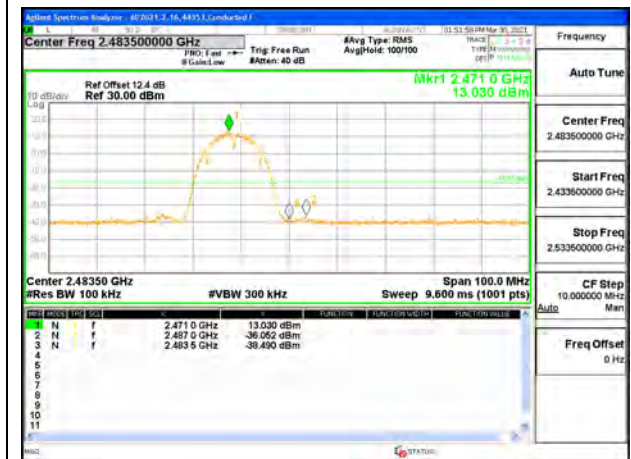

HIGH CHANNEL 13 BANDEDGE

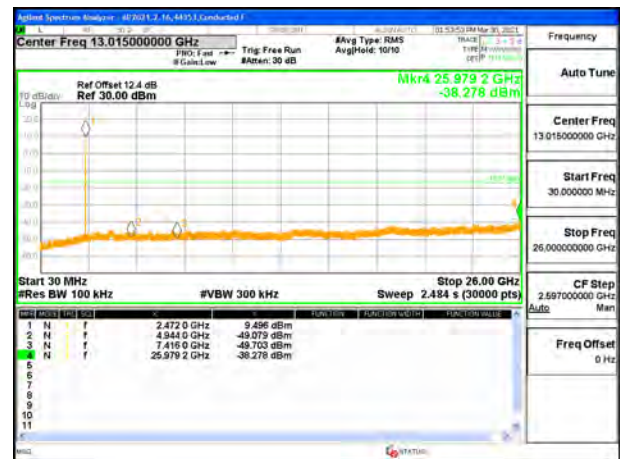

OUT-OF-BAND HIGH CHANNEL 13

1TX ANT 3 MODE



LOW CHANNEL 1 BANDEDGE



OUT-OF-BAND LOW CHANNEL 1

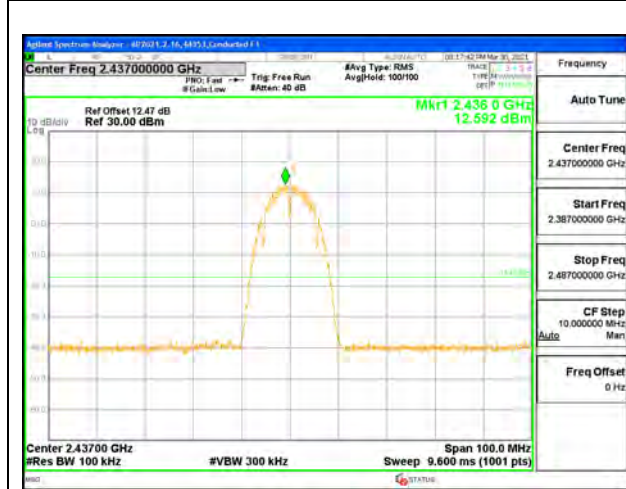

MID CHANNEL 6 BANDEDGE



OUT-OF-BAND MID CHANNEL 6



HIGH CHANNEL 11 BANDEDGE



OUT-OF-BAND HIGH CHANNEL 11



HIGH CHANNEL 12 BANDEDGE



OUT-OF-BAND HIGH CHANNEL 12



HIGH CHANNEL 13 BANDEDGE



OUT-OF-BAND HIGH CHANNEL 13

9.6.2. 802.11n HT20 MODE
1TX ANT 4 MODE

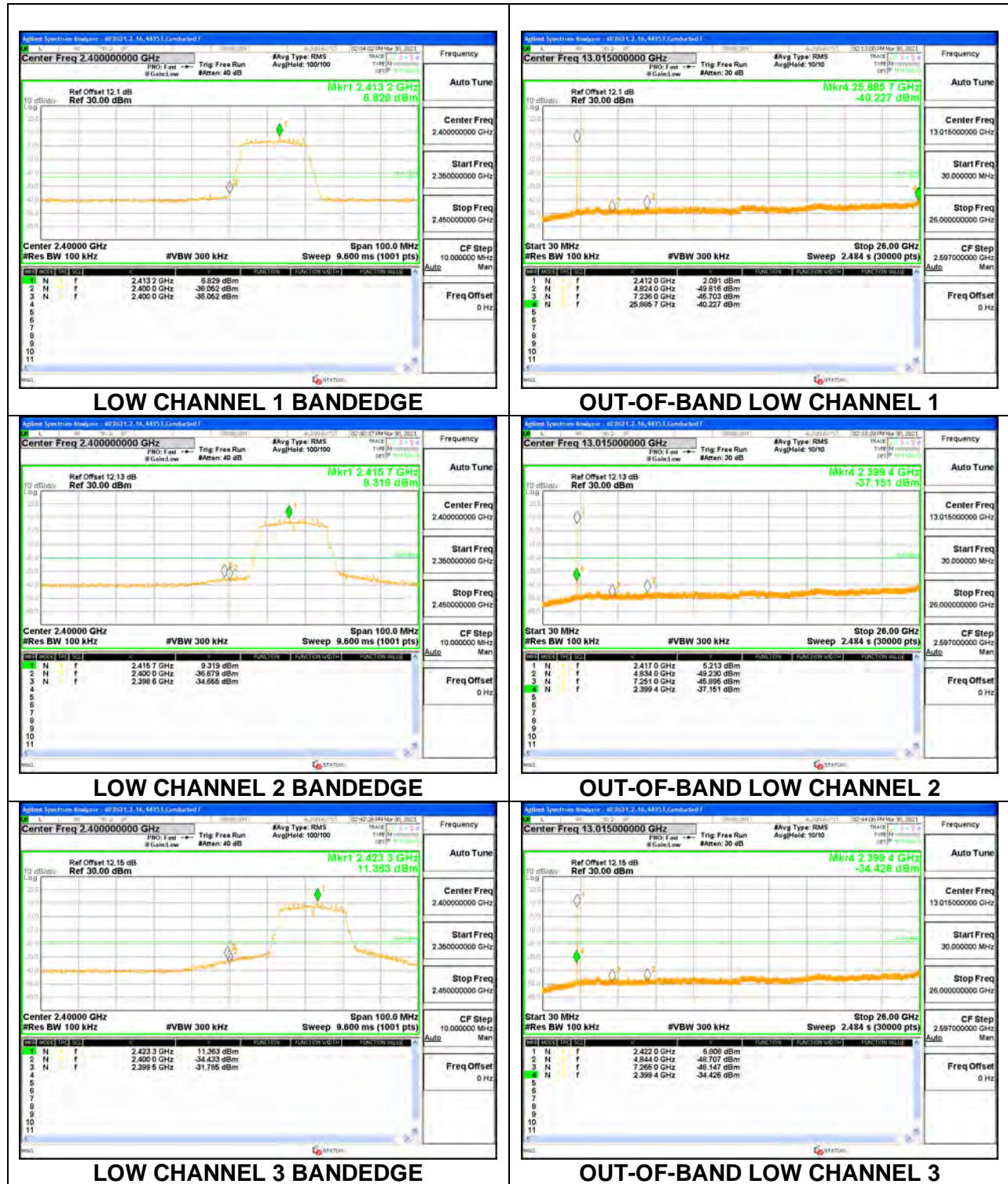

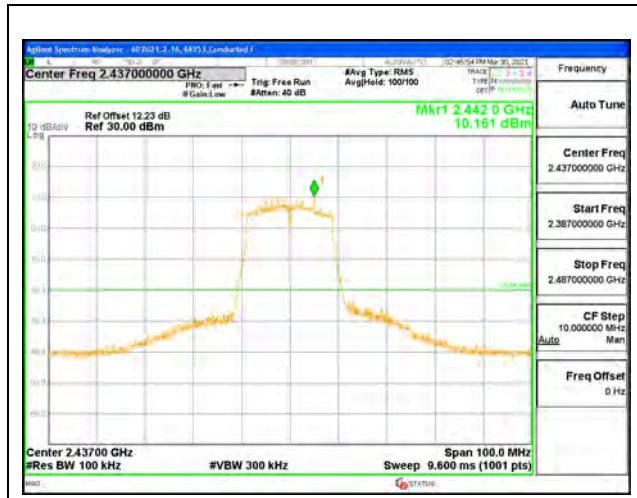

MID CHANNEL 6 BANDEDGE



OUT-OF-BAND MID CHANNEL 6

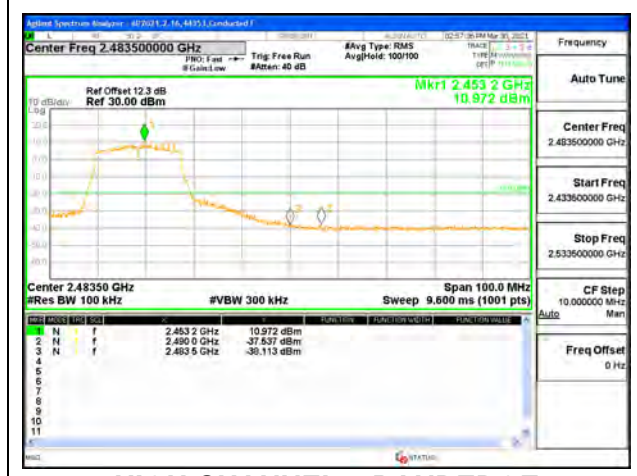

HIGH CHANNEL 9 BANDEDGE

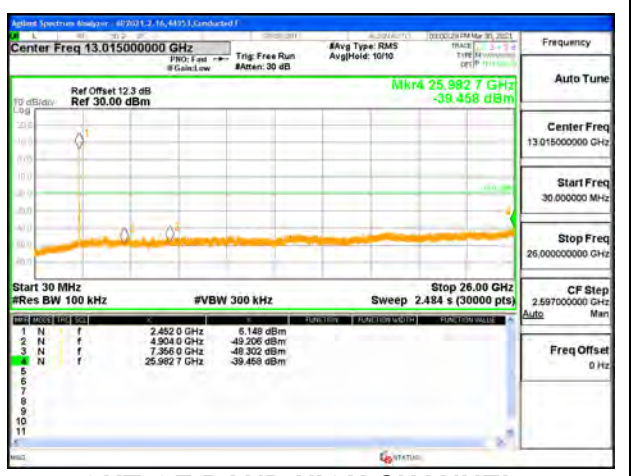

OUT-OF-BAND HIGH CHANNEL 9



HIGH CHANNEL 10 BANDEDGE



OUT-OF-BAND HIGH CHANNEL 10



HIGH CHANNEL 11 BANDEDGE



OUT-OF-BAND HIGH CHANNEL 11



HIGH CHANNEL 12 BANDEDGE



OUT-OF-BAND HIGH CHANNEL 12



HIGH CHANNEL 13 BANDEDGE



OUT-OF-BAND HIGH CHANNEL 13

1TX ANT 3 MODE

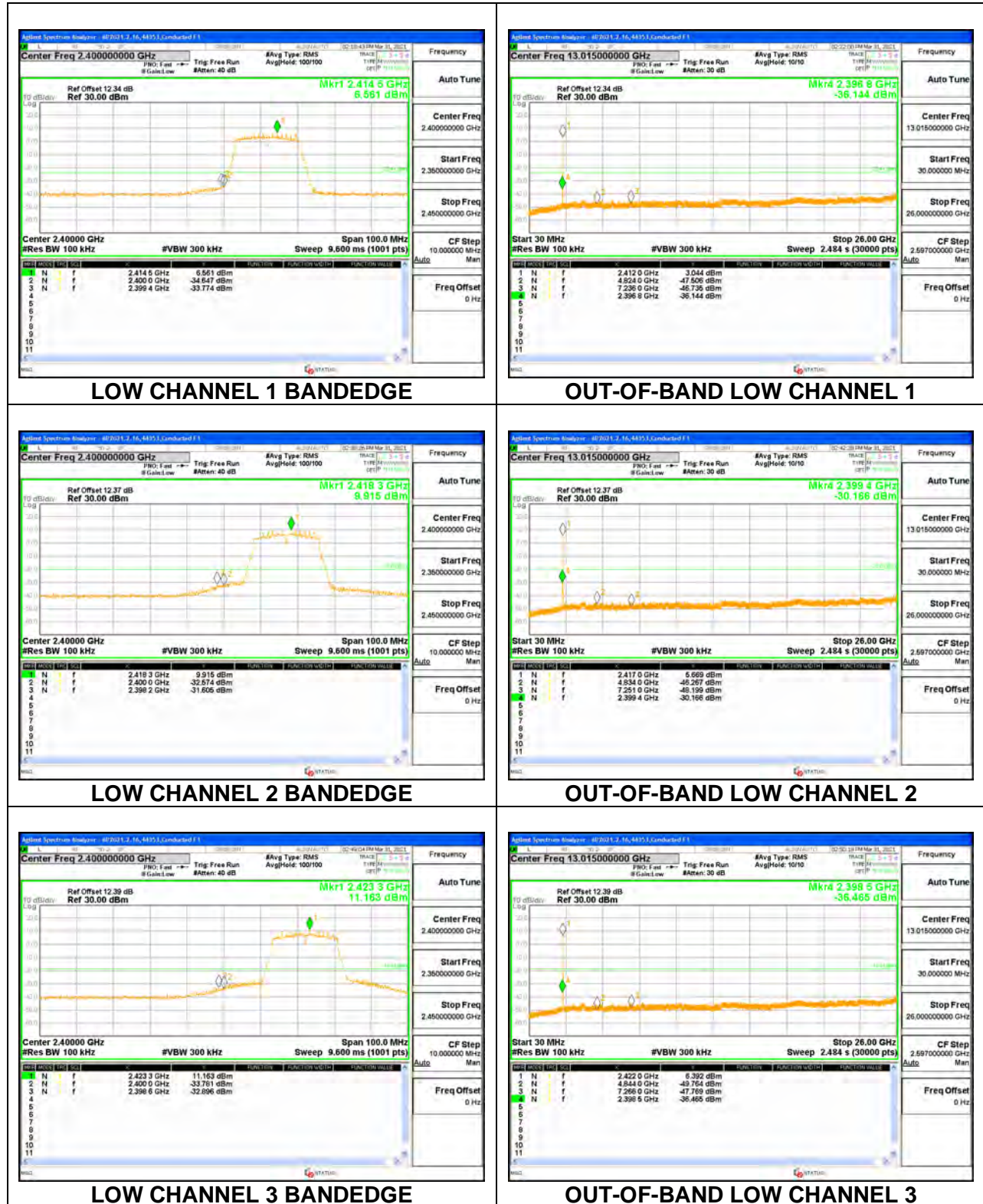

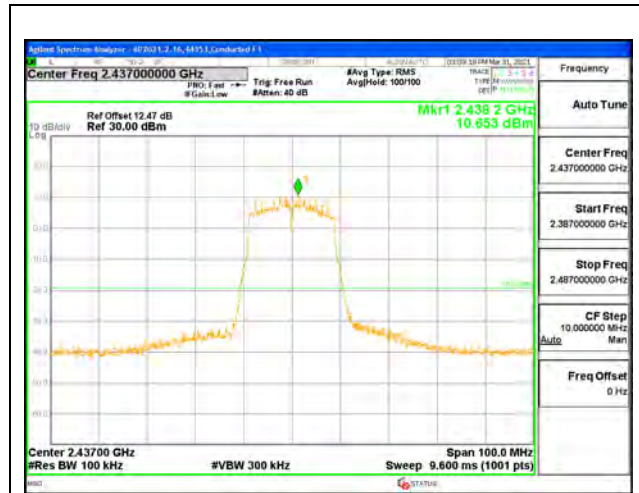

MID CHANNEL 6 BANDEDGE



OUT-OF-BAND MID CHANNEL 6



HIGH CHANNEL 9 BANDEDGE

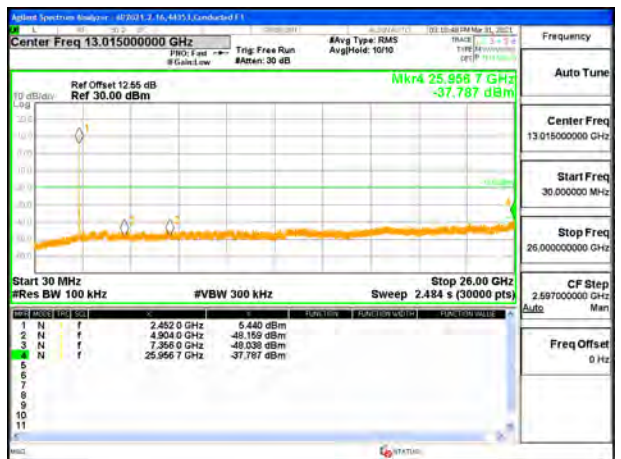

OUT-OF-BAND HIGH CHANNEL 9



HIGH CHANNEL 10 BANDEDGE



OUT-OF-BAND HIGH CHANNEL 10



HIGH CHANNEL 11 BANDEGE



OUT-OF-BAND HIGH CHANNEL 11



HIGH CHANNEL 12 BANDEGE



OUT-OF-BAND HIGH CHANNEL 12



HIGH CHANNEL 13 BANDEGE



OUT-OF-BAND HIGH CHANNEL 13

9.6.3. 802.11n HT20 MODE 2TX

2TX ANT 4 + ANT 3 CDD MODE



LOW CHANNEL 1 BANDEDGE ANT 4



OUT-OF-BAND LOW CHANNEL 1 ANT 4



LOW CHANNEL 2 BANDEDGE ANT 4



OUT-OF-BAND LOW CHANNEL 2 ANT 4



LOW CHANNEL 3 BANDEDGE ANT 4

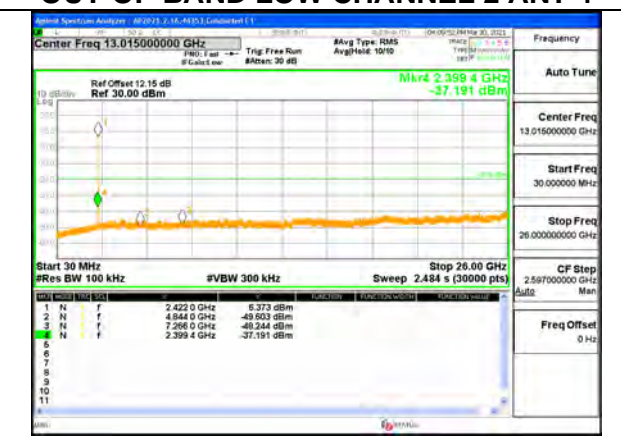

OUT-OF-BAND LOW CHANNEL 3 ANT 4

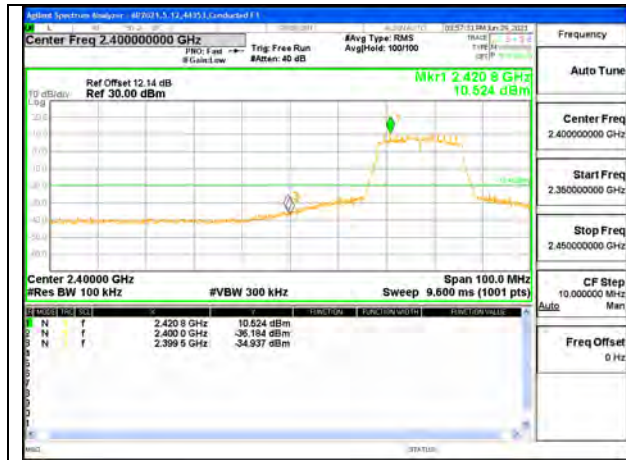

LOW CHANNEL 4 BANDEDGE ANT 4



OUT-OF-BAND LOW CHANNEL 4 ANT 4

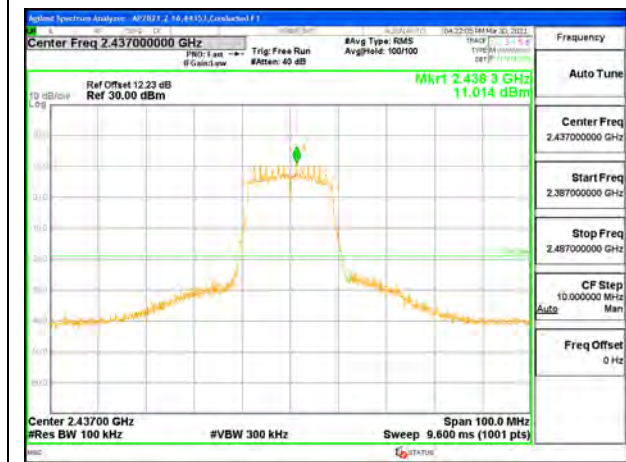

MID CHANNEL 6 BANDEDGE ANT 4



OUT-OF-BAND MID CHANNEL ANT 4



HIGH CHANNEL 8 BANDEDGE ANT 4



OUT-OF-BAND HIGH CHANNEL 8 ANT 4



HIGH CHANNEL 9 BANDEDGE ANT 4



OUT-OF-BAND HIGH CHANNEL 9 ANT 4



HIGH CHANNEL 10 BANDEDGE ANT 4



OUT-OF-BAND HIGH CHANNEL 10 ANT 4

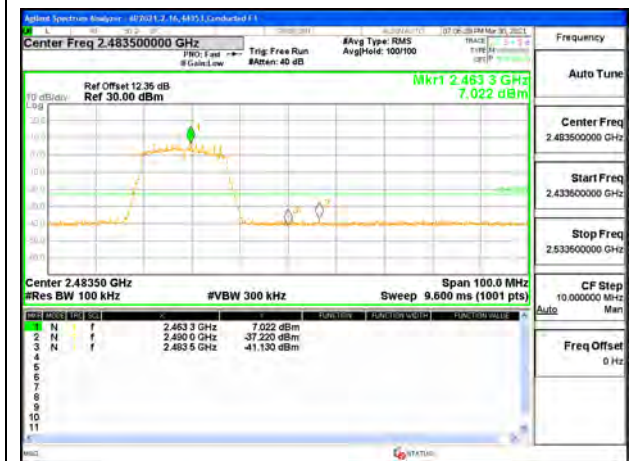

HIGH CHANNEL 11 BANDEDGE ANT 4



OUT-OF-BAND HIGH CHANNEL 11 ANT 4



HIGH CHANNEL 12 BANDEDGE ANT 4



OUT-OF-BAND HIGH CHANNEL 12 ANT 4



HIGH CHANNEL 13 BANDEDGE ANT 4



OUT-OF-BAND HIGH CHANNEL 13 ANT 4



LOW CHANNEL 1 BANDEDGE ANT 3



OUT-OF-BAND LOW CHANNEL 1 ANT 3

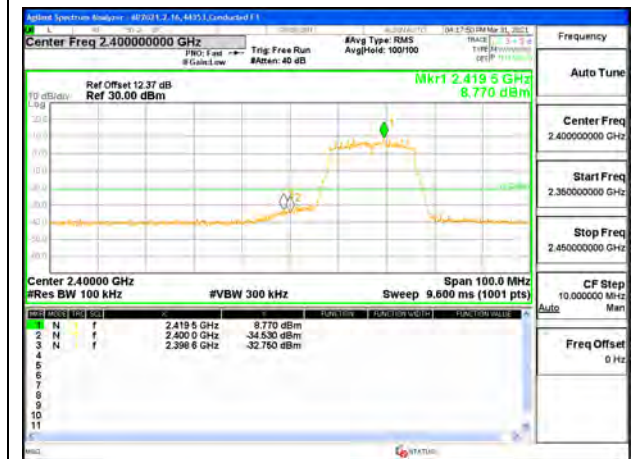

LOW CHANNEL 2 BANDEDGE ANT 3



OUT-OF-BAND LOW CHANNEL 2 ANT 3



LOW CHANNEL 3 BANDEDGE ANT 3



OUT-OF-BAND LOW CHANNEL 3 ANT 3



LOW CHANNEL 4 BANDEDGE ANT 3



OUT-OF-BAND LOW CHANNEL 4 ANT 3

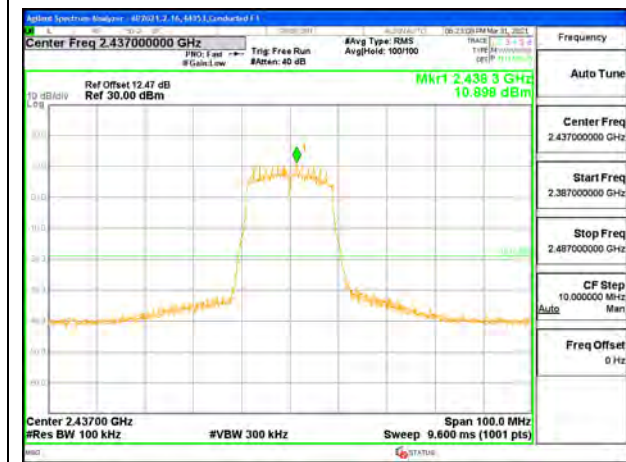

MID CHANNEL 6 BANDEDGE ANT 3



OUT-OF-BAND MID CHANNEL 6 ANT 3



HIGH CHANNEL 8 BANDEDGE ANT 3



OUT-OF-BAND HIGH CHANNEL 8 ANT 3



HIGH CHANNEL 9 BANDEDGE ANT 3



OUT-OF-BAND HIGH CHANNEL 9 ANT 3



HIGH CHANNEL 10 BANDEDGE ANT 3



OUT-OF-BAND HIGH CHANNEL 10 ANT 3



HIGH CHANNEL 11 BANDEDGE ANT 3

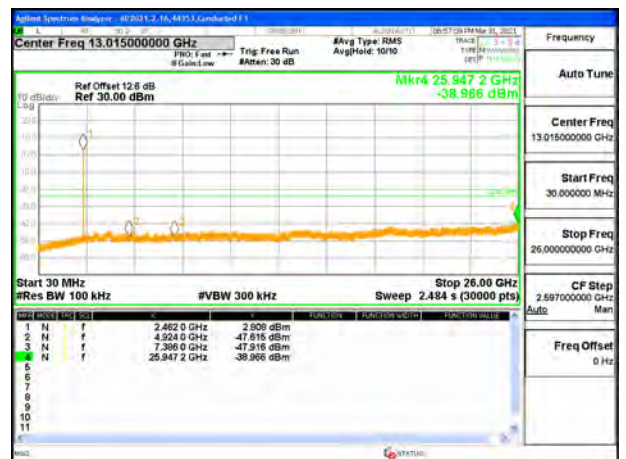

OUT-OF-BAND HIGH CHANNEL 11 ANT 3



HIGH CHANNEL 12 BANDEDGE ANT 3



OUT-OF-BAND HIGH CHANNEL 12 ANT 3



HIGH CHANNEL 13 BANDEDGE ANT 3



OUT-OF-BAND HIGH CHANNEL 13 ANT 3

9.6.4. 802.11ax HE20 MODE
1TX ANT 4 MODE, 26-Tone RU Index 0



LOW CHANNEL 1 BANDEDGE



OUT-OF-BAND LOW CHANNEL 1

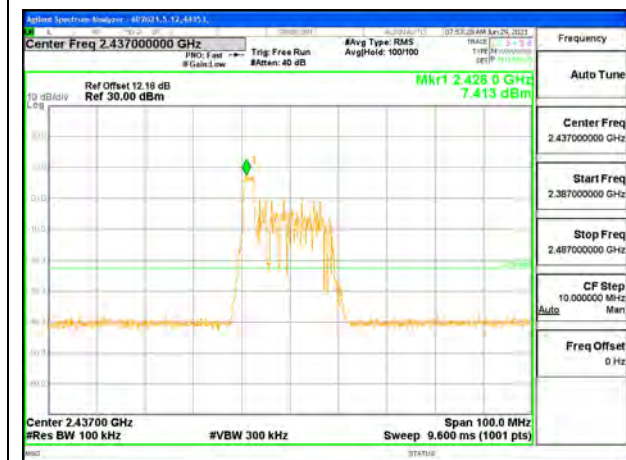

MID CHANNEL 6 BANDEDGE



OUT-OF-BAND MID CHANNEL 6



HIGH CHANNEL 11 BANDEDGE

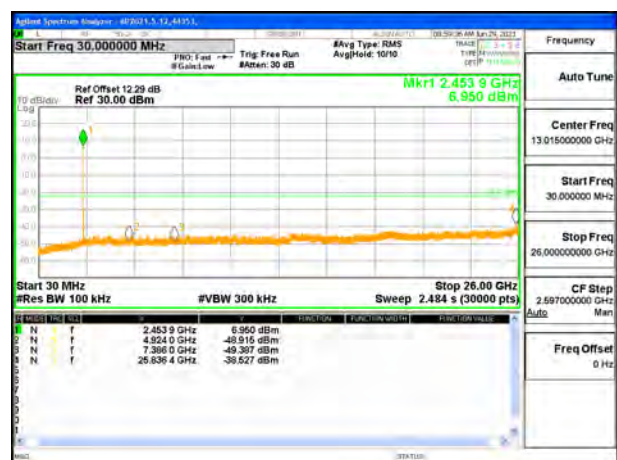

OUT-OF-BAND HIGH CHANNEL 11



HIGH CHANNEL 12 BANDEDGE



OUT-OF-BAND HIGH CHANNEL 12



HIGH CHANNEL 13 BANDEDGE



OUT-OF-BAND HIGH CHANNEL 13

1TX ANT 4 MODE, 26-Tone RU Index 4



LOW CHANNEL 1 BANDEDGE



OUT-OF-BAND LOW CHANNEL 1

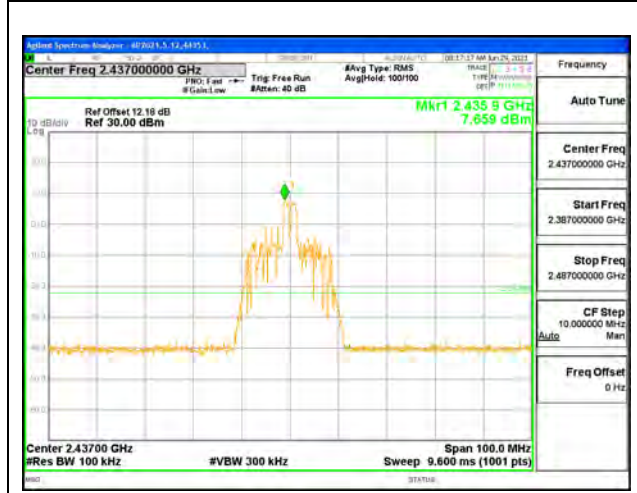

MID CHANNEL 6 BANDEDGE



OUT-OF-BAND MID CHANNEL 6



HIGH CHANNEL 11 BANDEDGE



OUT-OF-BAND HIGH CHANNEL 11



HIGH CHANNEL 12 BANDEDGE



OUT-OF-BAND HIGH CHANNEL 12



HIGH CHANNEL 13 BANDEDGE



OUT-OF-BAND HIGH CHANNEL 13

1TX ANT 4 MODE, 26-Tone RU Index 8



LOW CHANNEL 1 BANDEDGE



OUT-OF-BAND LOW CHANNEL 1

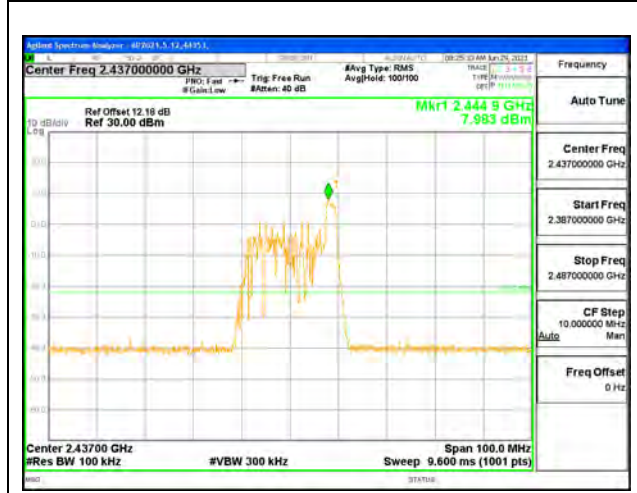

MID CHANNEL 6 BANDEDGE



OUT-OF-BAND MID CHANNEL 6



HIGH CHANNEL 11 BANDEDGE



OUT-OF-BAND HIGH CHANNEL 11



HIGH CHANNEL 12 BANDEDGE



OUT-OF-BAND HIGH CHANNEL 12



HIGH CHANNEL 13 BANDEDGE

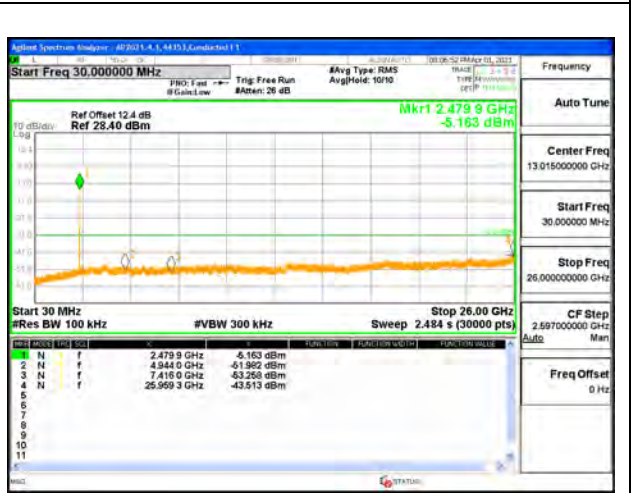

OUT-OF-BAND HIGH CHANNEL 13

1TX ANT 4 MODE, SU Tones



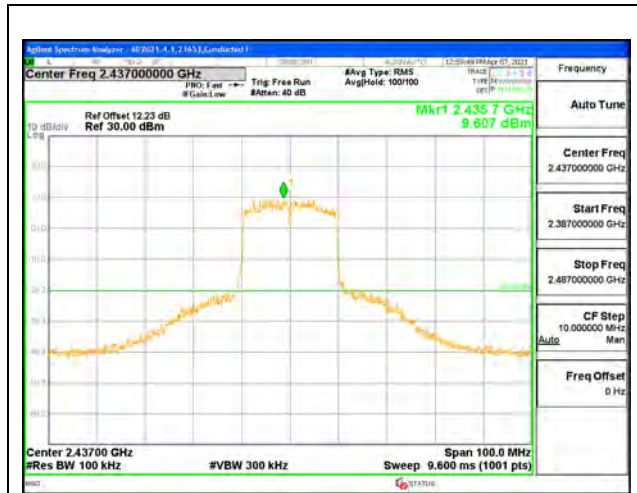

MID CHANNEL 6 BANDEDGE



OUT-OF-BAND MID CHANNEL 6



HIGH CHANNEL 9 BANDEDGE



OUT-OF-BAND HIGH CHANNEL 9



HIGH CHANNEL 10 BANDEDGE



OUT-OF-BAND HIGH CHANNEL 10



HIGH CHANNEL 11 BANDEDGE



OUT-OF-BAND HIGH CHANNEL 11



HIGH CHANNEL 12 BANDEDGE



OUT-OF-BAND HIGH CHANNEL 12



HIGH CHANNEL 13 BANDEDGE



OUT-OF-BAND HIGH CHANNEL 13

1TX ANT 3 MODE, 26-Tone RU Index 0

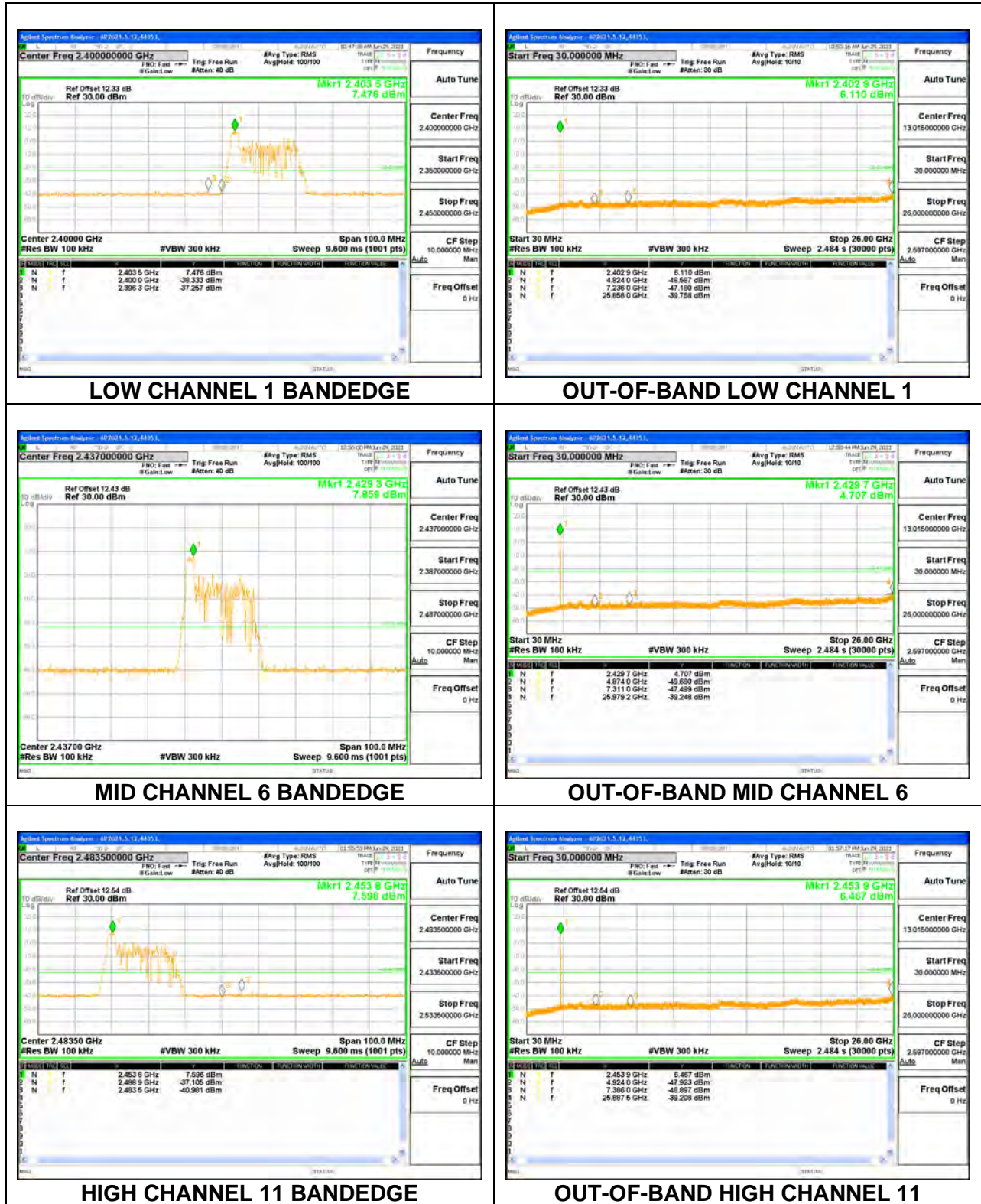



HIGH CHANNEL 12 BANDEDGE



OUT-OF-BAND HIGH CHANNEL 12



HIGH CHANNEL 13 BANDEDGE



OUT-OF-BAND HIGH CHANNEL 13

1TX ANT 3 MODE, 26-Tone RU Index 4



LOW CHANNEL 1 BANDEDGE



OUT-OF-BAND LOW CHANNEL 1

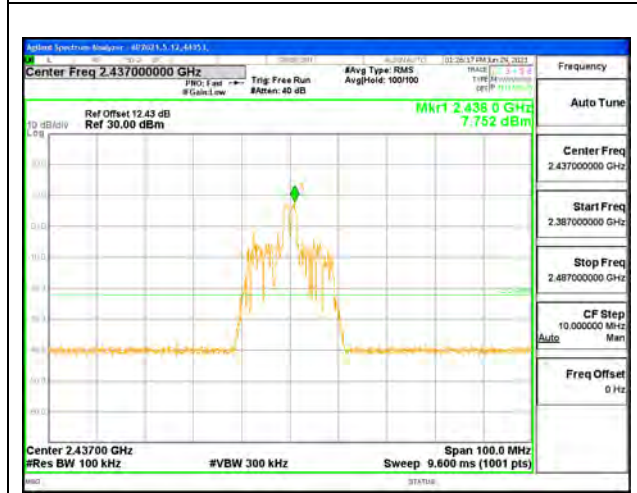

MID CHANNEL 6 BANDEDGE



OUT-OF-BAND MID CHANNEL 6



HIGH CHANNEL 11 BANDEDGE



OUT-OF-BAND HIGH CHANNEL 11



HIGH CHANNEL 12 BANDEDGE



OUT-OF-BAND HIGH CHANNEL 12



HIGH CHANNEL 13 BANDEDGE



OUT-OF-BAND HIGH CHANNEL 13

1TX ANT 3 MODE, 26-Tone RU Index 8



LOW CHANNEL 1 BANDEDGE



OUT-OF-BAND LOW CHANNEL 1

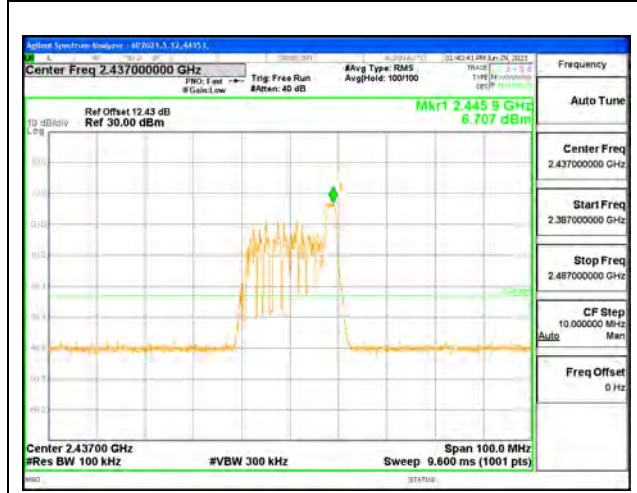

MID CHANNEL 6 BANDEDGE



OUT-OF-BAND MID CHANNEL 6



HIGH CHANNEL 11 BANDEDGE



OUT-OF-BAND HIGH CHANNEL 11



HIGH CHANNEL 12 BANDEDGE



OUT-OF-BAND HIGH CHANNEL 12



HIGH CHANNEL 13 BANDEDGE



OUT-OF-BAND HIGH CHANNEL 13

1TX ANT 3 MODE, SU Tones

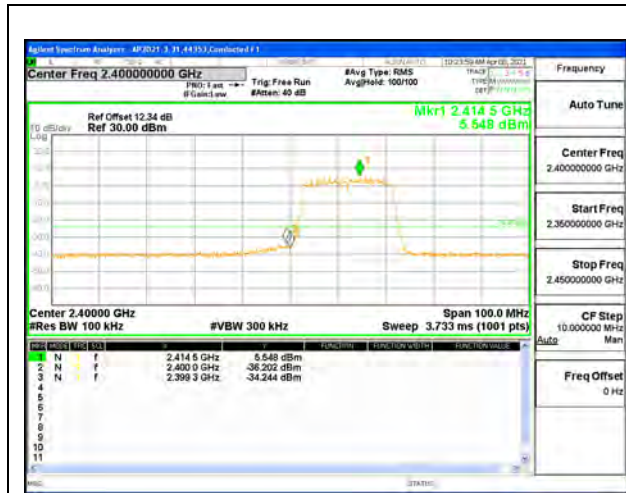

LOW CHANNEL 1 BANDEDGE



OUT-OF-BAND LOW CHANNEL 1



LOW CHANNEL 2 BANDEDGE



OUT-OF-BAND LOW CHANNEL 2



LOW CHANNEL 3 BANDEDGE



OUT-OF-BAND LOW CHANNEL 3

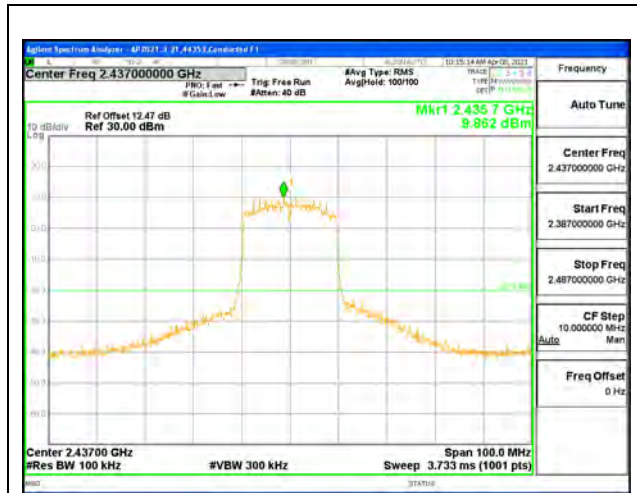

MID CHANNEL 6 BANDEDGE



OUT-OF-BAND MID CHANNEL 6



HIGH CHANNEL 9 BANDEDGE



OUT-OF-BAND HIGH CHANNEL 9



HIGH CHANNEL 10 BANDEDGE



OUT-OF-BAND HIGH CHANNEL 10



HIGH CHANNEL 11 BANDEDGE



OUT-OF-BAND HIGH CHANNEL 11



HIGH CHANNEL 12 BANDEDGE



OUT-OF-BAND HIGH CHANNEL 12



HIGH CHANNEL 13 BANDEDGE



OUT-OF-BAND HIGH CHANNEL 13

9.6.5. 802.11ax HE20 OFDMA MODE 2TX

ANT 4 + ANT 3 2TX MODE, 26-Tones, RU Index 0



LOW CHANNEL 1 BANDEDGE ANT 4



OUT-OF-BAND LOW CHANNEL 1 ANT 4



MID CHANNEL 6 BANDEDGE ANT 4



OUT-OF-BAND MID CHANNEL 6 ANT 4



HIGH CHANNEL 11 BANDEDGE ANT 4

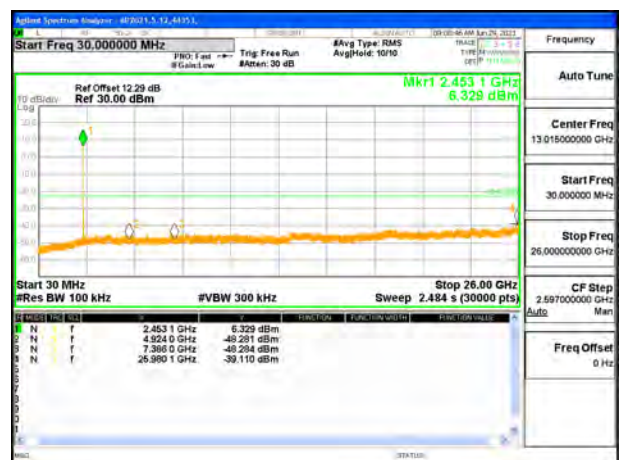

OUT-OF-BAND HIGH CHANNEL 11 ANT 4



HIGH CHANNEL 12 BANDEDGE ANT 4



OUT-OF-BAND HIGH CHANNEL 12 ANT 4



HIGH CHANNEL 13 BANDEDGE ANT 4



OUT-OF-BAND HIGH CHANNEL 13 ANT 4



LOW CHANNEL 1 BANDEDGE ANT 3



OUT-OF-BAND LOW CHANNEL 1 ANT 3

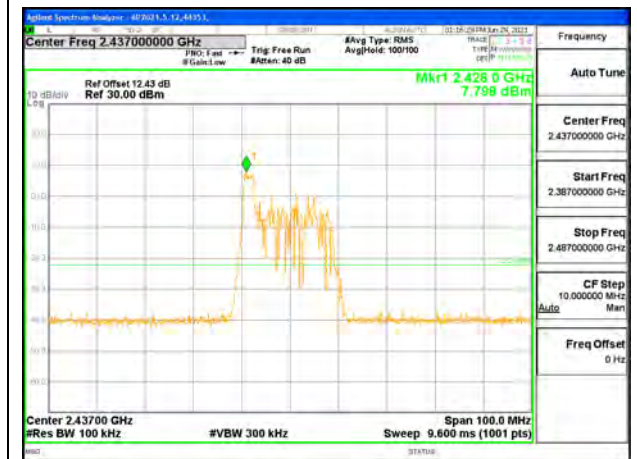

MID CHANNEL 6 BANDEDGE ANT 3



OUT-OF-BAND MID CHANNEL 6 ANT 3



HIGH CHANNEL 11 BANDEDGE ANT 3



OUT-OF-BAND HIGH CHANNEL 11 ANT 3



HIGH CHANNEL 12 BANDEDGE ANT 3

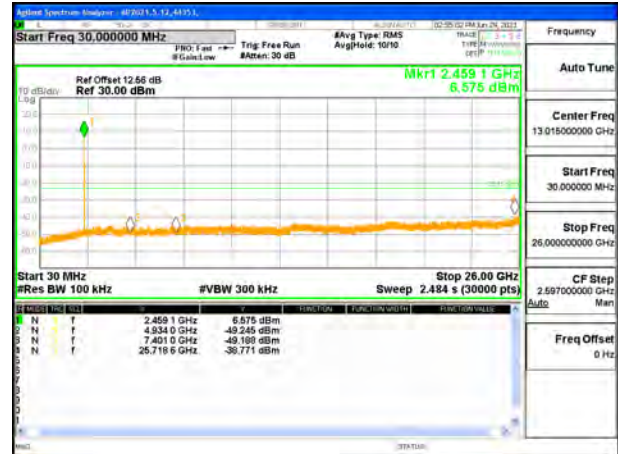

OUT-OF-BAND HIGH CHANNEL 12 ANT 3



HIGH CHANNEL 13 BANDEDGE ANT 3



OUT-OF-BAND HIGH CHANNEL 13 ANT 3