



**Part 2: Test Under Dynamic Transmission Condition**

*For*  
**SMARTPHONE**

**FCC ID: BCG-E4003A**  
**Model Name: A2484**

**Report Number: 13573771-S4V2**  
**Issue Date: 8/5/2021**

*Prepared for*  
**APPLE INC.**  
**1 APPLE PARK WAY**  
**CUPERTINO, CA 95014-2084**

*Prepared by*  
**UL VERIFICATION SERVICES INC.**  
**47173 BENICIA STREET**  
**FREMONT, CA 94538, U.S.A.**  
**TEL: (510) 319-4000**  
**FAX: (510) 661-0888**



**Revision History**

| Rev. | Date     | Revisions  | Revised By |
|------|----------|--|------------|
| V1   | 8/2/2021 | Initial Issue  | --         |
| V2   | 8/2/2021 | 1. Removed the blank page.<br>2. Updated Equation 3a in §3.4 |            |
|      |          |  |            |
|      |          |  |            |

## Table of Contents

|           |   |           |
|-----------|---|-----------|
| <b>1.</b> | <b>Introduction .....</b>   | <b>5</b>  |
| <b>2.</b> | <b>Varying Transmission Test Cases and Test Proposal .....</b>                            | <b>5</b>  |
| <b>3.</b> | <b>SAR Time Averaging Validation Test Procedures .....</b>                                | <b>7</b>  |
| 3.1.      | Test Sequence Determination for Validation .....  | 7         |
| 3.2.      | Test Configuration Selection Criteria for Validating Smart Transmit Feature .....         | 7         |
| 3.2.1.    | Test Configuration Selection for Time-varying Transmission Power .....                    | 7         |
| 3.2.2.    | Test Configuration Selection for Change in Call .....                                     | 8         |
| 3.2.3.    | Test Configuration Selection for Change in Technology/Band .....                          | 8         |
| 3.2.4.    | Test Configuration Selection for Change in Antenna .....                                  | 8         |
| 3.2.5.    | Test Configuration Selection for Change in DSI .....                                      | 9         |
| 3.2.6.    | Test Configuration Selection for Change in Time Window .....                              | 9         |
| 3.2.7.    | Test Configuration Selection for SAR Exposure Switching .....                             | 9         |
| 3.3.      | Test Procedures for Conducted Power Measurements .....                                    | 10        |
| 3.3.1.    | Time-varying Transmission Power Scenario .....  | 10        |
| 3.3.2.    | Change in Call Scenario .....   | 11        |
| 3.3.3.    | Change in Technology and Band .....   | 12        |
| 3.3.4.    | Change in Antenna .....   | 13        |
| 3.3.5.    | Change in DSI .....   | 13        |
| 3.3.6.    | Change in Time Window .....   | 13        |
| 3.3.7.    | SAR Exposure Switching .....  | 14        |
| 3.4.      | Test Procedure for Time-varying SAR Measurements .....                                    | 15        |
| <b>4.</b> | <b>PD Time Averaging Validation Test Procedures .....</b>                                 | <b>16</b> |
| 4.1.      | Test Sequence for Validation in mmW NR Transmission .....                                 | 16        |
| 4.2.      | Test Configuration Selection Criteria for Validating Smart Transmit Feature .....         | 16        |
| 4.2.1.    | Test Configuration Selection for Time-varying Transmission Power .....                    | 16        |
| 4.2.2.    | Test Configuration Selection for Change in Antenna Configuration (Beam) .....             | 16        |
| 4.2.3.    | Test Configuration Selection for SAR versus PD Exposure Switch during Transmission .....  | 16        |
| 4.3.      | Test Procedures for mmW Radiated Power Measurements .....                                 | 16        |
| 4.3.1.    | Time-varying Transmission Power Scenario .....  | 16        |
| 4.3.2.    | Switch in SAR vs. PD Exposure during Transmission .....                                   | 18        |
| 4.3.3.    | Change in Antenna Configuration (Beam) .....  | 19        |
| 4.4.      | Test Procedure for Time-varying PD Measurements .....                                     | 20        |
| <b>5.</b> | <b>Test Configurations .....</b>  | <b>22</b> |
| 5.1.      | WWAN (Sub-6 GHz) Transmission .....   | 22        |
| 5.2.      | LTE + mmW NR Transmission .....   | 25        |
| <b>6.</b> | <b>Conducted Power Test Results for Sub-6 GHz Smart Transmit Feature Validation .....</b> | <b>26</b> |
| 6.1.      | Measurement Setup .....   | 26        |
| 6.2.      | $P_{limit}$ and $P_{max}$ Measurement Results .....                                       | 28        |
| 6.3.      | Time-varying Transmission Power Measurement Results .....                                 | 29        |
| 6.3.1.    | GPRS PCS Antenna 2 (Test case 1 in Table 5-2) .....                                       | 30        |
| 6.3.2.    | GPRS PCS Antenna 1 (Test case 2 in Table 5-2) .....                                       | 31        |
| 6.3.3.    | W-CDMA Band IV Antenna 1 (Test Case 3 in Table 5-2) .....                                 | 32        |
| 6.3.4.    | W-CDMA Band IV Antenna 3 (Test Case 4 in Table 5-2) .....                                 | 33        |
| 6.3.5.    | CDMA BC1 Antenna 2 (Test Case 5 in Table 5-2) .....                                       | 34        |
| 6.3.6.    | CDMA BC1 Antenna 1 (Test Case 6 in Table 5-2) .....                                       | 35        |

- 6.3.7. LTE Band 66 Antenna 1 (Test Case 7 in Table 5-2).....36
- 6.3.8. LTE Band 25 Antenna 1 (Test Case 8 in Table 5-2).....37
- 6.3.9. NR Band n66 Antenna 1 (Test Case 9 in Table 5-2) .....38
- 6.3.10. NR Band n25 Antenna 1 (Test Case 10 in Table 5-2) .....39
- 6.4. Change in Call Test Results (Test Case 11 in Table 5-2) .....40
- 6.5. Change in Technology/Band Test Results (Test Case 12 in Table 5-2) .....41
- 6.6. Change in DSI Test Results (Test Case 13 in Table 5-2) .....42
- 6.7. Change in Time Window/Antenna Switch Test Results (Test Case 14 in Table 5-2) .....43
  - 6.7.1. Transition from LTE 48 to LTE 66 (i.e., 60 seconds to 100 seconds), then Back to LTE 48.....43
- 6.8. Switch in SAR Exposure Test Results .....44
  - 6.8.1. Test Case 1: EN-DC Switch between LTE 66 and NR n25 (Test Case 15 in Table 5-2).....44
  - 6.8.2. Test Case 2: Uplink CA Switch between LTE 5 Antenna 2 and LTE 66 Antenna 1 (Test Case 16 in Table 5-2).....45
- 7. SAR Test Results for Sub-6 GHz Smart Transmit Feature Validation .....46**
- 8. Radiated Power Test Results for mmW Smart Transmit Feature Validation .....47**
  - 8.1. Measurement Setup.....47
  - 8.2. mmW NR Radiated Power Test Results.....48
    - 8.2.1. Maximum Transmission Power Test Results for n258 .....49
    - 8.2.2. Maximum Transmission Power Test Results for n260 .....50
    - 8.2.3. Switch in SAR vs. PD Exposure Test Results for n258 .....51
    - 8.2.4. Switch in SAR vs. PD Exposure Test Results for n260 .....52
    - 8.2.5. Change in Beam Test Results for n258 .....53
    - 8.2.6. Change in Beam Test Results for n260 .....54
- 9. PD Test Results for mmW Smart Transmit Feature Validation .....55**
- 10. Conclusions.....56**
- Appendices.....57**
  - A Test Sequences .....57
  - B Test Procedures for Sub-6 GHz NR + Sub-6 GHz Radio.....59
    - B.1 Time-varying Transmission Power Test for Sub-6 GHz NR in NSA Mode.....59
    - B.2 Switch in SAR Exposure Between Sub-6 GHz vs. Sub-6 GHz NR during Transmission.....59
  - C Test Setup Photos .....60

**Figures**

- Figure 3-1: 100 seconds running average illustration.....10
- Figure 6-1a – 6-1c: Conducted power measurement setup .....27
- Figure 8-1: mmW NR radiated power measurement setup (see Appendix E for missing figures) .....47
- Figure A-1: Test Sequence 1 waveform .....57
- Figure A-2: Test Sequence 2 waveform .....58

**Tables**

- Table 5-1:  $P_{limit}$  for supported technologies and bands ( $P_{limit}$  in EFS file) .....23
- Table 5-2: Radio configurations selected for Part 2.....24
- Table 5-3: Selections for LTE + mmW NR validation measurements .....25
- Table 5-4: Test configuration for LTE + mmW NR validation .....25
- Table 6-1: Measured  $P_{limit}$  and  $P_{max}$  of selected radio configurations .....28
- Table 8-1: Worst-case 1g SAR, 4 cm<sup>2</sup> average PD and EIRP measured at *input.power.limit* for the selected configurations.....48
- Table A-1: Test Sequence 2 .....58

## 1. Introduction

The equipment under test (EUT) contains the Qualcomm SDX-60M modem supporting 2G/3G/4G/5G technologies as well as supporting mmW 5G NR bands. Both WWAN modems are enabled with Qualcomm's Smart Transmit feature with algorithms to control and manage transmitting power in real time and to ensure the time-averaged RF exposure from the WWAN modems are always in compliance with FCC requirements.

In addition to these WWAN modems, the EUT contains a different modem to support WLAN.

The purpose of this Part 2 report is to demonstrate that the EUT complies with the FCC RF exposure requirement under varying transmission scenarios, thereby validating the Qualcomm Smart Transmit feature.

The  $P_{limit}$  and *input.power.limit* used in this report are determined and listed in the Part 0 and Part 1 reports.

Refer to Compliance Summary report for product description and terminology used in this report.

## 2. Varying Transmission Test Cases and Test Proposal

To validate time averaging feature and demonstrate the compliance in varying transmission conditions, the following transmission scenarios are covered in Part 2 tests:

1. During a time-varying Tx power transmission: Prove that the Smart Transmit feature accounts for Tx power variations in time accurately.
2. During a call disconnect and re-establish scenario: Prove that the Smart Transmit feature accounts for history of past Tx power transmissions accurately.
3. During technology/band handover: Prove that the Smart Transmit feature functions correctly during transitions in technology/band.
4. During DSI (Device State Index) change: Prove that the Smart Transmit feature functions correctly during transition from one DSI to another.
5. During antenna (or beam) switch: Prove that the Smart Transmit feature functions correctly during transitions in antenna (such as AsDiv scenario) or beams (different antenna array configurations).
6. SAR vs. PD exposure switching during Sub-6 + mmW transmission: Prove that the Smart Transmit feature functions correctly and ensures total RF exposure compliance during transitions in SAR dominant exposure, SAR + PD exposure, and PD dominant exposure scenarios.
7. During time window switch: Prove that the Smart Transmit feature correctly handles the transition from one time window to another specified by FCC while maintaining the normalized time-averaged RF exposure to be less than the design limit of 1.0 W/kg at all times.
8. SAR exposure switching between two active radios (*radio1* and *radio2*): Prove that the Smart Transmit feature functions correctly and ensures total RF exposure compliance when exposure varies among *SAR\_radio1* only, *SAR\_radio1* + *SAR\_radio2*, and *SAR\_radio2* only scenarios.

As described in the Part 0 report, the RF exposure is proportional to the transmission power for a SAR- and PD-characterized wireless device. Thus, feature validation in Part 2 can be effectively performed through conducted (for  $f < 6\text{GHz}$ ) and radiated (for  $f \geq 6\text{GHz}$ ) power measurement. Therefore, the compliance demonstration under dynamic transmission conditions and feature validation are done in conducted/radiated power measurement setups for transmission scenarios 1 through 8.

To add confidence in the feature validation, the time-averaged SAR and PD measurements are also performed but only performed for transmission scenario 1 to avoid the complexity in SAR and PD measurement (such as, for scenario 3, requiring change in SAR probe calibration file to accommodate different bands and/or tissue simulating liquid).

The strategy for testing in varying transmission conditions are outlined as follows:

- Demonstrate the total RF exposure averaged over FCC's defined time windows do not exceed FCC's SAR and PD limits through time-averaged power measurements.
  - Measure conducted Tx power (for  $f < 6\text{GHz}$ ) versus time, and radiated Tx power (EIRP for  $f > 10\text{GHz}$ ) versus time.
  - Convert the conducted Tx power into RF exposure and divide by the respective FCC limits to get the normalized exposure versus time.

- Perform the running time-averaging over the FCC's defined time windows.
- Demonstrate that the total normalized time-averaged RF exposure is less than 1 W/kg for all transmission scenarios (i.e., transmission scenarios 1 through 8), always.

Mathematical expression:

- For Sub-6 GHz transmission scenarios only:

$$1g \text{ or } 10g \text{ SAR}(t) = \frac{\text{conducted Tx power}(t)}{\text{conducted Tx power } P_{limit}} * 1g \text{ or } 10g \text{ SAR } P_{limit} \text{ (1a)}$$

$$\frac{\frac{1}{T_{SAR}} \int_{t-T_{SAR}}^t 1g \text{ or } 10g \text{ SAR}(t) dt}{FCC \text{ SAR limit}} \leq 1 \text{ (1b)}$$

- For Sub-6 GHz + mmW transmission:

$$1g \text{ or } 10g \text{ SAR}(t) = \frac{\text{conducted Tx power}(t)}{\text{conducted Tx power } P_{limit}} * 1g \text{ or } 10g \text{ SAR } P_{limit} \text{ (2a)}$$

$$4 \text{ cm}^2 \text{ PD}(t) = \frac{\text{radiated Tx power}(t)}{\text{radiated Tx power input.power.limit}} * 4 \text{ cm}^2 \text{ PD input.power.limit} \text{ (2b)}$$

$$\frac{\frac{1}{T_{SAR}} \int_{t-T_{SAR}}^t 1g \text{ or } 10g \text{ SAR}(t) dt}{FCC \text{ SAR limit}} + \frac{\frac{1}{T_{PD}} \int_{t-T_{PD}}^t 4 \text{ cm}^2 \text{ PD}(t) dt}{FCC 4 \text{ cm}^2 \text{ PD limit}} \leq 1 \text{ (2c)}$$

where, *conducted Tx power(t)*, *conducted Tx power P<sub>limit</sub>*, and *1gSAR P<sub>limit</sub>* correspond to the measured instantaneous conducted Tx power, measured conducted Tx power at P<sub>limit</sub>, and measured 1g SAR values at P<sub>limit</sub> corresponding to Sub-6 GHz transmission. Similarly, *radiated Tx power(t)*, *radiated Tx power input.power.limit*, and *4 cm<sup>2</sup> PD input.power.limit* correspond to the measured instantaneous radiated Tx power, radiated Tx power at *input.power.limit* (i.e., radiated power limit), and 4 cm<sup>2</sup> PD value at *input.power.limit* corresponding to mmW transmission. Both P<sub>limit</sub> and *input.power.limit* are the parameters pre-defined in Part 0 and loaded via *Embedded File System* (EFS) onto the EUT. T<sub>SAR</sub> is the FCC defined time window for Sub-6 GHz radio; T<sub>PD</sub> is the FCC defined time window for mmW radio.

- Demonstrate the total RF exposure averaged over FCC's defined time windows do not exceed FCC's SAR and PD limits through time-averaged SAR and PD measurements. Note, as mentioned earlier, this measurement is performed for transmission scenario 1 only.
  - For Sub-6 GHz transmission only: Measure instantaneous SAR versus time; for LTE + Sub-6 GHz NR transmission: Request low power (or all-down bits) on LTE so that measured SAR predominantly corresponds to Sub-6 GHz NR.
  - For LTE + mmW transmission: Measure instantaneous E-field versus time for mmW radio and instantaneous conducted power versus time for the LTE radio.
  - Convert the result into RF exposure and divide by the respective FCC limits to obtain the normalized exposure versus time.
  - Perform time averaging over FCC defined time window.
  - Demonstrate that the total normalized time-average RF exposure is less than 1 W/kg for transmission scenario 1, always.

Mathematical expression:

- For Sub-6 GHz transmission only:

$$1g \text{ or } 10g \text{ SAR}(t) = \frac{\text{pointSAR}(t)}{\text{pointSAR}(t) P_{limit}} * 1g \text{ or } 10g \text{ SAR}(t) P_{limit} \text{ (3a)}$$

$$\frac{\frac{1}{T_{SAR}} \int_{t-T_{SAR}}^t 1g \text{ or } 10g \text{ SAR}(t) dt}{FCC \text{ SAR limit}} \leq 1 \text{ (3b)}$$

- For LTE + mmW transmission:

$$1g \text{ or } 10g \text{ SAR}(t) = \frac{\text{conducted Tx power}(t)}{\text{conducted Tx power } P_{limit}} * 1g \text{ or } 10g \text{ SAR } P_{limit} \text{ (4a)}$$

$$4 \text{ cm}^2 \text{ PD}(t) = \frac{[\text{pointE}(t)]^2}{[\text{pointE input.power.limit}]^2} * 4 \text{ cm}^2 \text{ PD input.power.limit} \text{ (4b)}$$

$$\frac{\frac{1}{T_{SAR}} \int_{t-T_{SAR}}^t 1g \text{ or } 10g \text{ SAR}(t) dt}{FCC \text{ SAR limit}} + \frac{\frac{1}{T_{PD}} \int_{t-T_{PD}}^t 4 \text{ cm}^2 \text{ PD}(t) dt}{FCC 4 \text{ cm}^2 \text{ PD limit}} \leq 1 \text{ (4c)}$$

where,  $\text{pointSAR}(t)$ ,  $\text{pointSAR } P_{limit}$ , and  $1g\text{SAR } P_{limit}$  correspond to the measured instantaneous point SAR, measured point SAR at  $P_{limit}$ , and measured 1g SAR values at  $P_{limit}$  corresponding to Sub-6 GHz transmission. Similarly,  $\text{pointE}(t)$ ,  $\text{pointE input.power.limit}$ , and  $4 \text{ cm}^2 \text{ PD input.power.limit}$  correspond to the measured instantaneous E-field, E-field at  $\text{input.power.limit}$ , and  $4 \text{ cm}^2 \text{ PD}$  value at  $\text{input.power.limit}$  corresponding to mmW transmission.<sup>1</sup>

### 3. SAR Time Averaging Validation Test Procedures

This chapter provides the test plan and test procedures for validating Qualcomm Smart Transmit feature for Sub-6 GHz transmission. The 100 seconds time window for operating  $f < 3$  GHz is used as an example to detail the test procedures in this chapter. The same test plan and test procedures described in this chapter apply to 60 seconds time window for operating  $f \geq 3$ GHz.

#### 3.1. Test Sequence Determination for Validation

Following the FCC recommendation, two test sequences<sup>2</sup> having time-variation in Tx power are predefined for sub-6 GHz ( $f < 6$  GHz) validation:

- Test sequence 1: Request EUT's Tx power to be at maximum power, measured  $P_{max}$ , for 80s, then requesting for half of the maximum power, i.e., measured  $P_{max}/2$ , for the rest of the time.
- Test sequence 2: Request EUT's Tx power to vary with time. This sequence is generated relative to measured  $P_{max}$ , measured  $P_{limit}$  and calculated  $P_{reserve}$  (= measured  $P_{limit}$  in dBm – Reserve power margin in dB) of the EUT based on measured  $P_{limit}$ .

The details for generating these two test sequences is described and listed in Appendix A.

#### 3.2. Test Configuration Selection Criteria for Validating Smart Transmit Feature

For validating the Smart Transmit feature, this section provides a general guidance to select test cases. In practice, an adjustment can be made in test case selection. The justification/clarification may be provided.

##### 3.2.1. Test Configuration Selection for Time-varying Transmission Power

The Smart Transmit time averaging feature operation is independent of bands, modes, and channels for a given technology. Hence, validation of Smart Transmit in one band/mode/channel per technology is sufficient. Two bands per technology are proposed and selected for this testing to provide high confidence in this validation.

<sup>1</sup> cDASY6 measurement system by Schmid & Partner Engineering AG (SPEAG ) of Zurich, Switzerland measures relative E-field, and provides ratio of  $\frac{[\text{pointE}(t)]^2}{[\text{pointE input.power.limit}]^2}$  versus time.

<sup>2</sup> For test sequence generation, “measured  $P_{limit}$ ” and “measured  $P_{max}$ ” are used instead of the “ $P_{limit}$ ” specified in EFS entry and “ $P_{max}$ ” specified for the device, because Smart Transmit feature operates against the actual power level of the “ $P_{limit}$ ” that was calibrated for the EUT. The “measured  $P_{limit}$ ” accurately reflects what the feature is referencing to, therefore, it should be used during feature validation testing. The RF tune-up and device-to-device variation are already considered in the Part 0 report prior to determining  $P_{limit}$ .

The criteria for the selection are based on the  $P_{limit}$  values determined in the Part 0 report. Select two bands<sup>3</sup> in each supported technology that correspond to approximately the least<sup>4</sup> and highest<sup>5</sup>  $P_{limit}$  values that are less than  $P_{max}$  based on pre-testing for validating Smart Transmit.

### 3.2.2. Test Configuration Selection for Change in Call

The criteria to select a test configuration for call-drop measurement is:

- Select the technology/band with the least  $P_{limit}$  among all supported technologies/bands and select the radio configuration (e.g., # of RBs, channel#) in this technology/band that corresponds to the highest measured 1g SAR at  $P_{limit}$  listed in the Part 1 report.
- In case of multiple bands having the same least  $P_{limit}$ , select the band having the highest measured 1g SAR at  $P_{limit}$  in the Part 1 report.

This test is performed with the EUT's Tx power requested to be at maximum power, the above band selection will result in Tx power enforcement (i.e., EUT forced to have Tx power at  $P_{reserve}$ ) for its longest duration in one FCC defined time window. The call change (call drop/reestablish) is performed during the Tx power enforcement duration (i.e., during the time when EUT is forced to have Tx power at  $P_{reserve}$ ). One test is sufficient as the feature operation is independent of technology and band.

### 3.2.3. Test Configuration Selection for Change in Technology/Band

The selection criteria for this measurement is, for a given antenna, to have the EUT switch from a technology/band with the lowest  $P_{limit}$  within the technology group (in case of multiple bands having the same  $P_{limit}$ , then select the band with highest measured 1g SAR at  $P_{limit}$ ) to a technology/band with the highest  $P_{limit}$  within the technology group (in case of multiple bands having the same  $P_{limit}$ , then select the band with lowest measured 1g SAR at  $P_{limit}$  in the Part 1 report, or vice versa).

This test is performed with the EUT's Tx power requested to be at maximum power, the technology/band switch is performed during Tx power enforcement duration (i.e., during the time when EUT is forced to have Tx power at  $P_{reserve}$ ).

### 3.2.4. Test Configuration Selection for Change in Antenna

The criteria to select a test configuration for antenna switch measurement is:

- Whenever possible, and supported by the EUT, first select an antenna switch configuration within the same technology/band (i.e., same technology and band combination).
- Select any technology/band that supports multiple Tx antennas, and has the highest difference in  $P_{limit}$  among all supported antennas.
- In case of multiple bands having the same difference in  $P_{limit}$  among supported antennas, select the band having the highest measured 1g SAR at  $P_{limit}$  in the Part 1 report.

This test is performed with the EUT's Tx power requested to be at maximum power in a selected technology/band and antenna change is conducted during Tx power enforcement duration (i.e., during the time when EUT is forced to have Tx power at Preserve).

---

<sup>3</sup> If one  $P_{limit}$  level applies to all the bands within a technology, then only one band needs to be tested. In this case, within the bands having the same  $P_{limit}$ , the radio configuration (e.g., # of RBs, channel#) and device position that correspond to the highest measured 1g SAR at  $P_{limit}$  shown in the Part 1 report is selected.

<sup>4</sup> In case of multiple bands having the same least  $P_{limit}$  within the technology, then select the band having the highest measured 1g SAR at  $P_{limit}$ .

<sup>5</sup> The band having a higher  $P_{limit}$  needs to be properly selected so that the power limiting enforced by Smart Transmit can be validated using the pre-defined test sequences. If the highest  $P_{limit}$  in a technology is too high where the power limiting enforcement is not needed when testing with the pre-defined test sequences, then the next highest level is checked. This process is continued within the technology until the second band for validation testing is determined.



### 3.2.5. Test Configuration Selection for Change in DSI

The criteria to select a test configuration for DSI change is:

- Select a technology/band having the  $P_{limit} < P_{max}$  within any technology and DSI group and for the same technology/band having a different  $P_{limit}$  in any other DSI group. Note that the selected DSI transition needs to be supported by the device.

This test is performed with the EUT's Tx power requested to be at maximum power in selected technology/band, and DSI change is conducted during Tx power enforcement duration (i.e., during the time when EUT is forced to have Tx power at  $P_{reserve}$ ).

### 3.2.6. Test Configuration Selection for Change in Time Window

The FCC specifies different time windows for time averaging based on operation frequency. The criteria to select a test configuration for validating the Smart Transmit feature and demonstrating the compliance during the change in time window is:

- Select any technology/band that has an operation frequency classified in one time window defined by the FCC (such as 100-seconds time window) and its corresponding  $P_{limit}$  is less than  $P_{max}$  if possible.
- Select the second technology/band that has an operation frequency classified in a different time window defined by the FCC (such as 60-seconds time window) and its corresponding  $P_{limit}$  is less than  $P_{max}$  if possible.
- Note it is preferred both  $P_{limit}$  values of two selected technologies/bands are less than the corresponding  $P_{max}$ ; if this is not possible, at least one of technologies/bands has its  $P_{limit}$  less than  $P_{max}$ .

This test is performed with the EUT's Tx power requested to be at maximum power in selected technology/band. Test for one pair of time windows selected is sufficient as the feature operation is the same.

### 3.2.7. Test Configuration Selection for SAR Exposure Switching

If supported, the test configuration for SAR exposure switching should cover:

1. SAR exposure switch when two active radios are in the same time window.
2. SAR exposure switch when two active radios are in different time windows. One test with two active radios in any two different time windows is sufficient as the Smart Transmit operation is the same for RF exposure switch in any combination of two different time windows. For devices supporting LTE + mmW NR, this test is covered in §9.2.3 and §9.2.4.

The Smart Transmit time averaging operation is independent of the source of SAR exposure (for example, LTE vs. Sub-6 GHz NR) and ensures total time-averaged RF exposure compliance. Hence, validation of Smart Transmit in any one simultaneous SAR transmission scenario (i.e., one combination for LTE + Sub-6 GHz NR transmission) is sufficient, where the SAR exposure varies among  $SAR_{radio1}$  only,  $SAR_{radio1} + SAR_{radio2}$ , and  $SAR_{radio2}$  only scenarios.

The criteria to select a test configuration for validating the Smart Transmit feature during SAR exposure switching scenario is:

- Select any two < 6 GHz technologies/bands that the EUT supports simultaneous transmission (for example, LTE + Sub-6 GHz NR).
- Among all supported simultaneous transmission configurations, the selection order is:
  1. Select one configuration where both  $P_{limit}$  of radio1 and radio2 is less than their corresponding  $P_{max}$ , preferable with different  $P_{limits}$ . If this configuration is not available, then
  2. Select one configuration that has  $P_{limit}$  less than its  $P_{max}$  for at least one radio. If this cannot be found, then
  3. Select one configuration that has  $P_{limit}$  of radio1 and radio2 greater than  $P_{max}$ , but with the least delta between the two ( $P_{limit} - P_{max}$ ).

Test for one simultaneous transmission scenario is sufficient as the feature operation is the same.

### 3.3. Test Procedures for Conducted Power Measurements

This section provides general conducted power measurement procedures to perform compliance test under dynamic transmission scenarios described in §2. In practice, an adjustment can be made in these procedures. The justification/clarification may be provided.

#### 3.3.1. Time-varying Transmission Power Scenario

This test is performed with the two pre-defined test sequences described in §3.1 for all the technologies and bands selected in §3.2.1. The purpose of the test is to demonstrate the effectiveness of power limiting enforcement and that the time-averaged SAR (corresponding time-averaged Tx power) does not exceed the FCC limit at all times (see Eq. (1a) and (1b)).

##### Test Procedure:

1. Measure  $P_{max}$ , measure  $P_{limit}$ , and calculate  $P_{reserve}$  (= measured  $P_{limit}$  in dBm – Reserve\_power\_margin in dB) and follow §3.1 to generate the test sequences for all the technologies and bands selected in §3.2.1. Both test sequence 1 and test sequence 2 are created based on measured  $P_{max}$  and measured  $P_{limit}$  of the EUT. Test conditions to measure  $P_{max}$  and  $P_{limit}$  are:
  - a. Measure  $P_{max}$  with Smart Transmit **disabled** and the callbox set to request maximum power.
  - b. Measure  $P_{limit}$  with Smart Transmit **enabled**, Reserve\_power\_margin set to 0 dB, and the callbox set to request maximum power.
2. Set Reserve\_power\_margin to actual (intended) value (3 dB for this EUT based on the Part 1 report) and reset power on EUT to enable Smart Transmit, establish a radio link in the desired radio configuration, with callbox requesting the EUT’s Tx power to be at a pre-defined test sequence 1, measure and record Tx power versus time and then convert the conducted Tx power into 1g SAR value (see Eq. (1a)<sup>6</sup>) using measured  $P_{limit}$  from Step 1. Perform a running time average<sup>7</sup> to determine time-averaged power and 1g SAR versus time, as illustrated in Figure 3-1 where using 100-seconds time window as an example.

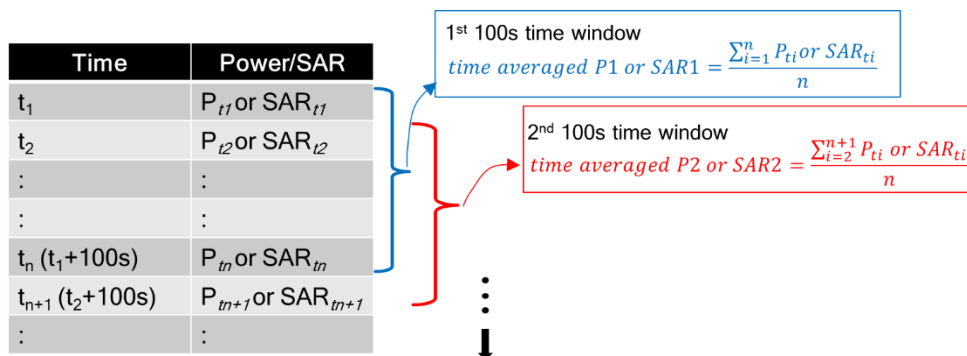

Figure 3-1: 100 seconds running average illustration

3. Make one plot containing:
  - a. Instantaneous Tx power versus time measured in Step 2.
  - b. Requested Tx power used in Step 2 (test sequence 1).
  - c. Computed time-average power versus time determined in Step 2.
  - d. Time-averaged power limit (corresponding to FCC SAR limit of 1.6 W/kg for 1g SAR) given by:

$$Time\ averaged\ power\ limit = meas.P_{limit} + 10 * \log\left(\frac{FCC\ SAR\ limit}{meas.SAR\ P_{limit}}\right) \quad (5a)$$

where  $meas.P_{limit}$  and  $meas.SAR\ P_{limit}$  corresponds to measured power at  $P_{limit}$  and measured SAR at  $P_{limit}$ .

<sup>6</sup> In Eq.(1a), instantaneous Tx power is converted into instantaneous 1g SAR value by applying the measured worst-case 1g SAR value at  $P_{limit}$  for the corresponding technology/band/antenna/DSI reported in the Part 1 report.

<sup>7</sup> For an easier computation of the running time average, 0 dBm can be added at the beginning of the test sequences. The length of the responding time window, for example, add 0dBm for 100-seconds so the running time average can be directly performed starting with the first 100-seconds data using excel spreadsheet. This technique applies to all tests performed in this Part 2 report for easier time-averaged computation using excel spreadsheet.

4. Make another plot containing:
  - a. Computed time-averaged 1g SAR versus time determined in Step 2.
  - b. FCC 1g SAR<sub>limit</sub> of 1.6 W/kg.
5. Repeat Steps 2 through 4 for pre-defined test sequence 2 and replace the requested Tx power (test sequence 1) in Step 2 with test sequence 2.
6. Repeat Steps 2 through 5 for all the selected technologies and bands.

The validation criteria are, at all times, the time-averaged power versus time, shown in Step 3's plot, where the result shall not exceed the time-averaged power limit (defined in Eq. (5a)); in turn, the time-averaged 1g SAR versus time, shown in Step 4's plot, shall not exceed the FCC limit of 1.6 W/kg for 1g SAR (i.e., Eq. (1b)).

### 3.3.2. Change in Call Scenario

This test is to demonstrate that the Smart Transmit feature accurately accounts for the past transmission powers during time-averaging when a new call is established.

The call disconnection and re-establishment need to be performed during power limit enforcement, i.e., when the EUT's transmission power is at  $P_{reserve}$  level, to demonstrate the continuity of RF exposure management and limiting in call change scenario. In other words, the RF exposure averaged over any FCC defined time window (including the time windows containing the call change) does not exceed the FCC limit of 1.6 W/kg for 1g SAR.

#### Test Procedure

1. Measure  $P_{limit}$  for the technology/band selected in §3.2.2. Measure  $P_{limit}$  with Smart Transmit enabled and Reserve\_power\_margin set to 0 dB, and the callbox set to request maximum power.
2. Set Reserve\_power\_margin to actual (intended) value and reset power on EUT to enable Smart Transmit.
3. Establish radio link with callbox in the selected technology/band.
4. Request EUT's transmission power at 0 dBm for at least one-time window specified for the selected technology/band, followed by requesting EUT's transmission power to be at maximum power for about ~60 seconds, and then drop the call for ~10 seconds. Afterwards, re-establish another call in the same radio configuration (i.e., same technology/band/channel) and continue callbox requesting EUT's transmission power to be at maximum power for the remaining time of at least another full duration of the specified time window. Measure and record the transmission power versus time. Once the measurement is done, extract instantaneous transmission power versus time, convert the measured conducted transmission power into 1g SAR values using Eq. (1a), and then perform the running time average to determine time-averaged power and 1g SAR versus time.<sup>8</sup>
5. Make one plot containing: (a) Instantaneous Tx power versus time, (b) requested power, (c) computed time-averaged power, (d) time-averaged power limit calculated using Eq.(5a).
6. Make another plot containing: (a) Computed time-averaged 1g SAR versus time, and (b) FCC limit of 1.6 W/kg for 1g SAR.

The time-averaged power versus time shall not exceed the time-averaged power limit (defined in Eq.(5a)) and, in turn, the time-averaged 1g SAR versus time shall not exceed the FCC limit of 1.6 W/kg for 1g SAR (i.e., Eq. (1b)).

<sup>8</sup> In Eq.(1a), the instantaneous transmission power is converted into instantaneous 1g SAR value by applying the measured worst-case 1g SAR value at  $P_{limit}$  for the corresponding technology/band/antenna/DSI reported in the Part 1 report.

### 3.3.3. Change in Technology and Band

This test is to demonstrate the correct power control by Smart Transmit during technology switches and/or band handovers.

Like the *Change in Call Scenario* test in §3.3.2, to validate the continuity of RF exposure limiting during the transition, the technology and band handover needs to be performed when EUT's transmission power is at  $P_{reserve}$  level (i.e., during transmission power enforcement) to make sure that the EUT's transmission power from previous  $P_{reserve}$  level to the new  $P_{reserve}$  level (corresponding to new technology/band). Since the  $P_{limit}$  could vary with technology and band, Eq. (1a) can be written as follows to convert the instantaneous transmission power in 1g SAR exposure for the two given radios, respectively:

$$1g \text{ or } 10g \text{ SAR}_1(t) = \frac{\text{conducted}_{Tx \text{ power } 1(t)}}{\text{conducted}_{Tx \text{ power } P_{limit 1}}} * 1g \text{ or } 10g \text{ SAR } P_{limit 1} \quad (6a)$$

$$1g \text{ or } 10g \text{ SAR}_2(t) = \frac{\text{conducted}_{Tx \text{ power } 2(t)}}{\text{conducted}_{Tx \text{ power } P_{limit 2}}} * 1g \text{ or } 10g \text{ SAR } P_{limit 2} \quad (6b)$$

$$\frac{1}{T_{SAR}} \left[ \int_{t-T_{SAR}}^{t_1} \frac{1g \text{ or } 10g \text{ SAR}_1(t)}{FCC \text{ SAR limit}} dt + \int_{t-T_{SAR}}^t \frac{1g \text{ or } 10g \text{ SAR}_2(t)}{FCC \text{ SAR limit}} dt \right] \leq 1 \quad (6c)$$

where,  $\text{conducted}_{Tx \text{ power } 1(t)}$ ,  $\text{conducted}_{Tx \text{ power } P_{limit 1}}$ , and  $1g \text{ SAR } P_{limit 1}$  correspond to the measured instantaneous conducted transmission power, measured conducted transmission power at  $P_{limit}$ , and measured 1g SAR value at  $P_{limit}$  of technology1/band1;  $\text{conducted}_{Tx \text{ power } 2(t)}$ ,  $\text{conducted}_{Tx \text{ power } P_{limit 2}}$ , and  $1g \text{ SAR } P_{limit 2}$  correspond to the measured instantaneous conducted transmission power, measured conducted transmission power at  $P_{limit}$ , and measured 1g SAR value at  $P_{limit}$  of technology2/band2. Transition from technology1/band1 to the technology2/band2 happens at time-instant ' $t1$ '.

#### Test Procedure

1. Measure  $P_{limit}$  for both the technologies and bands selected in §3.2.3. Measure the  $P_{limit}$  with Smart Transmit enabled and set *Reserve\_power\_margin* to 0 dB, and the callbox set to request maximum power.
2. Set *Reserve\_power\_margin* to actual (intended) value and reset power on the EUT to enable Smart Transmit.
3. Establish a radio link with the callbox in the first technology/band selected.
4. Request the EUT's transmission power to be 0 dBm for at least one-time window specified for the selected technology/band, followed by requesting the EUT's transmission power to be at maximum power for about ~60 seconds, and then switch to the second technology/band selected. Continue with the callbox requesting the EUT's transmission power to be at maximum power for the remaining time or, at least, for another full duration of the specified time window. Measure and record the transmission power versus time for the full duration of the test.
5. Once the measurement is done, extract the instantaneous transmission power versus time and convert the conducted transmission power into a 1g SAR value using Eq. (6a) and (6b) and corresponding measured  $P_{limit}$  values from Step 1 of this section. Perform the running time average to determine time-averaged power and 1g SAR versus time.<sup>9</sup>
6. Make one plot containing: (a) Instantaneous transmission power versus time, (b) requested power, (c) computed time-averaged power, (d) time-averaged power limit calculated using Eq.(5a).
7. Make another plot containing: (a) Computed time-averaged 1g SAR versus time, and (b) FCC limit of 1.6 W/kg for 1g SAR.

The time-averaged 1g SAR versus time shall not exceed the FCC limit of 1.6 W/kg for 1g SAR (i.e., Eq. (6c)).

<sup>9</sup> In Eq.(6a) and (6b), instantaneous transmission power is converted into instantaneous 1g SAR value by applying the measured worst-case 1g SAR value at  $P_{limit}$  for the corresponding technology/band/antenna/DSI reported in the Part 1 report.

### 3.3.4. Change in Antenna

This test is to demonstrate the correct power control by Smart Transmit during an antenna switch, i.e., switching from one antenna to another. The test procedure is identical to §3.3.3, by replacing technology/band switch operation with an antenna switch. The time-averaged 1g SAR versus time shall not exceed FCC limit of 1.6 W/kg for 1g SAR.<sup>10</sup>

### 3.3.5. Change in DSI

This test is to demonstrate the correct power control by Smart Transmit during a DSI switch, i.e., switching from one DSI state to another. The test procedure is identical to §3.3.3, by replacing technology/band switch operation with a DSI switch. The time-averaged 1g SAR versus time shall not exceed FCC limit of 1.6 W/kg for 1g SAR.

### 3.3.6. Change in Time Window

This test is to demonstrate the correct power control by Smart Transmit during the change in averaging time window when a specific band handover occurs. The FCC specifies time-averaging windows of 100 seconds for transmission frequencies < 3 GHz, and 60 seconds for transmission frequencies between 3 GHz and 6 GHz.

To validate the continuity of RF exposure limiting during the transition, the band handover test needs to be performed when the EUT handovers from one operating band less than 3 GHz to greater than 3 GHz, or vice versa. The equations (3a) and (3b) in §2 can be written as follows for transmission scenarios having a change in time windows:

$$1g SAR_1(t) = \frac{\text{conducted}_{Tx \text{ power } 1(t)}}{\text{conducted}_{Tx \text{ power } P_{limit 1}}} * 1g SAR P_{limit 1} \quad (7a)$$

$$1g SAR_2(t) = \frac{\text{conducted}_{Tx \text{ power } 2(t)}}{\text{conducted}_{Tx \text{ power } P_{limit 2}}} * 1g SAR P_{limit 2} \quad (7b)$$

$$\frac{1}{T_{1SAR}} \left[ \int_{t-T_{1SAR}}^{t_1} \frac{1g SAR_1(t)}{FCC SAR limit} dt \right] + \frac{1}{T_{2SAR}} \left[ \int_{t-T_{2SAR}}^t \frac{1g SAR_2(t)}{FCC SAR limit} dt \right] \leq 1 \quad (7c)$$

where,  $\text{conducted}_{Tx \text{ power } 1(t)}$ ,  $\text{conducted}_{Tx \text{ power } P_{limit 1(t)}}$ , and  $1g SAR P_{limit 1}$  correspond to the instantaneous transmission power, conducted transmission power at  $P_{limit}$ , and compliance  $1g SAR$  values at  $P_{limit 1}$  of band1 with the time-averaging window ' $T_{1SAR}$ ';  $\text{conducted}_{Tx \text{ power } 2(t)}$ ,  $\text{conducted}_{Tx \text{ power } P_{limit 2(t)}}$ , and  $1g SAR P_{limit 2}$  correspond to the instantaneous transmission power, conducted transmission power at  $P_{limit}$ , and compliance  $1g SAR$  values at  $P_{limit 2}$  of band2 with the time-averaging window ' $T_{2SAR}$ '. One of the two bands is less than 3 GHz, another is greater than 3 GHz. Transition from first band with time-averaging window ' $T_{1SAR}$ ' to the second band with time-averaging window ' $T_{2SAR}$ ' happens at time-instant ' $t_1$ '.

#### Test Procedure

1. Measure  $P_{limit}$  for both the technologies and bands selected in §3.2.6. Measure  $P_{limit}$  with Smart Transmit enabled and set Reserve\_power\_margin to 0 dB, and the callbox set to request maximum power.
2. Set Reserve\_power\_margin to actual (intended) value and enable Smart Transmit.

#### Transition from 100 seconds time window to 60 seconds time window, or vice versa

3. Establish radio link with the callbox in the technology/band having 100 seconds time window selected in §3.2.6.
4. Request the EUT's transmission power to be at 0 dBm for at least 100 seconds, followed by requesting the EUT's transmission power to be at maximum power for about ~140 seconds, and then switch to the second technology/band (having 60 seconds time window) selected in §3.2.6. Continue with the callbox requesting the EUT's transmission power to be at maximum power for about ~60 seconds in this second technology/band, and then switch back to the first technology/band. Continue with the callbox requesting the EUT's transmission power to be at maximum power for at least another 100 seconds. Measure and record the transmission power versus time for the entire duration of the test.

<sup>10</sup> If the EUT does not support antenna switching within the same technology/band, but has multiple antennas that support different frequency bands, then the antenna switch test is included as part of change in technology and band test (§3.3.3).

5. Once the measurement is done, extract the instantaneous transmission power versus time and convert the conducted transmission power into 1g SAR value (see Eq. (7a) and (7b)) using the corresponding technology/band in Step 1's result, then perform 100 seconds running average to determine time-averaged 1g SAR versus time.<sup>11</sup>
6. Make one plot containing: (a) Instantaneous transmission power versus time measured in Step 4.
7. Make another plot containing: (a) Instantaneous 1g SAR versus time determined in Step 5, (b) computed time-averaged 1g SAR versus time determined in Step 5, and (c) corresponding regulatory 1g SAR<sub>limit</sub> of 1.6W/kg.

#### Transition from 60 seconds time window to 100 seconds time window, or vice versa

8. Establish radio link with the callbox in the technology/band having a 60 second time window selected in §3.2.6.
9. Request the EUT's transmission power to be at 0 dBm for at least 60 seconds, followed by requesting the EUT's transmission power to be at maximum power for about ~80 seconds, and then switch to the second technology/band (having 100 seconds time window) selected in §3.2.6. Continue with the callbox requesting the EUT's transmission power to be at maximum power for about ~100 seconds in this second technology/band, and then switch back to the first technology/band. Continue with the callbox requesting the EUT's transmission power to be at maximum power for the remaining time for a total test time of 500 seconds. Measure and record the transmission power versus time for the entire duration of the test.
10. Repeat Step 5~7 to generate the plots.

The time-averaged 1g SAR versus time shall not exceed the regulatory 1g SAR<sub>limit</sub> of 1.6W/kg.

### 3.3.7. SAR Exposure Switching

This test is to demonstrate that the Smart Transmit feature is accurately accounting for switching in exposures among SAR from radio1 only, SAR from both radio1 and radio2, and SAR from radio2 only scenarios, and ensures total time-averaged RF exposure complies with the FCC limit. Here, radio1 represents the primary radio (for example, LTE anchor in a NR non-standalone mode call) and radio2 represents secondary radio (for example, Sub-6 GHz NR or mmW NR). The detailed test procedure for SAR exposure switching in the case of LTE+Sub-6 GHz NR non-standalone mode transmission scenario is provided in Appendix B.2.

#### Test Procedure

1. Measure the conducted transmission power corresponding to  $P_{limit}$  for radio1 and radio2 in the selected band. The test conditions to measure conducted  $P_{limit}$  are:
  - a. Establish a device in call with the callbox for radio1 technology/band. Measure the conducted transmission power corresponding to radio1  $P_{limit}$  with Smart Transmit enabled, set *Reserve\_power\_margin* to 0 dB, and set the callbox to request maximum power.
  - b. Repeat Step 1a to measure the conducted transmission power corresponding to radio2  $P_{limit}$ . If radio2 is dependent on radio1 (for example, non-standalone mode of Sub-6 GHz NR requiring radio1 LTE as an anchor), then establish radio1 + radio2 call with the callbox and request all down bits for radio1 LTE. In this scenario, set the callbox to request maximum power from radio2 Sub-6 GHz NR, then measure the conducted transmission power that corresponds to radio2's  $P_{limit}$  (as radio1 LTE is at all-down bits).
2. Set *Reserve\_power\_margin* to actual (intended) value, with the EUT setup for radio1 + radio2 call. In this description, it is assumed that radio2 has lower priority than radio1. Establish the device in radio1+radio2 call and request all-down bits or low power on radio1, with the callbox requesting the EUT's transmission power to be at maximum power in radio2 for at least one-time window. After one time window, set the callbox to request the EUT's transmission power to be at maximum power on radio1, i.e., all-up bits. Continue radio1 + radio2 call with both radios at maximum power for at least one-time window and drop (or request all-down bits on) radio2. Continue radio1 at maximum power for at least one-time window. Record the conducted transmission power for both radio1 and radio2 for the entire duration of this test.
3. Once the measurement is done, extract instantaneous transmission power versus time for both radio1 and radio2 links. Convert the conducted transmission power for both these radios into 1g SAR value (see Eq. (6a) and (6b)) using the corresponding technology/band  $P_{limit}$  measured in Step 1, and then perform the running time average to determine time-averaged 1g SAR versus time.

<sup>11</sup> In Eq.(7a) & (7b), instantaneous transmission power is converted into instantaneous 1g SAR value by applying the worst-case 1g SAR value tested in Part 1 for the selected technologies/bands at  $P_{limit}$ .

4. Make one plot containing: (a) Instantaneous transmission power versus time measured in Step 2.
5. Make another plot containing: (a) Instantaneous 1g SAR versus time determined in Step 3, (b) computed time-averaged 1g SAR versus time determined in Step 3, and (c) corresponding regulatory 1g SAR<sub>limit</sub> of 1.6W/kg.

The time-averaged 1g SAR versus time shall not exceed the regulatory 1g SAR<sub>limit</sub> of 1.6W/kg.

### 3.4. Test Procedure for Time-varying SAR Measurements

This section provides general time-varying SAR measurement procedures to perform compliance test under dynamic transmission scenarios described in §2. In practice, an adjustment can be made in these procedures. The justification/clarification may be provided.

To perform the validation through SAR measurement for transmission scenario 1 described in §2, the “path loss” between callbox, antenna, and EUT need to be calibrated to ensure that the EUT’s transmission power reacts to the requested power from the callbox in a radiated call. It should be noted that when signaling in closed loop mode, protocol-level power control is in play, resulting in the EUT not solely following the callbox’s TPC (transmit power control) commands. In other words, the EUT response has many dependencies (RSSI, quality of signal, path loss variation, fading, etc.) other than just TPC commands. These dependencies have less impact in conducted setup (as it is a controlled environment and the path loss can be very well calibrated) but have significant impact on radiated testing in an uncontrolled environment, such as a SAR test setup. Therefore, the deviation in EUT transmit power from the callbox’s requested power is expected, however the time-averaged SAR should not exceed the FCC SAR requirements as Smart Transmit controls the transmission power at the EUT.

The following steps are for time averaging feature validation through SAR measurement:

1. “Path Loss” calibration: Place the EUT against the phantom in the worst-case position determined based on §3.2.1. For each band selected, prior to SAR measurement, perform the “path loss” calibration between callbox, antenna, and EUT. Since the SAR test environment is not controlled and well calibrated for OTA (Over the Air) test, extreme care needs to be taken to avoid the influence of reflections. The test setup is described in §8.1.
2. Time averaging feature validation:
  - a. For a given radio configuration (technology/band) selected in §3.2.1, enable Smart Transmit and set *Reserve\_power\_margin* to 0 dB, with the callbox set to request maximum power. Perform an area scan, conduct a *pointSAR* (single point) measurement at the peak location of the area scan. This *pointSAR* value, *pointSAR*  $P_{limit}$ , corresponds to *pointSAR* at the measured  $P_{limit}$  (i.e., measured  $P_{limit}$  from the EUT in Step 1 of §3.3.1).
  - b. Set *Reserve\_power\_margin* to actual (intended) value and reset power on the EUT to enable Smart Transmit.<sup>12</sup> Establish radio link in desired radio configuration, with the callbox requesting the EUT’s transmission power at power levels described by test sequence 1 generated in Step 1 of §3.3.1, conduct *pointSAR* measurement versus time at peak location of the area scan determined in Step 2a of this section. Once the measurement is done, extract the instantaneous *pointSAR* versus time data, *pointSAR*( $t$ ), and convert it into instantaneous 1g SAR versus time using Eq. (3a), re-written below:

$$1gSAR(t) = \frac{pointSAR(t)}{pointSAR(t) P_{limit}} * 1gSAR(t) P_{limit} \quad (3a)$$

where, *pointSAR*  $P_{limit}$  is the value determined in Step 2a, and *pointSAR*( $t$ ) is the instantaneous *pointSAR* measured in Step 2b,  $1gSAR$   $P_{limit}$  is the measured 1g SAR value listed in the Part 1 report.

- c. Perform 100 seconds running average to determine time-averaged 1g SAR versus time.
- d. Make one plot containing: (a) Time-averaged 1g SAR versus time determined in Step 2c of this section, (b) FCC limit of 1.6 W/kg for 1g SAR.

<sup>12</sup> If *Reserve\_power\_margin* cannot be set wirelessly, care must be taken to re-position the EUT in the exact same position relative to the SAM phantom as in Step 2a.

- e. Repeat 2b ~ 2d for test sequence 2 generated in Step 1 of §3.3.1.
- f. Repeat 2a ~ 2e for all the technologies and bands selected in §3.2.1.

The time-averaged 1g SAR versus time shall not exceed FCC limit of 1.6 W/kg for 1g SAR (i.e., Eq. (3b)).

## 4. PD Time Averaging Validation Test Procedures

This chapter provides the test plan and test procedures for validating Qualcomm's Smart Transmit feature for mmW transmission. For this EUT, millimeter wave (mmW) transmission is only in non-standalone mode, i.e., it requires an LTE link as anchor.

### 4.1. Test Sequence for Validation in mmW NR Transmission

In 5G mmW NR transmission, the test sequence for validation is with the callbox always requesting the EUT's transmission power in 5G mmW NR at maximum power.

### 4.2. Test Configuration Selection Criteria for Validating Smart Transmit Feature

#### 4.2.1. Test Configuration Selection for Time-varying Transmission Power

The Smart Transmit time averaging feature operation is independent of bands, modes, channels, and antenna configurations (beams) for a given technology. Hence, validation of Smart Transmit in any one band/mode/channel per technology that approximately correspond to least and highest Plimit values that are less than Pmax based on pretesting is sufficient.

#### 4.2.2. Test Configuration Selection for Change in Antenna Configuration (Beam)

The Smart Transmit time averaging feature operation is independent of bands, modes, channels, and antenna configurations (beams) for a given technology. Hence, validation of Smart Transmit with beam switch between any two beams is sufficient.

#### 4.2.3. Test Configuration Selection for SAR versus PD Exposure Switch during Transmission

The Smart Transmit time averaging feature operation is independent of the nature of exposure (SAR vs. PD) and ensures total time-averaged RF exposure compliance. Hence, validation of Smart Transmit in any one band/mode/channel/beam for mmW + sub-6 GHz (LTE) transmission is sufficient, where the exposure varies among SAR dominant scenarios, SAR+PD scenarios, and PD dominant scenarios.

### 4.3. Test Procedures for mmW Radiated Power Measurements

Perform conducted power measurement (for  $f < 6$  GHz) and radiated power measurement (for  $f > 6$  GHz) for LTE + mmW transmission to validate Smart Transmit time averaging feature in the various transmission scenarios described in §2.

This section provides general conducted power measurement procedures to perform compliance test under dynamic transmission scenarios described in §2. In practice, an adjustment can be made in these procedures. The justification/clarification may be provided.

#### 4.3.1. Time-varying Transmission Power Scenario

The purpose of the test is to demonstrate the effectiveness of power limiting enforcement and that the time-averaged transmission power when converted into RF exposure values do not exceed the FCC limit (see Eq. (2a), (2b) & (2c) in §2).



## Test Procedure

1. Measure the conducted transmission power corresponding to  $P_{limit}$  for Sub-6 GHz selected band and measure the radiated transmission power corresponding to  $input.power.limit$  in desired mmW band/channel/beam by following below steps:
  - a. Measure the radiated power corresponding to mmW  $input.power.limit$  by setting up the EUT's transmission power in desired band/channel/beam at  $input.power.limit$  in Factory Test Mode (FTM). This test is performed in a calibrated anechoic chamber. Rotate the EUT to obtain maximum radiated transmission power, keep the EUT in this position and do not disturb the position of the EUT inside the anechoic chamber for the rest of this test.
  - b. Reset the EUT to place it in online mode and to establish a radio link in Sub-6 GHz, measure the conducted transmission power corresponding to Sub-6 GHz  $P_{limit}$  with Smart Transmit enabled and  $Reserve\_power\_margin$  set to 0 dB and with the callbox set to request maximum power.
2. Set  $Reserve\_power\_margin$  to actual (intended) value and reset power on the EUT to enable Smart Transmit. With the EUT setup for a mmW NR call in the desired/selected Sub-6 GHz band and mmW NR band, perform the following steps:
  - a. Establish Sub-6 GHz and mmW NR connection in the desired band/channel/beam used in Step 1. As soon as the mmW connection is established, immediately request all-down bits on the Sub-6 GHz link. With the callbox requesting the EUT's transmission power to be at maximum for mmW power to test predominantly the PD exposure scenario (as SAR exposure is less when the Sub-6 GHz transmission power is at low power).
  - b. After 120 seconds, request the Sub-6 GHz to go all-up bits for at least 100 seconds. SAR exposure is dominant. There are two scenarios:
    - i. If  $P_{limit} < P_{max}$  for Sub-6 GHz, then the RF exposure margin (provided to mmW NR) gradually runs out (due to high SAR exposure). This results in gradual reduction in the 5G mmW NR transmission power and eventually seized 5G mmW NR transmission when Sub-6 GHz goes to  $P_{reserve}$  level.
    - ii. If  $P_{limit} \geq P_{max}$  for Sub-6 GHz, then the 5G mmW NR transmission's averaged power should gradually reduce but the mmW NR connection can sustain all the time (assuming TxAGC uncertainty equal to 0dB).
  - c. Record the conducted transmission power of Sub-6 GHz and radiated transmission power of mmW for the full duration of this test of at least 300 seconds.
3. Once the measurement is done, extract the instantaneous transmission power versus time for both Sub-6 GHz and mmW links. Convert the conducted transmission power for Sub-6 GHz into 1g SAR values using Eq. (2a) and  $P_{limit}$  measured in Step 1.b, and then divide by FCC limit of 1.6 W/kg for 1g SAR to obtain the instantaneous normalized 1g SAR versus time. Perform 100 seconds running average to determine normalized 100 seconds-averaged 1g SAR versus time.<sup>13</sup>
4. Similarly, convert the radiated transmission power for mmW into 4 cm<sup>2</sup> PD value using Eq. (2b) and the radiated transmission power limit (i.e., radiated transmission power at  $input.power.limit$ ) measured in Step 1.a, then divide by FCC 4 cm<sup>2</sup> PD limit of 10 W/m<sup>2</sup> to obtain the instantaneous normalized 4 cm<sup>2</sup> PD versus time. Perform 4 seconds running average to determine normalized 4 seconds-averaged 4 cm<sup>2</sup> PD versus time.<sup>14</sup>
5. Make one plot containing: (a) Instantaneous conducted transmission power for Sub-6 GHz versus time, (b) computed 100 seconds-averaged conducted transmission power for Sub-6 GHz versus time, (c) instantaneous radiated transmission power for mmW versus time (as measured in Step 2), (d) computed 4 seconds-averaged radiated transmission power for mmW versus time, and (e) time-averaged conducted and radiated power limits for Sub-6 GHz and mmW radio using Eq. (5a) & (5b), respectively:

$$Time\ averaged\ Sub-6GHz\ power\ limit = meas.P_{limit} + 10 * \log\left(\frac{FCC\ SAR\ Limit}{meas.SAR\ P_{limit}}\right) \quad (5a)$$

$$Time\ averaged\ mmW\ NR\ power\ limit = meas.EIRP_{input.power.limit} + 10 * \log\left(\frac{FCC\ PD\ limit}{meas.PD\ input.power.limit}\right) \quad (5b)$$

where  $meas.EIRP_{input.power.limit}$  and  $meas.PD_{input.power.limit}$  correspond to measured EIRP at  $input.power.limit$  and measured power density at  $input.power.limit$ .

<sup>13</sup> In Eq.(2a), instantaneous transmission power is converted into instantaneous 1g SAR value by applying the measured worst-case 1g SAR value at  $P_{limit}$  for the corresponding technology/band/antenna/DSI reported in the Part 1 report.

<sup>14</sup> In Eq.(2b), instantaneous radiated transmission power is converted into instantaneous 4 cm<sup>2</sup> PD by applying the worst-case 4 cm<sup>2</sup> PD value measured at  $input.power.limit$  for the selected band/beam in the Part 1 report.

6. Make another plot containing: (a) Computed normalized 100 seconds-averaged 1g SAR versus time determined in Step 3, (b) computed normalized 4 seconds-averaged 4 cm<sup>2</sup> PD versus time determined in Step 4, and (c) corresponding total normalized time-averaged RF exposure (sum of steps (6.a) and (6.b)) versus time.

The total normalized time-averaged RF exposure versus time determined in Step 6.c shall not exceed the normalized limit of 1.0 of FCC requirement (i.e., Eq. (2c)).

### 4.3.2. Switch in SAR vs. PD Exposure during Transmission

This test is to demonstrate that the Smart Transmit feature is independent of the nature of exposure (SAR vs. PD) and accurately accounts for switching in exposures among SAR dominant, SAR + PD, and PD dominant scenarios, ensuring total time-averaged RF exposure compliance.

#### Test Procedure

1. Measure the conducted transmission power corresponding to  $P_{limit}$  for Sub-6 GHz in selected band(s), and measure the radiated transmission power corresponding to *input.power.limit* in the desired mmW band/channel/beam by following the steps below:
  - a. Measure the radiated power corresponding to *input.power.limit* by setting up the EUT's transmission power in the desired band/channel/beam at *input.power.limit* in FTM. This test is performed in a calibrated anechoic chamber. Rotate the EUT to obtain the maximum radiated transmission power, keep the EUT in this position and do not disturb the position of the EUT inside the anechoic chamber for the rest of this test.
  - b. Reset the EUT to place it in online mode and establish a radio link in Sub-6 GHz, measure the conducted transmission power corresponding to Sub-6 GHz  $P_{limit}$  with Smart Transmit enabled and with *Reserve\_power\_margin* set to 0 dB and the callbox set to request maximum power.
2. Set *Reserve\_power\_margin* to actual (intended) value and reset power in the EUT, with EUT setup for Sub-6 GHz + mmW call, perform the following steps:
  - a. Establish Sub-6 GHz and mmW NR connection with the callbox.
  - b. As soon as the mmW connection is established, immediately request all-down bits on the Sub-6 GHz link. Continue Sub-6 GHz (all-down bits) + mmW transmission for more than 100 seconds duration to test predominantly the PD exposure scenario (as SAR exposure is negligible from all-down bits in Sub-6 GHz).
  - c. After 120 seconds, request the Sub-6 GHz link to go all-up bits, mmW transmission should gradually run out of RF exposure margin if Sub-6 GHz's  $P_{limit} < P_{max}$  and seize mmW transmission (SAR only scenario); or mmW transmission should gradually reduce in transmission power and will sustain the connection if Sub-6 GHz's  $P_{limit} > P_{max}$ .
  - d. After 75 seconds, request the Sub-6 GHz link to go all-down bits, mmW transmission should start increase its RF exposure margin and resume transmission again.
  - e. Record the conducted transmission power of Sub-6 GHz and the radiated transmission power of mmW for the entire duration of this test of at least 300 seconds.
3. Once the measurement is done, extract the instantaneous transmission power versus time for both LTE and mmW links. Convert the conducted transmission power for Sub-6 GHz into 1g SAR value using Eq. (2a) and  $P_{limit}$  measured in Step 1.b, and then divide by FCC limit of 1.6 W/kg for 1g SAR to obtain the instantaneous normalized 1g SAR versus time. Perform 100 seconds running average to determine normalized 100 seconds-averaged 1g SAR versus time.<sup>15</sup>
4. Similarly, convert the radiated transmission power for mmW into 4 cm<sup>2</sup> PD value using Eq. (2b) and the radiated transmission power limit (i.e., radiated transmission power at *input.power.limit*) measured in Step 1.a, then divide this by FCC 4 cm<sup>2</sup> PD limit of 10 W/m<sup>2</sup> to obtain the instantaneous normalized 4 cm<sup>2</sup> PD versus time. Perform 4 seconds running average to determine normalized 4 seconds-averaged 4 cm<sup>2</sup> PD versus time.<sup>16</sup>

<sup>15</sup> In Eq.(2a), the instantaneous transmission power is converted into instantaneous 1g SAR value by applying the measured worst-case 1g SAR value at  $P_{limit}$  for the corresponding technology/band/antenna/DSI reported in the Part 1 report.

<sup>16</sup> In Eq.(2b), the instantaneous radiated transmission power is converted into instantaneous 4 cm<sup>2</sup> PD by applying the worst-case 4 cm<sup>2</sup> PD value measured at *input.power.limit* for the selected band/beam in the Part 1 report.

5. Make one plot containing: (a) Instantaneous conducted transmission power for Sub-6 GHz versus time, (b) computed 100 seconds-averaged conducted transmission power for Sub-6 GHz versus time, (c) instantaneous radiated transmission power for mmW versus time, as measured in Step 2, (d) computed 4 seconds-averaged radiated transmission power for mmW versus time, and (e) time-averaged conducted and radiated power limits for Sub-6 GHz and mmW radio using Eq. (5a) & (5b), respectively.
6. Make another plot containing: (a) Computed normalized 100 seconds-averaged 1g SAR versus time determined in Step 3, (b) computed normalized 4 seconds-averaged 4 cm<sup>2</sup> PD versus time determined in Step 4, and (c) corresponding total normalized time-averaged RF exposure (sum of steps (6.a) and (6.b)) versus time.

The total normalized time-averaged RF exposure versus time determined in Step 6.c shall not exceed the normalized limit of 1.0 of FCC requirement (i.e., Eq. (2c)).

### 4.3.3. Change in Antenna Configuration (Beam)

This test is to demonstrate the correct power control by Smart Transmit during changes in antenna configuration (beam). Since the *input.power.limit* varies with beam, the Eq. (2a), (2b) and (2c) in §2 are written as below for transmission scenarios having change in beam:

$$1g\ SAR(t) = \frac{\text{conducted Tx power}(t)}{\text{conducted Tx power } P_{limit}} * 1g\ SAR\ P_{limit} \quad (8a)$$

$$4\ cm^2\ PD_1(t) = \frac{\text{radiated Tx power } 1(t)}{\text{radiated Tx power } input.power.limit_1} * 4\ cm^2\ PD\ input.power.limit_1 \quad (8b)$$

$$4\ cm^2\ PD_2(t) = \frac{\text{radiated Tx power } 2(t)}{\text{radiated Tx power } input.power.limit_2} * 4\ cm^2\ PD\ input.power.limit_2 \quad (8c)$$

$$\frac{\frac{1}{T_{SAR}} \int_{t-T_{SAR}}^t 1g\ SAR(t) dt}{FCC\ SAR\ limit} + \frac{\frac{1}{T_{PD}} \left[ \int_{t-T_{PD}}^{t_1} 4\ cm^2\ PD_1(t) dt + \int_{t_1}^t 4\ cm^2\ PD_2(t) dt \right]}{FCC\ 4\ cm^2\ PD\ limit} \leq 1 \quad (8d)$$

where, *conducted Tx power(t)*, *conducted Tx power P<sub>limit</sub>*, and *1gSAR P<sub>limit</sub>* correspond to the measured instantaneous conducted transmission power, measured conducted transmission power at *P<sub>limit</sub>*, and measured 1g SAR values at *P<sub>limit</sub>* corresponding to Sub-6 GHz transmission. Similarly, *radiated Tx power 1(t)*, *radiated Tx power input.power.limit<sub>1</sub>*, and *4 cm<sup>2</sup> PD input.power.limit<sub>1</sub>* correspond to the measured instantaneous radiated transmission power, radiated Tx power at *input.power.limit*, and 4 cm<sup>2</sup> PD value at *input.power.limit* of beam 1; *radiated Tx power 2(t)*, *radiated Tx power input.power.limit<sub>2</sub>*, and *4 cm<sup>2</sup> PD input.power.limit<sub>2</sub>* correspond to the measured instantaneous radiated transmission power, radiated Tx power at *input.power.limit*, and 4 cm<sup>2</sup> PD value at *input.power.limit* of beam 2 corresponding to mmW transmission.

### Test Procedure

1. Measure the conducted transmission power corresponding to the *P<sub>limit</sub>* for Sub-6 GHz in the selected band and measure the radiated transmission power corresponding to the *input.power.limit* in the desired mmW band/channel/beam by following the steps below:
  - a. Measure the radiated power corresponding to mmW *input.power.limit* by setting up the EUT's transmission power in the desired band/channel at *input.power.limit* of beam 1 in FTM. Do not disturb the position of the EUT inside the anechoic chamber for the rest of this test. Repeat this Step (1.a) for beam 2.
  - b. Reset the EUT to place it in online mode and establish a radio link in Sub-6 GHz; measure the conducted transmission power corresponding to Sub-6 GHz *P<sub>limit</sub>* with Smart Transmit enabled, *Reserve\_power\_margin* set to 0 dB, and the callbox set to request maximum power.
2. Set *Reserve\_power\_margin* to actual (intended) value and reset power in EUT; with the EUT set for Sub-6 GHz + mmW connection, perform the following steps:
  - a. Establish Sub-6 GHz and mmW NR connection in beam 1. As soon as the mmW connection is established, immediately request all-down bits on Sub-6 GHz link with the callbox requesting the EUT's transmission power to be at maximum mmW power.
  - b. After beam 1 continues transmitting for at least 20 seconds, request the EUT to change from beam 1 to beam 2 and continue transmitting with beam 2 for at least 20 seconds.
  - c. Record the conducted transmission power of Sub-6 GHz and the radiated transmission power of mmW for the entire duration of this test.
3. Once the measurement is done, extract the instantaneous transmission power versus time for both Sub-6 GHz and mmW links. Convert the conducted transmission power for Sub-6 GHz into 1g SAR value using

- the similar approach described in Step 3 of §4.3.2. Perform 100 seconds running average to determine normalized 100 seconds-averaged 1g SAR versus time.
4. Similarly, convert the radiated transmission power for mmW NR into 4 cm<sup>2</sup> PD value using Eq. (8b), (8c) and the radiated transmission power limits (i.e., radiated transmission power at *input.power.limit*) measured in Step 1.a for beam 1 and beam 2, respectively, and then divide the resulting PD values by FCC's 4 cm<sup>2</sup> PD limit of 10 W/m<sup>2</sup> to obtain the instantaneous normalized 4 cm<sup>2</sup> PD versus time for beam 1 and beam 2. Perform 4 seconds running average to determine normalized 4 seconds-averaged 4 cm<sup>2</sup> PD versus time.<sup>17</sup>
  5. Since the measured radiated powers for beam 1 and beam 2 in Step 1.a were performed at an arbitrary rotation of the EUT in anechoic chamber, repeat Step 1.a of this procedure by rotating the EUT to determine maximum radiated power at *input.power.limit* using FTM mode for both beams separately. Re-scale the measured instantaneous radiated power in Step 2.c by the delta in radiated power measured in Step 5 and the radiated power measured in Step 1.a for plotting purposes in the next step. In other words, this step essentially converts measured instantaneous radiated power during the measurement in Step 2 into maximum instantaneous radiated power for both beams. Perform 4 seconds running average to compute 4 seconds-averaged radiated transmission power. Additionally, use these EIRP values measured at *input.power.limit* at respective peak locations to determine the EIRP limits (using Eq. (5b)) for both beams.
  6. Make one plot containing: (a) Instantaneous conducted transmission power for Sub-6 GHz versus time, (b) computed 100 seconds-averaged conducted transmission power for Sub-6 GHz versus time, (c) instantaneous radiated transmission power for mmW versus time, as obtained in Step 5, (d) computed 4 seconds-averaged radiated transmission power for mmW versus time, as obtained in Step 5, and (e) time-averaged conducted and radiated power limits for Sub-6 GHz and mmW radio, respectively.
  7. Make another plot containing: (a) Computed normalized 100 seconds-averaged 1g SAR versus time determined in Step 3, (b) computed normalized 4 seconds-averaged 4 cm<sup>2</sup> PD versus time determined in Step 4, and (c) corresponding total normalized time-averaged RF exposure (sum of steps (6.a) and (6.b)) versus time.

The total normalized time-averaged RF exposure versus time determined in Step 6.c shall not exceed the normalized limit of 1.0 of FCC requirement (i.e., (8d)).

#### 4.4. Test Procedure for Time-varying PD Measurements

The following steps are used to perform the validation through PD measurement for transmission scenario 1, as described in §2:

1. Place the EUT on the cDASY6 platform to perform a PD measurement in the worst-case position/surface for the selected mmW band/beam. In the PD measurement, the callbox is set to request maximum transmission power from the EUT. Hence, "path loss" calibration between callbox, antenna, and EUT is not needed in this test.
2. Time averaging feature validation:
  - a. Measure the conducted transmission power corresponding to  $P_{limit}$  for Sub-6 GHz in the selected band and measure the point E-field corresponding to *input.power.limit* in the desired mmW band/channel/beam by following the below steps:
    - i. Measure the conducted transmission power corresponding to the Sub-6 GHz  $P_{limit}$  with Smart Transmit enabled, *Reserve\_power\_margin* set to 0 dB, and with the callbox set to request maximum power.
    - ii. Measure the point E-field at the peak location of the fast area scan corresponding to the *input.power.limit* by setting up the EUT's transmission power in the desired mmW band/channel/beam at *input.power.limit* using FTM. Do not disturb the position of the EUT and mmW cDASY6 probe.
  - b. Set *Reserve\_power\_margin* to actual value (i.e., intended value) and reset power on the EUT; place the EUT in online mode. With the EUT setup for Sub-6 GHz + mmW NR call, as soon as the mmW NR connection is established, request all-down bits on Sub-6 GHz link. Continue Sub-6 GHz (all-down bits) + mmW transmission for more than 100 seconds duration to test predominantly the PD exposure scenario. After 120 seconds, request the Sub-6 GHz link to go all-up bits; the mmW transmission should gradually reduce. Simultaneously, record the conducted transmission power of the Sub-6 GHz transmission using the power meter and point E-field (in terms of ratio of  $\frac{[pointE(t)]^2}{[pointE\_input.power.limit]^2}$ ) of mmW transmission using cDASY6 E-field probe at peak location identified in Step 2.a.ii for the entire duration of this test, of at least 300 seconds.

<sup>17</sup> In Eq.(8b) and (8c), the instantaneous radiated transmission power of beam 1 and beam 2 is converted into instantaneous 4 cm<sup>2</sup> PD by applying the worst-case 4 cm<sup>2</sup> PD value measured at the *input.power.limit* of beam 1 and beam 2 in the Part 1 report, respectively.

- c. Once the measurement is done, extract the instantaneous conducted transmission power versus time for the Sub-6 GHz transmission and  $\frac{[pointE(t)]^2}{[pointE\_input.power.limit]^2}$  ratio versus time from the cDASY6 system for mmW transmission. Convert the conducted transmission power for the Sub-6 GHz link into 1g SAR value using Eq. (4a) and  $P_{limit}$  measured in Step 2.a.i, and then divide this by FCC limit of 1.6 W/kg for 1g SAR to obtain the instantaneous normalized 1g SAR versus time. Perform 100 seconds running average to determine the normalized 100 second-averaged 1g SAR versus time.<sup>18</sup>
- d. Similarly, convert the point E-field for mmW transmission into 4 cm<sup>2</sup> PD value using Eq. (4b) and radiated power limit measured in Step 2.a.ii, and then divide this by FCC 4 cm<sup>2</sup> PD limit of 10 W/m<sup>2</sup> to obtain the instantaneous normalized 4 cm<sup>2</sup> PD versus time. Perform 4 seconds running average to determine the normalized 4 seconds-averaged 4 cm<sup>2</sup> PD versus time.
- e. Make one plot containing: (i) Computed normalized 100 seconds-averaged 1g SAR versus time determined in Step 2.c, (ii) computed normalized 4 seconds-averaged 4 cm<sup>2</sup> PD versus time determined in Step 2.d, and (iii) corresponding total normalized time-averaged RF exposure (sum of steps (2.e.i) and (2.e.ii)) versus time.

The total normalized time-averaged RF exposure versus time determined in Step 2.e.iii shall not exceed the normalized limit of 1.0 of FCC requirement (i.e., Eq. (4c)).

---

<sup>18</sup> In Eq.(4a), the instantaneous transmission power is converted into instantaneous 1g SAR value by applying the measured worst-case 1g SAR value at  $P_{limit}$  for the corresponding technology/band reported in the Part 1 report.

## 5. Test Configurations

### 5.1. WWAN (Sub-6 GHz) Transmission

The  $P_{limit}$  values for technologies and bands supported by the EUT are derived in the Part 0 report and summarized in Table 5-1.<sup>19, 20</sup>

Based on the selection criteria described in §3.2.1, the selected technologies/bands for testing time-varying test sequences are shaded in Table 5-1. As per the Part 1 report, the *Reserve\_power\_margin* (dB) is set to 3 dB in the device EFS and is used in the Part 2 test.

The radio configurations used in the Part 2 test for selected technologies/bands/DSI states/antennas are listed in Table 5-2<sup>21</sup>. The corresponding worst-case radio configuration 1g SAR values for selected technology/band/DSI are extracted from the Part 1 report and are listed in the last column of Table 5-2.

Based on equations (1a), (2a), (3a) and (4a), Part 2 testing outcome is the normalized quantity, which implies that it can be applied to any radio configuration within a selected technology/band/DSI. Thus, applying the worst-case SAR obtained from the worst radio configuration in Part 1 testing to calculate time-varying SAR exposure in equations (1a), (2a), (3a) and (4a), the accuracy in compliance demonstration remains the same.

---

<sup>19</sup> All  $P_{limit}$  power levels entered in Table 5-1 correspond to average power levels after accounting for duty cycle in the case of TDD modulation schemes, e.g., GSM, LTE TDD & Sub-6 GHz NR TDD.

<sup>20</sup> Maximum tune up target power,  $P_{max}$ , is configured in the NV settings within the EUT to limit maximum transmitting power. This power is converted into peak power in the NV settings for TDD schemes. The EUT's maximum allowed output power is equal to  $P_{max}$  + device uncertainty (dB).

<sup>21</sup> The head exposure can be distinguished through audio receiver mode, represented as DSI state 0. DSI state 1 represents all other exposures which cannot be distinguished; thus, in this case, the maximum 1g SAR and/among all remaining exposure scenarios or the minimum  $P_{limit}$  among all remaining exposure scenarios (i.e., body worn 1g SAR evaluation at 5 mm spacing) is used in the Smart Transmit feature for time averaging operation.

**Table 5-1:  $P_{limit}$  for supported technologies and bands ( $P_{limit}$  in EFS file)**

| Tech/Band        | Antenna |           |         | Worst-case SAR (W/kg) |           |         | Plimit Max Tune-up Power + Uncertainty (dBm) |           |         |
|------------------|---------|-----------|---------|-----------------------|-----------|---------|--|-----------|---------|
|                  | Head    | Body-worn | Hotspot | Head                  | Body-worn | Hotspot | Head   | Body-worn | Hotspot |
|                  | DSI: 0  | DSI: 1    | DSI: 1  | DSI: 0                | DSI: 1    | DSI: 1  | DSI: 0                                       | DSI: 1    | DSI: 1  |
| GSM 850 2 slots  | ANT2    | ANT1      | ANT1    | 0.674                 | 0.557     | 0.557   | 30.50  | 31.00     | 31.00   |
| GSM 1900 2 slots | ANT2    | ANT3      | ANT3    | 0.952                 | 0.957     | 0.957   | 26.00  | 26.30     | 26.30   |
| W-CDMA B2        | ANT4    | ANT3      | ANT1    | 0.958                 | 0.954     | 0.959   | 20.30  | 20.30     | 21.80   |
| W-CDMA B4        | ANT2    | ANT2      | ANT2    | 0.930                 | 0.959     | 0.959   | 23.50  | 23.50     | 23.50   |
| W-CDMA B5        | ANT2    | ANT1      | ANT1    | 0.953                 | 0.958     | 0.958   | 24.50  | 25.00     | 25.00   |
| CDMA BC0         | ANT2    | ANT1      | ANT1    | 0.950                 | 0.567     | 0.567   | 23.00  | 23.50     | 23.50   |
| CDMA BC1         | ANT2    | ANT1      | ANT1    | 0.921                 | 0.897     | 0.951   | 20.00  | 21.80     | 21.80   |
| CDMA BC10        | ANT2    | ANT1      | ANT1    | 0.867                 | 0.845     | 0.845   | 24.50  | 25.00     | 25.00   |
| LTE Band 5       | ANT2    | ANT1      | ANT1    | 0.915                 | 0.919     | 0.919   | 24.50  | 25.00     | 25.00   |
| LTE Band 7       | ANT4    | ANT2      | ANT3    | 0.958                 | 0.897     | 0.957   | 19.50  | 19.50     | 19.30   |
| LTE Band 12/17   | ANT2    | ANT1      | ANT1    | 0.841                 | 0.524     | 0.705   | 24.70  | 25.70     | 25.70   |
| LTE Band 13      | ANT2    | ANT1      | ANT1    | 0.882                 | 0.627     | 0.627   | 24.70  | 25.70     | 25.70   |
| LTE Band 14      | ANT2    | ANT1      | ANT1    | 0.935                 | 0.688     | 0.688   | 24.70  | 25.70     | 25.70   |
| LTE Band 25/2    | ANT4    | ANT2      | ANT4    | 0.953                 | 0.926     | 0.958   | 20.30  | 19.80     | 20.80   |
| LTE Band 26      | ANT2    | ANT1      | ANT1    | 0.926                 | 0.876     | 0.876   | 24.50  | 25.00     | 25.00   |
| LTE Band 30      | ANT4    | ANT2      | ANT4    | 0.946                 | 0.940     | 0.952   | 20.30  | 21.00     | 20.00   |
| LTE Band 41      | ANT2    | ANT2      | ANT3    | 0.959                 | 0.914     | 0.958   | 20.30  | 21.50     | 21.30   |
| LTE Band 48      | ANT4    | ANT7      | ANT7    | 0.951                 | 0.956     | 0.956   | 19.50  | 22.80     | 22.80   |
| LTE Band 66/4    | ANT4    | ANT2      | ANT1    | 0.959                 | 0.879     | 0.959   | 19.80  | 23.50     | 19.30   |
| LTE Band 71      | ANT2    | ANT2      | ANT2    | 0.824                 | 0.495     | 0.495   | 24.70  | 24.70     | 24.70   |
| NR n5            | ANT2    | ANT1      | ANT1    | 0.613                 | 0.633     | 0.633   | 24.50  | 25.00     | 25.00   |
| NR n7            | ANT4    | ANT3      | ANT1    | 0.901                 | 0.741     | 0.883   | 19.50  | 19.30     | 20.00   |
| NR n12           | ANT2    | ANT1      | ANT1    | 0.619                 | 0.370     | 0.410   | 24.70  | 25.70     | 25.70   |
| NR n25/2         | ANT4    | ANT3      | ANT1    | 0.945                 | 0.856     | 0.950   | 20.30  | 20.30     | 21.80   |
| NR n30           | ANT4    | ANT2      | ANT1    | 0.842                 | 0.873     | 0.913   | 20.30  | 21.00     | 20.50   |
| NR n41           | ANT4    | ANT2      | ANT4    | 0.903                 | 0.729     | 0.762   | 17.50  | 19.50     | 18.80   |
| NR n66           | ANT4    | ANT3      | ANT1    | 0.886                 | 0.805     | 0.955   | 19.80  | 21.80     | 19.30   |
| NR n71           | ANT2    | ANT2      | ANT2    | 0.400                 | 0.367     | 0.367   | 24.70  | 24.70     | 24.70   |
| NR n77           | ANT4    | ANT7      | ANT8    | 0.951                 | 0.956     | 0.959   | 19.20  | 21.00     | 20.50   |

**Table 5-2: Radio configurations selected for Part 2**

| Part 2 Test Configurations |  |                |      |      |     |         |        |           |      |                          | Worst-case radio config 1g SAR measured at $P_{lim}$ (W/kg) |
|----------------------------|--|----------------|------|------|-----|---------|--------|-----------|------|--------------------------|---|
| Test Case                  | Test Scenario  | Tech           | Band | Ant. | DSI | Channel | Freq.  | RB/offset | Mode | Detail                   |   |
| 1                          | time-varying Tx power transmission (Seq1/Seq2) for conducted power | GSM            | 1900 | 2    | 1   | 810     | 1909.8 | N/A       | B    | GPRS Rear 1-g   5 mm     | 0.690   |
| 2                          |  |                | 1900 | 1    | 1   | 810     | 1909.8 | N/A       | B    | GPRS Edge 2 1-g   5 mm   | 0.785   |
| 3                          |  | W-CDMA         | B4   | 1    | 1   | 1413    | 1732.6 | N/A       | B    | UMTS Edge 3 1-g   5 mm   | 0.800   |
| 4                          |  |                | B4   | 3    | 1   | 1312    | 1712.4 | N/A       | B    | UMTS Rear 1-g   5 mm     | 0.805   |
| 5                          |  | CDMA           | BC1  | 2    | 1   | 1175    | 1908.8 | N/A       | B    | CDMA Rear 1-g   5 mm     | 0.778   |
| 6                          |  |                | BC1  | 1    | 1   | 1175    | 1908.8 | N/A       | B    | CDMA Edge 2 1-g   5 mm   | 0.848   |
| 7                          |  | LTE            | B66  | 1    | 1   | 132072  | 1720.0 | 1/49      | B    | LTE Edge 3 1-g   5 mm    | 0.878   |
| 8                          |  |                | B25  | 1    | 1   | 26365   | 1882.5 | 100/0     | B    | LTE Edge 2 1-g   5 mm    | 0.841   |
| 9                          |  | sub6 NR        | n66  | 1    | 1   | 344000  | 1720.0 | 50/28     | B    | NR Edge 3 1-g   5 mm     | 0.871   |
| 10                         |  |                | n25  | 1    | 1   | 381000  | 1905.0 | 1/53      | B    | NR Edge 2 1-g   5 mm     | 0.887   |
| 11                         | call drop for conducted power test                                 | LTE            | B66  | 1    | 1   | 132072  | 1720.0 | 1/49      | B    | LTE Edge 3 1-g   5 mm    | 0.878   |
| 12                         | tech/band for conducted power test                                 | W-CDMA         | B4   | 1    | 1   | 1413    | 1732.6 | N/A       | B    | UMTS Edge 3 1-g   5 mm   | 0.800   |
|                            |  | LTE            | B66  | 1    | 1   | 132072  | 1720.0 | 1/49      | B    | LTE Edge 3 1-g   5 mm    | 0.878   |
| 13                         | DSI switch for conducted power test                                | LTE            | B41  | 2    | 0   | 41055   | 2636.5 | 50/24     | A    | LTE Left Tilt 1-g   0 mm | 0.855   |
|                            |  | LTE            | B41  | 2    | 1   | 40620   | 2593.0 | 50/24     | B    | LTE Rear 1-g   5 mm      | 0.802   |
| 14                         | Time-window/Ant switch for conducted power test                    | LTE            | B66  | 1    | 1   | 132072  | 1720.0 | 1/49      | B    | LTE Edge 3 1-g   5 mm    | 0.878   |
|                            |  | LTE            | B48  | 7    | 1   | 56207   | 3646.7 | 50/24     | B    | LTE Rear 1-g   5 mm      | 0.786   |
| 15                         | SAR exposure switch for conducted power test                       | ENDC           | B66  | 1    | 1   | 132072  | 1720.0 | 1/49      | B    | LTE Edge 3 1-g   5 mm    | 0.878   |
|                            |  |                | n25  | 2    | 1   | 381000  | 1905.0 | 1/53      | B    | NR Rear 1-g   5 mm       | 0.740   |
| 16                         |  | Interband ULCA | B5   | 2    | 1   | 20525   | 836.5  | 1/25      | B    | LTE Front 1-g   5 mm     | 0.752   |
|                            |  |                | B66  | 1    | 1   | 132072  | 1720.0 | 1/49      | B    | LTE Edge 3 1-g   5 mm    | 0.878   |

Based on the selection criteria described in §3.2, the radio configurations for the transmission varying test cases listed in §2 are:

1. Technologies and bands for time-varying Tx power transmission: The test case 1~10 listed in Table 5-2 are selected to test with the test sequences defined in §3.1 in both time-varying conducted power measurements and time-varying SAR measurements.
2. Technology and band for change in call test: Select the technology and frequency band having the lowest  $P_{limit}$  among all technologies and bands (test case 11 in Table 5-2) for performing the call drop test in conducted power setup.
3. Technologies and bands for change in technology/band test: Following the guidelines in §3.2.3 and 4.2.4, test case 12 in Table 5-2 is selected for handover test from a technology/band/antenna with approximately the highest  $P_{limit}$  within one technology group, to a technology/band in the same DSI state with approximately the lowest  $P_{limit}$  within another technology group in a conducted power setup.
4. Technologies and bands for change in DSI: Based on selection criteria in §3.2.5, for a given technology and band, test case 13 in Table 5-2 is selected for DSI switch test by establishing a call in one technology and DSI state and then handing over to another DSI state/exposure scenario in a conducted power setup.
5. Technologies and bands for change in time-window/antenna: Based on selection criteria in §3.2.6, for a given DSI state, test case 14 in Table 5-2 is selected for time window switch between 60 seconds window and 100 seconds window in a conducted power setup.
6. Technologies and bands for switch in SAR exposure: Based on selection criteria in §3.2.7 Scenario 1, test case 15 in Table 5-2 is selected for SAR exposure switching test in one of the supported simultaneous WWAN transmission scenario, i.e., LTE + Sub6 NR active in the same 100 seconds time window, in a conducted power setup. Since this device supports Sub-6 GHz + mmW NR, test for §3.2.7 Scenario 2 for RF exposure switch is covered in §9.2.3 and 9.2.4 between Sub-6 GHz (100 seconds window) and mmW NR (4 seconds window).



## 5.2. LTE + mmW NR Transmission

Based on the selection criteria described in §4.2, the selections for LTE and mmW NR validation test are listed in Table 5-3. The radio configurations used in this test are listed in Table 5-4.<sup>22</sup>

**Table 5-3: Selections for LTE + mmW NR validation measurements**

| Transmission Scenario      | Test                                       | Technology and Band  | mmW Beam                |
|----------------------------|--|----------------------|-------------------------|
| Time-varying Tx power test | 1. Cond. & Rad. Power meas.<br>2. PD meas. | LTE Band 66 and n258 | Beam ID 32              |
|                            |  | LTE Band 66 and n260 | Beam ID 34              |
| Switch in SAR vs. PD       | 1. Cond. & Rad. Power meas.                | LTE Band 66 and n258 | Beam ID 32              |
|                            |  | LTE Band 66 and n260 | Beam ID 34              |
| Beam switch test           | 1. Cond. & Rad. Power meas.                | LTE Band 66 and n258 | Beam ID 34 to Beam ID 2 |
|                            |  | LTE Band 66 and n260 | Beam ID 33 to Beam ID 2 |

**Table 5-4: Test configuration for LTE + mmW NR validation**

| Tech   | Band | Antenna | DSI | Channel | RB Size | RB Offset | Freq (MHz) | Mode | UL Duty Cycle       |
|--------|------|---------|-----|---------|---------|-----------|------------|------|---------------------|
| LTE    | 66/4 | 1       | 1   | MID     | 1       | 49        | 1745       | QPSK | 100%                |
| mmW NR | N258 | M2      | --  | MID     | 1       |           | 25875      | CW   | 78.1% <sup>22</sup> |
|        | N260 | M2      | --  | MID     | 1       |           | 38500      | CW   | 78.1% <sup>22</sup> |

<sup>22</sup> mmW NR callbox UL duty cycle should be configured to be greater than 75% for all LTE + mmW NR Part 2 tests.

## 6. Conducted Power Test Results for Sub-6 GHz Smart Transmit Feature Validation

### 6.1. Measurement Setup

The Rohde & Schwarz CMW500 callbox is used in this test. The test setup picture and schematic are shown in Figures 7-1a and 7-1b for measurements with a single antenna and in Figure 6-1c for measurements involving antenna switching (see Appendix E for missing figures). For single antenna measurements, one port (RF1 COM) of the callbox is connected to the RF port of the EUT using a directional coupler. For antenna & technology switch measurement, two ports (RF1 COM and RF3 COM) of the callbox are used for signaling two different technologies are connected to a combiner, which is, in turn, connected to a directional coupler. The other end of the directional coupler is connected to a splitter to connect to two RF ports of the EUT corresponding to the two antennas of interest. In both the setups, a power meter is used to tap the directional coupler for measuring the conducted output power of the EUT. For time averaging validation test (§3.3.1), call drop test (§3.3.2), and DSI switch test (§3.3.4), only RF1 COM port of the callbox is used to communicate with the EUT. For technology/band switch measurement (§3.3.3), both RF1 COM and RF3 COM ports of the callbox are used to switch from one technology communicating on RF1 COM port to another technology communicating on RF3 COM port.<sup>23</sup> All the path losses from the RF port of the EUT to the callbox RF COM port and to the power meter are calibrated and automatically entered as offsets in the callbox and the power meter via test scripts on the PC used to control callbox and power meter.

---

<sup>23</sup> For this EUT, antenna switch test (§3.3.4) is included within time-window switch test (§3.3.6) as the selected technology/band combinations for the time-window switch test are on two different antennas.

LTE + Sub-6 GHz NR Test Setup:

If the LTE conducted port and Sub-6 GHz NR conducted port are same on this EUT (i.e., they share the same antenna), then low-/high-pass filters are used to separate the LTE and Sub-6 GHz NR signals for power meter measurement via directional couplers, as shown in below Figures 7-1b and 7-1c.

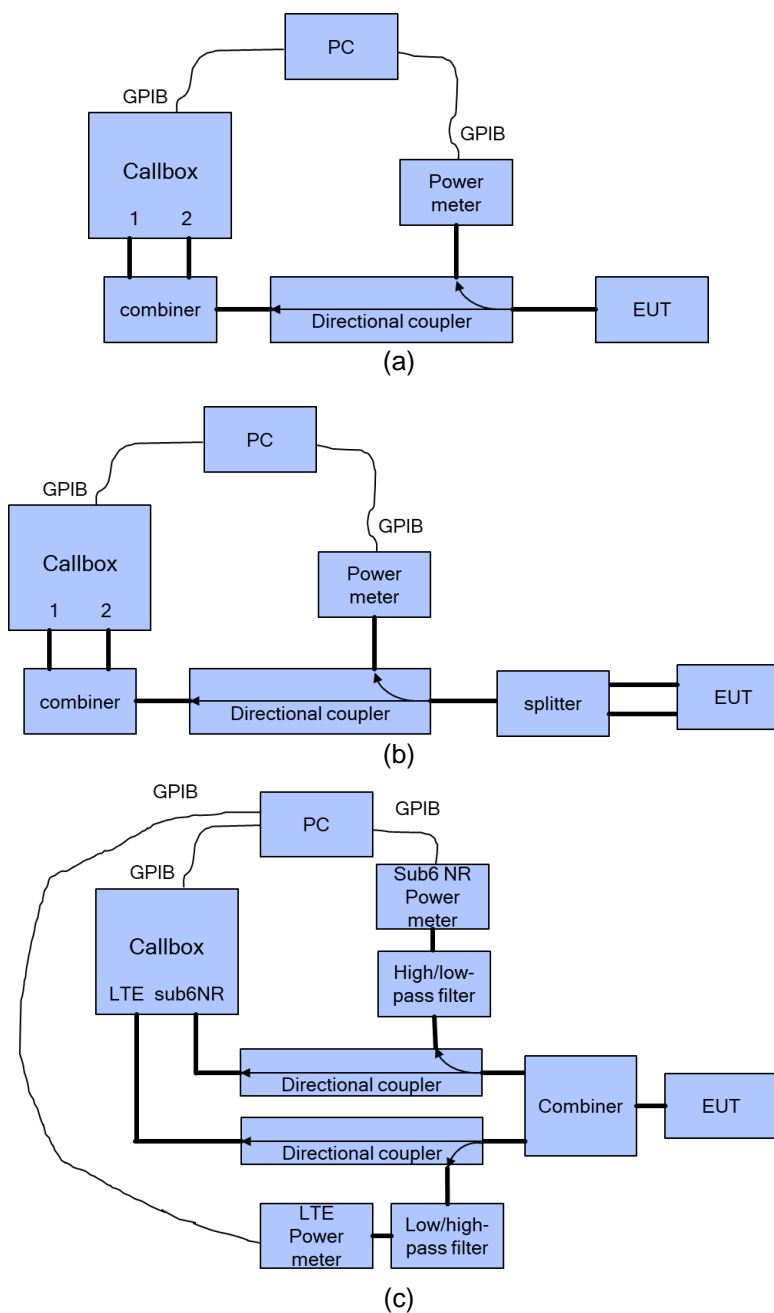

**Figure 6-1a – 6-1c: Conducted power measurement setup**

Both the callbox and power meter are connected to the PC using GPIB cables. Two test scripts are custom made for automation and the test duration set in the test scripts is 500 seconds.

For time-varying transmission power measurement, the PC runs the first test script to send GPIB commands to control the callbox’s requested power versus time, while, at the same time, recording the conducted power measured at the EUT’s RF port using the power meter. The commands sent to the callbox to request power are:

- 0 dBm for 100 seconds.

- Test sequence 1 or test sequence 2 (defined in §3.1 and generated in §3.2.1) for 500 seconds.
- Stay at the last power level of test sequence 1 or test sequence 2 for the remaining time.

The power meter readings are periodically recorded every 100 milliseconds. A running average of this measured transmission power over 100 seconds is performed in the post-data processing to determine the 100 seconds-time averaged power.

For call drop, technology/band/antenna switch, and DSI switch tests, after the call is established, the callbox is set to request the EUT’s transmission power at 0 dBm for 100 seconds while simultaneously starting the second test script run at the same time to start recording the transmission power measured at the EUT’s RF port using the power meter. After the initial 100 seconds, since starting the transmission power recording, the callbox is set to request maximum power from the EUT for the rest of the test.<sup>24</sup>

## 6.2. $P_{limit}$ and $P_{max}$ Measurement Results

The measured  $P_{limit}$  for all the selected radio configurations given in Table 5-2 are listed in Table 6-1.<sup>25</sup>  $P_{max}$  was also measured for radio configurations selected for testing time-varying power transmission scenarios to generate test sequences following the test procedures in §3.1.

**Table 6-1: Measured  $P_{limit}$  and  $P_{max}$  of selected radio configurations**

| Test Case | Test Scenario  | Tech           | Band | Antenna | DSI | Channel | Freq.  | RB/offset | Mode | Detail(s)                | $P_{lim}$ EFS Setting <sup>1</sup> (Burst) | Tune-up Target Power $P_{max}$ (Burst) | Measured $P_{lim}$ |
|-----------|--|----------------|------|---------|-----|---------|--------|-----------|------|--------------------------|--|--|--------------------|
| 1         | time-varying Tx power transmission (Seq1/Seq2) for conducted power | GSM            | 1900 | 2       | 1   | 810     | 1909.8 | N/A       | B    | GPRS Rear 1-g   5 mm     | 24.8                                       | 28.5                                   | 24.5               |
| 2         |  |                | 1900 | 1       | 1   | 810     | 1909.8 | N/A       | B    | GPRS Edge 2 1-g   5 mm   | 26.8                                       | 31.0                                   | 27.0               |
| 3         |  | W-CDMA         | B4   | 1       | 1   | 1413    | 1732.6 | N/A       | B    | UMTS Edge 3 1-g   5 mm   | 18.8                                       | 25.7                                   | 18.5               |
| 4         |  |                | B4   | 3       | 1   | 1312    | 1712.4 | N/A       | B    | UMTS Rear 1-g   5 mm     | 21.3                                       | 25.2                                   | 21.1               |
| 5         |  | CDMA           | BC1  | 2       | 1   | 1175    | 1908.8 | N/A       | B    | CDMA Rear 1-g   5 mm     | 19.3                                       | 23.7                                   | 19.2               |
| 6         |  |                | BC1  | 1       | 1   | 1175    | 1908.8 | N/A       | B    | CDMA Edge 2 1-g   5 mm   | 21.3                                       | 25.7                                   | 21.3               |
| 7         |  | LTE            | B66  | 1       | 1   | 132072  | 1720.0 | 1/49      | B    | LTE Edge 3 1-g   5 mm    | 18.8                                       | 25.7                                   | 18.7               |
| 8         |  |                | B25  | 1       | 1   | 26365   | 1882.5 | 100/0     | B    | LTE Edge 2 1-g   5 mm    | 21.3                                       | 25.7                                   | 21.3               |
| 9         |  | sub6 NR        | n66  | 1       | 1   | 344000  | 1720.0 | 50/28     | B    | NR Edge 3 1-g   5 mm     | 18.6                                       | 25.7                                   | 18.9               |
| 10        |  |                | n25  | 1       | 1   | 381000  | 1905.0 | 1/53      | B    | NR Edge 2 1-g   5 mm     | 21.1                                       | 25.7                                   | 21.5               |
| 11        | call drop for conducted power test                                 | LTE            | B66  | 1       | 1   | 132072  | 1720.0 | 1/49      | B    | LTE Edge 3 1-g   5 mm    | 18.8                                       | 25.7                                   | 18.7               |
| 12        | tech/band for conducted power test                                 | W-CDMA         | B4   | 1       | 1   | 1413    | 1732.6 | N/A       | B    | UMTS Edge 3 1-g   5 mm   | 18.8                                       | 25.7                                   | 18.5               |
|           |  | LTE            | B66  | 1       | 1   | 132072  | 1720.0 | 1/49      | B    | LTE Edge 3 1-g   5 mm    | 18.8                                       | 25.7                                   | 18.7               |
| 13        | DSI switch for conducted power test                                | LTE            | B41  | 2       | 0   | 41055   | 2636.5 | 50/24     | A    | LTE Left Tilt 1-g   0 mm | 19.8                                       | 25.0                                   | 19.8               |
|           |  | LTE            | B41  | 2       | 1   | 40620   | 2593.0 | 50/24     | B    | LTE Rear 1-g   5 mm      | 21.0                                       | 25.0                                   | 20.9               |
| 14        | Time-window/Ant switch for conducted power test                    | LTE            | B66  | 1       | 1   | 132072  | 1720.0 | 1/49      | B    | LTE Edge 3 1-g   5 mm    | 18.8                                       | 25.7                                   | 18.7               |
|           |  | LTE            | B48  | 7       | 1   | 56207   | 3646.7 | 50/24     | B    | LTE Rear 1-g   5 mm      | 22.3                                       | 24.8                                   | 22.0               |
| 15        | SAR exposure switch for conducted power test                       | ENDC           | B66  | 1       | 1   | 132072  | 1720.0 | 1/49      | B    | LTE Edge 3 1-g   5 mm    | 18.8                                       | 25.7                                   | 18.7               |
|           |  |                | n25  | 2       | 1   | 381000  | 1905.0 | 1/53      | B    | NR Rear 1-g   5 mm       | 19.1                                       | 23.7                                   | 19.6               |
| 16        |  | Interband ULCA | B5   | 2       | 1   | 20525   | 836.5  | 1/25      | B    | LTE Front 1-g   5 mm     | 24.2                                       | 24.7                                   | 24.3               |
|           |  |                | B66  | 1       | 1   | 132072  | 1720.0 | 1/49      | B    | LTE Edge 3 1-g   5 mm    | 18.8                                       | 25.7                                   | 18.7               |

<sup>1</sup> Lists the target power without manufacturer tolerance (uncertainty) per specified configuration.

<sup>24</sup> The call drop/re-establish, or technology/band/antenna switch, or DSI switch is manually performed when the transmission power of the EUT is at  $P_{reserve}$  level. See §3.3 for the detailed test procedure of call drop test, technology/band/antenna switch test, and DSI switch test.

<sup>25</sup> The device uncertainty of  $P_{max}$  is +1 dBm/-1 dBm as provided by manufacturer.

### 6.3. Time-varying Transmission Power Measurement Results

The measurement setups are shown in Figures 7-1(a) and 7-1(c). The purpose of the time-varying transmission power measurement is to demonstrate the effectiveness of power limiting enforcement and that the time-averaged transmission power, when represented in time-averaged 1g SAR values, do not exceed FCC limit as shown in Eq. (1a) and (1b), rewritten below:

$$1g \text{ or } 10g \text{ SAR}(t) = \frac{\text{conducted Tx power}(t)}{\text{conducted Tx power } P_{limit}} * 1g \text{ or } 10g \text{ SAR } P_{limit} \quad (1a)$$

$$\frac{\frac{1}{T_{SAR}} \int_{t-T_{SAR}}^t 1g \text{ or } 10g \text{ SAR}(t) dt}{FCC \text{ SAR limit}} \leq 1 \quad (1b)$$

where *conducted Tx power(t)*, *conducted Tx power  $P_{limit}$* , and *1gSAR  $P_{limit}$*  correspond to the measured instantaneous conducted transmission power, measured conducted Tx power at  $P_{limit}$ , and measured 1g SAR values at  $P_{limit}$  reported in the Part 1 test (listed in Table 5-2 of this report as well).

Following the test procedure in §3.3, the conducted transmission power measurement for all selected configurations is reported in this section. In all the conducted transmission power plots, the dotted line represents the requested power by callbox (test sequence 1 or test sequence 2), the blue curve represents the instantaneous conducted transmission power measured using the power meter, the green curve represents time-averaged power, and the red line represents the conducted power limit that corresponds to FCC limit of 1.6 W/kg for 1g SAR.

Similarly, in all the 1gSAR plots (when converted using Eq. (1a)), the green curve represents the 100/60 seconds-time averaged 1g SAR value calculated based on the instantaneous 1g SAR; the red line limit represents the FCC limit of 1.6 W/kg for 1g SAR.

Time-varying transmission power measurements were conducted on test cases 1 through 10 in Table 5-2, by generating test sequence 1 and test sequence 2 given in Appendix A using measured  $P_{limit}$  and measured  $P_{max}$  (last columns of Table 6-1) for each of these test cases. Measurement results for test cases 1 through 10 are given in §6.3.1 through §6.3.10.

### 6.3.1. GPRS PCS Antenna 2 (Test case 1 in Table 5-2)

Test results for Test Sequence 1:

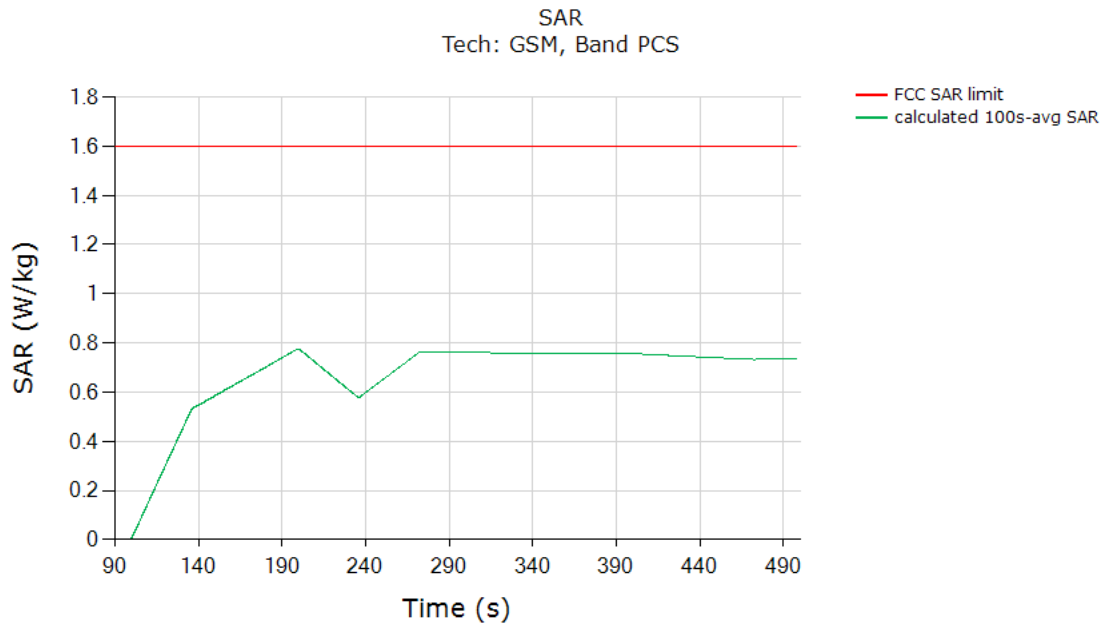

|  |        |
|--|--------|
|  | (W/kg) |
| FCC 1g SAR limit   | 1.6    |
| Max 100 seconds-time averaged 1g SAR (green curve)   | 0.776  |
| Validated: Max time averaged SAR (green curve) is within -0.132 dB device uncertainty of measured SAR at $P_{limit}$ (last column in Table 5-2). |        |

Test Result for Test Sequence 2:

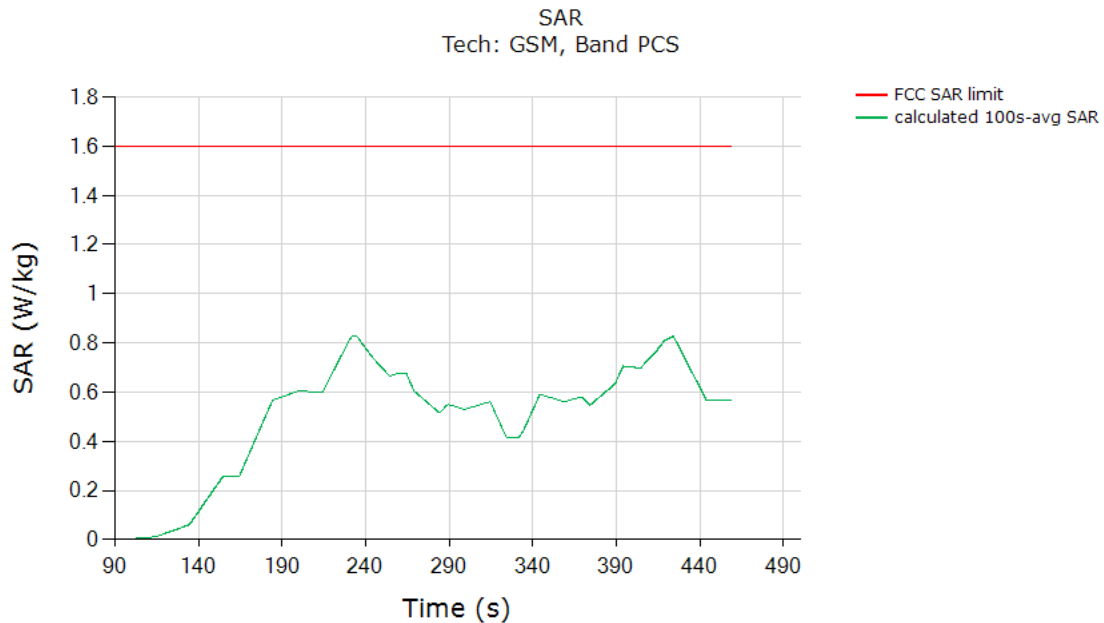

|   |        |
|---|--------|
|   | (W/kg) |
| FCC 1g SAR limit  | 1.6    |
| Max 100 seconds-time averaged 1g SAR (green curve)  | 0.830  |
| Validated: Max time averaged SAR (green curve) is within 0.160 dB device uncertainty of measured SAR at $P_{limit}$ (last column in Table 5-2). |        |

### 6.3.2. GPRS PCS Antenna 1 (Test case 2 in Table 5-2)

Test results for Test Sequence 1:

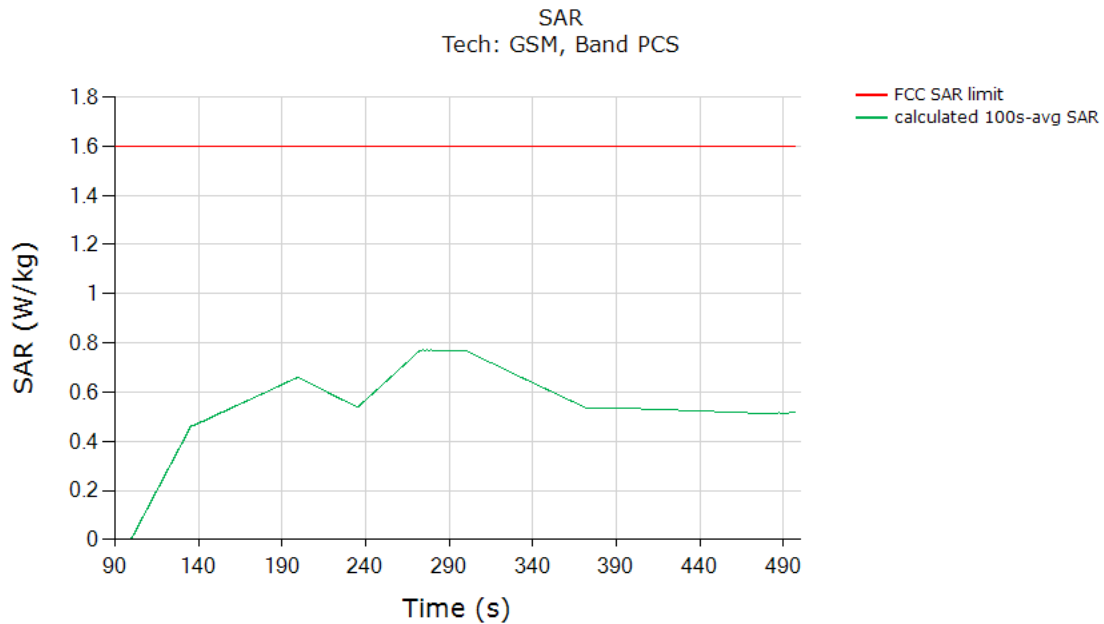

|  |        |
|--|--------|
|  | (W/kg) |
| FCC 1g SAR limit   | 1.6    |
| Max 100 seconds-time averaged 1g SAR (green curve)   | 0.771  |
| Validated: Max time averaged SAR (green curve) is within -0.162 dB device uncertainty of measured SAR at $P_{limit}$ (last column in Table 5-2). |        |

Test Result for Test Sequence 2:

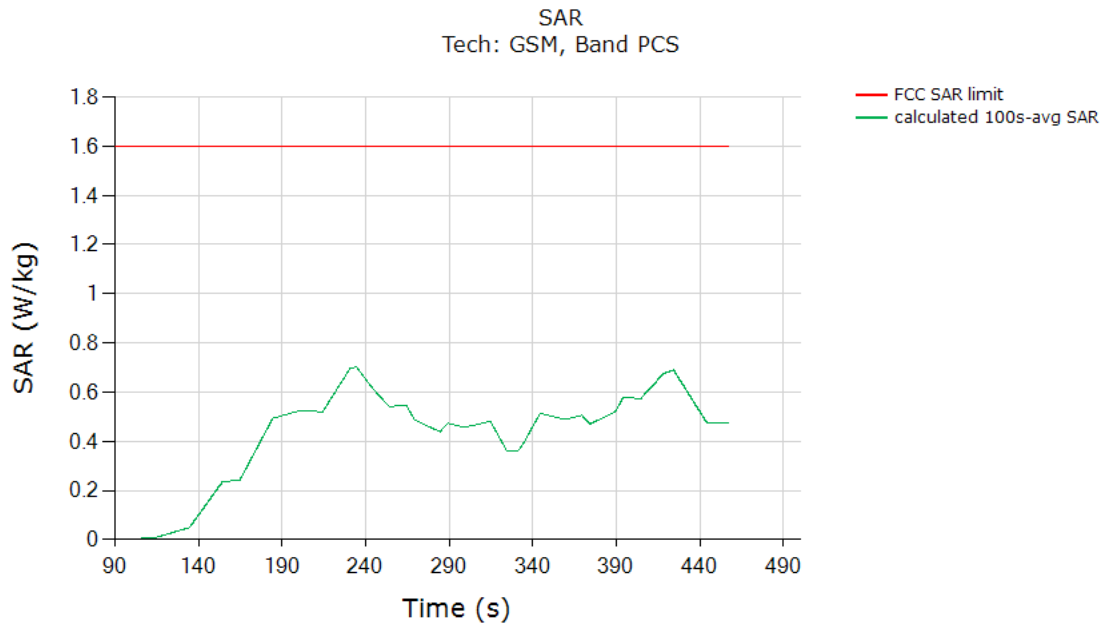

|  |        |
|--|--------|
|  | (W/kg) |
| FCC 1g SAR limit   | 1.6    |
| Max 100 seconds-time averaged 1g SAR (green curve)   | 0.702  |
| Validated: Max time averaged SAR (green curve) is within -0.567 dB device uncertainty of measured SAR at $P_{limit}$ (last column in Table 5-2). |        |

### 6.3.3. W-CDMA Band IV Antenna 1 (Test Case 3 in Table 5-2)

Test Result for Test Sequence 1:

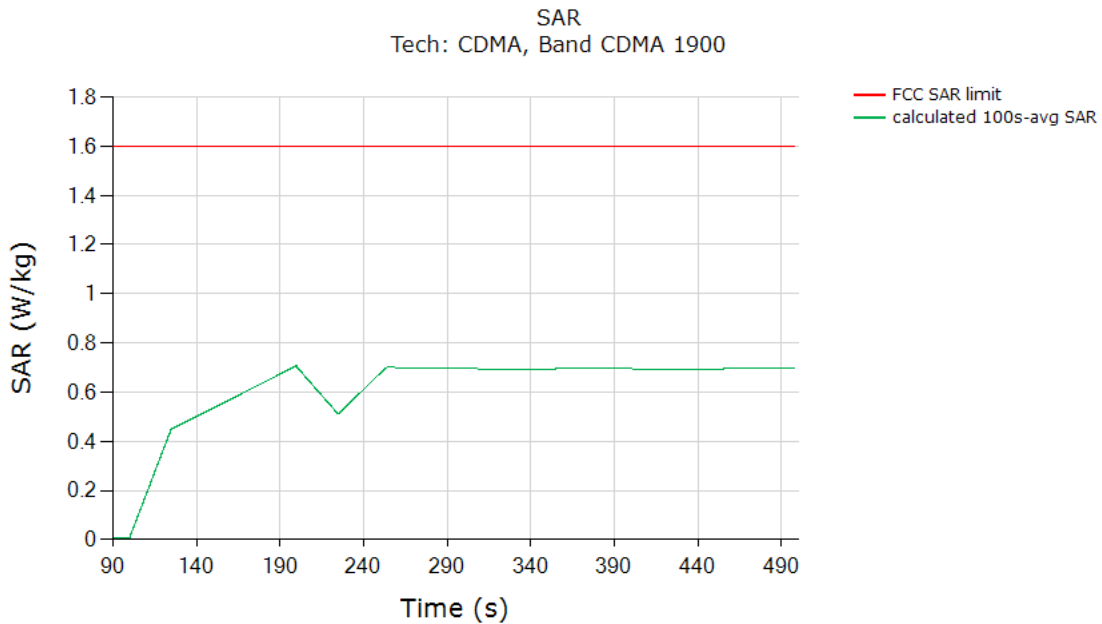

|  |        |
|--|--------|
|  | (W/kg) |
| FCC 1g SAR limit   | 1.6    |
| Max 100 seconds-time averaged 1g SAR (green curve)   | 0.707  |
| Validated: Max time averaged SAR (green curve) is within -0.538 dB device uncertainty of measured SAR at $P_{limit}$ (last column in Table 5-2). |        |

Test Result for Test Sequence 2:

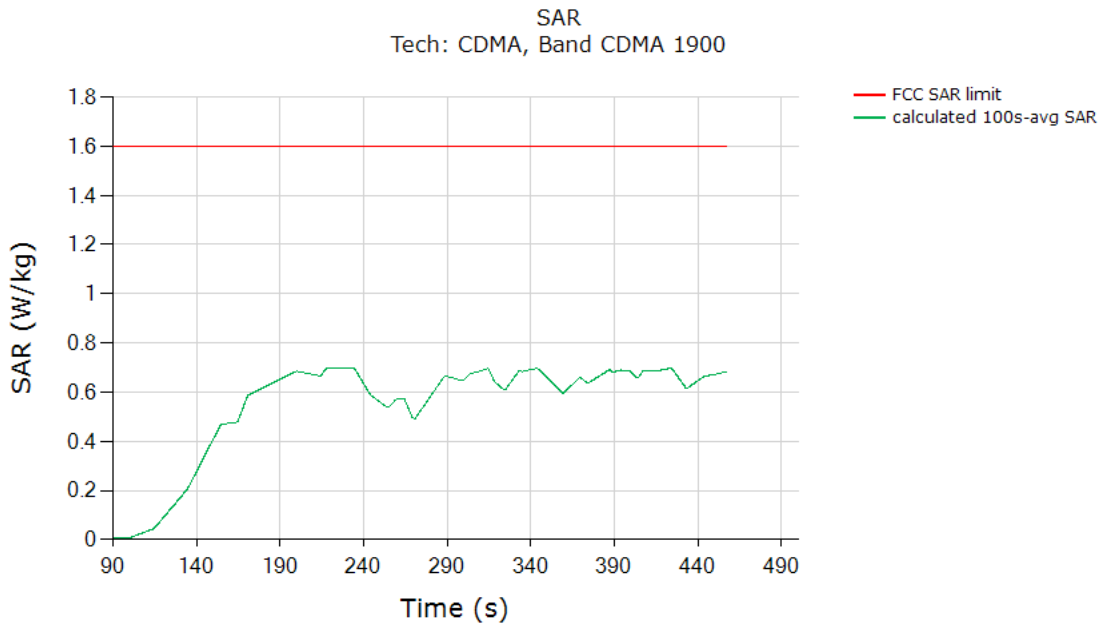

|  |        |
|--|--------|
|  | (W/kg) |
| FCC 1g SAR limit   | 1.6    |
| Max 100 seconds-time averaged 1g SAR (green curve)   | 0.698  |
| Validated: Max time averaged SAR (green curve) is within -0.594 dB device uncertainty of measured SAR at $P_{limit}$ (last column in Table 5-2). |        |



### 6.3.4. W-CDMA Band IV Antenna 3 (Test Case 4 in Table 5-2)

Test results for Test Sequence 1:

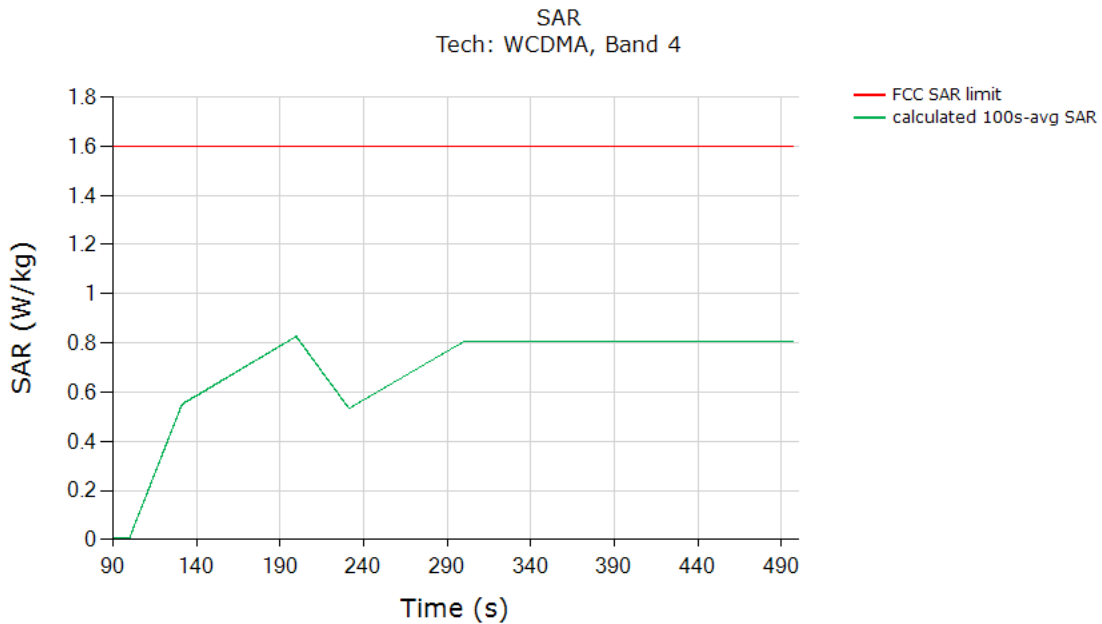

|  |        |
|--|--------|
|  | (W/kg) |
| FCC 1g SAR limit   | 1.6    |
| Max 100 seconds-time averaged 1g SAR (green curve)   | 0.826  |
| <i>Validated:</i> Max time averaged SAR (green curve) is within 0.141 dB device uncertainty of measured SAR at $P_{limit}$ (last column in Table 5-2). |        |

Test Result for Test Sequence 2:

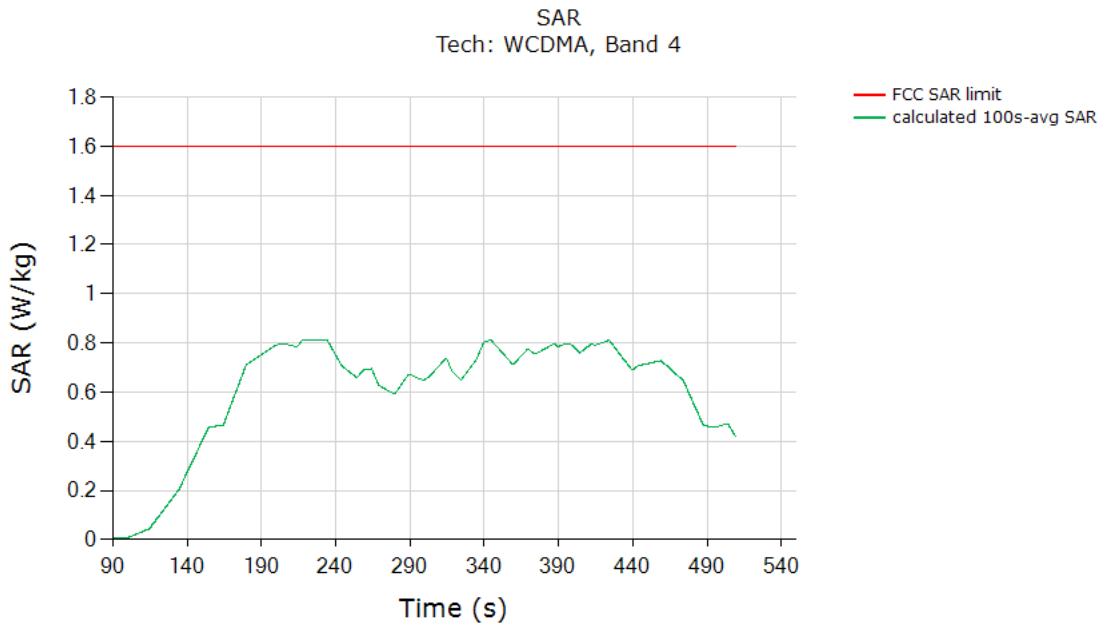

|  |        |
|--|--------|
|  | (W/kg) |
| FCC 1g SAR limit   | 1.6    |
| Max 100 seconds-time averaged 1g SAR (green curve)   | 0.813  |
| <i>Validated:</i> Max time averaged SAR (green curve) is within 0.068 dB device uncertainty of measured SAR at $P_{limit}$ (last column in Table 5-2). |        |

### 6.3.5. CDMA BC1 Antenna 2 (Test Case 5 in Table 5-2)

Test results for Test Sequence 1:

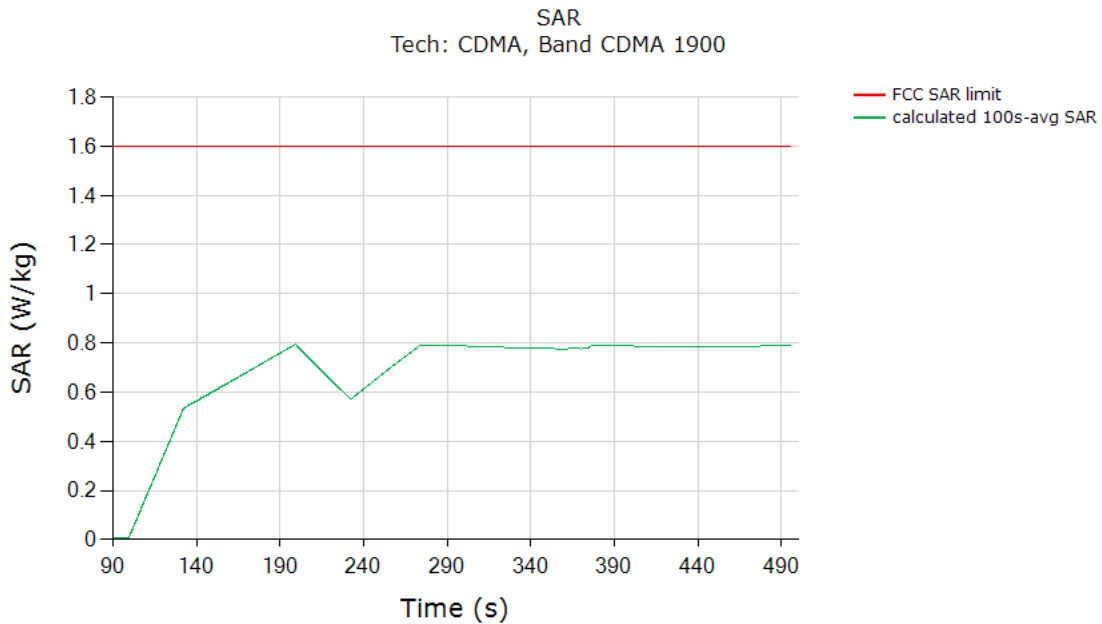

|  |        |
|--|--------|
|  | (W/kg) |
| FCC 1g SAR limit   | 1.6    |
| Max 100 seconds-time averaged 1g SAR (green curve)   | 0.795  |
| Validated: Max time averaged SAR (green curve) is within -0.028 dB device uncertainty of measured SAR at $P_{limit}$ (last column in Table 5-2). |        |

Test Result for Test Sequence 2:

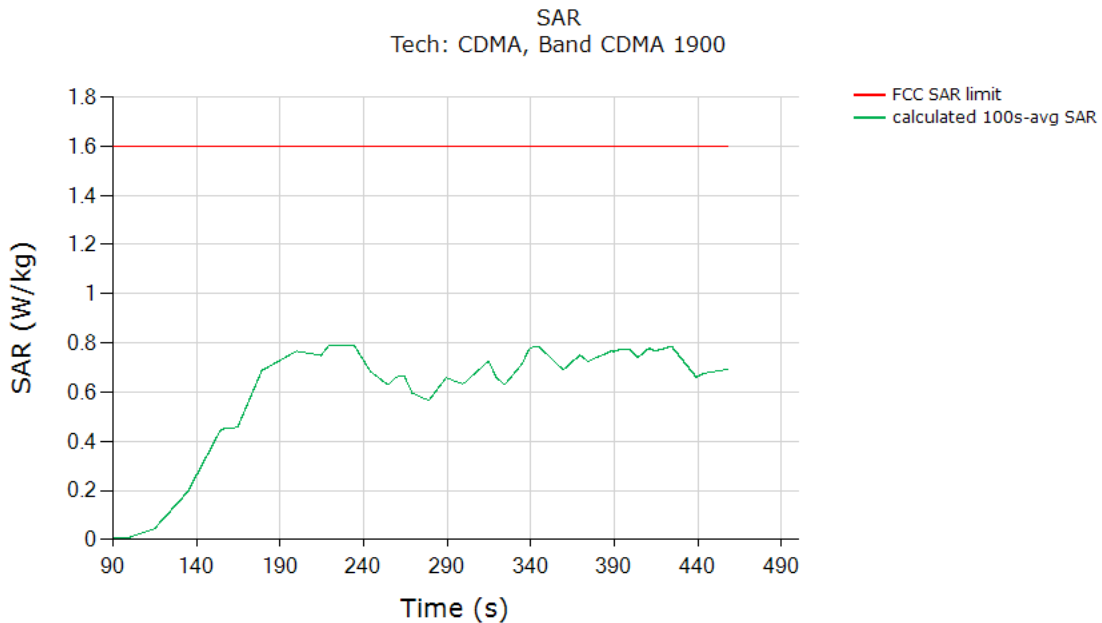

|  |        |
|--|--------|
|  | (W/kg) |
| FCC 1g SAR limit   | 1.6    |
| Max 100 seconds-time averaged 1g SAR (green curve)   | 0.789  |
| Validated: Max time averaged SAR (green curve) is within -0.061 dB device uncertainty of measured SAR at $P_{limit}$ (last column in Table 5-2). |        |

### 6.3.6. CDMA BC1 Antenna 1 (Test Case 6 in Table 5-2)

Test results for Test Sequence 1:

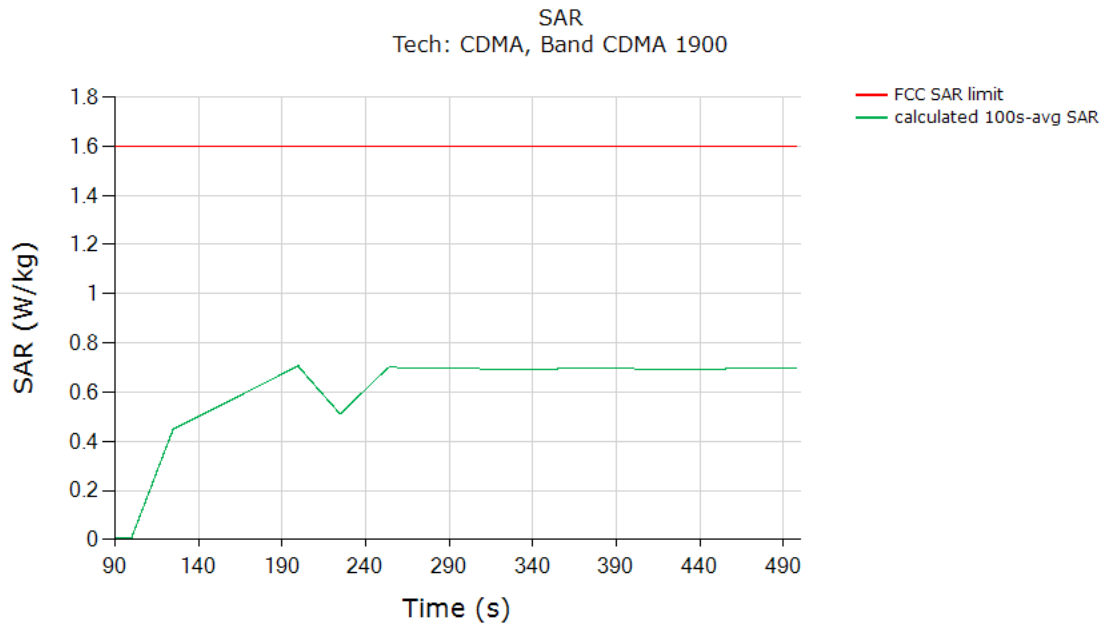

|  |        |
|--|--------|
|  | (W/kg) |
| FCC 1g SAR limit   | 1.6    |
| Max 100 seconds-time averaged 1g SAR (green curve)   | 0.707  |
| Validated: Max time averaged SAR (green curve) is within -0.538 dB device uncertainty of measured SAR at $P_{limit}$ (last column in Table 5-2). |        |

Test Result for Test Sequence 2:

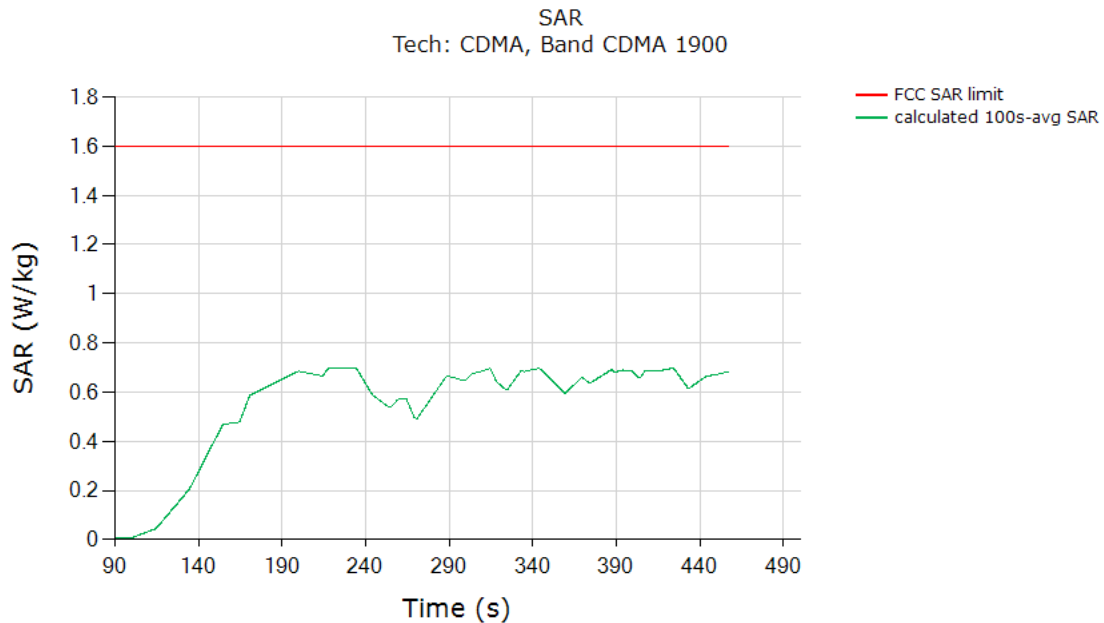

|  |        |
|--|--------|
|  | (W/kg) |
| FCC 1g SAR limit   | 1.6    |
| Max 100 seconds-time averaged 1g SAR (green curve)   | 0.698  |
| Validated: Max time averaged SAR (green curve) is within -0.594 dB device uncertainty of measured SAR at $P_{limit}$ (last column in Table 5-2). |        |

### 6.3.7. LTE Band 66 Antenna 1 (Test Case 7 in Table 5-2)

Test results for Test Sequence 1:

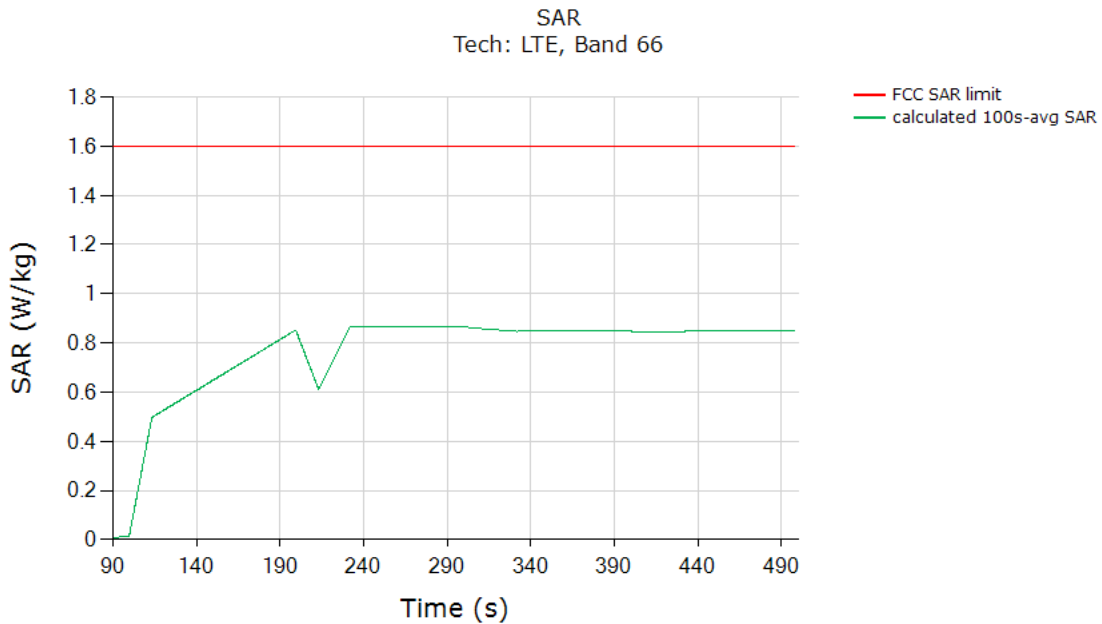

|  |        |
|--|--------|
|  | (W/kg) |
| FCC 1g SAR limit   | 1.6    |
| Max 100 seconds-time averaged 1g SAR (green curve)   | 0.868  |
| <i>Validated:</i> Max time averaged SAR (green curve) is within 0.355 dB device uncertainty of measured SAR at $P_{limit}$ (last column in Table 5-2). |        |

Test Result for Test Sequence 2:

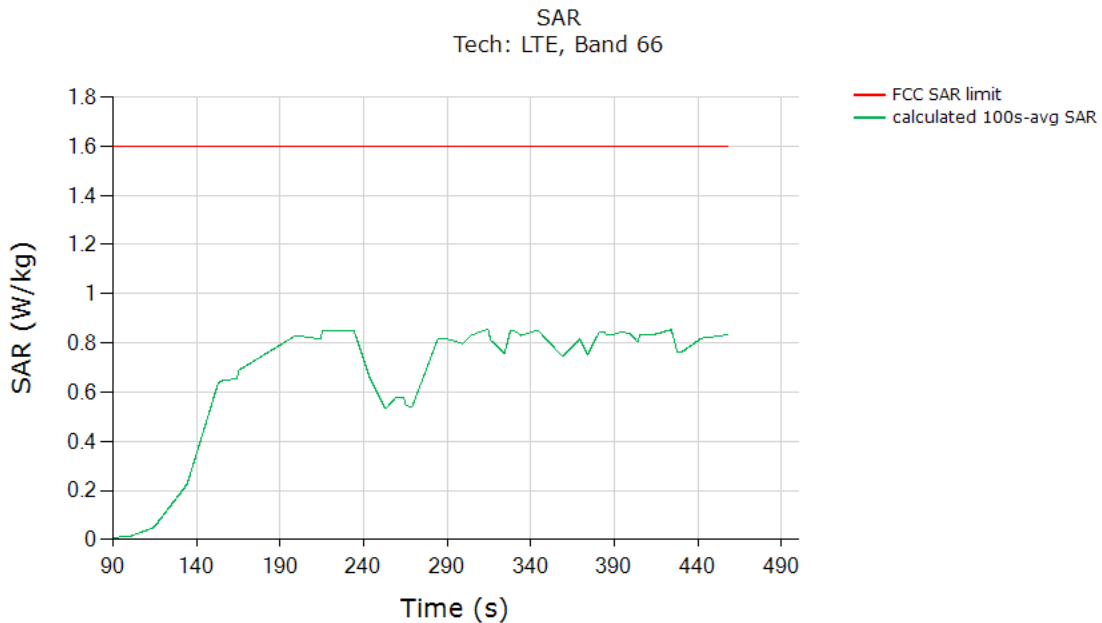

|  |        |
|--|--------|
|  | (W/kg) |
| FCC 1g SAR limit   | 1.6    |
| Max 100 seconds-time averaged 1g SAR (green curve)   | 0.855  |
| <i>Validated:</i> Max time averaged SAR (green curve) is within 0.290 dB device uncertainty of measured SAR at $P_{limit}$ (last column in Table 5-2). |        |

### 6.3.8. LTE Band 25 Antenna 1 (Test Case 8 in Table 5-2)

Test results for Test Sequence 1:

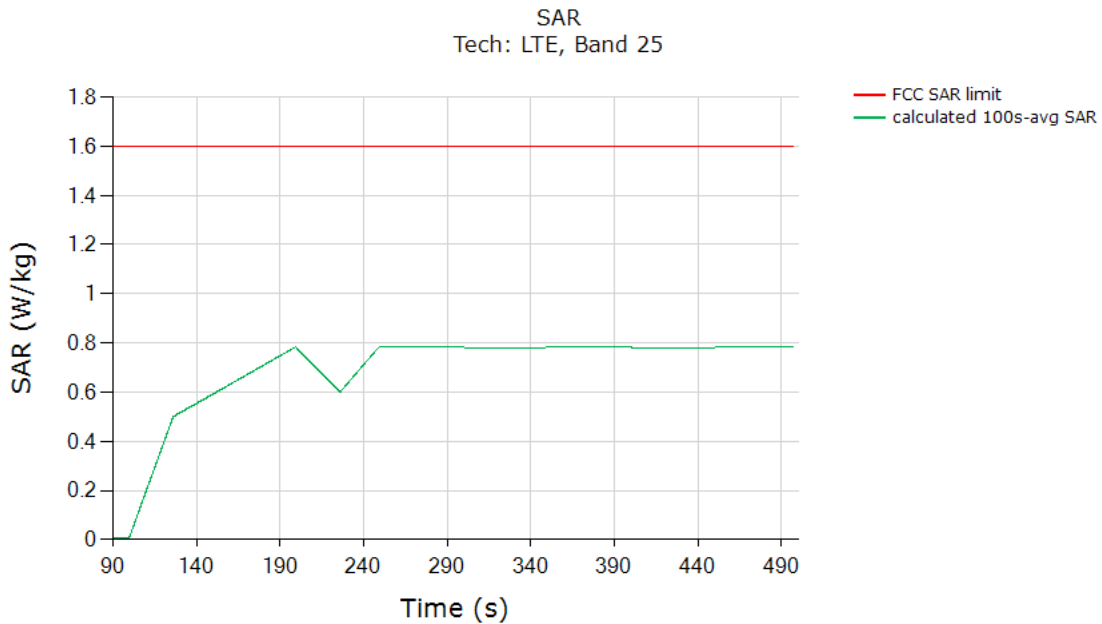

|  |        |
|--|--------|
|  | (W/kg) |
| FCC 1g SAR limit   | 1.6    |
| Max 100 seconds-time averaged 1g SAR (green curve)   | 0.784  |
| Validated: Max time averaged SAR (green curve) is within -0.087 dB device uncertainty of measured SAR at $P_{limit}$ (last column in Table 5-2). |        |

Test Result for Test Sequence 2:

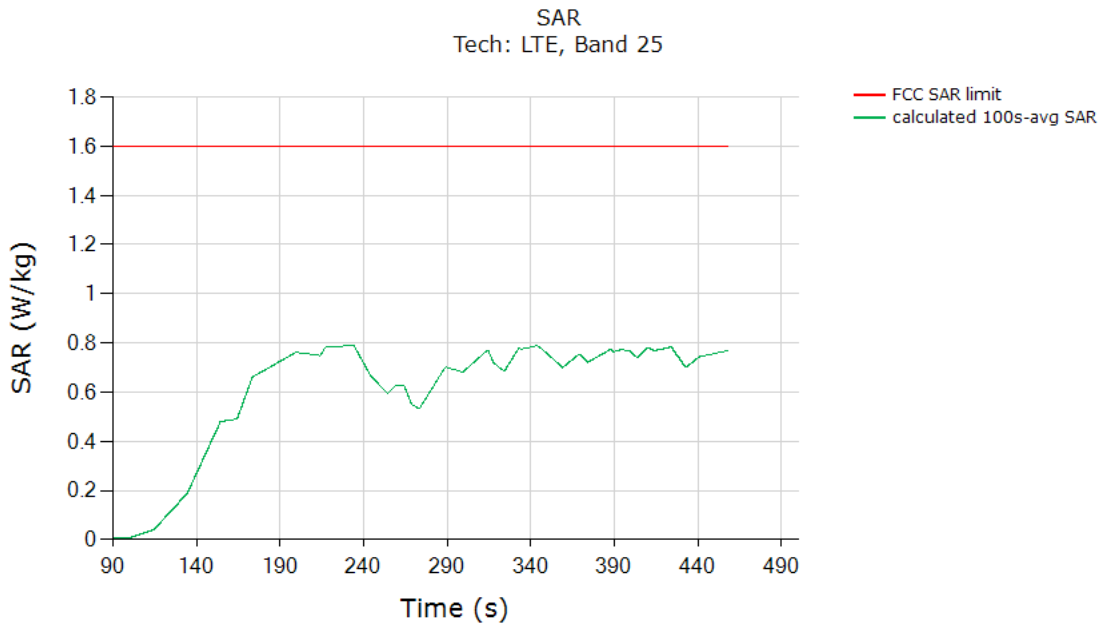

|  |        |
|--|--------|
|  | (W/kg) |
| FCC 1g SAR limit   | 1.6    |
| Max 100 seconds-time averaged 1g SAR (green curve)   | 0.789  |
| Validated: Max time averaged SAR (green curve) is within -0.059 dB device uncertainty of measured SAR at $P_{limit}$ (last column in Table 5-2). |        |

### 6.3.9. NR Band n66 Antenna 1 (Test Case 9 in Table 5-2)

Test results for Test Sequence 1:

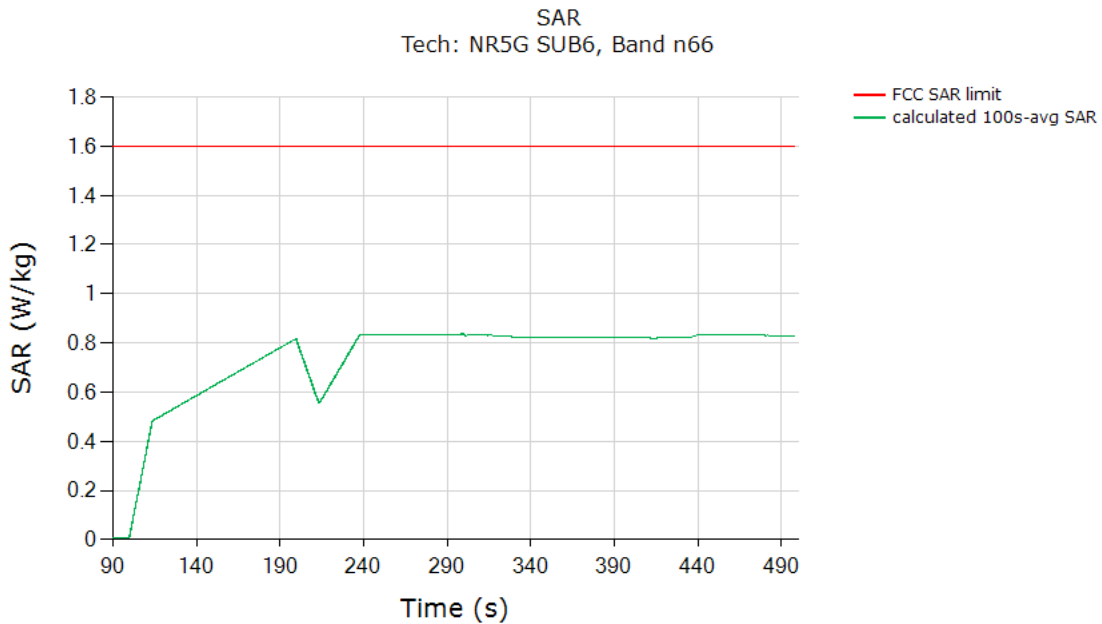

|   |        |
|---|--------|
|   | (W/kg) |
| FCC 1g SAR limit  | 1.6    |
| Max 100 seconds-time averaged 1g SAR (green curve)  | 0.836  |
| Validated: Max time averaged SAR (green curve) is within 0.189 dB device uncertainty of measured SAR at $P_{limit}$ (last column in Table 5-2). |        |

Test Result for Test Sequence 2:

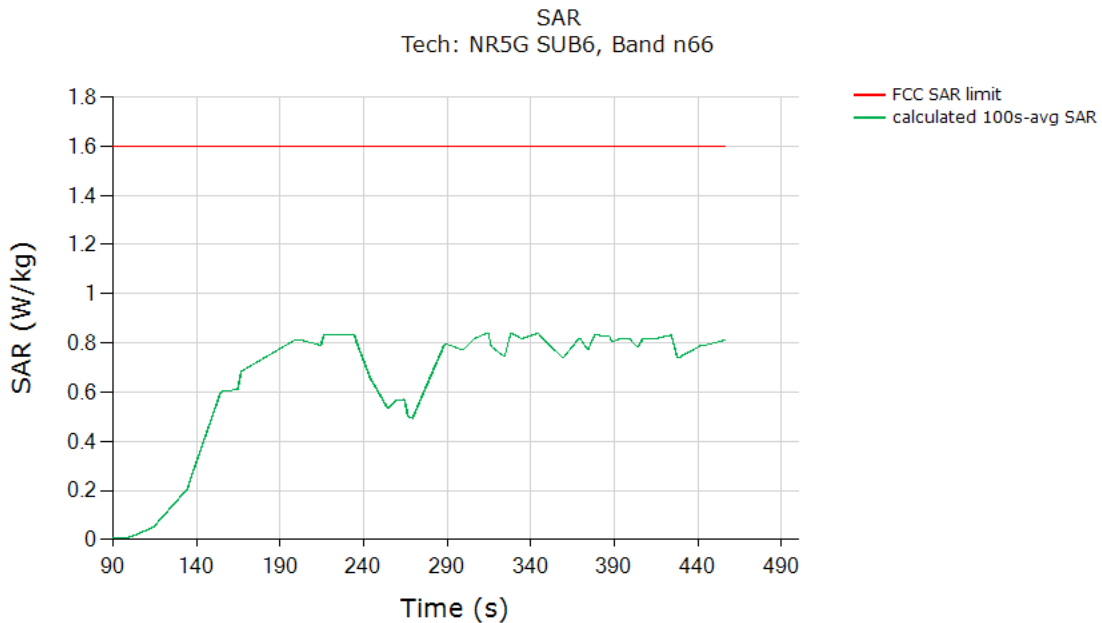

|   |        |
|---|--------|
|   | (W/kg) |
| FCC 1g SAR limit  | 1.6    |
| Max 100 seconds-time averaged 1g SAR (green curve)  | 0.840  |
| Validated: Max time averaged SAR (green curve) is within 0.211 dB device uncertainty of measured SAR at $P_{limit}$ (last column in Table 5-2). |        |

### 6.3.10. NR Band n25 Antenna 1 (Test Case 10 in Table 5-2)

Test results for Test Sequence 1:

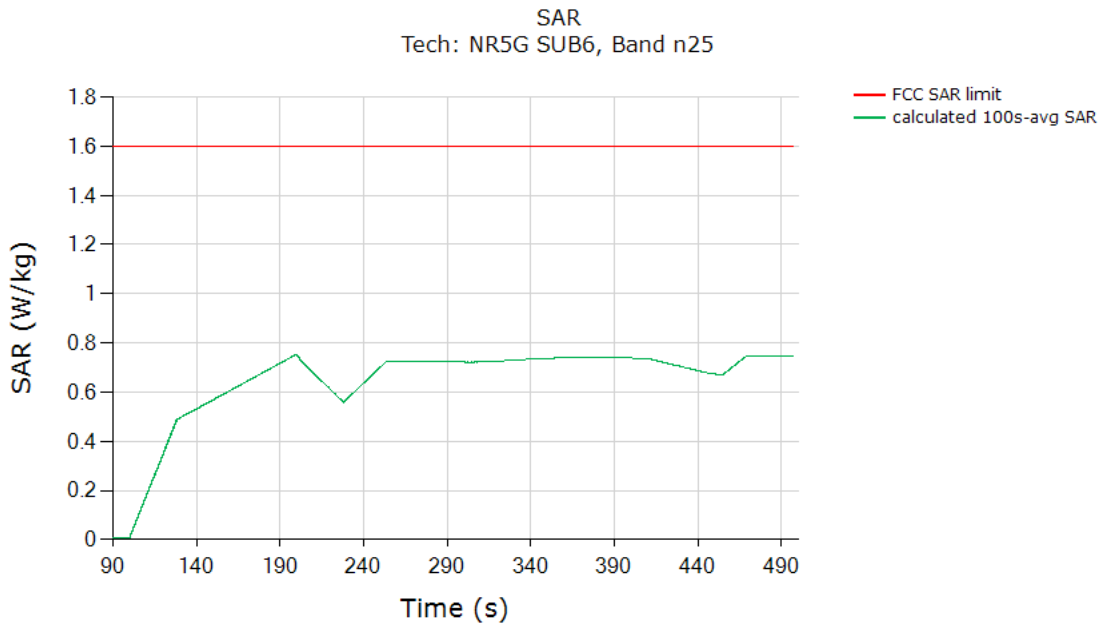

|  |        |
|--|--------|
|  | (W/kg) |
| FCC 1g SAR limit   | 1.6    |
| Max 100 seconds-time averaged 1g SAR (green curve)   | 0.752  |
| Validated: Max time averaged SAR (green curve) is within -0.268 dB device uncertainty of measured SAR at $P_{limit}$ (last column in Table 5-2). |        |

Test results for Test Sequence 2:

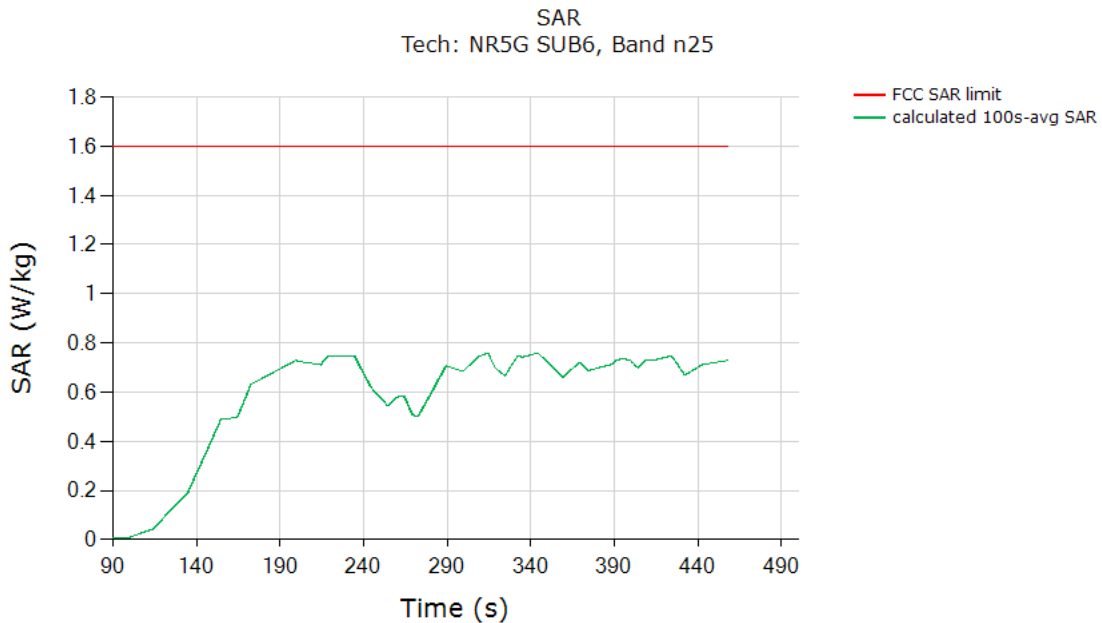

|  |        |
|--|--------|
|  | (W/kg) |
| FCC 1g SAR limit   | 1.6    |
| Max 100 seconds-time averaged 1g SAR (green curve)   | 0.758  |
| Validated: Max time averaged SAR (green curve) is within -0.234 dB device uncertainty of measured SAR at $P_{limit}$ (last column in Table 5-2). |        |

### 6.4. Change in Call Test Results (Test Case 11 in Table 5-2)

This test was measured with LTE 66, Antenna 01, DSI state 01, and with callbox requesting maximum power. The call drop was manually performed at ~125 seconds into the test when the EUT is transmitting at  $P_{reserve}$ . The measurement setup is shown in Figure 6-1(a) and (c). The detailed test procedure is described in §3.3.2.

Time-averaged conducted transmission power is converted/calculated into time-averaged 1g SAR using Equation (1a) and plotted below to demonstrate that the time-averaged 1g SAR versus time does not exceed the FCC limit of 1.6 W/kg for 1g SAR, respectively:

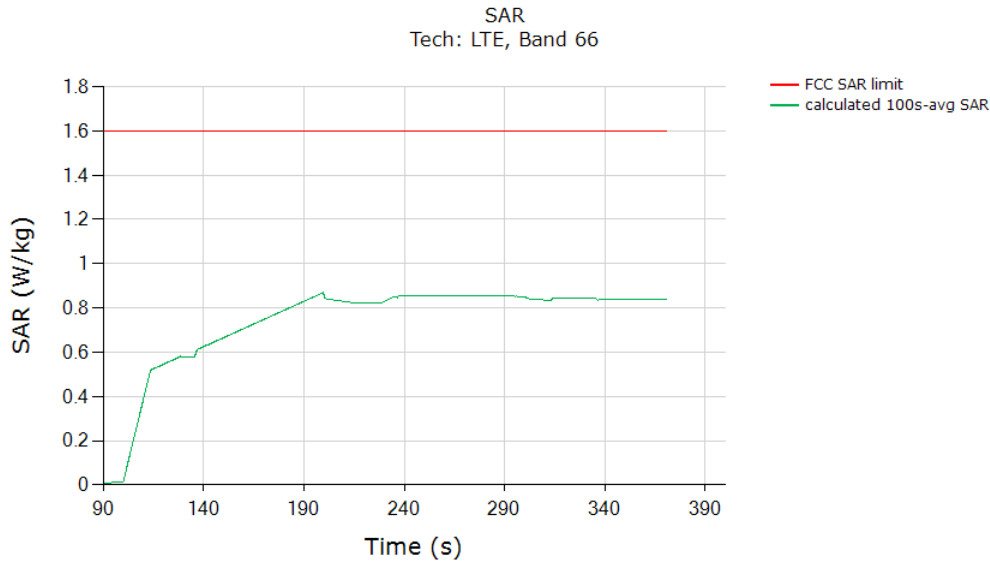

|  | (W/kg) |
|--|--------|
| FCC 1g SAR limit                                   | 1.6    |
| Max 100 seconds-time averaged 1g SAR (green curve) | 0.869  |
| <b>Validated</b>                                   |        |

The test result validated the continuity of power limiting in the call change scenario.



### 6.5. Change in Technology/Band Test Results (Test Case 12 in Table 5-2)

This test was conducted with the callbox requesting maximum power and with an antenna and technology switch from W-CDMA IV, Antenna 3, DSI state 1 to LTE 66, Antenna 3, DSI state 1. Following the procedure detailed in §3.3.3 and using the measurement setup shown in Figure 6-1(a) and (c), the technology/band switch was performed when the EUT is transmitting at  $P_{reserve}$  level ~145 seconds into the test.

Test Result for Change in Technology/Band:

All the time-averaged conducted transmission power measurement results were converted into time-averaged normalized SAR values using Equation (6a), (6b) and (6c), and plotted below to demonstrate that the time-averaged normalized SAR versus time does not exceed the normalized FCC limit of 1.0:

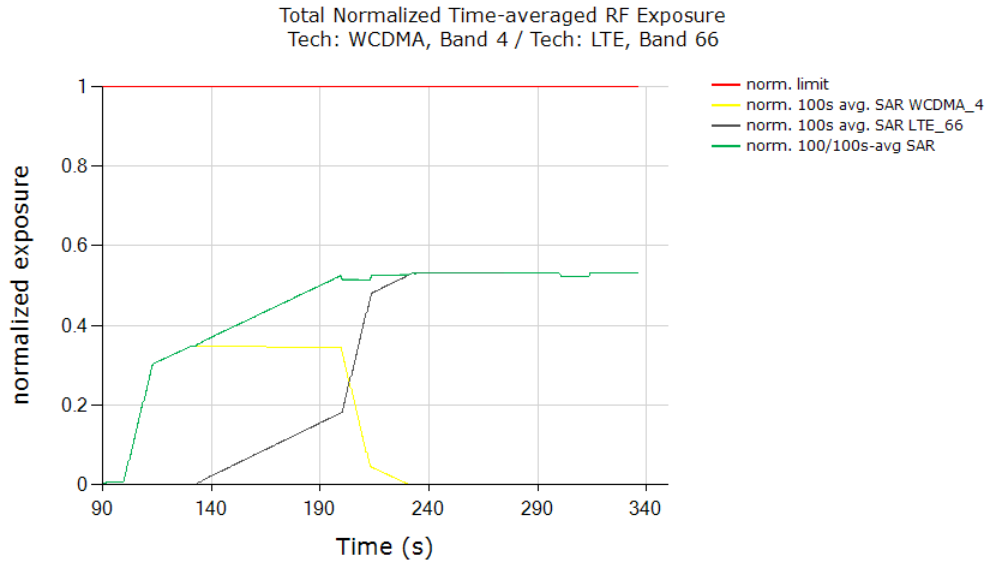

|  |        |
|--|--------|
|  | (W/kg) |
| FCC normalized SAR limit                           | 1.0    |
| Max 100 seconds-time averaged 1g SAR (green curve) | 0.533  |
| Validated  |        |

The test result validated the continuity of power limiting in technology/band switch scenario.

### 6.6. Change in DSI Test Results (Test Case 13 in Table 5-2)

This test was conducted with the callbox requesting maximum power, and with the DSI switching states. Following the procedure detailed in §3.3.5 using the measurement setup shown in Figure 6-1(a) and (c), the DSI switch was performed when the EUT is transmitting at  $P_{reserve}$  level ~145 seconds into the test.

Test Result for Change in DSI:

All the time-averaged conducted transmission power measurement results were converted into time-averaged normalized SAR values using Equation (6a), (6b) and (6c), and plotted below to demonstrate that the time-averaged normalized SAR versus time does not exceed the normalized FCC limit of 1.0:

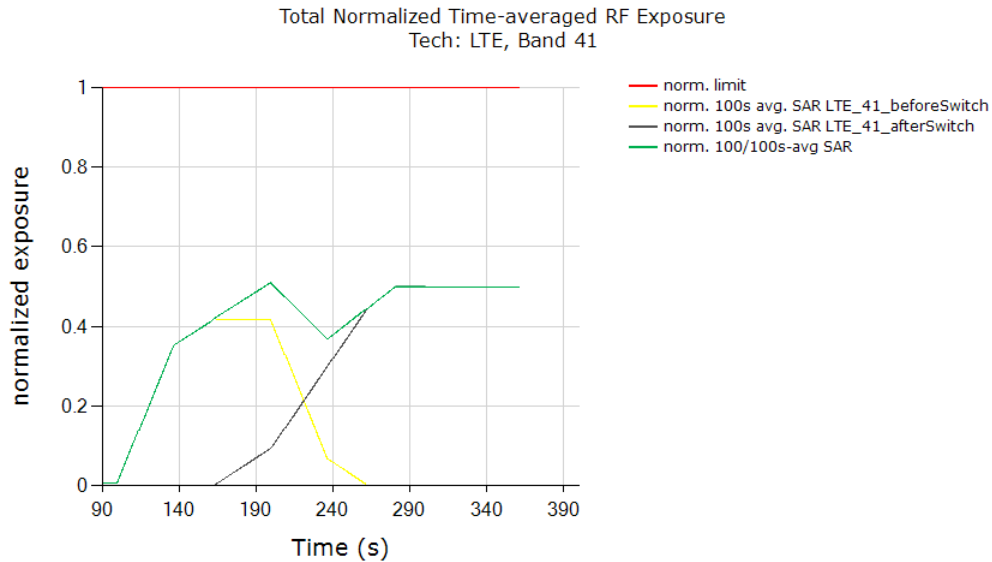

|  |        |
|--|--------|
|  | (W/kg) |
| FCC normalized SAR limit                           | 1.0    |
| Max 100 seconds-time averaged 1g SAR (green curve) | 0.510  |
| <b>Validated</b>                                   |        |

The test result validated the continuity of power limiting in technology/band switch scenario.

### 6.7. Change in Time Window/Antenna Switch Test Results (Test Case 14 in Table 5-2)

This test was conducted with the callbox requesting maximum power and with time-window/antenna switch between LTE 25, Antenna 1, DSI = 1 (100 seconds window) and LTE 48, Antenna 7, DSI = 1 (60 seconds window). Following the procedure detailed in §3.3.6 and using the measurement setup shown in Figure 6-1(b) and (d), the time-window switch via tech/band/antenna switch was performed when the EUT is transmitting at  $P_{reserve}$  level.

#### 6.7.1. Transition from LTE 48 to LTE 66 (i.e., 60 seconds to 100 seconds), then Back to LTE 48

Test Result for Change in Time Window (from 60 seconds to 100 seconds to 60 seconds):

All the conducted transmission power measurement results were converted into time-averaged normalized SAR values using Equation (7a), (7b) and (7c) and plotted below to demonstrate that the time-averaged normalized SAR versus time does not exceed the FCC limit of 1 unit. Equation (7a) is used to convert the transmission power of the device to obtain the 60 seconds-averaged normalized SAR for LTE 48 as shown with the black curve. Similarly, equation (7b) is used to obtain the 100 seconds-averaged normalized SAR for LTE 66 as shown with the orange curve. Equation (7c) is used to obtain the total time-averaged normalized SAR as shown with the green curve (i.e., the sum of both the black and orange curves).

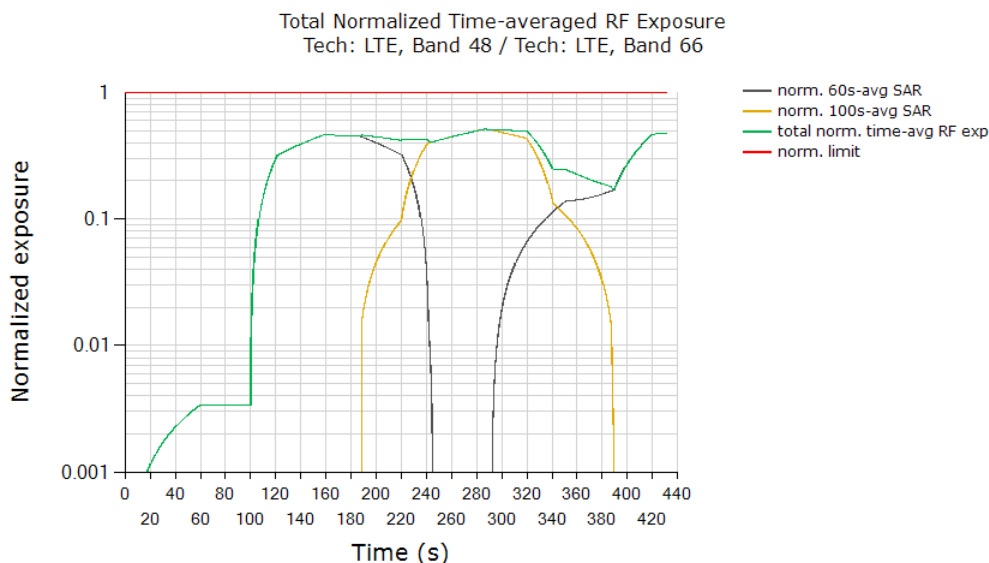

|  |        |
|--|--------|
|  | (W/kg) |
| FCC normalized SAR limit                           | 1.0    |
| Max 100 seconds-time averaged 1g SAR (green curve) | 0.521  |
| <i>Validated</i>                                   |        |

The test result validated the continuity of power limiting in technology/band switch scenario.

## 6.8. Switch in SAR Exposure Test Results

### 6.8.1. Test Case 1: EN-DC Switch between LTE 66 and NR n25 (Test Case 15 in Table 5-2)

This test was conducted with the callbox requesting maximum power and with the EUT in LTE 66 + Sub-6 GHz NR Band 25 call. Following the procedure detailed in §3.3.7 and Appendix B.2, and using the measurement setup shown in Figure 6-1(a) and (c), since LTE and Sub-6 GHz NR are sharing the same antenna port (otherwise, it should be Figure 6-1(b) and (d) for different antenna ports), the SAR exposure switch measurement is performed with the EUT in various SAR exposure scenarios, i.e., in SAR<sub>Sub-6 GHz NR</sub> only scenario (t =0s ~120s), SAR<sub>Sub-6 GHz NR</sub> + SAR<sub>LTE</sub> scenario (t =120s ~ 240s) and SAR<sub>LTE</sub> only scenario (t > 240s)

All the conducted transmission power measurement results were converted into time-averaged normalized SAR values using Equation (7a), (7b) and (7c) and plotted below to demonstrate that the time-averaged normalized SAR versus time does not exceed the FCC limit of 1 unit. Equation (7a) is used to convert the LTE transmission power of the device to obtain the 100 seconds-averaged normalized SAR in LTE 66 as shown with the black curve. Similarly, equation (7b) is used to obtain the 100 seconds-averaged normalized SAR in Sub-6 GHz NR n25 as shown with the orange curve. Equation (7c) is used to obtain the total time-averaged normalized SAR as shown with the green curve (i.e., sum of both the black and orange curves).

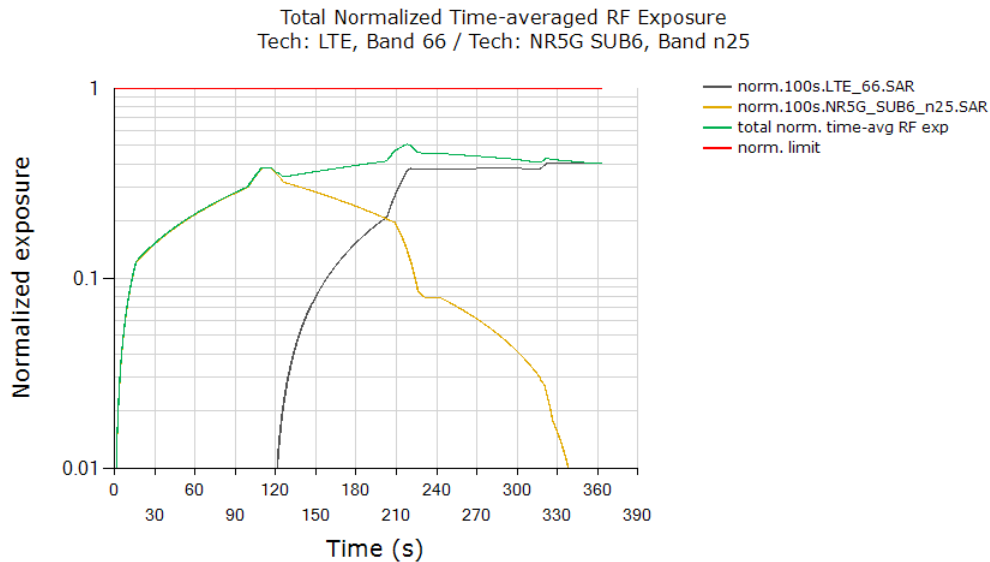

|  | (W/kg) |
|--|--------|
| FCC normalized SAR limit                           | 1.0    |
| Max 100 seconds-time averaged 1g SAR (green curve) | 0.507  |
| Validated  |        |

The test result validated the continuity of power limiting in technology/band switch scenario.

### 6.8.2. Test Case 2: Uplink CA Switch between LTE 5 Antenna 2 and LTE 66 Antenna 1 (Test Case 16 in Table 5-2)

This test was conducted with the callbox requesting maximum power and with the EUT in an LTE Uplink Carrier Aggregation call in combination CA\_5A-66A. Following the procedure detailed in §3.3.7 and Appendix B.2, and using the measurement setup shown in Figure 6-1(a) and (c), since LTE and Sub-6 GHz NR are sharing the same antenna port (otherwise, it should be Figure 6-1(b) and (d) for different antenna ports), the SAR exposure switch measurement is performed with the EUT in various SAR exposure scenarios, i.e., in SAR<sub>Sub-6 GHz NR</sub> only scenario (t =0s ~120s), SAR<sub>Sub-6 GHz NR</sub> + SAR<sub>LTE</sub> scenario (t =120s ~ 240s) and SAR<sub>LTE</sub> only scenario (t > 240s)

All the conducted transmission power measurement results were converted into time-averaged normalized SAR values using Equation (7a), (7b) and (7c) and plotted below to demonstrate that the time-averaged normalized SAR versus time does not exceed the FCC limit of 1 unit. Equation (7a) is used to convert the LTE transmission power of the device to obtain the 100 seconds-averaged normalized SAR in LTE 5 as shown with the black curve. Similarly, equation (7b) is used to obtain the 100 seconds-averaged normalized SAR in LTE 66 as shown with the orange curve. Equation (7c) is used to obtain the total time-averaged normalized SAR as shown with the green curve (i.e., sum of both the black and orange curves).

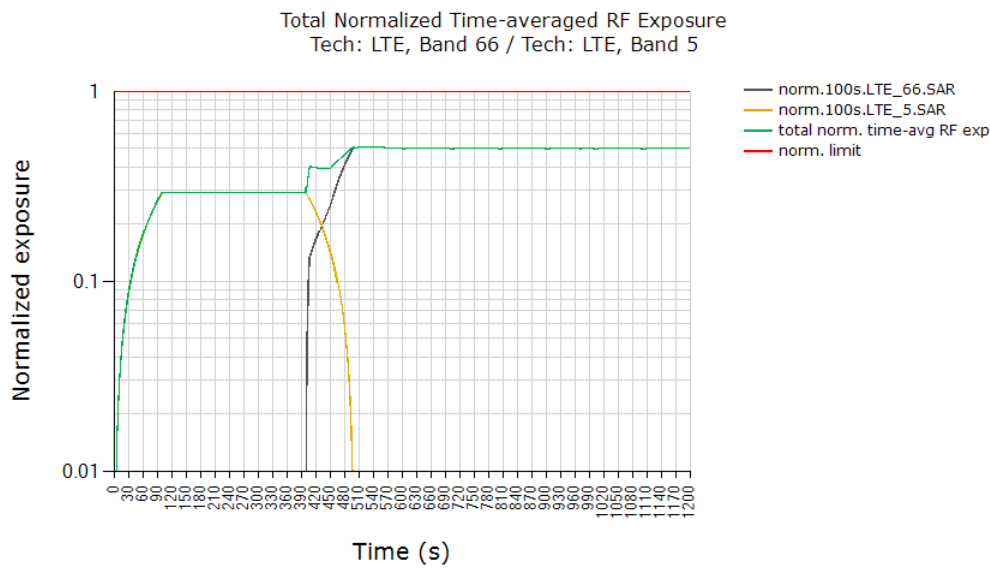

|  |        |
|--|--------|
|  | (W/kg) |
| FCC\ normalized SAR limit                          | 1.0    |
| Max 360 seconds-time averaged 1g SAR (green curve) | 0.512  |
| Validated  |        |

The test result validated the continuity of power limiting in technology/band switch scenario.

## 7. SAR Test Results for Sub-6 GHz Smart Transmit Feature Validation

Given the use of the same modem chipset as other models, test case reduction has been implemented per Qualcomm guidance. Measured SAR results shall be reused from reference model A2483 (FCC: BCG-E4000A).

## 8. Radiated Power Test Results for mmW Smart Transmit Feature Validation

### 8.1. Measurement Setup

The Keysight Technologies E7515B UXM callbox is used in this test. The test setup is shown in Figure 8-1a and the schematic of the setup is shown in Figure 8-1b (see Appendix E for missing figures). The UXM callbox has two RF radio heads to up/down convert IF to mmW frequencies, which, in turn, are connected to two horn antennas for V- and H-polarizations for downlink communication. In the uplink, a directional coupler is used in the path of one of the horn antennas to measure and record radiated power using a Rohde & Schwarz NR50S power sensor and NRP2 power meter.<sup>26</sup>

The EUT is placed inside an anechoic chamber with V- and H-pol horn antennas to establish the radio link as shown in Figure 8-1. The callbox's LTE port is directly connected to the EUT's RF port via a directional coupler to measure the EUT's conducted transmission power using a Rohde & Schwarz NR8S power sensor and NRP2 power meter. Additionally, the EUT is connected to the PC via USB connection for sending beam switch command. Care is taken to route the USB cable and RF cable (for LTE connection) away from the EUT's mmW antenna modules.

Setup in Figure 8-1 is used for the test scenario 1, 4, and 5, as described in §2. The test procedures described in §4 are followed. The path losses from the EUT to both the power meters are calibrated and used as an offset in the power meter.

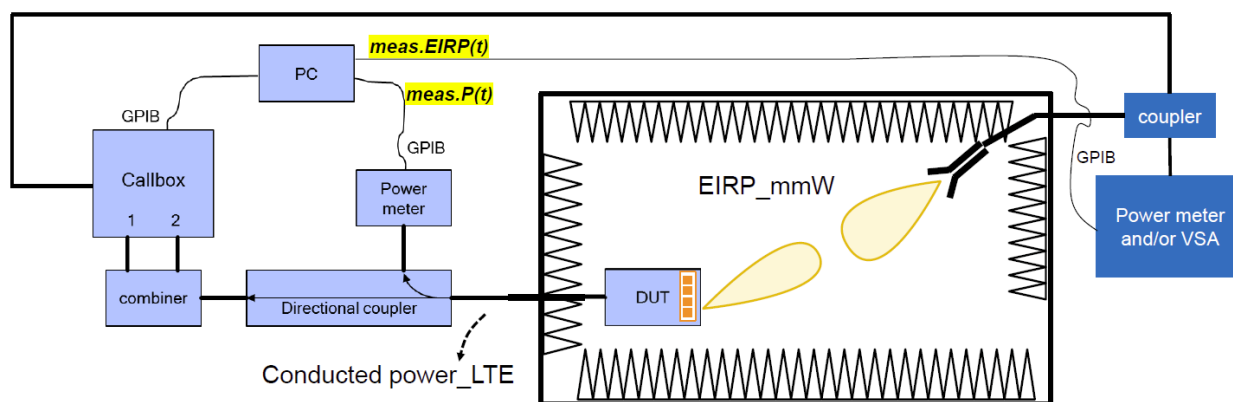

**Figure 8-1: mmW NR radiated power measurement setup (see Appendix E for missing figures)**

Both the callbox and power meters are connected to the PC using USB cables. Test scripts are custom made for automation, i.e., establishing an LTE + mmW call, conducted transmission power recording for LTE, and radiated transmission power recording for mmW. These tests are manually stopped after the desired time duration. The test script is programmed to set the LTE transmission power to all-down bits on the callbox immediately after the mmW link is established and programmed to toggle between all-up and all-down bits depending on the transmission scenario being evaluated. Similarly, the test script is also programmed to send beam switching commands manually to the EUT via a USB connection. For all the tests, the callbox is set to request maximum transmission power from the mmW NR radio from the EUT.

Test configurations for this validation are detailed in §5.2. Test procedures are listed in §4.3.

<sup>26</sup> The isolation of the directional coupler may not be sufficient to attenuate the downlink signal from the callbox, which will result in high noise floor masking the recording of radiated power from EUT. In that case, either lower the downlink signal strength emanating from the RF radio heads of the callbox or add an attenuator between the callbox radio heads and the directional coupler. Additionally, since the measurements performed in this validation are all relative, measurement of the EUT's radiated power in one polarization is sufficient.

## 8.2. mmW NR Radiated Power Test Results

To demonstrate the compliance, the conducted transmission power of LTE 66 in DSI = 1 is converted to 1g SAR exposure by applying the corresponding worst-case 1g SAR value at  $P_{limit}$ , as reported in the Part 1 report and listed in Table 5-2 of this report.

Similarly, following Step 4 in §4.3.1, radiated transmission power of mmW Band n261 and n260 for the beams tested is converted by applying the corresponding worst-case 4 cm<sup>2</sup> PD values measured in the Qualcomm lab and listed in Table 8-1. Qualcomm Smart Transmit feature operates based on the time-averaged transmission power reported on a per symbol basis, which is independent of modulation, channel, and bandwidth (RBs); therefore, the worst-case 4 cm<sup>2</sup> PD was conducted with the EUT in FTM mode, with CW modulation, and 100% duty cycle. cDASY6 system verification for power density measurement is provided in Appendix C and the associated SPEAG certificates are attached in Appendix D.

Both the worst-case 1g SAR and 4 cm<sup>2</sup> PD values used in this section are listed in Table 8-1. The measured EIRP at *input.power.limit* for the beams tested in this section are also listed in Table 8-1.

**Table 8-1: Worst-case 1g SAR, 4 cm<sup>2</sup> average PD and EIRP measured at *input.power.limit* for the selected configurations**

| mmW Transmission Scenario | Test Case | Test Scenario     | Antenna | mmW Band/ Beam | input.power.limit (dBm) | Configuration | Meas. EIRP at input.power.limit (dBm) |
|---------------------------|-----------|-------------------|---------|----------------|-------------------------|---------------|---------------------------------------|
| A                         | 4         | Max Power Test    | M2      | n258 Beam 32   | 0.6                     | Edge 2        | 12.8                                  |
| G                         | 5         | SAR vs. PD Switch |         | n258 Beam 32   | 0.6                     | Edge 2        | 12.8                                  |
| D                         | 6         | Beam Switch       |         | n258 Beam 34   | 1.4                     | Edge 2        | 13.9                                  |
|                           |           |                   |         | n258 Beam 2    | 7.5                     | Edge 2        | 10.5                                  |
| A                         | 4         | Max Power Test    | M2      | n260 Beam 34   | 1.5                     | Edge 2        | 15.1                                  |
| G                         | 5         | SAR vs. PD Switch |         | n260 Beam 34   | 1.5                     | Edge 2        | 15.1                                  |
| D                         | 6         | Beam Switch       |         | n260 Beam 33   | 1.6                     | Edge 2        | 13.9                                  |
|                           |           |                   |         | n260 Beam 2    | 7.1                     | Edge 2        | 8.2                                   |

| Test Scenario | Antenna | Band | Meas. $P_{limit}$ (dBm) | Configuration | SAR at $P_{limit}$ (W/kg) |
|---------------|---------|------|-------------------------|---------------|---------------------------|
| LTE Anchor    | 1       | 66/4 | 18.74                   | Edge 3        | 0.878                     |



### 8.2.1. Maximum Transmission Power Test Results for n258

This test was measured with LTE 66 and mmW Band n258 Beam ID 32, by following the detailed test procedure described in §4.3.1.

The time-averaged conducted transmission power for LTE 66 and radiated transmission power for mmW NR n258 Beam 32 are converted into time-averaged 1g SAR and time-averaged 4 cm<sup>2</sup> PD using Equation (2a) and (2b), which are divided by FCC 1g SAR limit of 1.6 W/kg and 4 cm<sup>2</sup> PD limit of 10 W/m<sup>2</sup>, respectively, to obtain the normalized exposures versus time. Plots show: (a) Normalized time-averaged 1g SAR versus time, (b) normalized time-averaged 4 cm<sup>2</sup>-averaged PD versus time, (c) sum of the normalized time-averaged 1g SAR and normalized time-averaged 4 cm<sup>2</sup>-averaged PD:

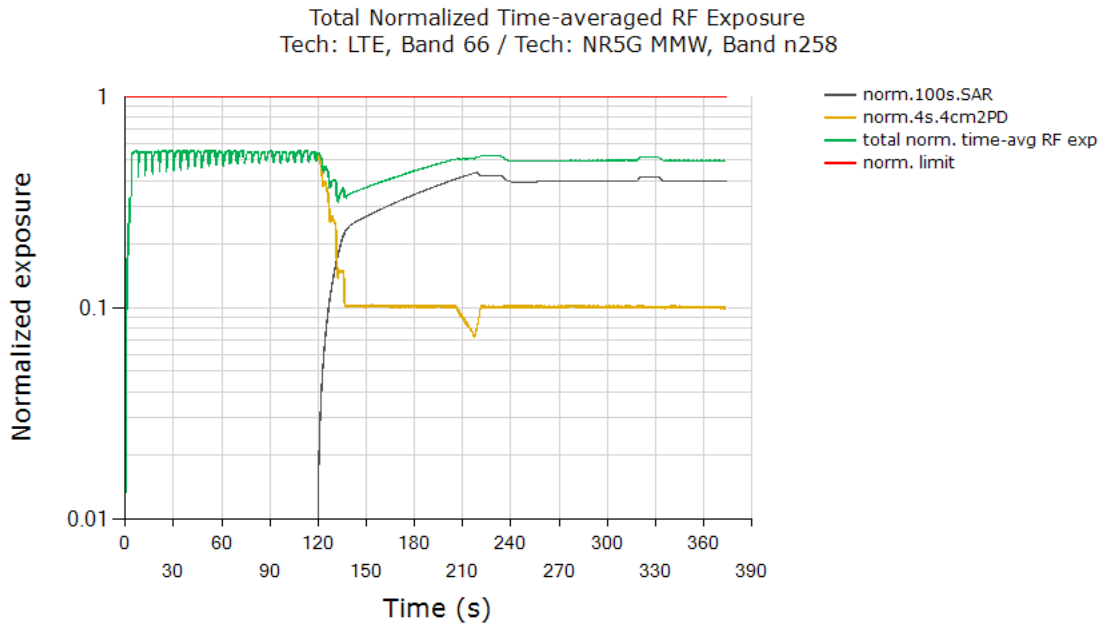

|  |       |
|--|-------|
| FCC requirement for total RF exposure (normalized)           | 1.0   |
| Max total normalized time-averaged RF exposure (green curve) | 0.560 |
| Validated  |       |

As can be seen, the power limiting enforcement is effective and the total normalized time-averaged RF exposure does not exceed 1.0. Therefore, the Smart Transmit time averaging feature is validated.

### 8.2.2. Maximum Transmission Power Test Results for n260

This test was measured with LTE 66 and mmW Band n260 Beam ID 34, by following the detailed test procedure described in §4.3.1.

The time-averaged conducted transmission power for LTE 66 and radiated transmission power for mmW NR n260 Beam 34 are converted into time-averaged 1g SAR and time-averaged 4 cm<sup>2</sup> PD using Equation (2a) and (2b), which are divided by FCC 1g SAR limit of 1.6 W/kg and 4 cm<sup>2</sup> PD limit of 10 W/m<sup>2</sup>, respectively, to obtain the normalized exposures versus time. Plots show: (a) Normalized time-averaged 1g SAR versus time, (b) normalized time-averaged 4 cm<sup>2</sup>-avergeraged PD versus time, (c) sum of the normalized time-averaged 1g SAR and normalized time-averaged 4 cm<sup>2</sup>-avergeraged PD:

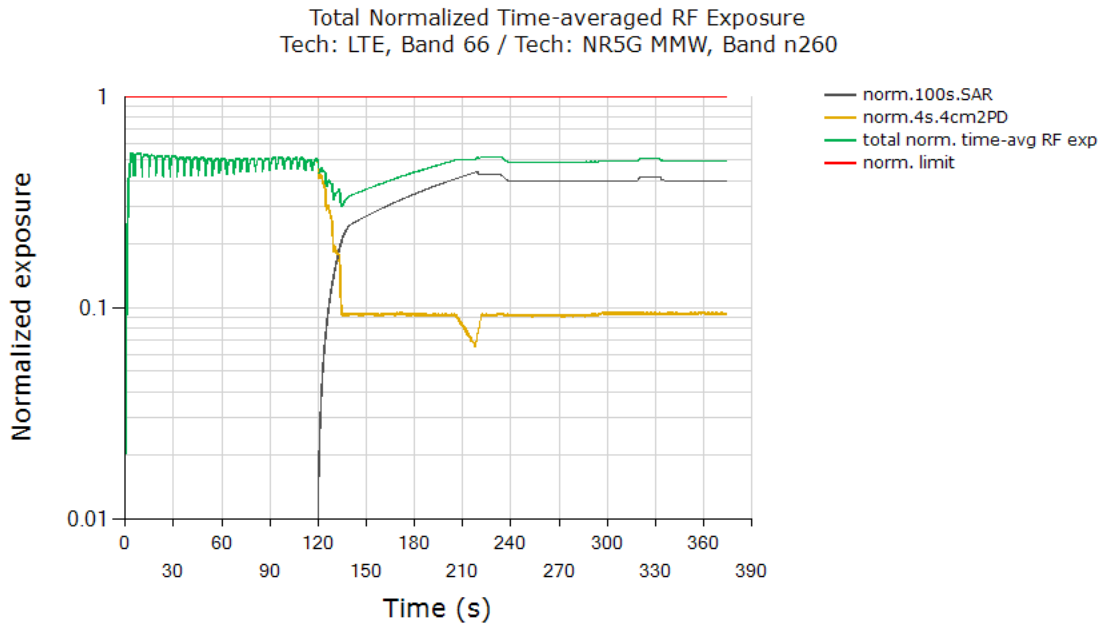

|  |       |
|--|-------|
| FCC requirement for total RF exposure (normalized)           | 1.0   |
| Max total normalized time-averaged RF exposure (green curve) | 0.546 |
| Validated  |       |

As can be seen, the power limiting enforcement is effective and the total normalized time-averaged RF exposure does not exceed 1.0. Therefore, the Smart Transmit time averaging feature is validated.

### 8.2.3. Switch in SAR vs. PD Exposure Test Results for n258

This test was measured with LTE Band 66 (DSI state 1) and mmW Band n258 Beam ID 32, by following the detailed test procedure as described in §4.3.2.

It is predominantly instantaneous PD exposure between 0 seconds ~ 120 seconds; it is instantaneous SAR + PD exposure between 120 seconds ~ 240 seconds; above 240 seconds, it is predominantly instantaneous PD exposure.

Normalized time-averaged exposures for LTE (1g SAR) and mmW (4 cm<sup>2</sup> PD), as well as total normalized time-averaged exposure versus time is shown below:

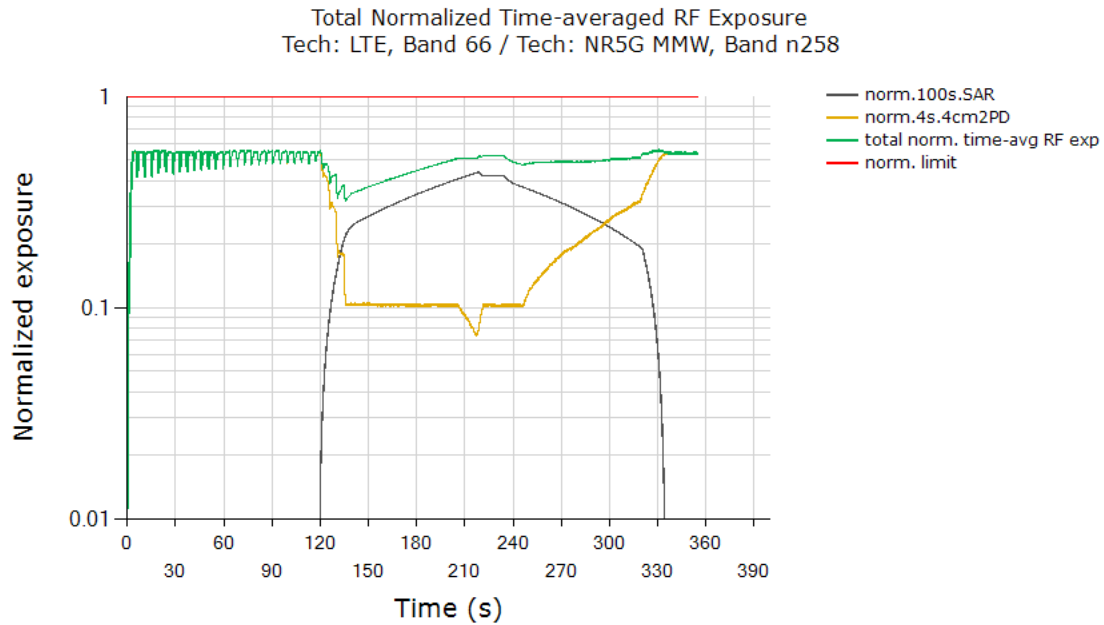

|  |       |
|--|-------|
| FCC requirement for total RF exposure (normalized)           | 1.0   |
| Max total normalized time-averaged RF exposure (green curve) | 0.564 |
| Validated  |       |

The power limiting enforcement is effective during transmission when SAR and PD exposures are switched, and the total normalized time-averaged RF exposure does not exceed 1.0. Therefore, the Smart Transmit time averaging feature is validated.

### 8.2.4. Switch in SAR vs. PD Exposure Test Results for n260

This test was measured with LTE Band 66 (DSI state 1) and mmW Band n260 Beam ID 34, by following the detailed test procedure as described in §4.3.2.

It is predominantly instantaneous PD exposure between 0 seconds ~ 120 seconds; it is instantaneous SAR + PD exposure between 120 seconds ~ 240 seconds; above 240 seconds, it is predominantly instantaneous PD exposure. Normalized time-averaged exposures for LTE (1g SAR) and mmW (4 cm<sup>2</sup> PD), as well as total normalized time-averaged exposure versus time is shown below:

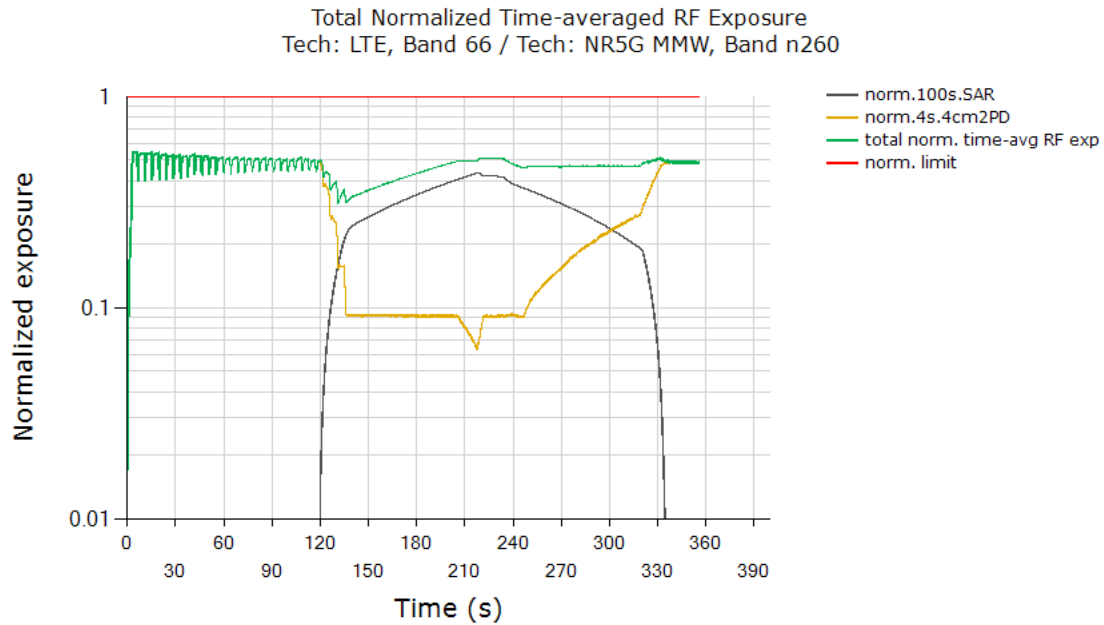

|  |       |
|--|-------|
| FCC requirement for total RF exposure (normalized)           | 1.0   |
| Max total normalized time-averaged RF exposure (green curve) | 0.555 |
| Validated  |       |

The power limiting enforcement is effective during transmission when SAR and PD exposures are switched, and the total normalized time-averaged RF exposure does not exceed 1.0. Therefore, the Smart Transmit time averaging feature is validated.

### 8.2.5. Change in Beam Test Results for n258

This test was measured with LTE Band 66 (DSI state 1) and mmW Band n258, with beams switching from Beam ID 34 to Beam ID 2, by following the test procedure as described in §4.3.3.

Normalized time-averaged exposures for LTE and mmW (4 cm<sup>2</sup> PD), as well as total normalized time-averaged exposure versus time:

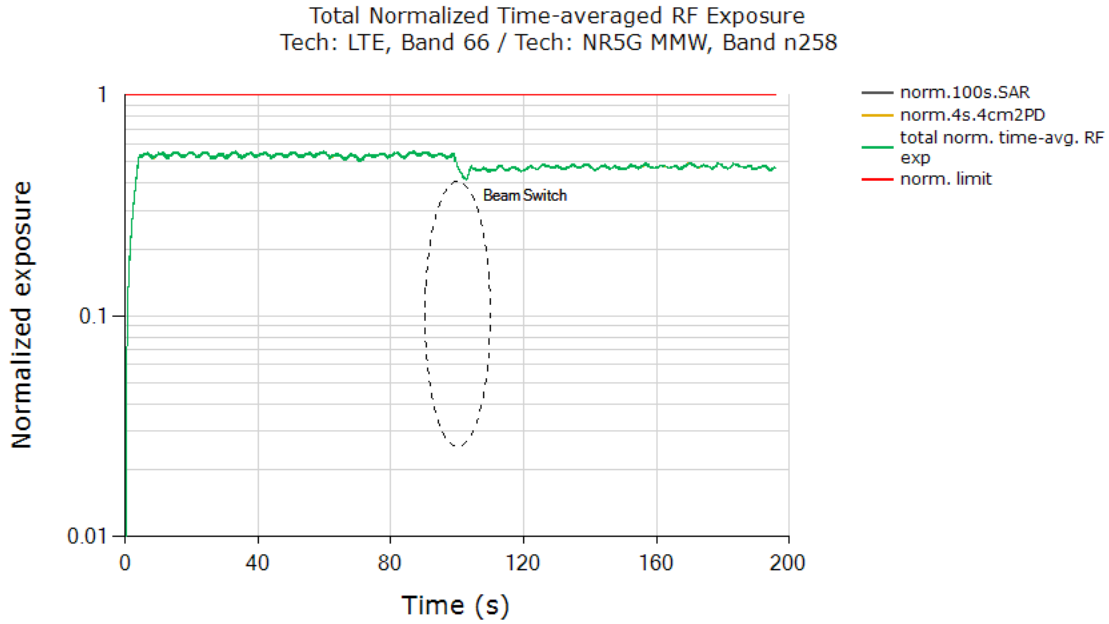

|  |       |
|--|-------|
| FCC requirement for total RF exposure (normalized)           | 1.0   |
| Max total normalized time-averaged RF exposure (green curve) | 0.555 |
| Validated  |       |

Additionally, during the switch, the ratio between the averaged radiated powers of the two beams (yellow curve) should correspond to the difference in EIRPs measured at each corresponding *input.power.limit* for these beams listed in Table 8-1.

### 8.2.6. Change in Beam Test Results for n260

This test was measured with LTE Band 66 (DSI state 1) and mmW Band n260, with beams switching from Beam ID 33 to Beam ID 2, by following the test procedure as described in §4.3.3.

Normalized time-averaged exposures for LTE and mmW (4 cm<sup>2</sup> PD), as well as total normalized time-averaged exposure versus time:

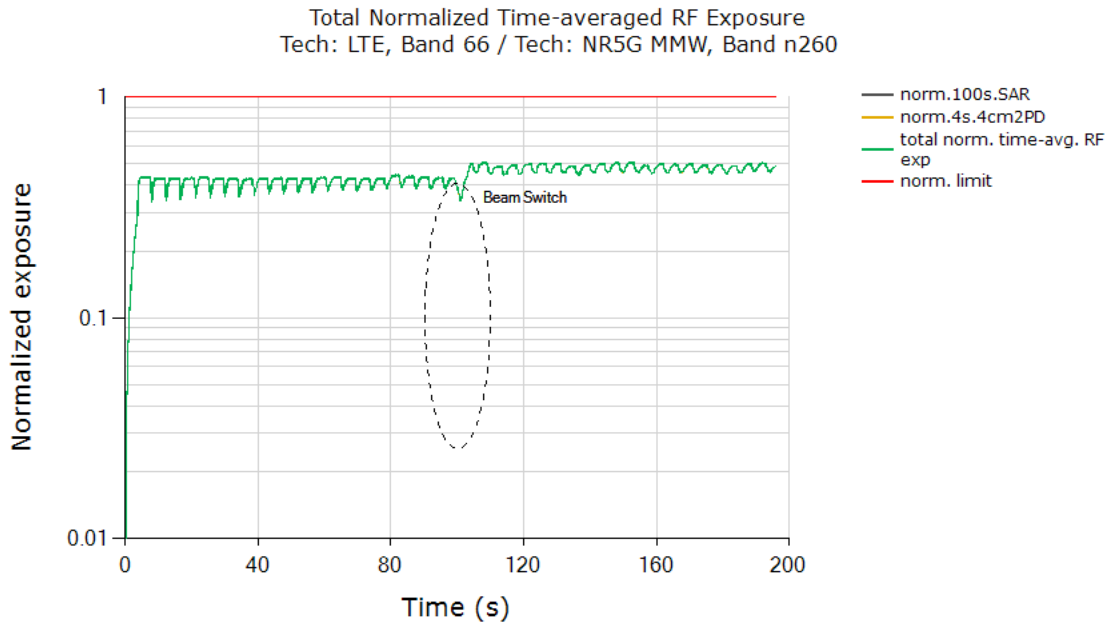

|  |       |
|--|-------|
| FCC requirement for total RF exposure (normalized)           | 1.0   |
| Max total normalized time-averaged RF exposure (green curve) | 0.507 |
| Validated  |       |

Additionally, during the switch, the ratio between the averaged radiated powers of the two beams (yellow curve) should correspond to the difference in EIRPs measured at each corresponding *input.power.limit* for these beams listed in Table 8-1.

## 9. PD Test Results for mmW Smart Transmit Feature Validation

Given the use of the same modem chipset as other models, test case reduction has been implemented per Qualcomm guidance. Measured PD results shall be reused from reference model A2483 (FCC: BCG-E4000A).

## 10. Conclusions

Qualcomm Smart Transmit feature employed herein has been validated through the conducted/radiated power measurement (as demonstrated in §6 and §8), as well as SAR and PD measurement (as demonstrated in §7 and §9).

As demonstrated in this report, the power limiting enforcement is effective and the total normalized time-averaged RF exposure does not exceed 1.0 for all the transmission scenarios as described in §2. Therefore, the EUT complies with FCC RF exposure requirements.



## Appendices

### A Test Sequences

1. Test sequence is generated based on the following parameters of the EUT:
  - a. Measured maximum power ( $P_{max}$ )
  - b. Measured transmission power at SAR<sub>Design Target</sub> ( $P_{limit}$ )
  - c. Reserve\_power\_margin (dB)
    - i.  $P_{reserve}$  (dBm) = measured  $P_{limit}$  (dBm) - Reserve\_power\_margin (dB)
  - d. SAR time window (100 seconds for FCC)
2. Test Sequence 1 Waveform: Based on the parameters above, Test Sequence 1 is generated with one transition between high and low transmission powers. Here, high power =  $P_{max}$ ; low power =  $P_{max}/2$ , and the transition occurs after 80 seconds at high power ( $P_{max}$ ). If the power enforcement is taking into effective during one 100 seconds/60 seconds time window, the validation test with this defined Test Sequence 1 is valid; otherwise, select other radio configurations (band/DSI within the same technology group) having lower  $P_{limit}$  for this test. The Test Sequence 1 waveform is shown below:

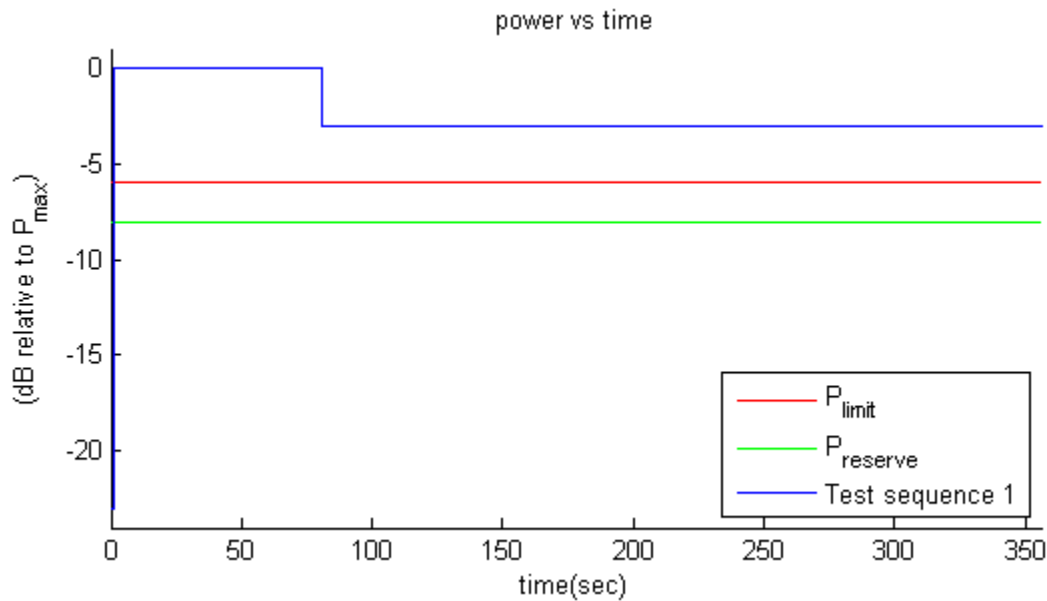
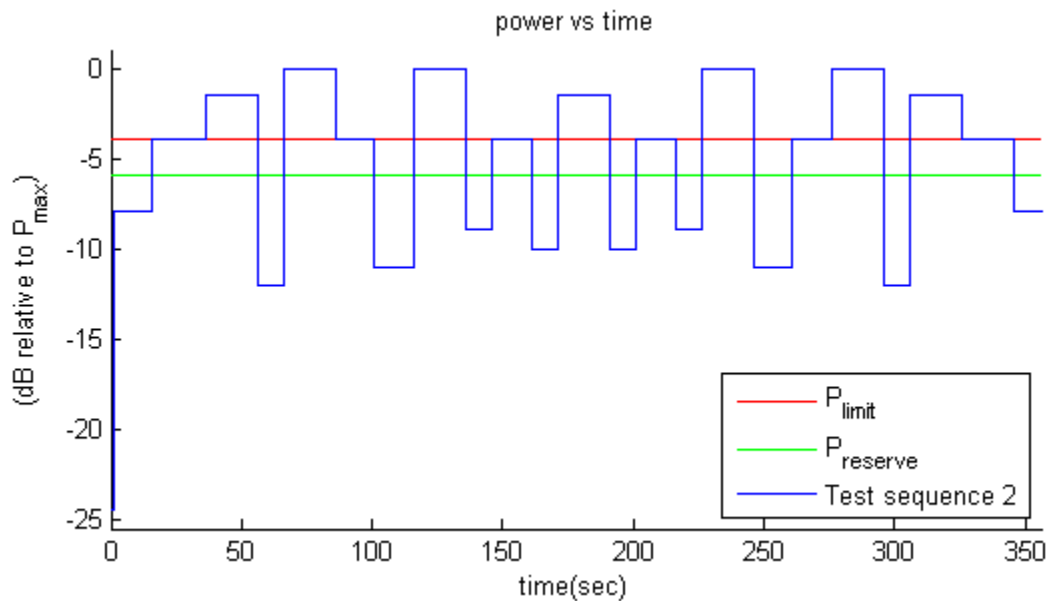

**Figure A-1: Test Sequence 1 waveform**

3. Test Sequence 2 Waveform: Based on the parameters in A-1, the Test Sequence 2 is generated as described in Table A-1 and pictured in Figure A-2, which contains two 170 seconds-long sequences (yellow and green highlighted rows) that are mirrored around the center row of 20 seconds, resulting in a total duration of 360 seconds:

**Table A-1: Test Sequence 2**

| Time duration (seconds) | dB relative to $P_{limit}$ or $P_{reserve}$                                 |
|-------------------------|---|
| 15                      | $P_{reserve} - 2$   |
| 20                      | $P_{limit}$   |
| 20                      | $(P_{limit} + P_{max})/2$ averaged in mW and rounded to nearest 0.1 dB step |
| 10                      | $P_{reserve} - 6$   |
| 20                      | $P_{max}$   |
| 15                      | $P_{limit}$   |
| 15                      | $P_{reserve} - 5$   |
| 20                      | $P_{max}$   |
| 10                      | $P_{reserve} - 3$   |
| 15                      | $P_{limit}$   |
| 10                      | $P_{reserve} - 4$   |
| 20                      | $(P_{limit} + P_{max})/2$ averaged in mW and rounded to nearest 0.1 dB step |
| 10                      | $P_{reserve} - 4$   |
| 15                      | $P_{limit}$   |
| 10                      | $P_{reserve} - 3$   |
| 20                      | $P_{max}$   |
| 15                      | $P_{reserve} - 5$   |
| 15                      | $P_{limit}$   |
| 20                      | $P_{max}$   |
| 10                      | $P_{reserve} - 6$   |
| 20                      | $(P_{limit} + P_{max})/2$ averaged in mW and rounded to nearest 0.1 dB step |
| 20                      | $P_{limit}$   |
| 15                      | $P_{reserve} - 2$   |



**Figure A-2: Test Sequence 2 waveform**

## B Test Procedures for Sub-6 GHz NR + Sub-6 GHz Radio

Appendix B provides the test procedures for validating the Smart Transmit feature for Sub-6 GHz + Sub-6 GHz NR non-standalone (NSA) mode transmission scenario, where Sub-6 GHz link acts as an anchor.

### B.1 Time-varying Transmission Power Test for Sub-6 GHz NR in NSA Mode

Following §3.2.1 to select the test configurations for time-varying tests, these tests are performed with two pre-defined test sequences (as described in §3.1) and applied to Sub-6 GHz NR (with Sub-6 GHz on all-down bits or low power for the entire test after establishing the Sub-6 GHz + Sub-6 GHz NR call with the callbox). Follow the test procedures described in §3.3.1 to demonstrate the effectiveness of power limiting enforcement and that the time averaged transmission power of Sub-6 GHz NR when converted into 1g SAR values do not exceed the regulatory limit (see Eq. (1a) and (1b)). Sub-6 GHz NR response to Test Sequence 1 and Test Sequence 2 will be similar to other technologies (say, LTE), and are shown in §6.3.7 and §6.3.8.

### B.2 Switch in SAR Exposure Between Sub-6 GHz vs. Sub-6 GHz NR during Transmission

This test is to demonstrate that the Smart Transmit feature accurately accounts for switching in exposures among SAR for Sub-6 GHz radio only, SAR from both Sub-6 GHz radio and Sub-6 GHz NR, and SAR from Sub-6 GHz NR only scenarios, and ensures total time-averaged RF exposure compliance with FCC limit.

#### Test Procedure:

1. Measure the conducted transmission power corresponding to  $P_{limit}$  for Sub-6 GHz and Sub-6 GHz NR in selected bands. Test conditions to measure conducted  $P_{limit}$  are:
  - a. Establish the device in a call with the callbox for Sub-6 GHz in a desired band. Measure the conducted transmission power corresponding to Sub-6 GHz  $P_{limit}$  with Smart Transmit enabled and *Reserve\_power\_margin* set to 0 dB, and the callbox set to request maximum power.
  - b. Repeat Step 1a to measure the conducted transmission power corresponding to Sub-6 GHz NR  $P_{limit}$ . If testing Sub-6 GHz + Sub-6 GHz NR in non-standalone mode (NSA), then establish a Sub-6 GHz + Sub-6 GHz NR call with the callbox and request all down bits for radio1 Sub-6 GHz. In this scenario, with the callbox requesting maximum power from the Sub-6 GHz NR radio, measure the conducted transmission power corresponding to radio2  $P_{limit}$  (as radio1 Sub-6 GHz is at all-down bits).
2. Set *Reserve\_power\_margin* to actual (intended) value with the EUT setup for Sub-6 GHz + Sub-6 GHz NR call. First, establish a Sub-6 GHz connection in all-up bits with the callbox and then a Sub-6 GHz NR connection is added with the callbox requesting the EUT to transmit at maximum power in Sub-6 GHz NR. When the Sub-6 GHz NR connection is established, request all-down bits on the Sub-6 GHz link (otherwise, Sub-6 GHz NR will not have sufficient RF exposure margin to sustain the call with Sub-6 GHz in all-up bits). Continue the Sub-6 GHz (all-down bits) + Sub-6 GHz NR transmission for more than one time-window duration to test, predominantly, the Sub-6 GHz NR SAR exposure scenario (as SAR exposure is negligible from all-down bits in Sub-6 GHz). After at least one time-window, request Sub-6 GHz to go all-up bits to test Sub-6 GHz SAR and Sub-6 GHz NR SAR exposure scenario. After at least one more time-window, drop (or request all-down bits) Sub-6 GHz NR transmission to test predominantly the Sub-6 GHz SAR exposure scenario. Continue the test for at least one more time-window. Record the conducted transmission powers for both Sub-6 GHz and Sub-6 GHz NR for the entire duration of this test.
3. Once the measurement is done, extract the instantaneous transmission power versus time for both Sub-6 GHz and Sub-6 GHz NR links. Like the technology/band switch test in §3.3.3, convert the conducted transmission power for both these radios into 1g SAR value (see Eq. (6a) and (6b)) using corresponding technology/band  $P_{limit}$  measured in Step 1 and then perform 100 seconds running average to determine time-averaged 1g SAR versus time as illustrated in Figure 3-1.<sup>27</sup>
4. Make one plot containing: (a) Instantaneous transmission power versus time measured in Step 2.
5. Make another plot containing: (a) Instantaneous 1g SAR versus time determined in Step 3, (b) computed time-averaged 1g SAR versus time determined in Step 3, and (c) corresponding regulatory 1g SAR<sub>limit</sub> of 1.6 W/kg.

<sup>27</sup> It is assumed both radios have transmission frequencies < 3 GHz; otherwise, 60 seconds running average should be performed for radios having transmission frequencies between 3 GHz and 6 GHz.

The validation criterion is the time-averaged 1g SAR versus time shall not exceed the regulatory 1g SAR<sub>limit</sub> of 1.6 W/kg.

## **C Test Setup Photos**

End of Report