

CERTIFICATE OF CALIBRATION

ISSUED BY **UL VS LTD**

DATE OF ISSUE: 20/Apr/2020

CERTIFICATE NUMBER : 13252595JD01C



5248

UL VS LTD
UNIT 1-3 HORIZON
KINGSLAND PARK, WADE ROAD
BASINGSTOKE, HAMPSHIRE
RG24 8AH, UK
TEL: +44 (0) 1256 312000
FAX: +44 (0) 1256 312001
Email: LST.UK.Calibration@ul.com



Page 1 of 10

APPROVED SIGNATORY

A handwritten signature in black ink, appearing to read 'M. Nasir'.

.....
Naseer Mirza

Customer :

UL VS Inc
47173 Benicia Street
Fremont, CA 94538, USA

Equipment Details:

Description:	Dipole Validation Kit	Date of Receipt:	14/Apr/2020
Manufacturer:	Speag		
Type/Model Number:	D2450V2		
Serial Number:	899		
Calibration Date:	17/Apr/2020		
Calibrated By:	Masood Khan Test Engineer		

Signature:

A handwritten signature in black ink, appearing to read 'Masood Khan'.

.....

All Calibration have been conducted in the closed laboratory facility: Lab Temperature (22±3) °C and humidity < 70%

This certificate is issued in accordance with the laboratory accreditation requirements of the United Kingdom Accreditation Service. It provides traceability of measurement to the SI system of units and/or to units of measurement realised at the National Physical Laboratory or other recognised national metrology institutes. This certificate may not be reproduced other than in full, except with the prior written approval of the issuing laboratory.

Use of the UKAS mark demonstrates that compliance with the requirements of BS/EN/ISO/IEC 17025 has been independently assessed.

CERTIFICATE OF CALIBRATION

ISSUED BY UL VS LTD

UKAS Accredited Calibration Laboratory No. 5248

CERTIFICATE
NUMBER :
13252595JD01C

Page 2 of 10

The calibration methods and procedures used were as detailed in:

1. **IEC 62209-1:2016:** Procedure to determine the specific absorption rate (SAR) for hand-held devices used in close proximity to the ear (frequency range of 300 MHz to 3 GHz)
2. **IEC 62209-2:2010:** Procedure to determine the specific absorption rate (SAR) for wireless communication devices used in close proximity to the human body (frequency range of 30 MHz to 6 GHz)
3. **IEEE 1528: 2013:** IEEE Recommended Practice for Determining the Peak Spatial-Average Specific Absorption Rate (SAR) in the Human Head from Wireless Communication Devices: Measurement Techniques
4. FCC KDB Publication Number: “**KDB865664 D01 SAR Measurement 100 MHz to 6 GHz**”
5. **SPEAG DASY5 System Handbook**

The measuring equipment used to perform the calibration, documented in this certificate has been calibrated in accordance with the manufacturers' recommendations, and is traceable to recognized national standards.

UL No.	Instrument	Manufacturer	Type No.	Serial No.	Date Last Calibrated	Cal. Interval (Months)
PRE0178317	Data Acquisition Electronics	SPEAG	DAE4	1542	17 Mar 2020	12
PRE0178314	Probe	SPEAG	EX3DV4	7496	24 Mar 2020	12
PRE0134944	Dipole	SPEAG	D2440V2	701	14 Feb 2020	12
PRE0131118	Power Sensor	Rhode & Schwarz	NRV-Z1	826515/015	27 Jan 2020	12
PRE0134023	Power Sensor	Rhode & Schwarz	NRV-Z1	860462/016	27 Jan 2020	12
PRE0151154	Vector Network Analyser	Rhode & Schwarz	ZND	100151	30 Jan 2020	12
PRE0151877	Calibration Kit	Rhode & Schwarz	ZV-Z135	102947	17 Oct 2019	12
PRE0178154	Signal Generator	Rhode & Schwarz	SMIQ 03B	1125.555.03	23 Jan 2020	12

CERTIFICATE OF CALIBRATION ISSUED BY **UL VS LTD**

UKAS Accredited Calibration Laboratory No. 5248

CERTIFICATE
NUMBER :
13252595JD01C

Page 3 of 10

SAR System Specification

Robot System Positioner:	Stäubli Unimation Corp. Robot Model: TX60L
Robot Serial Number:	F17/5ENYG1/A/01
DASY Version:	DASY 52 (v52.8.8.1258)
Phantom:	Flat section of SAM Twin Phantom
Distance Dipole Centre:	10 mm (with spacer)
Frequency:	2450 MHz

Dielectric Property Measurements – Head Simulating Liquid (HSL)

Simulant Liquid	Frequency (MHz)	Room Temp		Liquid Temp		Parameters	Target Value	Measured Value	Uncertainty (%)
		Start	End	Start	End				
Head	2450	20.5 °C	21.0 °C	20.9°C	21.1°C	ϵ_r	39.20	40.15	± 5%
						σ	1.80	1.82	± 5%

SAR Results – Head Simulating Liquid (HSL)

Simulant Liquid	SAR Measured	250 mW input Power	Normalised to 1.00 W	Uncertainty (%)
Head	SAR averaged over 1g	13.00 W/Kg	51.75 W/Kg	± 17.57%
	SAR averaged over 10g	6.06 W/Kg	24.12 W/Kg	± 17.32%

Antenna Parameters – Head Simulating Liquid (HSL)

Simulant Liquid	Parameter	Measured Level	Uncertainty (%)
Head	Impedance	43.662 Ω 1.47 $j\Omega$	± 0.28 Ω ± 0.044 $j\Omega$
	Return Loss	-23.19	± dB

CERTIFICATE OF CALIBRATION

ISSUED BY UL VS LTD

UKAS Accredited Calibration Laboratory No. 5248

CERTIFICATE
NUMBER :
13252595JD01C

Page 4 of 10

Dielectric Property Measurements – Body Simulating Liquid (MSL)

Simulant Liquid	Frequency (MHz)	Room Temp		Liquid Temp		Parameters	Target Value	Measured Value	Uncertainty (%)
		Start	End	Start	End				
Body	2450	21.5 °C	21.1 °C	21.0°C	21.0°C	ϵ_r	52.70	52.22	± 5%
						σ	1.95	1.99	± 5%

SAR Results – Body Simulating Liquid (MSL)

Simulant Liquid	SAR Measured	250 mW input Power	Normalised to 1.00 W	Uncertainty (%)
Body	SAR averaged over 1g	13.00 W/Kg	51.75 W/Kg	± 18.06%
	SAR averaged over 10g	6.03 W/Kg	24.00 W/Kg	± 17.44%

Antenna Parameters – Body Simulating Liquid (MSL)

Simulant Liquid	Parameter	Measured Level	Uncertainty (%)
Body	Impedance	43.82 Ω -0.368 j Ω	± 0.28 Ω ± 0.044 j Ω
	Return Loss	-23.63	± 2.03 dB

CERTIFICATE OF CALIBRATION

ISSUED BY UL VS LTD

CERTIFICATE
NUMBER :
13252595JD01C

UKAS Accredited Calibration Laboratory No. 5248

Page 5 of 10

DASY Validation Scan for Head Stimulating Liquid (HSL)

DUT: D2450V2 - SN899; Type: D2450V2; Serial: SN899

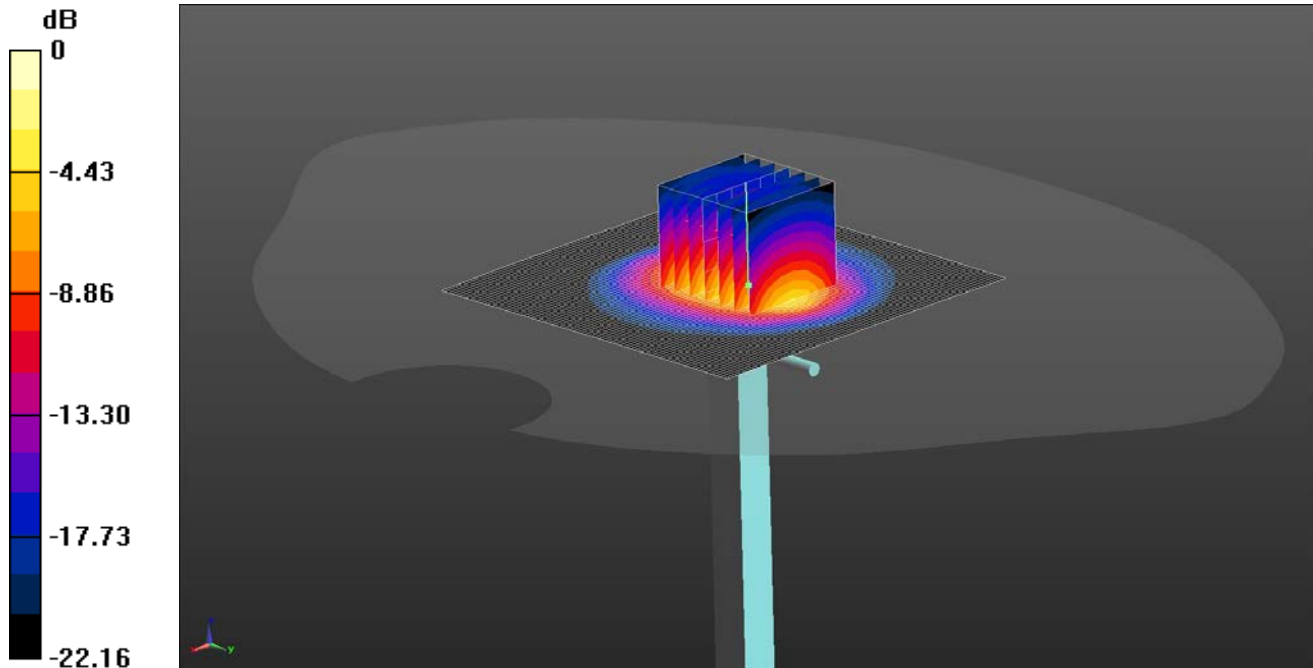

0 dB = 21.6 W/kg = 13.34 dBW/kg

Communication System: UID 0, CW (0); Frequency: 2450 MHz; Duty Cycle: 1:1;
Medium: Site65_14Apr2020_180909_Head - 750 2300 2450 2600; Medium parameters used: $f = 2450$ MHz; $\sigma = 1.818$ S/m; $\epsilon_r = 40.149$; $\rho = 1000$ kg/m³ ;
Phantom section: Flat Section ;

DASY5 Configuration:

- Probe: EX3DV4 - SN7496; ConvF(7.78, 7.78, 7.78); Calibrated: 24/03/2020;
- Sensor-Surface: 3mm (Mechanical Surface Detection), Sensor-Surface: 1.4mm (Mechanical Surface Detection);
- Electronics: DAE4 Sn1542; Calibrated: 17/03/2020;
- Phantom: Twin-SAM B (Site 65); Type: QD 000 P40 CC; Serial: 1945;
- Measurement SW: DASY52, Version 52.10 (0); SEMCAD X Version 14.6.10 (7417) ;

Configuration/d=10mm, Pin=250mW 2/Area Scan (81x81x1): Interpolated grid: dx=1.200 mm, dy=1.200 mm

Maximum value of SAR (interpolated) = 17.7 W/kg

Configuration/d=10mm, Pin=250mW 2/Zoom Scan (7x7x5)/Cube 0: Measurement grid: dx=5mm, dy=5mm, dz=4mm

Reference Value = 89.18 V/m; Power Drift = 0.11 dB

Peak SAR (extrapolated) = 26.8 W/kg

SAR(1 g) = 13 W/kg; SAR(10 g) = 6.06 W/kg

Maximum value of SAR (measured) = 21.6 W/kg

CERTIFICATE OF CALIBRATION ISSUED BY UL VS LTD

CERTIFICATE
NUMBER :
13252595JD01C

UKAS Accredited Calibration Laboratory No. 5248

Page 6 of 10

Impedance Measurement Plot for Head Stimulating Liquid (HSL)

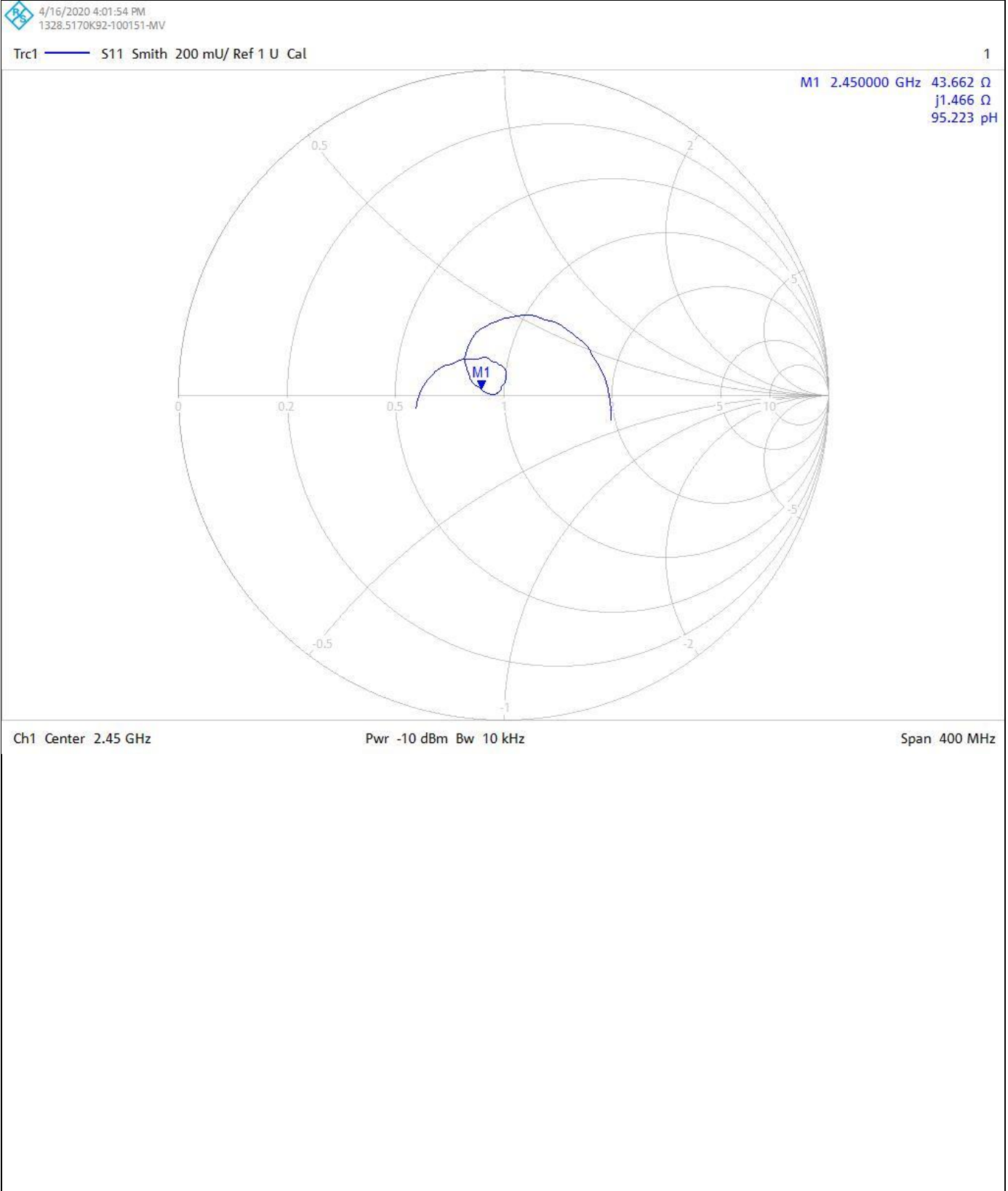

CERTIFICATE OF CALIBRATION

ISSUED BY UL VS LTD

UKAS Accredited Calibration Laboratory No. 5248

CERTIFICATE
NUMBER :
13252595JD01C

Page 7 of 10

Return Loss Measurement Plot for Head Stimulating Liquid (HSL)

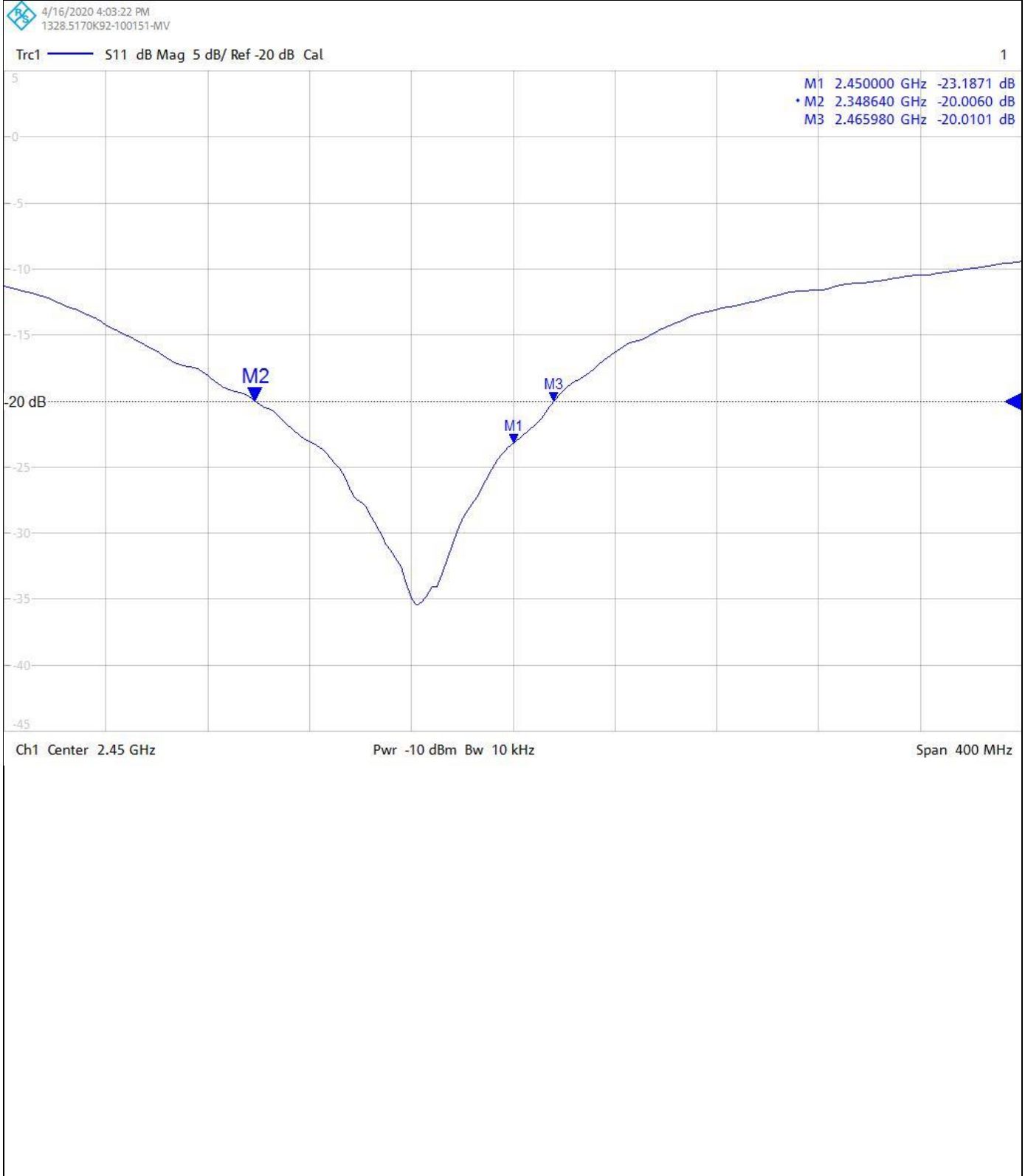

CERTIFICATE OF CALIBRATION

ISSUED BY UL VS LTD

CERTIFICATE
NUMBER :
13252595JD01C

UKAS Accredited Calibration Laboratory No. 5248

Page 8 of 10

DASY Validation Scan for Body Stimulating Liquid (MSL)

DUT: D2440V2 - SN899; Type: D2440V2; Serial: SN899

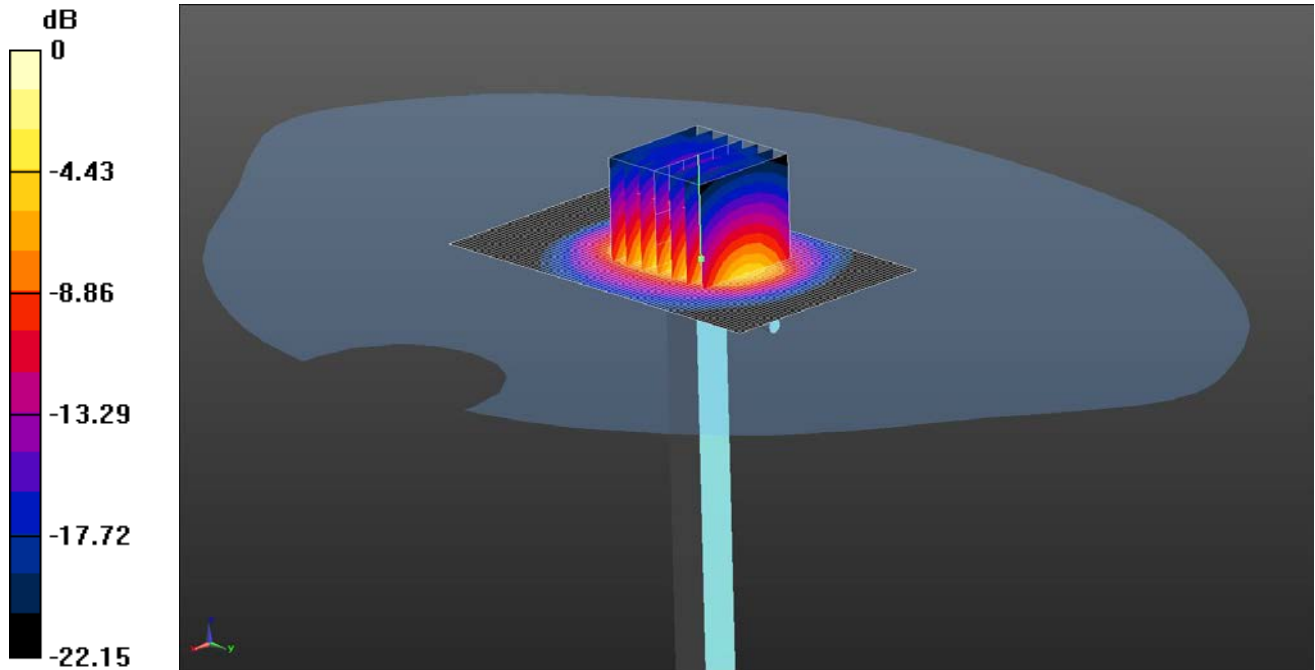

0 dB = 21.5 W/kg = 13.32 dBW/kg

Communication System: UID 0, CW (0); Frequency: 2450 MHz; Duty Cycle: 1:1;

Medium: Site65_15Apr2020_140023_Body - 750 2300 2450 2600 5%; Medium parameters used: $f = 2450$ MHz; $\sigma = 1.993$ S/m; $\epsilon_r = 52.221$; $\rho = 1000$ kg/m³ ;

Phantom section: Flat Section ;

DASY5 Configuration:

- Probe: EX3DV4 - SN7496; ConvF(7.75, 7.75, 7.75); Calibrated: 24/03/2020;

- Sensor-Surface: 3mm (Mechanical Surface Detection), Sensor-Surface: 1.4mm (Mechanical Surface Detection);

- Electronics: DAE4 Sn1542; Calibrated: 17/03/2020;

- Phantom: Twin SAM A (Site 65); Type: SAM 5.0; Serial: SN1818;

- Measurement SW: DASY52, Version 52.10 (0); SEMCAD X Version 14.6.10 (7417) ;

2450/d=10mm, Pin=250mW/Area Scan (51x81x1): Interpolated grid: dx=1.200 mm, dy=1.200 mm

Maximum value of SAR (interpolated) = 18.4 W/kg

2450/d=10mm, Pin=250mW/Zoom Scan (7x7x5)/Cube 0: Measurement grid: dx=5mm, dy=5mm, dz=4mm

Reference Value = 86.25 V/m; Power Drift = 0.08 dB

Peak SAR (extrapolated) = 26.9 W/kg

SAR(1 g) = 13 W/kg; SAR(10 g) = 6.03 W/kg

Maximum value of SAR (measured) = 21.5 W/kg

CERTIFICATE OF CALIBRATION

ISSUED BY UL VS LTD

UKAS Accredited Calibration Laboratory No. 5248

CERTIFICATE
NUMBER :
13252595JD01C

Page 9 of 10

Impedance Measurement Plot for Body Stimulating Liquid (MSL)

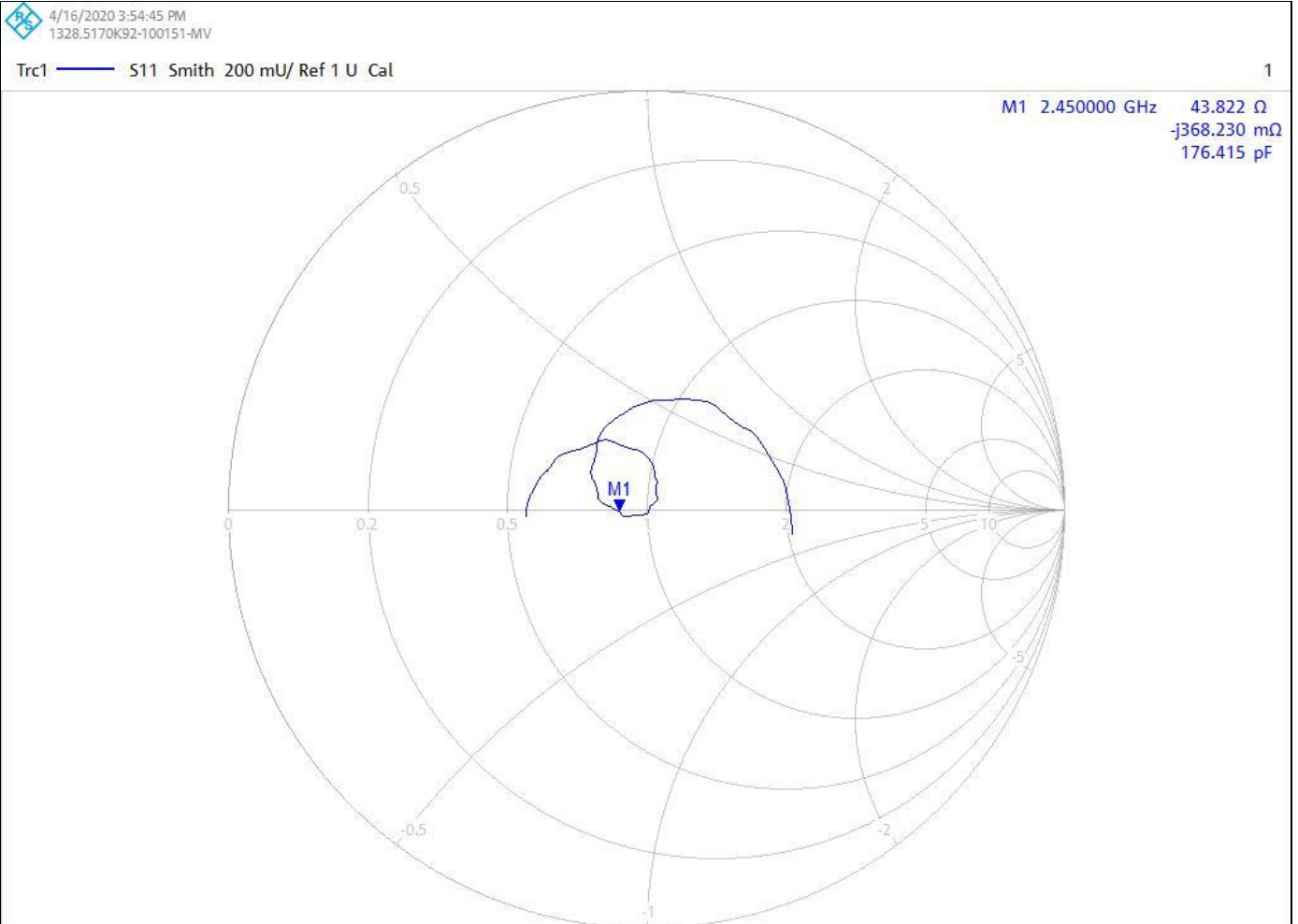

Ch1 Center 2.45 GHz

Pwr -10 dBm Bw 10 kHz

Span 400 MHz

CERTIFICATE OF CALIBRATION

ISSUED BY UL VS LTD

UKAS Accredited Calibration Laboratory No. 5248

CERTIFICATE
NUMBER :
13252595JD01C

Page 10 of 10

Return Loss Measurement Plot for Body Stimulating Liquid (MSL)

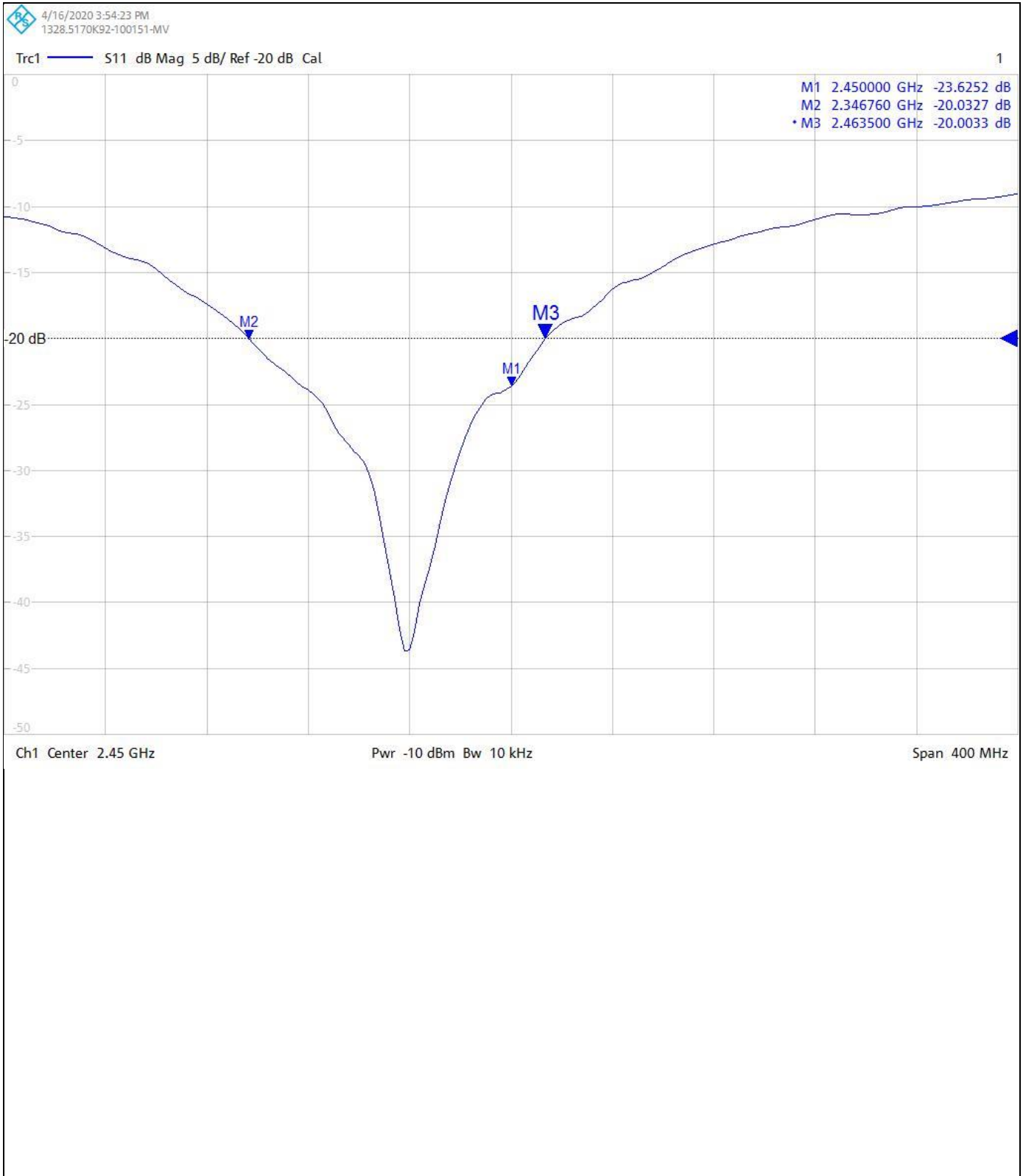

Calibration Certificate Label:

 <p>UKAS CALIBRATION 5248</p>	<p>UL VS LTD - Tel: +44 (0) 1256312000</p> <p>Certificate Number: 13252595JD01C</p> <p>Instrument ID: 899</p> <p>Calibration Date: 17/Apr/2020</p> <p>Calibration Due Date:</p>
------------------------------------------------------------------------------------------------------------------------	----------------------------------------------------------------------------------------------------------------------------------------------------------------------------------------

 <p>UKAS CALIBRATION 5248</p>	<p>UL VS LTD - Tel: +44 (0) 1256312000</p> <p>Certificate Number: 13252595JD01C</p> <p>Instrument ID: 899</p> <p>Calibration Date: 17/Apr/2020</p> <p>Calibration Due Date:</p>
------------------------------------------------------------------------------------------------------------------------	----------------------------------------------------------------------------------------------------------------------------------------------------------------------------------------

 <p>UKAS CALIBRATION 5248</p>	<p>UL VS LTD - Tel: +44 (0) 1256312000</p> <p>Certificate Number: 13252595JD01C</p> <p>Instrument ID: 899</p> <p>Calibration Date: 17/Apr/2020</p> <p>Calibration Due Date:</p>
--------------------------------------------------------------------------------------------------------------------------	----------------------------------------------------------------------------------------------------------------------------------------------------------------------------------------

CERTIFICATE OF CALIBRATION

ISSUED BY **UL VS LTD**

DATE OF ISSUE: 12/Mar/2020 CERTIFICATE NUMBER : 13252596JD01A



5248

UL VS LTD
UNIT 1-3 HORIZON
KINGSLAND PARK, WADE ROAD
BASINGSTOKE, HAMPSHIRE
RG24 8AH, UK
TEL: +44 (0) 1256 312000
FAX: +44 (0) 1256 312001
Email: LST.UK.Calibration@ul.com



Page 1 of 10

APPROVED SIGNATORY

A handwritten signature in black ink, appearing to read 'M. Naseer', with a horizontal line underneath.

.....
Naseer Mirza

Customer :

UL VS Inc
47173 Benicia Street
Fremont, CA 94538, USA

Equipment Details:

Description:	Dipole Validation Kit	Date of Receipt:	26/Feb/2020
Manufacturer:	Speag		
Type/Model Number:	D2450V2		
Serial Number:	748		
Calibration Date:	12/Mar/2020		
Calibrated By:	Harmohan Sahota Laboratory Engineer		

Signature:

A handwritten signature in black ink, appearing to read 'Harmohan Sahota', with a horizontal line underneath.

All Calibration have been conducted in the closed laboratory facility: Lab Temperature (22±3) °C and humidity < 70%

This certificate is issued in accordance with the laboratory accreditation requirements of the United Kingdom Accreditation Service. It provides traceability of measurement to the SI system of units and/or to units of measurement realised at the National Physical Laboratory or other recognised national metrology institutes. This certificate may not be reproduced other than in full, except with the prior written approval of the issuing laboratory.

Use of the UKAS mark demonstrates that compliance with the requirements of BS/EN/ISO/IEC 17025 has been independently assessed.

CERTIFICATE OF CALIBRATION

ISSUED BY UL VS LTD

UKAS Accredited Calibration Laboratory No. 5248

CERTIFICATE
NUMBER :
13252596JD01A

Page 2 of 10

The calibration methods and procedures used were as detailed in:

1. **IEC 62209-1:2016**: Procedure to determine the specific absorption rate (SAR) for hand-held devices used in close proximity to the ear (frequency range of 300 MHz to 3 GHz)
2. **IEC 62209-2:2010**: Procedure to determine the specific absorption rate (SAR) for wireless communication devices used in close proximity to the human body (frequency range of 30 MHz to 6 GHz)
3. **IEEE 1528: 2013**: IEEE Recommended Practice for Determining the Peak Spatial-Average Specific Absorption Rate (SAR) in the Human Head from Wireless Communication Devices: Measurement Techniques
4. FCC KDB Publication Number: “**KDB865664 D01 SAR Measurement 100 MHz to 6 GHz**”
5. **SPEAG DASY5 System Handbook**

The measuring equipment used to perform the calibration, documented in this certificate has been calibrated in accordance with the manufacturers' recommendations, and is traceable to recognized national standards.

UL No.	Instrument	Manufacturer	Type No.	Serial No.	Date Last Calibrated	Cal. Interval (Months)
A2547	Data Acquisition Electronics	SPEAG	DAE4	1438	11 Apr 2019	12
A2545	Probe	SPEAG	EX3DV4	3995	24 Apr 2019	12
A2202	Dipole	SPEAG	D2440V2	701	14 Feb 2020	12
PRE0151451	Power Monitoring Kit	Art-Fi	ART 100850-01	0001	Cal as part of System	-
PRE0151441	Power Sensor	Rhode & Schwarz	NRP8S	102481	27 Mar 2019	12
PRE0151154	Vector Network Analyser	Rhode & Schwarz	ZND8	100151	30 Jan 2020	12
PRE0151877	Calibration Kit	Rhode & Schwarz	ZV-Z135	102947	17 Oct 2019	12
PRE0178154	Signal Generator	Rhode & Schwarz	SMB 100A	175325	30 Apr 2019	12

CERTIFICATE OF CALIBRATION

ISSUED BY UL VS LTD

UKAS Accredited Calibration Laboratory No. 5248

CERTIFICATE
NUMBER :
13252596JD01A

Page 3 of 10

SAR System Specification

Robot System Positioner:	Stäubli Unimation Corp. Robot Model: TX60L
Robot Serial Number:	F17/5ENYG1/A/01
DASY Version:	DASY 52 (v52.10.0.1446)
Phantom:	Flat section of SAM Twin Phantom
Distance Dipole Centre:	10 mm (with spacer)
Frequency:	2450 MHz

Dielectric Property Measurements – Head Simulating Liquid (HSL)

Simulant Liquid	Frequency (MHz)	Room Temp		Liquid Temp		Parameters	Target Value	Measured Value	Uncertainty (%)
		Start	End	Start	End				
Head	2450	20.6 °C	21.6 °C	20.4 °C	20.6 °C	ϵ_r	39.20	41.02	± 5%
						σ	1.80	1.88	± 5%

SAR Results – Head Simulating Liquid (HSL)

Simulant Liquid	SAR Measured	250 mW input Power	Normalised to 1.00 W	Uncertainty (%)
Head	SAR averaged over 1g	13.60 W/Kg	54.14 W/Kg	± 17.57%
	SAR averaged over 10g	6.34 W/Kg	25.24 W/Kg	± 17.32%

Antenna Parameters – Head Simulating Liquid (HSL)

Simulant Liquid	Parameter	Measured Level	Uncertainty (%)
Head	Impedance	54.283 Ω + 7.483 j Ω	± 0.28 Ω ± 0.044 j Ω
	Return Loss	-21.66	± 1.27 dB

CERTIFICATE OF CALIBRATION

ISSUED BY UL VS LTD

UKAS Accredited Calibration Laboratory No. 5248

CERTIFICATE
NUMBER :
13252596JD01A

Page 4 of 10

Dielectric Property Measurements – Body Simulating Liquid (MSL)

Simulant Liquid	Frequency (MHz)	Room Temp		Liquid Temp		Parameters	Target Value	Measured Value	Uncertainty (%)
		Start	End	Start	End				
Body	2450	20.5 °C	21.4 °C	20.0°C	20.2°C	ϵ_r	52.70	52.37	± 5%
						σ	1.95	2.02	± 5%

SAR Results – Body Simulating Liquid (MSL)

Simulant Liquid	SAR Measured	250 mW input Power	Normalised to 1.00 W	Uncertainty (%)
Body	SAR averaged over 1g	13.80 W/Kg	54.93 W/Kg	± 18.06%
	SAR averaged over 10g	6.33 W/Kg	25.20 W/Kg	± 17.44%

Antenna Parameters – Body Simulating Liquid (MSL)

Simulant Liquid	Parameter	Measured Level	Uncertainty (%)
Body	Impedance	54.61 Ω + 4.96 j Ω	± 0.28 Ω ± 0.044 j Ω
	Return Loss	-23.83	± 2.03 dB

CERTIFICATE OF CALIBRATION

ISSUED BY UL VS LTD

CERTIFICATE
NUMBER :
13252596JD01A

UKAS Accredited Calibration Laboratory No. 5248

Page 5 of 10

DASY Validation Scan for Head Stimulating Liquid (HSL)

DUT: D2450V2 - SN748; Type: D2450V2; Serial: SN748

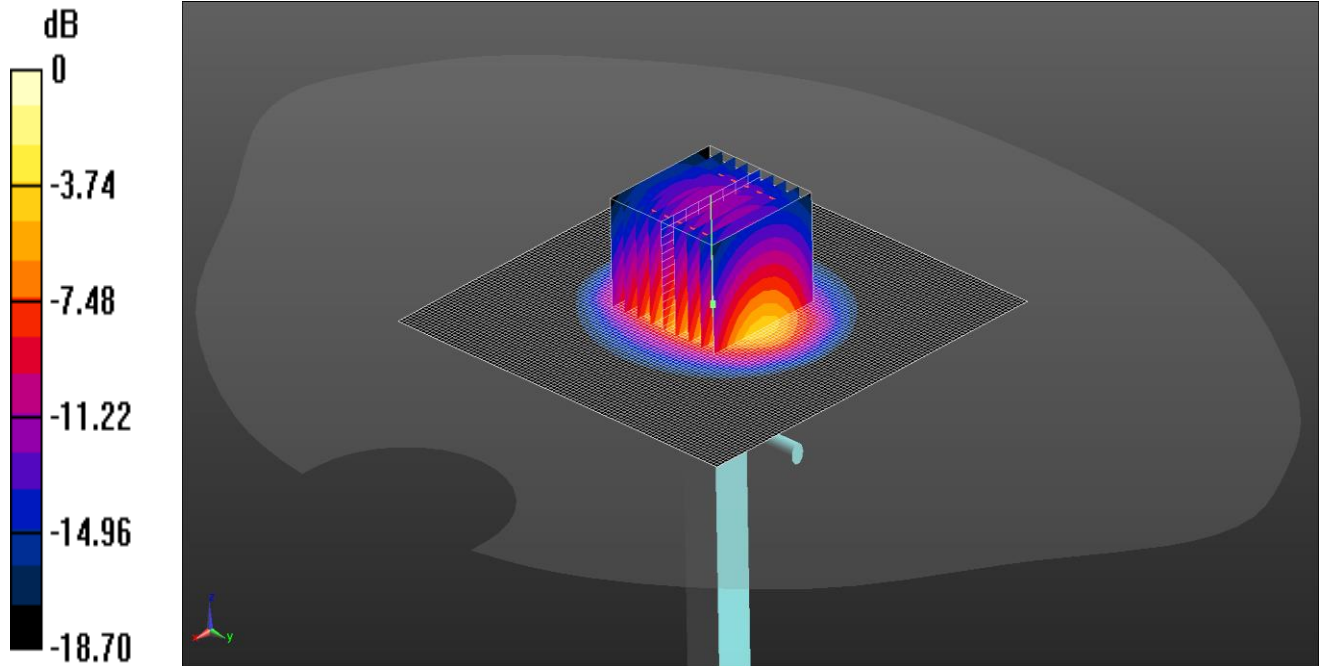

0 dB = 20.8 W/kg = 13.18 dBW/kg

Communication System: UID 0, CW (0); Frequency: 2450 MHz; Duty Cycle: 1:1
Medium: HSL 09 03 20 - 2450 3500 5250 5600 5750 5% Medium parameters used: $f = 2450$ MHz; $\sigma = 1.885$ S/m; $\epsilon_r = 41.017$; $\rho = 1000$ kg/m³
Phantom section: Flat Section
DASY4 Configuration:
- Probe: EX3DV4 - SN3995; ConvF(7.79, 7.79, 7.79); Calibrated: 24/04/2019;
- Sensor-Surface: 4mm (Mechanical Surface Detection), Sensor-Surface: 2mm (Mechanical Surface Detection)
- Electronics: DAE4 Sn1438; Calibrated: 11/04/2019
- Phantom: Twin-SAM V8.0 (20deg probe tilt); Type: QD 000 P41 Ax; Serial: 1945
- ; SEMCAD X Version 14.6.10 (7417)

Configuration/d=10mm, Pin=250mW/Area Scan (101x101x1): Interpolated grid: dx=1.000 mm, dy=1.000 mm

Maximum value of SAR (interpolated) = 15.9 W/kg

Configuration/d=10mm, Pin=250mW/Zoom Scan (9x9x16)/Cube 0: Measurement grid: dx=4mm, dy=4mm, dz=1.4mm

Reference Value = 90.85 V/m; Power Drift = 0.04 dB

Peak SAR (extrapolated) = 27.5 W/kg

SAR(1 g) = 13.6 W/kg; SAR(10 g) = 6.34 W/kg

Maximum value of SAR (measured) = 20.8 W/kg

CERTIFICATE OF CALIBRATION

ISSUED BY UL VS LTD

UKAS Accredited Calibration Laboratory No. 5248

CERTIFICATE
NUMBER :
13252596JD01A

Page 6 of 10

Impedance Measurement Plot for Head Stimulating Liquid (HSL)

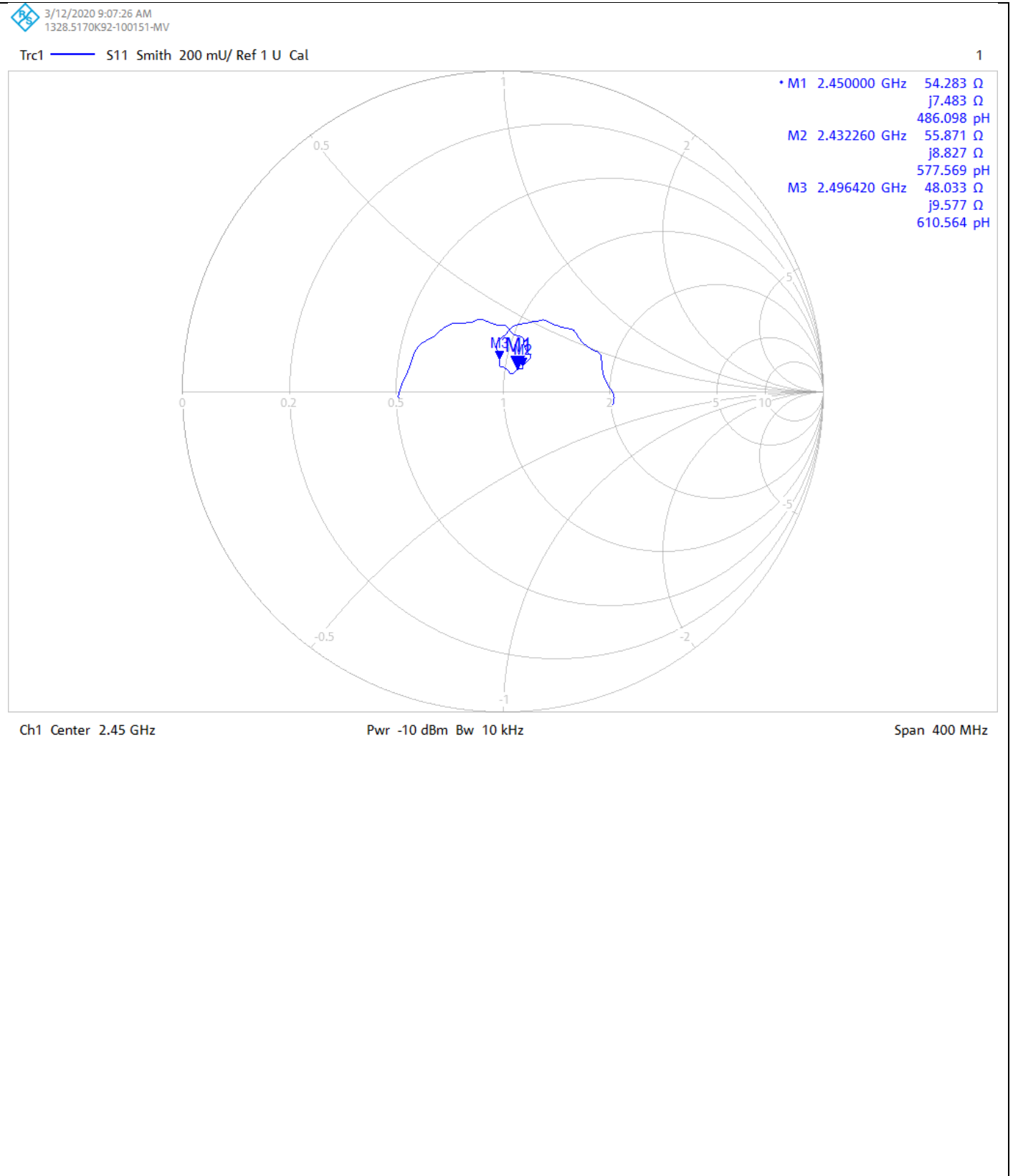

CERTIFICATE OF CALIBRATION

ISSUED BY UL VS LTD

UKAS Accredited Calibration Laboratory No. 5248

CERTIFICATE
NUMBER :
13252596JD01A

Page 7 of 10

Return Loss Measurement Plot for Head Stimulating Liquid (HSL)

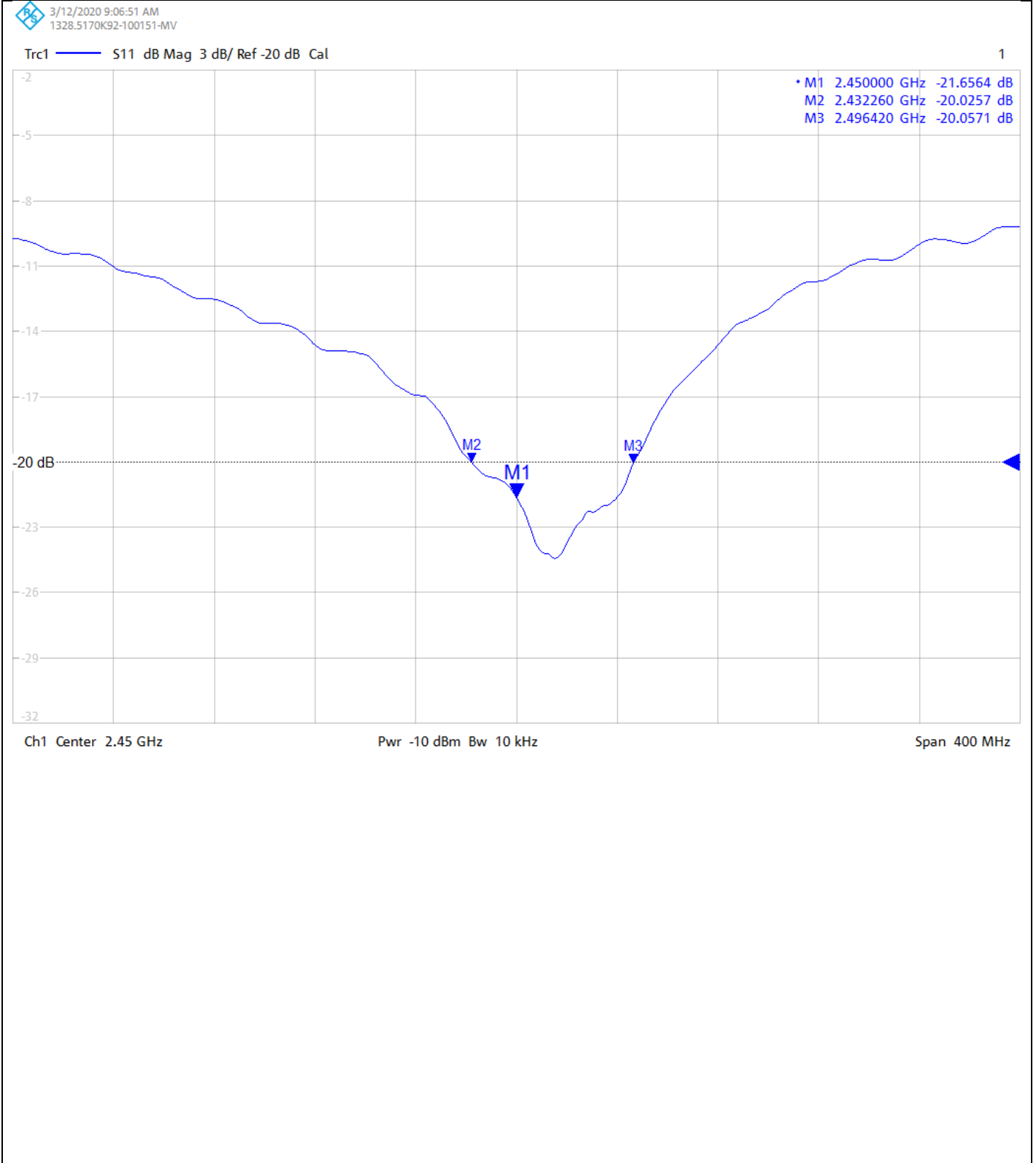

CERTIFICATE OF CALIBRATION

ISSUED BY UL VS LTD

UKAS Accredited Calibration Laboratory No. 5248

CERTIFICATE
NUMBER :
13252596JD01A

Page 8 of 10

DASY Validation Scan for Body Stimulating Liquid (MSL)

DUT: D2450V2 - SN748; Type: D2450V2; Serial: SN748

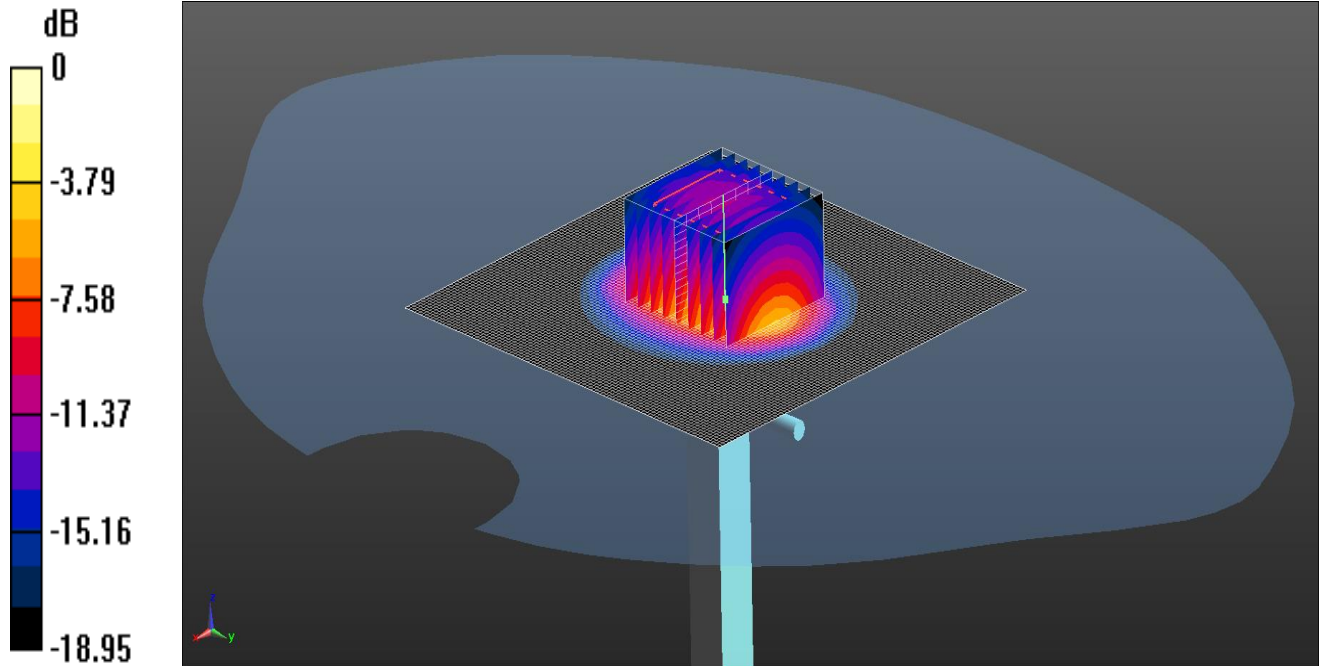

0 dB = 21.2 W/kg = 13.26 dBW/kg

Communication System: UID 0, CW (0); Frequency: 2450 MHz; Duty Cycle: 1:1
Medium: MSL 10 03 20 - 2450 5% MHz Medium parameters used: $f = 2450$ MHz; $\sigma = 2.026$ S/m; $\epsilon_r = 52.369$; $\rho = 1000$ kg/m³
Phantom section: Flat Section
DASY4 Configuration:
- Probe: EX3DV4 - SN3995; ConvF(7.72, 7.72, 7.72); Calibrated: 24/04/2019;
- Sensor-Surface: 4mm (Mechanical Surface Detection), Sensor-Surface: 2mm (Mechanical Surface Detection)
- Electronics: DAE4 Sn1438; Calibrated: 11/04/2019
- Phantom: Twin SAM A (Site 65); Type: SAM 5.0; Serial: SN1818
- ; SEMCAD X Version 14.6.10 (7417)

Configuration/d=10mm, Pin=250mW/Area Scan (101x101x1): Interpolated grid: dx=1.000 mm, dy=1.000 mm

Maximum value of SAR (interpolated) = 16.0 W/kg

Configuration/d=10mm, Pin=250mW/Zoom Scan (9x9x16)/Cube 0: Measurement grid: dx=4mm, dy=4mm, dz=1.4mm

Reference Value = 88.95 V/m; Power Drift = 0.01 dB

Peak SAR (extrapolated) = 27.8 W/kg

SAR(1 g) = 13.8 W/kg; SAR(10 g) = 6.33 W/kg

Maximum value of SAR (measured) = 21.2 W/kg

CERTIFICATE OF CALIBRATION

ISSUED BY UL VS LTD

UKAS Accredited Calibration Laboratory No. 5248

CERTIFICATE
NUMBER :
13252596JD01A

Page 9 of 10

Impedance Measurement Plot for Body Stimulating Liquid (MSL)

3/12/2020 8:58:54 AM
1328.5170K92-100151-MV

Trc1 — S11 Smith 200 mU/ Ref 1 U Cal

1

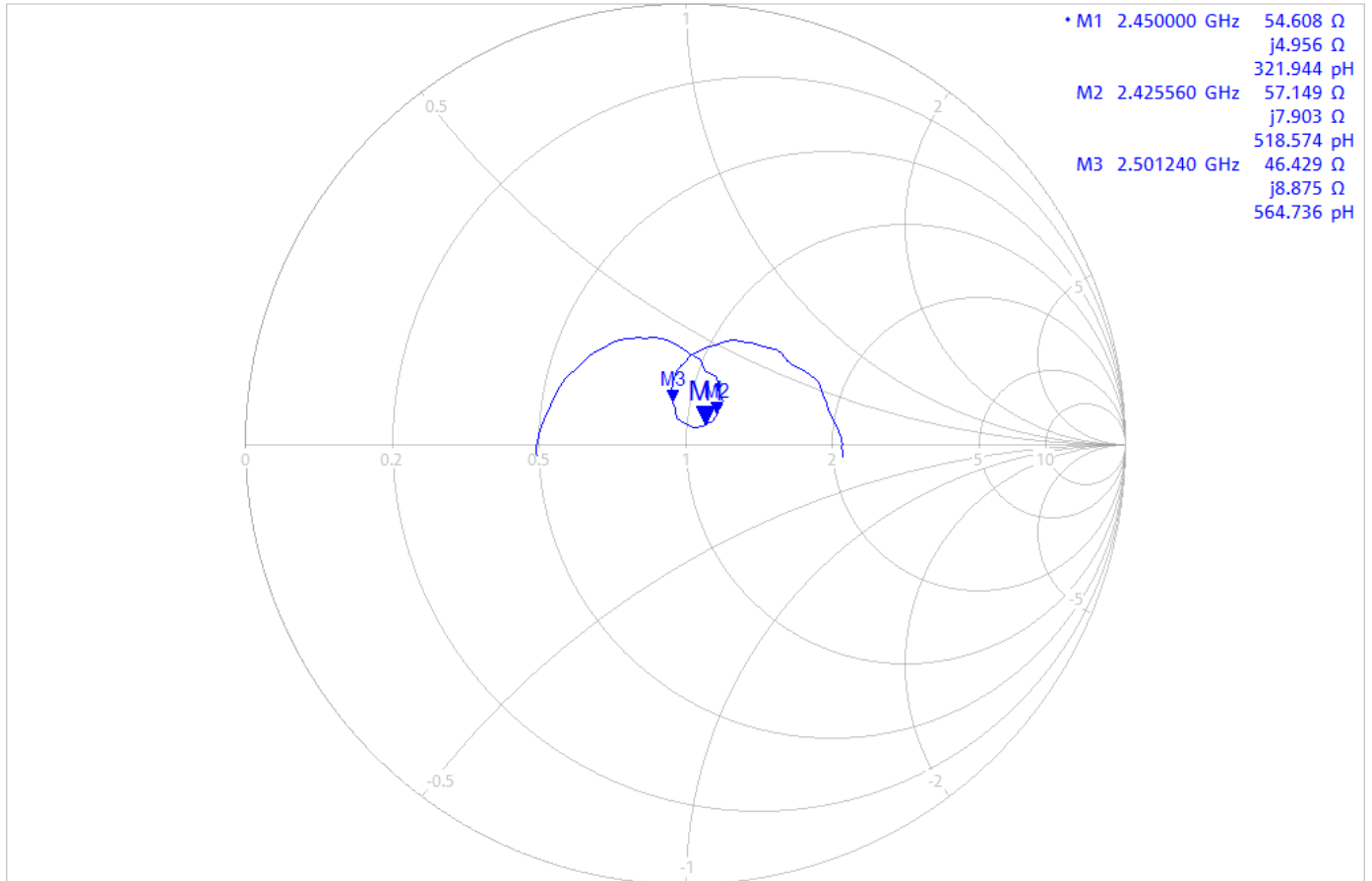

Ch1 Center 2.45 GHz

Pwr -10 dBm Bw 10 kHz

Span 400 MHz

CERTIFICATE OF CALIBRATION

ISSUED BY UL VS LTD

UKAS Accredited Calibration Laboratory No. 5248

CERTIFICATE
NUMBER :
13252596JD01A

Page 10 of 10

Return Loss Measurement Plot for Body Stimulating Liquid (MSL)

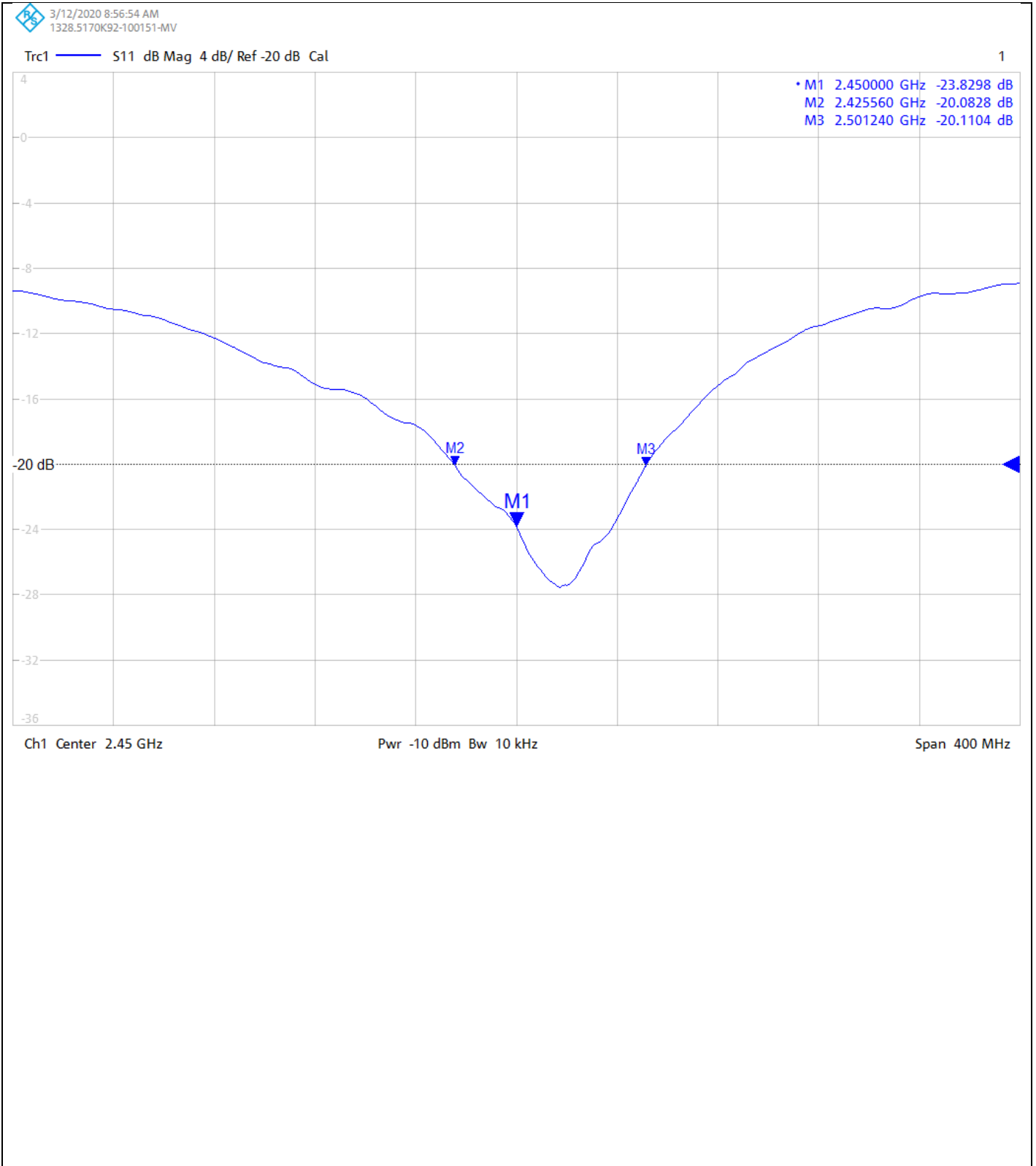

Calibration Certificate Label:

 <p>UKAS CALIBRATION 5248</p>	<p>UL VS LTD - Tel: +44 (0) 1256312000</p> <p>Certificate Number: 13252596JD01A</p> <p>Instrument ID: 748</p> <p>Calibration Date: 12/Mar/2020</p> <p>Calibration Due Date:</p>
------------------------------------------------------------------------------------------------------------------------	----------------------------------------------------------------------------------------------------------------------------------------------------------------------------------------

 <p>UKAS CALIBRATION 5248</p>	<p>UL VS LTD - Tel: +44 (0) 1256312000</p> <p>Certificate Number: 13252596JD01A</p> <p>Instrument ID: 748</p> <p>Calibration Date: 12/Mar/2020</p> <p>Calibration Due Date:</p>
------------------------------------------------------------------------------------------------------------------------	----------------------------------------------------------------------------------------------------------------------------------------------------------------------------------------

 <p>UKAS CALIBRATION 5248</p>	<p>UL VS LTD - Tel: +44 (0) 1256312000</p> <p>Certificate Number: 13252596JD01A</p> <p>Instrument ID: 748</p> <p>Calibration Date: 12/Mar/2020</p> <p>Calibration Due Date:</p>
--------------------------------------------------------------------------------------------------------------------------	----------------------------------------------------------------------------------------------------------------------------------------------------------------------------------------

32 CERTIFICATE OF CALIBRATION

ISSUED BY **UL VS LTD**

DATE OF ISSUE: 17/Apr/2020

CERTIFICATE NUMBER : 13252595JD01D



5248

UL VS LTD
UNIT 1-3 HORIZON
KINGSLAND PARK, WADE ROAD
BASINGSTOKE, HAMPSHIRE
RG24 8AH, UK
TEL: +44 (0) 1256 312000
FAX: +44 (0) 1256 312001
Email: LST.UK.Calibration@ul.com



Page 1 of 10

APPROVED SIGNATORY

.....
Naseer Mirza

Customer :

UL VS Inc
47173 Benicia Street
Fremont, CA 94538, USA

Equipment Details:

Description:	Dipole Validation Kit	Date of Receipt:	14/Apr/2020
Manufacturer:	Speag		
Type/Model Number:	D2600V2		
Serial Number:	1036		
Calibration Date:	17/Apr/2020		
Calibrated By:	Masood Khan Test Engineer		

Signature:

.....

All Calibration have been conducted in the closed laboratory facility: Lab Temperature (22±3) °C and humidity < 70%

This certificate is issued in accordance with the laboratory accreditation requirements of the United Kingdom Accreditation Service. It provides traceability of measurement to the SI system of units and/or to units of measurement realised at the National Physical Laboratory or other recognised national metrology institutes. This certificate may not be reproduced other than in full, except with the prior written approval of the issuing laboratory.

Use of the UKAS mark demonstrates that compliance with the requirements of BS/EN/ISO/IEC 17025 has been independently assessed.

CERTIFICATE OF CALIBRATION

ISSUED BY UL VS LTD

UKAS Accredited Calibration Laboratory No. 5248

CERTIFICATE
NUMBER :
13252595JD01D

Page 2 of 10

The calibration methods and procedures used were as detailed in:

1. **IEC 62209-1:2016**: Procedure to determine the specific absorption rate (SAR) for hand-held devices used in close proximity to the ear (frequency range of 300 MHz to 3 GHz)
2. **IEC 62209-2:2010**: Procedure to determine the specific absorption rate (SAR) for wireless communication devices used in close proximity to the human body (frequency range of 30 MHz to 6 GHz)
3. **IEEE 1528: 2013**: IEEE Recommended Practice for Determining the Peak Spatial-Average Specific Absorption Rate (SAR) in the Human Head from Wireless Communication Devices: Measurement Techniques
4. FCC KDB Publication Number: “**KDB865664 D01 SAR Measurement 100 MHz to 6 GHz**”
5. **SPEAG DASY5 System Handbook**

The measuring equipment used to perform the calibration, documented in this certificate has been calibrated in accordance with the manufacturers' recommendations, and is traceable to recognized national standards.

UL No.	Instrument	Manufacturer	Type No.	Serial No.	Date Last Calibrated	Cal. Interval (Months)
PRE0178317	Data Acquisition Electronics	SPEAG	DAE4	1542	17 Mar 2020	12
PRE0178314	Probe	SPEAG	EX3DV4	7496	24 Mar 2020	12
PRE0135603	Dipole	SPEAG	D2600V2	1109	14 Feb 2020	12
PRE0131118	Power Sensor	Rhode & Schwarz	NRV-Z1	826515/015	27 Jan 2020	12
PRE0134023	Power Sensor	Rhode & Schwarz	NRV-Z1	860462/016	27 Jan 2020	12
PRE0151154	Vector Network Analyser	Rhode & Schwarz	ZND	100151	30 Jan 2020	12
PRE0151877	Calibration Kit	Rhode & Schwarz	ZV-Z135	102947	17 Oct 2019	12
PRE0178154	Signal Generator	Rhode & Schwarz	SMIQ 03B	1125.555.03	23 Jan 2020	12

CERTIFICATE OF CALIBRATION

ISSUED BY UL VS LTD

UKAS Accredited Calibration Laboratory No. 5248

CERTIFICATE
NUMBER :
13252595JD01D

Page 3 of 10

SAR System Specification

Robot System Positioner:	Stäubli Unimation Corp. Robot Model: TX60L
Robot Serial Number:	F17/5ENYG1/A/01
DASY Version:	DASY 52 (v52.10.0.1446)
Phantom:	Flat section of SAM Twin Phantom
Distance Dipole Centre:	10 mm (with spacer)
Frequency:	2600 MHz

Dielectric Property Measurements – Head Simulating Liquid (HSL)

Simulant Liquid	Frequency (MHz)	Room Temp		Liquid Temp		Parameters	Target Value	Measured Value	Uncertainty (%)
		Start	End	Start	End				
Head	2600	20.5 °C	21.0 °C	20.9°C	21.1°C	ϵ_r	39.00	39.88	± 5%
						σ	1.96	1.93	± 5%

SAR Results – Head Simulating Liquid (HSL)

Simulant Liquid	SAR Measured	250 mW input Power	Normalised to 1.00 W	Uncertainty (%)
Head	SAR averaged over 1g	14.20 W/Kg	56.53 W/Kg	± 17.57%
	SAR averaged over 10g	6.34 W/Kg	25.23 W/Kg	± 17.32%

Antenna Parameters – Head Simulating Liquid (HSL)

Simulant Liquid	Parameter	Measured Level	Uncertainty (%)
Head	Impedance	51.234 Ω ± 4.85 j Ω	± 0.28 Ω ± 0.044 j Ω
	Return Loss	-26.09	± 2.03 dB

CERTIFICATE OF CALIBRATION

ISSUED BY UL VS LTD

UKAS Accredited Calibration Laboratory No. 5248

CERTIFICATE
NUMBER :
13252595JD01D

Page 4 of 10

Dielectric Property Measurements – Body Simulating Liquid (MSL)

Simulant Liquid	Frequency (MHz)	Room Temp		Liquid Temp		Parameters	Target Value	Measured Value	Uncertainty (%)
		Start	End	Start	End				
Body	2600	21.5 °C	21.0 °C	21.0°C	21.1°C	ϵ_r	52.50	52.07	± 5%
						σ	2.16	2.12	± 5%

SAR Results – Body Simulating Liquid (MSL)

Simulant Liquid	SAR Measured	250 mW input Power	Normalised to 1.00 W	Uncertainty (%)
Body	SAR averaged over 1g	14.30 W/Kg	56.92 W/Kg	± 18.06%
	SAR averaged over 10g	6.33 W/Kg	25.20 W/Kg	± 17.44%

Antenna Parameters – Body Simulating Liquid (MSL)

Simulant Liquid	Parameter	Measured Level	Uncertainty (%)
Body	Impedance	47.60 Ω ± 4.39 j Ω	± 0.28 Ω ± 0.044 j Ω
	Return Loss	-25.81	± 2.03 dB

CERTIFICATE OF CALIBRATION

ISSUED BY UL VS LTD

UKAS Accredited Calibration Laboratory No. 5248

CERTIFICATE
NUMBER :
13252595JD01D

Page 5 of 10

DASY Validation Scan for Head Stimulating Liquid (HSL)

DUT: D2600V2 - SN1036; Type: D2600V2; Serial: SN1036

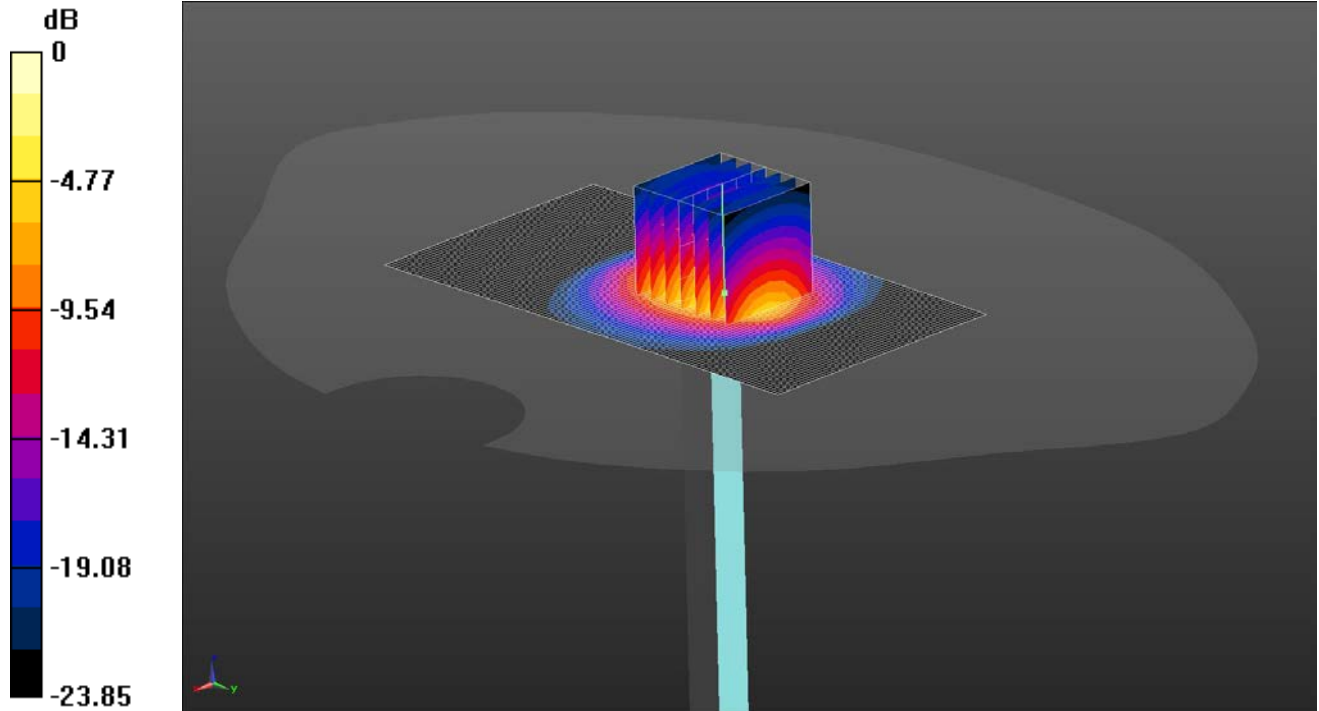

0 dB = 24.5 W/kg = 13.89 dBW/kg

Communication System: UID 0, CW (0); Frequency: 2600 MHz; Duty Cycle: 1:1;
Medium: Site65_14Apr2020_180909_Head - 750 2300 2450 2600; Medium parameters used: $f = 2600$ MHz; $\sigma = 1.935$ S/m; $\epsilon_r = 39.884$; $\rho = 1000$ kg/m³;

Phantom section: Flat Section ;

DASY5 Configuration:

- Probe: EX3DV4 - SN7496; ConvF(7.6, 7.6, 7.6); Calibrated: 24/03/2020;
- Sensor-Surface: 3mm (Mechanical Surface Detection), Sensor-Surface: 1.4mm (Mechanical Surface Detection);
- Electronics: DAE4 Sn1542; Calibrated: 17/03/2020;
- Phantom: Twin-SAM B (Site 65); Type: QD 000 P40 CC; Serial: 1945;
- Measurement SW: DASY52, Version 52.10 (0); SEMCAD X Version 14.6.10 (7417) ;

2600/d=10mm, Pin=250 mW 2/Area Scan (61x111x1): Interpolated grid: dx=1.200 mm, dy=1.200 mm

Maximum value of SAR (interpolated) = 19.4 W/kg

2600/d=10mm, Pin=250 mW 2/Zoom Scan (7x7x5)/Cube 0: Measurement grid: dx=5mm, dy=5mm, dz=4mm

Reference Value = 87.99 V/m; Power Drift = 0.11 dB

Peak SAR (extrapolated) = 31.2 W/kg

SAR(1 g) = 14.2 W/kg; SAR(10 g) = 6.34 W/kg

Maximum value of SAR (measured) = 24.5 W/kg

CERTIFICATE OF CALIBRATION

ISSUED BY UL VS LTD

CERTIFICATE
NUMBER :
13252595JD01D

UKAS Accredited Calibration Laboratory No. 5248

Page 6 of 10

Impedance Measurement Plot for Head Stimulating Liquid (HSL)

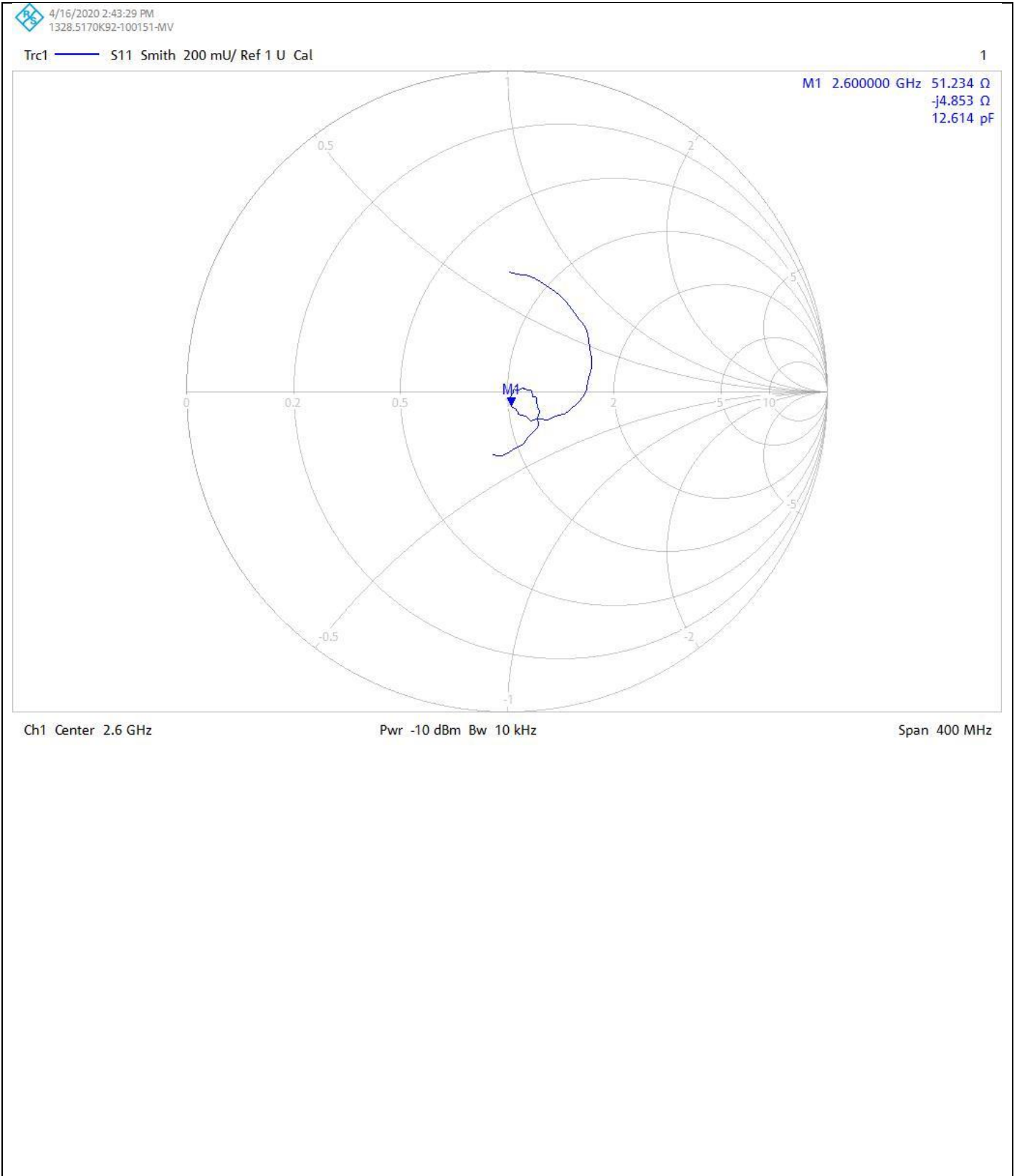

CERTIFICATE OF CALIBRATION

ISSUED BY UL VS LTD

UKAS Accredited Calibration Laboratory No. 5248

CERTIFICATE
NUMBER :
13252595JD01D

Page 7 of 10

Return Loss Measurement Plot for Head Stimulating Liquid (HSL)

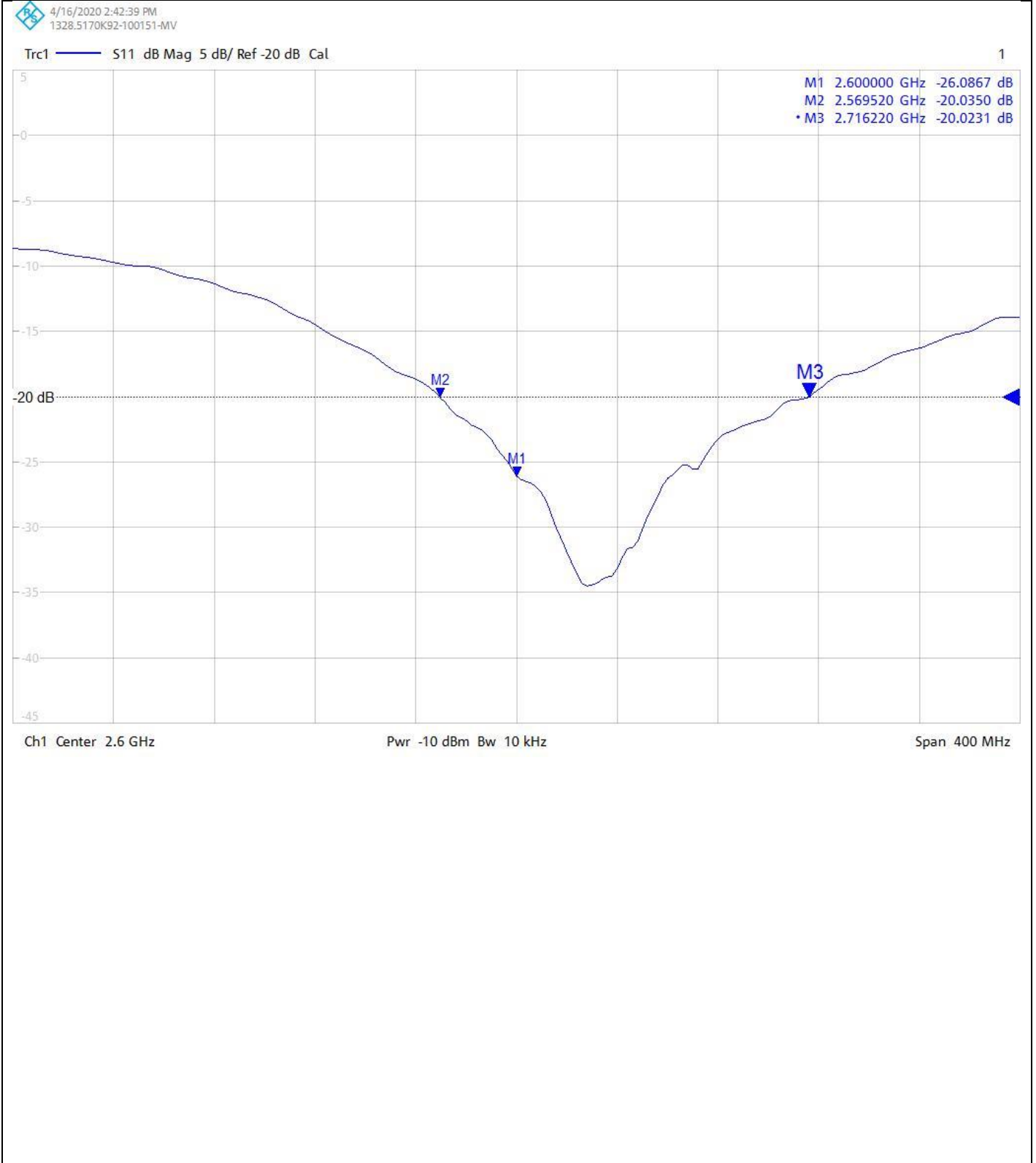

CERTIFICATE OF CALIBRATION

ISSUED BY UL VS LTD

UKAS Accredited Calibration Laboratory No. 5248

CERTIFICATE
NUMBER :
13252595JD01D

Page 8 of 10

DASY Validation Scan for Body Stimulating Liquid (MSL)

DUT: D2600V2 - SN1036; Type: D2600V2; Serial: SN1036

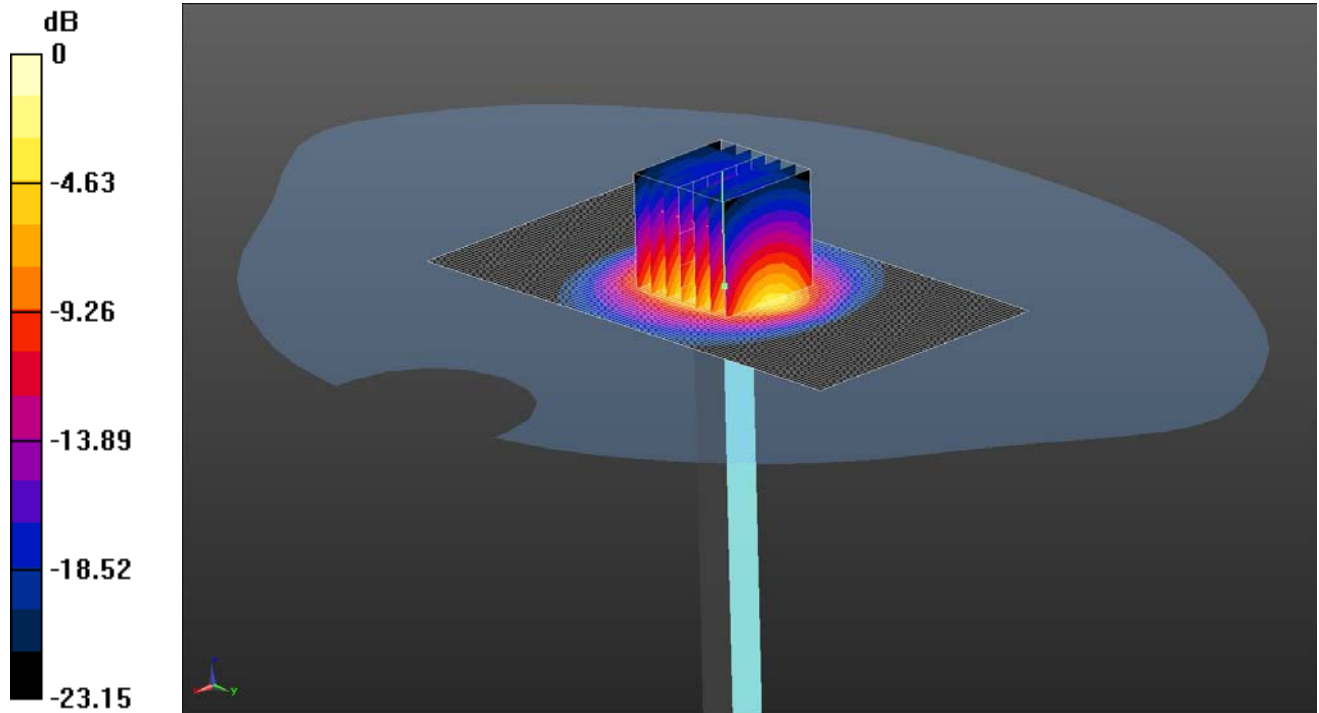

0 dB = 24.6 W/kg = 13.91 dBW/kg

Communication System: UID 0, CW (0); Frequency: 2600 MHz; Duty Cycle: 1:1;
Medium: Site65_15Apr2020_140023_Body - 750 2300 2450 2600 5%; Medium parameters used: $f = 2600$ MHz; $\sigma = 2.125$ S/m; $\epsilon_r = 52.07$; $\rho = 1000$ kg/m³;

Phantom section: Flat Section ;

DASY5 Configuration:

- Probe: EX3DV4 - SN7496; ConvF(7.58, 7.58, 7.58); Calibrated: 24/03/2020;

- Sensor-Surface: 1.4mm (Mechanical Surface Detection);

- Electronics: DAE4 Sn1542; Calibrated: 17/03/2020;

- Phantom: Twin SAM A (Site 65); Type: SAM 5.0; Serial: SN1818;

- Measurement SW: DASY52, Version 52.10 (0); SEMCAD X Version 14.6.10 (7417) ;

2600/d=10mm, Pin=250 mW 2/Area Scan (61x111x1): Interpolated grid: dx=1.200 mm, dy=1.200 mm

Maximum value of SAR (interpolated) = 26.1 W/kg

2600/d=10mm, Pin=250 mW 2/Zoom Scan (7x7x5)/Cube 0: Measurement grid: dx=5mm, dy=5mm, dz=4mm

Reference Value = 111.4 V/m; Power Drift = 0.00 dB

Peak SAR (extrapolated) = 31.1 W/kg

SAR(1 g) = 14.3 W/kg; SAR(10 g) = 6.33 W/kg

Maximum value of SAR (measured) = 24.6 W/kg

CERTIFICATE OF CALIBRATION

ISSUED BY UL VS LTD

UKAS Accredited Calibration Laboratory No. 5248

CERTIFICATE
NUMBER :
13252595JD01D

Page 9 of 10

Impedance Measurement Plot for Body Stimulating Liquid (MSL)

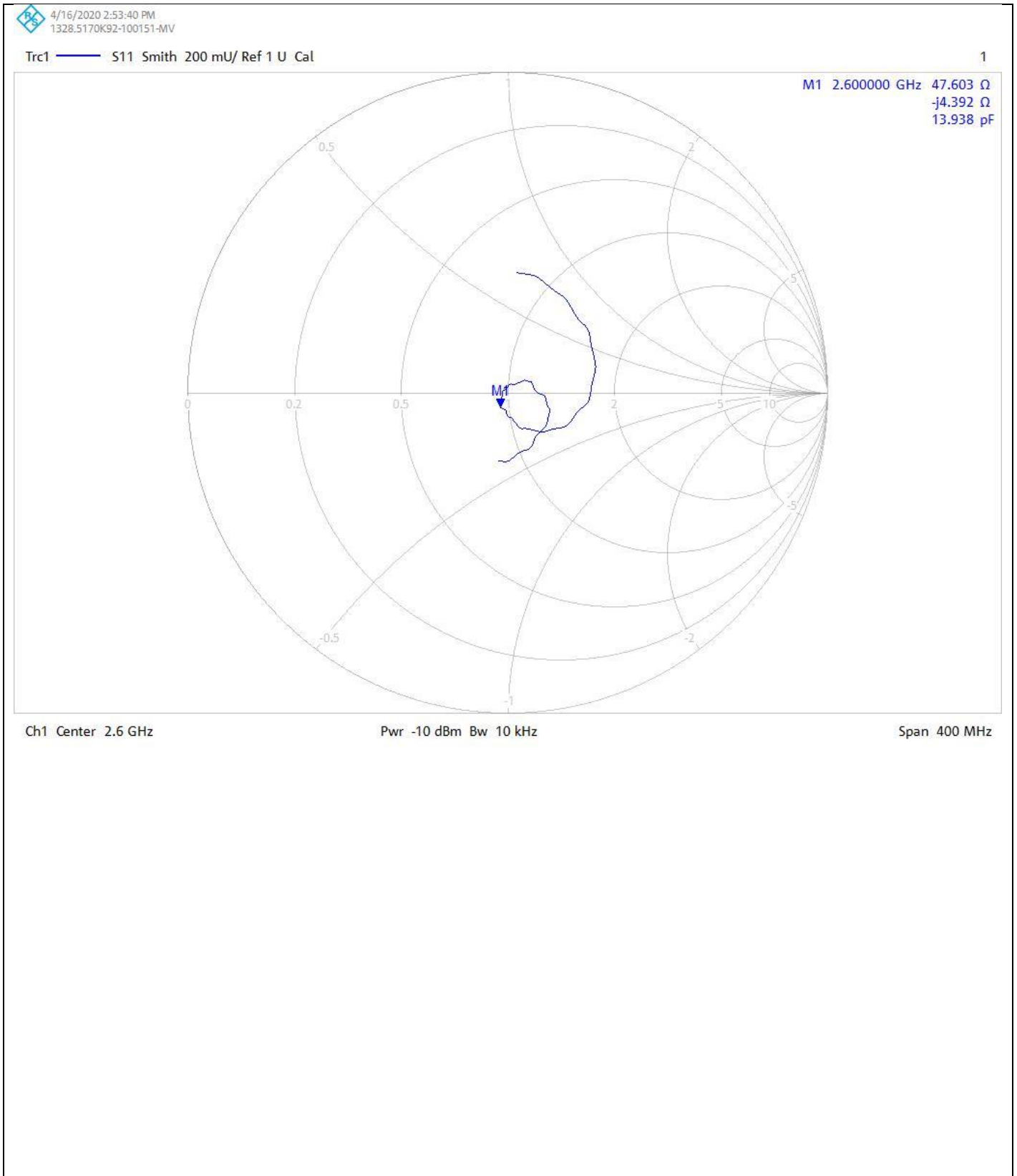

CERTIFICATE OF CALIBRATION

ISSUED BY UL VS LTD

UKAS Accredited Calibration Laboratory No. 5248

CERTIFICATE
NUMBER :
13252595JD01D

Page 10 of 10

Return Loss Measurement Plot for Body Stimulating Liquid (MSL)

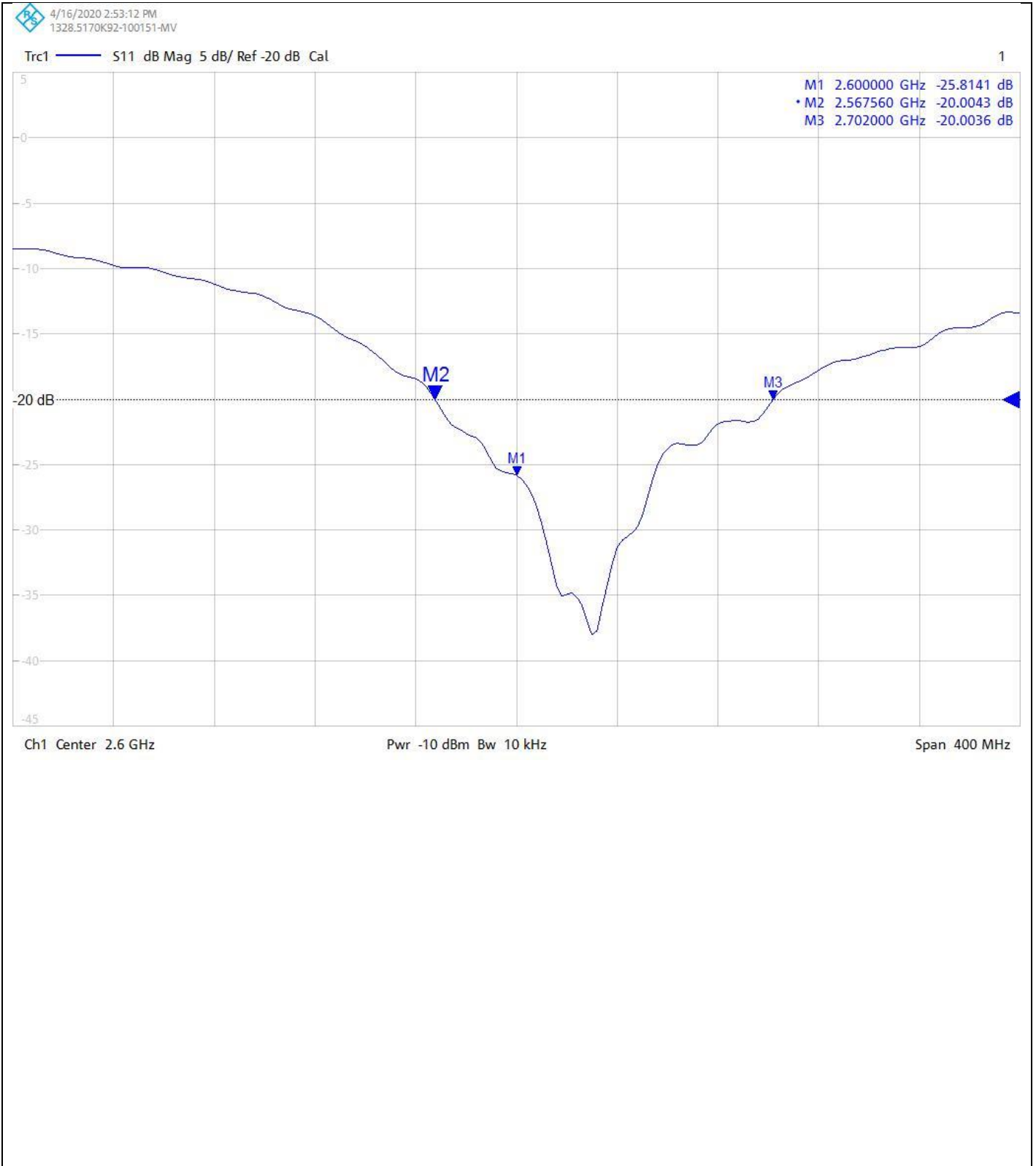

Calibration Certificate Label:

 <p>UKAS CALIBRATION 5248</p>	<p>UL VS LTD - Tel: +44 (0) 1256312000</p> <p>Certificate Number: 13252595JD01D</p> <p>Instrument ID: 1036</p> <p>Calibration Date: 17/Apr/2020</p> <p>Calibration Due Date:</p>
------------------------------------------------------------------------------------------------------------------------	-----------------------------------------------------------------------------------------------------------------------------------------------------------------------------------------

 <p>UKAS CALIBRATION 5248</p>	<p>UL VS LTD - Tel: +44 (0) 1256312000</p> <p>Certificate Number: 13252595JD01D</p> <p>Instrument ID: 1036</p> <p>Calibration Date: 17/Apr/2020</p> <p>Calibration Due Date:</p>
------------------------------------------------------------------------------------------------------------------------	-----------------------------------------------------------------------------------------------------------------------------------------------------------------------------------------

 <p>UKAS CALIBRATION 5248</p>	<p>UL VS LTD - Tel: +44 (0) 1256312000</p> <p>Certificate Number: 13252595JD01D</p> <p>Instrument ID: 1036</p> <p>Calibration Date: 17/Apr/2020</p> <p>Calibration Due Date:</p>
--------------------------------------------------------------------------------------------------------------------------	-----------------------------------------------------------------------------------------------------------------------------------------------------------------------------------------



Accredited by the Swiss Accreditation Service (SAS)
The Swiss Accreditation Service is one of the signatories to the EA
Multilateral Agreement for the recognition of calibration certificates

Accreditation No.: **SCS 0108**

Client **UL CCS USA**

Certificate No: **D2600V2-1006_Oct19**

CALIBRATION CERTIFICATE

Object **D2600V2 - SN:1006**

Calibration procedure(s) **QA CAL-05.v11
Calibration Procedure for SAR Validation Sources between 0.7-3 GHz**

Calibration date: **October 14, 2019**

This calibration certificate documents the traceability to national standards, which realize the physical units of measurements (SI).
The measurements and the uncertainties with confidence probability are given on the following pages and are part of the certificate.

All calibrations have been conducted in the closed laboratory facility: environment temperature (22 ± 3)°C and humidity < 70%.

Calibration Equipment used (M&TE critical for calibration)

Primary Standards	ID #	Cal Date (Certificate No.)	Scheduled Calibration
Power meter NRP	SN: 104778	03-Apr-19 (No. 217-02892/02893)	Apr-20
Power sensor NRP-Z91	SN: 103244	03-Apr-19 (No. 217-02892)	Apr-20
Power sensor NRP-Z91	SN: 103245	03-Apr-19 (No. 217-02893)	Apr-20
Reference 20 dB Attenuator	SN: 5058 (20k)	04-Apr-19 (No. 217-02894)	Apr-20
Type-N mismatch combination	SN: 5047.2 / 06327	04-Apr-19 (No. 217-02895)	Apr-20
Reference Probe EX3DV4	SN: 7349	29-May-19 (No. EX3-7349_May19)	May-20
DAE4	SN: 601	30-Apr-19 (No. DAE4-601_Apr19)	Apr-20

Secondary Standards	ID #	Check Date (in house)	Scheduled Check
Power meter E4419B	SN: GB39512475	30-Oct-14 (in house check Feb-19)	In house check: Oct-20
Power sensor HP 8481A	SN: US37292783	07-Oct-15 (in house check Oct-18)	In house check: Oct-20
Power sensor HP 8481A	SN: MY41092317	07-Oct-15 (in house check Oct-18)	In house check: Oct-20
RF generator R&S SMT-06	SN: 100972	15-Jun-15 (in house check Oct-18)	In house check: Oct-20
Network Analyzer Agilent E8358A	SN: US41080477	31-Mar-14 (in house check Oct-18)	In house check: Oct-19

	Name	Function	Signature
Calibrated by:	Michael Weber	Laboratory Technician	
Approved by:	Katja Pokovic	Technical Manager	

Issued: October 15, 2019

This calibration certificate shall not be reproduced except in full without written approval of the laboratory.

Measurement Conditions

DASY system configuration, as far as not given on page 1.

DASY Version	DASY5	V52.10.3
Extrapolation	Advanced Extrapolation	
Phantom	Modular Flat Phantom	
Distance Dipole Center - TSL	10 mm	with Spacer
Zoom Scan Resolution	dx, dy, dz = 5 mm	
Frequency	2600 MHz ± 1 MHz	

Head TSL parameters

The following parameters and calculations were applied.

	Temperature	Permittivity	Conductivity
Nominal Head TSL parameters	22.0 °C	39.0	1.96 mho/m
Measured Head TSL parameters	(22.0 ± 0.2) °C	37.4 ± 6 %	2.04 mho/m ± 6 %
Head TSL temperature change during test	< 0.5 °C	----	----

SAR result with Head TSL

SAR averaged over 1 cm³ (1 g) of Head TSL	Condition	
SAR measured	250 mW input power	14.3 W/kg
SAR for nominal Head TSL parameters	normalized to 1W	55.7 W/kg ± 17.0 % (k=2)

SAR averaged over 10 cm³ (10 g) of Head TSL	condition	
SAR measured	250 mW input power	6.37 W/kg
SAR for nominal Head TSL parameters	normalized to 1W	25.1 W/kg ± 16.5 % (k=2)

Body TSL parameters

The following parameters and calculations were applied.

	Temperature	Permittivity	Conductivity
Nominal Body TSL parameters	22.0 °C	52.5	2.16 mho/m
Measured Body TSL parameters	(22.0 ± 0.2) °C	50.9 ± 6 %	2.21 mho/m ± 6 %
Body TSL temperature change during test	< 0.5 °C	----	----

SAR result with Body TSL

SAR averaged over 1 cm³ (1 g) of Body TSL	Condition	
SAR measured	250 mW input power	13.7 W/kg
SAR for nominal Body TSL parameters	normalized to 1W	53.9 W/kg ± 17.0 % (k=2)

SAR averaged over 10 cm³ (10 g) of Body TSL	condition	
SAR measured	250 mW input power	6.11 W/kg
SAR for nominal Body TSL parameters	normalized to 1W	24.2 W/kg ± 16.5 % (k=2)

Appendix (Additional assessments outside the scope of SCS 0108)

Antenna Parameters with Head TSL

Impedance, transformed to feed point	49.1 Ω - 4.8 j Ω
Return Loss	- 26.1 dB

Antenna Parameters with Body TSL

Impedance, transformed to feed point	46.2 Ω - 3.7 j Ω
Return Loss	- 25.2 dB

General Antenna Parameters and Design

Electrical Delay (one direction)	1.153 ns
----------------------------------	----------

After long term use with 100W radiated power, only a slight warming of the dipole near the feedpoint can be measured.

The dipole is made of standard semirigid coaxial cable. The center conductor of the feeding line is directly connected to the second arm of the dipole. The antenna is therefore short-circuited for DC-signals. On some of the dipoles, small end caps are added to the dipole arms in order to improve matching when loaded according to the position as explained in the "Measurement Conditions" paragraph. The SAR data are not affected by this change. The overall dipole length is still according to the Standard.

No excessive force must be applied to the dipole arms, because they might bend or the soldered connections near the feedpoint may be damaged.

Additional EUT Data

Manufactured by	SPEAG
-----------------	-------

DASY5 Validation Report for Head TSL

Date: 14.10.2019

Test Laboratory: SPEAG, Zurich, Switzerland

DUT: Dipole 2600 MHz; Type: D2600V2; Serial: D2600V2 - SN:1006

Communication System: UID 0 - CW; Frequency: 2600 MHz

Medium parameters used: $f = 2600$ MHz; $\sigma = 2.04$ S/m; $\epsilon_r = 37.4$; $\rho = 1000$ kg/m³

Phantom section: Flat Section

Measurement Standard: DASY5 (IEEE/IEC/ANSI C63.19-2011)

DASY52 Configuration:

- Probe: EX3DV4 - SN7349; ConvF(7.69, 7.69, 7.69) @ 2600 MHz; Calibrated: 29.05.2019
- Sensor-Surface: 1.4mm (Mechanical Surface Detection)
- Electronics: DAE4 Sn601; Calibrated: 30.04.2019
- Phantom: Flat Phantom 5.0 (front); Type: QD 000 P50 AA; Serial: 1001
- DASY52 52.10.3(1513); SEMCAD X 14.6.13(7474)

Dipole Calibration for Head Tissue/Pin=250 mW, d=10mm/Zoom Scan (7x7x7)/Cube 0:

Measurement grid: dx=5mm, dy=5mm, dz=5mm

Reference Value = 117.6 V/m; Power Drift = 0.03 dB

Peak SAR (extrapolated) = 28.5 W/kg

SAR(1 g) = 14.3 W/kg; SAR(10 g) = 6.37 W/kg

Smallest distance from peaks to all points 3 dB below = 8.9 mm

Ratio of SAR at M2 to SAR at M1 = 50.1%

Maximum value of SAR (measured) = 23.8 W/kg

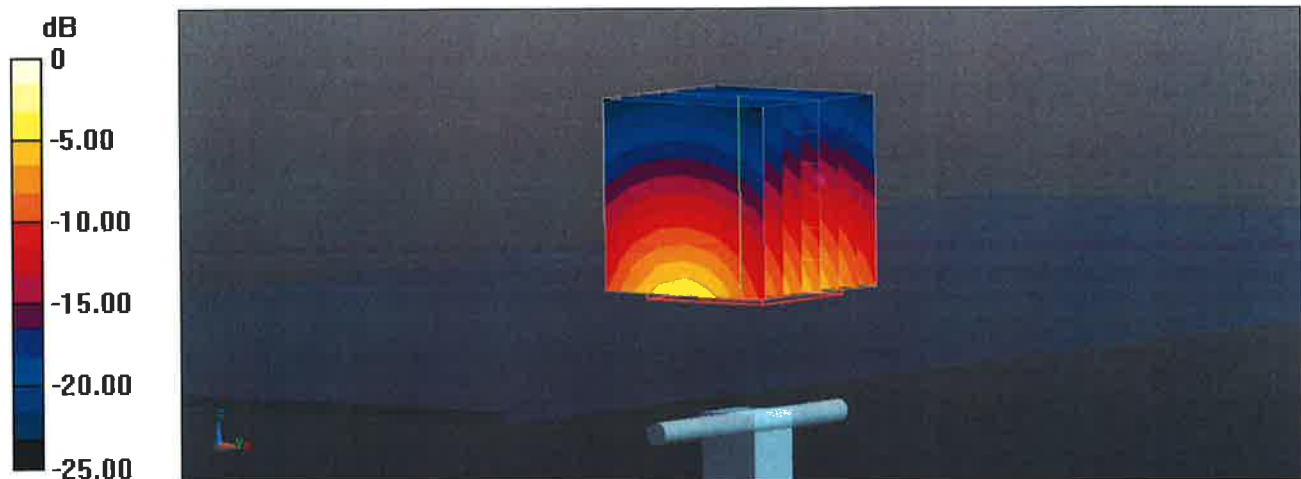

Test Laboratory: SPEAG, Zurich, Switzerland

DUT: Dipole 2600 MHz; Type: D2600V2; Serial: D2600V2 - SN:1006

Communication System: UID 0 - CW; Frequency: 2600 MHz

Medium parameters used: $f = 2600$ MHz; $\sigma = 2.21$ S/m; $\epsilon_r = 50.9$; $\rho = 1000$ kg/m³

Phantom section: Flat Section

Measurement Standard: DASY5 (IEEE/IEC/ANSI C63.19-2011)

DASY52 Configuration:

- Probe: EX3DV4 - SN7349; ConvF(7.8, 7.8, 7.8) @ 2600 MHz; Calibrated: 29.05.2019
- Sensor-Surface: 1.4mm (Mechanical Surface Detection)
- Electronics: DAE4 Sn601; Calibrated: 30.04.2019
- Phantom: Flat Phantom 5.0 (back); Type: QD 000 P50 AA; Serial: 1002
- DASY52 52.10.3(1513); SEMCAD X 14.6.13(7474)

Dipole Calibration for Body Tissue/Pin=250 mW, d=10mm/Zoom Scan (7x7x7)/Cube 0:

Measurement grid: dx=5mm, dy=5mm, dz=5mm

Reference Value = 109.0 V/m; Power Drift = -0.04 dB

Peak SAR (extrapolated) = 27.9 W/kg

SAR(1 g) = 13.7 W/kg; SAR(10 g) = 6.11 W/kg

Smallest distance from peaks to all points 3 dB below = 8.5 mm

Ratio of SAR at M2 to SAR at M1 = 49.8%

Maximum value of SAR (measured) = 22.8 W/kg

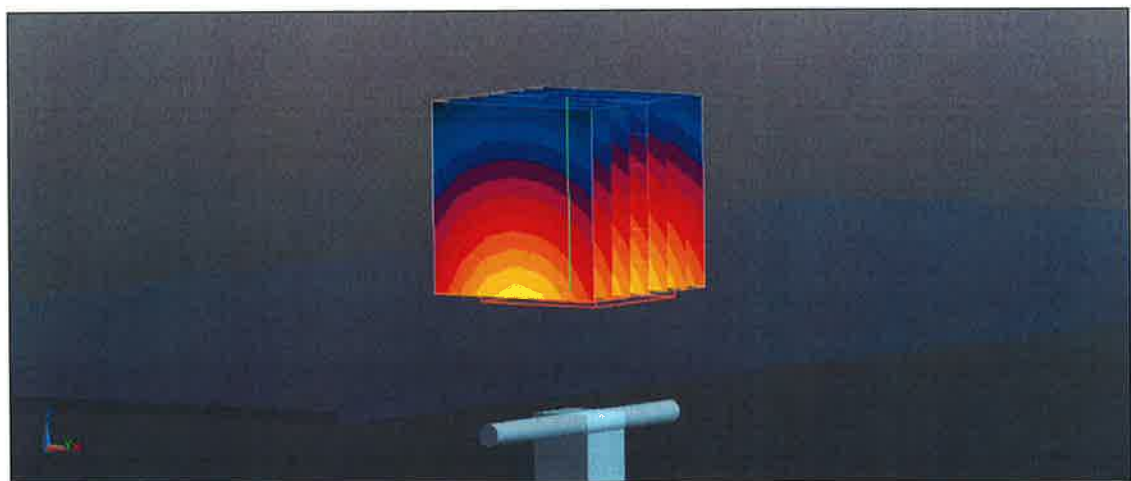
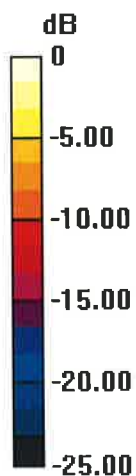

0 dB = 22.8 W/kg = 13.58 dBW/kg

CERTIFICATE OF CALIBRATION

ISSUED BY **UL VS LTD**

DATE OF ISSUE: 17/Apr/2020

CERTIFICATE NUMBER : 13252595JD01E



5248

UL VS LTD
UNIT 1-3 HORIZON
KINGSLAND PARK, WADE ROAD
BASINGSTOKE, HAMPSHIRE
RG24 8AH, UK
TEL: +44 (0) 1256 312000
FAX: +44 (0) 1256 312001
Email: LST.UK.Calibration@ul.com



Page 1 of 10

APPROVED SIGNATORY

A handwritten signature in blue ink, appearing to read 'M. Nasir', is written over a horizontal line.

.....
Naseer Mirza

Customer :

UL VS Inc
47173 Benicia Street
Fremont, CA 94538, USA

Equipment Details:

Description:	Dipole Validation Kit	Date of Receipt:	14/Apr/2018
Manufacturer:	SPEAG		
Type/Model Number:	D3500V2		
Serial Number:	1011		
Calibration Date:	17/Apr/2020		
Calibrated By:	Masood Khan Test Engineer		
Signature:	A handwritten signature in blue ink, appearing to read 'Masood Khan', is written over a horizontal line.		

All Calibration have been conducted in the closed laboratory facility: Lab Temperature (22±3) °C and humidity < 70%

This certificate is issued in accordance with the laboratory accreditation requirements of the United Kingdom Accreditation Service. It provides traceability of measurement to the SI system of units and/or to units of measurement realised at the National Physical Laboratory or other recognised national metrology institutes. This certificate may not be reproduced other than in full, except with the prior written approval of the issuing laboratory.

Use of the UKAS mark demonstrates that compliance with the requirements of BS/EN/ISO/IEC 17025 has been independently assessed.

CERTIFICATE OF CALIBRATION

ISSUED BY UL VS LTD

UKAS Accredited Calibration Laboratory No. 5248

CERTIFICATE
NUMBER :
13252595JD01E

Page 2 of 10

The calibration methods and procedures used were as detailed in:

1. **IEC 62209-1:2016**: Procedure to determine the specific absorption rate (SAR) for hand-held devices used in close proximity to the ear (frequency range of 300 MHz to 3 GHz)
2. **IEC 62209-2:2010**: Procedure to determine the specific absorption rate (SAR) for wireless communication devices used in close proximity to the human body (frequency range of 30 MHz to 6 GHz)
3. **IEEE 1528: 2013**: IEEE Recommended Practice for Determining the Peak Spatial-Average Specific Absorption Rate (SAR) in the Human Head from Wireless Communication Devices: Measurement Techniques
4. FCC KDB Publication Number: **“KDB865664 D01 SAR Measurement 100 MHz to 6 GHz”**
5. **SPEAG DASY5 System Handbook**

The measuring equipment used to perform the calibration, documented in this certificate has been calibrated in accordance with the manufacturers' recommendations, and is traceable to recognized national standards.

UL No.	Instrument	Manufacturer	Type No.	Serial No.	Date Last Calibrated	Cal. Interval (Months)
PRE0178317	Data Acquisition Electronics	SPEAG	DAE4	1542	17 Mar 2020	12
PRE0178314	Probe	SPEAG	EX3DV4	7496	24 Mar 2020	12
PRE0135600	Dipole	SPEAG	D3500V2	1044	14 Feb 2020	12
PRE0131118	Power Sensor	Rhode & Schwarz	NRV-Z1	826515/015	27 Jan 2020	12
PRE0134023	Power Sensor	Rhode & Schwarz	NRV-Z1	860462/016	27 Jan 2020	12
PRE0151154	Vector Network Analyser	Rhode & Schwarz	ZND	100151	30 Jan 2020	12
PRE0151877	Calibration Kit	Rhode & Schwarz	ZV-Z135	102947	17 Oct 2019	12
G0615	Signal Generator	Rhode & Schwarz	SMBV100A	260473	25 Feb 2020	12

CERTIFICATE OF CALIBRATION

ISSUED BY UL VS LTD

UKAS Accredited Calibration Laboratory No. 5248

CERTIFICATE
NUMBER :
13252595JD01E

Page 3 of 10

SAR System Specification

Robot System Positioner:	Stäubli Unimation Corp. Robot Model: TX60L
Robot Serial Number:	F17/5ENYG1/A/01
DASY Version:	DASY 52 (v52.10.0.1446)
Phantom:	Flat section of SAM Twin Phantom
Distance Dipole Centre:	10 mm (with spacer)
Frequency:	3500 MHz

Dielectric Property Measurements – Head Simulating Liquid (HSL)

Simulant Liquid	Frequency (MHz)	Room Temp		Liquid Temp		Parameters	Target Value	Measured Value	Uncertainty (%)
		Start	End	Start	End				
Head	3500	21.0 °C	21.5 °C	20.1 °C	21.1 °C	ϵ_r	37.90	37.34	± 5%
						σ	2.91	2.91	± 5%

SAR Results – Head Simulating Liquid (HSL)

Simulant Liquid	SAR Measured	250 mW input Power	Normalised to 1.00 W	Uncertainty (%)
Head	SAR averaged over 1g	17.3 W/Kg	68.87 W/Kg	± 18.75%
	SAR averaged over 10g	6.65 W/Kg	26.47 W/Kg	± 18.63%

Antenna Parameters – Head Simulating Liquid (HSL)

Simulant Liquid	Parameter	Measured Level	Uncertainty (%)
Head	Impedance	54.226 Ω ± -1.98 j Ω	± 0.28 Ω ± 0.044 j Ω
	Return Loss	-26.99	± 2.03 dB

CERTIFICATE OF CALIBRATION

ISSUED BY UL VS LTD

UKAS Accredited Calibration Laboratory No. 5248

CERTIFICATE
NUMBER :
13252595JD01E

Page 4 of 10

Dielectric Property Measurements – Body Simulating Liquid (MSL)

Simulant Liquid	Frequency (MHz)	Room Temp		Liquid Temp		Parameters	Target Value	Measured Value	Uncertainty (%)
		Start	End	Start	End				
Body	3500	21.0 °C	21.5 °C	19.1°C	20.0°C	ϵ_r	51.30	50.75	± 5%
						σ	3.31	3.17	± 5%

SAR Results – Body Simulating Liquid (MSL)

Simulant Liquid	SAR Measured	250 mW input Power	Normalised to 1.00 W	Uncertainty (%)
Body	SAR averaged over 1g	16.60 W/Kg	66.08 W/Kg	± 18.53%
	SAR averaged over 10g	6.30 W/Kg	25.08 W/Kg	± 18.61%

Antenna Parameters – Body Simulating Liquid (MSL)

Simulant Liquid	Parameter	Measured Level	Uncertainty (%)
Body	Impedance	53.40 Ω ± 0.629 j Ω	± 0.28 Ω ± 0.044 j Ω
	Return Loss	-29.59	± 2.03 dB

CERTIFICATE OF CALIBRATION

ISSUED BY UL VS LTD

UKAS Accredited Calibration Laboratory No. 5248

CERTIFICATE
NUMBER :
13252595JD01E

Page 5 of 10

DASY Validation Scan for Head Stimulating Liquid (HSL)

DUT: D3500V2 - SN1011; Type: D3500V2; Serial: SN1011

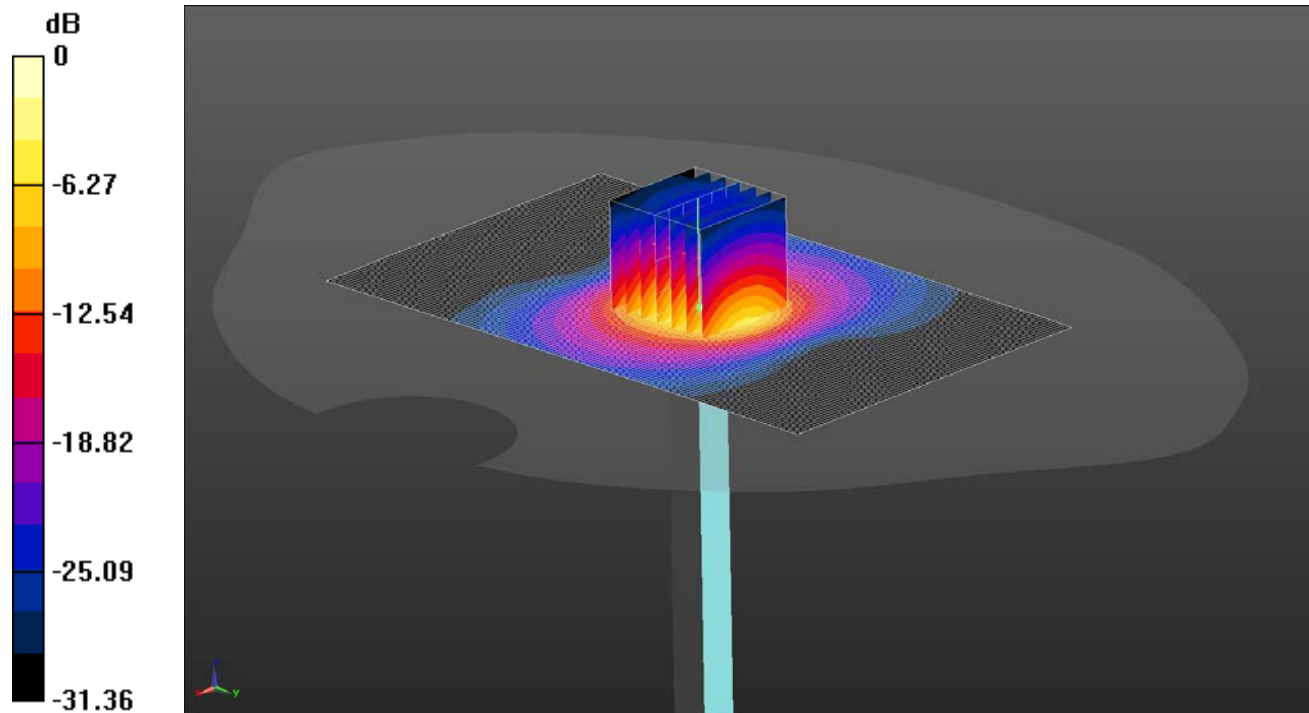

0 dB = 33.2 W/kg = 15.21 dBW/kg

Communication System: UID 0, CW (0); Frequency: 3500 MHz; Duty Cycle: 1:1;
Medium: Site65_14Apr2020_175947_Head - 3500 5%; Medium parameters used: $f = 3500$ MHz; $\sigma = 2.911$ S/m; $\epsilon_r = 37.345$; $\rho = 1000$ kg/m³;

Phantom section: Flat Section ;

DASY5 Configuration:

- Probe: EX3DV4 - SN7496; ConvF(6.79, 6.79, 6.79); Calibrated: 24/03/2020;
- Sensor-Surface: 3mm (Mechanical Surface Detection), Sensor-Surface: 1.4mm (Mechanical Surface Detection);
- Electronics: DAE4 Sn1542; Calibrated: 17/03/2020;
- Phantom: Twin-SAM B (Site 65); Type: QD 000 P40 CC; Serial: 1945;
- Measurement SW: DASY52, Version 52.10 (0); SEMCAD X Version 14.6.10 (7417) ;

Configuration/d=10mm, Pin=250mW 2/Area Scan (81x131x1): Interpolated grid: dx=1.200 mm, dy=1.200 mm

Maximum value of SAR (interpolated) = 25.2 W/kg

Configuration/d=10mm, Pin=250mW 2/Zoom Scan (5x5x7) (7x7x5)/Cube 0: Measurement grid: dx=5mm, dy=5mm, dz=4mm

Reference Value = 91.15 V/m; Power Drift = 0.10 dB

Peak SAR (extrapolated) = 45.4 W/kg

SAR(1 g) = 17.3 W/kg; SAR(10 g) = 6.65 W/kg

Maximum value of SAR (measured) = 33.2 W/kg

CERTIFICATE OF CALIBRATION

ISSUED BY UL VS LTD

CERTIFICATE
NUMBER :
13252595JD01E

UKAS Accredited Calibration Laboratory No. 5248

Page 6 of 10

Impedance Measurement Plot for Head Stimulating Liquid (HSL)

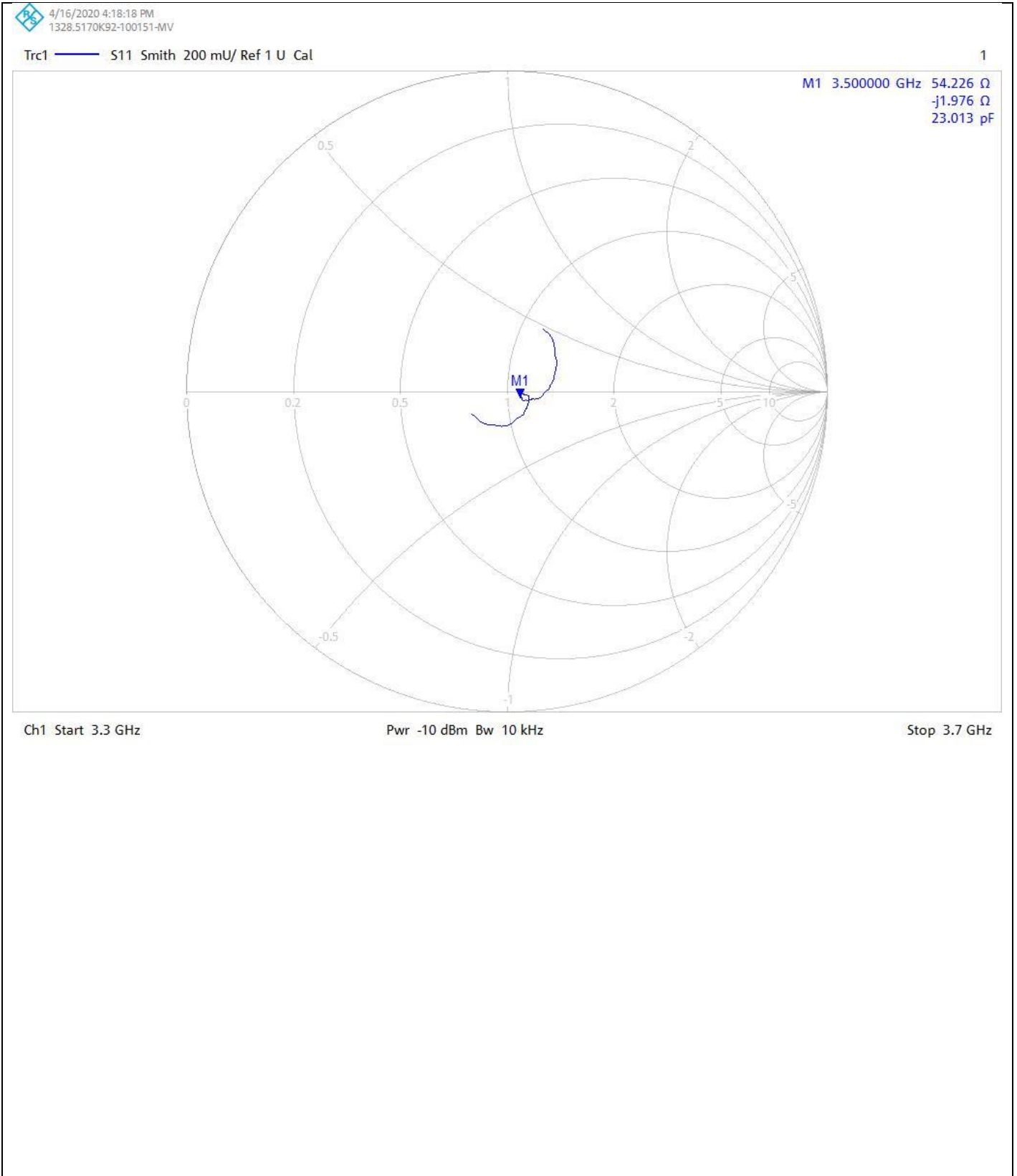

CERTIFICATE OF CALIBRATION

ISSUED BY UL VS LTD

UKAS Accredited Calibration Laboratory No. 5248

CERTIFICATE
NUMBER :
13252595JD01E

Page 7 of 10

Return Loss Measurement Plot for Head Stimulating Liquid (HSL)



CERTIFICATE OF CALIBRATION

ISSUED BY UL VS LTD

UKAS Accredited Calibration Laboratory No. 5248

CERTIFICATE
NUMBER :
13252595JD01E

Page 8 of 10

DASY Validation Scan for Body Stimulating Liquid (MSL)

DUT: D3500V2 - SN1011; Type: D3500V2; Serial: SN1011

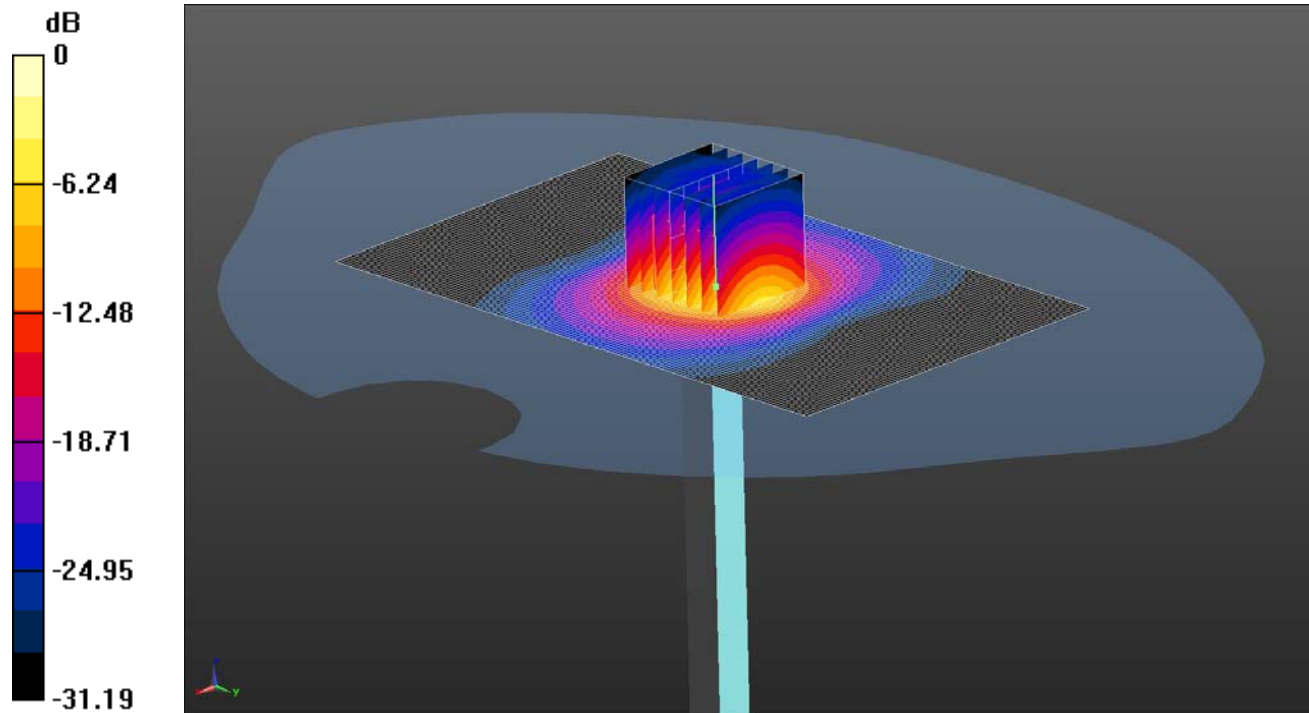

0 dB = 31.4 W/kg = 14.97 dBW/kg

Communication System: UID 0, CW (0); Frequency: 3500 MHz; Duty Cycle: 1:1;
Medium: Site65_15Apr2020_170455_Body - 3500 5%; Medium parameters used: $f = 3500$ MHz; $\sigma = 3.172$ S/m; $\epsilon_r = 50.748$; $\rho = 1000$ kg/m³;

Phantom section: Flat Section ;

DASY5 Configuration:

- Probe: EX3DV4 - SN7496; ConvF(6.46, 6.46, 6.46); Calibrated: 24/03/2020;
- Sensor-Surface: 3mm (Mechanical Surface Detection), Sensor-Surface: 1.4mm (Mechanical Surface Detection);
- Electronics: DAE4 Sn1542; Calibrated: 17/03/2020;
- Phantom: Twin SAM A (Site 65); Type: SAM 5.0; Serial: SN1818;
- Measurement SW: DASY52, Version 52.10 (0); SEMCAD X Version 14.6.10 (7417) ;

Configuration/d=10mm, Pin=250mW/Area Scan (81x131x1): Interpolated grid: dx=1.200 mm, dy=1.200 mm

Maximum value of SAR (interpolated) = 25.2 W/kg

Configuration/d=10mm, Pin=250mW/Zoom Scan (5x5x7) (7x7x5)/Cube 0: Measurement grid: dx=5mm, dy=5mm, dz=4mm

Reference Value = 84.11 V/m; Power Drift = 0.12 dB

Peak SAR (extrapolated) = 41.7 W/kg

SAR(1 g) = 16.6 W/kg; SAR(10 g) = 6.3 W/kg

Maximum value of SAR (measured) = 31.4 W/kg

CERTIFICATE OF CALIBRATION

ISSUED BY UL VS LTD

UKAS Accredited Calibration Laboratory No. 5248

CERTIFICATE
NUMBER :
13252595JD01E

Page 9 of 10

Impedance Measurement Plot for Body Stimulating Liquid (MSL)

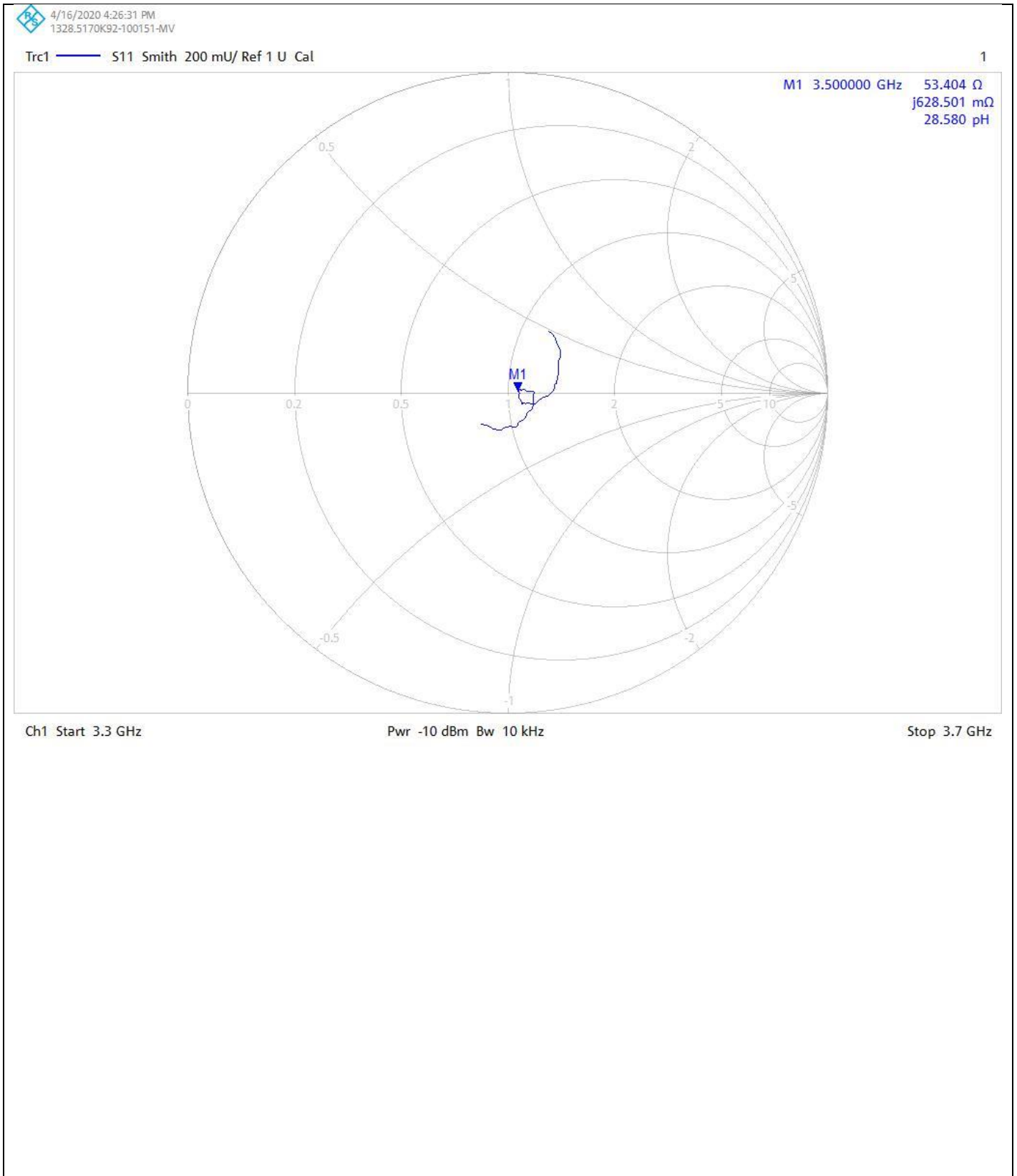

CERTIFICATE OF CALIBRATION

ISSUED BY UL VS LTD

UKAS Accredited Calibration Laboratory No. 5248

CERTIFICATE
NUMBER :
13252595JD01E

Page 10 of 10

Return Loss Measurement Plot for Body Stimulating Liquid (MSL)

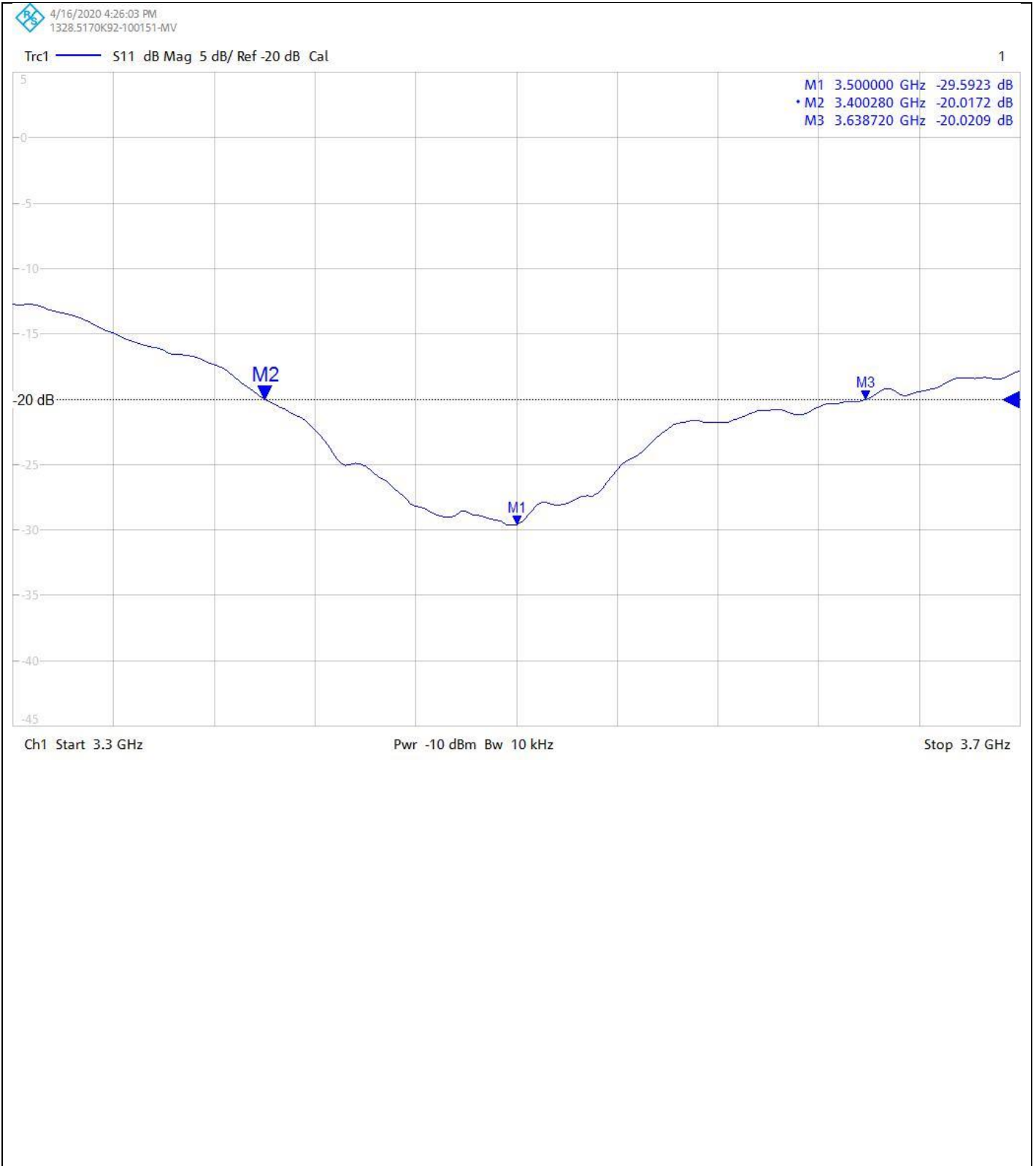

Calibration Certificate Label:

 <p>UKAS CALIBRATION 5248</p>	<p>UL VS LTD - Tel: +44 (0) 1256312000</p> <p>Certificate Number: 13252595JD01E</p> <p>Instrument ID: 1011</p> <p>Calibration Date: 17/Apr/2020</p> <p>Calibration Due Date:</p>
------------------------------------------------------------------------------------------------------------------------	-----------------------------------------------------------------------------------------------------------------------------------------------------------------------------------------

 <p>UKAS CALIBRATION 5248</p>	<p>UL VS LTD - Tel: +44 (0) 1256312000</p> <p>Certificate Number: 13252595JD01E</p> <p>Instrument ID: 1011</p> <p>Calibration Date: 17/Apr/2020</p> <p>Calibration Due Date:</p>
------------------------------------------------------------------------------------------------------------------------	-----------------------------------------------------------------------------------------------------------------------------------------------------------------------------------------

 <p>UKAS CALIBRATION 5248</p>	<p>UL VS LTD - Tel: +44 (0) 1256312000</p> <p>Certificate Number: 13252595JD01E</p> <p>Instrument ID: 1011</p> <p>Calibration Date: 17/Apr/2020</p> <p>Calibration Due Date:</p>
--------------------------------------------------------------------------------------------------------------------------	-----------------------------------------------------------------------------------------------------------------------------------------------------------------------------------------

CERTIFICATE OF CALIBRATION

ISSUED BY **UL VS LTD**

DATE OF ISSUE: 12/Mar/2020 CERTIFICATE NUMBER : 13252596JD01B



5248

UL VS LTD
UNIT 1-3 HORIZON
KINGSLAND PARK, WADE ROAD
BASINGSTOKE, HAMPSHIRE
RG24 8AH, UK
TEL: +44 (0) 1256 312000
FAX: +44 (0) 1256 312001
Email: LST.UK.Calibration@ul.com



Page 1 of 10

APPROVED SIGNATORY

A handwritten signature in black ink, appearing to read 'M. Naseer'.

.....
Naseer Mirza

Customer :

UL VS Inc
47173 Benicia Street
Fremont, CA 94538, USA

Equipment Details:

Description:	Dipole Validation Kit	Date of Receipt:	26/Feb/2020
Manufacturer:	Speag		
Type/Model Number:	D3500V2		
Serial Number:	1060		
Calibration Date:	12/Mar/2020		
Calibrated By:	Harmohan Sahota Laboratory Engineer		

Signature:

A handwritten signature in black ink, appearing to read 'Harmohan Sahota'.

All Calibration have been conducted in the closed laboratory facility: Lab Temperature (22±3) °C and humidity < 70%

This certificate is issued in accordance with the laboratory accreditation requirements of the United Kingdom Accreditation Service. It provides traceability of measurement to the SI system of units and/or to units of measurement realised at the National Physical Laboratory or other recognised national metrology institutes. This certificate may not be reproduced other than in full, except with the prior written approval of the issuing laboratory.

Use of the UKAS mark demonstrates that compliance with the requirements of BS/EN/ISO/IEC 17025 has been independently assessed.

CERTIFICATE OF CALIBRATION

ISSUED BY UL VS LTD

UKAS Accredited Calibration Laboratory No. 5248

CERTIFICATE
NUMBER :
13252596JD01B

Page 2 of 10

The calibration methods and procedures used were as detailed in:

1. **IEC 62209-1:2016**: Procedure to determine the specific absorption rate (SAR) for hand-held devices used in close proximity to the ear (frequency range of 300 MHz to 3 GHz)
2. **IEC 62209-2:2010**: Procedure to determine the specific absorption rate (SAR) for wireless communication devices used in close proximity to the human body (frequency range of 30 MHz to 6 GHz)
3. **IEEE 1528: 2013**: IEEE Recommended Practice for Determining the Peak Spatial-Average Specific Absorption Rate (SAR) in the Human Head from Wireless Communication Devices: Measurement Techniques
4. FCC KDB Publication Number: “**KDB865664 D01 SAR Measurement 100 MHz to 6 GHz**”
5. **SPEAG DASY5 System Handbook**

The measuring equipment used to perform the calibration, documented in this certificate has been calibrated in accordance with the manufacturers' recommendations, and is traceable to recognized national standards.

UL No.	Instrument	Manufacturer	Type No.	Serial No.	Date Last Calibrated	Cal. Interval (Months)
A2547	Data Acquisition Electronics	SPEAG	DAE4	1438	11 Apr 2019	12
A2545	Probe	SPEAG	EX3DV4	3995	24 Apr 2019	12
A2782	Dipole	SPEAG	D3500V2	1044	14 Feb 2020	12
PRE0151451	Power Monitoring Kit	Art-Fi	ART 100850-01	0001	Cal as part of System	-
PRE0151441	Power Sensor	Rhode & Schwarz	NRP8S	102481	27 Mar 2019	12
PRE0151154	Vector Network Analyser	Rhode & Schwarz	ZND8	100151	30 Jan 2020	12
PRE0151877	Calibration Kit	Rhode & Schwarz	ZV-Z135	102947	17 Oct 2019	12
PRE0178154	Signal Generator	Rhode & Schwarz	SMB 100A	175325	30 Apr 2019	12

CERTIFICATE OF CALIBRATION

ISSUED BY UL VS LTD

UKAS Accredited Calibration Laboratory No. 5248

CERTIFICATE
NUMBER :
13252596JD01B

Page 3 of 10

SAR System Specification

Robot System Positioner:	Stäubli Unimation Corp. Robot Model: TX60L
Robot Serial Number:	F17/5ENYG1/A/01
DASY Version:	DASY 52 (v52.10.0.1446)
Phantom:	Flat section of SAM Twin Phantom
Distance Dipole Centre:	10 mm (with spacer)
Frequency:	3500 MHz

Dielectric Property Measurements – Head Simulating Liquid (HSL)

Simulant Liquid	Frequency (MHz)	Room Temp		Liquid Temp		Parameters	Target Value	Measured Value	Uncertainty (%)
		Start	End	Start	End				
Head	3500	20.6 °C	21.4 °C	20.4°C	20.2°C	ϵ_r	37.90	39.12	± 5%
						σ	2.91	2.79	± 5%

SAR Results – Head Simulating Liquid (HSL)

Simulant Liquid	SAR Measured	250 mW input Power	Normalised to 1.00 W	Uncertainty (%)
Head	SAR averaged over 1g	16.30 W/Kg	64.89 W/Kg	± 18.75%
	SAR averaged over 10g	6.23 W/Kg	24.80 W/Kg	± 18.63%

Antenna Parameters – Head Simulating Liquid (HSL)

Simulant Liquid	Parameter	Measured Level	Uncertainty (%)
Head	Impedance	54.363 Ω - 3.65 $j\Omega$	± 0.28 Ω ± 0.044 $j\Omega$
	Return Loss	-25.34	± 2.03 dB

CERTIFICATE OF CALIBRATION

ISSUED BY UL VS LTD

UKAS Accredited Calibration Laboratory No. 5248

CERTIFICATE
NUMBER :
13252596JD01B

Page 4 of 10

Dielectric Property Measurements – Body Simulating Liquid (MSL)

Simulant Liquid	Frequency (MHz)	Room Temp		Liquid Temp		Parameters	Target Value	Measured Value	Uncertainty (%)
		Start	End	Start	End				
Body	3500	20.5 °C	20.4 °C	19.5°C	21.0°C	ϵ_r	51.30	51.16	± 5%
						σ	3.31	3.21	± 5%

SAR Results – Body Simulating Liquid (MSL)

Simulant Liquid	SAR Measured	250 mW input Power	Normalised to 1.00 W	Uncertainty (%)
Body	SAR averaged over 1g	17.00 W/Kg	67.67 W/Kg	± 18.53%
	SAR averaged over 10g	6.35 W/Kg	25.27 W/Kg	± 18.61%

Antenna Parameters – Body Simulating Liquid (MSL)

Simulant Liquid	Parameter	Measured Level	Uncertainty (%)
Body	Impedance	53.97 Ω - 3.45 j Ω	± 0.28 Ω ± 0.044 j Ω
	Return Loss	-25.94	± 2.03 dB

CERTIFICATE OF CALIBRATION

ISSUED BY UL VS LTD

UKAS Accredited Calibration Laboratory No. 5248

CERTIFICATE
NUMBER :
13252596JD01B

Page 5 of 10

DASY Validation Scan for Head Stimulating Liquid (HSL)

DUT: D3500V2 - SN1060; Type: D3500V2; Serial: SN1060

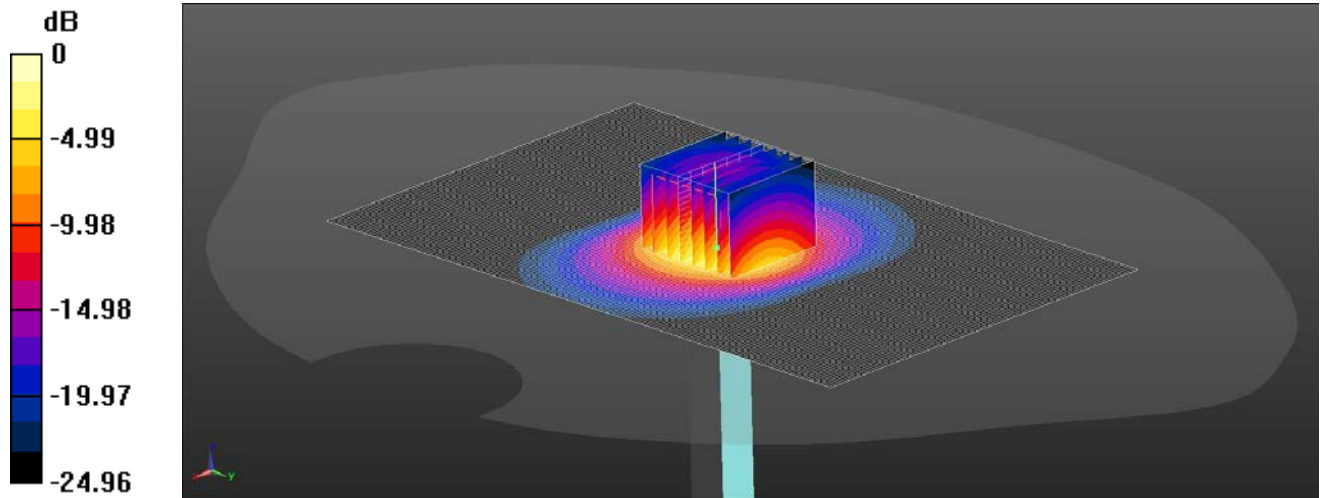

0 dB = 22.9 W/kg = 13.60 dBW/kg

Communication System: UID 0, CW (0); Frequency: 3500 MHz; Duty Cycle: 1:1

Medium: HSL 09 03 20 - 2450 3500 5250 5600 5750 5% Medium parameters used: $f = 3500$ MHz; $\sigma = 2.795$ S/m; $\epsilon_r = 39.123$; $\rho = 1000$ kg/m³

Phantom section: Flat Section

DASY4 Configuration:

- Probe: EX3DV4 - SN3995; ConvF(7.09, 7.09, 7.09); Calibrated: 24/04/2019;
- Sensor-Surface: 3mm (Mechanical Surface Detection)
- Electronics: DAE4 Sn1438; Calibrated: 11/04/2019
- Phantom: Twin-SAM V8.0 (20deg probe tilt); Type: QD 000 P41 Ax; Serial: 1945
- ; SEMCAD X Version 14.6.10 (7417)

Configuration/d=10mm, Pin=250mW/Area Scan (101x161x1): Interpolated grid: dx=1.000 mm, dy=1.000 mm

Maximum value of SAR (interpolated) = 23.4 W/kg

Configuration/d=10mm, Pin=250mW/Zoom Scan (5x5x7) (8x8x16)/Cube 0: Measurement grid: dx=4mm, dy=4mm, dz=1.4mm

Reference Value = 91.12 V/m; Power Drift = 0.02 dB

Peak SAR (extrapolated) = 43.0 W/kg

SAR(1 g) = 16.3 W/kg; SAR(10 g) = 6.23 W/kg

Maximum value of SAR (measured) = 22.9 W/kg

CERTIFICATE OF CALIBRATION

ISSUED BY UL VS LTD

UKAS Accredited Calibration Laboratory No. 5248

CERTIFICATE
NUMBER :
13252596JD01B

Page 6 of 10

Impedance Measurement Plot for Head Stimulating Liquid (HSL)

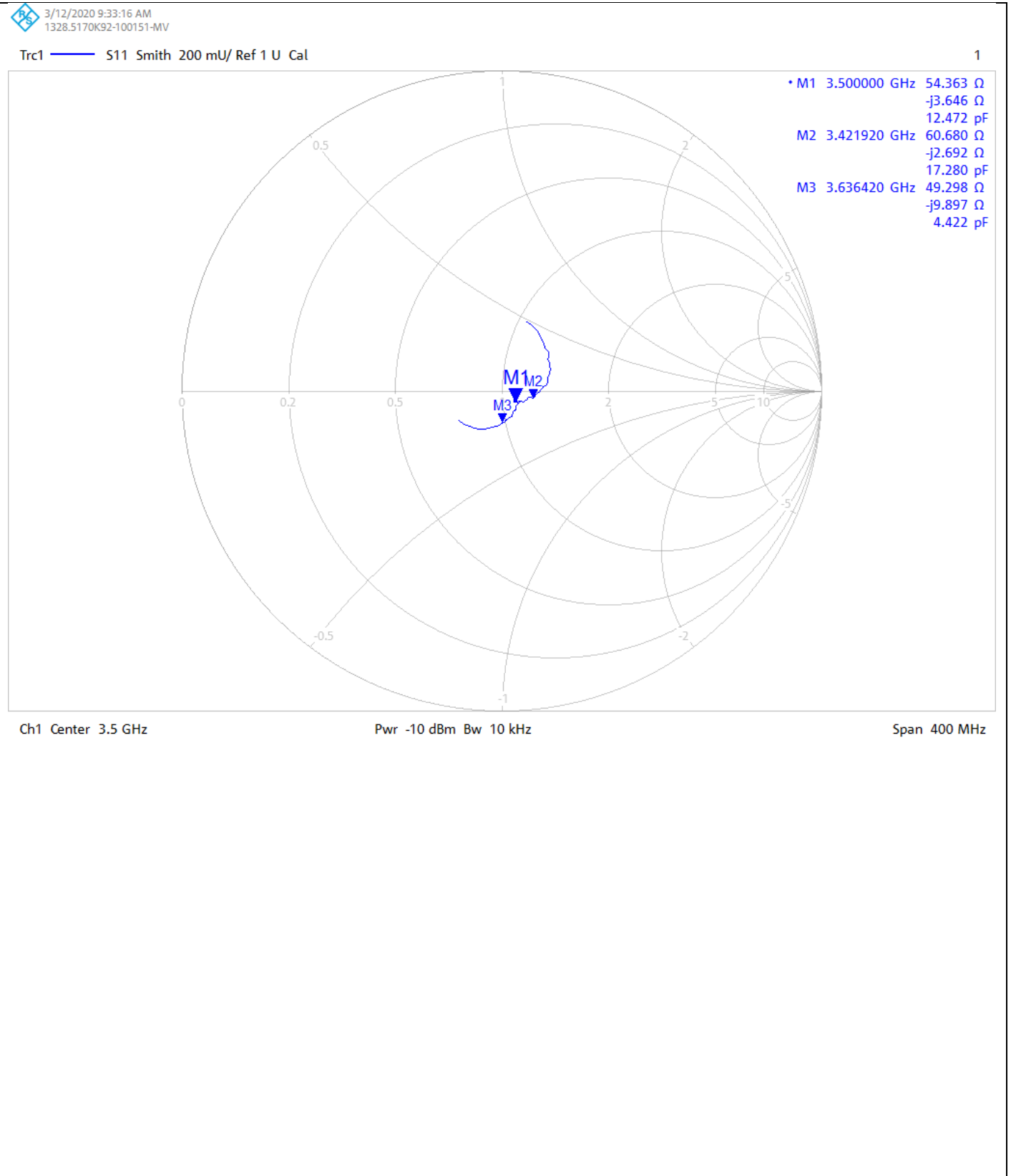

CERTIFICATE OF CALIBRATION

ISSUED BY UL VS LTD

UKAS Accredited Calibration Laboratory No. 5248

CERTIFICATE
NUMBER :
13252596JD01B

Page 7 of 10

Return Loss Measurement Plot for Head Stimulating Liquid (HSL)

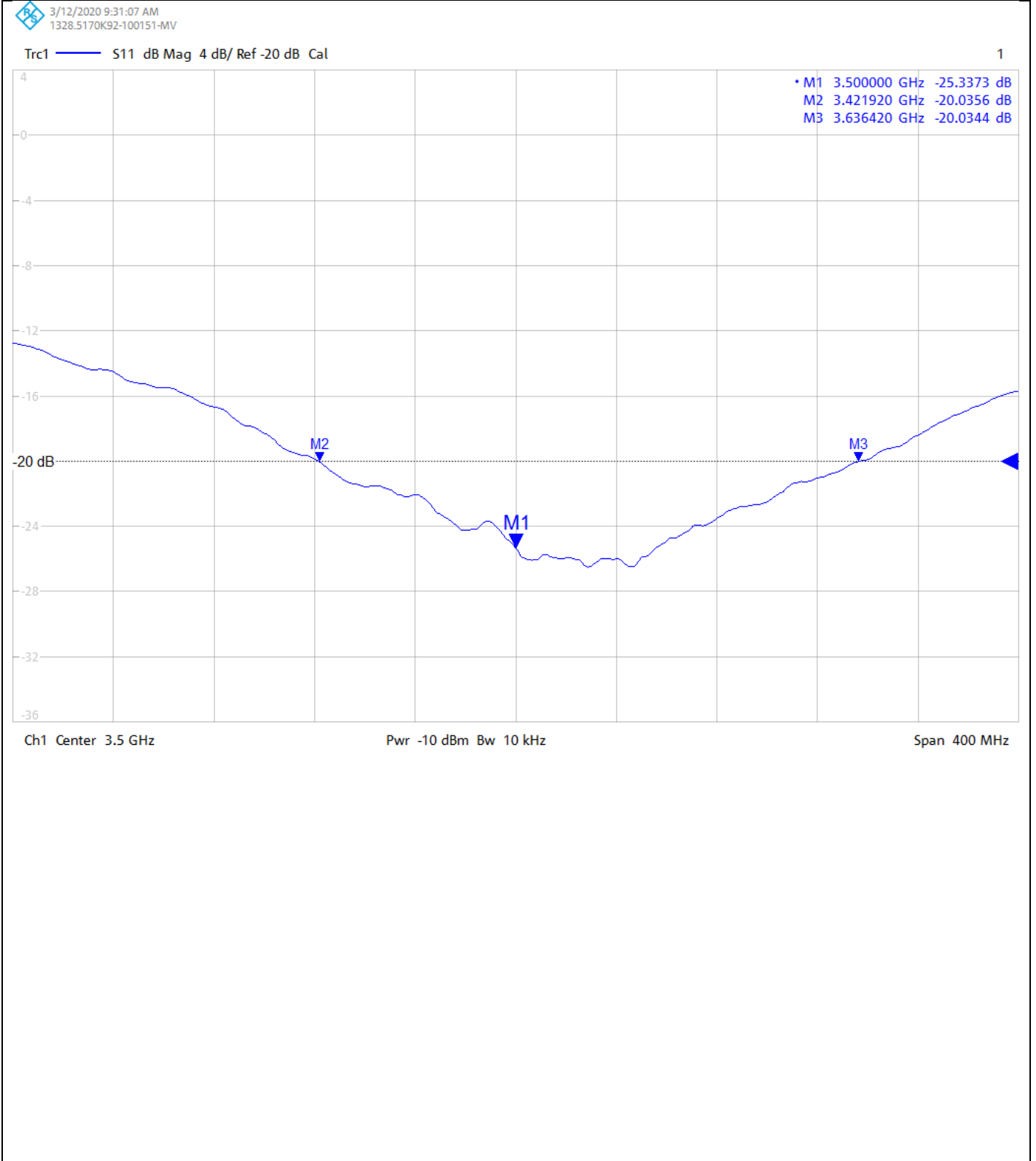

CERTIFICATE OF CALIBRATION

ISSUED BY UL VS LTD

CERTIFICATE
NUMBER :
13252596JD01B

UKAS Accredited Calibration Laboratory No. 5248

Page 8 of 10

DASY Validation Scan for Body Stimulating Liquid (MSL)

DUT: D3500V2 - SN1060; Type: D3500V2; Serial: SN1060

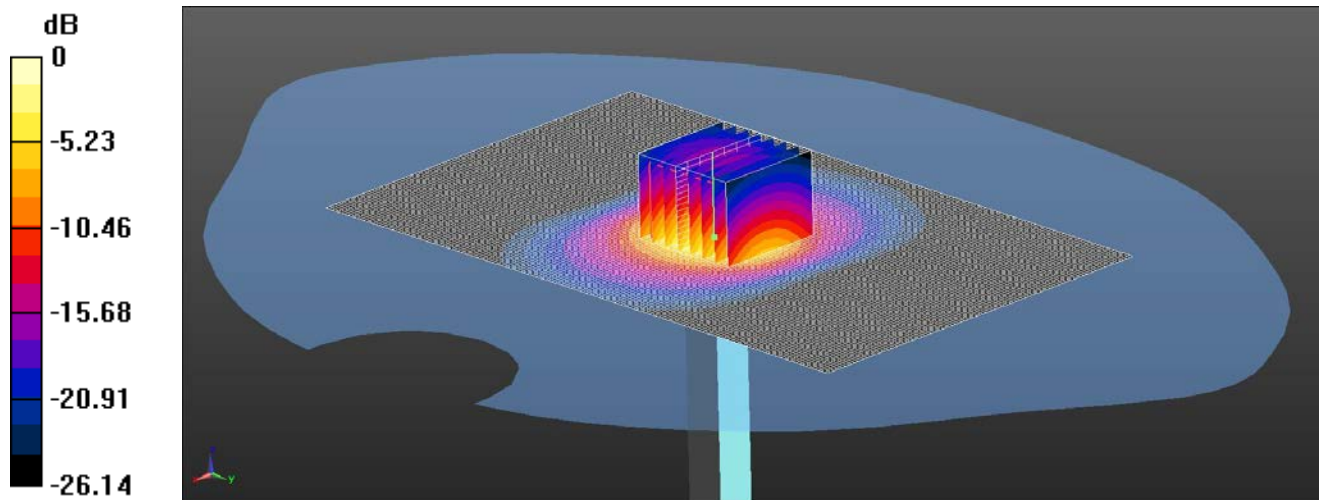

0 dB = 24.1 W/kg = 13.82 dBW/kg

Communication System: UID 0, CW (0); Frequency: 3500 MHz; Duty Cycle: 1:1

Medium: MSL 10 03 20 - 3500 5% Medium parameters used: $f = 3500$ MHz; $\sigma = 3.21$ S/m; $\epsilon_r = 51.158$; $\rho = 1000$ kg/m³

Phantom section: Flat Section

DASY4 Configuration:

- Probe: EX3DV4 - SN3995; ConvF(6.67, 6.67, 6.67); Calibrated: 24/04/2019;
- Sensor-Surface: 3mm (Mechanical Surface Detection)
- Electronics: DAE4 Sn1438; Calibrated: 11/04/2019
- Phantom: Twin SAM A (Site 65); Type: SAM 5.0; Serial: SN1818
- ; SEMCAD X Version 14.6.10 (7417)

3500/d=10mm, Pin=250mW/Area Scan (101x161x1): Interpolated grid: dx=1.000 mm, dy=1.000 mm

Maximum value of SAR (interpolated) = 24.4 W/kg

3500/d=10mm, Pin=250mW/Zoom Scan (5x5x7) (8x8x16)/Cube 0: Measurement grid: dx=4mm, dy=4mm, dz=1.4mm

Reference Value = 88.07 V/m; Power Drift = 0.01 dB

Peak SAR (extrapolated) = 44.6 W/kg

SAR(1 g) = 17 W/kg; SAR(10 g) = 6.35 W/kg

Maximum value of SAR (measured) = 24.1 W/kg

CERTIFICATE OF CALIBRATION

ISSUED BY UL VS LTD

UKAS Accredited Calibration Laboratory No. 5248

CERTIFICATE
NUMBER :
13252596JD01B

Page 9 of 10

Impedance Measurement Plot for Body Stimulating Liquid (MSL)

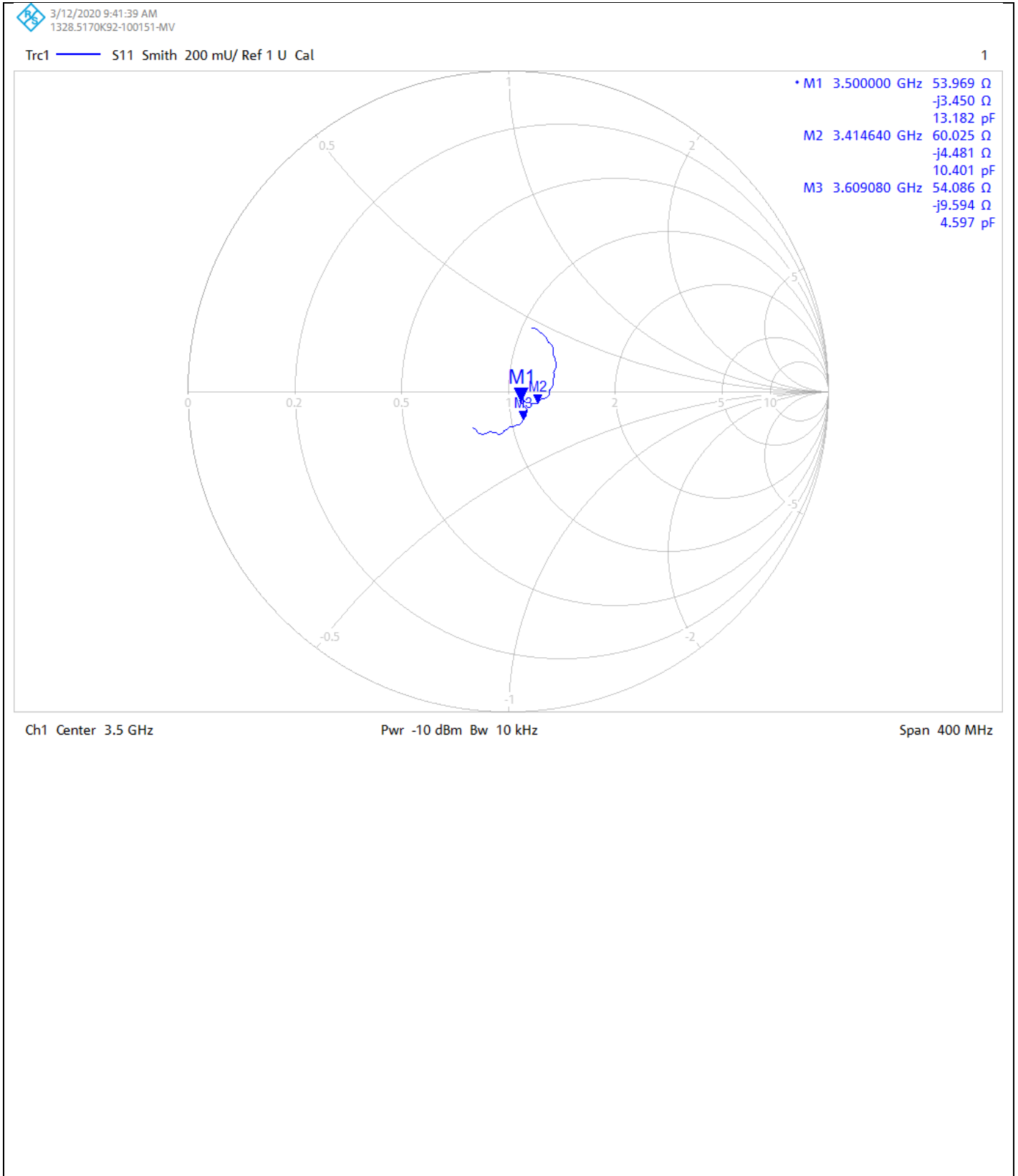

CERTIFICATE OF CALIBRATION

ISSUED BY UL VS LTD

UKAS Accredited Calibration Laboratory No. 5248

CERTIFICATE
NUMBER :
13252596JD01B

Page 10 of 10

Return Loss Measurement Plot for Body Stimulating Liquid (MSL)

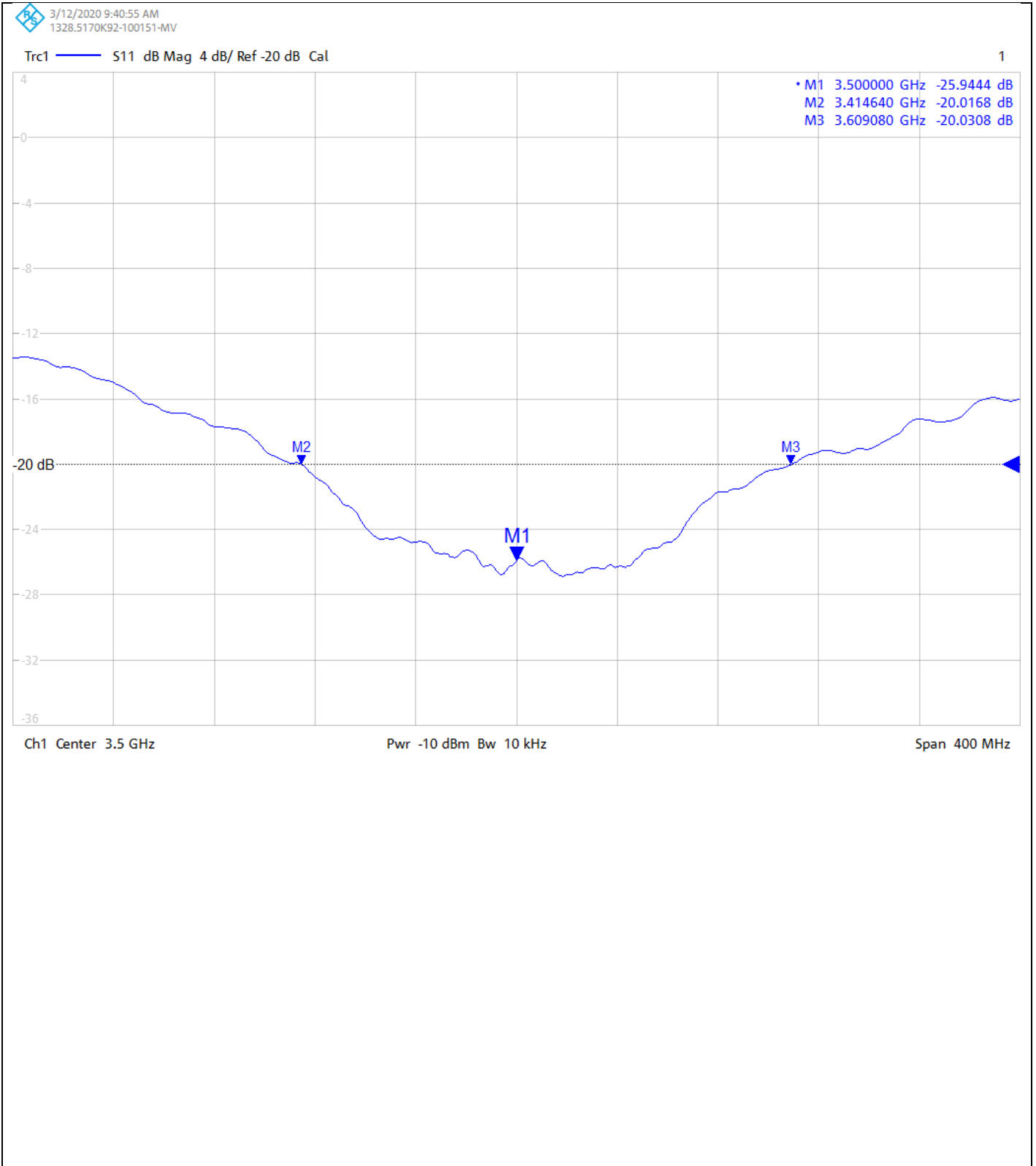

Calibration Certificate Label:

 <p>UKAS CALIBRATION 5248</p>	<p>UL VS LTD - Tel: +44 (0) 1256312000</p> <p>Certificate Number: 13252596JD01B</p> <p>Instrument ID: 1060</p> <p>Calibration Date: 12/Mar/2020</p> <p>Calibration Due Date:</p>
------------------------------------------------------------------------------------------------------------------------	-----------------------------------------------------------------------------------------------------------------------------------------------------------------------------------------

 <p>UKAS CALIBRATION 5248</p>	<p>UL VS LTD - Tel: +44 (0) 1256312000</p> <p>Certificate Number: 13252596JD01B</p> <p>Instrument ID: 1060</p> <p>Calibration Date: 12/Mar/2020</p> <p>Calibration Due Date:</p>
------------------------------------------------------------------------------------------------------------------------	-----------------------------------------------------------------------------------------------------------------------------------------------------------------------------------------

 <p>UKAS CALIBRATION 5248</p>	<p>UL VS LTD - Tel: +44 (0) 1256312000</p> <p>Certificate Number: 13252596JD01B</p> <p>Instrument ID: 1060</p> <p>Calibration Date: 12/Mar/2020</p> <p>Calibration Due Date:</p>
--------------------------------------------------------------------------------------------------------------------------	-----------------------------------------------------------------------------------------------------------------------------------------------------------------------------------------



Accreditation No.: **SCS 0108**

Accredited by the Swiss Accreditation Service (SAS)
The Swiss Accreditation Service is one of the signatories to the EA
Multilateral Agreement for the recognition of calibration certificates

Client **UL USA**

Certificate No: **D3700V2-1039_May20**

CALIBRATION CERTIFICATE

Object **D3700V2 - SN:1039**

Calibration procedure(s) **QA CAL-22.v4
Calibration Procedure for SAR Validation Sources between 3-6 GHz**

Calibration date: **May 11, 2020**

This calibration certificate documents the traceability to national standards, which realize the physical units of measurements (SI).
The measurements and the uncertainties with confidence probability are given on the following pages and are part of the certificate.

All calibrations have been conducted in the closed laboratory facility: environment temperature (22 ± 3)°C and humidity < 70%.

Calibration Equipment used (M&TE critical for calibration)

Primary Standards	ID #	Cal Date (Certificate No.)	Scheduled Calibration
Power meter NRP	SN: 104778	01-Apr-20 (No. 217-03100/03101)	Apr-21
Power sensor NRP-Z91	SN: 103244	01-Apr-20 (No. 217-03100)	Apr-21
Power sensor NRP-Z91	SN: 103245	01-Apr-20 (No. 217-03101)	Apr-21
Reference 20 dB Attenuator	SN: BH9394 (20k)	31-Mar-20 (No. 217-03106)	Apr-21
Type-N mismatch combination	SN: 310982 / 06327	31-Mar-20 (No. 217-03104)	Apr-21
Reference Probe EX3DV4	SN: 3503	31-Dec-19 (No. EX3-3503_Dec19)	Dec-20
DAE4	SN: 601	27-Dec-19 (No. DAE4-601_Dec19)	Dec-20

Secondary Standards	ID #	Check Date (in house)	Scheduled Check
Power meter E4419B	SN: GB39512475	30-Oct-14 (in house check Feb-19)	In house check: Oct-20
Power sensor HP 8481A	SN: US37292783	07-Oct-15 (in house check Oct-18)	In house check: Oct-20
Power sensor HP 8481A	SN: MY41092317	07-Oct-15 (in house check Oct-18)	In house check: Oct-20
RF generator R&S SMT-06	SN: 100972	15-Jun-15 (in house check Oct-18)	In house check: Oct-20
Network Analyzer Agilent E8358A	SN: US41080477	31-Mar-14 (in house check Oct-19)	In house check: Oct-20

	Name	Function	Signature
Calibrated by:	Jeffrey Katzman	Laboratory Technician	
Approved by:	Katja Pokovic	Technical Manager	

Issued: May 11, 2020

This calibration certificate shall not be reproduced except in full without written approval of the laboratory.



Accredited by the Swiss Accreditation Service (SAS)

The Swiss Accreditation Service is one of the signatories to the EA Multilateral Agreement for the recognition of calibration certificates

Glossary:

TSL	tissue simulating liquid
ConvF	sensitivity in TSL / NORM x,y,z
N/A	not applicable or not measured

Calibration is Performed According to the Following Standards:

- IEEE Std 1528-2013, "IEEE Recommended Practice for Determining the Peak Spatial-Averaged Specific Absorption Rate (SAR) in the Human Head from Wireless Communications Devices: Measurement Techniques", June 2013
- IEC 62209-1, "Measurement procedure for the assessment of Specific Absorption Rate (SAR) from hand-held and body-mounted devices used next to the ear (frequency range of 300 MHz to 6 GHz)", July 2016
- IEC 62209-2, "Procedure to determine the Specific Absorption Rate (SAR) for wireless communication devices used in close proximity to the human body (frequency range of 30 MHz to 6 GHz)", March 2010
- KDB 865664, "SAR Measurement Requirements for 100 MHz to 6 GHz"

Additional Documentation:

- DASY4/5 System Handbook

Methods Applied and Interpretation of Parameters:

- Measurement Conditions:** Further details are available from the Validation Report at the end of the certificate. All figures stated in the certificate are valid at the frequency indicated.
- Antenna Parameters with TSL:** The dipole is mounted with the spacer to position its feed point exactly below the center marking of the flat phantom section, with the arms oriented parallel to the body axis.
- Feed Point Impedance and Return Loss:** These parameters are measured with the dipole positioned under the liquid filled phantom. The impedance stated is transformed from the measurement at the SMA connector to the feed point. The Return Loss ensures low reflected power. No uncertainty required.
- Electrical Delay:** One-way delay between the SMA connector and the antenna feed point. No uncertainty required.
- SAR measured:** SAR measured at the stated antenna input power.
- SAR normalized:** SAR as measured, normalized to an input power of 1 W at the antenna connector.
- SAR for nominal TSL parameters:** The measured TSL parameters are used to calculate the nominal SAR result.

The reported uncertainty of measurement is stated as the standard uncertainty of measurement multiplied by the coverage factor $k=2$, which for a normal distribution corresponds to a coverage probability of approximately 95%.

Measurement Conditions

DASY system configuration, as far as not given on page 1.

DASY Version	DASY5	V52.10.4
Extrapolation	Advanced Extrapolation	
Phantom	Modular Flat Phantom	
Distance Dipole Center - TSL	10 mm	with Spacer
Zoom Scan Resolution	dx, dy = 4 mm, dz = 1.4 mm	Graded Ratio = 1.4 (Z direction)
Frequency	3700 MHz \pm 1 MHz	

Head TSL parameters

The following parameters and calculations were applied.

	Temperature	Permittivity	Conductivity
Nominal Head TSL parameters	22.0 °C	37.7	3.12 mho/m
Measured Head TSL parameters	(22.0 \pm 0.2) °C	37.5 \pm 6 %	3.05 mho/m \pm 6 %
Head TSL temperature change during test	< 0.5 °C	----	----

SAR result with Head TSL

SAR averaged over 1 cm³ (1 g) of Head TSL	Condition	
SAR measured	100 mW input power	6.68 W/kg
SAR for nominal Head TSL parameters	normalized to 1W	67.0 W/kg \pm 19.9 % (k=2)

SAR averaged over 10 cm³ (10 g) of Head TSL	condition	
SAR measured	100 mW input power	2.41 W/kg
SAR for nominal Head TSL parameters	normalized to 1W	24.1 W/kg \pm 19.5 % (k=2)

Body TSL parameters

The following parameters and calculations were applied.

	Temperature	Permittivity	Conductivity
Nominal Body TSL parameters	22.0 °C	51.0	3.55 mho/m
Measured Body TSL parameters	(22.0 \pm 0.2) °C	49.9 \pm 6 %	3.54 mho/m \pm 6 %
Body TSL temperature change during test	< 0.5 °C	----	----

SAR result with Body TSL

SAR averaged over 1 cm³ (1 g) of Body TSL	Condition	
SAR measured	100 mW input power	6.34 W/kg
SAR for nominal Body TSL parameters	normalized to 1W	63.1 W/kg \pm 19.9 % (k=2)

SAR averaged over 10 cm³ (10 g) of Body TSL	condition	
SAR measured	100 mW input power	2.25 W/kg
SAR for nominal Body TSL parameters	normalized to 1W	22.4 W/kg \pm 19.5 % (k=2)

Appendix (Additional assessments outside the scope of SCS 0108)

Antenna Parameters with Head TSL

Impedance, transformed to feed point	46.3 Ω - 2.0 j Ω
Return Loss	- 27.2 dB

Antenna Parameters with Body TSL

Impedance, transformed to feed point	45.1 Ω + 1.1 j Ω
Return Loss	- 25.5 dB

General Antenna Parameters and Design

Electrical Delay (one direction)	1.134 ns
----------------------------------	----------

After long term use with 100W radiated power, only a slight warming of the dipole near the feedpoint can be measured.

The dipole is made of standard semirigid coaxial cable. The center conductor of the feeding line is directly connected to the second arm of the dipole. The antenna is therefore short-circuited for DC-signals. On some of the dipoles, small end caps are added to the dipole arms in order to improve matching when loaded according to the position as explained in the "Measurement Conditions" paragraph. The SAR data are not affected by this change. The overall dipole length is still according to the Standard.

No excessive force must be applied to the dipole arms, because they might bend or the soldered connections near the feedpoint may be damaged.

Additional EUT Data

Manufactured by	SPEAG
-----------------	-------

Test Laboratory: SPEAG, Zurich, Switzerland

DUT: Dipole 3700 MHz; Type: D3700V2; Serial: D3700V2 - SN:1039

Communication System: UID 0 - CW; Frequency: 3700 MHz

Medium parameters used: $f = 3700$ MHz; $\sigma = 3.05$ S/m; $\epsilon_r = 37.5$; $\rho = 1000$ kg/m³

Phantom section: Flat Section

Measurement Standard: DASY5 (IEEE/IEC/ANSI C63.19-2011)

DASY52 Configuration:

- Probe: EX3DV4 - SN3503; ConvF(7.73, 7.73, 7.73) @ 3700 MHz; Calibrated: 31.12.2019
- Sensor-Surface: 1.4mm (Mechanical Surface Detection)
- Electronics: DAE4 Sn601; Calibrated: 27.12.2019
- Phantom: Flat Phantom 5.0 (front); Type: QD 000 P50 AA; Serial: 1001
- DASY52 52.10.4(1527); SEMCAD X 14.6.14(7483)

Dipole Calibration for Head Tissue/Pin=100 mW, d=10mm, f=3700MHz/Zoom Scan,

dist=1.4mm (8x8x8)/Cube 0: Measurement grid: dx=4mm, dy=4mm, dz=1.4mm

Reference Value = 70.96 V/m; Power Drift = -0.06 dB

Peak SAR (extrapolated) = 19.3 W/kg

SAR(1 g) = 6.68 W/kg; SAR(10 g) = 2.41 W/kg

Smallest distance from peaks to all points 3 dB below = 7.9 mm

Ratio of SAR at M2 to SAR at M1 = 72.7%

Maximum value of SAR (measured) = 13.1 W/kg

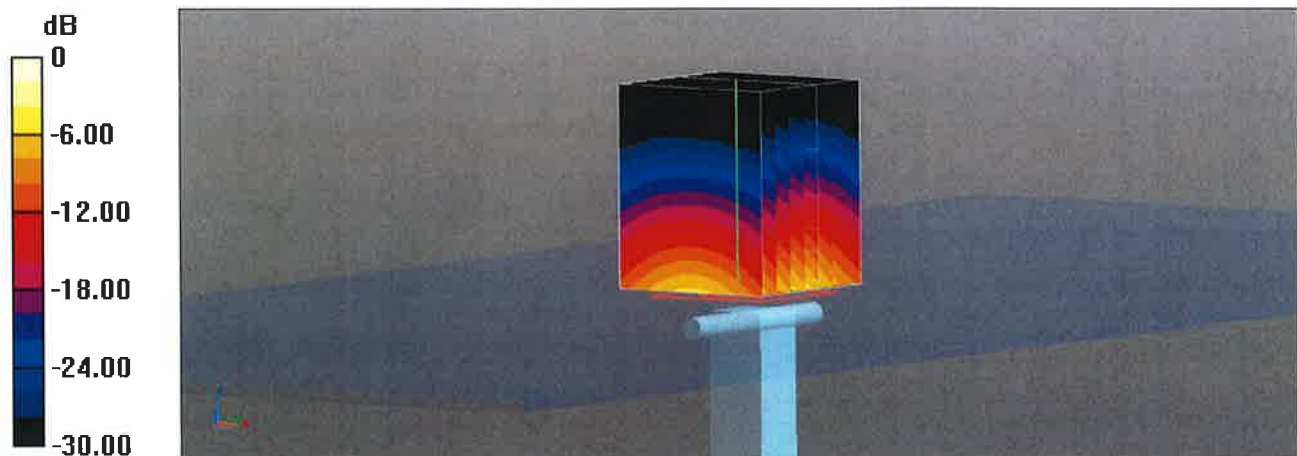

0 dB = 13.1 W/kg = 11.17 dBW/kg

Impedance Measurement Plot for Head TSL

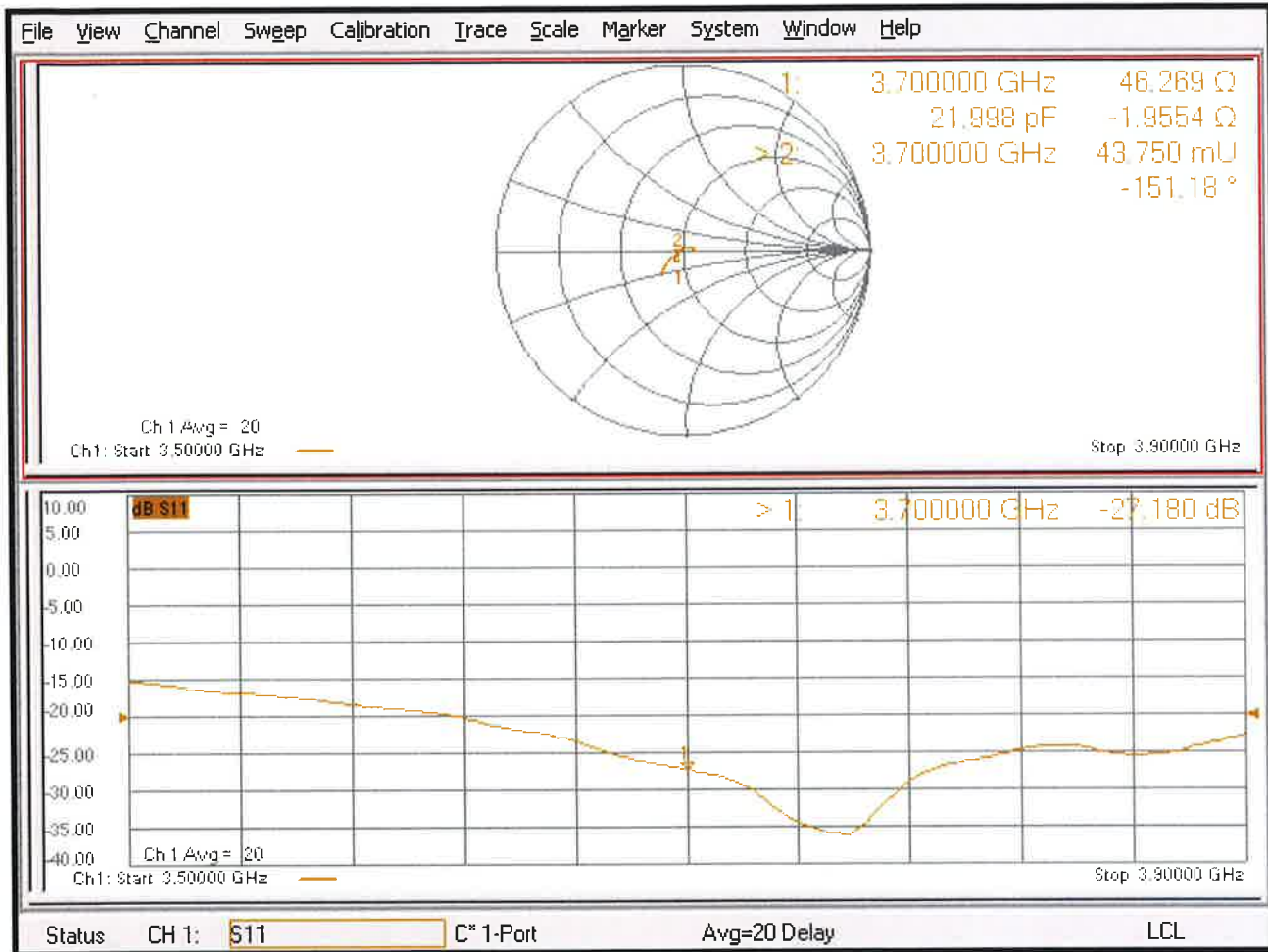

DASY5 Validation Report for Body TSL

Date: 11.05.2020

Test Laboratory: SPEAG, Zurich, Switzerland

DUT: Dipole 3700 MHz; Type: D3700V2; Serial: D3700V2 - SN:1039

Communication System: UID 0 - CW; Frequency: 3700 MHz

Medium parameters used: $f = 3700$ MHz; $\sigma = 3.54$ S/m; $\epsilon_r = 49.9$; $\rho = 1000$ kg/m³

Phantom section: Flat Section

Measurement Standard: DASY5 (IEEE/IEC/ANSI C63.19-2011)

DASY52 Configuration:

- Probe: EX3DV4 - SN3503; ConvF(7.31, 7.31, 7.31) @ 3700 MHz; Calibrated: 31.12.2019
- Sensor-Surface: 1.4mm (Mechanical Surface Detection)
- Electronics: DAE4 Sn601; Calibrated: 27.12.2019
- Phantom: Flat Phantom 5.0 (back); Type: QD 000 P50 AA; Serial: 1002
- DASY52 52.10.4(1527); SEMCAD X 14.6.14(7483)

Dipole Calibration for Body Tissue/Pin=100 mW, d=10mm, f=3700MHz/Zoom Scan ,

dist=1.4mm (8x8x8)/Cube 0: Measurement grid: dx=4mm, dy=4mm, dz=1.4mm

Reference Value = 64.85 V/m; Power Drift = -0.07 dB

Peak SAR (extrapolated) = 17.8 W/kg

SAR(1 g) = 6.34 W/kg; SAR(10 g) = 2.25 W/kg

Smallest distance from peaks to all points 3 dB below = 7.9 mm

Ratio of SAR at M2 to SAR at M1 = 74.3%

Maximum value of SAR (measured) = 12.4 W/kg

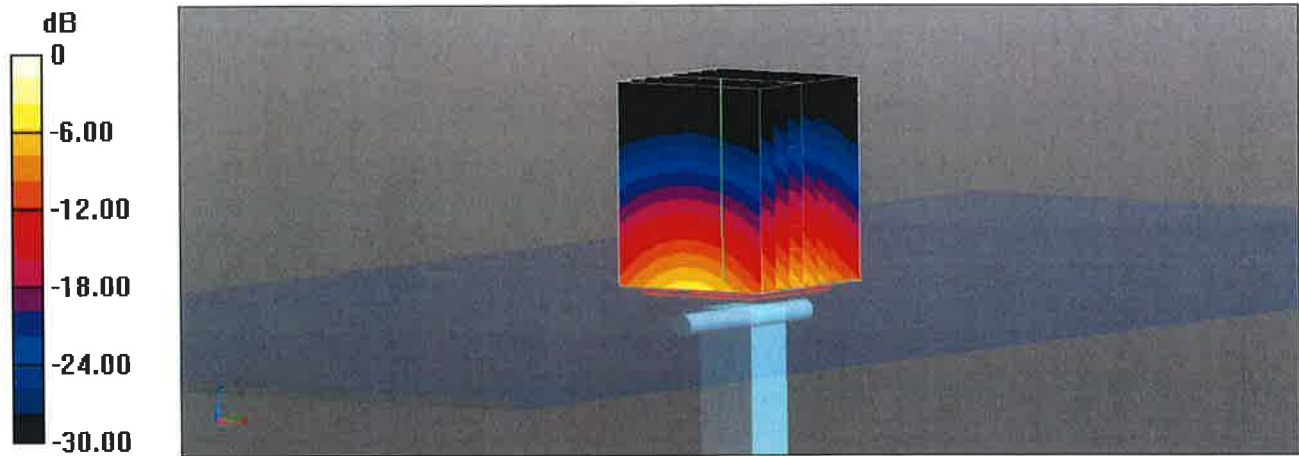

Impedance Measurement Plot for Body TSL

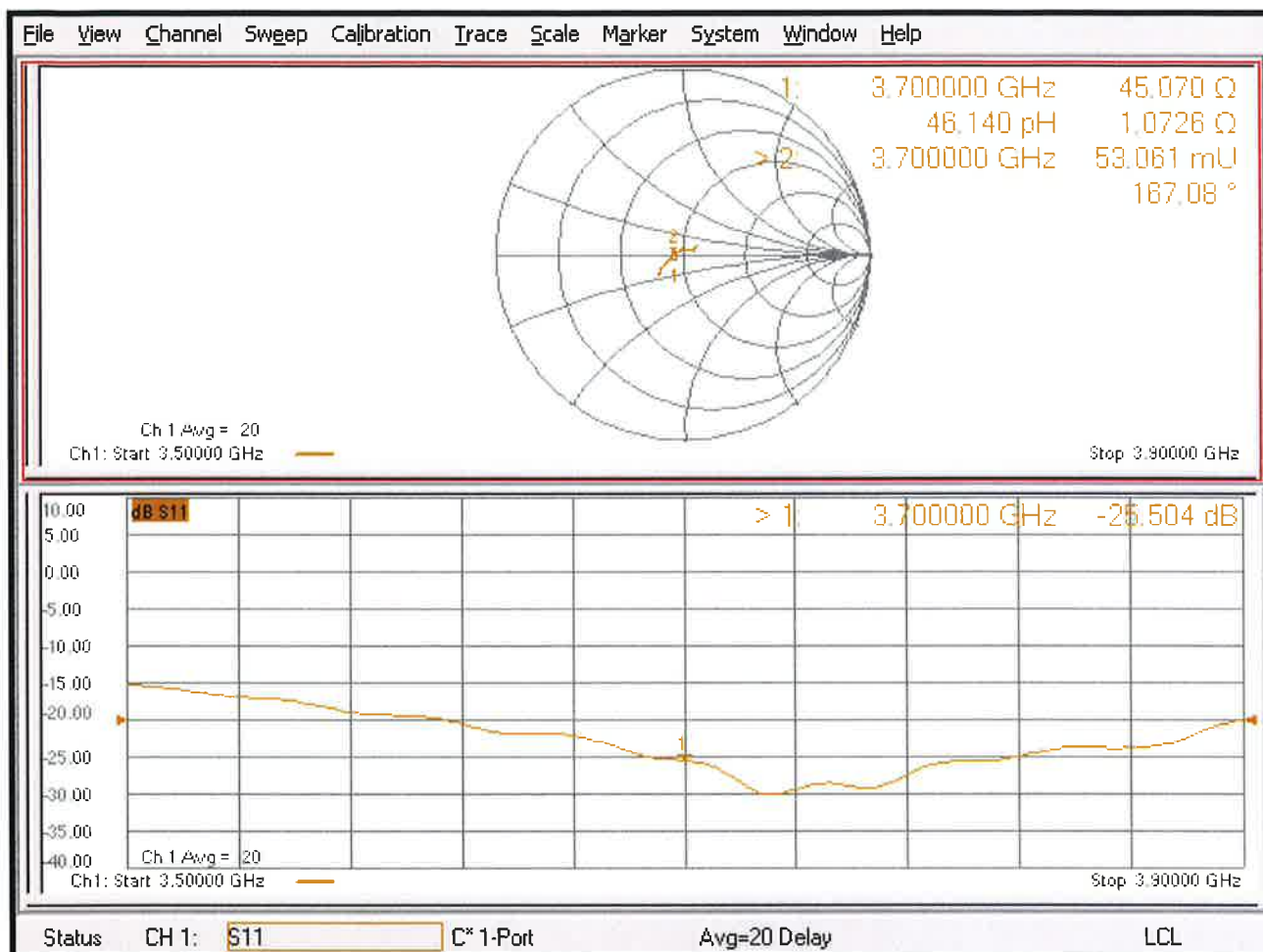



Accreditation No.: **SCS 0108**

Accredited by the Swiss Accreditation Service (SAS)
The Swiss Accreditation Service is one of the signatories to the EA
Multilateral Agreement for the recognition of calibration certificates

Client **UL USA**

Certificate No: **D3900V2-1052_Aug20**

CALIBRATION CERTIFICATE

Object **D3900V2 - SN:1052**

Calibration procedure(s) **QA CAL-22.v5
Calibration Procedure for SAR Validation Sources between 3-10 GHz**

Calibration date: **August 03, 2020**

This calibration certificate documents the traceability to national standards, which realize the physical units of measurements (SI).
The measurements and the uncertainties with confidence probability are given on the following pages and are part of the certificate.

All calibrations have been conducted in the closed laboratory facility: environment temperature (22 ± 3)°C and humidity < 70%.

Calibration Equipment used (M&TE critical for calibration)

Primary Standards	ID #	Cal Date (Certificate No.)	Scheduled Calibration
Power meter NRP	SN: 104778	01-Apr-20 (No. 217-03100/03101)	Apr-21
Power sensor NRP-Z91	SN: 103244	01-Apr-20 (No. 217-03100)	Apr-21
Power sensor NRP-Z91	SN: 103245	01-Apr-20 (No. 217-03101)	Apr-21
Reference 20 dB Attenuator	SN: BH9394 (20k)	31-Mar-20 (No. 217-03106)	Apr-21
Type-N mismatch combination	SN: 310982 / 06327	31-Mar-20 (No. 217-03104)	Apr-21
Reference Probe EX3DV4	SN: 3503	31-Dec-19 (No. EX3-3503_Dec19)	Dec-20
DAE4	SN: 601	27-Dec-19 (No. DAE4-601_Dec19)	Dec-20

Secondary Standards	ID #	Check Date (in house)	Scheduled Check
Power meter E4419B	SN: GB39512475	30-Oct-14 (in house check Feb-19)	In house check: Oct-20
Power sensor HP 8481A	SN: US37292783	07-Oct-15 (in house check Oct-18)	In house check: Oct-20
Power sensor HP 8481A	SN: MY41092317	07-Oct-15 (in house check Oct-18)	In house check: Oct-20
RF generator R&S SMT-06	SN: 100972	15-Jun-15 (in house check Oct-18)	In house check: Oct-20
Network Analyzer Agilent E8358A	SN: US41080477	31-Mar-14 (in house check Oct-19)	In house check: Oct-20

Calibrated by: **Jeffrey Katzman** **Jeffrey Katzman** **Laboratory Technician**

Signature

Approved by: **Katja Pokovic** **Katja Pokovic** **Technical Manager**

Issued: August 3, 2020

This calibration certificate shall not be reproduced except in full without written approval of the laboratory.



Accredited by the Swiss Accreditation Service (SAS)

The Swiss Accreditation Service is one of the signatories to the EA Multilateral Agreement for the recognition of calibration certificates

Accreditation No.: **SCS 0108**

Glossary:

TSL	tissue simulating liquid
ConvF	sensitivity in TSL / NORM x,y,z
N/A	not applicable or not measured

Calibration is Performed According to the Following Standards:

- IEEE Std 1528-2013, "IEEE Recommended Practice for Determining the Peak Spatial-Averaged Specific Absorption Rate (SAR) in the Human Head from Wireless Communications Devices: Measurement Techniques", June 2013
- IEC 62209-1, "Measurement procedure for the assessment of Specific Absorption Rate (SAR) from hand-held and body-mounted devices used next to the ear (frequency range of 300 MHz to 6 GHz)", July 2016
- IEC 62209-2, "Procedure to determine the Specific Absorption Rate (SAR) for wireless communication devices used in close proximity to the human body (frequency range of 30 MHz to 6 GHz)", March 2010
- KDB 865664, "SAR Measurement Requirements for 100 MHz to 6 GHz"

Additional Documentation:

- DASY4/5 System Handbook

Methods Applied and Interpretation of Parameters:

- Measurement Conditions:** Further details are available from the Validation Report at the end of the certificate. All figures stated in the certificate are valid at the frequency indicated.
- Antenna Parameters with TSL:** The dipole is mounted with the spacer to position its feed point exactly below the center marking of the flat phantom section, with the arms oriented parallel to the body axis.
- Feed Point Impedance and Return Loss:** These parameters are measured with the dipole positioned under the liquid filled phantom. The impedance stated is transformed from the measurement at the SMA connector to the feed point. The Return Loss ensures low reflected power. No uncertainty required.
- Electrical Delay:** One-way delay between the SMA connector and the antenna feed point. No uncertainty required.
- SAR measured:** SAR measured at the stated antenna input power.
- SAR normalized:** SAR as measured, normalized to an input power of 1 W at the antenna connector.
- SAR for nominal TSL parameters:** The measured TSL parameters are used to calculate the nominal SAR result.

The reported uncertainty of measurement is stated as the standard uncertainty of measurement multiplied by the coverage factor $k=2$, which for a normal distribution corresponds to a coverage probability of approximately 95%.

Measurement Conditions

DASY system configuration, as far as not given on page 1.

DASY Version	DASY5	V52.10.4
Extrapolation	Advanced Extrapolation	
Phantom	Modular Flat Phantom	
Distance Dipole Center - TSL	10 mm	with Spacer
Zoom Scan Resolution	dx, dy = 4 mm, dz = 1.4 mm	Graded Ratio = 1.4 (Z direction)
Frequency	3900 MHz ± 1 MHz	

Head TSL parameters

The following parameters and calculations were applied.

	Temperature	Permittivity	Conductivity
Nominal Head TSL parameters	22.0 °C	37.5	3.32 mho/m
Measured Head TSL parameters	(22.0 ± 0.2) °C	37.1 ± 6 %	3.21 mho/m ± 6 %
Head TSL temperature change during test	< 0.5 °C	----	----

SAR result with Head TSL

SAR averaged over 1 cm³ (1 g) of Head TSL	Condition	
SAR measured	100 mW input power	6.99 W/kg
SAR for nominal Head TSL parameters	normalized to 1W	70.1 W/kg ± 19.9 % (k=2)

SAR averaged over 10 cm³ (10 g) of Head TSL	condition	
SAR measured	100 mW input power	2.43 W/kg
SAR for nominal Head TSL parameters	normalized to 1W	24.3 W/kg ± 19.5 % (k=2)

Body TSL parameters

The following parameters and calculations were applied.

	Temperature	Permittivity	Conductivity
Nominal Body TSL parameters	22.0 °C	50.8	3.78 mho/m
Measured Body TSL parameters	(22.0 ± 0.2) °C	50.0 ± 6 %	3.77 mho/m ± 6 %
Body TSL temperature change during test	< 0.5 °C	----	----

SAR result with Body TSL

SAR averaged over 1 cm³ (1 g) of Body TSL	Condition	
SAR measured	100 mW input power	6.51 W/kg
SAR for nominal Body TSL parameters	normalized to 1W	64.9 W/kg ± 19.9 % (k=2)

SAR averaged over 10 cm³ (10 g) of Body TSL	condition	
SAR measured	100 mW input power	2.24 W/kg
SAR for nominal Body TSL parameters	normalized to 1W	22.3 W/kg ± 19.5 % (k=2)

Appendix (Additional assessments outside the scope of SCS 0108)

Antenna Parameters with Head TSL

Impedance, transformed to feed point	48.5 Ω - 5.9 j Ω
Return Loss	- 24.2 dB

Antenna Parameters with Body TSL

Impedance, transformed to feed point	48.3 Ω - 2.7 j Ω
Return Loss	- 29.7 dB

General Antenna Parameters and Design

Electrical Delay (one direction)	1.106 ns
----------------------------------	----------

After long term use with 100W radiated power, only a slight warming of the dipole near the feedpoint can be measured.

The dipole is made of standard semirigid coaxial cable. The center conductor of the feeding line is directly connected to the second arm of the dipole. The antenna is therefore short-circuited for DC-signals. On some of the dipoles, small end caps are added to the dipole arms in order to improve matching when loaded according to the position as explained in the "Measurement Conditions" paragraph. The SAR data are not affected by this change. The overall dipole length is still according to the Standard.

No excessive force must be applied to the dipole arms, because they might bend or the soldered connections near the feedpoint may be damaged.

Additional EUT Data

Manufactured by	SPEAG
-----------------	-------

DASY5 Validation Report for Head TSL

Date: 03.08.2020

Test Laboratory: SPEAG, Zurich, Switzerland

DUT: Dipole 3900 MHz; Type: D3900V2; Serial: D3900V2 - SN:1052

Communication System: UID 0 - CW; Frequency: 3900 MHz

Medium parameters used: $f = 3900$ MHz; $\sigma = 3.21$ S/m; $\epsilon_r = 37.1$; $\rho = 1000$ kg/m³

Phantom section: Flat Section

Measurement Standard: DASY5 (IEEE/IEC/ANSI C63.19-2011)

DASY52 Configuration:

- Probe: EX3DV4 - SN3503; ConvF(7.39, 7.39, 7.39) @ 3900 MHz; Calibrated: 31.12.2019
- Sensor-Surface: 1.4mm (Mechanical Surface Detection)
- Electronics: DAE4 Sn601; Calibrated: 27.12.2019
- Phantom: Flat Phantom 5.0 (front); Type: QD 000 P50 AA; Serial: 1001
- DASY52 52.10.4(1527); SEMCAD X 14.6.14(7483)

Dipole Calibration for Head Tissue/Pin=100 mW, d=10mm, f=3900MHz/Zoom Scan, dist=1.4mm (8x8x8)/Cube 0: Measurement grid: dx=4mm, dy=4mm, dz=1.4mm

Reference Value = 72.87 V/m; Power Drift = -0.04 dB

Peak SAR (extrapolated) = 20.2 W/kg

SAR(1 g) = 6.99 W/kg; SAR(10 g) = 2.43 W/kg

Smallest distance from peaks to all points 3 dB below = 8 mm

Ratio of SAR at M2 to SAR at M1 = 73.5%

Maximum value of SAR (measured) = 14.0 W/kg

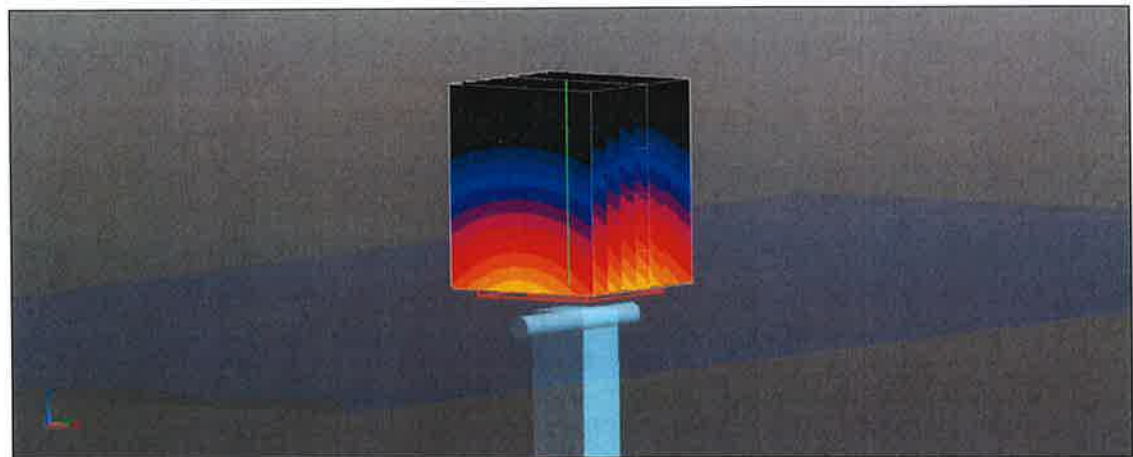
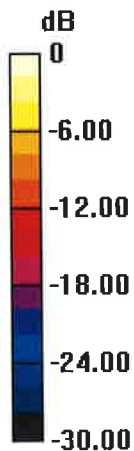

0 dB = 14.0 W/kg = 11.46 dBW/kg

Impedance Measurement Plot for Head TSL

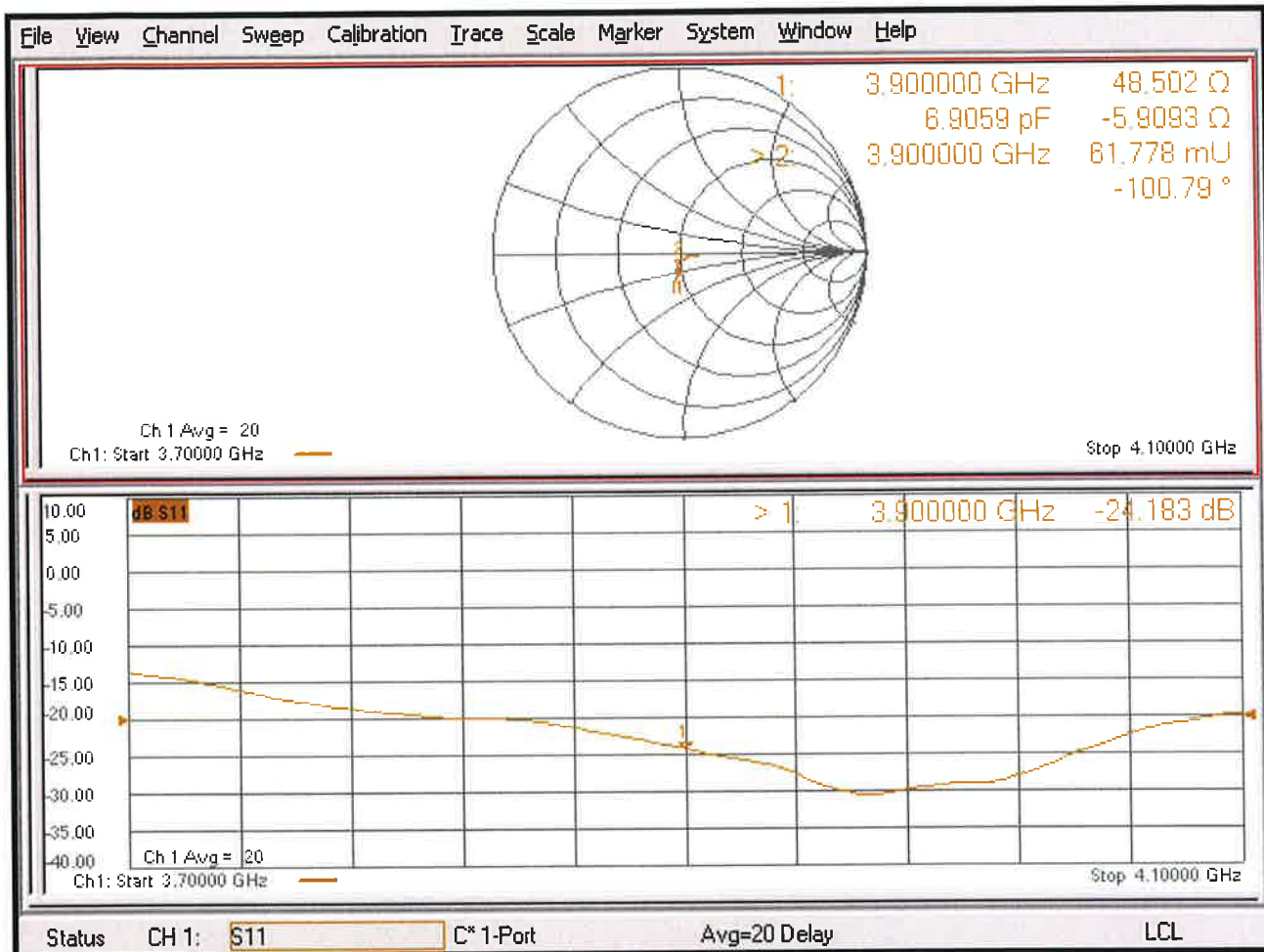

DASY5 Validation Report for Body TSL

Date: 03.08.2020

Test Laboratory: SPEAG, Zurich, Switzerland

DUT: Dipole 3900 MHz; Type: D3900V2; Serial: D3900V2 - SN:1052

Communication System: UID 0 - CW; Frequency: 3900 MHz

Medium parameters used: $f = 3900$ MHz; $\sigma = 3.77$ S/m; $\epsilon_r = 50.0$; $\rho = 1000$ kg/m³

Phantom section: Flat Section

Measurement Standard: DASY5 (IEEE/IEC/ANSI C63.19-2011)

DASY52 Configuration:

- Probe: EX3DV4 - SN3503; ConvF(7.18, 7.18, 7.18) @ 3900 MHz; Calibrated: 31.12.2019
- Sensor-Surface: 1.4mm (Mechanical Surface Detection)
- Electronics: DAE4 Sn601; Calibrated: 27.12.2019
- Phantom: Flat Phantom 5.0 (back); Type: QD 000 P50 AA; Serial: 1002
- DASY52 52.10.4(1527); SEMCAD X 14.6.14(7483)

Dipole Calibration for Body Tissue/ $P_{in}=100$ mW, $d=10$ mm, $f=3900$ MHz/Zoom Scan,

dist=1.4mm (8x8x8)/Cube 0: Measurement grid: $dx=4$ mm, $dy=4$ mm, $dz=1.4$ mm

Reference Value = 64.81 V/m; Power Drift = -0.06 dB

Peak SAR (extrapolated) = 19.5 W/kg

SAR(1 g) = 6.51 W/kg; SAR(10 g) = 2.24 W/kg

Smallest distance from peaks to all points 3 dB below = 8 mm

Ratio of SAR at M2 to SAR at M1 = 72.4%

Maximum value of SAR (measured) = 13.1 W/kg



0 dB = 13.1 W/kg = 11.17 dBW/kg

Impedance Measurement Plot for Body TSL

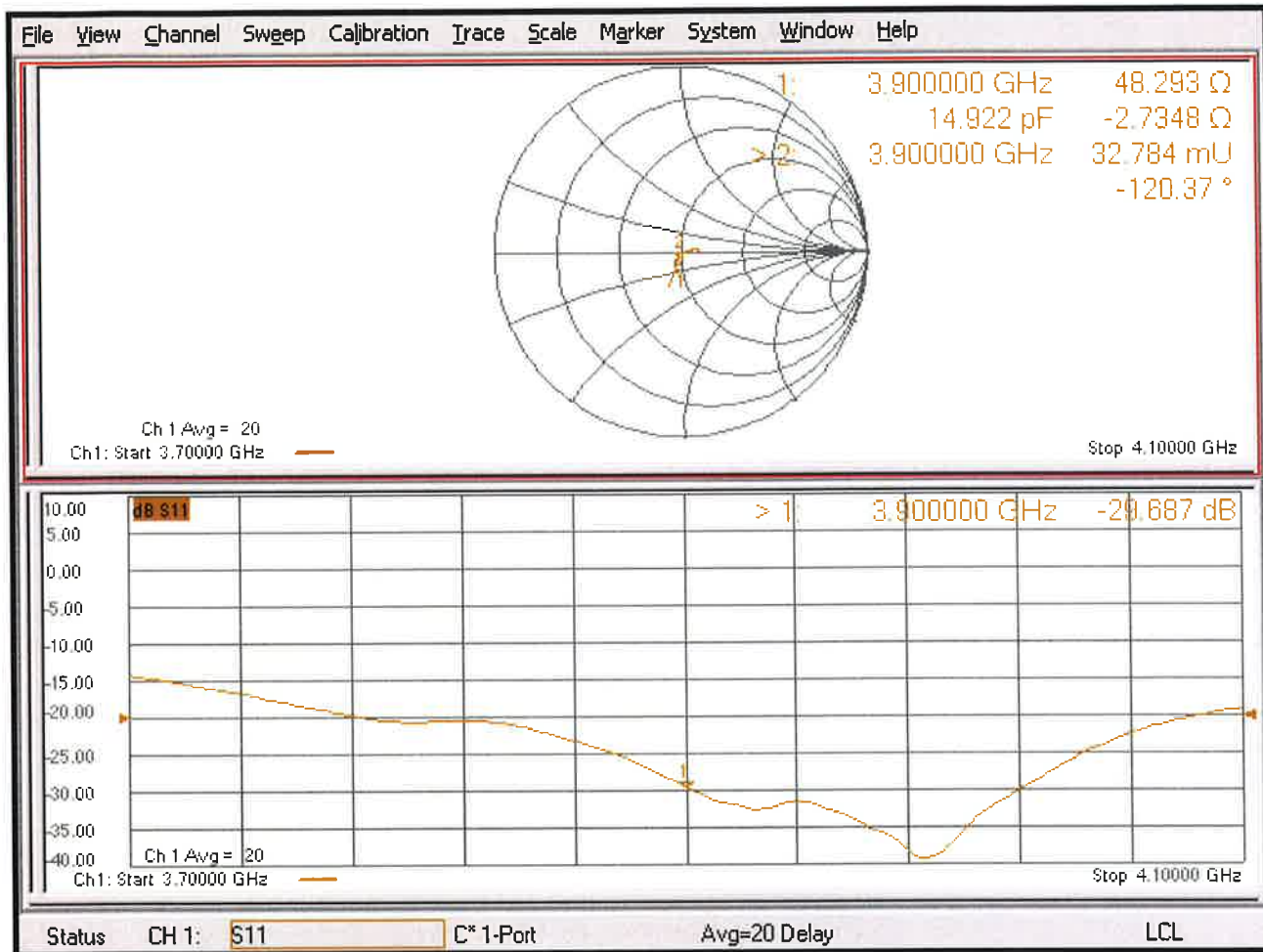



Accredited by the Swiss Accreditation Service (SAS)
**The Swiss Accreditation Service is one of the signatories to the EA
Multilateral Agreement for the recognition of calibration certificates**

Accreditation No.: **SCS 0108**

Client **UL CCS USA**

Certificate No: **D5GHzV2-1168_Nov19**

CALIBRATION CERTIFICATE

Object **D5GHzV2 - SN:1168**

Calibration procedure(s) **QA CAL-22.v4
Calibration Procedure for SAR Validation Sources between 3-6 GHz**

Calibration date: **November 23, 2019**

This calibration certificate documents the traceability to national standards, which realize the physical units of measurements (SI).
The measurements and the uncertainties with confidence probability are given on the following pages and are part of the certificate.

All calibrations have been conducted in the closed laboratory facility: environment temperature (22 ± 3)°C and humidity < 70%.

Calibration Equipment used (M&TE critical for calibration)

Primary Standards	ID #	Cal Date (Certificate No.)	Scheduled Calibration
Power meter NRP	SN: 104778	03-Apr-19 (No. 217-02892/02893)	Apr-20
Power sensor NRP-Z91	SN: 103244	03-Apr-19 (No. 217-02892)	Apr-20
Power sensor NRP-Z91	SN: 103245	03-Apr-19 (No. 217-02893)	Apr-20
Reference 20 dB Attenuator	SN: 5058 (20k)	04-Apr-19 (No. 217-02894)	Apr-20
Type-N mismatch combination	SN: 5047.2 / 06327	04-Apr-19 (No. 217-02895)	Apr-20
Reference Probe EX3DV4	SN: 3503	25-Mar-19 (No. EX3-3503_Mar19)	Mar-20
DAE4	SN: 601	30-Apr-19 (No. DAE4-601_Apr19)	Apr-20

Secondary Standards	ID #	Check Date (in house)	Scheduled Check
Power meter E4419B	SN: GB39512475	30-Oct-14 (in house check Feb-19)	In house check: Oct-20
Power sensor HP 8481A	SN: US37292783	07-Oct-15 (in house check Oct-18)	In house check: Oct-20
Power sensor HP 8481A	SN: MY41092317	07-Oct-15 (in house check Oct-18)	In house check: Oct-20
RF generator R&S SMT-06	SN: 100972	15-Jun-15 (in house check Oct-18)	In house check: Oct-20
Network Analyzer Agilent E8358A	SN: US41080477	31-Mar-14 (in house check Oct-19)	In house check: Oct-20

	Name	Function	Signature
Calibrated by:	Leif Klysner	Laboratory Technician	
Approved by:	Katja Pokovic	Technical Manager	

Issued: November 26, 2019

This calibration certificate shall not be reproduced except in full without written approval of the laboratory.

Measurement Conditions

DASY system configuration, as far as not given on page 1.

DASY Version	DASY5	V52.10.3
Extrapolation	Advanced Extrapolation	
Phantom	Modular Flat Phantom V5.0	
Distance Dipole Center - TSL	10 mm	with Spacer
Zoom Scan Resolution	dx, dy = 4.0 mm, dz = 1.4 mm	Graded Ratio = 1.4 (Z direction)
Frequency	5200 MHz ± 1 MHz 5600 MHz ± 1 MHz 5800 MHz ± 1 MHz	

Head TSL parameters at 5200 MHz

The following parameters and calculations were applied.

	Temperature	Permittivity	Conductivity
Nominal Head TSL parameters	22.0 °C	36.0	4.66 mho/m
Measured Head TSL parameters	(22.0 ± 0.2) °C	34.8 ± 6 %	4.45 mho/m ± 6 %
Head TSL temperature change during test	< 0.5 °C	----	----

SAR result with Head TSL at 5200 MHz

SAR averaged over 1 cm³ (1 g) of Head TSL	Condition	
SAR measured	100 mW input power	7.98 W/kg
SAR for nominal Head TSL parameters	normalized to 1W	79.2 W/kg ± 19.9 % (k=2)

SAR averaged over 10 cm³ (10 g) of Head TSL	condition	
SAR measured	100 mW input power	2.28 W/kg
SAR for nominal Head TSL parameters	normalized to 1W	22.5 W/kg ± 19.5 % (k=2)

Head TSL parameters at 5600 MHz

The following parameters and calculations were applied.

	Temperature	Permittivity	Conductivity
Nominal Head TSL parameters	22.0 °C	35.5	5.07 mho/m
Measured Head TSL parameters	(22.0 ± 0.2) °C	34.3 ± 6 %	4.84 mho/m ± 6 %
Head TSL temperature change during test	< 0.5 °C	----	----

SAR result with Head TSL at 5600 MHz

SAR averaged over 1 cm ³ (1 g) of Head TSL	Condition	
SAR measured	100 mW input power	8.46 W/kg
SAR for nominal Head TSL parameters	normalized to 1W	83.8 W/kg ± 19.9 % (k=2)

SAR averaged over 10 cm ³ (10 g) of Head TSL	condition	
SAR measured	100 mW input power	2.40 W/kg
SAR for nominal Head TSL parameters	normalized to 1W	23.7 W/kg ± 19.5 % (k=2)

Head TSL parameters at 5800 MHz

The following parameters and calculations were applied.

	Temperature	Permittivity	Conductivity
Nominal Head TSL parameters	22.0 °C	35.3	5.27 mho/m
Measured Head TSL parameters	(22.0 ± 0.2) °C	34.0 ± 6 %	5.05 mho/m ± 6 %
Head TSL temperature change during test	< 0.5 °C	----	----

SAR result with Head TSL at 5800 MHz

SAR averaged over 1 cm ³ (1 g) of Head TSL	Condition	
SAR measured	100 mW input power	8.04 W/kg
SAR for nominal Head TSL parameters	normalized to 1W	79.6 W/kg ± 19.9 % (k=2)

SAR averaged over 10 cm ³ (10 g) of Head TSL	condition	
SAR measured	100 mW input power	2.27 W/kg
SAR for nominal Head TSL parameters	normalized to 1W	22.4 W/kg ± 19.5 % (k=2)

Body TSL parameters at 5200 MHz

The following parameters and calculations were applied.

	Temperature	Permittivity	Conductivity
Nominal Body TSL parameters	22.0 °C	49.0	5.30 mho/m
Measured Body TSL parameters	(22.0 ± 0.2) °C	47.1 ± 6 %	5.45 mho/m ± 6 %
Body TSL temperature change during test	< 0.5 °C	----	----

SAR result with Body TSL at 5200 MHz

SAR averaged over 1 cm ³ (1 g) of Body TSL	Condition	
SAR measured	100 mW input power	7.59 W/kg
SAR for nominal Body TSL parameters	normalized to 1W	75.3 W/kg ± 19.9 % (k=2)

SAR averaged over 10 cm ³ (10 g) of Body TSL	condition	
SAR measured	100 mW input power	2.13 W/kg
SAR for nominal Body TSL parameters	normalized to 1W	21.1 W/kg ± 19.5 % (k=2)

Body TSL parameters at 5600 MHz

The following parameters and calculations were applied.

	Temperature	Permittivity	Conductivity
Nominal Body TSL parameters	22.0 °C	48.5	5.77 mho/m
Measured Body TSL parameters	(22.0 ± 0.2) °C	46.4 ± 6 %	5.99 mho/m ± 6 %
Body TSL temperature change during test	< 0.5 °C	----	----

SAR result with Body TSL at 5600 MHz

SAR averaged over 1 cm ³ (1 g) of Body TSL	Condition	
SAR measured	100 mW input power	8.00 W/kg
SAR for nominal Body TSL parameters	normalized to 1W	79.4 W/kg ± 19.9 % (k=2)

SAR averaged over 10 cm ³ (10 g) of Body TSL	condition	
SAR measured	100 mW input power	2.22 W/kg
SAR for nominal Body TSL parameters	normalized to 1W	22.0 W/kg ± 19.5 % (k=2)

Body TSL parameters at 5800 MHz

The following parameters and calculations were applied.

	Temperature	Permittivity	Conductivity
Nominal Body TSL parameters	22.0 °C	48.2	6.00 mho/m
Measured Body TSL parameters	(22.0 ± 0.2) °C	46.0 ± 6 %	6.26 mho/m ± 6 %
Body TSL temperature change during test	< 0.5 °C	----	----

SAR result with Body TSL at 5800 MHz

SAR averaged over 1 cm ³ (1 g) of Body TSL	Condition	
SAR measured	100 mW input power	7.55 W/kg
SAR for nominal Body TSL parameters	normalized to 1W	74.9 W/kg ± 19.9 % (k=2)

SAR averaged over 10 cm ³ (10 g) of Body TSL	condition	
SAR measured	100 mW input power	2.09 W/kg
SAR for nominal Body TSL parameters	normalized to 1W	20.7 W/kg ± 19.5 % (k=2)

Appendix (Additional assessments outside the scope of SCS 0108)

Antenna Parameters with Head TSL at 5200 MHz

Impedance, transformed to feed point	50.7 Ω - 9.5 j Ω
Return Loss	- 20.5 dB

Antenna Parameters with Head TSL at 5600 MHz

Impedance, transformed to feed point	56.7 Ω - 7.3 j Ω
Return Loss	- 20.6 dB

Antenna Parameters with Head TSL at 5800 MHz

Impedance, transformed to feed point	53.5 Ω - 8.3 j Ω
Return Loss	- 21.2 dB

Antenna Parameters with Body TSL at 5200 MHz

Impedance, transformed to feed point	49.5 Ω - 12.3 j Ω
Return Loss	- 18.2 dB

Antenna Parameters with Body TSL at 5600 MHz

Impedance, transformed to feed point	55.6 Ω - 7.3 j Ω
Return Loss	- 21.2 dB

Antenna Parameters with Body TSL at 5800 MHz

Impedance, transformed to feed point	54.8 Ω - 6.9 j Ω
Return Loss	- 21.9 dB

General Antenna Parameters and Design

Electrical Delay (one direction)	1.206 ns
----------------------------------	----------

After long term use with 100W radiated power, only a slight warming of the dipole near the feedpoint can be measured.

The dipole is made of standard semirigid coaxial cable. The center conductor of the feeding line is directly connected to the second arm of the dipole. The antenna is therefore short-circuited for DC-signals. On some of the dipoles, small end caps are added to the dipole arms in order to improve matching when loaded according to the position as explained in the "Measurement Conditions" paragraph. The SAR data are not affected by this change. The overall dipole length is still according to the Standard.

No excessive force must be applied to the dipole arms, because they might bend or the soldered connections near the feedpoint may be damaged.

Additional EUT Data

Manufactured by	SPEAG
-----------------	-------

Dipole Calibration for Head Tissue/Pin=100mW, dist=10mm, f=5800 MHz/Zoom Scan,

dist=1.4mm (8x8x7)/Cube 0: Measurement grid: dx=4mm, dy=4mm, dz=1.4mm

Reference Value = 74.24 V/m; Power Drift = 0.05 dB

Peak SAR (extrapolated) = 32.2 W/kg

SAR(1 g) = 8.04 W/kg; SAR(10 g) = 2.27 W/kg

Smallest distance from peaks to all points 3 dB below = 7.4 mm

Ratio of SAR at M2 to SAR at M1 = 65.2%

Maximum value of SAR (measured) = 19.1 W/kg

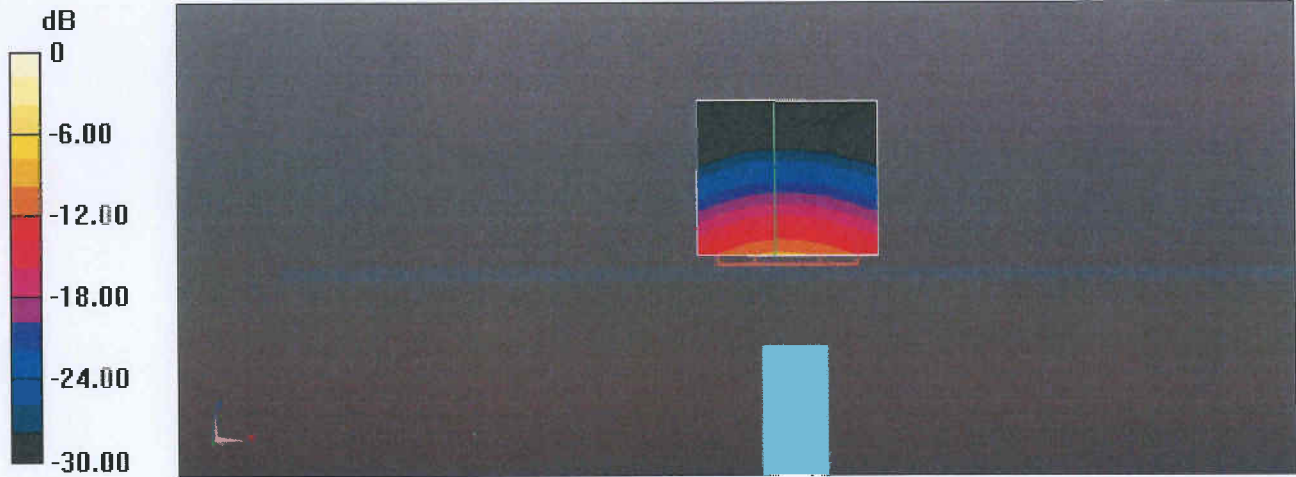

0 dB = 17.8 W/kg = 12.50 dBW/kg

Dipole Calibration for Body Tissue/Pin=100mW, dist=10mm, f=5800 MHz/Zoom Scan,

dist=1.4mm (8x8x7)/Cube 0: Measurement grid: dx=4mm, dy=4mm, dz=1.4mm

Reference Value = 66.34 V/m; Power Drift = -0.06 dB

Peak SAR (extrapolated) = 32.9 W/kg

SAR(1 g) = 7.55 W/kg; SAR(10 g) = 2.09 W/kg

Smallest distance from peaks to all points 3 dB below = 6.9 mm

Ratio of SAR at M2 to SAR at M1 = 62.8%

Maximum value of SAR (measured) = 18.7 W/kg

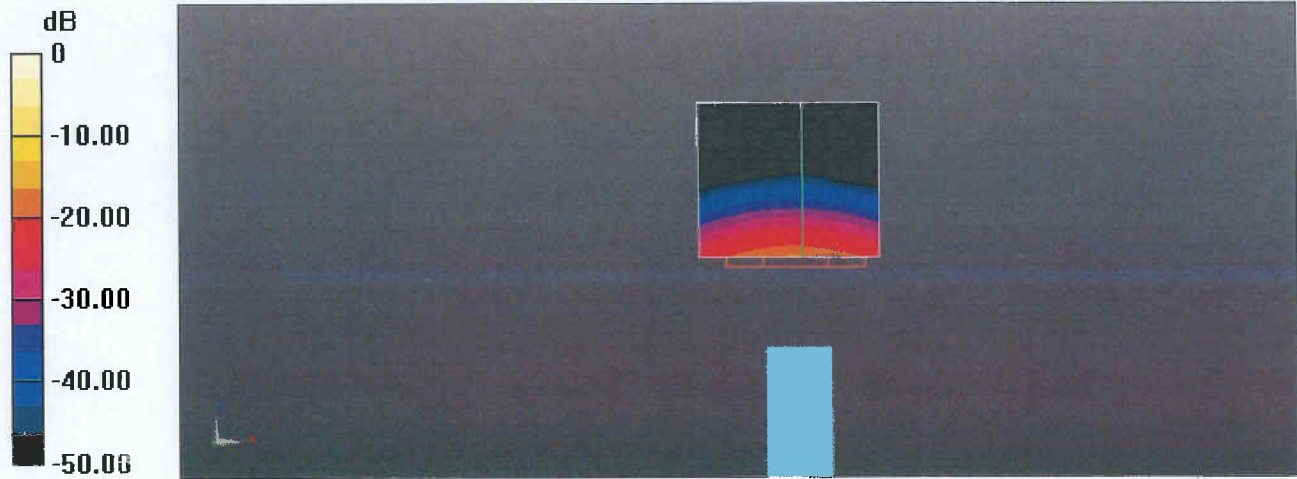

0 dB = 17.8 W/kg = 12.50 dBW/kg



Accredited by the Swiss Accreditation Service (SAS)
The Swiss Accreditation Service is one of the signatories to the EA
Multilateral Agreement for the recognition of calibration certificates

Accreditation No.: **SCS 0108**

Client **UL USA**

Certificate No: **D5GHzV2-1138_Aug20**

CALIBRATION CERTIFICATE

Object **D5GHzV2 - SN:1138**

Calibration procedure(s) **QA CAL-22.v5
Calibration Procedure for SAR Validation Sources between 3-10 GHz**



Calibration date: **August 17, 2020**

This calibration certificate documents the traceability to national standards, which realize the physical units of measurements (SI).
The measurements and the uncertainties with confidence probability are given on the following pages and are part of the certificate.

All calibrations have been conducted in the closed laboratory facility: environment temperature (22 ± 3)°C and humidity < 70%.

Calibration Equipment used (M&TE critical for calibration)

Primary Standards	ID #	Cal Date (Certificate No.)	Scheduled Calibration
Power meter NRP	SN: 104778	01-Apr-20 (No. 217-03100/03101)	Apr-21
Power sensor NRP-Z91	SN: 103244	01-Apr-20 (No. 217-03100)	Apr-21
Power sensor NRP-Z91	SN: 103245	01-Apr-20 (No. 217-03101)	Apr-21
Reference 20 dB Attenuator	SN: BH9394 (20k)	31-Mar-20 (No. 217-03106)	Apr-21
Type-N mismatch combination	SN: 310982 / 06327	31-Mar-20 (No. 217-03104)	Apr-21
Reference Probe EX3DV4	SN: 3503	31-Dec-19 (No. EX3-3503_Dec19)	Dec-20
DAE4	SN: 601	27-Dec-19 (No. DAE4-601_Dec19)	Dec-20
Secondary Standards	ID #	Check Date (in house)	Scheduled Check
Power meter E4419B	SN: GB39512475	30-Oct-14 (in house check Feb-19)	In house check: Oct-20
Power sensor HP 8481A	SN: US37292783	07-Oct-15 (in house check Oct-18)	In house check: Oct-20
Power sensor HP 8481A	SN: MY41092317	07-Oct-15 (in house check Oct-18)	In house check: Oct-20
RF generator R&S SMT-06	SN: 100972	15-Jun-15 (in house check Oct-18)	In house check: Oct-20
Network Analyzer Agilent E8358A	SN: US41080477	31-Mar-14 (in house check Oct-19)	In house check: Oct-20

Calibrated by:	Name Jeffrey Katzman	Function Laboratory Technician	Signature 
Approved by:	Name Katja Pokovic	Function Technical Manager	Signature 

Issued: August 17, 2020

This calibration certificate shall not be reproduced except in full without written approval of the laboratory.



Accredited by the Swiss Accreditation Service (SAS)
The Swiss Accreditation Service is one of the signatories to the EA
Multilateral Agreement for the recognition of calibration certificates

Glossary:

TSL	tissue simulating liquid
ConvF	sensitivity in TSL / NORM x,y,z
N/A	not applicable or not measured

Calibration is Performed According to the Following Standards:

- a) IEEE Std 1528-2013, "IEEE Recommended Practice for Determining the Peak Spatial-Averaged Specific Absorption Rate (SAR) in the Human Head from Wireless Communications Devices: Measurement Techniques", June 2013
- b) IEC 62209-1, "Measurement procedure for the assessment of Specific Absorption Rate (SAR) from hand-held and body-mounted devices used next to the ear (frequency range of 300 MHz to 6 GHz)", July 2016
- c) IEC 62209-2, "Procedure to determine the Specific Absorption Rate (SAR) for wireless communication devices used in close proximity to the human body (frequency range of 30 MHz to 6 GHz)", March 2010
- d) KDB 865664, "SAR Measurement Requirements for 100 MHz to 6 GHz"

Additional Documentation:

- e) DASY4/5 System Handbook

Methods Applied and Interpretation of Parameters:

- *Measurement Conditions:* Further details are available from the Validation Report at the end of the certificate. All figures stated in the certificate are valid at the frequency indicated.
- *Antenna Parameters with TSL:* The dipole is mounted with the spacer to position its feed point exactly below the center marking of the flat phantom section, with the arms oriented parallel to the body axis.
- *Feed Point Impedance and Return Loss:* These parameters are measured with the dipole positioned under the liquid filled phantom. The impedance stated is transformed from the measurement at the SMA connector to the feed point. The Return Loss ensures low reflected power. No uncertainty required.
- *Electrical Delay:* One-way delay between the SMA connector and the antenna feed point. No uncertainty required.
- *SAR measured:* SAR measured at the stated antenna input power.
- *SAR normalized:* SAR as measured, normalized to an input power of 1 W at the antenna connector.
- *SAR for nominal TSL parameters:* The measured TSL parameters are used to calculate the nominal SAR result.

The reported uncertainty of measurement is stated as the standard uncertainty of measurement multiplied by the coverage factor $k=2$, which for a normal distribution corresponds to a coverage probability of approximately 95%.

Measurement Conditions

DASY system configuration, as far as not given on page 1.

DASY Version	DASY5	V52.10.4
Extrapolation	Advanced Extrapolation	
Phantom	Modular Flat Phantom V5.0	
Distance Dipole Center - TSL	10 mm	with Spacer
Zoom Scan Resolution	dx, dy = 10.0 mm, dz = 10.0 mm	Graded Ratio = 1.4 (Z direction)
Frequency	5250 MHz ± 1 MHz 5600 MHz ± 1 MHz 5800 MHz ± 1 MHz	

Head TSL parameters at 5250 MHz

The following parameters and calculations were applied.

	Temperature	Permittivity	Conductivity
Nominal Head TSL parameters	22.0 °C	35.9	4.71 mho/m
Measured Head TSL parameters	(22.0 ± 0.2) °C	34.6 ± 6 %	4.48 mho/m ± 6 %
Head TSL temperature change during test	< 0.5 °C	----	----

SAR result with Head TSL at 5250 MHz

SAR averaged over 1 cm³ (1 g) of Head TSL	Condition	
SAR measured	100 mW input power	8.07 W/kg
SAR for nominal Head TSL parameters	normalized to 1W	80.0 W/kg ± 19.9 % (k=2)

SAR averaged over 10 cm³ (10 g) of Head TSL	condition	
SAR measured	100 mW input power	2.31 W/kg
SAR for nominal Head TSL parameters	normalized to 1W	22.8 W/kg ± 19.5 % (k=2)

Head TSL parameters at 5600 MHz

The following parameters and calculations were applied.

	Temperature	Permittivity	Conductivity
Nominal Head TSL parameters	22.0 °C	35.5	5.07 mho/m
Measured Head TSL parameters	(22.0 ± 0.2) °C	34.2 ± 6 %	4.83 mho/m ± 6 %
Head TSL temperature change during test	< 0.5 °C	----	----

SAR result with Head TSL at 5600 MHz

SAR averaged over 1 cm³ (1 g) of Head TSL	Condition	
SAR measured	100 mW input power	8.36 W/kg
SAR for nominal Head TSL parameters	normalized to 1W	82.8 W/kg ± 19.9 % (k=2)

SAR averaged over 10 cm³ (10 g) of Head TSL	condition	
SAR measured	100 mW input power	2.38 W/kg
SAR for nominal Head TSL parameters	normalized to 1W	23.5 W/kg ± 19.5 % (k=2)

Head TSL parameters at 5800 MHz

The following parameters and calculations were applied.

	Temperature	Permittivity	Conductivity
Nominal Head TSL parameters	22.0 °C	35.3	5.27 mho/m
Measured Head TSL parameters	(22.0 ± 0.2) °C	33.9 ± 6 %	5.03 mho/m ± 6 %
Head TSL temperature change during test	< 0.5 °C	----	----

SAR result with Head TSL at 5800 MHz

SAR averaged over 1 cm ³ (1 g) of Head TSL	Condition	
SAR measured	100 mW input power	8.09 W/kg
SAR for nominal Head TSL parameters	normalized to 1W	80.1 W/kg ± 19.9 % (k=2)

SAR averaged over 10 cm ³ (10 g) of Head TSL	condition	
SAR measured	100 mW input power	2.30 W/kg
SAR for nominal Head TSL parameters	normalized to 1W	22.7 W/kg ± 19.5 % (k=2)

Appendix (Additional assessments outside the scope of SCS 0108)

Antenna Parameters with Head TSL at 5250 MHz

Impedance, transformed to feed point	50.0 Ω - 6.1 j Ω
Return Loss	- 24.3 dB

Antenna Parameters with Head TSL at 5600 MHz

Impedance, transformed to feed point	56.9 Ω - 2.4 j Ω
Return Loss	- 23.3 dB

Antenna Parameters with Head TSL at 5800 MHz

Impedance, transformed to feed point	54.9 Ω - 1.9 j Ω
Return Loss	- 26.1 dB

General Antenna Parameters and Design

Electrical Delay (one direction)	1.201 ns
----------------------------------	----------

After long term use with 100W radiated power, only a slight warming of the dipole near the feedpoint can be measured.

The dipole is made of standard semirigid coaxial cable. The center conductor of the feeding line is directly connected to the second arm of the dipole. The antenna is therefore short-circuited for DC-signals. On some of the dipoles, small end caps are added to the dipole arms in order to improve matching when loaded according to the position as explained in the "Measurement Conditions" paragraph. The SAR data are not affected by this change. The overall dipole length is still according to the Standard.

No excessive force must be applied to the dipole arms, because they might bend or the soldered connections near the feedpoint may be damaged.

Additional EUT Data

Manufactured by	SPEAG
-----------------	-------

Test Laboratory: SPEAG, Zurich, Switzerland

DUT: Dipole D5GHzV2; Type: D5GHzV2; Serial: D5GHzV2 - SN:1138

Communication System: UID 0 - CW; Frequency: 5250 MHz, Frequency: 5600 MHz, Frequency: 5800 MHz
Medium parameters used: $f = 5250$ MHz; $\sigma = 4.48$ S/m; $\epsilon_r = 34.6$; $\rho = 1000$ kg/m³,
Medium parameters used: $f = 5600$ MHz; $\sigma = 4.83$ S/m; $\epsilon_r = 34.2$; $\rho = 1000$ kg/m³,
Medium parameters used: $f = 5800$ MHz; $\sigma = 5.03$ S/m; $\epsilon_r = 33.9$; $\rho = 1000$ kg/m³
Phantom section: Flat Section
Measurement Standard: DASY5 (IEEE/IEC/ANSI C63.19-2011)

DASY52 Configuration:

- Probe: EX3DV4 - SN3503; ConvF(5.5, 5.5, 5.5) @ 5250 MHz, ConvF(5.1, 5.1, 5.1) @ 5600 MHz, ConvF(5.01, 5.01, 5.01) @ 5800 MHz; Calibrated: 31.12.2019
- Sensor-Surface: 1.4mm (Mechanical Surface Detection)
- Electronics: DAE4 Sn601; Calibrated: 27.12.2019
- Phantom: Flat Phantom 5.0 (front); Type: QD 000 P50 AA; Serial: 1001
- DASY52 52.10.4(1527); SEMCAD X 14.6.14(7483)

Dipole Calibration for Head Tissue/Pin=100mW, dist=10mm, f=5250 MHz/Zoom Scan, dist=1.4mm (8x8x7)/Cube 0: Measurement grid: dx=4mm, dy=4mm, dz=1.4mm

Reference Value = 76.68 V/m; Power Drift = -0.08 dB

Peak SAR (extrapolated) = 28.4 W/kg

SAR(1 g) = 8.07 W/kg; SAR(10 g) = 2.31 W/kg

Smallest distance from peaks to all points 3 dB below = 7.4 mm

Ratio of SAR at M2 to SAR at M1 = 69.9%

Maximum value of SAR (measured) = 18.6 W/kg

Dipole Calibration for Head Tissue/Pin=100mW, dist=10mm, f=5600 MHz/Zoom Scan, dist=1.4mm (8x8x7)/Cube 0: Measurement grid: dx=4mm, dy=4mm, dz=1.4mm

Reference Value = 77.08 V/m; Power Drift = -0.07 dB

Peak SAR (extrapolated) = 31.5 W/kg

SAR(1 g) = 8.36 W/kg; SAR(10 g) = 2.38 W/kg

Smallest distance from peaks to all points 3 dB below = 7.4 mm

Ratio of SAR at M2 to SAR at M1 = 67.6%

Maximum value of SAR (measured) = 19.9 W/kg

Dipole Calibration for Head Tissue/Pin=100mW, dist=10mm, f=5800 MHz/Zoom Scan,

dist=1.4mm (8x8x7)/Cube 0: Measurement grid: dx=4mm, dy=4mm, dz=1.4mm

Reference Value = 73.94 V/m; Power Drift = -0.07 dB

Peak SAR (extrapolated) = 32.7 W/kg

SAR(1 g) = 8.09 W/kg; SAR(10 g) = 2.30 W/kg

Smallest distance from peaks to all points 3 dB below = 7.4 mm

Ratio of SAR at M2 to SAR at M1 = 65.1%

Maximum value of SAR (measured) = 19.7 W/kg

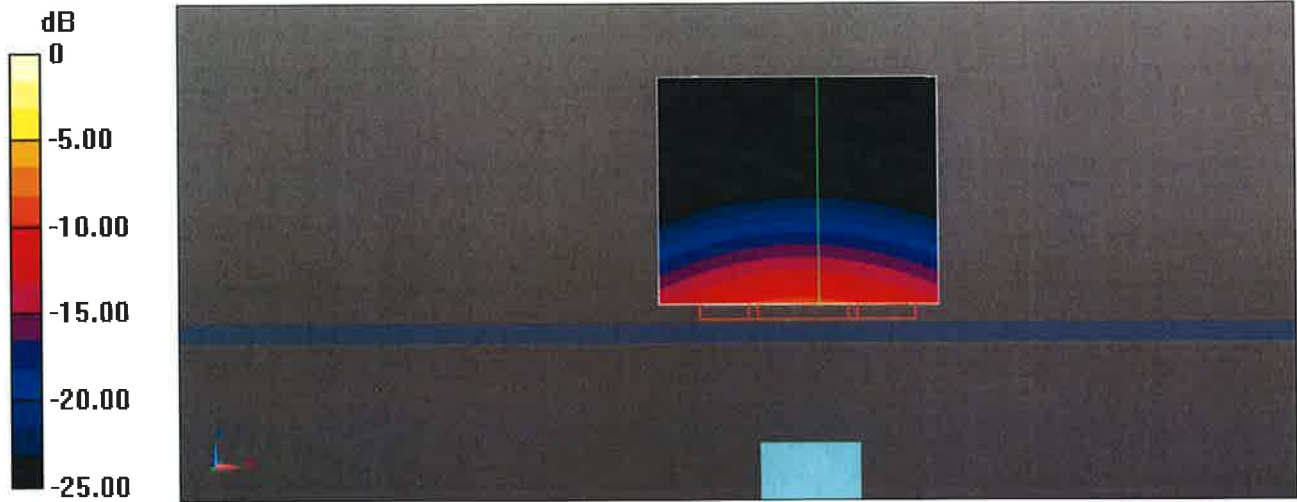

0 dB = 19.9 W/kg = 12.99 dBW/kg

Impedance Measurement Plot for Head TSL

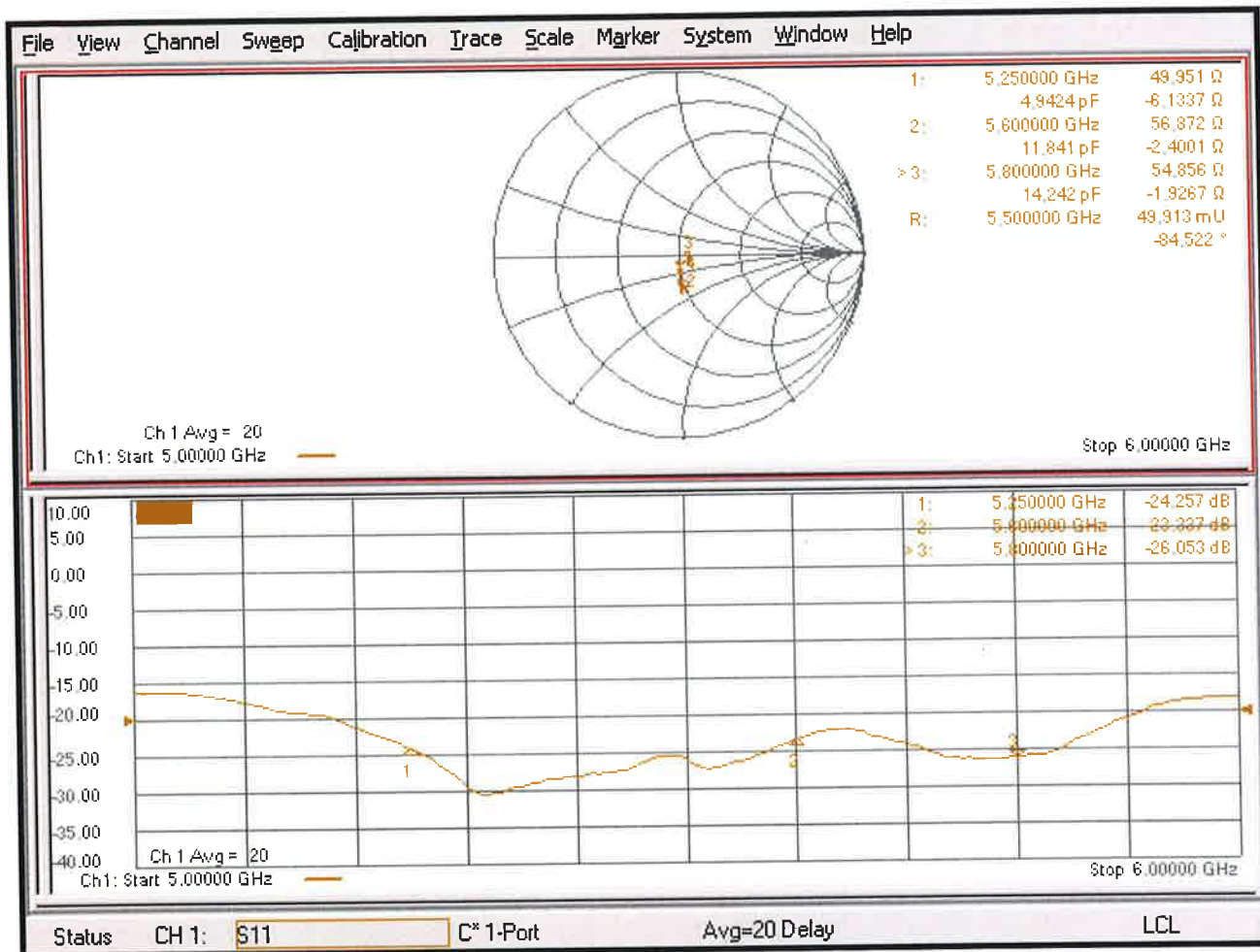

CERTIFICATE OF CALIBRATION

ISSUED BY **UL VS LTD**

DATE OF ISSUE: 12/Mar/2020

CERTIFICATE NUMBER : 13252596JD01C



5248

UL VS LTD
UNIT 1-3 HORIZON
KINGSLAND PARK, WADE ROAD
BASINGSTOKE, HAMPSHIRE
RG24 8AH, UK
TEL: +44 (0) 1256 312000
FAX: +44 (0) 1256 312001
Email: LST.UK.Calibration@ul.com



Page 1 of 16

APPROVED SIGNATORY

A handwritten signature in black ink, appearing to read 'M. Naseer'.

.....
Naseer Mirza

Customer :

UL VS Inc
47173 Benicia Street
Fremont, CA 94538, USA

Equipment Details:

Description:	Dipole Validation Kit	Date of Receipt:	26/Feb/2020
Manufacturer:	SPEAG		
Type/Model Number:	D5GHzV2		
Serial Number:	1003		
Calibration Date:	12/Mar/2020		
Calibrated By:	Harmohan Sahota Laboratory Engineer		

Signature:

A handwritten signature in black ink, appearing to read 'Harmohan Sahota'.

All Calibration have been conducted in the closed laboratory facility: Lab Temperature (22±3) °C and humidity < 70%

This certificate is issued in accordance with the laboratory accreditation requirements of the United Kingdom Accreditation Service. It provides traceability of measurement to the SI system of units and/or to units of measurement realised at the National Physical Laboratory or other recognised national metrology institutes. This certificate may not be reproduced other than in full, except with the prior written approval of the issuing laboratory.

Use of the UKAS mark demonstrates that compliance with the requirements of BS/EN/ISO/IEC 17025 has been independently assessed.

CERTIFICATE OF CALIBRATION

ISSUED BY UL VS LTD

UKAS Accredited Calibration Laboratory No. 5248

CERTIFICATE
NUMBER :
13252596JD01C

Page 2 of 16

The calibration methods and procedures used were as detailed in:

1. **IEC 62209-1:2016**: Procedure to determine the specific absorption rate (SAR) for hand-held devices used in close proximity to the ear (frequency range of 300 MHz to 3 GHz)
2. **IEC 62209-2:2010**: Procedure to determine the specific absorption rate (SAR) for wireless communication devices used in close proximity to the human body (frequency range of 30 MHz to 6 GHz)
3. **IEEE 1528: 2013**: IEEE Recommended Practice for Determining the Peak Spatial-Average Specific Absorption Rate (SAR) in the Human Head from Wireless Communication Devices: Measurement Techniques
4. FCC KDB Publication Number: “**KDB865664 D01 SAR Measurement 100 MHz to 6 GHz**”
5. **SPEAG DASY5 System Handbook**

The measuring equipment used to perform the calibration, documented in this certificate has been calibrated in accordance with the manufacturers' recommendations, and is traceable to recognized national standards.

UL No.	Instrument	Manufacturer	Type No.	Serial No.	Date Last Calibrated	Cal. Interval (Months)
A2547	Data Acquisition Electronics	SPEAG	DAE4	1438	11 Apr 2019	12
A2545	Probe	SPEAG	EX3DV4	3995	24 Apr 2019	12
A1377	Dipole	SPEAG	D5GHzv2	1016	18 Feb 2020	12
PRE0151451	Power Monitoring Kit	Art-Fi	ART 100850-01	0001	Cal as part of System	-
PRE0151441	Power Sensor	Rhode & Schwarz	NRP8S	102481	27 Mar 2019	12
PRE0151154	Vector Network Analyser	Rhode & Schwarz	ZND8	100151	30 Jan 2020	12
PRE0151877	Calibration Kit	Rhode & Schwarz	ZV-Z135	102947	17 Oct 2019	12
PRE0178154	Signal Generator	Rhode & Schwarz	SMB 100A	175325	30 Apr 2019	12

CERTIFICATE OF CALIBRATION

ISSUED BY UL VS LTD

UKAS Accredited Calibration Laboratory No. 5248

CERTIFICATE
NUMBER :
13252596JD01C

Page 3 of 16

SAR System Specification

Robot System Positioner:	Stäubli Unimation Corp. Robot Model: TX60L
Robot Serial Number:	F17/5ENYG1/A/01
DASY Version:	DASY 52 (v52.10.0.1446)
Phantom:	Flat section of SAM Twin Phantom
Distance Dipole Centre:	10 mm (with spacer)

Frequency: 5250 MHz

Dielectric Property Measurements – Head Simulating Liquid (HSL)

Simulant Liquid	Frequency (MHz)	Room Temp		Liquid Temp		Parameters	Target Value	Measured Value	Uncertainty (%)
		Start	End	Start	End				
Head	5250	20.6 °C	21.6 °C	20.4°C	20.6°C	ϵ_r	35.9	36.151	± 5%
						σ	4.71	4.652	± 5%

SAR Results – Head Simulating Liquid (HSL)

Simulant Liquid	SAR Measured	100 mW input Power	Normalised to 1.00 W	Uncertainty (%)
Head	SAR averaged over 1g	8.01 W/Kg	80.1 W/Kg	± 18.75%
	SAR averaged over 10g	2.29 W/Kg	22.9 W/Kg	± 18.63%

Antenna Parameters – Head Simulating Liquid (HSL)

Simulant Liquid	Parameter	Measured Level	Uncertainty (%)
Head	Impedance	58.014 Ω + 5.272 j Ω	± 0.28 Ω ± 0.044 j Ω
	Return Loss	-21.04	± 2.23 dB

Frequency: 5600 MHz

Dielectric Property Measurements – Head Simulating Liquid (HSL)

Simulant Liquid	Frequency (MHz)	Room Temp		Liquid Temp		Parameters	Target Value	Measured Value	Uncertainty (%)
		Start	End	Start	End				
Head	5600	20.6 °C	21.6 °C	20.4°C	20.6°C	ϵ_r	35.5	35.524	± 5%
						σ	5.07	5.047	± 5%

SAR Results – Head Simulating Liquid (HSL)

Simulant Liquid	SAR Measured	100 mW input Power	Normalised to 1.00 W	Uncertainty (%)
Head	SAR averaged over 1g	7.98 W/Kg	79.8 W/Kg	± 18.75%
	SAR averaged over 10g	2.25 W/Kg	22.5 W/Kg	± 18.63%

Antenna Parameters – Head Simulating Liquid (HSL)

Simulant Liquid	Parameter	Measured Level	Uncertainty (%)
Head	Impedance	45.328 Ω + 2.547 j Ω	± 0.28 Ω ± 0.044 j Ω
	Return Loss	-25.05	± 2.23 dB

CERTIFICATE OF CALIBRATION

ISSUED BY UL VS LTD

UKAS Accredited Calibration Laboratory No. 5248

CERTIFICATE
NUMBER :
13252596JD01C

Page 4 of 16

Frequency: 5750 MHz

Dielectric Property Measurements – Head Simulating Liquid (HSL)

Simulant Liquid	Frequency (MHz)	Room Temp		Liquid Temp		Parameters	Target Value	Measured Value	Uncertainty (%)
		Start	End	Start	End				
Head	5750	20.6 °C	21.6 °C	20.4°C	20.6°C	ϵ_r	35.4	35.25	± 5%
						σ	5.22	5.217	± 5%

SAR Results – Head Simulating Liquid (HSL)

Simulant Liquid	SAR Measured	100 mW input Power	Normalised to 1.00 W	Uncertainty (%)
Head	SAR averaged over 1g	7.37 W/Kg	73.7 W/Kg	± 18.75%
	SAR averaged over 10g	2.10 W/Kg	21.0 W/Kg	± 18.63%

Antenna Parameters – Head Simulating Liquid (HSL)

Simulant Liquid	Parameter	Measured Level	Uncertainty (%)
Head	Impedance	59.08 Ω + 1.306 $j\Omega$	± 0.28 Ω ± 0.044 $j\Omega$
	Return Loss	-21.52	± 2.23 dB

CERTIFICATE OF CALIBRATION

ISSUED BY UL VS LTD

UKAS Accredited Calibration Laboratory No. 5248

CERTIFICATE
NUMBER :
13252596JD01C

Page 5 of 16

Frequency: 5250 MHz

Dielectric Property Measurements – Body Simulating Liquid (MSL)

Simulant Liquid	Frequency (MHz)	Room Temp		Liquid Temp		Parameters	Target Value	Measured Value	Uncertainty (%)
		Start	End	Start	End				
Body	5250	21.0 °C	21.2 °C	20.7°C	20.8°C	ϵ_r	48.9	48.462	± 5%
						σ	5.36	5.402	± 5%

SAR Results – Body Simulating Liquid (MSL)

Simulant Liquid	SAR Measured	100 mW input Power	Normalised to 1.00 W	Uncertainty (%)
Body	SAR averaged over 1g	7.96 W/Kg	79.6 W/Kg	± 18.53%
	SAR averaged over 10g	2.23 W/Kg	22.3 W/Kg	± 18.61%

Antenna Parameters – Body Simulating Liquid (MSL)

Simulant Liquid	Parameter	Measured Level	Uncertainty (%)
Body	Impedance	58.686 Ω + 5.831 j Ω	± 0.28 Ω ± 0.044 j Ω
	Return Loss	-20.33	± 2.23 dB

Frequency: 5600 MHz

Dielectric Property Measurements – Body Simulating Liquid (MSL)

Simulant Liquid	Frequency (MHz)	Room Temp		Liquid Temp		Parameters	Target Value	Measured Value	Uncertainty (%)
		Start	End	Start	End				
Body	5600	21.0 °C	21.2 °C	20.7°C	20.8°C	ϵ_r	48.5	47.929	± 5%
						σ	5.77	5.93	± 5%

SAR Results – Body Simulating Liquid (MSL)

Simulant Liquid	SAR Measured	50 mW input Power	Normalised to 1.00 W	Uncertainty (%)
Body	SAR averaged over 1g	3.86 W/Kg	77.01 W/Kg	± 18.53%
	SAR averaged over 10g	1.07 W/Kg	21.34 W/Kg	± 18.61%

Antenna Parameters – Body Simulating Liquid (MSL)

Simulant Liquid	Parameter	Measured Level	Uncertainty (%)
Body	Impedance	45.54 Ω + 2.691 j Ω	± 0.28 Ω ± 0.044 j Ω
	Return Loss	-25.30	± 2.23 dB

CERTIFICATE OF CALIBRATION

ISSUED BY UL VS LTD

UKAS Accredited Calibration Laboratory No. 5248

CERTIFICATE
NUMBER :
13252596JD01C

Page 6 of 16

Frequency: 5750 MHz

Dielectric Property Measurements – Body Simulating Liquid (MSL)

Simulant Liquid	Frequency (MHz)	Room Temp		Liquid Temp		Parameters	Target Value	Measured Value	Uncertainty (%)
		Start	End	Start	End				
Body	5750	21.0 °C	21.2 °C	20.7°C	20.8°C	ϵ_r	48.3	47.506	± 5%
						σ	5.94	6.12	± 5%

SAR Results – Body Simulating Liquid (MSL)

Simulant Liquid	SAR Measured	100 mW input Power	Normalised to 1.00 W	Uncertainty (%)
Body	SAR averaged over 1g	7.48 W/Kg	74.8 W/Kg	± 18.53%
	SAR averaged over 10g	2.09 W/Kg	20.9 W/Kg	± 18.61%

Antenna Parameters – Body Simulating Liquid (MSL)

Simulant Liquid	Parameter	Measured Level	Uncertainty (%)
Body	Impedance	58.526 Ω + 4.072 j Ω	± 0.28 Ω ± 0.044 j Ω
	Return Loss	-21.24	± 2.23 dB

CERTIFICATE OF CALIBRATION

ISSUED BY UL VS LTD

UKAS Accredited Calibration Laboratory No. 5248

CERTIFICATE
NUMBER :
13252596JD01C

Page 7 of 16

DASY Validation Scan for Head Stimulating Liquid (HSL)

DUT: D5GHzV2 - SN1003; Type: D5GHzV2; Serial: SN1003

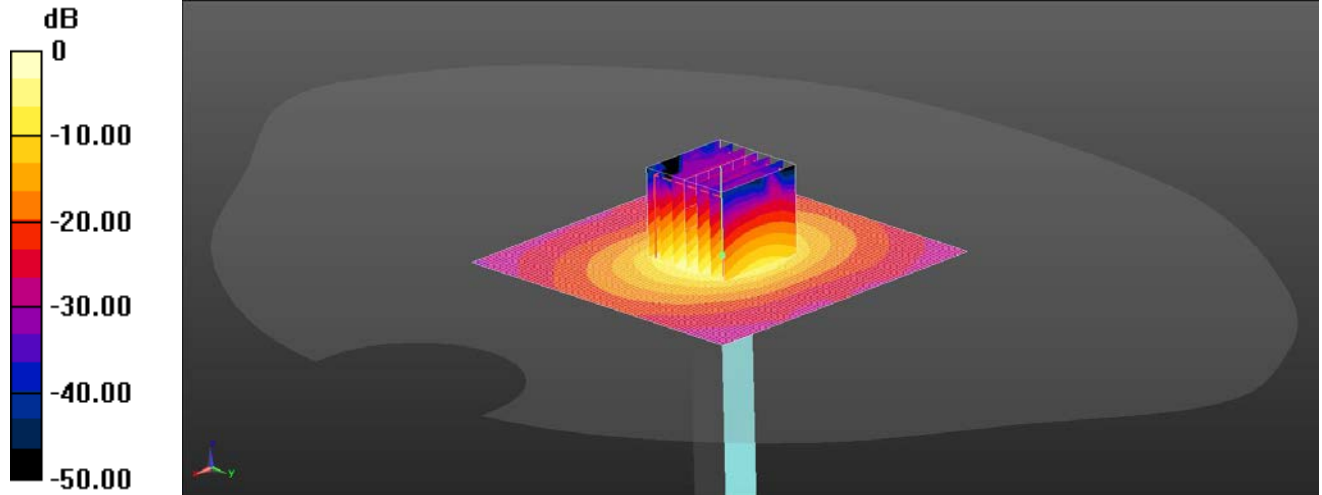

0 dB = 20.2 W/kg = 13.05 dBW/kg

Communication System: UID 0, CW (0); Frequency: 5250 MHz; Duty Cycle: 1:1
Medium: HSL 09 03 20 - 2450 3500 5250 5600 5750 5% Medium parameters used: $f = 5250$ MHz; $\sigma = 4.659$ S/m; $\epsilon_r = 36.152$; $\rho = 1000$ kg/m³

Phantom section: Flat Section

DASY4 Configuration:

- Probe: EX3DV4 - SN3995; ConvF(5.34, 5.34, 5.34); Calibrated: 24/04/2019;
- Sensor-Surface: 1.4mm (Mechanical Surface Detection)
- Electronics: DAE4 Sn1438; Calibrated: 11/04/2019
- Phantom: Twin-SAM V8.0 (20deg probe tilt); Type: QD 000 P41 Ax; Serial: 1945
- ; SEMCAD X Version 14.6.10 (7417)

5250/PMK d=10mm, Pin=100mW/Area Scan (81x81x1): Interpolated grid: dx=1.000 mm, dy=1.000 mm

Maximum value of SAR (interpolated) = 20.9 W/kg

5250/PMK d=10mm, Pin=100mW/Zoom Scan (7x7x7)/Cube 0: Measurement grid: dx=4mm, dy=4mm, dz=1.4mm

Reference Value = 73.94 V/m; Power Drift = -0.12 dB

Peak SAR (extrapolated) = 32.3 W/kg

SAR(1 g) = 8.01 W/kg; SAR(10 g) = 2.29 W/kg

Maximum value of SAR (measured) = 20.2 W/kg

CERTIFICATE OF CALIBRATION

ISSUED BY UL VS LTD

UKAS Accredited Calibration Laboratory No. 5248

CERTIFICATE
NUMBER :
13252596JD01C

Page 8 of 16

DASY Validation Scan for Head Stimulating Liquid (HSL)

DUT: D5GHzV2 - SN1003; Type: D5GHzV2; Serial: SN1003

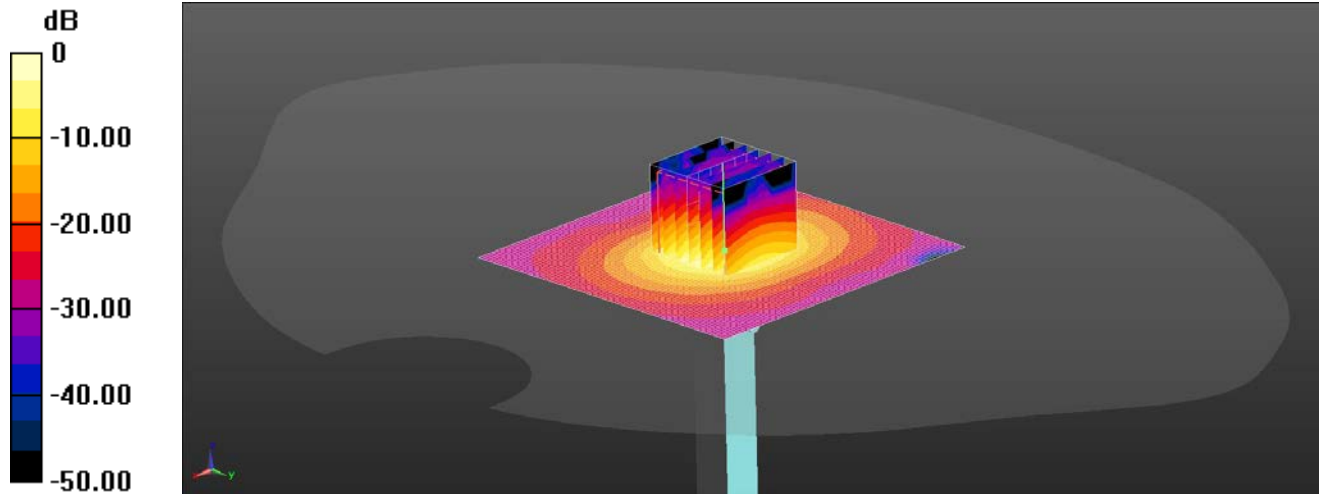

0 dB = 20.9 W/kg = 13.20 dBW/kg

Communication System: UID 0, CW (0); Frequency: 5600 MHz; Duty Cycle: 1:1

Medium: HSL 09 03 20 - 2450 3500 5250 5600 5750 5% Medium parameters used: $f = 5600$ MHz; $\sigma = 5.054$ S/m; $\epsilon_r = 35.525$; $\rho = 1000$ kg/m³

Phantom section: Flat Section

DASY4 Configuration:

- Probe: EX3DV4 - SN3995; ConvF(5.05, 5.05, 5.05); Calibrated: 24/04/2019;
- Sensor-Surface: 1.4mm (Mechanical Surface Detection)
- Electronics: DAE4 Sn1438; Calibrated: 11/04/2019
- Phantom: Twin-SAM V8.0 (20deg probe tilt); Type: QD 000 P41 Ax; Serial: 1945
- ; SEMCAD X Version 14.6.10 (7417)

5600/PMK d=10mm, Pin=100mW/Area Scan (81x81x1): Interpolated grid: dx=1.000 mm, dy=1.000 mm

Maximum value of SAR (interpolated) = 20.5 W/kg

5600/PMK d=10mm, Pin=100mW/Zoom Scan (7x7x7)/Cube 0: Measurement grid: dx=4mm, dy=4mm, dz=1.4mm

Reference Value = 70.02 V/m; Power Drift = 0.04 dB

Peak SAR (extrapolated) = 35.3 W/kg

SAR(1 g) = 7.98 W/kg; SAR(10 g) = 2.25 W/kg

Maximum value of SAR (measured) = 20.9 W/kg

CERTIFICATE OF CALIBRATION

ISSUED BY UL VS LTD

UKAS Accredited Calibration Laboratory No. 5248

CERTIFICATE
NUMBER :
13252596JD01C

Page 9 of 16

DASY Validation Scan for Head Stimulating Liquid (HSL)

DUT: D5GHzV2 - SN1003; Type: D5GHzV2; Serial: SN1003

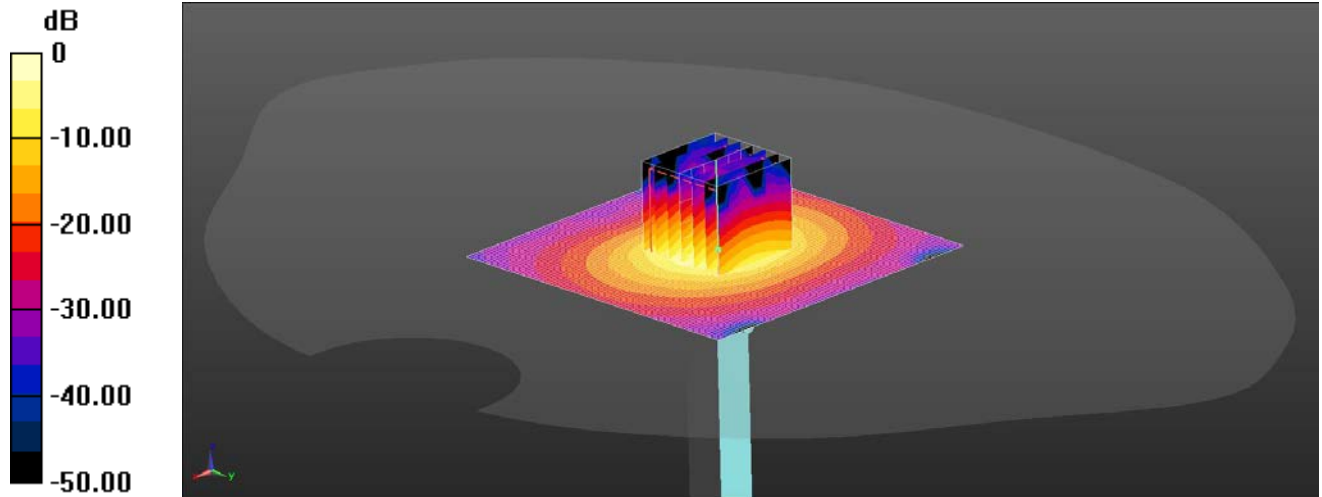

0 dB = 19.4 W/kg = 12.88 dBW/kg

Communication System: UID 0, CW (0); Frequency: 5750 MHz; Duty Cycle: 1:1
Medium: HSL 09 03 20 - 2450 3500 5250 5600 5750 5% Medium parameters used: $f = 5750$ MHz; $\sigma = 5.225$ S/m; $\epsilon_r = 35.25$; $\rho = 1000$ kg/m³
Phantom section: Flat Section
DASY4 Configuration:
- Probe: EX3DV4 - SN3995; ConvF(5.15, 5.15, 5.15); Calibrated: 24/04/2019;
- Sensor-Surface: 1.4mm (Mechanical Surface Detection)
- Electronics: DAE4 Sn1438; Calibrated: 11/04/2019
- Phantom: Twin-SAM V8.0 (20deg probe tilt); Type: QD 000 P41 Ax; Serial: 1945
- ; SEMCAD X Version 14.6.10 (7417)

5750/PMK d=10mm, Pin=100mW/Area Scan (81x81x1): Interpolated grid: dx=1.000 mm, dy=1.000 mm

Maximum value of SAR (interpolated) = 19.1 W/kg

5750/PMK d=10mm, Pin=100mW/Zoom Scan (7x7x7)/Cube 0: Measurement grid: dx=4mm, dy=4mm, dz=1.4mm

Reference Value = 66.19 V/m; Power Drift = 0.07 dB

Peak SAR (extrapolated) = 33.9 W/kg

SAR(1 g) = 7.37 W/kg; SAR(10 g) = 2.1 W/kg

Maximum value of SAR (measured) = 19.4 W/kg

CERTIFICATE OF CALIBRATION

ISSUED BY UL VS LTD

UKAS Accredited Calibration Laboratory No. 5248

CERTIFICATE
NUMBER :
13252596JD01C

Page 10 of 16

Impedance Measurement Plot for Head Stimulating Liquid (HSL)

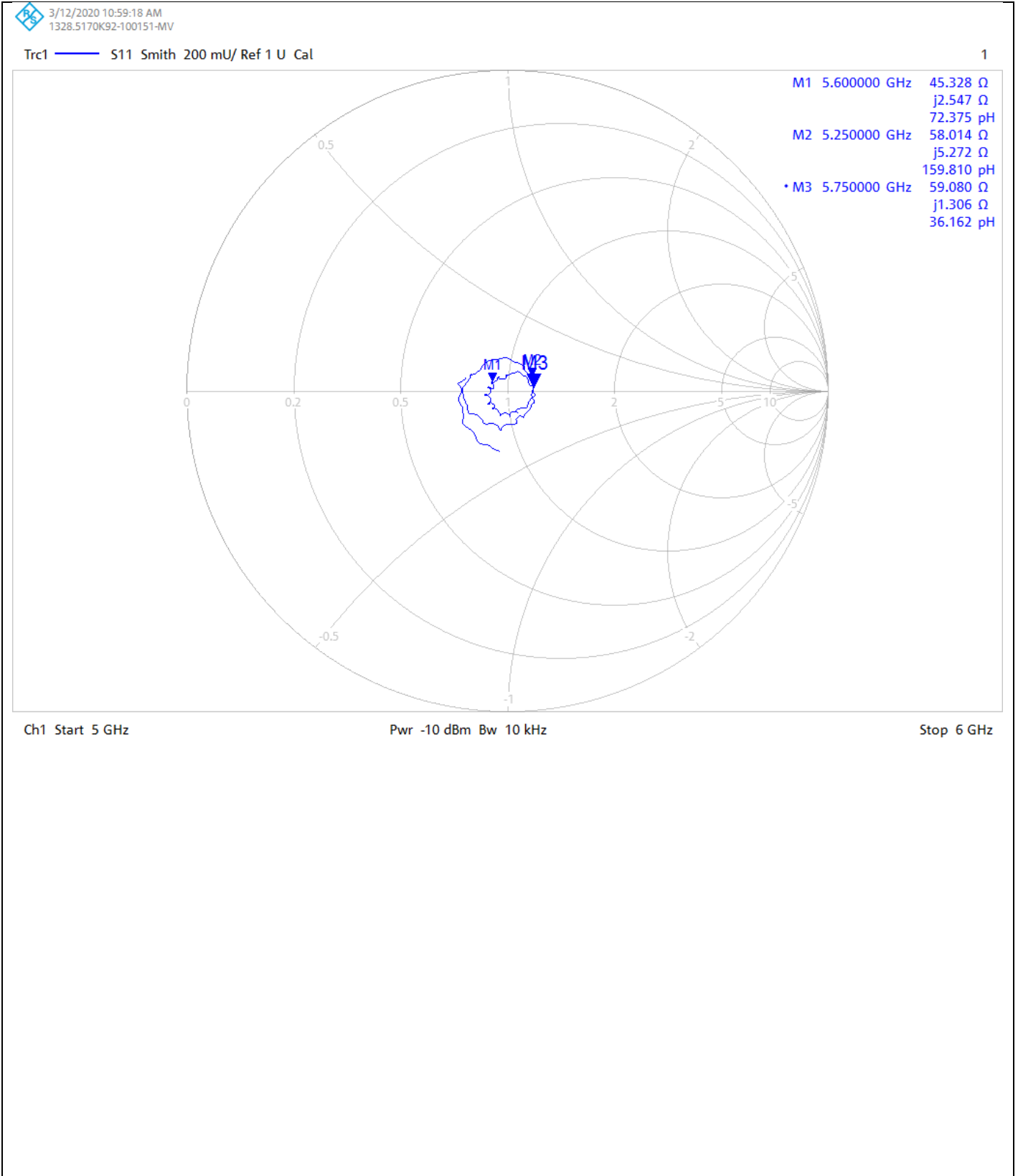

CERTIFICATE OF CALIBRATION

ISSUED BY UL VS LTD

UKAS Accredited Calibration Laboratory No. 5248

CERTIFICATE
NUMBER :
13252596JD01C

Page 11 of 16

Return Loss Measurement Plot for Head Stimulating Liquid (HSL)

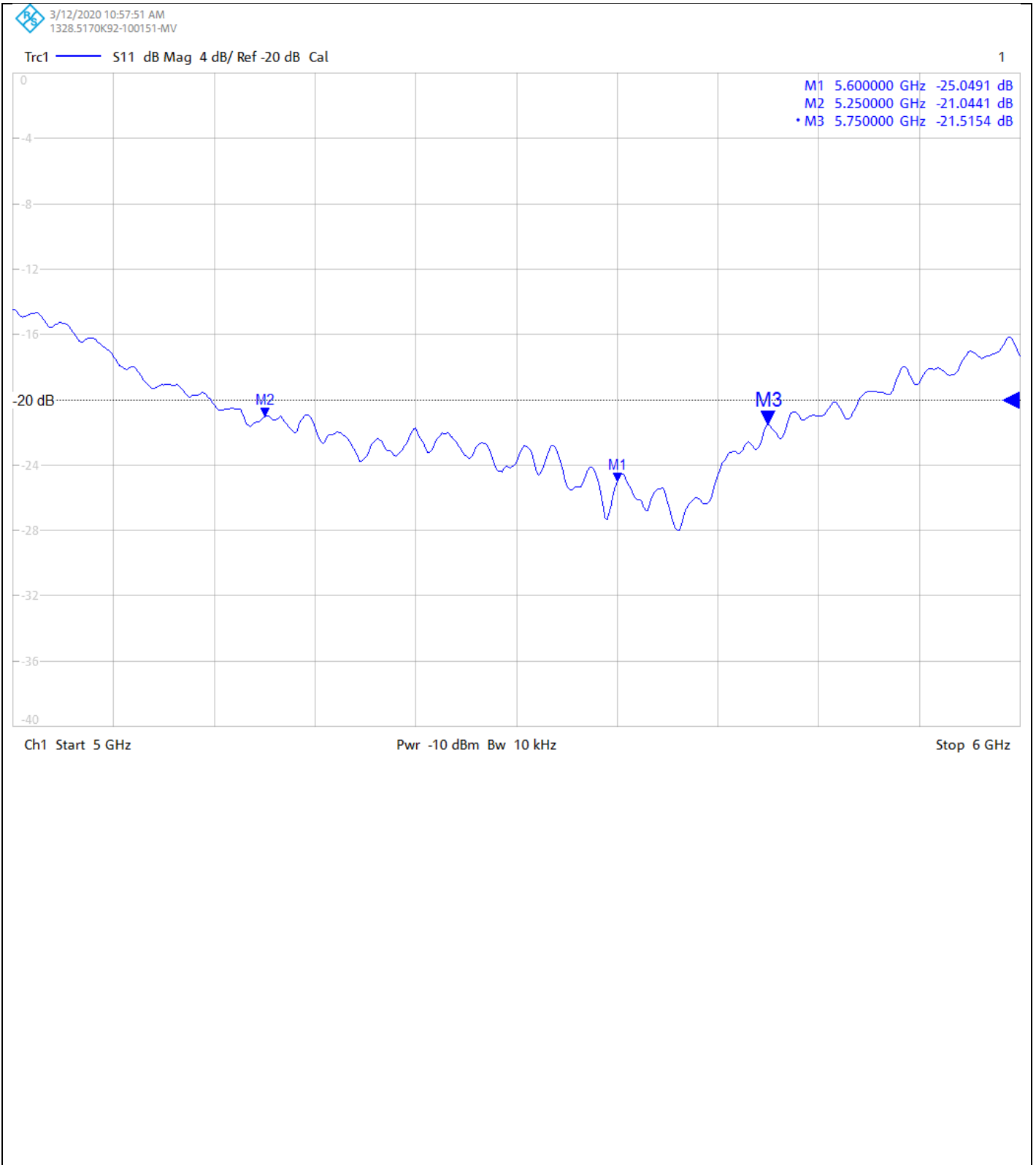

CERTIFICATE OF CALIBRATION

ISSUED BY UL VS LTD

UKAS Accredited Calibration Laboratory No. 5248

CERTIFICATE
NUMBER :
13252596JD01C

Page 12 of 16

DASY Validation Scan for Body Stimulating Liquid (MSL)

DUT: D5GHzV2 - SN1003; Type: D5GHzV2; Serial: SN1003

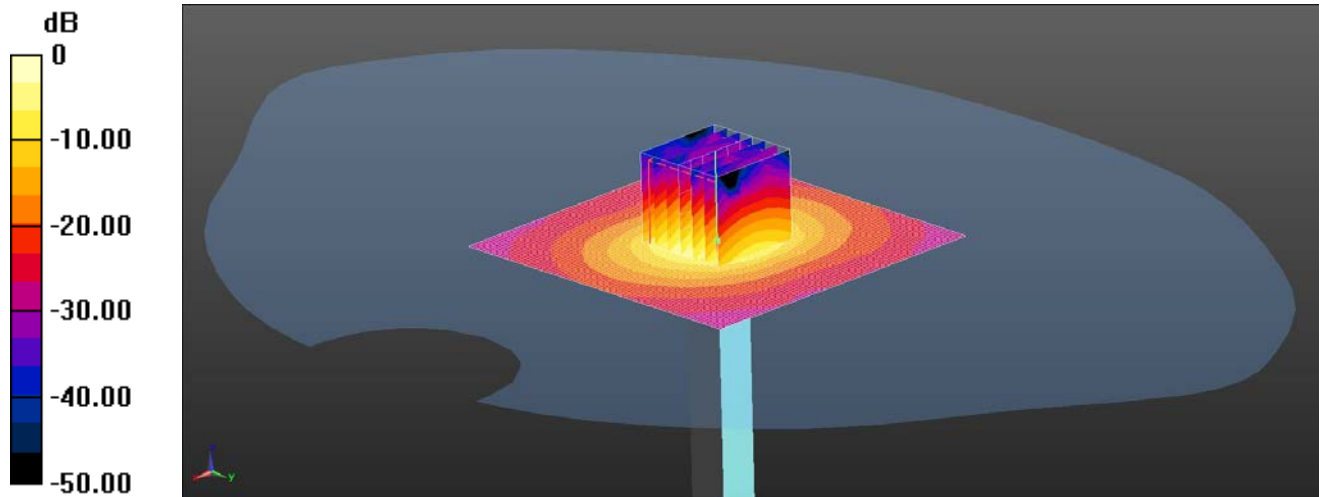

0 dB = 20.4 W/kg = 13.10 dBW/kg

Communication System: UID 0, CW (0); Frequency: 5250 MHz; Duty Cycle: 1:1
Medium: MSL 10 03 20 - 5250, 5600, 5750 5% Medium parameters used: $f = 5250$ MHz; $\sigma = 5.41$ S/m; $\epsilon_r = 48.463$; $\rho = 1000$ kg/m³

Phantom section: Flat Section

DASY4 Configuration:

- Probe: EX3DV4 - SN3995; ConvF(4.78, 4.78, 4.78); Calibrated: 24/04/2019;
- Sensor-Surface: 1.4mm (Mechanical Surface Detection)
- Electronics: DAE4 Sn1438; Calibrated: 11/04/2019
- Phantom: Twin SAM A (Site 65); Type: SAM 5.0; Serial: SN1818
- ; SEMCAD X Version 14.6.10 (7417)

5250/d=10mm, Pin=100mW/Area Scan (81x81x1): Interpolated grid: dx=1.000 mm, dy=1.000 mm

Maximum value of SAR (interpolated) = 20.5 W/kg

5250/d=10mm, Pin=100mW/Zoom Scan (7x7x7)/Cube 0: Measurement grid: dx=4mm, dy=4mm, dz=1.4mm

Reference Value = 70.27 V/m; Power Drift = -0.00 dB

Peak SAR (extrapolated) = 32.2 W/kg

SAR(1 g) = 7.96 W/kg; SAR(10 g) = 2.23 W/kg

Maximum value of SAR (measured) = 20.4 W/kg

CERTIFICATE OF CALIBRATION

ISSUED BY UL VS LTD

UKAS Accredited Calibration Laboratory No. 5248

CERTIFICATE
NUMBER :
13252596JD01C

Page 13 of 16

DASY Validation Scan for Body Stimulating Liquid (MSL)

DUT: D5GHzV2 - SN1003; Type: D5GHzV2; Serial: SN1003

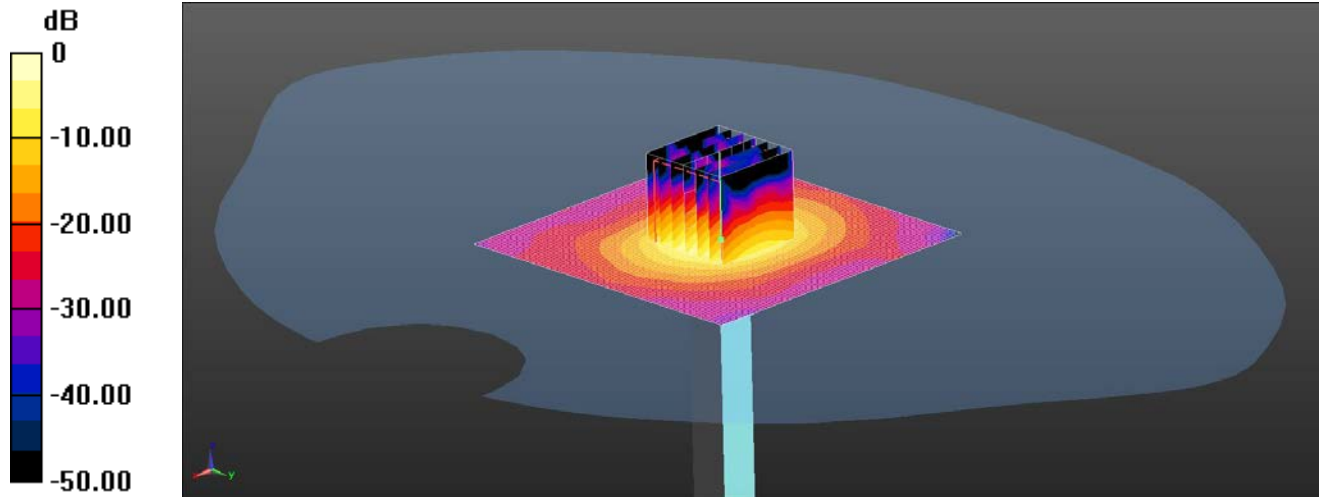

0 dB = 10.3 W/kg = 10.13 dBW/kg

Communication System: UID 0, CW (0); Frequency: 5600 MHz; Duty Cycle: 1:1
Medium: MSL 10 03 20 - 5250, 5600, 5750 5% Medium parameters used: $f = 5600$ MHz; $\sigma = 5.939$ S/m; $\epsilon_r = 47.929$; $\rho = 1000$ kg/m³

Phantom section: Flat Section

DASY4 Configuration:

- Probe: EX3DV4 - SN3995; ConvF(4.32, 4.32, 4.32); Calibrated: 24/04/2019;
- Sensor-Surface: 1.4mm (Mechanical Surface Detection)
- Electronics: DAE4 Sn1438; Calibrated: 11/04/2019
- Phantom: Twin SAM A (Site 65); Type: SAM 5.0; Serial: SN1818
- ; SEMCAD X Version 14.6.10 (7417)

5600/Power Source d=10mm, Pin=50mW/Area Scan (81x81x1): Interpolated grid: dx=1.000 mm, dy=1.000 mm

Maximum value of SAR (interpolated) = 10.3 W/kg

5600/Power Source d=10mm, Pin=50mW/Zoom Scan (7x7x7)/Cube 0: Measurement grid: dx=4mm, dy=4mm, dz=1.4mm

Reference Value = 47.80 V/m; Power Drift = -0.08 dB

Peak SAR (extrapolated) = 17.2 W/kg

SAR(1 g) = 3.86 W/kg; SAR(10 g) = 1.07 W/kg

Maximum value of SAR (measured) = 10.3 W/kg

CERTIFICATE OF CALIBRATION

ISSUED BY UL VS LTD

UKAS Accredited Calibration Laboratory No. 5248

CERTIFICATE
NUMBER :
13252596JD01C

Page 14 of 16

DASY Validation Scan for Body Stimulating Liquid (MSL)

DUT: D5GHzV2 - SN1003; Type: D5GHzV2; Serial: SN1003

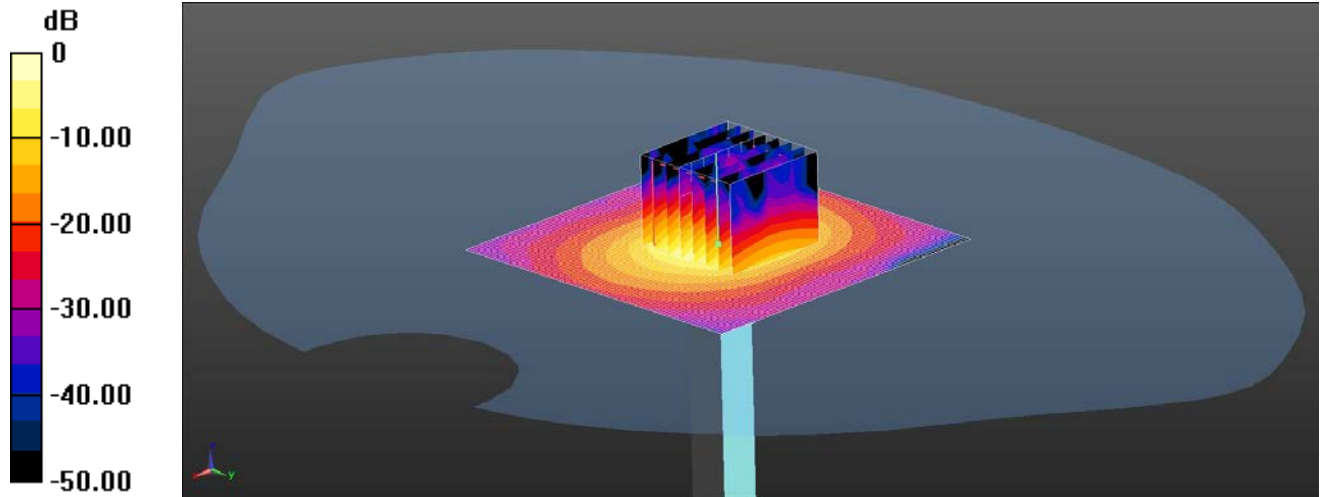

0 dB = 20.0 W/kg = 13.01 dBW/kg

Communication System: UID 0, CW (0); Frequency: 5750 MHz; Duty Cycle: 1:1

Medium: MSL 10 03 20 - 5250, 5600, 5750 5% Medium parameters used: $f = 5750$ MHz; $\sigma = 6.129$ S/m; $\epsilon_r = 47.506$; $\rho = 1000$ kg/m³

Phantom section: Flat Section

DASY4 Configuration:

- Probe: EX3DV4 - SN3995; ConvF(4.5, 4.5, 4.5); Calibrated: 24/04/2019;
- Sensor-Surface: 1.4mm (Mechanical Surface Detection)
- Electronics: DAE4 Sn1438; Calibrated: 11/04/2019
- Phantom: Twin SAM A (Site 65); Type: SAM 5.0; Serial: SN1818
- ; SEMCAD X Version 14.6.10 (7417)

5750/PMK d=10mm, Pin=100mW/Area Scan (81x81x1): Interpolated grid: dx=1.000 mm, dy=1.000 mm

Maximum value of SAR (interpolated) = 20.1 W/kg

5750/PMK d=10mm, Pin=100mW/Zoom Scan (8x8x7)/Cube 0: Measurement grid: dx=4mm, dy=4mm, dz=1.4mm

Reference Value = 65.55 V/m; Power Drift = 0.03 dB

Peak SAR (extrapolated) = 34.9 W/kg

SAR(1 g) = 7.48 W/kg; SAR(10 g) = 2.09 W/kg

Maximum value of SAR (measured) = 20.0 W/kg

CERTIFICATE OF CALIBRATION

ISSUED BY UL VS LTD

UKAS Accredited Calibration Laboratory No. 5248

CERTIFICATE
NUMBER :
13252596JD01C

Page 15 of 16

Impedance Measurement Plot for Body Stimulating Liquid (MSL)

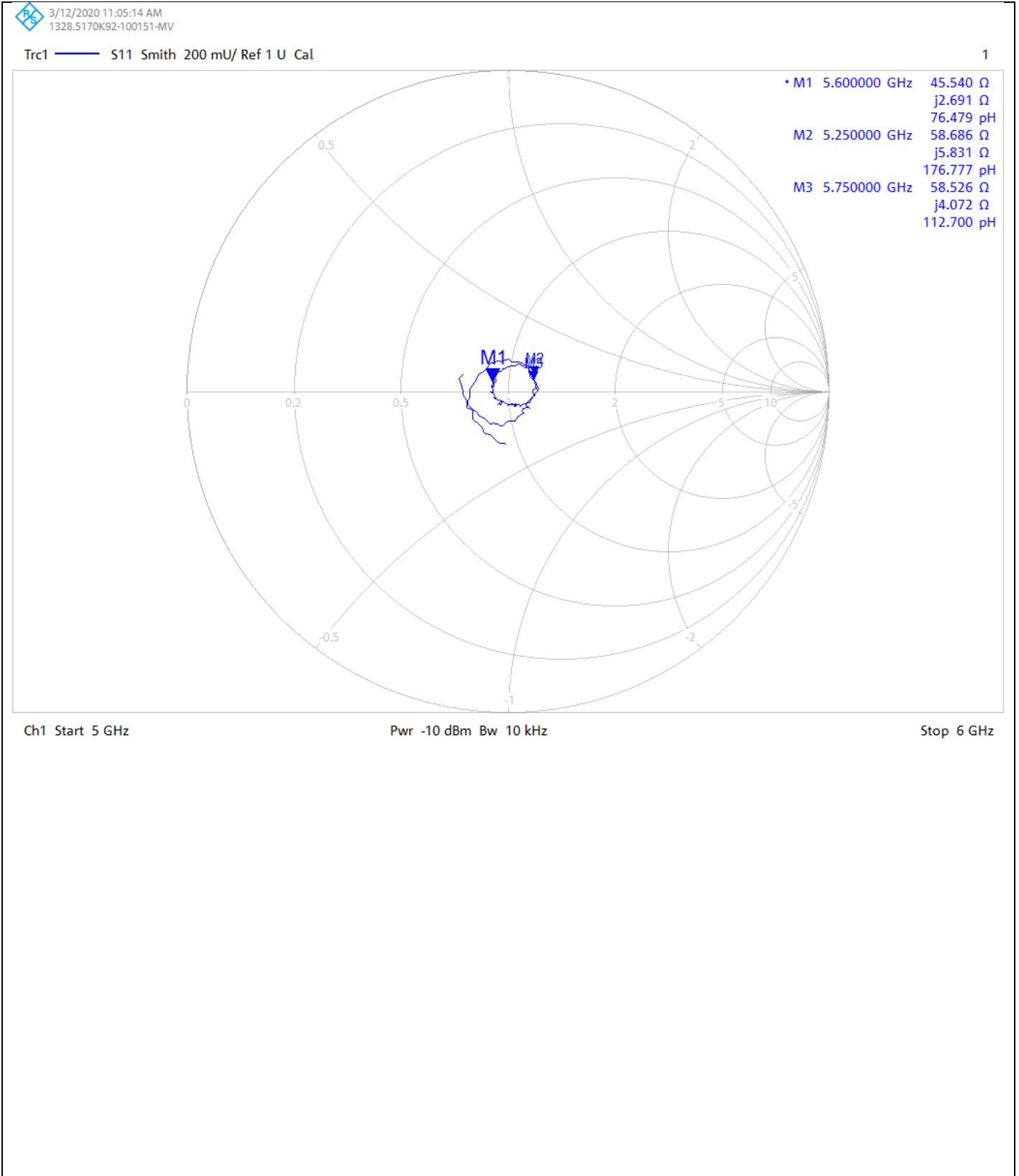

CERTIFICATE OF CALIBRATION

ISSUED BY UL VS LTD

UKAS Accredited Calibration Laboratory No. 5248

CERTIFICATE
NUMBER :
13252596JD01C

Page 16 of 16

Return Loss Measurement Plot for Body Stimulating Liquid (MSL)

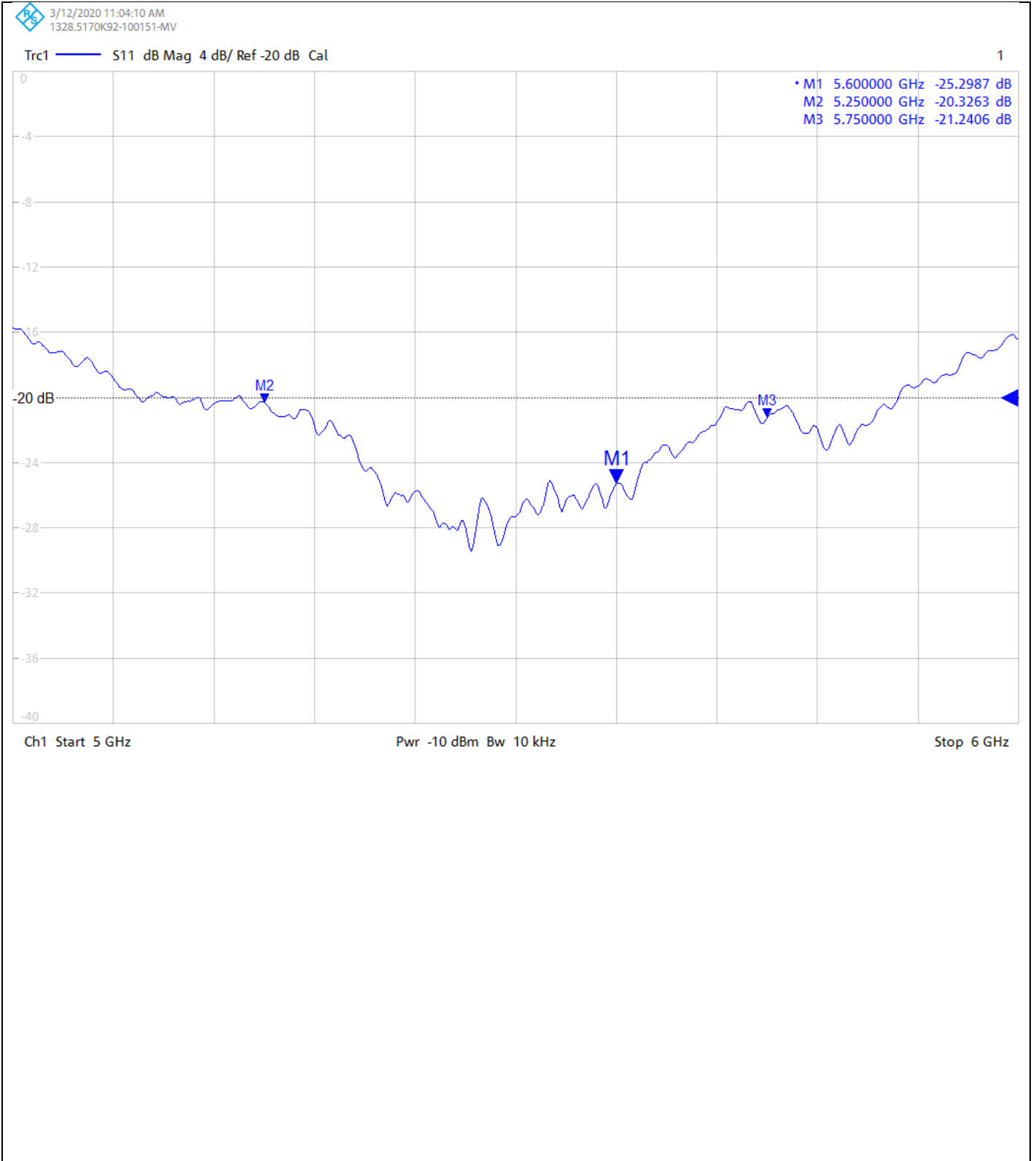

Calibration Certificate Label:

	<p>UL VS LTD - Tel: +44 (0) 1256312000</p> <p>Certificate Number: 13252596JD01C</p> <p>Instrument ID: 1003</p> <p>Calibration Date: 12/Mar/2020</p> <p>Calibration Due Date:</p>
-----------------------------------------------------------------------------------	-----------------------------------------------------------------------------------------------------------------------------------------------------------------------------------------

	<p>UL VS LTD - Tel: +44 (0) 1256312000</p> <p>Certificate Number: 13252596JD01C</p> <p>Instrument ID: 1003</p> <p>Calibration Date: 12/Mar/2020</p> <p>Calibration Due Date:</p>
-----------------------------------------------------------------------------------	-----------------------------------------------------------------------------------------------------------------------------------------------------------------------------------------

	<p>UL VS LTD - Tel: +44 (0) 1256312000</p> <p>Certificate Number: 13252596JD01C</p> <p>Instrument ID: 1003</p> <p>Calibration Date: 12/Mar/2020</p> <p>Calibration Due Date:</p>
-------------------------------------------------------------------------------------	-----------------------------------------------------------------------------------------------------------------------------------------------------------------------------------------