



Accredited by the Swiss Accreditation Service (SAS)
**The Swiss Accreditation Service is one of the signatories to the EA
Multilateral Agreement for the recognition of calibration certificates**

Accreditation No.: **SCS 0108**

Client **UL CCS USA**

Certificate No: **D750V3-1019_Mar19**

CALIBRATION CERTIFICATE

Object **D750V3 - SN:1019**

Calibration procedure(s) **QA CAL-05.v11
Calibration Procedure for SAR Validation Sources between 0.7-3 GHz**

Calibration date: **March 21, 2019**

This calibration certificate documents the traceability to national standards, which realize the physical units of measurements (SI).
The measurements and the uncertainties with confidence probability are given on the following pages and are part of the certificate.

All calibrations have been conducted in the closed laboratory facility: environment temperature (22 ± 3)°C and humidity < 70%.

Calibration Equipment used (M&TE critical for calibration)

Primary Standards	ID #	Cal Date (Certificate No.)	Scheduled Calibration
Power meter NRP	SN: 104778	04-Apr-18 (No. 217-02672/02673)	Apr-19
Power sensor NRP-Z91	SN: 103244	04-Apr-18 (No. 217-02672)	Apr-19
Power sensor NRP-Z91	SN: 103245	04-Apr-18 (No. 217-02673)	Apr-19
Reference 20 dB Attenuator	SN: 5058 (20k)	04-Apr-18 (No. 217-02682)	Apr-19
Type-N mismatch combination	SN: 5047.2 / 06327	04-Apr-18 (No. 217-02683)	Apr-19
Reference Probe EX3DV4	SN: 7349	31-Dec-18 (No. EX3-7349_Dec18)	Dec-19
DAE4	SN: 601	04-Oct-18 (No. DAE4-601_Oct18)	Oct-19

Secondary Standards	ID #	Check Date (in house)	Scheduled Check
Power meter E4419B	SN: GB39512475	07-Oct-15 (in house check Feb-19)	In house check: Oct-20
Power sensor HP 8481A	SN: US37292783	07-Oct-15 (in house check Oct-18)	In house check: Oct-20
Power sensor HP 8481A	SN: MY41092317	07-Oct-15 (in house check Oct-18)	In house check: Oct-20
RF generator R&S SMT-06	SN: 100972	15-Jun-15 (in house check Oct-18)	In house check: Oct-20
Network Analyzer Agilent E8358A	SN: US41080477	31-Mar-14 (in house check Oct-18)	In house check: Oct-19

	Name	Function	Signature
Calibrated by:	Manu Seitz	Laboratory Technician	
Approved by:	Katja Pokovic	Technical Manager	

Issued: March 21, 2019

This calibration certificate shall not be reproduced except in full without written approval of the laboratory.



Accredited by the Swiss Accreditation Service (SAS)

The Swiss Accreditation Service is one of the signatories to the EA
Multilateral Agreement for the recognition of calibration certificates

Accreditation No.: **SCS 0108**

Glossary:

TSL	tissue simulating liquid
ConvF	sensitivity in TSL / NORM x,y,z
N/A	not applicable or not measured

Calibration is Performed According to the Following Standards:

- IEEE Std 1528-2013, "IEEE Recommended Practice for Determining the Peak Spatial-Averaged Specific Absorption Rate (SAR) in the Human Head from Wireless Communications Devices: Measurement Techniques", June 2013
- IEC 62209-1, "Measurement procedure for the assessment of Specific Absorption Rate (SAR) from hand-held and body-mounted devices used next to the ear (frequency range of 300 MHz to 6 GHz)", July 2016
- IEC 62209-2, "Procedure to determine the Specific Absorption Rate (SAR) for wireless communication devices used in close proximity to the human body (frequency range of 30 MHz to 6 GHz)", March 2010
- KDB 865664, "SAR Measurement Requirements for 100 MHz to 6 GHz"

Additional Documentation:

- DASY4/5 System Handbook

Methods Applied and Interpretation of Parameters:

- Measurement Conditions:** Further details are available from the Validation Report at the end of the certificate. All figures stated in the certificate are valid at the frequency indicated.
- Antenna Parameters with TSL:** The dipole is mounted with the spacer to position its feed point exactly below the center marking of the flat phantom section, with the arms oriented parallel to the body axis.
- Feed Point Impedance and Return Loss:** These parameters are measured with the dipole positioned under the liquid filled phantom. The impedance stated is transformed from the measurement at the SMA connector to the feed point. The Return Loss ensures low reflected power. No uncertainty required.
- Electrical Delay:** One-way delay between the SMA connector and the antenna feed point. No uncertainty required.
- SAR measured:** SAR measured at the stated antenna input power.
- SAR normalized:** SAR as measured, normalized to an input power of 1 W at the antenna connector.
- SAR for nominal TSL parameters:** The measured TSL parameters are used to calculate the nominal SAR result.

The reported uncertainty of measurement is stated as the standard uncertainty of measurement multiplied by the coverage factor $k=2$, which for a normal distribution corresponds to a coverage probability of approximately 95%.

Measurement Conditions

DASY system configuration, as far as not given on page 1.

DASY Version	DASY5	V52.10.2
Extrapolation	Advanced Extrapolation	
Phantom	Modular Flat Phantom	
Distance Dipole Center - TSL	15 mm	with Spacer
Zoom Scan Resolution	dx, dy, dz = 5 mm	
Frequency	750 MHz \pm 1 MHz	

Head TSL parameters

The following parameters and calculations were applied.

	Temperature	Permittivity	Conductivity
Nominal Head TSL parameters	22.0 °C	41.9	0.89 mho/m
Measured Head TSL parameters	(22.0 \pm 0.2) °C	42.1 \pm 6 %	0.89 mho/m \pm 6 %
Head TSL temperature change during test	< 0.5 °C	----	----

SAR result with Head TSL

SAR averaged over 1 cm³ (1 g) of Head TSL	Condition	
SAR measured	250 mW input power	2.07 W/kg
SAR for nominal Head TSL parameters	normalized to 1W	8.29 W/kg \pm 17.0 % (k=2)

SAR averaged over 10 cm³ (10 g) of Head TSL	condition	
SAR measured	250 mW input power	1.36 W/kg
SAR for nominal Head TSL parameters	normalized to 1W	5.44 W/kg \pm 16.5 % (k=2)

Body TSL parameters

The following parameters and calculations were applied.

	Temperature	Permittivity	Conductivity
Nominal Body TSL parameters	22.0 °C	55.5	0.96 mho/m
Measured Body TSL parameters	(22.0 \pm 0.2) °C	54.5 \pm 6 %	0.98 mho/m \pm 6 %
Body TSL temperature change during test	< 0.5 °C	----	----

SAR result with Body TSL

SAR averaged over 1 cm³ (1 g) of Body TSL	Condition	
SAR measured	250 mW input power	2.16 W/kg
SAR for nominal Body TSL parameters	normalized to 1W	8.47 W/kg \pm 17.0 % (k=2)

SAR averaged over 10 cm³ (10 g) of Body TSL	condition	
SAR measured	250 mW input power	1.42 W/kg
SAR for nominal Body TSL parameters	normalized to 1W	5.59 W/kg \pm 16.5 % (k=2)

Appendix (Additional assessments outside the scope of SCS 0108)

Antenna Parameters with Head TSL

Impedance, transformed to feed point	55.6 Ω + 3.2 j Ω
Return Loss	- 24.3 dB

Antenna Parameters with Body TSL

Impedance, transformed to feed point	51.3 Ω - 0.7 j Ω
Return Loss	- 36.9 dB

General Antenna Parameters and Design

Electrical Delay (one direction)	1.035 ns
----------------------------------	----------

After long term use with 100W radiated power, only a slight warming of the dipole near the feedpoint can be measured.

The dipole is made of standard semirigid coaxial cable. The center conductor of the feeding line is directly connected to the second arm of the dipole. The antenna is therefore short-circuited for DC-signals. On some of the dipoles, small end caps are added to the dipole arms in order to improve matching when loaded according to the position as explained in the "Measurement Conditions" paragraph. The SAR data are not affected by this change. The overall dipole length is still according to the Standard.

No excessive force must be applied to the dipole arms, because they might bend or the soldered connections near the feedpoint may be damaged.

Additional EUT Data

Manufactured by	SPEAG
-----------------	-------

DASY5 Validation Report for Head TSL

Date: 21.03.2019

Test Laboratory: SPEAG, Zurich, Switzerland

DUT: Dipole 750 MHz; Type: D750V3; Serial: D750V3 - SN:1019

Communication System: UID 0 - CW; Frequency: 750 MHz

Medium parameters used: $f = 750 \text{ MHz}$; $\sigma = 0.89 \text{ S/m}$; $\epsilon_r = 42.1$; $\rho = 1000 \text{ kg/m}^3$

Phantom section: Flat Section

Measurement Standard: DASY5 (IEEE/IEC/ANSI C63.19-2011)

DASY52 Configuration:

- Probe: EX3DV4 - SN7349; ConvF(10.32, 10.32, 10.32) @ 750 MHz; Calibrated: 31.12.2018
- Sensor-Surface: 1.4mm (Mechanical Surface Detection)
- Electronics: DAE4 Sn601; Calibrated: 04.10.2018
- Phantom: Flat Phantom 4.9 (front); Type: QD 00L P49 AA; Serial: 1001
- DASY52 52.10.2(1495); SEMCAD X 14.6.12(7450)

Dipole Calibration for Head Tissue/Pin=250 mW, d=15mm/Zoom Scan (7x7x7)/Cube 0:

Measurement grid: $dx=5\text{mm}$, $dy=5\text{mm}$, $dz=5\text{mm}$

Reference Value = 59.02 V/m; Power Drift = -0.00 dB

Peak SAR (extrapolated) = 3.09 W/kg

SAR(1 g) = 2.07 W/kg; SAR(10 g) = 1.36 W/kg

Maximum value of SAR (measured) = 2.76 W/kg

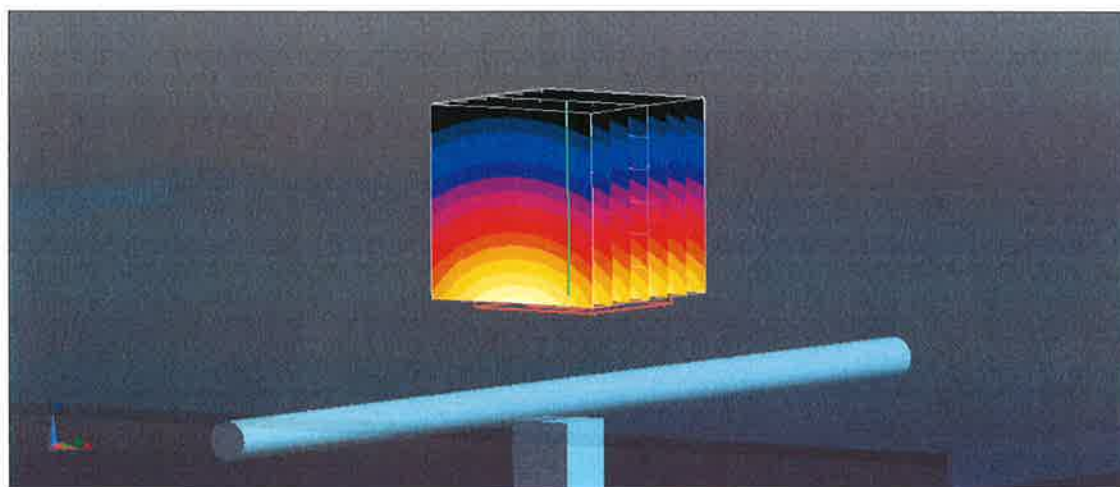
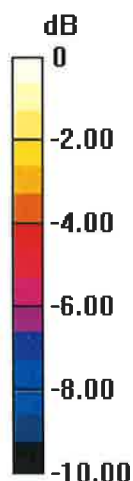

0 dB = 2.76 W/kg = 4.41 dBW/kg

Impedance Measurement Plot for Head TSL

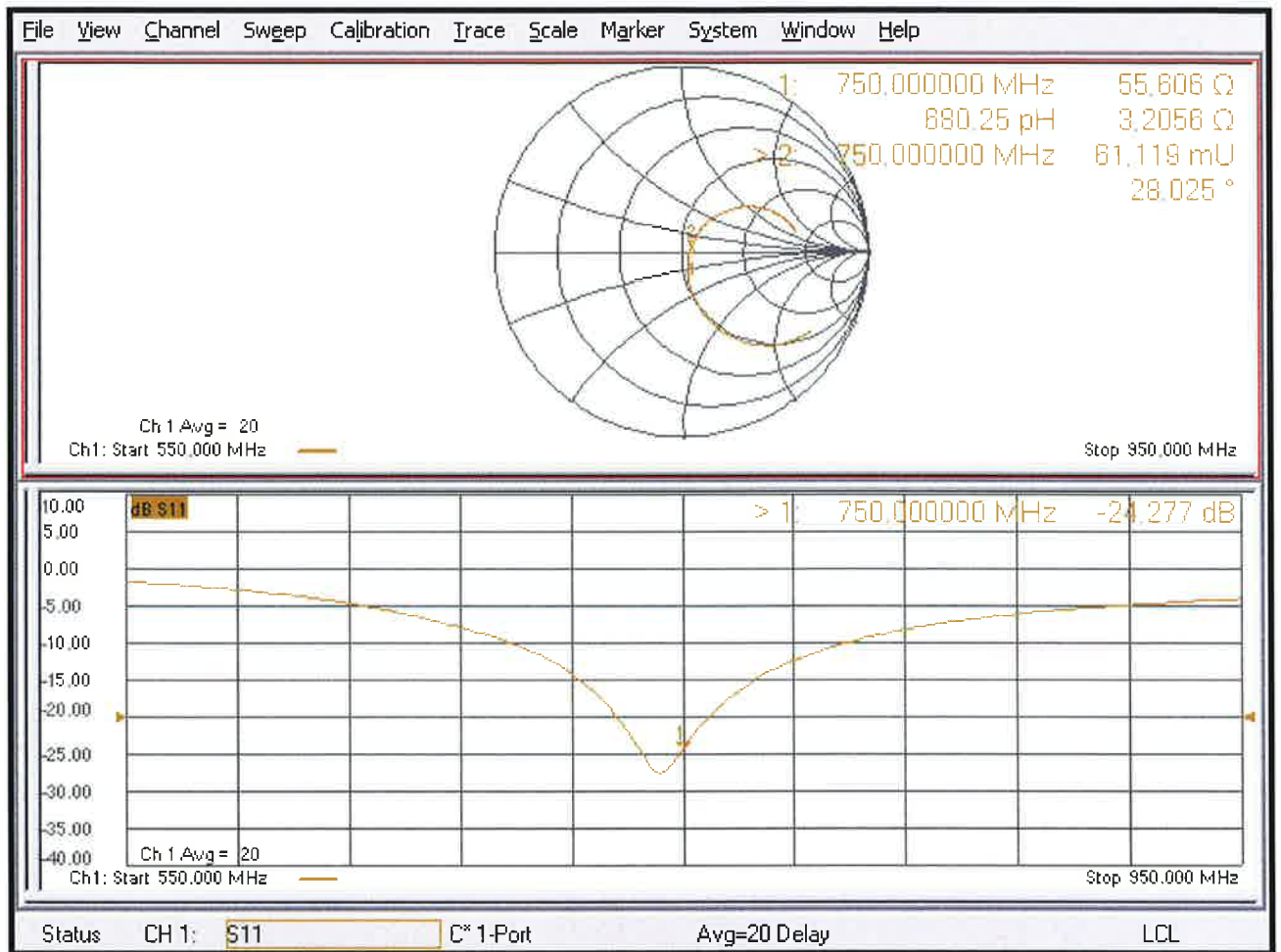

Test Laboratory: SPEAG, Zurich, Switzerland

DUT: Dipole 750 MHz; Type: D750V3; Serial: D750V3 - SN:1019

Communication System: UID 0 - CW; Frequency: 750 MHz

Medium parameters used: $f = 750 \text{ MHz}$; $\sigma = 0.98 \text{ S/m}$; $\epsilon_r = 54.5$; $\rho = 1000 \text{ kg/m}^3$

Phantom section: Flat Section

Measurement Standard: DASY5 (IEEE/IEC/ANSI C63.19-2011)

DASY52 Configuration:

- Probe: EX3DV4 - SN7349; ConvF(10.29, 10.29, 10.29) @ 750 MHz; Calibrated: 31.12.2018
- Sensor-Surface: 1.4mm (Mechanical Surface Detection)
- Electronics: DAE4 Sn601; Calibrated: 04.10.2018
- Phantom: Flat Phantom 4.9 (Back); Type: QD 00R P49 AA; Serial: 1005
- DASY52 52.10.2(1495); SEMCAD X 14.6.12(7450)

Dipole Calibration for Body Tissue/Pin=250 mW, d=15mm/Zoom Scan (7x7x7)/Cube 0:

Measurement grid: dx=5mm, dy=5mm, dz=5mm

Reference Value = 57.19 V/m; Power Drift = -0.01 dB

Peak SAR (extrapolated) = 3.17 W/kg

SAR(1 g) = 2.16 W/kg; SAR(10 g) = 1.42 W/kg

Maximum value of SAR (measured) = 2.85 W/kg

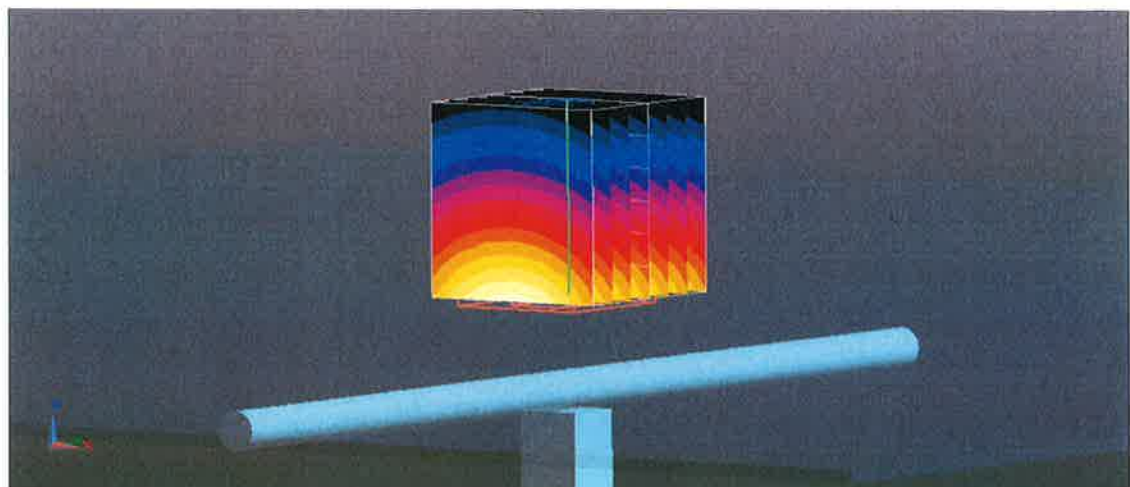
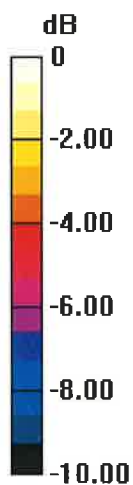

0 dB = 2.85 W/kg = 4.55 dBW/kg

Impedance Measurement Plot for Body TSL

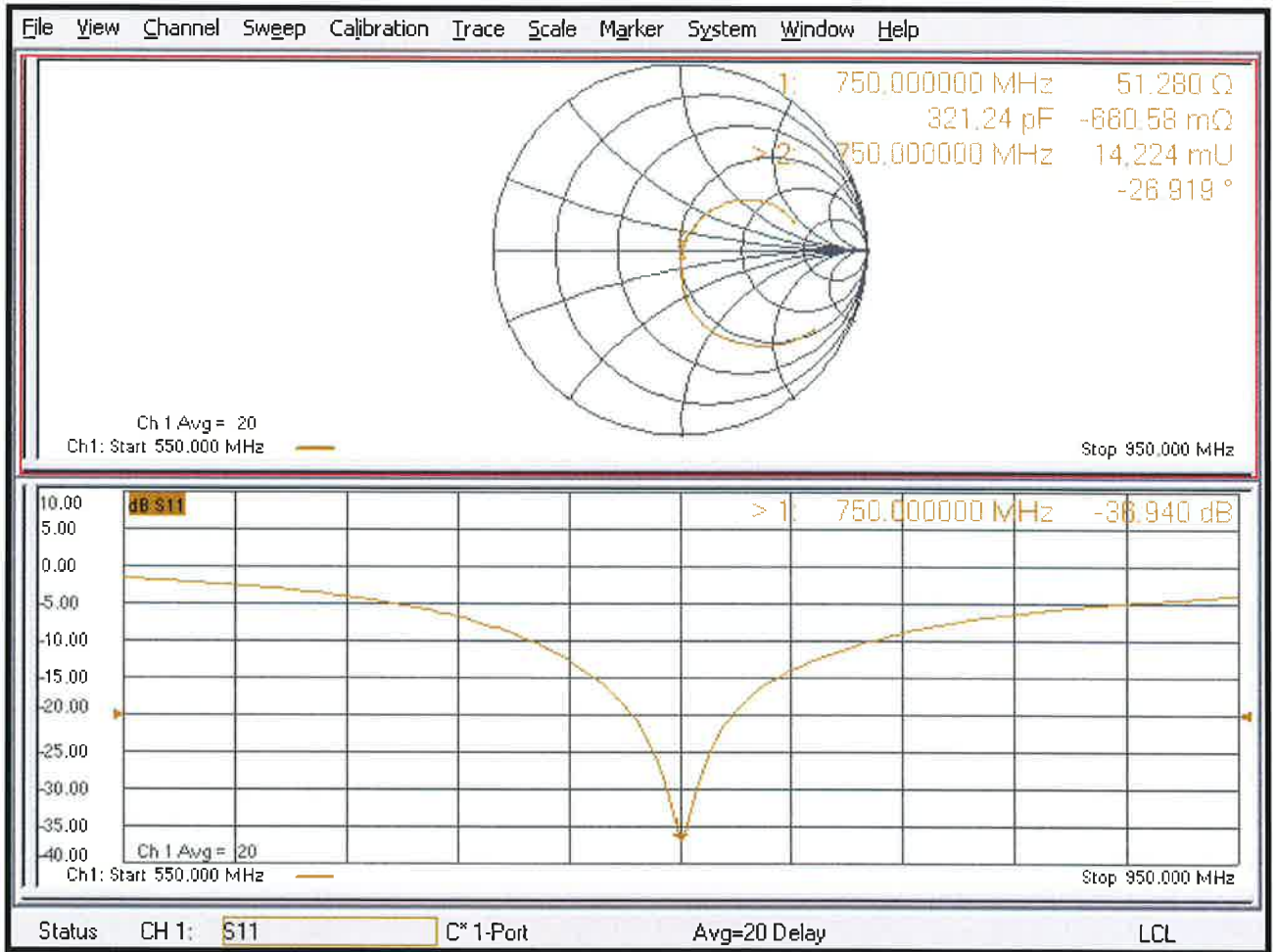

CERTIFICATE OF CALIBRATION

ISSUED BY **UL VS LTD**

DATE OF ISSUE: 28/Nov/2018 CERTIFICATE NUMBER : 12134289JD01A



5248

UL VS LTD
UNIT 1 HORIZON
KINGSLAND PARK, WADE ROAD
BASINGSTOKE, HAMPSHIRE
RG24 8AH, UK
TEL: +44 (0) 1256 312000
FAX: +44 (0) 1256 312001
Email: LST.UK.Calibration@ul.com



Page 1 of 10

APPROVED SIGNATORY

.....
Naseer Mirza

Customer :

UL VS Inc
47173 Benicia Street
Fremont, CA 94538, USA

Equipment Details:

Description:	Dipole Validation Kit	Date of Receipt:	20/Nov/2017
Manufacturer:	Speag		
Type/Model Number:	D750V3		
Serial Number:	1071		
Calibration Date:	28/Nov/2018		
Calibrated By:	Chanthu Thevarajah Senior Engineer		

Signature:

.....

All Calibration have been conducted in the closed laboratory facility: Lab Temperature (22±3) °C and humidity < 70%

This certificate is issued in accordance with the laboratory accreditation requirements of the United Kingdom Accreditation Service. It provides traceability of measurement to the SI system of units and/or to units of measurement realised at the National Physical Laboratory or other recognised national metrology institutes. This certificate may not be reproduced other than in full, except with the prior written approval of the issuing laboratory.

Use of the UKAS mark demonstrates that compliance with the requirements of BS/EN/ISO/IEC 17025 has been independently assessed.

CERTIFICATE OF CALIBRATION

ISSUED BY UL VS LTD

UKAS Accredited Calibration Laboratory No. 5248

CERTIFICATE
NUMBER :
12134289JD01A

Page 2 of 10

The calibration methods and procedures used were as detailed in:

1. **IEC 62209-1:2016:** Procedure to determine the specific absorption rate (SAR) for hand-held devices used in close proximity to the ear (frequency range of 300 MHz to 3 GHz)
2. **IEC 62209-2:2010:** Procedure to determine the specific absorption rate (SAR) for wireless communication devices used in close proximity to the human body (frequency range of 30 MHz to 6 GHz)
3. **IEEE 1528: 2013:** IEEE Recommended Practice for Determining the Peak Spatial-Average Specific Absorption Rate (SAR) in the Human Head from Wireless Communication Devices: Measurement Techniques
4. FCC KDB Publication Number: “**KDB865664 D01 SAR Measurement 100 MHz to 6 GHz**”
5. **SPEAG DASY4/ DASY5 System Handbook**

The measuring equipment used to perform the calibration, documented in this certificate has been calibrated in accordance with the manufacturers' recommendations, and is traceable to recognized national standards.

UL No.	Instrument	Manufacturer	Type No.	Serial No.	Date Last Calibrated	Cal. Interval (Months)
PRE0178318	Data Acquisition Electronics	SPEAG	DAE4	1543	08 Mar 2018	12
PRE0178315	Probe	SPEAG	ES3DV3	3360	17 Aug 2018	12
A1985	Dipole	SPEAG	D750V3	1011	07 Feb 2018	12
PRE0151451	Power Monitoring Kit	Art-Fi	ART 100850-01	0001	Cal as part of System	12
PRE0151441	Power Sensor	Rhode & Schwarz	NRP8S	102481	05 Feb 2018	12
PRE0151154	Network Analyser	Rhode & Schwarz	ZND8	100151	14 Dec 2017	12
PRE0151877	Calibration Kit	Rhode & Schwarz	ZV-Z135	102947-Bt	27 Apr 2018	12
PRE0178154	Signal Generator	Rhode & Schwarz	SMB 100A	175325	09 Apr 2018	12

CERTIFICATE OF CALIBRATION

ISSUED BY **UL VS LTD**

UKAS Accredited Calibration Laboratory No. 5248

CERTIFICATE
NUMBER :
12134289JD01A

Page 3 of 10

SAR System Specification

Robot System Positioner:	Stäubli Unimation Corp. Robot Model: TX60L
Robot Serial Number:	F17/5ENYG1/A/01
DASY Version:	DASY 52 (v52.8.8.1258)
Phantom:	Flat section of SAM Twin Phantom
Distance Dipole Centre:	15 mm (with spacer)
Frequency:	750 MHz

Dielectric Property Measurements – Head Simulating Liquid (HSL)

Simulant Liquid	Frequency (MHz)	Room Temp		Liquid Temp		Parameters	Target Value	Measured Value	Uncertainty (%)
		Start	End	Start	End				
Head	750	20.0 °C	20.5 °C	20.5°C	20.5°C	ϵ_r	41.96	41.83	± 5%
						σ	0.89	0.90	± 5%

SAR Results – Head Simulating Liquid (HSL)

Simulant Liquid	SAR Measured	250 mW input Power	Normalised to 1.00 W	Uncertainty (%)
Head	SAR averaged over 1g	2.09 W/Kg	8.32 W/Kg	± 17.57%
	SAR averaged over 10g	1.37 W/Kg	5.45 W/Kg	± 17.32%

Antenna Parameters – Head Simulating Liquid (HSL)

Simulant Liquid	Parameter	Measured Level	Uncertainty (%)
Head	Impedance	47.158 Ω 3.05 j Ω	± 0.28 Ω ± 0.044 j Ω
	Return Loss	-26.81	± 2.03 dB

CERTIFICATE OF CALIBRATION

ISSUED BY **UL VS LTD**

UKAS Accredited Calibration Laboratory No. 5248

CERTIFICATE
NUMBER :
12134289JD01A

Page 4 of 10

Dielectric Property Measurements – Body Simulating Liquid (MSL)

Simulant Liquid	Frequency (MHz)	Room Temp		Liquid Temp		Parameters	Target Value	Measured Value	Uncertainty (%)
		Start	End	Start	End				
Body	750	20.0 °C	20.0 °C	19.3°C	20.0°C	εr	55.55	54.19	± 5%
						σ	0.96	0.96	± 5%

SAR Results – Body Simulating Liquid (MSL)

Simulant Liquid	SAR Measured	250 mW input Power	Normalised to 1.00 W	Uncertainty (%)
Body	SAR averaged over 1g	2.17 W/Kg	8.63 W/Kg	± 18.06%
	SAR averaged over 10g	1.42 W/Kg	5.65 W/Kg	± 17.44%

Antenna Parameters – Body Simulating Liquid (MSL)

Simulant Liquid	Parameter	Measured Level	Uncertainty (%)
Body	Impedance	52.66 Ω 4.35 jΩ	± 0.28 Ω ± 0.044 jΩ
	Return Loss	-26.59	± 2.03 dB

CERTIFICATE OF CALIBRATION

ISSUED BY UL VS LTD

CERTIFICATE
NUMBER :
12134289JD01A

UKAS Accredited Calibration Laboratory No. 5248

Page 5 of 10

DASY Validation Scan for Head Stimulating Liquid (HSL)

DUT: D750V3 - SN1071; Type: D750V3; Serial: SN1071

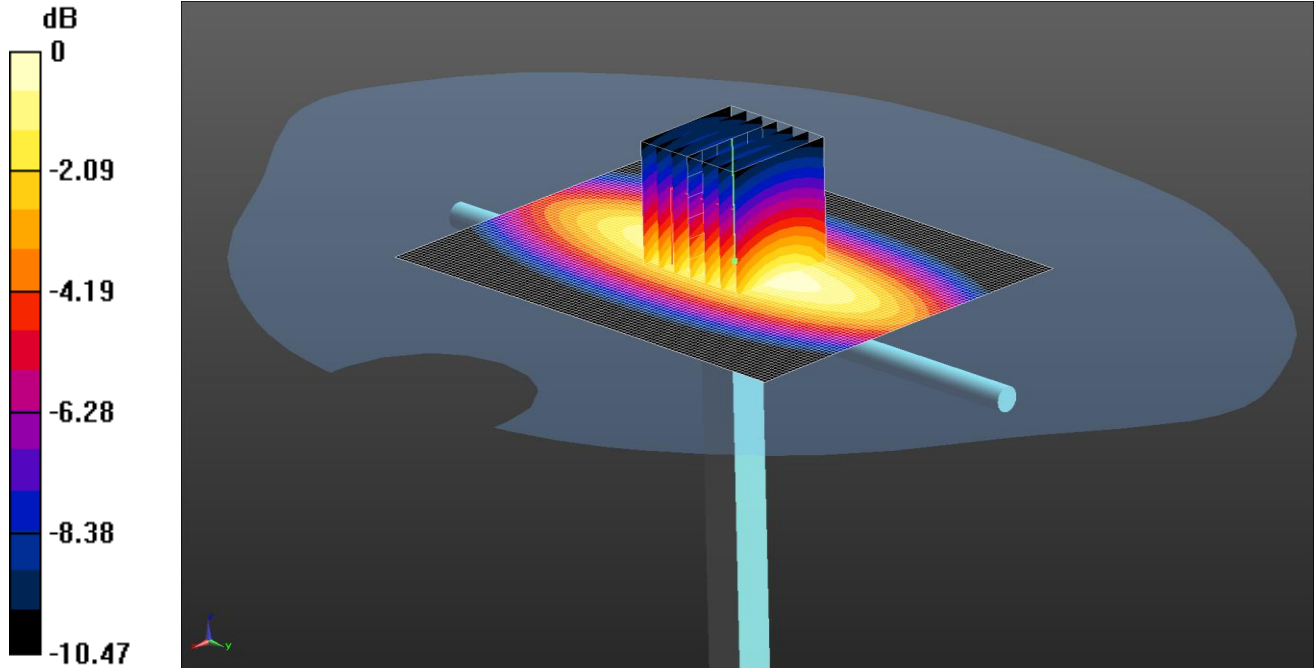

0 dB = 2.45 W/kg = 3.89 dBW/kg

Communication System: UID 0, CW (0); Frequency: 750 MHz; Duty Cycle: 1:1

Medium: 750 835 900 1800 1900 MHz HSL Medium parameters used: $f = 750$ MHz; $\sigma = 0.899$ S/m; $\epsilon_r = 41.829$; $\rho = 1000$ kg/m³

Phantom section: Flat Section

DASY4 Configuration:

- Probe: ES3DV3 - SN3360; ConvF(6.48, 6.48, 6.48); Calibrated: 17/08/2018;

- Sensor-Surface: 3mm (Mechanical Surface Detection)

- Electronics: DAE4 Sn1543; Calibrated: 08/03/2018

- Phantom: Twin SAM A (Site 65); Type: SAM 8.0; Serial: TP:1945

- ; SEMCAD X Version 14.6.10 (7417)

Configuration/d=10mm, Pin=250mW 2/Area Scan (81x101x1): Interpolated grid: dx=1.200 mm, dy=1.200 mm

Maximum value of SAR (interpolated) = 2.45 W/kg

Configuration/d=10mm, Pin=250mW 2/Zoom Scan 2 (7x7x7)/Cube 0: Measurement grid: dx=5mm, dy=5mm, dz=5mm

Reference Value = 53.77 V/m; Power Drift = -0.03 dB

Peak SAR (extrapolated) = 3.13 W/kg

SAR(1 g) = 2.09 W/kg; SAR(10 g) = 1.37 W/kg

Maximum value of SAR (measured) = 2.45 W/kg

CERTIFICATE OF CALIBRATION

ISSUED BY UL VS LTD

CERTIFICATE
NUMBER :
12134289JD01A

UKAS Accredited Calibration Laboratory No. 5248

Page 6 of 10

Impedance Measurement Plot for Head Stimulating Liquid (HSL)

11/23/2018 12:00:16 PM
1328.5170K92-100151-MV

Trc1 — S11 Smith 200 mU/ Ref 1 U Cal Smo

1

• M1 750.000000 MHz 47.158 Ω
j3.048 Ω
646.882 pF

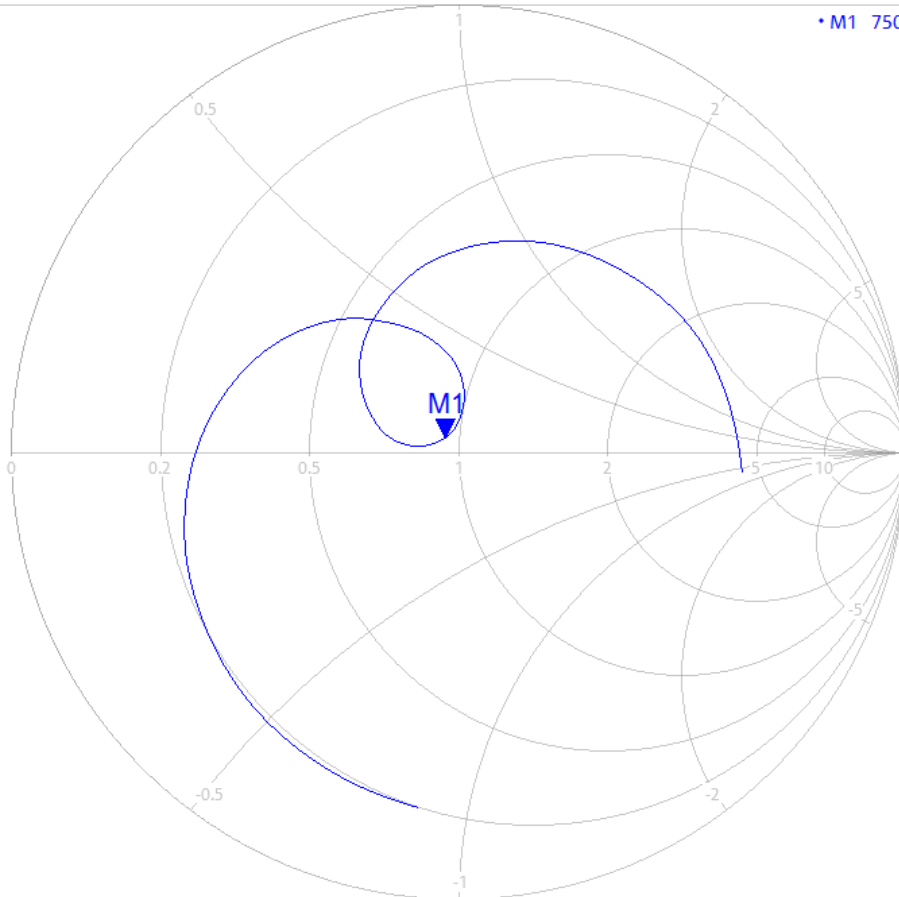

Ch1 Center 750 MHz

Pwr -10 dBm Bw 10 kHz

Span 400 MHz

CERTIFICATE OF CALIBRATION ISSUED BY UL VS LTD

UKAS Accredited Calibration Laboratory No. 5248

CERTIFICATE
NUMBER :
12134289JD01A

Page 7 of 10

Return Loss Measurement Plot for Head Stimulating Liquid (HSL)

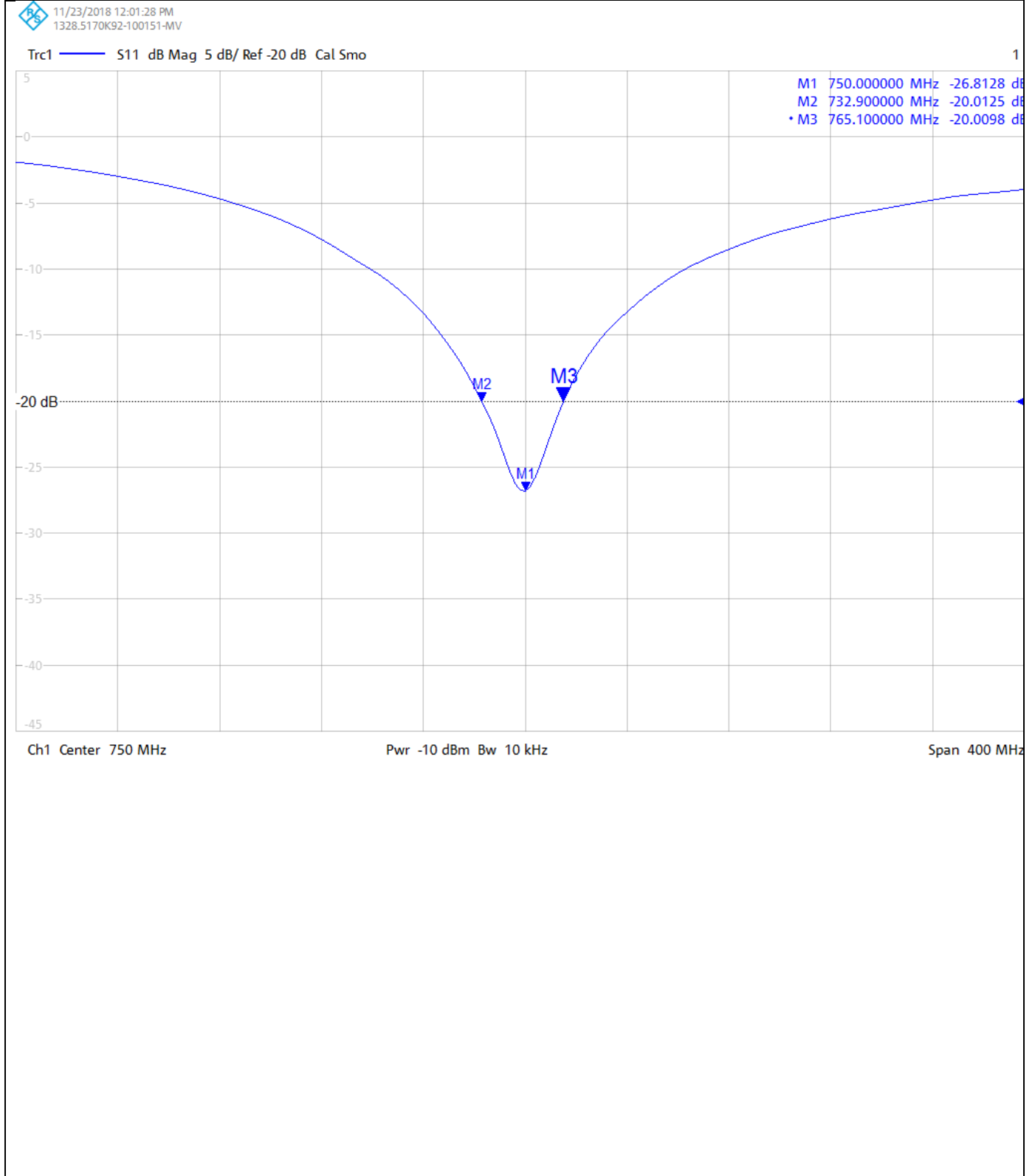

CERTIFICATE OF CALIBRATION

ISSUED BY UL VS LTD

CERTIFICATE
NUMBER :
12134289JD01A

UKAS Accredited Calibration Laboratory No. 5248

Page 8 of 10

DASY Validation Scan for Body Stimulating Liquid (MSL)

DUT: D750V3 - SN1071; Type: D750V3; Serial: SN1071

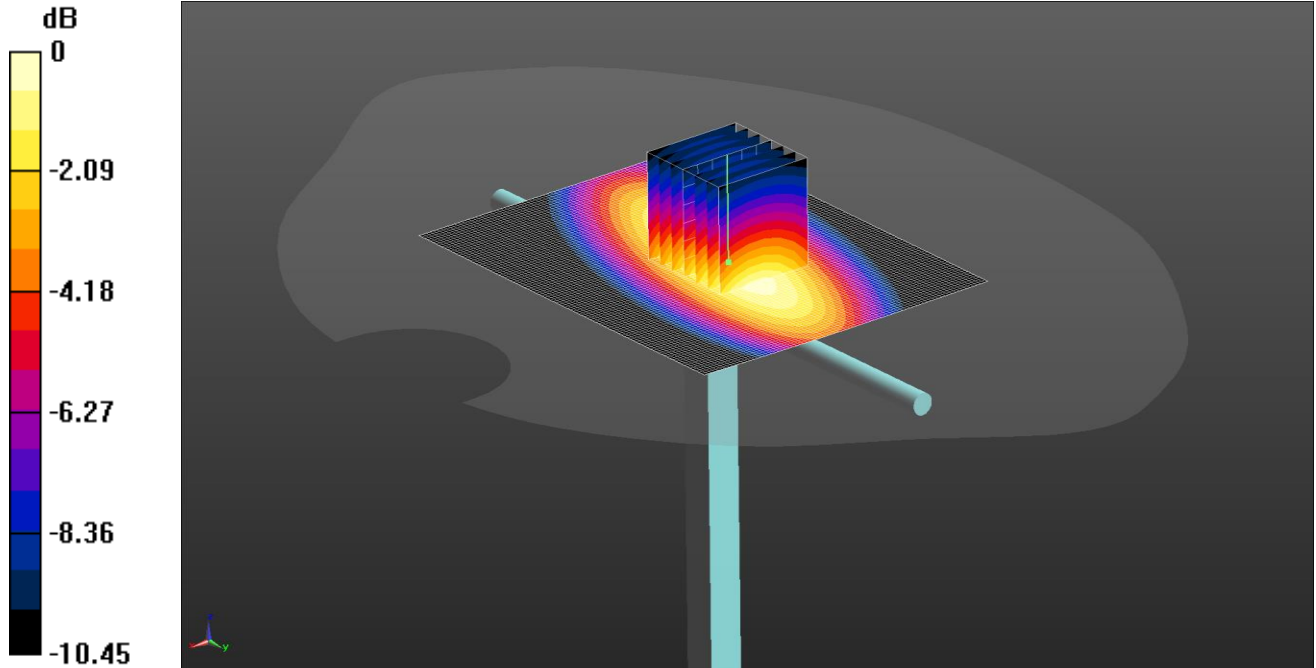

0 dB = 2.54 W/kg = 4.05 dBW/kg

Communication System: UID 0, CW (0); Frequency: 750 MHz; Duty Cycle: 1:1

Medium: 750 835 900 1800 MHz MSL Medium parameters used: $f = 750$ MHz; $\sigma = 0.959$ S/m; $\epsilon_r = 54.189$; $\rho = 1000$ kg/m³

Phantom section: Flat Section

DASY4 Configuration:

- Probe: ES3DV3 - SN3360; ConvF(6.55, 6.55, 6.55); Calibrated: 17/08/2018;

- Sensor-Surface: 3mm (Mechanical Surface Detection)

- Electronics: DAE4 Sn1543; Calibrated: 08/03/2018

- Phantom: Twin SAM B (Site 65); Type: SAM 5.0; Serial: TP:1836

- ; SEMCAD X Version 14.6.10 (7417)

Configuration/d=10mm, Pin=250mW 2/Area Scan (81x101x1): Interpolated grid: dx=1.200 mm, dy=1.200 mm

Maximum value of SAR (interpolated) = 2.53 W/kg

Configuration/d=10mm, Pin=250mW 2/Zoom Scan 2 (7x7x7)/Cube 0: Measurement grid: dx=5mm, dy=5mm, dz=5mm

Reference Value = 51.97 V/m; Power Drift = 0.06 dB

Peak SAR (extrapolated) = 3.28 W/kg

SAR(1 g) = 2.17 W/kg; SAR(10 g) = 1.42 W/kg

Maximum value of SAR (measured) = 2.54 W/kg

CERTIFICATE OF CALIBRATION

ISSUED BY UL VS LTD

CERTIFICATE
NUMBER :
12134289JD01A

UKAS Accredited Calibration Laboratory No. 5248

Page 9 of 10

Impedance Measurement Plot for Body Stimulating Liquid (MSL)

11/23/2018 3:34:36 PM
1328.5170K92-100151-MV

Trc1 — S11 Smith 200 mU/ Ref 1 U Cal Smo

1

• M1 750.000000 MHz 52.661 Ω
j4.355 Ω
924.067 pF

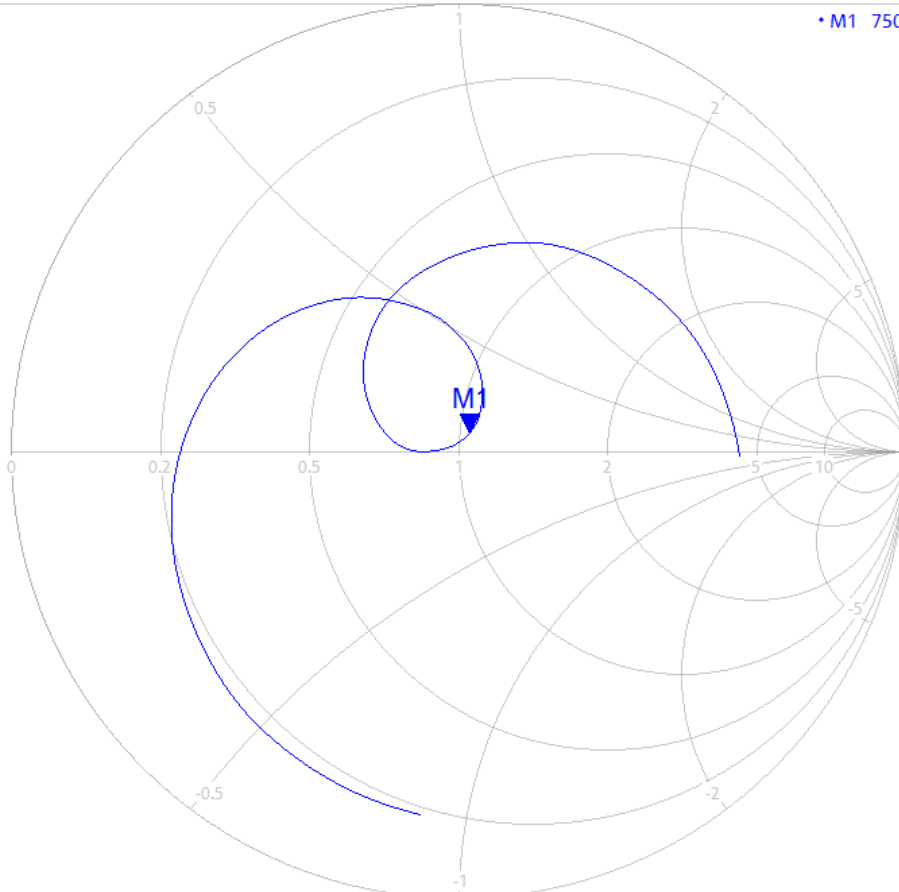

Ch1 Center 750 MHz

Pwr -10 dBm Bw 10 kHz

Span 400 MHz

CERTIFICATE OF CALIBRATION

ISSUED BY UL VS LTD

UKAS Accredited Calibration Laboratory No. 5248

CERTIFICATE
NUMBER :
12134289JD01A

Page 10 of 10

Return Loss Measurement Plot for Body Stimulating Liquid (MSL)

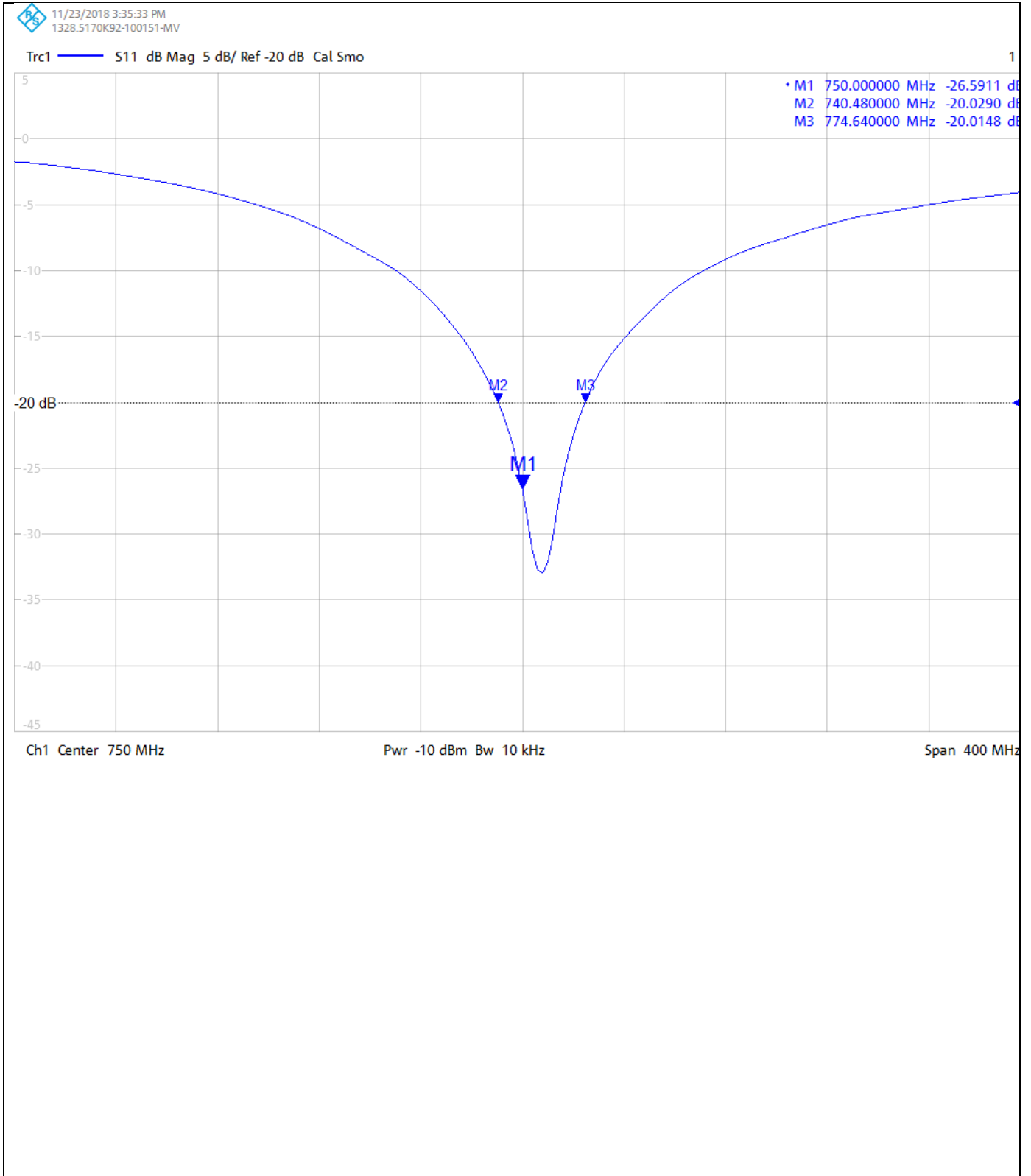

Calibration Certificate Label:

 <p>UKAS CALIBRATION 5248</p>	<p>UL VS LTD - Tel: +44 (0) 1256312000</p> <p>Certificate Number: 12134289JD01A</p> <p>Instrument ID: 1071</p> <p>Calibration Date: 28/Nov/2018</p> <p>Calibration Due Date:</p>
--	---

 <p>UKAS CALIBRATION 5248</p>	<p>UL VS LTD - Tel: +44 (0) 1256312000</p> <p>Certificate Number: 12134289JD01A</p> <p>Instrument ID: 1071</p> <p>Calibration Date: 28/Nov/2018</p> <p>Calibration Due Date:</p>
--	---

 <p>UKAS CALIBRATION 5248</p>	<p>UL VS LTD - Tel: +44 (0) 1256312000</p> <p>Certificate Number: 12134289JD01A</p> <p>Instrument ID: 1071</p> <p>Calibration Date: 28/Nov/2018</p> <p>Calibration Due Date:</p>
--	---

CERTIFICATE OF CALIBRATION

ISSUED BY **UL VS LTD**

DATE OF ISSUE: 28/Nov/2018 CERTIFICATE NUMBER : 12134289JD01B



5248

UL VS LTD
UNIT 1 HORIZON
KINGSLAND PARK, WADE ROAD
BASINGSTOKE, HAMPSHIRE
RG24 8AH, UK
TEL: +44 (0) 1256 312000
FAX: +44 (0) 1256 312001
Email: LST.UK.Calibration@ul.com



Page 1 of 10

APPROVED SIGNATORY

.....
Naseer Mirza

Customer :

UL VS Inc
47173 Benicia Street
Fremont, CA 94538, USA

Equipment Details:

Description:	Dipole Validation Kit	Date of Receipt:	20/Nov/2017
Manufacturer:	Speag		
Type/Model Number:	D835V2		
Serial Number:	4d002		
Calibration Date:	28/Nov/2018		
Calibrated By:	Chanthu Thevarajah Senior Engineer		

Signature:

.....

All Calibration have been conducted in the closed laboratory facility: Lab Temperature (22±3) °C and humidity < 70%

This certificate is issued in accordance with the laboratory accreditation requirements of the United Kingdom Accreditation Service. It provides traceability of measurement to the SI system of units and/or to units of measurement 1ecogniz at the National Physical Laboratory or other 1ecognized national metrology institutes. This certificate may not be reproduced other than in full, except with the prior written approval of the issuing laboratory.

Use of the UKAS mark demonstrates that compliance with the requirements of BS/EN/ISO/IEC 17025 has been independently assessed.

CERTIFICATE OF CALIBRATION

ISSUED BY UL VS LTD

UKAS Accredited Calibration Laboratory No. 5248

CERTIFICATE
NUMBER :
12134289JD01B

Page 2 of 10

The calibration methods and procedures used were as detailed in:

1. **IEC 62209-1:2016:** Procedure to determine the specific absorption rate (SAR) for hand-held devices used in close proximity to the ear (frequency range of 300 MHz to 3 GHz)
2. **IEC 62209-2:2010:** Procedure to determine the specific absorption rate (SAR) for wireless communication devices used in close proximity to the human body (frequency range of 30 MHz to 6 GHz)
3. **IEEE 1528: 2013:** IEEE Recommended Practice for Determining the Peak Spatial-Average Specific Absorption Rate (SAR) in the Human Head from Wireless Communication Devices: Measurement Techniques
4. FCC KDB Publication Number: **“KDB865664 D01 SAR Measurement 100 MHz to 6 GHz”**
5. **SPEAG DASY4/ DASY5 System Handbook**

The measuring equipment used to perform the calibration, documented in this certificate has been calibrated in accordance with the manufacturers' recommendations, and is traceable to recognized national standards.

UL No.	Instrument	Manufacturer	Type No.	Serial No.	Date Last Calibrated	Cal. Interval (Months)
PRE0178318	Data Acquisition Electronics	SPEAG	DAE4	1543	08 Mar 2018	12
PRE0178315	Probe	SPEAG	ES3DV3	3360	17 Aug 2018	12
A2588	Dipole	SPEAG	D900V2	1d168	18 Sep 2018	12
PRE0151451	Power Monitoring Kit	Art-Fi	ART 100850-01	0001	Cal as part of System	12
PRE0151441	Power Sensor	Rhode & Schwarz	NRP8S	102481	05 Feb 2018	12
PRE0151154	Network Analyser	Rhode & Schwarz	ZND8	100151	14 Dec 2017	12
PRE0151877	Calibration Kit	Rhode & Schwarz	ZV-Z135	102947-Bt	27 Apr 2018	12
PRE0178154	Signal Generator	Rhode & Schwarz	SMB 100A	175325	09 Apr 2018	12

CERTIFICATE OF CALIBRATION

ISSUED BY **UL VS LTD**

UKAS Accredited Calibration Laboratory No. 5248

CERTIFICATE
NUMBER :
12134289JD01B

Page 3 of 10

SAR System Specification

Robot System Positioner:	Stäubli Unimation Corp. Robot Model: TX60L
Robot Serial Number:	F17/5ENYG1/A/01
DASY Version:	DASY 52 (v52.8.8.1258)
Phantom:	Flat section of SAM Twin Phantom
Distance Dipole Centre:	15 mm (with spacer)
Frequency:	835 MHz

Dielectric Property Measurements – Head Simulating Liquid (HSL)

Simulant Liquid	Frequency (MHz)	Room Temp		Liquid Temp		Parameters	Target Value	Measured Value	Uncertainty (%)
		Start	End	Start	End				
Head	835	20.0 °C	20.0 °C	20.5°C	20.0°C	ϵ_r	41.50	41.57	± 5%
						σ	0.90	0.93	± 5%

SAR Results – Head Simulating Liquid (HSL)

Simulant Liquid	SAR Measured	250 mW input Power	Normalised to 1.00 W	Uncertainty (%)
Head	SAR averaged over 1g	2.48 W/Kg	9.87 W/Kg	± 17.57%
	SAR averaged over 10g	1.60 W/Kg	6.36 W/Kg	± 17.32%

Antenna Parameters – Head Simulating Liquid (HSL)

Simulant Liquid	Parameter	Measured Level	Uncertainty (%)
Head	Impedance	47.85 Ω 0.47 j Ω	± 0.28 Ω ± 0.044 j Ω
	Return Loss	-31.95	± 2.03 dB

CERTIFICATE OF CALIBRATION

ISSUED BY UL VS LTD

UKAS Accredited Calibration Laboratory No. 5248

CERTIFICATE
NUMBER :
12134289JD01B

Page 4 of 10

Dielectric Property Measurements – Body Simulating Liquid (MSL)

Simulant Liquid	Frequency (MHz)	Room Temp		Liquid Temp		Parameters	Target Value	Measured Value	Uncertainty (%)
		Start	End	Start	End				
Body	835	20.0 °C	20.0 °C	19.3°C	20.0°C	ϵ_r	55.20	54.10	± 5%
						σ	0.97	0.99	± 5%

SAR Results – Body Simulating Liquid (MSL)

Simulant Liquid	SAR Measured	250 mW input Power	Normalised to 1.00 W	Uncertainty (%)
Body	SAR averaged over 1g	2.53 W/Kg	10.07 W/Kg	± 18.06%
	SAR averaged over 10g	1.65 W/Kg	6.56 W/Kg	± 17.44%

Antenna Parameters – Body Simulating Liquid (MSL)

Simulant Liquid	Parameter	Measured Level	Uncertainty (%)
Body	Impedance	46.49 Ω 5.59 j Ω	± 0.28 Ω ± 0.044 j Ω
	Return Loss	-23.73	± 2.03 dB

CERTIFICATE OF CALIBRATION

ISSUED BY UL VS LTD

CERTIFICATE
NUMBER :
12134289JD01B

UKAS Accredited Calibration Laboratory No. 5248

Page 5 of 10

DASY Validation Scan for Head Stimulating Liquid (HSL)

DUT: D835V2 - SN4d002; Type: D835V2; Serial: SN4d002

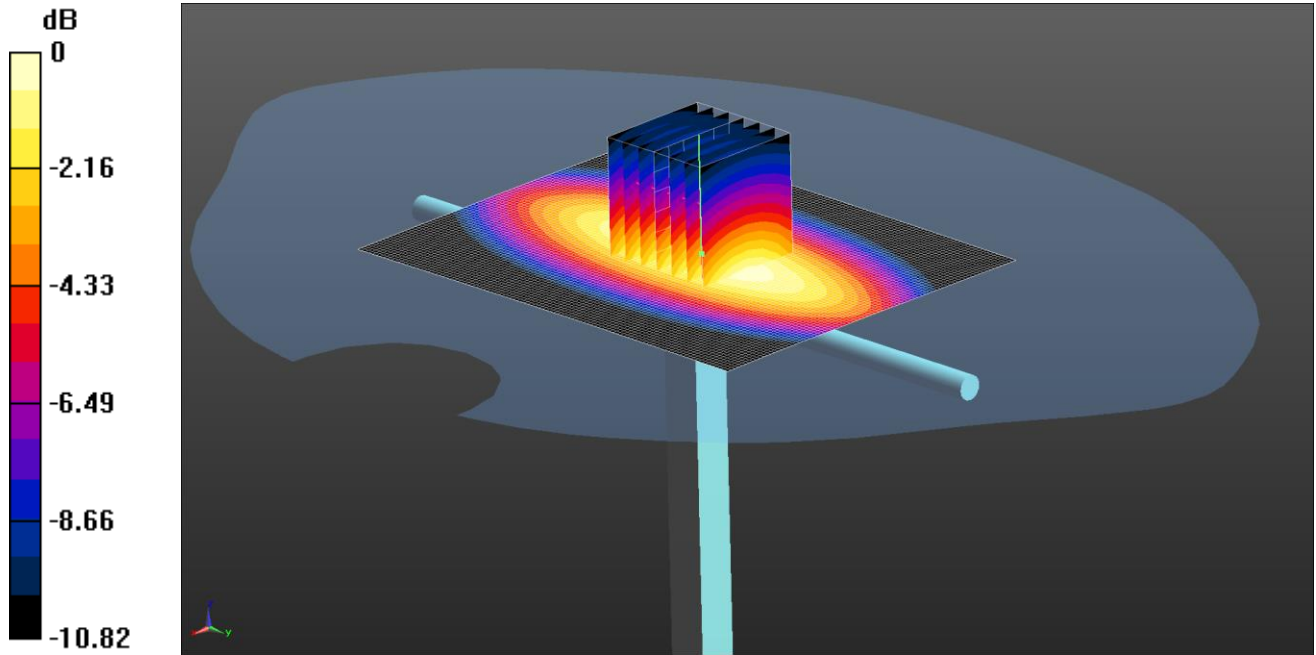

0 dB = 2.91 W/kg = 4.64 dBW/kg

Communication System: UID 0, CW (0); Frequency: 835 MHz; Duty Cycle: 1:1
Medium: 750 835 900 1800 1900 MHz HSL Medium parameters used (interpolated): $f = 835$ MHz; $\sigma = 0.931$ S/m; $\epsilon_r = 41.573$;
 $\rho = 1000$ kg/m³

Phantom section: Flat Section

DASY4 Configuration:

- Probe: ES3DV3 - SN3360; ConvF(6.23, 6.23, 6.23); Calibrated: 17/08/2018;
- Sensor-Surface: 3mm (Mechanical Surface Detection)
- Electronics: DAE4 Sn1543; Calibrated: 08/03/2018
- Phantom: Twin SAM A (Site 65); Type: SAM 8.0; Serial: TP:1945
- ; SEMCAD X Version 14.6.10 (7417)

Configuration/d=10mm, Pin=250mW 2/Area Scan (81x101x1): Interpolated grid: dx=1.200 mm, dy=1.200 mm

Maximum value of SAR (interpolated) = 2.90 W/kg

Configuration/d=10mm, Pin=250mW 2/Zoom Scan 2 (7x7x7)/Cube 0: Measurement grid: dx=5mm, dy=5mm, dz=5mm

Reference Value = 57.40 V/m; Power Drift = -0.04 dB

Peak SAR (extrapolated) = 3.75 W/kg

SAR(1 g) = 2.48 W/kg; SAR(10 g) = 1.6 W/kg

Maximum value of SAR (measured) = 2.91 W/kg

CERTIFICATE OF CALIBRATION ISSUED BY UL VS LTD

CERTIFICATE
NUMBER :
12134289JD01B

UKAS Accredited Calibration Laboratory No. 5248

Page 6 of 10

Impedance Measurement Plot for Head Stimulating Liquid (HSL)

11/23/2018 10:38:03 AM
1328.5170K92-100151-MV

Trc1 — S11 Smith 200 mU/ Ref 1 U Cal

1

• M1 835.000000 MHz 47.850 Ω
j473.047 m Ω
90.165 pH

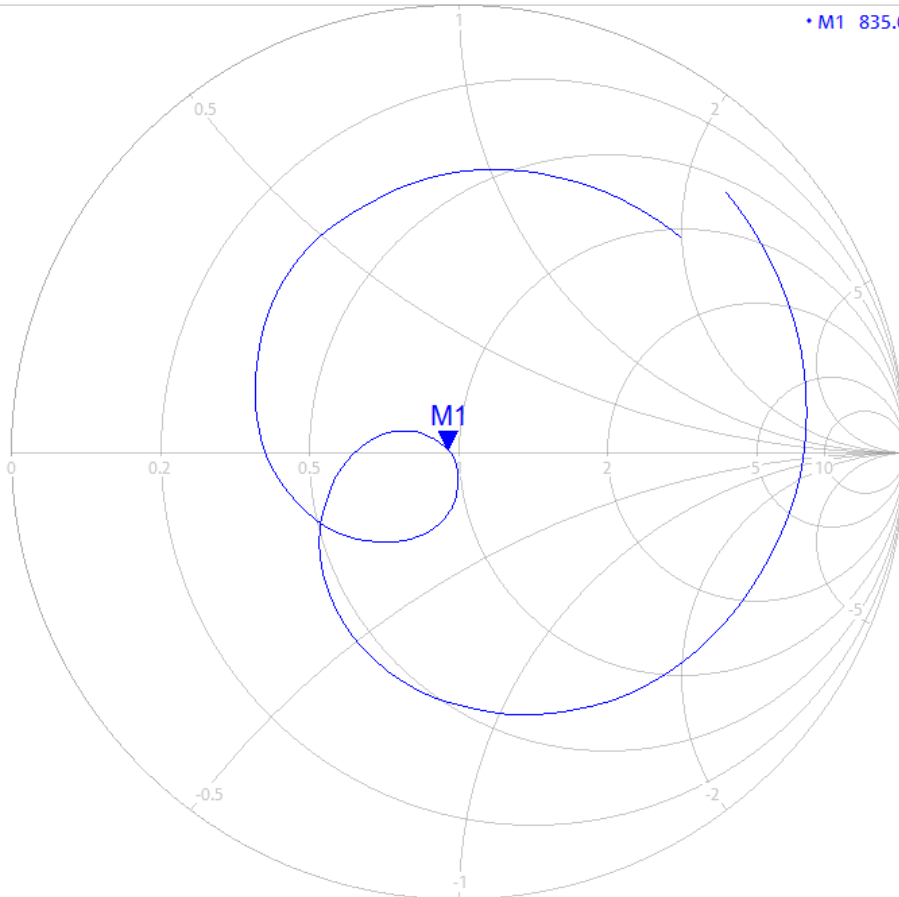

Ch1 Center 835 MHz

Pwr -10 dBm Bw 10 kHz

Span 400 MHz

CERTIFICATE OF CALIBRATION

ISSUED BY UL VS LTD

UKAS Accredited Calibration Laboratory No. 5248

CERTIFICATE
NUMBER :
12134289JD01B

Page 7 of 10

Return Loss Measurement Plot for Head Stimulating Liquid (HSL)

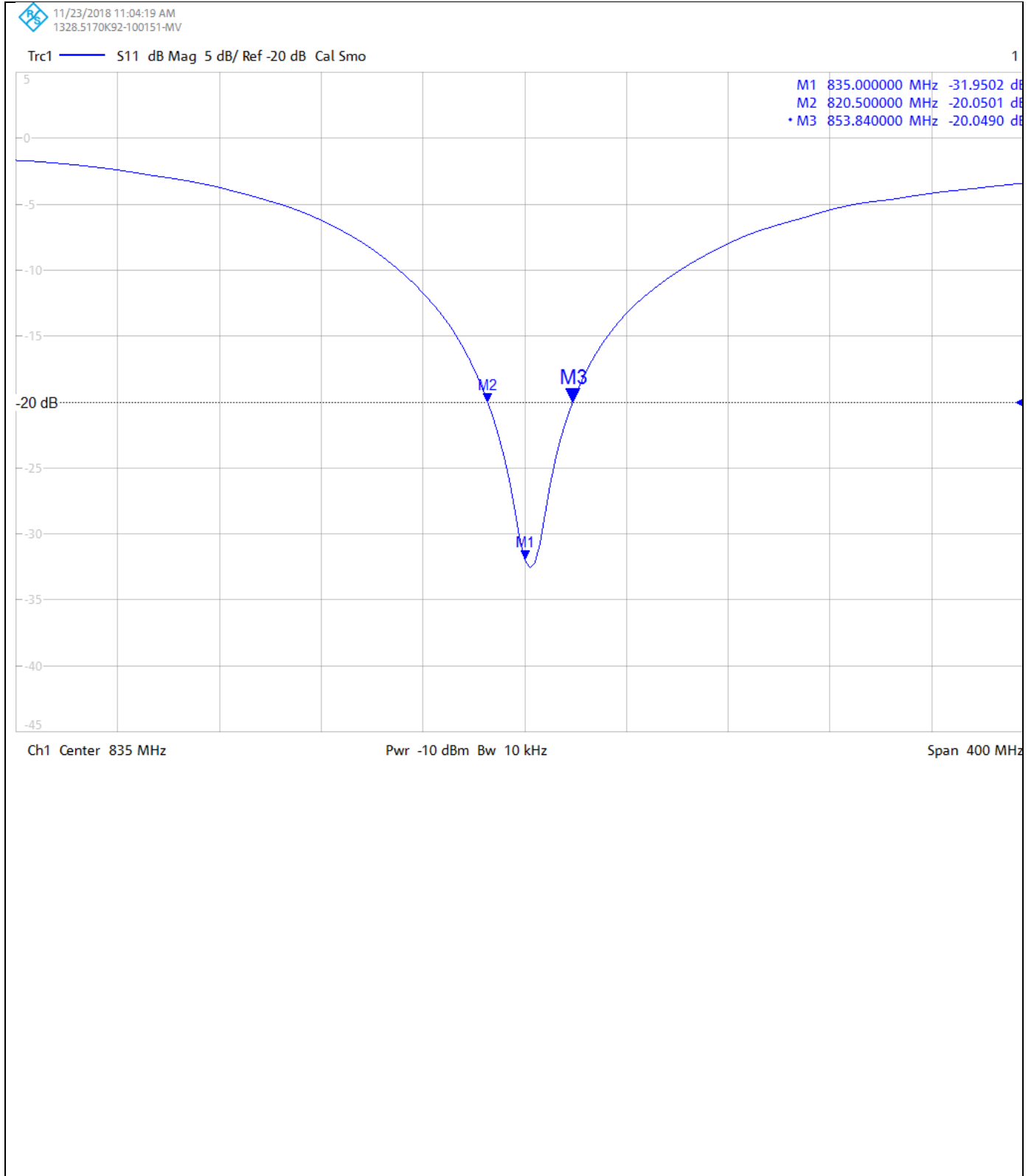

CERTIFICATE OF CALIBRATION

ISSUED BY UL VS LTD

CERTIFICATE
NUMBER :
12134289JD01B

UKAS Accredited Calibration Laboratory No. 5248

Page 8 of 10

DASY Validation Scan for Body Stimulating Liquid (MSL)

DUT: D835V2 - SN4d002; Type: D900V2; Serial: SN4d002

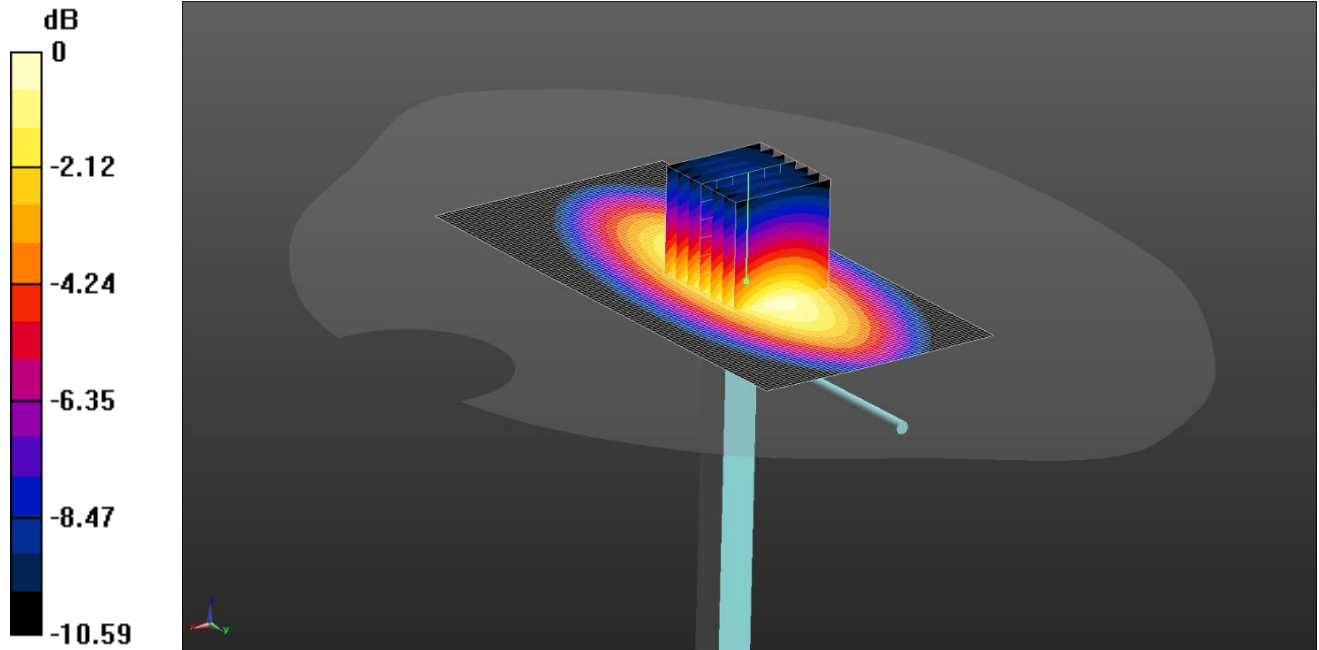

0 dB = 2.97 W/kg = 4.73 dBW/kg

Communication System: UID 0, CW (0); Frequency: 835 MHz; Duty Cycle: 1:1

Medium: 750,835,900,1800 5%MHz MSL Medium parameters used (interpolated): $f = 835$ MHz; $\sigma = 0.992$ S/m; $\epsilon_r = 54.099$; $\rho = 1000$ kg/m³

Phantom section: Flat Section

DASY4 Configuration:

- Probe: ES3DV3 - SN3360; ConvF(6.31, 6.31, 6.31); Calibrated: 17/08/2018;
- Sensor-Surface: 3mm (Mechanical Surface Detection)
- Electronics: DAE4 Sn1543; Calibrated: 08/03/2018
- Phantom: Twin SAM B (Site 65); Type: SAM 5.0; Serial: TP:1836
- ; SEMCAD X Version 14.6.10 (7417)

SAR/d=10mm, Pin=50 mW/Area Scan (61x121x1): Interpolated grid: dx=1.200 mm, dy=1.200 mm

Maximum value of SAR (interpolated) = 2.96 W/kg

SAR/d=10mm, Pin=50 mW/Zoom Scan 2 2 (7x7x7)/Cube 0: Measurement grid: dx=5mm, dy=5mm, dz=5mm

Reference Value = 56.17 V/m; Power Drift = -0.00 dB

Peak SAR (extrapolated) = 3.82 W/kg

SAR(1 g) = 2.53 W/kg; SAR(10 g) = 1.65 W/kg

Maximum value of SAR (measured) = 2.97 W/kg

CERTIFICATE OF CALIBRATION

ISSUED BY UL VS LTD

CERTIFICATE
NUMBER :
12134289JD01B

UKAS Accredited Calibration Laboratory No. 5248

Page 9 of 10

Impedance Measurement Plot for Body Stimulating Liquid (MSL)

11/23/2018 3:30:40 PM
1328.5170K92-100151-MV

Trc1 — S11 Smith 200 mU/ Ref 1 U Cal Smo

1

• M1 835.000000 MHz 46.486 Ω
j5.588 Ω
1.065 nH

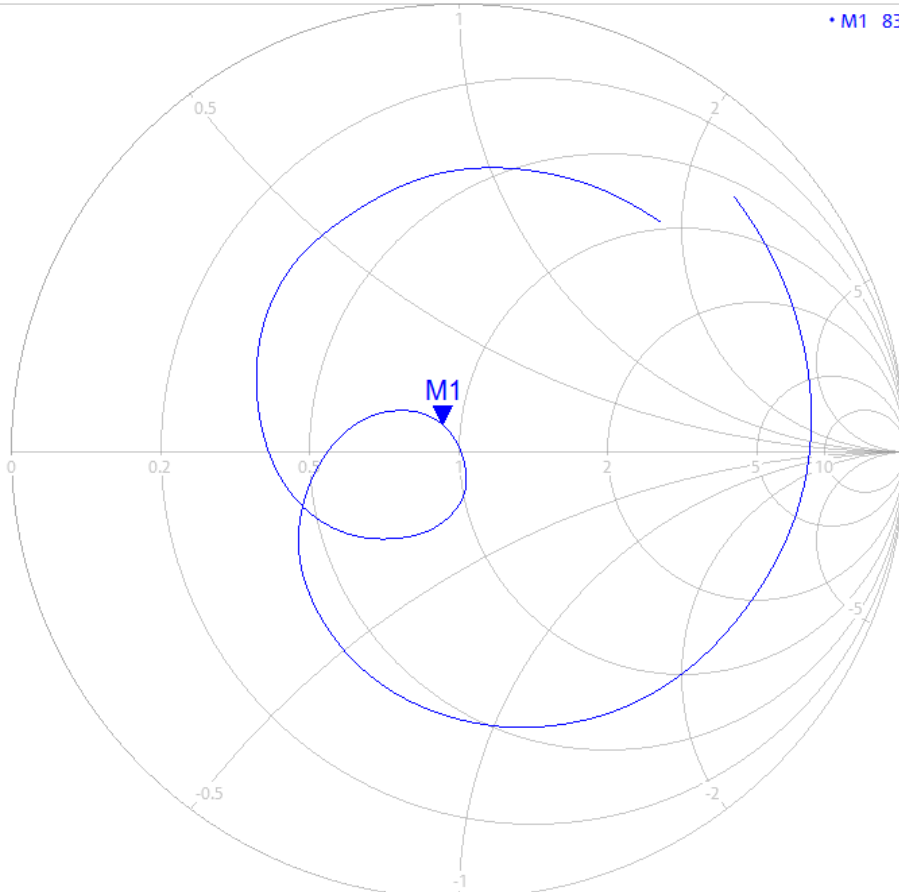

Ch1 Center 835 MHz

Pwr -10 dBm Bw 10 kHz

Span 400 MHz

CERTIFICATE OF CALIBRATION

ISSUED BY UL VS LTD

UKAS Accredited Calibration Laboratory No. 5248

CERTIFICATE
NUMBER :
12134289JD01B

Page 10 of 10

Return Loss Measurement Plot for Body Stimulating Liquid (MSL)

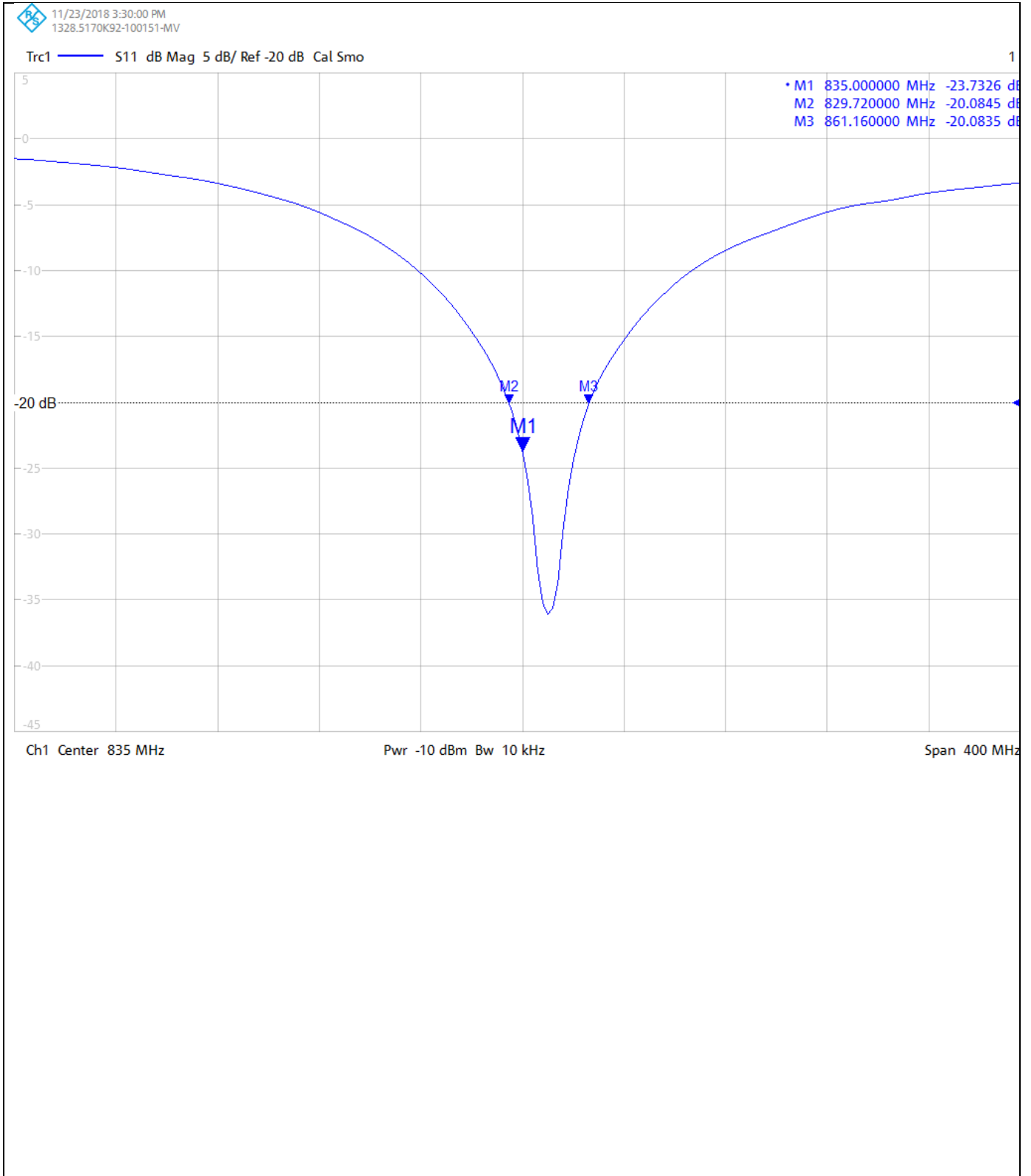

Calibration Certificate Label:

 <p>UKAS CALIBRATION 5248</p>	<p>UL VS LTD - Tel: +44 (0) 1256312000</p> <p>Certificate Number: 12134289JD01B</p> <p>Instrument ID: 4d002</p> <p>Calibration Date: 28/Nov/2018</p> <p>Calibration Due Date:</p>
--	--

 <p>UKAS CALIBRATION 5248</p>	<p>UL VS LTD - Tel: +44 (0) 1256312000</p> <p>Certificate Number: 12134289JD01B</p> <p>Instrument ID: 4d002</p> <p>Calibration Date: 28/Nov/2018</p> <p>Calibration Due Date:</p>
--	--

 <p>UKAS CALIBRATION 5248</p>	<p>UL VS LTD - Tel: +44 (0) 1256312000</p> <p>Certificate Number: 12134289JD01B</p> <p>Instrument ID: 4d002</p> <p>Calibration Date: 28/Nov/2018</p> <p>Calibration Due Date:</p>
--	--



Accreditation No.: **SCS 0108**

Accredited by the Swiss Accreditation Service (SAS)
**The Swiss Accreditation Service is one of the signatories to the EA
Multilateral Agreement for the recognition of calibration certificates**

Client **UL CCS USA**

Certificate No: **D835V2-4d117_May19**

CALIBRATION CERTIFICATE

Object **D835V2 - SN:4d117**

Calibration procedure(s) **QA CAL-05.v11
Calibration Procedure for SAR Validation Sources between 0.7-3 GHz**

Calibration date: **May 15, 2019**

This calibration certificate documents the traceability to national standards, which realize the physical units of measurements (SI).
The measurements and the uncertainties with confidence probability are given on the following pages and are part of the certificate.

All calibrations have been conducted in the closed laboratory facility: environment temperature (22 ± 3)°C and humidity < 70%.

Calibration Equipment used (M&TE critical for calibration)

Primary Standards	ID #	Cal Date (Certificate No.)	Scheduled Calibration
Power meter NRP	SN: 104778	03-Apr-19 (No. 217-02892/02893)	Apr-20
Power sensor NRP-Z91	SN: 103244	03-Apr-19 (No. 217-02892)	Apr-20
Power sensor NRP-Z91	SN: 103245	03-Apr-19 (No. 217-02893)	Apr-20
Reference 20 dB Attenuator	SN: 5058 (20k)	04-Apr-19 (No. 217-02894)	Apr-20
Type-N mismatch combination	SN: 5047.2 / 06327	04-Apr-19 (No. 217-02895)	Apr-20
Reference Probe EX3DV4	SN: 7349	31-Dec-18 (No. EX3-7349_Dec18)	Dec-19
DAE4	SN: 601	30-Apr-19 (No. DAE4-601_Apr19)	Apr-20

Secondary Standards	ID #	Check Date (in house)	Scheduled Check
Power meter E4419B	SN: GB39512475	30-Oct-14 (in house check Feb-19)	In house check: Oct-20
Power sensor HP 8481A	SN: US37292783	07-Oct-15 (in house check Oct-18)	In house check: Oct-20
Power sensor HP 8481A	SN: MY41092317	07-Oct-15 (in house check Oct-18)	In house check: Oct-20
RF generator R&S SMT-06	SN: 100972	15-Jun-15 (in house check Oct-18)	In house check: Oct-20
Network Analyzer Agilent E8358A	SN: US41080477	31-Mar-14 (in house check Oct-18)	In house check: Oct-19

	Name	Function	Signature
Calibrated by:	Jeton Kastrati	Laboratory Technician	
Approved by:	Katja Pokovic	Technical Manager	

Issued: May 16, 2019

This calibration certificate shall not be reproduced except in full without written approval of the laboratory.



Accredited by the Swiss Accreditation Service (SAS)

The Swiss Accreditation Service is one of the signatories to the EA Multilateral Agreement for the recognition of calibration certificates

Glossary:

TSL	tissue simulating liquid
ConvF	sensitivity in TSL / NORM x,y,z
N/A	not applicable or not measured

Calibration is Performed According to the Following Standards:

- IEEE Std 1528-2013, "IEEE Recommended Practice for Determining the Peak Spatial-Averaged Specific Absorption Rate (SAR) in the Human Head from Wireless Communications Devices: Measurement Techniques", June 2013
- IEC 62209-1, "Measurement procedure for the assessment of Specific Absorption Rate (SAR) from hand-held and body-mounted devices used next to the ear (frequency range of 300 MHz to 6 GHz)", July 2016
- IEC 62209-2, "Procedure to determine the Specific Absorption Rate (SAR) for wireless communication devices used in close proximity to the human body (frequency range of 30 MHz to 6 GHz)", March 2010
- KDB 865664, "SAR Measurement Requirements for 100 MHz to 6 GHz"

Additional Documentation:

- DASY4/5 System Handbook

Methods Applied and Interpretation of Parameters:

- Measurement Conditions:** Further details are available from the Validation Report at the end of the certificate. All figures stated in the certificate are valid at the frequency indicated.
- Antenna Parameters with TSL:** The dipole is mounted with the spacer to position its feed point exactly below the center marking of the flat phantom section, with the arms oriented parallel to the body axis.
- Feed Point Impedance and Return Loss:** These parameters are measured with the dipole positioned under the liquid filled phantom. The impedance stated is transformed from the measurement at the SMA connector to the feed point. The Return Loss ensures low reflected power. No uncertainty required.
- Electrical Delay:** One-way delay between the SMA connector and the antenna feed point. No uncertainty required.
- SAR measured:** SAR measured at the stated antenna input power.
- SAR normalized:** SAR as measured, normalized to an input power of 1 W at the antenna connector.
- SAR for nominal TSL parameters:** The measured TSL parameters are used to calculate the nominal SAR result.

The reported uncertainty of measurement is stated as the standard uncertainty of measurement multiplied by the coverage factor $k=2$, which for a normal distribution corresponds to a coverage probability of approximately 95%.

Measurement Conditions

DASY system configuration, as far as not given on page 1.

DASY Version	DASY5	V52.10.2
Extrapolation	Advanced Extrapolation	
Phantom	Modular Flat Phantom	
Distance Dipole Center - TSL	15 mm	with Spacer
Zoom Scan Resolution	dx, dy, dz = 5 mm	
Frequency	835 MHz \pm 1 MHz	

Head TSL parameters

The following parameters and calculations were applied.

	Temperature	Permittivity	Conductivity
Nominal Head TSL parameters	22.0 °C	41.5	0.90 mho/m
Measured Head TSL parameters	(22.0 \pm 0.2) °C	41.8 \pm 6 %	0.93 mho/m \pm 6 %
Head TSL temperature change during test	< 0.5 °C	----	----

SAR result with Head TSL

SAR averaged over 1 cm³ (1 g) of Head TSL	Condition	
SAR measured	250 mW input power	2.43 W/kg
SAR for nominal Head TSL parameters	normalized to 1W	9.50 W/kg \pm 17.0 % (k=2)

SAR averaged over 10 cm³ (10 g) of Head TSL	condition	
SAR measured	250 mW input power	1.57 W/kg
SAR for nominal Head TSL parameters	normalized to 1W	6.17 W/kg \pm 16.5 % (k=2)

Body TSL parameters

The following parameters and calculations were applied.

	Temperature	Permittivity	Conductivity
Nominal Body TSL parameters	22.0 °C	55.2	0.97 mho/m
Measured Body TSL parameters	(22.0 \pm 0.2) °C	54.9 \pm 6 %	0.99 mho/m \pm 6 %
Body TSL temperature change during test	< 0.5 °C	----	----

SAR result with Body TSL

SAR averaged over 1 cm³ (1 g) of Body TSL	Condition	
SAR measured	250 mW input power	2.46 W/kg
SAR for nominal Body TSL parameters	normalized to 1W	9.68 W/kg \pm 17.0 % (k=2)

SAR averaged over 10 cm³ (10 g) of Body TSL	condition	
SAR measured	250 mW input power	1.60 W/kg
SAR for nominal Body TSL parameters	normalized to 1W	6.32 W/kg \pm 16.5 % (k=2)

Appendix (Additional assessments outside the scope of SCS 0108)

Antenna Parameters with Head TSL

Impedance, transformed to feed point	52.4 Ω - 2.1 j Ω
Return Loss	- 30.1 dB

Antenna Parameters with Body TSL

Impedance, transformed to feed point	48.3 Ω - 5.2 j Ω
Return Loss	- 25.0 dB

General Antenna Parameters and Design

Electrical Delay (one direction)	1.396 ns
----------------------------------	----------

After long term use with 100W radiated power, only a slight warming of the dipole near the feedpoint can be measured.

The dipole is made of standard semirigid coaxial cable. The center conductor of the feeding line is directly connected to the second arm of the dipole. The antenna is therefore short-circuited for DC-signals. On some of the dipoles, small end caps are added to the dipole arms in order to improve matching when loaded according to the position as explained in the "Measurement Conditions" paragraph. The SAR data are not affected by this change. The overall dipole length is still according to the Standard.

No excessive force must be applied to the dipole arms, because they might bend or the soldered connections near the feedpoint may be damaged.

Additional EUT Data

Manufactured by	SPEAG
-----------------	-------

DASY5 Validation Report for Head TSL

Date: 14.05.2019

Test Laboratory: SPEAG, Zurich, Switzerland

DUT: Dipole 835 MHz; Type: D835V2; Serial: D835V2 - SN:4d117

Communication System: UID 0 - CW; Frequency: 835 MHz

Medium parameters used: $f = 835 \text{ MHz}$; $\sigma = 0.93 \text{ S/m}$; $\epsilon_r = 41.8$; $\rho = 1000 \text{ kg/m}^3$

Phantom section: Flat Section

Measurement Standard: DASY5 (IEEE/IEC/ANSI C63.19-2011)

DASY52 Configuration:

- Probe: EX3DV4 - SN7349; ConvF(10, 10, 10) @ 835 MHz; Calibrated: 31.12.2018
- Sensor-Surface: 1.4mm (Mechanical Surface Detection)
- Electronics: DAE4 Sn601; Calibrated: 30.04.2019
- Phantom: Flat Phantom 4.9 (front); Type: QD 00L P49 AA; Serial: 1001
- DASY52 52.10.2(1495); SEMCAD X 14.6.12(7450)

Dipole Calibration for Head Tissue/Pin=250 mW, d=15mm/Zoom Scan (7x7x7)/Cube 0:

Measurement grid: $dx=5\text{mm}$, $dy=5\text{mm}$, $dz=5\text{mm}$

Reference Value = 62.35 V/m; Power Drift = -0.01 dB

Peak SAR (extrapolated) = 3.71 W/kg

SAR(1 g) = 2.43 W/kg; SAR(10 g) = 1.57 W/kg

Maximum value of SAR (measured) = 3.26 W/kg

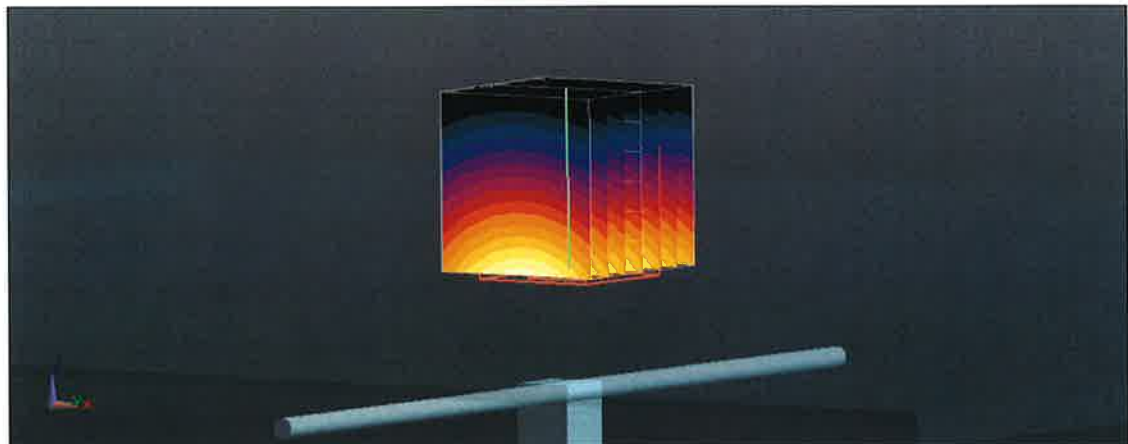
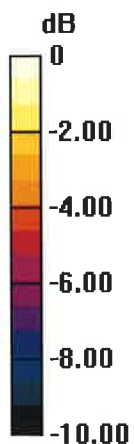

0 dB = 3.26 W/kg = 5.13 dBW/kg

Impedance Measurement Plot for Head TSL

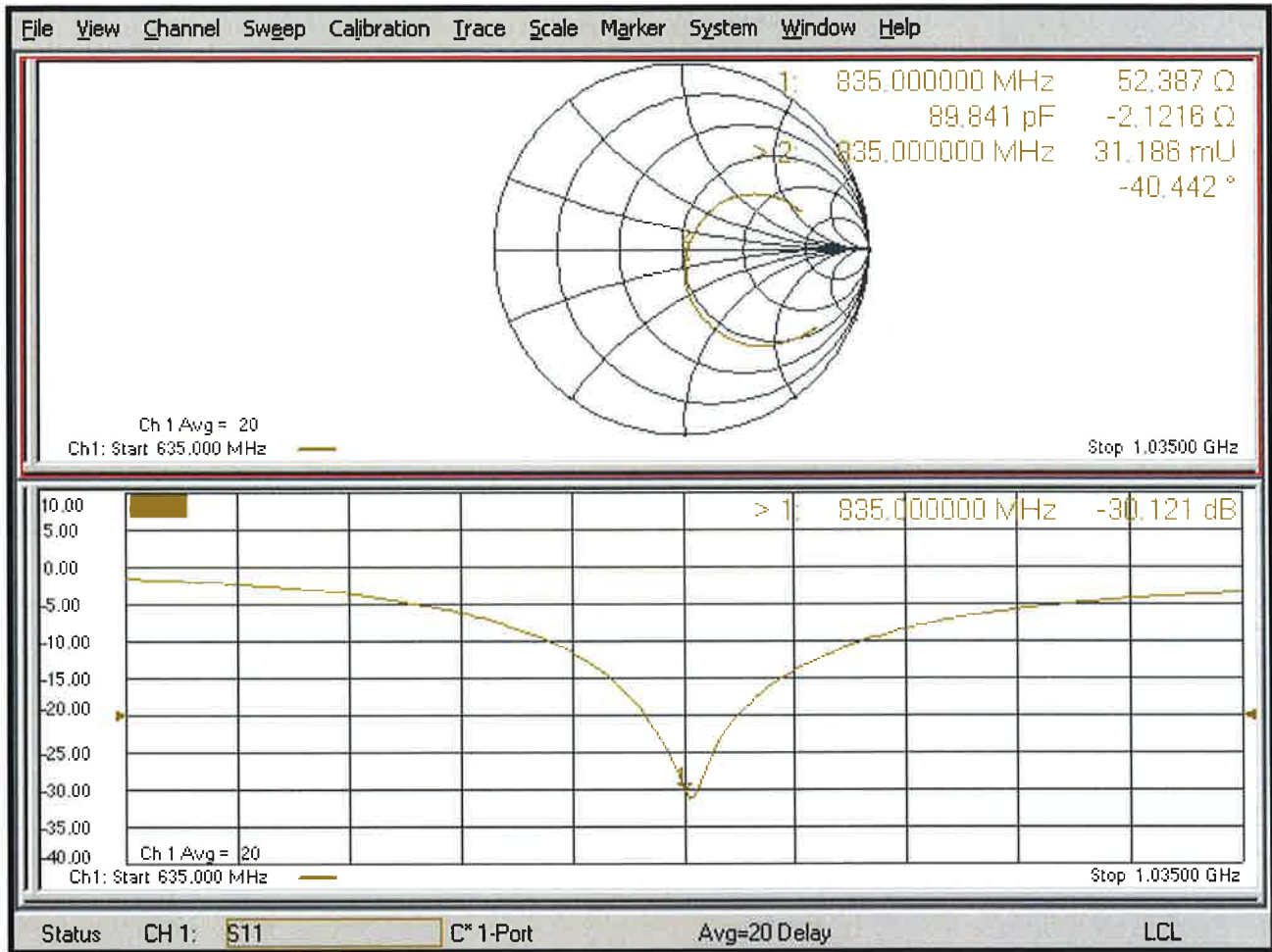

Test Laboratory: SPEAG, Zurich, Switzerland

DUT: Dipole 835 MHz; Type: D835V2; Serial: D835V2 - SN:4d117

Communication System: UID 0 - CW; Frequency: 835 MHz

Medium parameters used: $f = 835 \text{ MHz}$; $\sigma = 0.99 \text{ S/m}$; $\epsilon_r = 54.9$; $\rho = 1000 \text{ kg/m}^3$

Phantom section: Flat Section

Measurement Standard: DASY5 (IEEE/IEC/ANSI C63.19-2011)

DASY52 Configuration:

- Probe: EX3DV4 - SN7349; ConvF(10.15, 10.15, 10.15) @ 835 MHz; Calibrated: 31.12.2018
- Sensor-Surface: 1.4mm (Mechanical Surface Detection)
- Electronics: DAE4 Sn601; Calibrated: 30.04.2019
- Phantom: Flat Phantom 4.9 (Back); Type: QD 00R P49 AA; Serial: 1005
- DASY52 52.10.2(1495); SEMCAD X 14.6.12(7450)

Dipole Calibration for Body Tissue/Pin=250 mW, d=15mm/Zoom Scan (7x7x7)/Cube 0:

Measurement grid: dx=5mm, dy=5mm, dz=5mm

Reference Value = 60.12 V/m; Power Drift = -0.04 dB

Peak SAR (extrapolated) = 3.67 W/kg

SAR(1 g) = 2.46 W/kg; SAR(10 g) = 1.6 W/kg

Maximum value of SAR (measured) = 3.27 W/kg

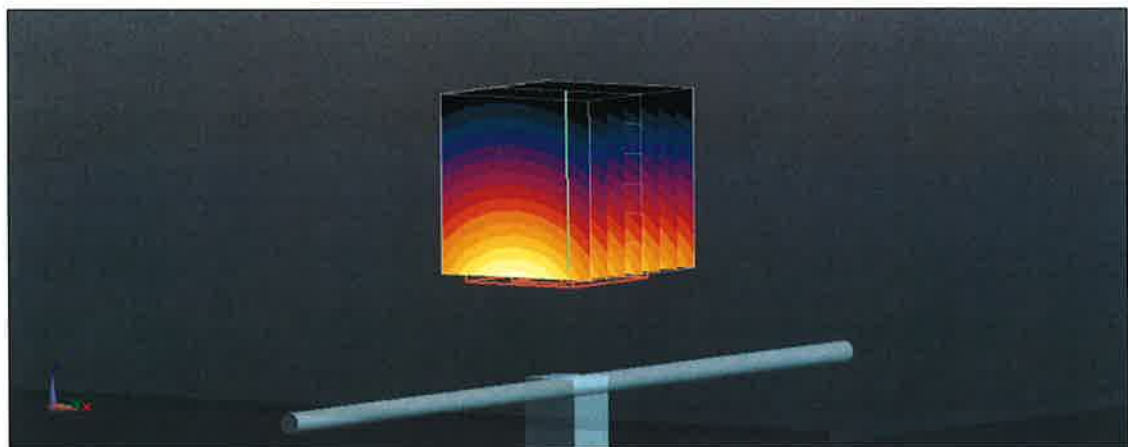
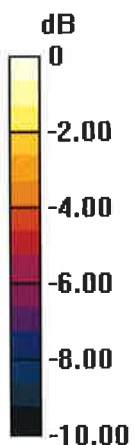

0 dB = 3.27 W/kg = 5.15 dBW/kg

Impedance Measurement Plot for Body TSL

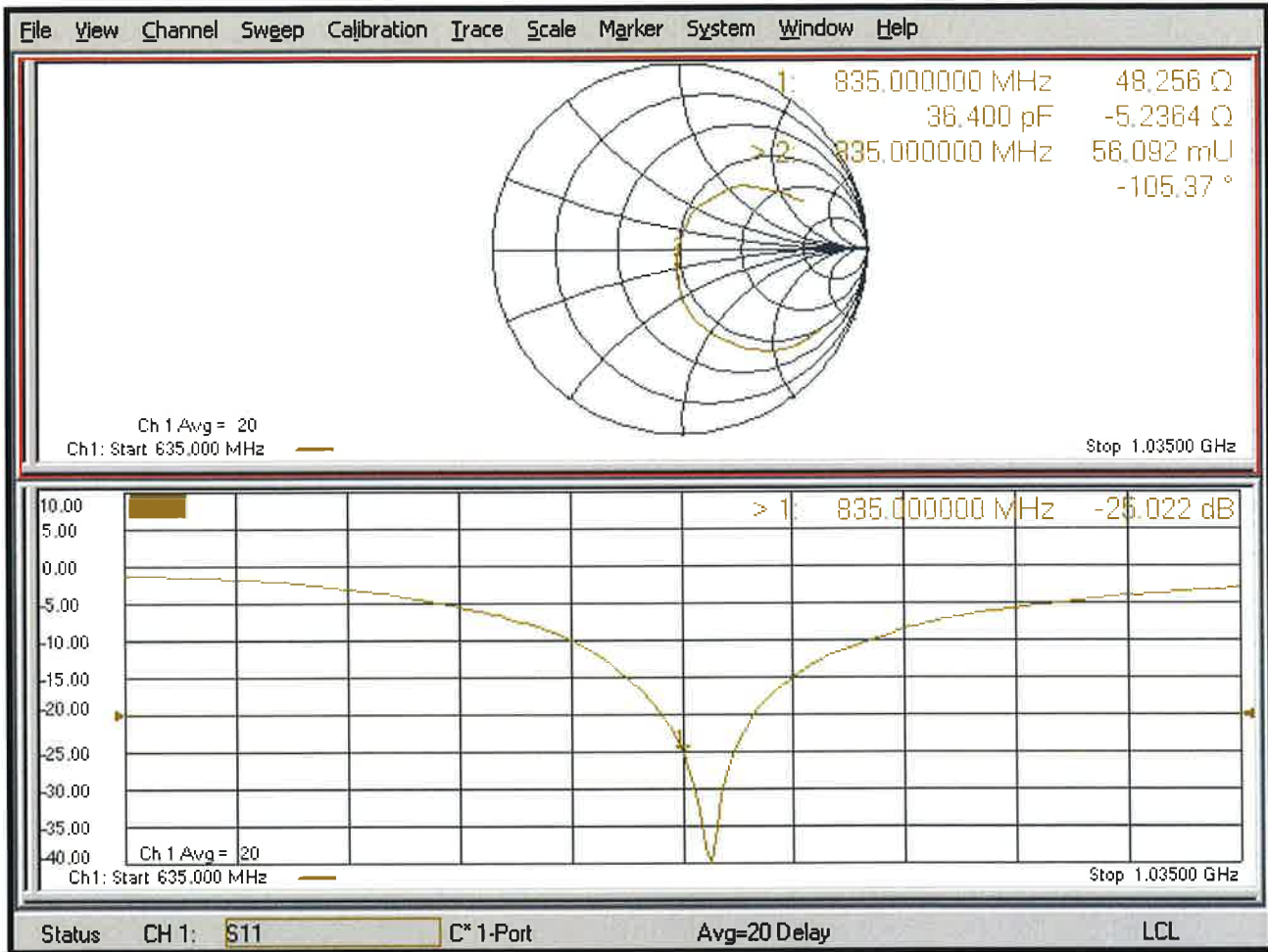



Accredited by the Swiss Accreditation Service (SAS)
**The Swiss Accreditation Service is one of the signatories to the EA
Multilateral Agreement for the recognition of calibration certificates**

Accreditation No.: **SCS 0108**

Client **UL CCS USA**

Certificate No: **D1750V2-1050_Apr19**

CALIBRATION CERTIFICATE

Object **D1750V2 - SN:1050**

Calibration procedure(s) **QA CAL-05.v11
Calibration Procedure for SAR Validation Sources between 0.7-3 GHz**

Calibration date: **April 17, 2019**

This calibration certificate documents the traceability to national standards, which realize the physical units of measurements (SI).
The measurements and the uncertainties with confidence probability are given on the following pages and are part of the certificate.

All calibrations have been conducted in the closed laboratory facility: environment temperature (22 ± 3)°C and humidity < 70%.

Calibration Equipment used (M&TE critical for calibration)

Primary Standards	ID #	Cal Date (Certificate No.)	Scheduled Calibration
Power meter NRP	SN: 104778	03-Apr-19 (No. 217-02892/02893)	Apr-20
Power sensor NRP-Z91	SN: 103244	03-Apr-19 (No. 217-02892)	Apr-20
Power sensor NRP-Z91	SN: 103245	03-Apr-19 (No. 217-02893)	Apr-20
Reference 20 dB Attenuator	SN: 5058 (20k)	04-Apr-19 (No. 217-02894)	Apr-20
Type-N mismatch combination	SN: 5047.2 / 06327	04-Apr-19 (No. 217-02895)	Apr-20
Reference Probe EX3DV4	SN: 7349	31-Dec-18 (No. EX3-7349_Dec18)	Dec-19
DAE4	SN: 601	04-Oct-18 (No. DAE4-601_Oct18)	Oct-19

Secondary Standards	ID #	Check Date (in house)	Scheduled Check
Power meter E4419B	SN: GB39512475	07-Oct-15 (in house check Feb-19)	In house check: Oct-20
Power sensor HP 8481A	SN: US37292783	07-Oct-15 (in house check Oct-18)	In house check: Oct-20
Power sensor HP 8481A	SN: MY41092317	07-Oct-15 (in house check Oct-18)	In house check: Oct-20
RF generator R&S SMT-06	SN: 100972	15-Jun-15 (in house check Oct-18)	In house check: Oct-20
Network Analyzer Agilent E8358A	SN: US41080477	31-Mar-14 (in house check Oct-18)	In house check: Oct-19

Calibrated by:	Name Michael Weber	Function Laboratory Technician	Signature
Approved by:	Name Katja Pokovic	Function Technical Manager	

Issued: April 18, 2019

This calibration certificate shall not be reproduced except in full without written approval of the laboratory.



Accredited by the Swiss Accreditation Service (SAS)
The Swiss Accreditation Service is one of the signatories to the EA
Multilateral Agreement for the recognition of calibration certificates

Glossary:

TSL	tissue simulating liquid
ConvF	sensitivity in TSL / NORM x,y,z
N/A	not applicable or not measured

Calibration is Performed According to the Following Standards:

- IEEE Std 1528-2013, "IEEE Recommended Practice for Determining the Peak Spatial-Averaged Specific Absorption Rate (SAR) in the Human Head from Wireless Communications Devices: Measurement Techniques", June 2013
- IEC 62209-1, "Measurement procedure for the assessment of Specific Absorption Rate (SAR) from hand-held and body-mounted devices used next to the ear (frequency range of 300 MHz to 6 GHz)", July 2016
- IEC 62209-2, "Procedure to determine the Specific Absorption Rate (SAR) for wireless communication devices used in close proximity to the human body (frequency range of 30 MHz to 6 GHz)", March 2010
- KDB 865664, "SAR Measurement Requirements for 100 MHz to 6 GHz"

Additional Documentation:

- DASY4/5 System Handbook

Methods Applied and Interpretation of Parameters:

- Measurement Conditions:** Further details are available from the Validation Report at the end of the certificate. All figures stated in the certificate are valid at the frequency indicated.
- Antenna Parameters with TSL:** The dipole is mounted with the spacer to position its feed point exactly below the center marking of the flat phantom section, with the arms oriented parallel to the body axis.
- Feed Point Impedance and Return Loss:** These parameters are measured with the dipole positioned under the liquid filled phantom. The impedance stated is transformed from the measurement at the SMA connector to the feed point. The Return Loss ensures low reflected power. No uncertainty required.
- Electrical Delay:** One-way delay between the SMA connector and the antenna feed point. No uncertainty required.
- SAR measured:** SAR measured at the stated antenna input power.
- SAR normalized:** SAR as measured, normalized to an input power of 1 W at the antenna connector.
- SAR for nominal TSL parameters:** The measured TSL parameters are used to calculate the nominal SAR result.

The reported uncertainty of measurement is stated as the standard uncertainty of measurement multiplied by the coverage factor $k=2$, which for a normal distribution corresponds to a coverage probability of approximately 95%.

Measurement Conditions

DASY system configuration, as far as not given on page 1.

DASY Version	DASY5	V52.10.2
Extrapolation	Advanced Extrapolation	
Phantom	Modular Flat Phantom	
Distance Dipole Center - TSL	10 mm	with Spacer
Zoom Scan Resolution	dx, dy, dz = 5 mm	
Frequency	1750 MHz \pm 1 MHz	

Head TSL parameters

The following parameters and calculations were applied.

	Temperature	Permittivity	Conductivity
Nominal Head TSL parameters	22.0 °C	40.1	1.37 mho/m
Measured Head TSL parameters	(22.0 \pm 0.2) °C	40.0 \pm 6 %	1.34 mho/m \pm 6 %
Head TSL temperature change during test	< 0.5 °C	----	----

SAR result with Head TSL

SAR averaged over 1 cm³ (1 g) of Head TSL	Condition	
SAR measured	250 mW input power	8.74 W/kg
SAR for nominal Head TSL parameters	normalized to 1W	35.4 W/kg \pm 17.0 % (k=2)

SAR averaged over 10 cm³ (10 g) of Head TSL	condition	
SAR measured	250 mW input power	4.61 W/kg
SAR for nominal Head TSL parameters	normalized to 1W	18.6 W/kg \pm 16.5 % (k=2)

Body TSL parameters

The following parameters and calculations were applied.

	Temperature	Permittivity	Conductivity
Nominal Body TSL parameters	22.0 °C	53.4	1.49 mho/m
Measured Body TSL parameters	(22.0 \pm 0.2) °C	52.3 \pm 6 %	1.48 mho/m \pm 6 %
Body TSL temperature change during test	< 0.5 °C	----	----

SAR result with Body TSL

SAR averaged over 1 cm³ (1 g) of Body TSL	Condition	
SAR measured	250 mW input power	9.10 W/kg
SAR for nominal Body TSL parameters	normalized to 1W	36.4 W/kg \pm 17.0 % (k=2)

SAR averaged over 10 cm³ (10 g) of Body TSL	condition	
SAR measured	250 mW input power	4.79 W/kg
SAR for nominal Body TSL parameters	normalized to 1W	19.2 W/kg \pm 16.5 % (k=2)

Appendix (Additional assessments outside the scope of SCS 0108)

Antenna Parameters with Head TSL

Impedance, transformed to feed point	50.3 Ω - 1.8 j Ω
Return Loss	- 34.8 dB

Antenna Parameters with Body TSL

Impedance, transformed to feed point	47.5 Ω - 2.1 j Ω
Return Loss	- 29.6 dB

General Antenna Parameters and Design

Electrical Delay (one direction)	1.224 ns
----------------------------------	----------

After long term use with 100W radiated power, only a slight warming of the dipole near the feedpoint can be measured.

The dipole is made of standard semirigid coaxial cable. The center conductor of the feeding line is directly connected to the second arm of the dipole. The antenna is therefore short-circuited for DC-signals. On some of the dipoles, small end caps are added to the dipole arms in order to improve matching when loaded according to the position as explained in the "Measurement Conditions" paragraph. The SAR data are not affected by this change. The overall dipole length is still according to the Standard.

No excessive force must be applied to the dipole arms, because they might bend or the soldered connections near the feedpoint may be damaged.

Additional EUT Data

Manufactured by	SPEAG
-----------------	-------

DASY5 Validation Report for Head TSL

Date: 17.04.2019

Test Laboratory: SPEAG, Zurich, Switzerland

DUT: Dipole 1750 MHz; Type: D1750V2; Serial: D1750V2 - SN:1050

Communication System: UID 0 - CW; Frequency: 1750 MHz

Medium parameters used: $f = 1750$ MHz; $\sigma = 1.34$ S/m; $\epsilon_r = 40$; $\rho = 1000$ kg/m³

Phantom section: Flat Section

Measurement Standard: DASY5 (IEEE/IEC/ANSI C63.19-2011)

DASY52 Configuration:

- Probe: EX3DV4 - SN7349; ConvF(8.59, 8.59, 8.59) @ 1750 MHz; Calibrated: 31.12.2018
- Sensor-Surface: 1.4mm (Mechanical Surface Detection)
- Electronics: DAE4 Sn601; Calibrated: 04.10.2018
- Phantom: Flat Phantom 5.0 (front); Type: QD 000 P50 AA; Serial: 1001
- DASY52 52.10.2(1495); SEMCAD X 14.6.12(7450)

Dipole Calibration for Head Tissue/Pin=250 mW, d=10mm/Zoom Scan (7x7x7)/Cube 0:

Measurement grid: dx=5mm, dy=5mm, dz=5mm

Reference Value = 105.8 V/m; Power Drift = 0.01 dB

Peak SAR (extrapolated) = 15.9 W/kg

SAR(1 g) = 8.74 W/kg; SAR(10 g) = 4.61 W/kg

Maximum value of SAR (measured) = 13.5 W/kg



0 dB = 13.5 W/kg = 11.30 dBW/kg

Impedance Measurement Plot for Head TSL

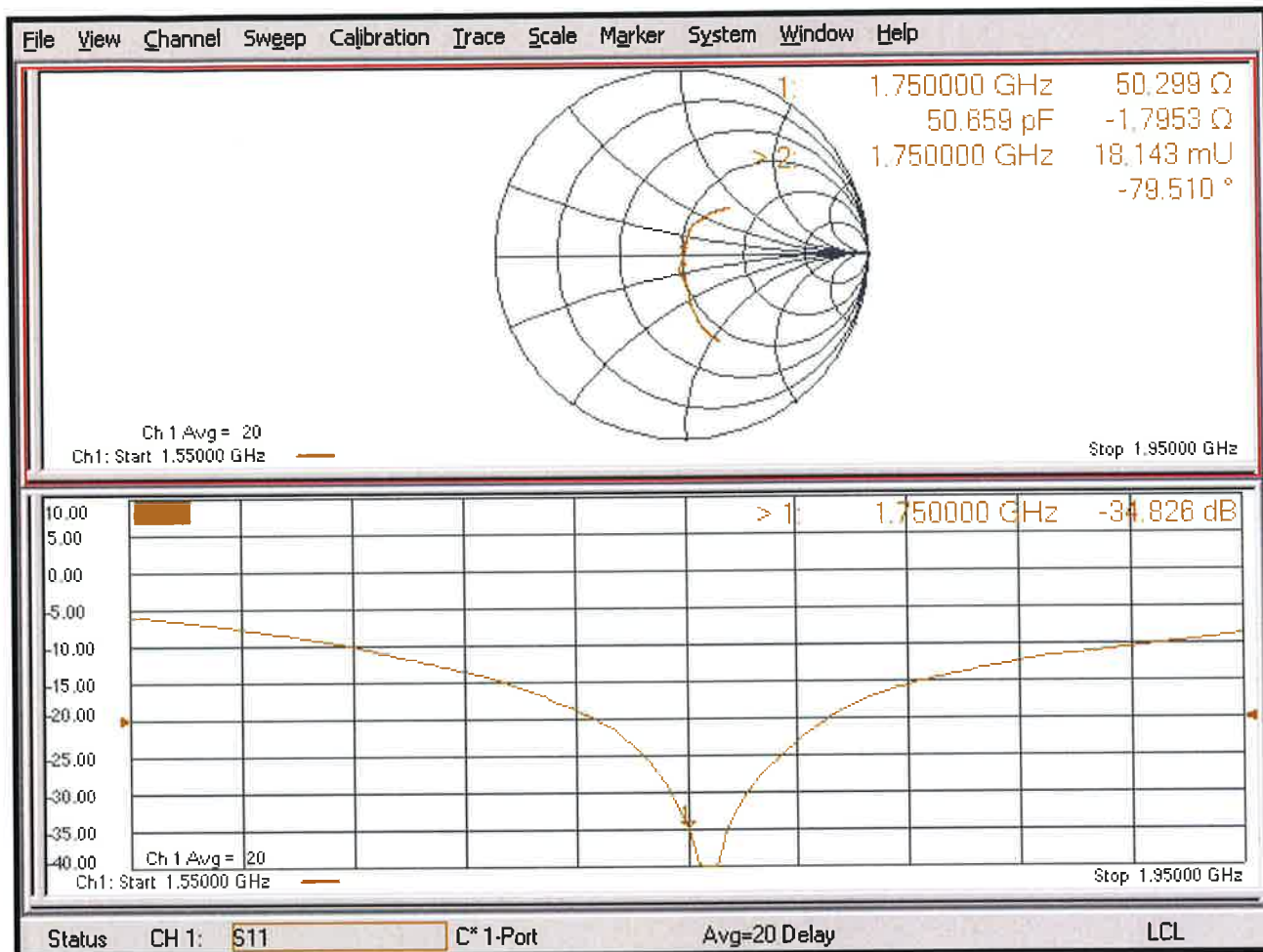

DASY5 Validation Report for Body TSL

Date: 17.04.2019

Test Laboratory: SPEAG, Zurich, Switzerland

DUT: Dipole 1750 MHz; Type: D1750V2; Serial: D1750V2 - SN:1050

Communication System: UID 0 - CW; Frequency: 1750 MHz

Medium parameters used: $f = 1750$ MHz; $\sigma = 1.48$ S/m; $\epsilon_r = 52.3$; $\rho = 1000$ kg/m³

Phantom section: Flat Section

Measurement Standard: DASY5 (IEEE/IEC/ANSI C63.19-2011)

DASY52 Configuration:

- Probe: EX3DV4 - SN7349; ConvF(8.43, 8.43, 8.43) @ 1750 MHz; Calibrated: 31.12.2018
- Sensor-Surface: 1.4mm (Mechanical Surface Detection)
- Electronics: DAE4 Sn601; Calibrated: 04.10.2018
- Phantom: Flat Phantom 5.0 (back); Type: QD 000 P50 AA; Serial: 1002
- DASY52 52.10.2(1495); SEMCAD X 14.6.12(7450)

Dipole Calibration for Body Tissue/Pin=250 mW, d=10mm/Zoom Scan (7x7x7)/Cube 0:

Measurement grid: dx=5mm, dy=5mm, dz=5mm

Reference Value = 101.0 V/m; Power Drift = -0.04 dB

Peak SAR (extrapolated) = 16.7 W/kg

SAR(1 g) = 9.1 W/kg; SAR(10 g) = 4.79 W/kg

Maximum value of SAR (measured) = 13.8 W/kg

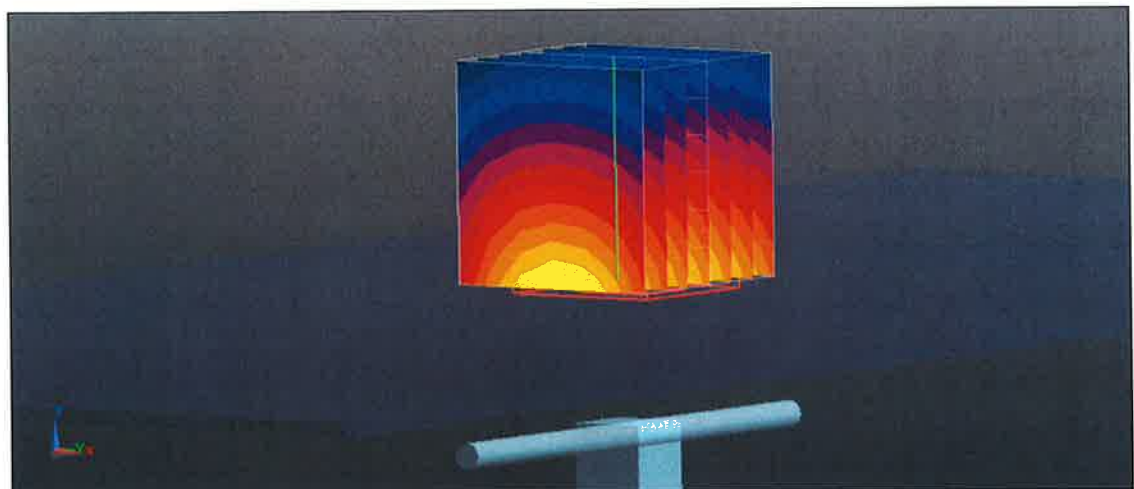
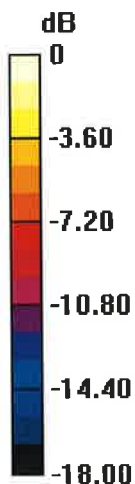

0 dB = 13.8 W/kg = 11.40 dBW/kg

Impedance Measurement Plot for Body TSL

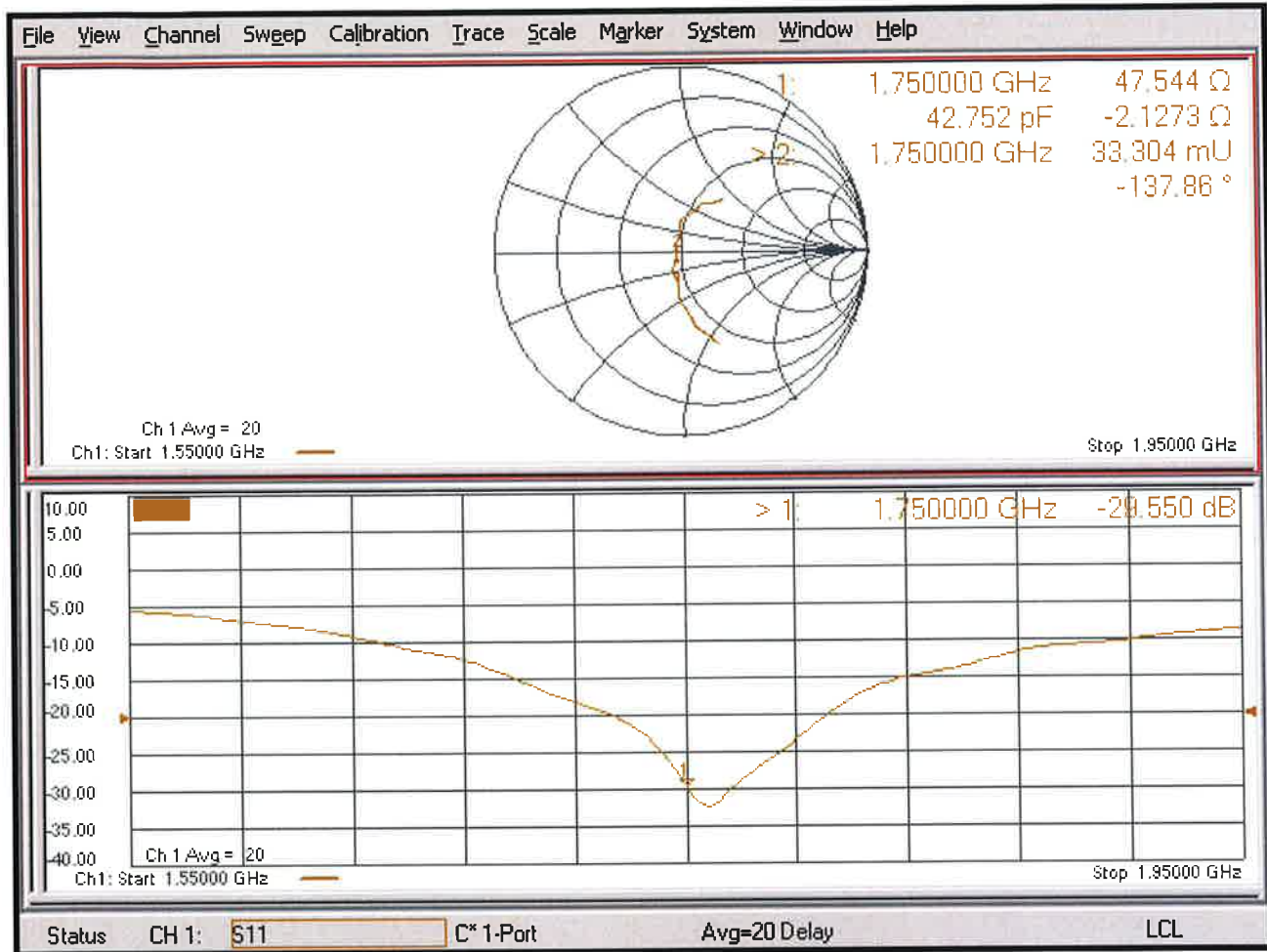

CERTIFICATE OF CALIBRATION

ISSUED BY **UL VS LTD**

DATE OF ISSUE: 16/Oct/2018

CERTIFICATE NUMBER : 12134285JD01B



5248

UL VS LTD
UNIT 1 HORIZON
KINGSLAND PARK, WADE ROAD
BASINGSTOKE, HAMPSHIRE
RG24 8AH, UK
TEL: +44 (0) 1256 312000
FAX: +44 (0) 1256 312001
Email: LST.UK.Calibration@ul.com



Page 1 of 10

APPROVED SIGNATORY

A handwritten signature in black ink, appearing to read 'M. Naseer'.

.....
Naseer Mirza

Customer :

UL VS Inc
47173 Benicia Street
Fremont, CA 94538, USA

Equipment Details:

Description:	Dipole Validation Kit	Date of Receipt:	08/Oct/2018
Manufacturer:	SPEAG		
Type/Model Number:	D1750V2		
Serial Number:	1077		
Calibration Date:	16/Oct/2018		
Calibrated By:	Chanthu Thevarajah Senior Engineer		

Signature:

A handwritten signature in black ink, appearing to be 'Chanthu Thevarajah'.

.....

All Calibration have been conducted in the closed laboratory facility: Lab Temperature (22±3) °C and humidity < 70%

This certificate is issued in accordance with the laboratory accreditation requirements of the United Kingdom Accreditation Service. It provides traceability of measurement to the SI system of units and/or to units of measurement realised at the National Physical Laboratory or other recognised national metrology institutes. This certificate may not be reproduced other than in full, except with the prior written approval of the issuing laboratory.

Use of the UKAS mark demonstrates that compliance with the requirements of BS/EN/ISO/IEC 17025 has been independently assessed.

CERTIFICATE OF CALIBRATION

ISSUED BY UL VS LTD

UKAS Accredited Calibration Laboratory No. 5248

CERTIFICATE
NUMBER :
12134285JD01B

Page 2 of 10

The calibration methods and procedures used were as detailed in:

1. **IEC 62209-1:2016:** Procedure to determine the specific absorption rate (SAR) for hand-held devices used in close proximity to the ear (frequency range of 300 MHz to 3 GHz)
2. **IEC 62209-2:2010:** Procedure to determine the specific absorption rate (SAR) for wireless communication devices used in close proximity to the human body (frequency range of 30 MHz to 6 GHz)
3. **IEEE 1528: 2013:** IEEE Recommended Practice for Determining the Peak Spatial-Average Specific Absorption Rate (SAR) in the Human Head from Wireless Communication Devices: Measurement Techniques
4. FCC KDB Publication Number: **“KDB865664 D01 SAR Measurement 100 MHz to 6 GHz”**
5. **SPEAG DASY4/ DASY5 System Handbook**

The measuring equipment used to perform the calibration, documented in this certificate has been calibrated in accordance with the manufacturers' recommendations, and is traceable to recognized national standards.

UL No.	Instrument	Manufacturer	Type No.	Serial No.	Date Last Calibrated	Cal. Interval (Months)
PRE0178318	Data Acquisition Electronics	SPEAG	DAE4	1543	08 Mar 2018	12
PRE0178315	Probe	SPEAG	ES3DV3	3360	17 Aug 2018	12
A1236	Dipole	SPEAG	D1800V2	2d009	06 Feb 2018	12
PRE0151451	Power Monitoring Kit	Art-Fi	ART 100850-01	0001	Cal as part of System	12
PRE0151441	Power Sensor	Rhode & Schwarz	NRP8S	102481	05 Feb 2018	12
PRE0151154	Network Analyser	Rhode & Schwarz	ZND8	100151	14 Dec 2017	12
PRE0151877	Calibration Kit	Rhode & Schwarz	ZV-Z135	102947-Bt	27 Apr 2018	12
PRE0178154	Signal Generator	Rhode & Schwarz	SMB 100A	175325	09 Apr 2018	12

CERTIFICATE OF CALIBRATION ISSUED BY **UL VS LTD**

UKAS Accredited Calibration Laboratory No. 5248

CERTIFICATE
NUMBER :
12134285JD01B

Page 3 of 10

SAR System Specification

Robot System Positioner:	Stäubli Unimation Corp. Robot Model: TX60L
Robot Serial Number:	F17/5ENYG1/A/01
DASY Version:	DASY 52 (v52.8.8.1258)
Phantom:	Flat section of SAM Twin Phantom
Distance Dipole Centre:	10 mm (with spacer)
Frequency:	1750 MHz

Dielectric Property Measurements – Head Simulating Liquid (HSL)

Simulant Liquid	Frequency (MHz)	Room Temp		Liquid Temp		Parameters	Target Value	Measured Value	Uncertainty (%)
		Start	End	Start	End				
Head	1750	22.2 °C	22.5 °C	22.0°C	22.0°C	ϵ_r	40.10	39.65	± 5%
						σ	1.37	1.40	± 5%

SAR Results – Head Simulating Liquid (HSL)

Simulant Liquid	SAR Measured	250 mW input Power	Normalised to 1.00 W	Uncertainty (%)
Head	SAR averaged over 1g	9.72 W/Kg	38.69 W/Kg	± 17.57%
	SAR averaged over 10g	5.14 W/Kg	20.46 W/Kg	± 17.32%

Antenna Parameters – Head Simulating Liquid (HSL)

Simulant Liquid	Parameter	Measured Level	Uncertainty (%)
Head	Impedance	50.453 Ω -1.52 $j\Omega$	± 0.28 Ω ± 0.044 $j\Omega$
	Return Loss	36.26	± 2.03 dB

CERTIFICATE OF CALIBRATION

ISSUED BY UL VS LTD

UKAS Accredited Calibration Laboratory No. 5248

CERTIFICATE
NUMBER :
12134285JD01B

Page 4 of 10

Dielectric Property Measurements – Body Simulating Liquid (MSL)

Simulant Liquid	Frequency (MHz)	Room Temp		Liquid Temp		Parameters	Target Value	Measured Value	Uncertainty (%)
		Start	End	Start	End				
Body	1750	20.0 °C	21.0 °C	19.9°C	20.2°C	ϵ_r	53.40	53.30	± 5%
						σ	1.49	1.47	± 5%

SAR Results – Body Simulating Liquid (MSL)

Simulant Liquid	SAR Measured	250 mW input Power	Normalised to 1.00 W	Uncertainty (%)
Body	SAR averaged over 1g	9.87 W/Kg	39.29 W/Kg	± 18.06%
	SAR averaged over 10g	5.29 W/Kg	21.05 W/Kg	± 17.44%

Antenna Parameters – Body Simulating Liquid (MSL)

Simulant Liquid	Parameter	Measured Level	Uncertainty (%)
Body	Impedance	49.46 Ω 4.07 j Ω	± 0.28 Ω ± 0.044 j Ω
	Return Loss	27.66	± 2.03 dB

CERTIFICATE OF CALIBRATION

ISSUED BY UL VS LTD

CERTIFICATE
NUMBER :
12134285JD01B

UKAS Accredited Calibration Laboratory No. 5248

Page 5 of 10

DASY Validation Scan for Head Stimulating Liquid (HSL)

DUT: D1750V2 - SN1077; Type: D1750V2; Serial: SN1077

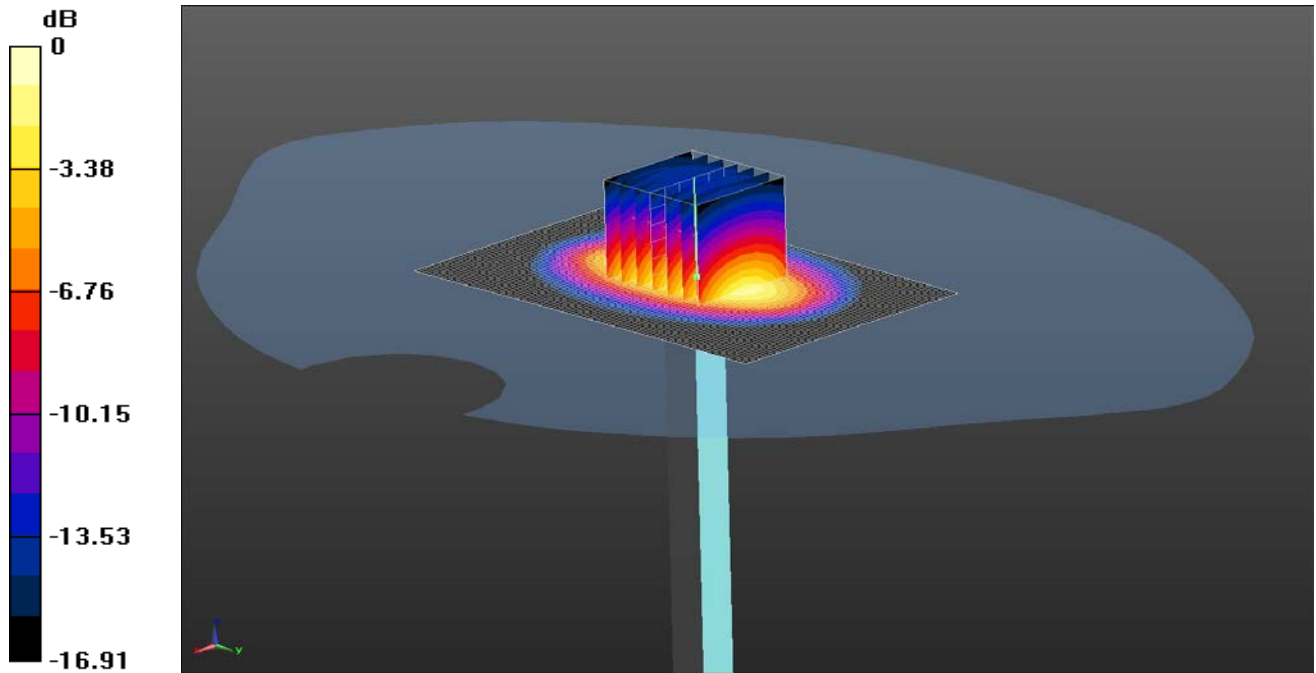

0 dB = 12.4 W/kg = 10.93 dBW/kg

Communication System: UID 0, CW (0); Frequency: 1750 MHz; Duty Cycle: 1:1

Medium: 900, 1750, 1800, 2600 5% MHz HSL Medium parameters used: $f = 1750$ MHz; $\sigma = 1.399$ S/m; $\epsilon_r = 39.653$; $\rho = 1000$ kg/m³

Phantom section: Flat Section

DASY4 Configuration:

- Probe: ES3DV3 - SN3360; ConvF(5.27, 5.27, 5.27); Calibrated: 17/08/2018;

- Sensor-Surface: 3mm (Mechanical Surface Detection)

- Electronics: DAE4 Sn1543; Calibrated: 08/03/2018

- Phantom: Twin SAM A (Site 65); Type: SAM 8.0; Serial: TP:1945

- ; SEMCAD X Version 14.6.10 (7417)

SAR/d=10mm, Pin=50 mW 2/Area Scan (61x91x1): Interpolated grid: dx=1.200 mm, dy=1.200 mm

Maximum value of SAR (interpolated) = 12.4 W/kg

SAR/d=10mm, Pin=50 mW 2/Zoom Scan 2 2 (7x7x7)/Cube 0: Measurement grid: dx=5mm, dy=5mm, dz=5mm

Reference Value = 97.18 V/m; Power Drift = -0.00 dB

Peak SAR (extrapolated) = 17.8 W/kg

SAR(1 g) = 9.72 W/kg; SAR(10 g) = 5.14 W/kg

Maximum value of SAR (measured) = 12.4 W/kg

CERTIFICATE OF CALIBRATION

ISSUED BY UL VS LTD

CERTIFICATE
NUMBER :
12134285JD01B

UKAS Accredited Calibration Laboratory No. 5248

Page 6 of 10

Impedance Measurement Plot for Head Stimulating Liquid (HSL)

10/12/2018 10:56:31 AM
1328.5170K92-100151-MV

Trc1 — S11 Smith 200 mU/ Ref 1 U Cal

1

M1 1.750000 GHz 50.453 Ω
-j1.521 Ω
59.778 pF

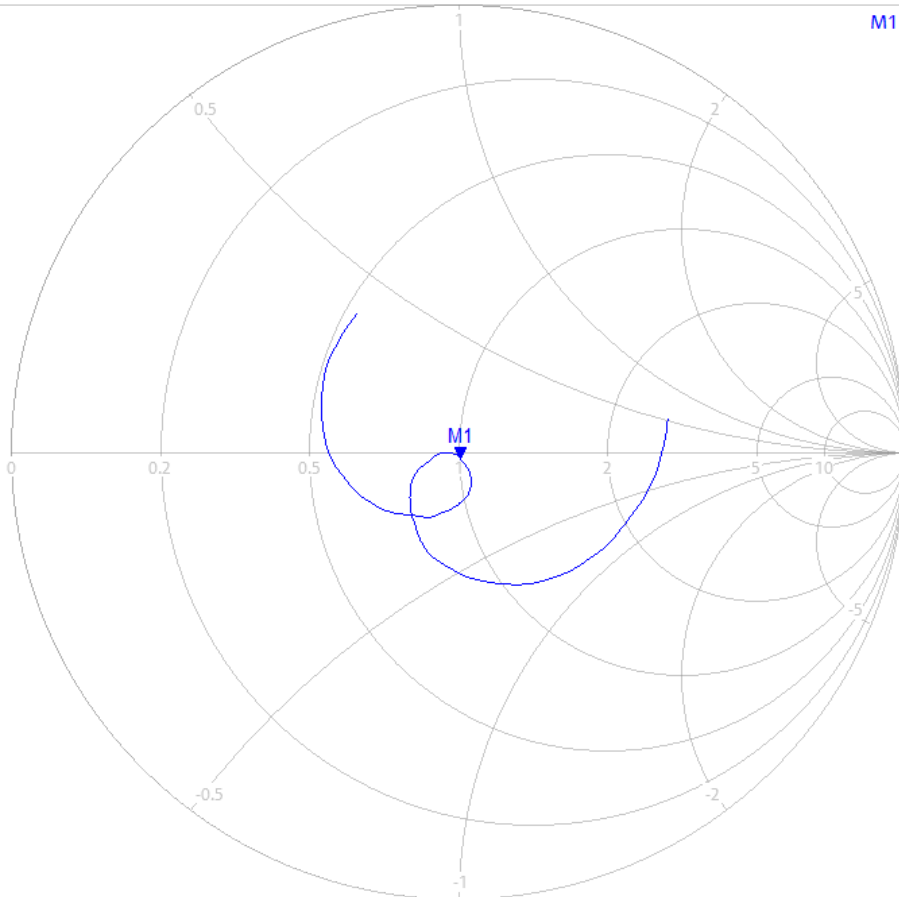

Ch1 Center 1.75 GHz

Pwr -10 dBm Bw 10 kHz

Span 400 MHz

CERTIFICATE OF CALIBRATION

ISSUED BY UL VS LTD

UKAS Accredited Calibration Laboratory No. 5248

CERTIFICATE
NUMBER :
12134285JD01B

Page 7 of 10

Return Loss Measurement Plot for Head Stimulating Liquid (HSL)

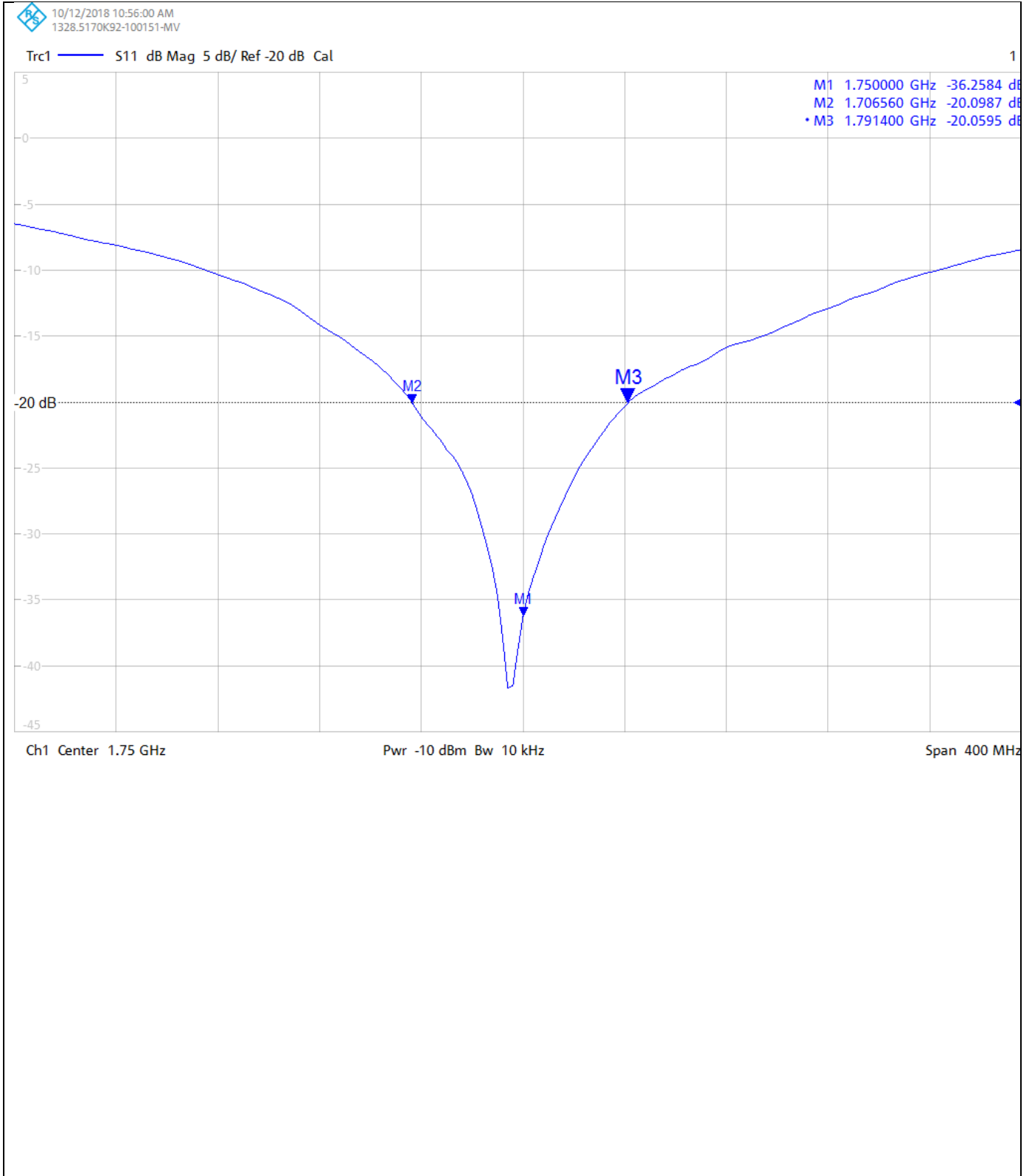

CERTIFICATE OF CALIBRATION

ISSUED BY UL VS LTD

CERTIFICATE
NUMBER :
12134285JD01B

UKAS Accredited Calibration Laboratory No. 5248

Page 8 of 10

DASY Validation Scan for Body Stimulating Liquid (MSL)

DUT: D1750V2 - SN1077; Type: D1750V2; Serial: SN1077

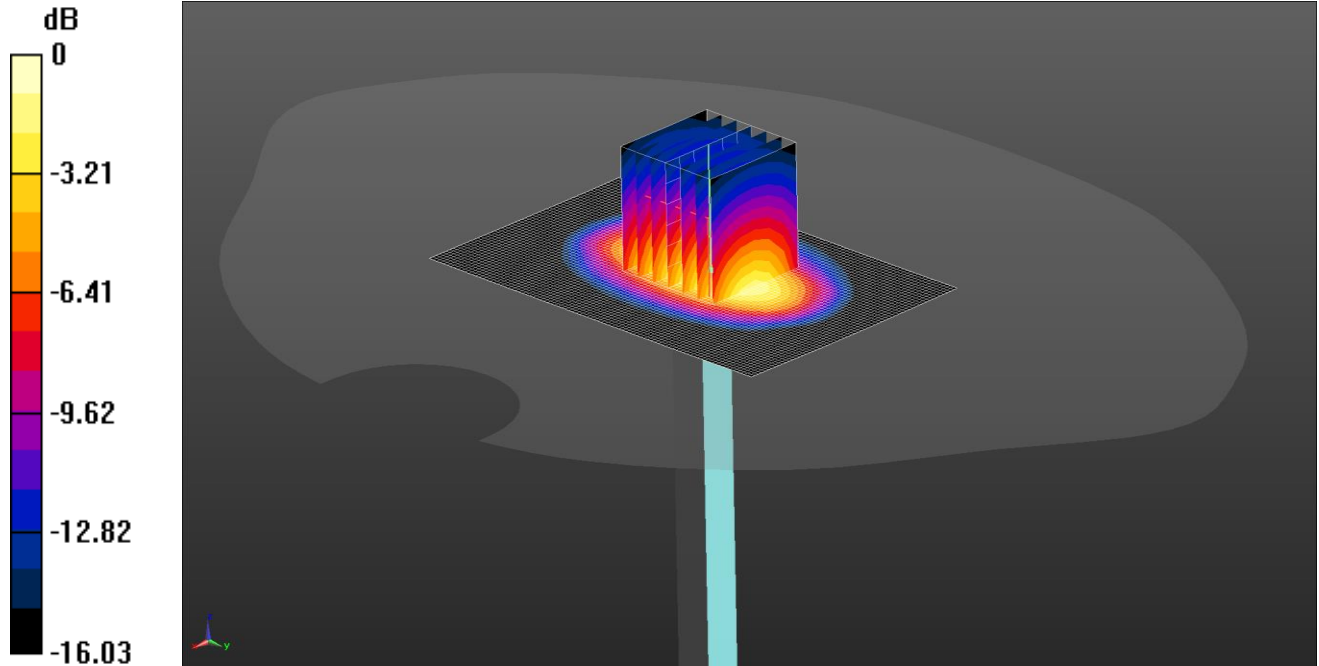

0 dB = 12.5 W/kg = 10.97 dBW/kg

Communication System: UID 0, CW (0); Frequency: 1750 MHz; Duty Cycle: 1:1
Medium: 900, 1750, 1800, 1900 5% MHz MSL Medium parameters used: $f = 1750$ MHz; $\sigma = 1.477$ S/m; $\epsilon_r = 53.299$; $\rho = 1000$ kg/m³

Phantom section: Flat Section

DASY4 Configuration:

- Probe: ES3DV3 - SN3360; ConvF(4.92, 4.92, 4.92); Calibrated: 17/08/2018;
- Sensor-Surface: 3mm (Mechanical Surface Detection)
- Electronics: DAE4 Sn1543; Calibrated: 08/03/2018
- Phantom: Twin SAM A (Site 65); Type: SAM 5.0; Serial: TP:1836
- ; SEMCAD X Version 14.6.10 (7417)

SAR/d=10mm, Pin=50 mW 2 2 /Area Scan (61x91x1): Interpolated grid: dx=1.200 mm, dy=1.200 mm

Maximum value of SAR (interpolated) = 13.0 W/kg

SAR/d=10mm, Pin=50 mW 2 2 /Zoom Scan 2 2 (7x7x7)/Cube 0: Measurement grid: dx=5mm, dy=5mm, dz=5mm

Reference Value = 94.90 V/m; Power Drift = 0.00 dB

Peak SAR (extrapolated) = 17.5 W/kg

SAR(1 g) = 9.87 W/kg; SAR(10 g) = 5.29 W/kg

Maximum value of SAR (measured) = 12.5 W/kg

CERTIFICATE OF CALIBRATION

ISSUED BY UL VS LTD

CERTIFICATE
NUMBER :
12134285JD01B

UKAS Accredited Calibration Laboratory No. 5248

Page 9 of 10

Impedance Measurement Plot for Body Stimulating Liquid (MSL)



10/15/2018 2:17:54 PM
1328.5170K92-100151-MV

Trc1 — S11 Smith 200 mU/ Ref 1 U Cal

1

M1 1.750000 GHz 49.460 Ω
j4.073 Ω
370.398 pF

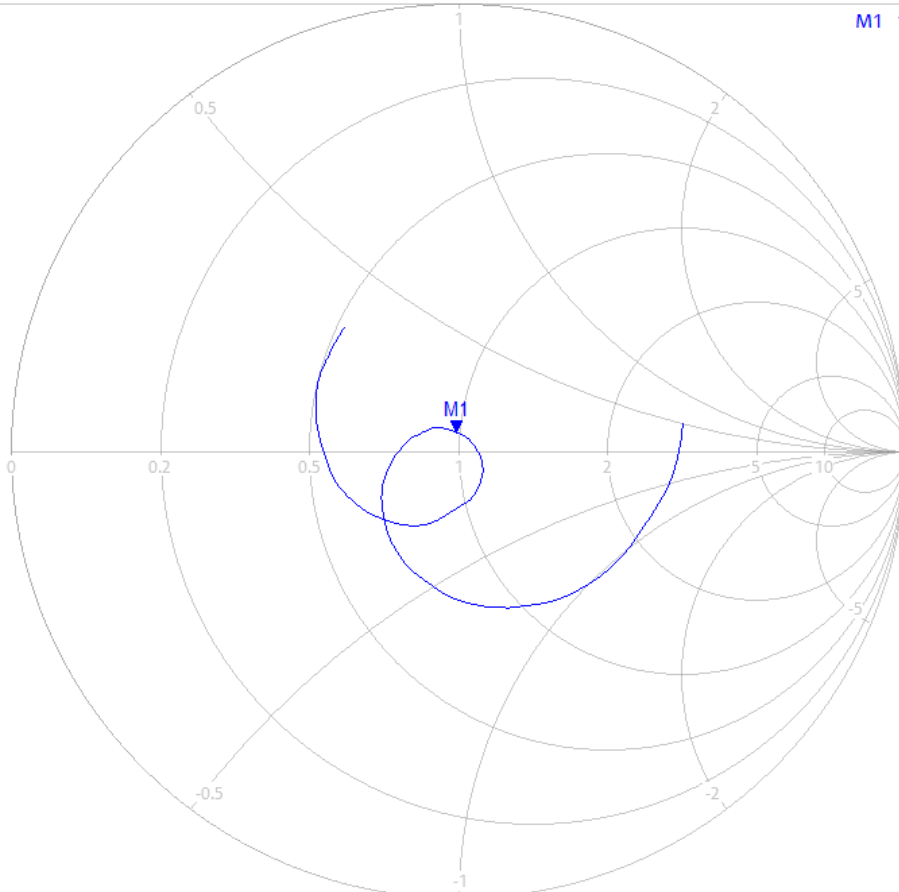

Ch1 Center 1.75 GHz

Pwr -10 dBm Bw 10 kHz

Span 400 MHz

CERTIFICATE OF CALIBRATION

ISSUED BY UL VS LTD

UKAS Accredited Calibration Laboratory No. 5248

CERTIFICATE
NUMBER :
12134285JD01B

Page 10 of 10

Return Loss Measurement Plot for Body Stimulating Liquid (MSL)

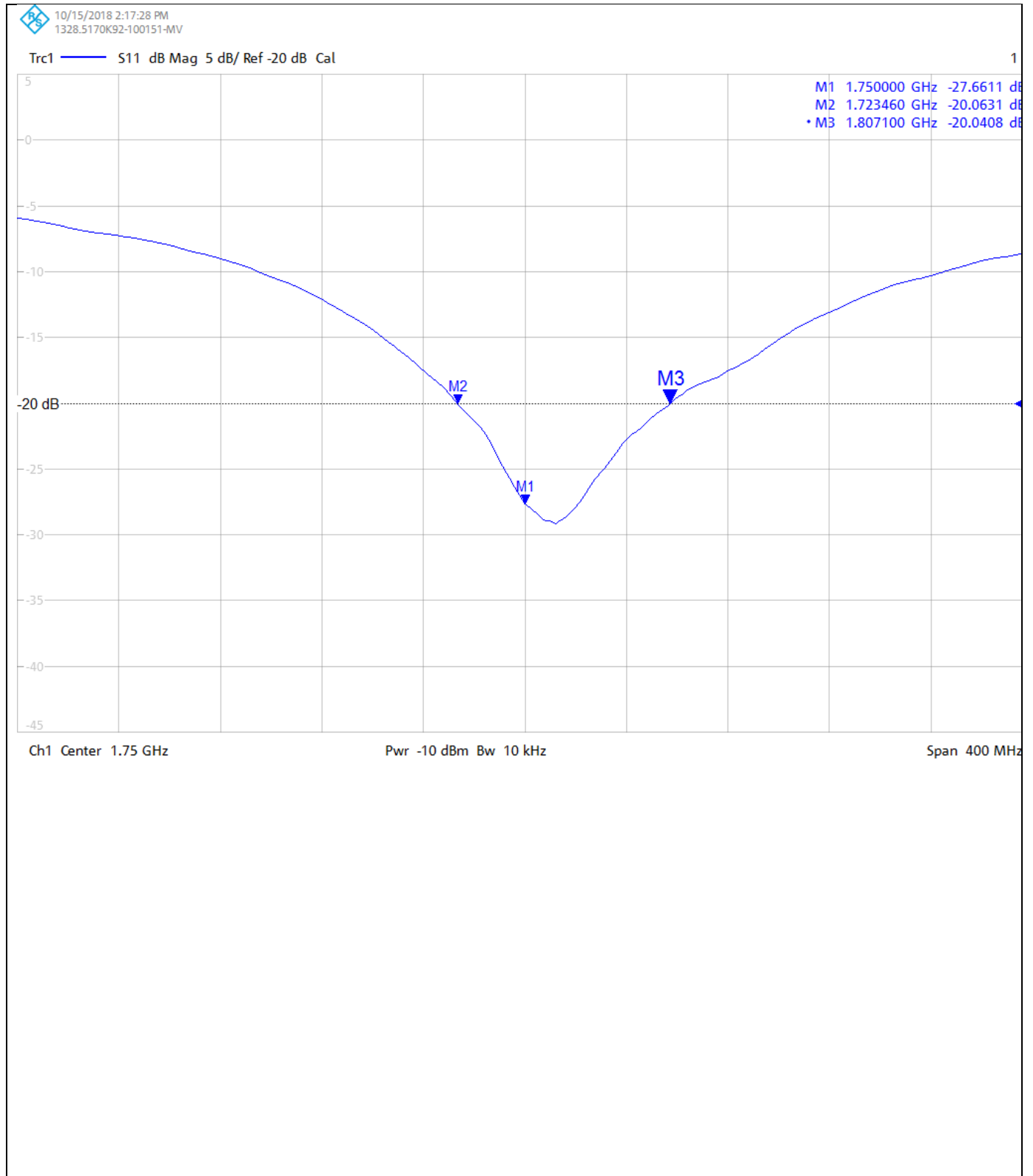

Calibration Certificate Label:

 <p>UKAS CALIBRATION 5248</p>	<p>UL VS LTD - Tel: +44 (0) 1256312000</p> <p>Certificate Number: 12134285JD01B</p> <p>Instrument ID: 1077</p> <p>Calibration Date: 16/Oct/2018</p> <p>Calibration Due Date:</p>
--	---

 <p>UKAS CALIBRATION 5248</p>	<p>UL VS LTD - Tel: +44 (0) 1256312000</p> <p>Certificate Number: 12134285JD01B</p> <p>Instrument ID: 1077</p> <p>Calibration Date: 16/Oct/2018</p> <p>Calibration Due Date:</p>
--	---

 <p>UKAS CALIBRATION 5248</p>	<p>UL VS LTD - Tel: +44 (0) 1256312000</p> <p>Certificate Number: 12134285JD01B</p> <p>Instrument ID: 1077</p> <p>Calibration Date: 16/Oct/2018</p> <p>Calibration Due Date:</p>
--	---

CERTIFICATE OF CALIBRATION

ISSUED BY **UL VS LTD**

DATE OF ISSUE: 16/Oct/2018

CERTIFICATE NUMBER : 12134285JD01D



5248

UL VS LTD
UNIT 1 HORIZON
KINGSLAND PARK, WADE ROAD
BASINGSTOKE, HAMPSHIRE
RG24 8AH, UK
TEL: +44 (0) 1256 312000
FAX: +44 (0) 1256 312001
Email: LST.UK.Calibration@ul.com



Page 1 of 10

APPROVED SIGNATORY

.....
Naseer Mirza

Customer :

UL VS Inc
47173 Benicia Street
Fremont, CA 94538, USA

Equipment Details:

Description:	Dipole Validation Kit	Date of Receipt:	08/Oct/2018
Manufacturer:	SPEAG		
Type/Model Number:	D1900V2		
Serial Number:	5d163		
Calibration Date:	16/Oct/2018		
Calibrated By:	Chanthu Thevarajah Senior Engineer		

Signature:

.....

All Calibration have been conducted in the closed laboratory facility: Lab Temperature (22±3) °C and humidity < 70%

This certificate is issued in accordance with the laboratory accreditation requirements of the United Kingdom Accreditation Service. It provides traceability of measurement to the SI system of units and/or to units of measurement realised at the National Physical Laboratory or other recognised national metrology institutes. This certificate may not be reproduced other than in full, except with the prior written approval of the issuing laboratory.

Use of the UKAS mark demonstrates that compliance with the requirements of BS/EN/ISO/IEC 17025 has been independently assessed.

CERTIFICATE OF CALIBRATION

ISSUED BY UL VS LTD

UKAS Accredited Calibration Laboratory No. 5248

CERTIFICATE
NUMBER :
12134285JD01D

Page 2 of 10

The calibration methods and procedures used were as detailed in:

1. **IEC 62209-1:2016:** Procedure to determine the specific absorption rate (SAR) for hand-held devices used in close proximity to the ear (frequency range of 300 MHz to 3 GHz)
2. **IEC 62209-2:2010:** Procedure to determine the specific absorption rate (SAR) for wireless communication devices used in close proximity to the human body (frequency range of 30 MHz to 6 GHz)
3. **IEEE 1528: 2013:** IEEE Recommended Practice for Determining the Peak Spatial-Average Specific Absorption Rate (SAR) in the Human Head from Wireless Communication Devices: Measurement Techniques
4. FCC KDB Publication Number: “**KDB865664 D01 SAR Measurement 100 MHz to 6 GHz**”
5. **SPEAG DASY4/ DASY5 System Handbook**

The measuring equipment used to perform the calibration, documented in this certificate has been calibrated in accordance with the manufacturers' recommendations, and is traceable to recognized national standards.

UL No.	Instrument	Manufacturer	Type No.	Serial No.	Date Last Calibrated	Cal. Interval (Months)
PRE0178318	Data Acquisition Electronics	SPEAG	DAE4	1543	08 Mar 2018	12
PRE0178315	Probe	SPEAG	ES3DV3	3360	17 Aug 2018	12
PRE0178326	Dipole	SPEAG	D1900V2	5d227	07 Mar 2018	12
PRE0151451	Power Monitoring Kit	Art-Fi	ART 100850-01	0001	Cal as part of System	12
PRE0151441	Power Sensor	Rhode & Schwarz	NRP8S	102481	05 Feb 2018	12
PRE0151154	Network Analyser	Rhode & Schwarz	ZND8	100151	14 Dec 2017	12
PRE0151877	Calibration Kit	Rhode & Schwarz	ZV-Z135	102947-Bt	27 Apr 2018	12
PRE0178154	Signal Generator	Rhode & Schwarz	SMB 100A	175325	09 Apr 2018	12

CERTIFICATE OF CALIBRATION

ISSUED BY **UL VS LTD**

UKAS Accredited Calibration Laboratory No. 5248

CERTIFICATE
NUMBER :
12134285JD01D

Page 3 of 10

SAR System Specification

Robot System Positioner:	Stäubli Unimation Corp. Robot Model: TX60L
Robot Serial Number:	F17/5ENYG1/A/01
DASY Version:	DASY 52 (v52.8.8.1258)
Phantom:	Flat section of SAM Twin Phantom
Distance Dipole Centre:	10 mm (with spacer)
Frequency:	1900 MHz

Dielectric Property Measurements – Head Simulating Liquid (HSL)

Simulant Liquid	Frequency (MHz)	Room Temp		Liquid Temp		Parameters	Target Value	Measured Value	Uncertainty (%)
		Start	End	Start	End				
Head	1900	22.0 °C	22.0 °C	21.1°C	21.5°C	ϵ_r	40.00	39.71	± 5%
						σ	1.40	1.44	± 5%

SAR Results – Head Simulating Liquid (HSL)

Simulant Liquid	SAR Measured	250 mW input Power	Normalised to 1.00 W	Uncertainty (%)
Head	SAR averaged over 1g	10.60 W/Kg	42.19 W/Kg	± 17.57%
	SAR averaged over 10g	5.46 W/Kg	21.73 W/Kg	± 17.32%

Antenna Parameters – Head Simulating Liquid (HSL)

Simulant Liquid	Parameter	Measured Level	Uncertainty (%)
Head	Impedance	47.246 Ω -3.29 $j\Omega$	± 0.28 Ω ± 0.044 $j\Omega$
	Return Loss	27.20	± 2.03 dB

CERTIFICATE OF CALIBRATION

ISSUED BY **UL VS LTD**

UKAS Accredited Calibration Laboratory No. 5248

CERTIFICATE
NUMBER :
12134285JD01D

Page 4 of 10

Dielectric Property Measurements – Body Simulating Liquid (MSL)

Simulant Liquid	Frequency (MHz)	Room Temp		Liquid Temp		Parameters	Target Value	Measured Value	Uncertainty (%)
		Start	End	Start	End				
Body	1900	20.0 °C	21.0 °C	19.9°C	20.5°C	ϵ_r	53.30	53.10	± 5%
						σ	1.52	1.58	± 5%

SAR Results – Body Simulating Liquid (MSL)

Simulant Liquid	SAR Measured	250 mW input Power	Normalised to 1.00 W	Uncertainty (%)
Body	SAR averaged over 1g	10.70 W/Kg	42.59 W/Kg	± 18.06%
	SAR averaged over 10g	5.57 W/Kg	22.17 W/Kg	± 17.44%

Antenna Parameters – Body Simulating Liquid (MSL)

Simulant Liquid	Parameter	Measured Level	Uncertainty (%)
Body	Impedance	52.08 Ω -5.44 j Ω	± 0.28 Ω ± 0.044 j Ω
	Return Loss	25.11	± 2.03 dB

CERTIFICATE OF CALIBRATION

ISSUED BY UL VS LTD

CERTIFICATE
NUMBER :
12134285JD01D

UKAS Accredited Calibration Laboratory No. 5248

Page 5 of 10

DASY Validation Scan for Head Stimulating Liquid (HSL)

DUT: D1900V2 - SN5d163; Type: D1900V2; Serial: SN5d163

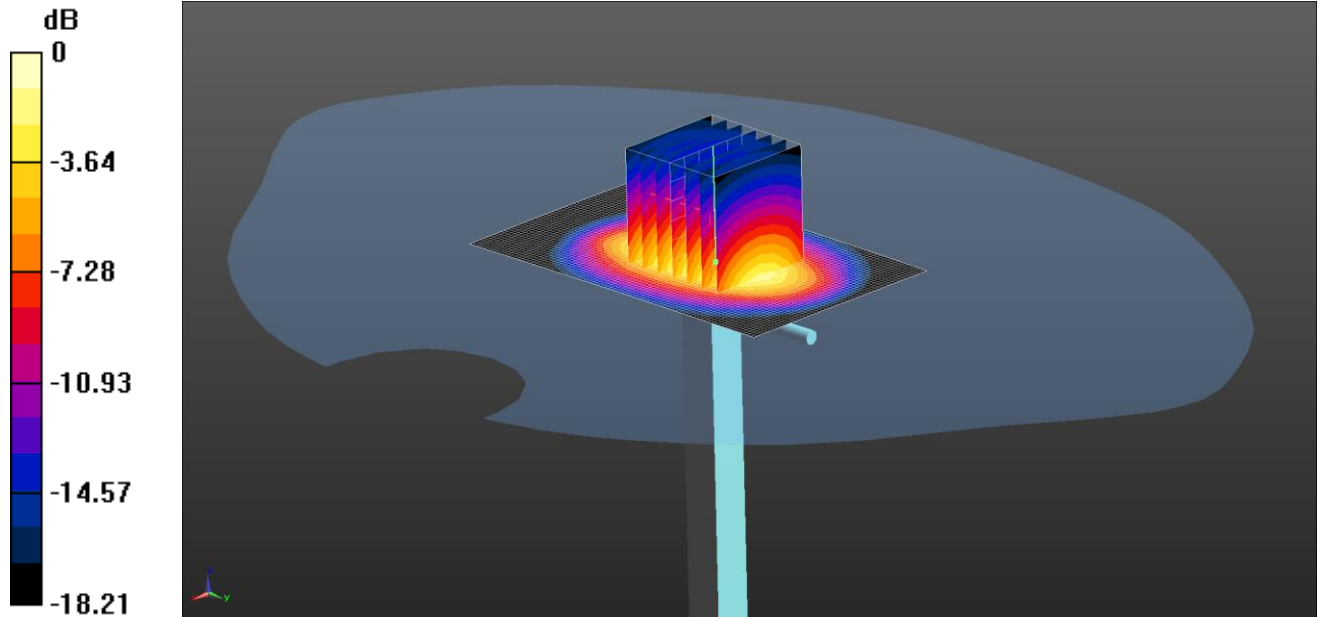

0 dB = 13.5 W/kg = 11.30 dBW/kg

Communication System: UID 0, CW (0); Frequency: 1900 MHz; Duty Cycle: 1:1
Medium: 1900 5% MHz HSL Medium parameters used: $f = 1900$ MHz; $\sigma = 1.444$ S/m; $\epsilon_r = 39.709$; $\rho = 1000$ kg/m³
Phantom section: Flat Section

DASY4 Configuration:

- Probe: ES3DV3 - SN3360; ConvF(5.11, 5.11, 5.11); Calibrated: 17/08/2018;
- Sensor-Surface: 3mm (Mechanical Surface Detection)
- Electronics: DAE4 Sn1543; Calibrated: 08/03/2018
- Phantom: Twin SAM A (Site 65); Type: SAM 8.0; Serial: TP:1945
- ; SEMCAD X Version 14.6.10 (7417)

SAR/d=10mm, Pin=250mW/Area Scan (51x81x1): Interpolated grid: dx=1.200 mm, dy=1.200 mm

Maximum value of SAR (interpolated) = 13.8 W/kg

SAR/d=10mm, Pin=250mW/Zoom Scan (7x7x7)/Cube 0: Measurement grid: dx=5mm, dy=5mm, dz=5mm

Reference Value = 100.1 V/m; Power Drift = -0.04 dB

Peak SAR (extrapolated) = 19.9 W/kg

SAR(1 g) = 10.6 W/kg; SAR(10 g) = 5.46 W/kg

Maximum value of SAR (measured) = 13.5 W/kg

CERTIFICATE OF CALIBRATION

ISSUED BY UL VS LTD

CERTIFICATE
NUMBER :
12134285JD01D

UKAS Accredited Calibration Laboratory No. 5248

Page 6 of 10

Impedance Measurement Plot for Head Stimulating Liquid (HSL)

10/12/2018 10:39:17 AM
1328.5170K92-100151-MV

Trc1 — S11 Smith 200 mU/ Ref 1 U Cal

1

M1 1.900000 GHz 47.246 Ω
-j3.287 Ω
25.480 pF

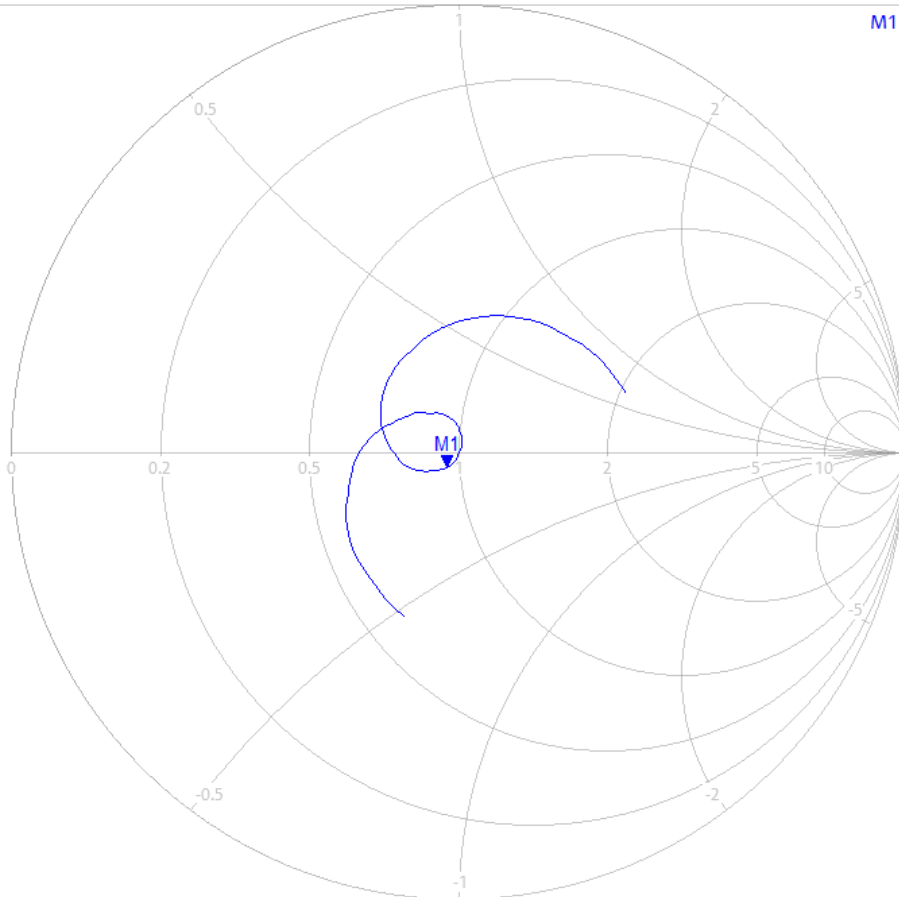

Ch1 Start 1.7 GHz

Pwr -10 dBm Bw 10 kHz

Stop 2.1 GHz

CERTIFICATE OF CALIBRATION

ISSUED BY UL VS LTD

UKAS Accredited Calibration Laboratory No. 5248

CERTIFICATE
NUMBER :
12134285JD01D

Page 7 of 10

Return Loss Measurement Plot for Head Stimulating Liquid (HSL)

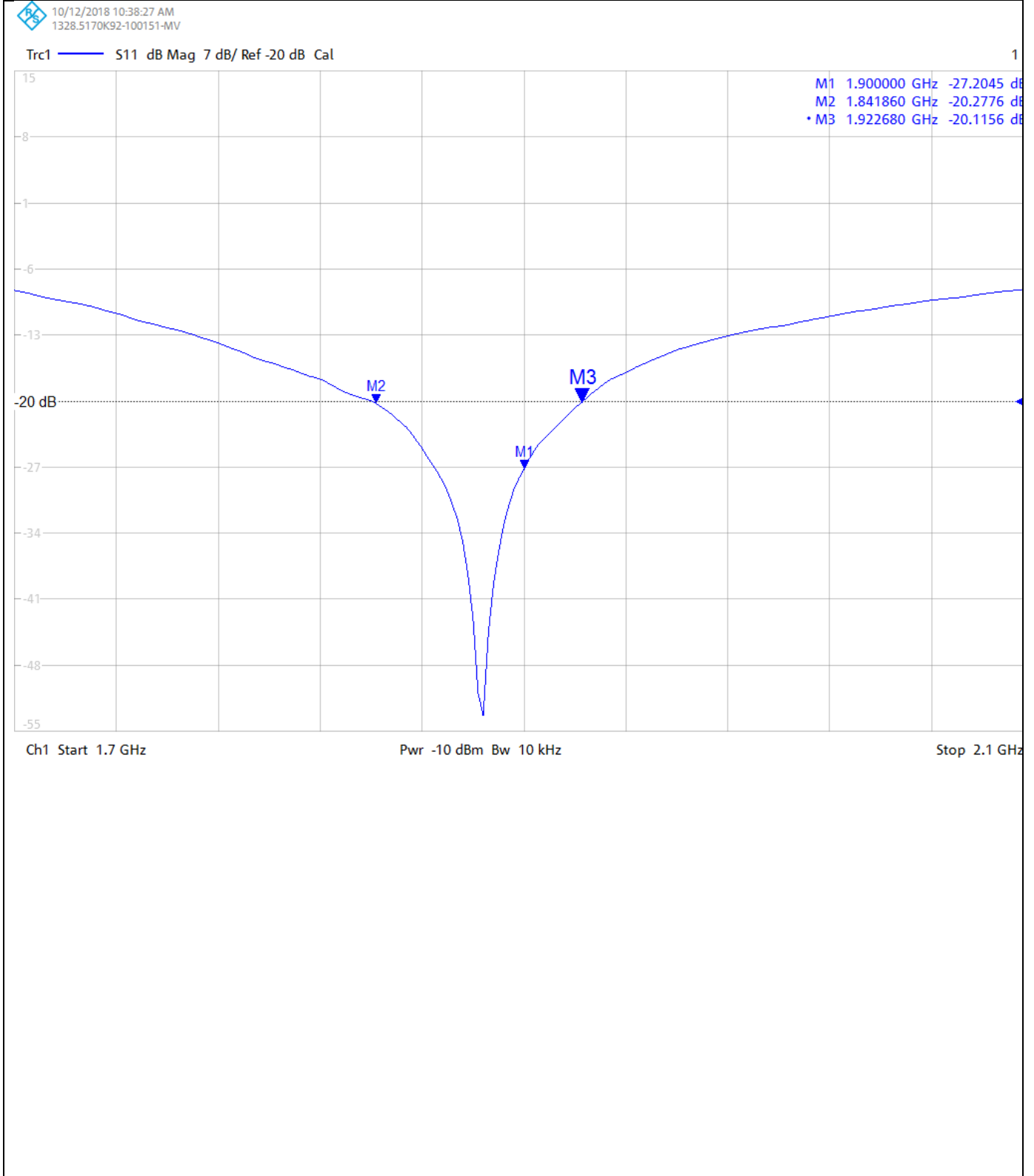

CERTIFICATE OF CALIBRATION

ISSUED BY UL VS LTD

CERTIFICATE
NUMBER :
12134285JD01D

UKAS Accredited Calibration Laboratory No. 5248

Page 8 of 10

DASY Validation Scan for Body Stimulating Liquid (MSL)

DUT: D1900V2 - SN5d163; Type: D1900V2; Serial: SN5d163

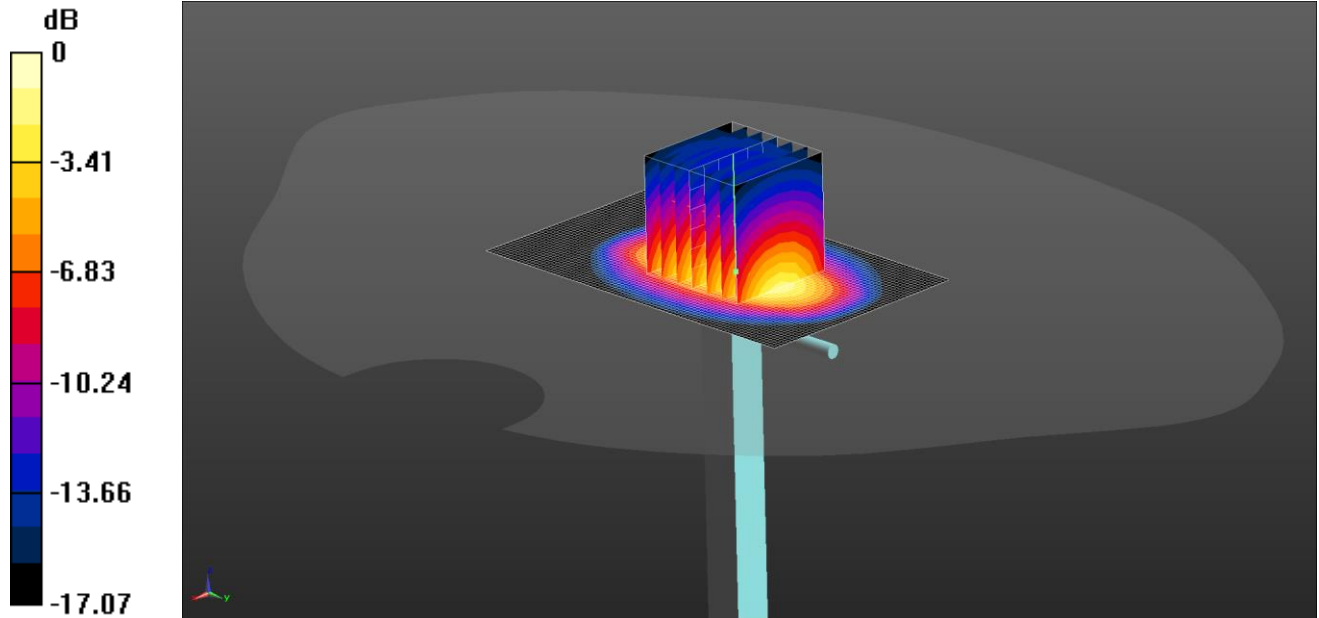

0 dB = 13.7 W/kg = 11.37 dBW/kg

Communication System: UID 0, CW (0); Frequency: 1900 MHz; Duty Cycle: 1:1
Medium: 900, 1750, 1800, 1900 5% MHz MSL Medium parameters used: $f = 1900$ MHz; $\sigma = 1.583$ S/m; $\epsilon_r = 53.097$; $\rho = 1000$ kg/m³

Phantom section: Flat Section

DASY4 Configuration:

- Probe: ES3DV3 - SN3360; ConvF(4.77, 4.77, 4.77); Calibrated: 17/08/2018;
- Sensor-Surface: 3mm (Mechanical Surface Detection)
- Electronics: DAE4 Sn1543; Calibrated: 08/03/2018
- Phantom: Twin SAM A (Site 65); Type: SAM 5.0; Serial: TP:1836
- ; SEMCAD X Version 14.6.10 (7417)

SAR/d=10mm, Pin=250mW/Area Scan (51x81x1): Interpolated grid: dx=1.200 mm, dy=1.200 mm

Maximum value of SAR (interpolated) = 14.3 W/kg

SAR/d=10mm, Pin=250mW/Zoom Scan (7x7x7)/Cube 0: Measurement grid: dx=5mm, dy=5mm, dz=5mm

Reference Value = 3.856 V/m; Power Drift = 0.19 dB

Peak SAR (extrapolated) = 19.2 W/kg

SAR(1 g) = 10.7 W/kg; SAR(10 g) = 5.57 W/kg

Maximum value of SAR (measured) = 13.7 W/kg

CERTIFICATE OF CALIBRATION

ISSUED BY UL VS LTD

CERTIFICATE
NUMBER :
12134285JD01D

UKAS Accredited Calibration Laboratory No. 5248

Page 9 of 10

Impedance Measurement Plot for Body Stimulating Liquid (MSL)



10/15/2018 2:06:28 PM
1328.5170K92-100151-MV

Trc1 — S11 Smith 200 mU/ Ref 1 U Cal

1

M1 1.900000 GHz 52.082 Ω
-j5.437 Ω
15.408 pF

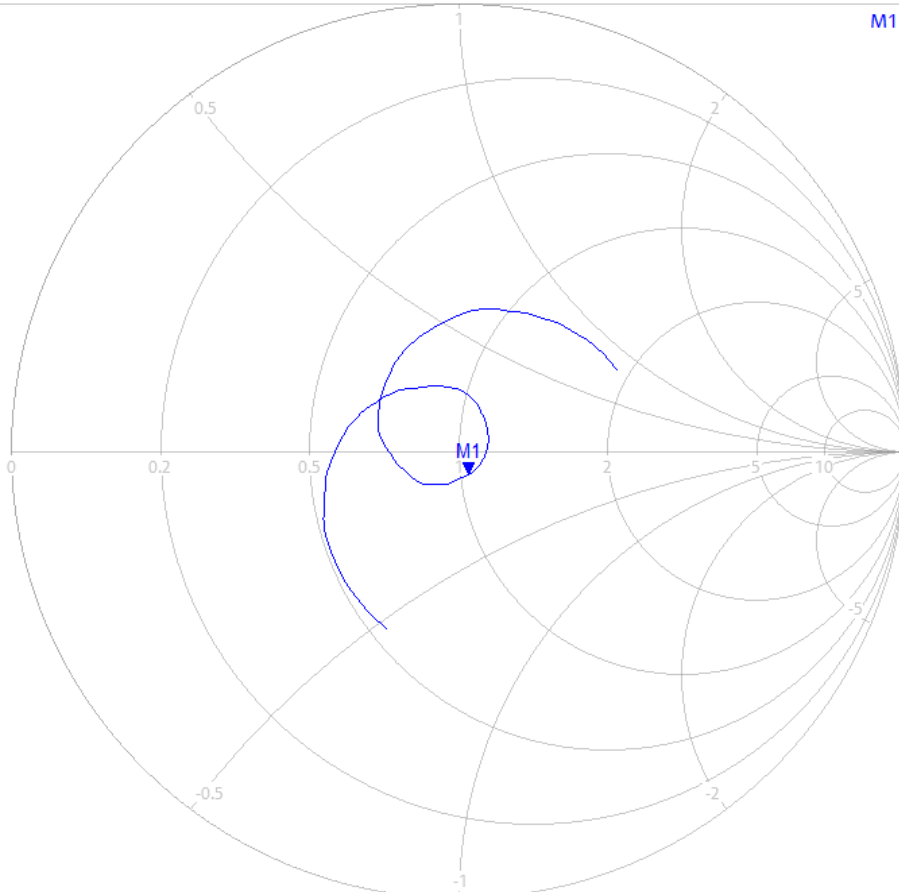

Ch1 Center 1.9 GHz

Pwr -10 dBm Bw 10 kHz

Span 400 MHz

CERTIFICATE OF CALIBRATION

ISSUED BY UL VS LTD

UKAS Accredited Calibration Laboratory No. 5248

CERTIFICATE
NUMBER :
12134285JD01D

Page 10 of 10

Return Loss Measurement Plot for Body Stimulating Liquid (MSL)

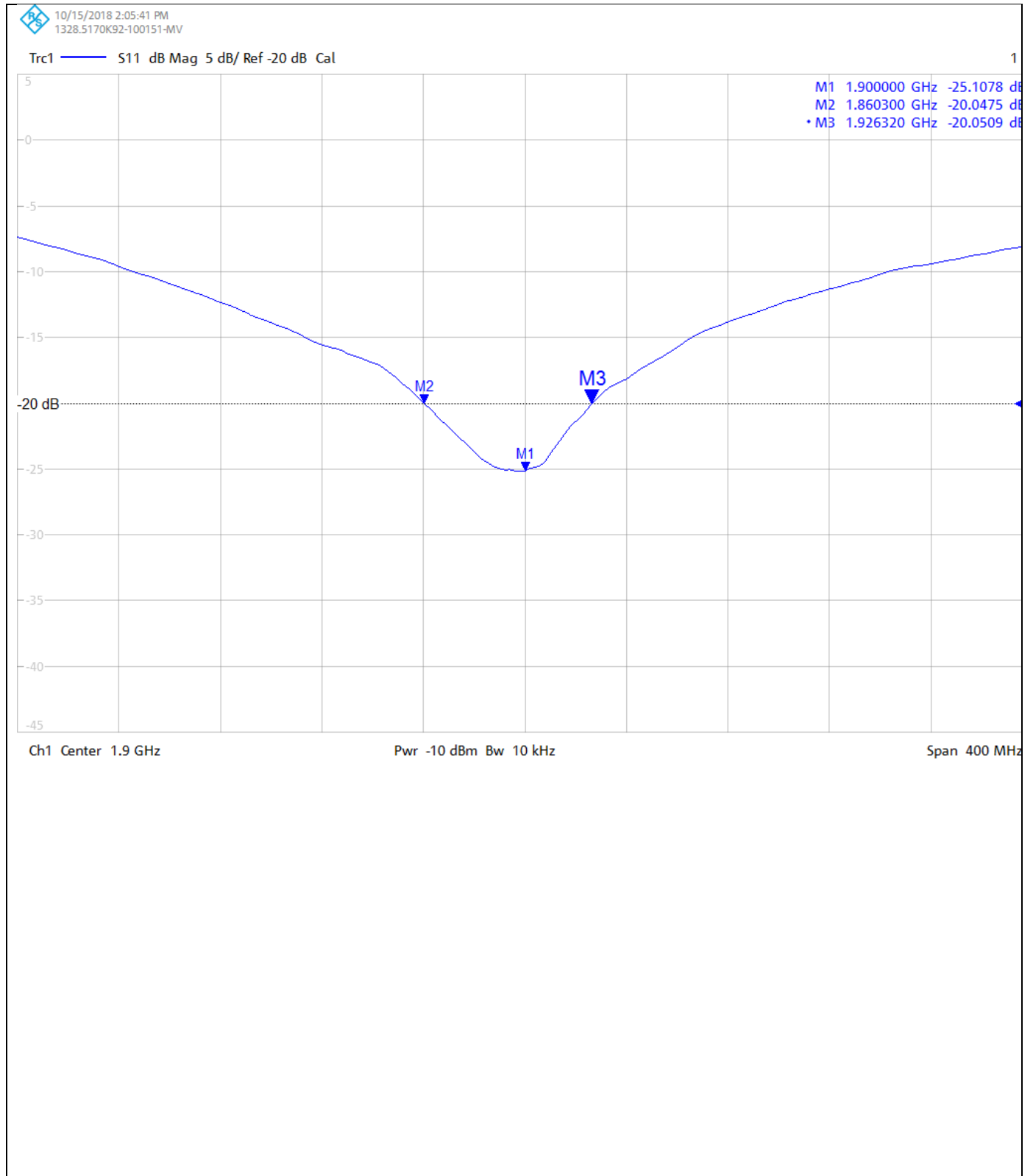

Calibration Certificate Label:

 <p>UKAS CALIBRATION 5248</p>	<p>UL VS LTD - Tel: +44 (0) 1256312000</p> <p>Certificate Number: 12134285JD01D</p> <p>Instrument ID: 5d163</p> <p>Calibration Date: 16/Oct/2018</p> <p>Calibration Due Date:</p>
--	--

 <p>UKAS CALIBRATION 5248</p>	<p>UL VS LTD - Tel: +44 (0) 1256312000</p> <p>Certificate Number: 12134285JD01D</p> <p>Instrument ID: 5d163</p> <p>Calibration Date: 16/Oct/2018</p> <p>Calibration Due Date:</p>
--	--

 <p>UKAS CALIBRATION 5248</p>	<p>UL VS LTD - Tel: +44 (0) 1256312000</p> <p>Certificate Number: 12134285JD01D</p> <p>Instrument ID: 5d163</p> <p>Calibration Date: 16/Oct/2018</p> <p>Calibration Due Date:</p>
--	--



Accredited by the Swiss Accreditation Service (SAS)
The Swiss Accreditation Service is one of the signatories to the EA
Multilateral Agreement for the recognition of calibration certificates

Accreditation No.: **SCS 0108**

Client **UL CCS USA**

Certificate No: **D1900V2-5d140_Apr19**

CALIBRATION CERTIFICATE

Object **D1900V2 - SN:5d140**

Calibration procedure(s) **QA CAL-05.v11
Calibration Procedure for SAR Validation Sources between 0.7-3 GHz**

Calibration date: **April 17, 2019**

This calibration certificate documents the traceability to national standards, which realize the physical units of measurements (SI).
The measurements and the uncertainties with confidence probability are given on the following pages and are part of the certificate.

All calibrations have been conducted in the closed laboratory facility: environment temperature (22 ± 3)°C and humidity < 70%.

Calibration Equipment used (M&TE critical for calibration)

Primary Standards	ID #	Cal Date (Certificate No.)	Scheduled Calibration
Power meter NRP	SN: 104778	03-Apr-19 (No. 217-02892/02893)	Apr-20
Power sensor NRP-Z91	SN: 103244	03-Apr-19 (No. 217-02892)	Apr-20
Power sensor NRP-Z91	SN: 103245	03-Apr-19 (No. 217-02893)	Apr-20
Reference 20 dB Attenuator	SN: 5058 (20k)	04-Apr-19 (No. 217-02894)	Apr-20
Type-N mismatch combination	SN: 5047.2 / 06327	04-Apr-19 (No. 217-02895)	Apr-20
Reference Probe EX3DV4	SN: 7349	31-Dec-18 (No. EX3-7349_Dec18)	Dec-19
DAE4	SN: 601	04-Oct-18 (No. DAE4-601_Oct18)	Oct-19

Secondary Standards	ID #	Check Date (in house)	Scheduled Check
Power meter E4419B	SN: GB39512475	07-Oct-15 (in house check Feb-19)	In house check: Oct-20
Power sensor HP 8481A	SN: US37292783	07-Oct-15 (in house check Oct-18)	In house check: Oct-20
Power sensor HP 8481A	SN: MY41092317	07-Oct-15 (in house check Oct-18)	In house check: Oct-20
RF generator R&S SMT-06	SN: 100972	15-Jun-15 (in house check Oct-18)	In house check: Oct-20
Network Analyzer Agilent E8358A	SN: US41080477	31-Mar-14 (in house check Oct-18)	In house check: Oct-19

Calibrated by: **Michael Weber** Name: Michael Weber Function: Laboratory Technician Signature:

Approved by: **Katja Pokovic** Name: Katja Pokovic Function: Technical Manager Signature:

Issued: April 18, 2019

This calibration certificate shall not be reproduced except in full without written approval of the laboratory.



Accredited by the Swiss Accreditation Service (SAS)

The Swiss Accreditation Service is one of the signatories to the EA
Multilateral Agreement for the recognition of calibration certificates

Glossary:

TSL	tissue simulating liquid
ConvF	sensitivity in TSL / NORM x,y,z
N/A	not applicable or not measured

Calibration is Performed According to the Following Standards:

- IEEE Std 1528-2013, "IEEE Recommended Practice for Determining the Peak Spatial-Averaged Specific Absorption Rate (SAR) in the Human Head from Wireless Communications Devices: Measurement Techniques", June 2013
- IEC 62209-1, "Measurement procedure for the assessment of Specific Absorption Rate (SAR) from hand-held and body-mounted devices used next to the ear (frequency range of 300 MHz to 6 GHz)", July 2016
- IEC 62209-2, "Procedure to determine the Specific Absorption Rate (SAR) for wireless communication devices used in close proximity to the human body (frequency range of 30 MHz to 6 GHz)", March 2010
- KDB 865664, "SAR Measurement Requirements for 100 MHz to 6 GHz"

Additional Documentation:

- DASY4/5 System Handbook

Methods Applied and Interpretation of Parameters:

- Measurement Conditions:** Further details are available from the Validation Report at the end of the certificate. All figures stated in the certificate are valid at the frequency indicated.
- Antenna Parameters with TSL:** The dipole is mounted with the spacer to position its feed point exactly below the center marking of the flat phantom section, with the arms oriented parallel to the body axis.
- Feed Point Impedance and Return Loss:** These parameters are measured with the dipole positioned under the liquid filled phantom. The impedance stated is transformed from the measurement at the SMA connector to the feed point. The Return Loss ensures low reflected power. No uncertainty required.
- Electrical Delay:** One-way delay between the SMA connector and the antenna feed point. No uncertainty required.
- SAR measured:** SAR measured at the stated antenna input power.
- SAR normalized:** SAR as measured, normalized to an input power of 1 W at the antenna connector.
- SAR for nominal TSL parameters:** The measured TSL parameters are used to calculate the nominal SAR result.

The reported uncertainty of measurement is stated as the standard uncertainty of measurement multiplied by the coverage factor $k=2$, which for a normal distribution corresponds to a coverage probability of approximately 95%.

Measurement Conditions

DASY system configuration, as far as not given on page 1.

DASY Version	DASY5	V52.10.2
Extrapolation	Advanced Extrapolation	
Phantom	Modular Flat Phantom	
Distance Dipole Center - TSL	10 mm	with Spacer
Zoom Scan Resolution	dx, dy, dz = 5 mm	
Frequency	1900 MHz \pm 1 MHz	

Head TSL parameters

The following parameters and calculations were applied.

	Temperature	Permittivity	Conductivity
Nominal Head TSL parameters	22.0 °C	40.0	1.40 mho/m
Measured Head TSL parameters	(22.0 \pm 0.2) °C	40.6 \pm 6 %	1.38 mho/m \pm 6 %
Head TSL temperature change during test	< 0.5 °C	----	----

SAR result with Head TSL

SAR averaged over 1 cm³ (1 g) of Head TSL	Condition	
SAR measured	250 mW input power	9.75 W/kg
SAR for nominal Head TSL parameters	normalized to 1W	39.5 W/kg \pm 17.0 % (k=2)

SAR averaged over 10 cm³ (10 g) of Head TSL	condition	
SAR measured	250 mW input power	5.11 W/kg
SAR for nominal Head TSL parameters	normalized to 1W	20.6 W/kg \pm 16.5 % (k=2)

Body TSL parameters

The following parameters and calculations were applied.

	Temperature	Permittivity	Conductivity
Nominal Body TSL parameters	22.0 °C	53.3	1.52 mho/m
Measured Body TSL parameters	(22.0 \pm 0.2) °C	53.9 \pm 6 %	1.50 mho/m \pm 6 %
Body TSL temperature change during test	< 0.5 °C	----	----

SAR result with Body TSL

SAR averaged over 1 cm³ (1 g) of Body TSL	Condition	
SAR measured	250 mW input power	10.0 W/kg
SAR for nominal Body TSL parameters	normalized to 1W	40.4 W/kg \pm 17.0 % (k=2)

SAR averaged over 10 cm³ (10 g) of Body TSL	condition	
SAR measured	250 mW input power	5.30 W/kg
SAR for nominal Body TSL parameters	normalized to 1W	21.3 W/kg \pm 16.5 % (k=2)

Appendix (Additional assessments outside the scope of SCS 0108)

Antenna Parameters with Head TSL

Impedance, transformed to feed point	49.3 Ω + 5.6 j Ω
Return Loss	- 25.0 dB

Antenna Parameters with Body TSL

Impedance, transformed to feed point	45.0 Ω + 5.6 j Ω
Return Loss	- 22.0 dB

General Antenna Parameters and Design

Electrical Delay (one direction)	1.204 ns
----------------------------------	----------

After long term use with 100W radiated power, only a slight warming of the dipole near the feedpoint can be measured.

The dipole is made of standard semirigid coaxial cable. The center conductor of the feeding line is directly connected to the second arm of the dipole. The antenna is therefore short-circuited for DC-signals. On some of the dipoles, small end caps are added to the dipole arms in order to improve matching when loaded according to the position as explained in the "Measurement Conditions" paragraph. The SAR data are not affected by this change. The overall dipole length is still according to the Standard.

No excessive force must be applied to the dipole arms, because they might bend or the soldered connections near the feedpoint may be damaged.

Additional EUT Data

Manufactured by	SPEAG
-----------------	-------

DASY5 Validation Report for Head TSL

Date: 17.04.2019

Test Laboratory: SPEAG, Zurich, Switzerland

DUT: Dipole 1900 MHz; Type: D1900V2; Serial: D1900V2 - SN: 5d140

Communication System: UID 0 - CW; Frequency: 1900 MHz

Medium parameters used: $f = 1900$ MHz; $\sigma = 1.38$ S/m; $\epsilon_r = 40.6$; $\rho = 1000$ kg/m³

Phantom section: Flat Section

Measurement Standard: DASY5 (IEEE/IEC/ANSI C63.19-2011)

DASY52 Configuration:

- Probe: EX3DV4 - SN7349; ConvF(8.26, 8.26, 8.26) @ 1900 MHz; Calibrated: 31.12.2018
- Sensor-Surface: 1.4mm (Mechanical Surface Detection)
- Electronics: DAE4 Sn601; Calibrated: 04.10.2018
- Phantom: Flat Phantom 5.0 (front); Type: QD 000 P50 AA; Serial: 1001
- DASY52 52.10.2(1495); SEMCAD X 14.6.12(7450)

Dipole Calibration for Head Tissue/Pin=250 mW, d=10mm/Zoom Scan (7x7x7)/Cube 0:

Measurement grid: dx=5mm, dy=5mm, dz=5mm

Reference Value = 109.1 V/m; Power Drift = 0.01 dB

Peak SAR (extrapolated) = 17.9 W/kg

SAR(1 g) = 9.75 W/kg; SAR(10 g) = 5.11 W/kg

Maximum value of SAR (measured) = 15.1 W/kg

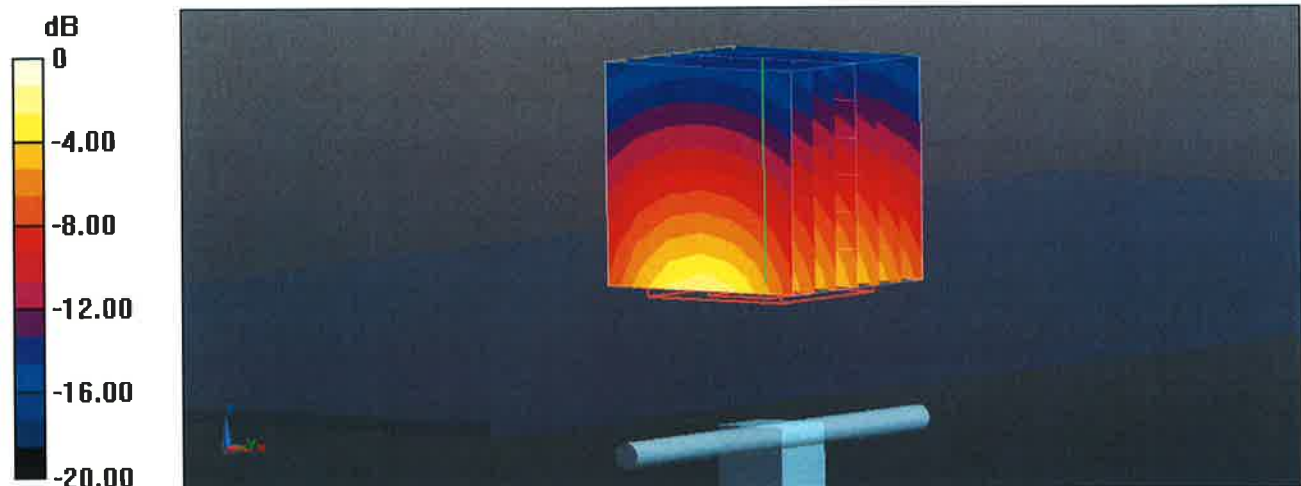

Impedance Measurement Plot for Head TSL

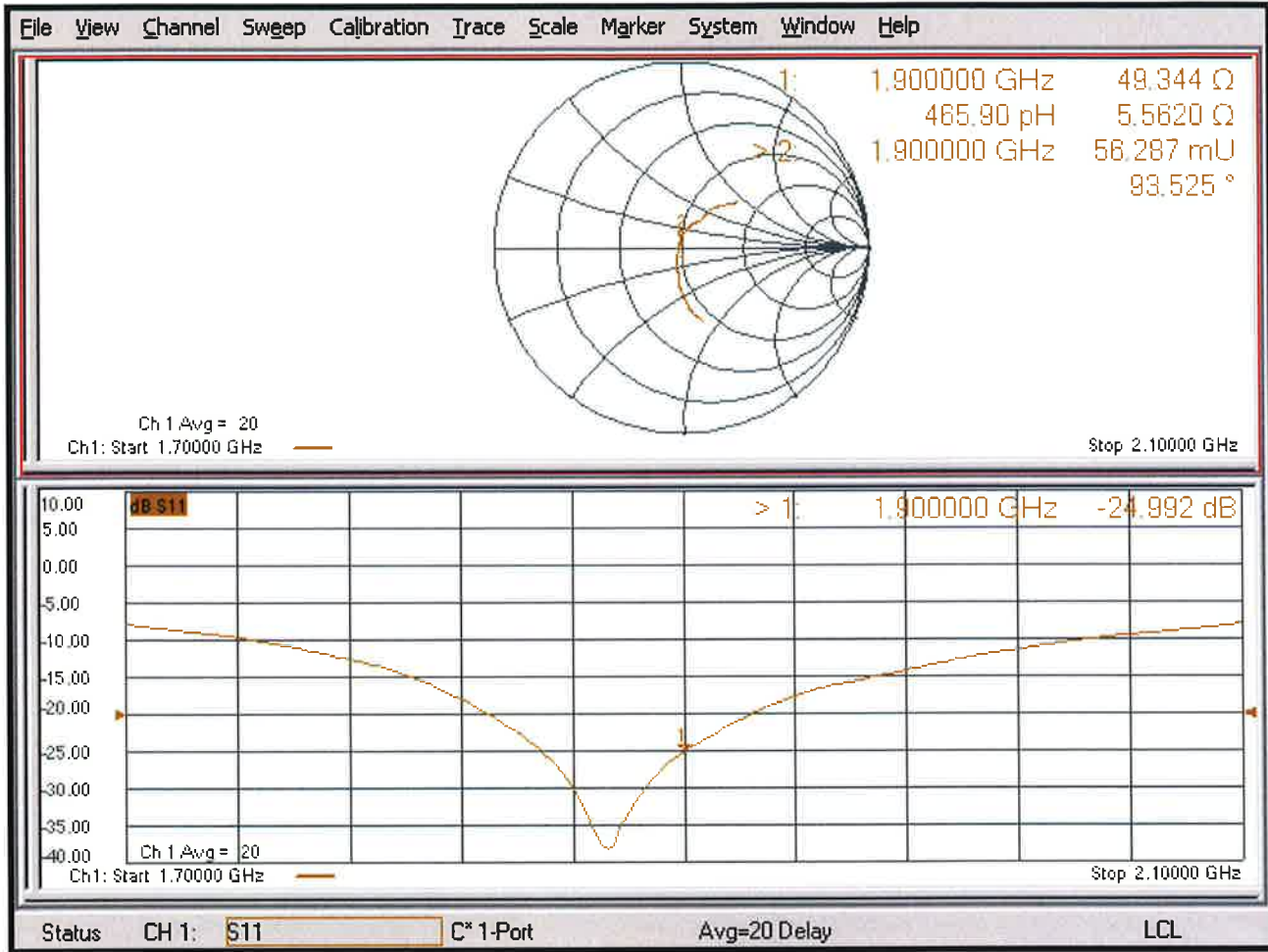

DASY5 Validation Report for Body TSL

Date: 17.04.2019

Test Laboratory: SPEAG, Zurich, Switzerland

DUT: Dipole 1900 MHz; Type: D1900V2; Serial: D1900V2 - SN: 5d140

Communication System: UID 0 - CW; Frequency: 1900 MHz

Medium parameters used: $f = 1900$ MHz; $\sigma = 1.5$ S/m; $\epsilon_r = 53.9$; $\rho = 1000$ kg/m³

Phantom section: Flat Section

Measurement Standard: DASY5 (IEEE/IEC/ANSI C63.19-2011)

DASY52 Configuration:

- Probe: EX3DV4 - SN7349; ConvF(8.23, 8.23, 8.23) @ 1900 MHz; Calibrated: 31.12.2018
- Sensor-Surface: 1.4mm (Mechanical Surface Detection)
- Electronics: DAE4 Sn601; Calibrated: 04.10.2018
- Phantom: Flat Phantom 5.0 (back); Type: QD 000 P50 AA; Serial: 1002
- DASY52 52.10.2(1495); SEMCAD X 14.6.12(7450)

Dipole Calibration for Body Tissue/Pin=250 mW, d=10mm/Zoom Scan (7x7x7)/Cube 0:

Measurement grid: dx=5mm, dy=5mm, dz=5mm

Reference Value = 105.8 V/m; Power Drift = -0.04 dB

Peak SAR (extrapolated) = 17.9 W/kg

SAR(1 g) = 10 W/kg; SAR(10 g) = 5.3 W/kg

Maximum value of SAR (measured) = 15.2 W/kg

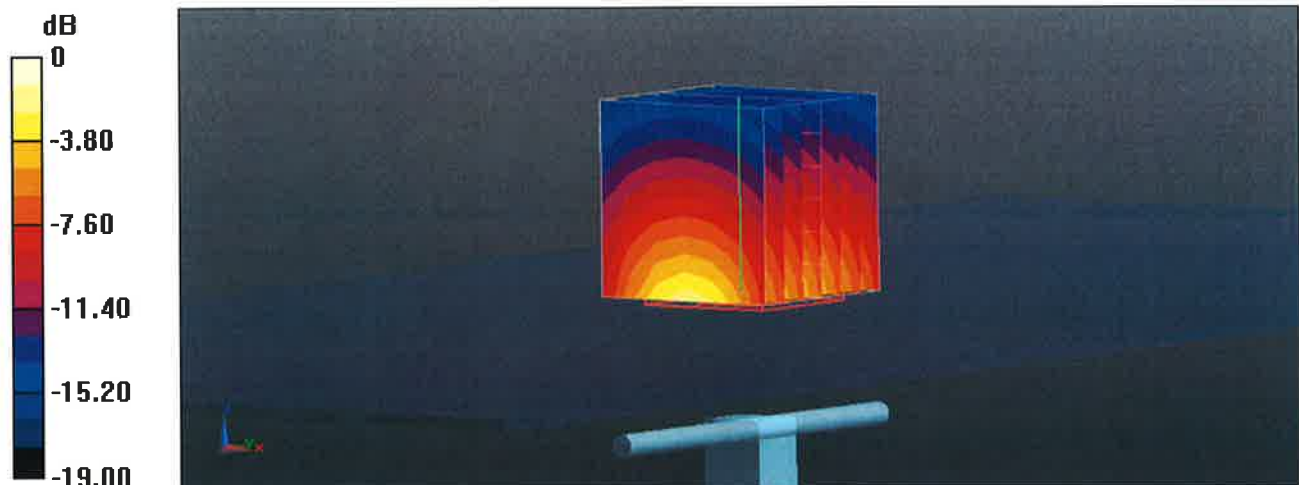

Impedance Measurement Plot for Body TSL

