



# **CERTIFICATION TEST REPORT**

**Report Number. :** 12258201-E3V2

**Applicant :** APPLE, INC.  
1 APPLE PARK WAY  
CUPERTINO, CA 95014, U.S.A.

**Model :** A2106

**FCC ID :** BCG-E3238A

**IC :** 579C-E3238A

**EUT Description :** SMARTPHONE

**Test Standard(s) :** FCC 47 CFR PART 15 SUBPART C  
ISED RSS-247 ISSUE 2

**Date Of Issue:**  
August 28, 2018

**Prepared by:**  
UL Verification Services Inc.  
47173 Benicia Street  
Fremont, CA 94538 U.S.A.  
TEL: (510) 771-1000  
FAX: (510) 661-0888



NVLAP Lab code: 200065-0

---

## REPORT REVISION HISTORY

Rev.	Issue Date	Revisions	Revised By
V1	8/22/2018	Initial Issue	Chin Pang
V2	8/28/2018	Address TCB questions	Jingang Li

## TABLE OF CONTENTS

<b>REPORT REVISION HISTORY .....</b>	<b>2</b>
<b>TABLE OF CONTENTS .....</b>	<b>3</b>
<b>1. ATTESTATION OF TEST RESULTS .....</b>	<b>5</b>
<b>2. TEST METHODOLOGY .....</b>	<b>6</b>
<b>3. FACILITIES AND ACCREDITATION .....</b>	<b>6</b>
<b>4. CALIBRATION AND UNCERTAINTY .....</b>	<b>7</b>
4.1. <i>MEASURING INSTRUMENT CALIBRATION .....</i>	<i>7</i>
4.2. <i>SAMPLE CALCULATION .....</i>	<i>7</i>
4.3. <i>MEASUREMENT UNCERTAINTY.....</i>	<i>7</i>
<b>5. EQUIPMENT UNDER TEST.....</b>	<b>8</b>
5.1. <i>EUT DESCRIPTION.....</i>	<i>8</i>
5.2. <i>MAXIMUM OUTPUT POWER.....</i>	<i>8</i>
5.3. <i>DESCRIPTION OF AVAILABLE ANTENNAS.....</i>	<i>8</i>
5.4. <i>SOFTWARE AND FIRMWARE.....</i>	<i>8</i>
5.5. <i>WORST-CASE CONFIGURATION AND MODE.....</i>	<i>9</i>
5.6. <i>DESCRIPTION OF TEST SETUP.....</i>	<i>10</i>
<b>6. MEASUREMENT METHOD.....</b>	<b>15</b>
<b>7. TEST AND MEASUREMENT EQUIPMENT .....</b>	<b>16</b>
<b>8. ANTENNA PORT TEST RESULTS .....</b>	<b>17</b>
8.1. <i>ON TIME AND DUTY CYCLE.....</i>	<i>17</i>
8.2. <i>99% BANDWIDTH.....</i>	<i>19</i>
8.2.1. <i>802.11b MODE .....</i>	<i>19</i>
8.2.2. <i>802.11n HT20 MODE .....</i>	<i>23</i>
8.2.3. <i>2TX Antenna 2 + Antenna 5 CDD MODE .....</i>	<i>29</i>
8.3. <i>6 dB BANDWIDTH.....</i>	<i>34</i>
8.3.1. <i>802.11b MODE .....</i>	<i>35</i>
8.3.2. <i>802.11n HT20 MODE .....</i>	<i>39</i>
8.3.3. <i>2TX Antenna 2 + Antenna 5 CDD MODE .....</i>	<i>45</i>
8.4. <i>OUTPUT POWER.....</i>	<i>50</i>
8.4.1. <i>802.11b MODE .....</i>	<i>52</i>
8.4.2. <i>802.11n HT20 MODE .....</i>	<i>54</i>
8.4.3. <i>2TX Antenna 2 + Antenna 5 CDD MODE .....</i>	<i>56</i>
8.5. <i>POWER SPECTRAL DENSITY.....</i>	<i>57</i>
8.5.1. <i>802.11b MODE .....</i>	<i>58</i>
8.5.2. <i>802.11n HT20 MODE .....</i>	<i>62</i>
8.5.3. <i>2TX Antenna 2 + Antenna 5 CDD MODE .....</i>	<i>68</i>

---

8.6.	<i>CONDUCTED SPURIOUS EMISSIONS</i> .....	73
8.6.1.	802.11b MODE .....	74
8.6.2.	802.11n HT20 MODE .....	78
8.6.3.	2TX Antenna 2 + Antenna 5 CDD MODE .....	84
<b>9.</b>	<b>RADIATED TEST RESULTS</b> .....	<b>92</b>
9.1.	<i>TRANSMITTER ABOVE 1 GHz</i> .....	93
9.1.1.	TX ABOVE 1 GHz 802.11b MODE IN THE 2.4 GHz BAND .....	93
9.1.2.	TX ABOVE 1 GHz 802.11n HT20 MODE IN THE 2.4 GHz BAND.....	125
9.1.3.	2TX Antenna 2 + Antenna 5 CDD MODE .....	157
9.2.	<i>Worst Case Below 1 GHz</i> .....	183
9.3.	<i>Worst Case 18-26 GHz</i> .....	185
<b>10.</b>	<b>AC POWER LINE CONDUCTED EMISSIONS</b> .....	<b>187</b>
10.1.1.	AC Power Line Host.....	188
10.1.2.	AC Power Line Norm .....	190
<b>11.</b>	<b>SETUP PHOTOS</b> .....	<b>192</b>

# 1. ATTESTATION OF TEST RESULTS

**COMPANY NAME:** APPLE, INC.  
1 APPLE PARK WAY  
CUPERTINO, CA 95014, U.S.A.

**EUT DESCRIPTION:** SMARTPHONE

**MODEL:** A2106

**SERIAL NUMBER:** C7CWW04EKJRC

**DATE TESTED:** MAY 29, 2018 – JULY 27, 2018

APPLICABLE STANDARDS	
STANDARD	TEST RESULTS
CFR 47 Part 15 Subpart C	Complies
ISED RSS-247 Issue 2	Complies
ISED RSS-GEN Issue 5	Complies

UL Verification Services Inc. tested the above equipment in accordance with the requirements set forth in the above standards. All indications of Pass/Fail in this report are opinions expressed by UL Verification Services Inc. based on interpretations and/or observations of test results. Measurement Uncertainties were not taken into account and are published for informational purposes only. The test results show that the equipment tested is capable of demonstrating compliance with the requirements as documented in this report.

**Note:** The results documented in this report apply only to the tested sample, under the conditions and modes of operation as described herein. This document may not be altered or revised in any way unless done so by UL Verification Services Inc. and all revisions are duly noted in the revisions section. Any alteration of this document not carried out by UL Verification Services Inc. will constitute fraud and shall nullify the document. This report must not be used by the client to claim product certification, approval, or endorsement by NVLAP, NIST, any agency of the Federal Government, or any agency of the U.S. government.

Approved & Released For  
UL Verification Services Inc. By:



Chin Pang  
CONSUMER TECHNOLOGY DIVISION  
Senior Engineer  
UL Verification Services Inc.

Prepared By:



Jingang Li  
CONSUMER TECHNOLOGY DIVISION  
Lab Engineer  
UL Verification Services Inc.

## 2. TEST METHODOLOGY

The tests documented in this report were performed in accordance with FCC CFR 47 Part 2, FCC CFR 47 Part 15, KDB 558074 D01 v04, ANSI C63.10-2013, RSS-GEN Issue 5, and RSS-247 Issue 2.

## 3. FACILITIES AND ACCREDITATION

The test sites and measurement facilities used to collect data are located at 47173 and 47266 Benicia Street, and 47658 Kato Road, Fremont, California, USA. Line conducted emissions are measured only at the 47173 address. The following table identifies which facilities were utilized for radiated emission measurements documented in this report. Specific facilities are also identified in the test results sections.

47173 Benicia Street	47266 Benicia Street	47658 Kato Rd
<input checked="" type="checkbox"/> Chamber A (ISED:2324B-1)	<input checked="" type="checkbox"/> Chamber D (ISED:22541-1)	<input type="checkbox"/> Chamber K (ISED:2324A-1)
<input type="checkbox"/> Chamber B (ISED:2324B-2)	<input checked="" type="checkbox"/> Chamber E (ISED:22541-2)	<input type="checkbox"/> Chamber L (ISED:2324A-3)
<input type="checkbox"/> Chamber C (ISED:2324B-3)	<input type="checkbox"/> Chamber F (ISED:22541-3)	
	<input type="checkbox"/> Chamber G (ISED:22541-4)	
	<input type="checkbox"/> Chamber H (ISED:22541-5)	

The above test sites and facilities are covered under FCC Test Firm Registration # 208313. Chambers A through C are covered under ISED company address code 2324B with site numbers 2324B -1 through 2324B-3, respectively. Chambers D through H are covered under ISED company address code 22541 with site numbers 22541 -1 through 22541-5, respectively. Chambers K and L are covered under ISED company address code 2324A with site numbers 2324A-1 and 2324A-3, respectively.

UL Verification Services Inc. is accredited by NVLAP, Laboratory Code 200065-0. The full scope of accreditation can be viewed at [NVLAP Lab Search](#).

## 4. CALIBRATION AND UNCERTAINTY

### 4.1. MEASURING INSTRUMENT CALIBRATION

The measuring equipment utilized to perform the tests documented in this report has been calibrated in accordance with the manufacturer's recommendations, and is traceable to recognized national standards.

### 4.2. SAMPLE CALCULATION

Where relevant, the following sample calculation is provided:

$$\begin{aligned} \text{Field Strength (dBuV/m)} &= \text{Measured Voltage (dBuV)} + \text{Antenna Factor (dB/m)} + \\ &\text{Cable Loss (dB)} - \text{Preamp Gain (dB)} \\ 36.5 \text{ dBuV} + 18.7 \text{ dB/m} + 0.6 \text{ dB} - 26.9 \text{ dB} &= 28.9 \text{ dBuV/m} \end{aligned}$$

### 4.3. MEASUREMENT UNCERTAINTY

Where relevant, the following measurement uncertainty levels have been estimated for tests performed on the apparatus:

PARAMETER	UNCERTAINTY
Worst Case Conducted Disturbance, 9KHz to 0.15 MHz	3.84 dB
Worst Case Conducted Disturbance, 0.15 to 30 MHz	3.65 dB
Worst Case Radiated Disturbance, 9KHz to 30 MHz	3.15 dB
Worst Case Radiated Disturbance, 30 to 1000 MHz	5.36 dB
Worst Case Radiated Disturbance, 1000 to 18000 MHz	4.32 dB
Worst Case Radiated Disturbance, 18000 to 26000 MHz	4.45 dB
Worst Case Radiated Disturbance, 26000 to 40000 MHz	5.24 dB

Uncertainty figures are valid to a confidence level of 95%.

## 5. EQUIPMENT UNDER TEST

### 5.1. EUT DESCRIPTION

The Apple iPhone, is a smartphone with multimedia functions (music, application support, and video), cellular GSM, GPRS, EGPRS, UMTS, LTE, TD-SCDMA, CDMA, IEEE 802.11a/b/g/n/ac, Bluetooth, GPS and NFC. All models support at least one UICC based SIM. The second SIM is either UICC based, electronic SIM (e-SIM), or second SIM is not present. The device has a built-in inductive charging receiver which is not user accessible. The rechargeable battery is not user accessible.

### 5.2. MAXIMUM OUTPUT POWER

The transmitter has a maximum conducted output power as follows:

#### 2.4GHz BAND

Frequency Range (MHz)	Mode	Output Power (dBm)	Output Power (mW)
<b>1Tx</b>			
2412 - 2462	802.11b	21.91	155.24
2412 - 2462	802.11g	Covered by 11n HT20	
2412 - 2462	802.11n HT20	21.47	140.28

Frequency Range (MHz)	Mode	Output Power (dBm)	Output Power (mW)
<b>2Tx</b>			
2412 - 2462	802.11n HT20 CDD	24.47	279.90

### 5.3. DESCRIPTION OF AVAILABLE ANTENNAS

Frequency Range (GHz)	Ant. 2 (dBi)	Ant. 5 (dBi)
2.4	-2.8	-4.9

### 5.4. SOFTWARE AND FIRMWARE

The EUT firmware installed during testing was v1.29.99992

The test utility software used during testing was QRCT v3.0.264.0.



## 5.5. WORST-CASE CONFIGURATION AND MODE

EUT was investigated in three orthogonal orientations X, Y and Z on Ant 2 (Antenna 2) and Ant 5 (Antenna 5), it was determined that X (Flatbed) orientation was worst-case orientation for both Ant 2 and MIMO. Y (Landscape) orientation was worst-case orientation for Ant 5.

Radiated band edge, harmonic, and spurious emissions from 1GHz to 18GHz were performed with the EUT was set to transmit at highest power on Low/Middle/High channels.

Radiated emissions below 30MHz, below 1GHz, 18-26GHz and power line conducted emissions were performed with the EUT transmits at the channel with the highest output power as worst-case scenario.

For HT20 modes, radiated harmonics spurious were performed with the EUT set at the 2TX CDD mode with power setting equal or higher than SISO modes as the worst-case scenario. G mode covered by HT20 mode since it has the same power as HT20.

Below 1GHz tests were performed with EUT connected to AC power adapter as the worst case; and for above 1GHz, the worst-case configuration reported was tested with EUT only. For AC line conducted emission, test was investigated with AC power adapter and with laptop. There were no emissions found below 30MHz within 20dB of the limit.

Worst-case data rates as provided by the client were:

802.11b mode: 1 Mbps  
802.11n HT20mode: MCS0

There are two vendors of the WiFi/Bluetooth radio modules: variant 1 and variant 2. The Wi-Fi/Bluetooth radio modules have the same mechanical outline (e.g., the same package dimension and pin-out layout), use the same on-board antenna matching circuit, have an identical antenna structure, and are built and tested to conform to the same specifications and to operate within the same tolerances.

Baseline testing was performed on the two variants to determine the worst case on all conducted power and radiated emissions.

## 5.6. DESCRIPTION OF TEST SETUP

### SUPPORT EQUIPMENT

Support Equipment List				
Description	Manufacturer	Model	Serial Number	FCC ID
laptop	Apple	Macbook Pro	C02P41RZG086	FCC DoC
Laptop AC/DC adapter	Liteon Technology	PA-1450-BA1	B123	NA
EUT AC Adapter	Apple	A1385	D292365CDYADHLHC3	NA

### I/O CABLES (CONDUCTED TEST)

I/O Cable List						
Cable No	Port	# of identical ports	Connector Type	Cable Type	Cable Length (m)	Remarks
1	Antenna	1	SMA	Un-Shielded	0.2	To spectrum Analyzer
2	USB	1	USB	Shielded	1	N/A
3	AC	1	AC	Un-shielded	2	N/A

### I/O CABLES (RADIATED ABOVE 1 GHZ)

I/O Cable List						
Cable No	Port	# of identical ports	Connector Type	Cable Type	Cable Length (m)	Remarks
NA						

### I/O CABLES (BELOW 1GHz AND AC POWER LINE TEST WITH ADAPTER AND LAPTOP)

I/O Cable List						
Cable No	Port	# of identical	Connector Type	Cable Type	Cable Length (m)	Remarks
1	AC	1	AC	Un-shielded	2	N/A
2	USB	1	USB	Un-shielded	1	N/A

### TEST SETUP

The EUT is connected to a test laptop during the tests. Test software exercised the EUT.

**SETUP DIAGRAM FOR CONDUCTED TESTS**

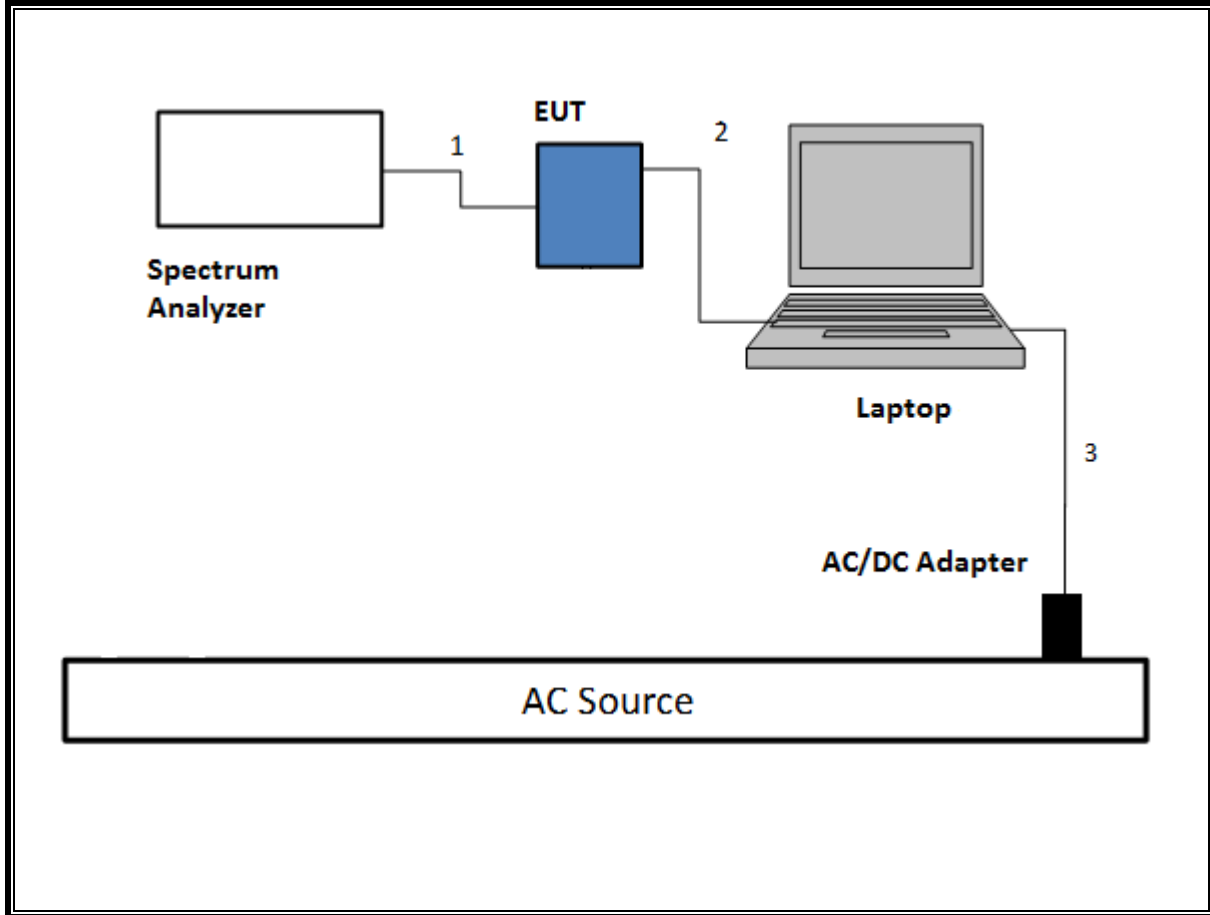

**SETUP DIAGRAM FOR RADIATED TESTS Above 1 GHz**

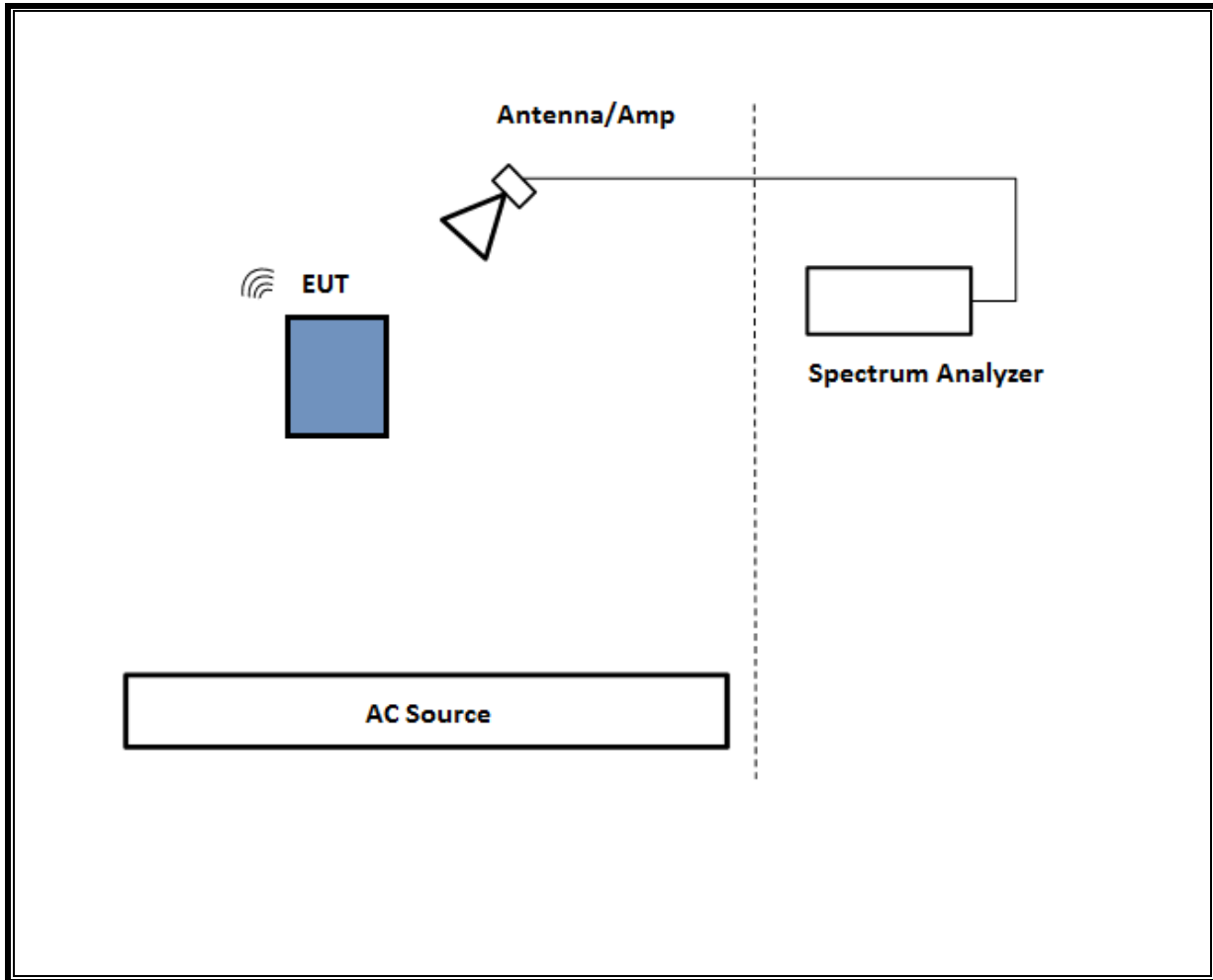

**SETUP DIAGRAM FOR Below 1GHz and AC LINE CONDUCTED TEST**

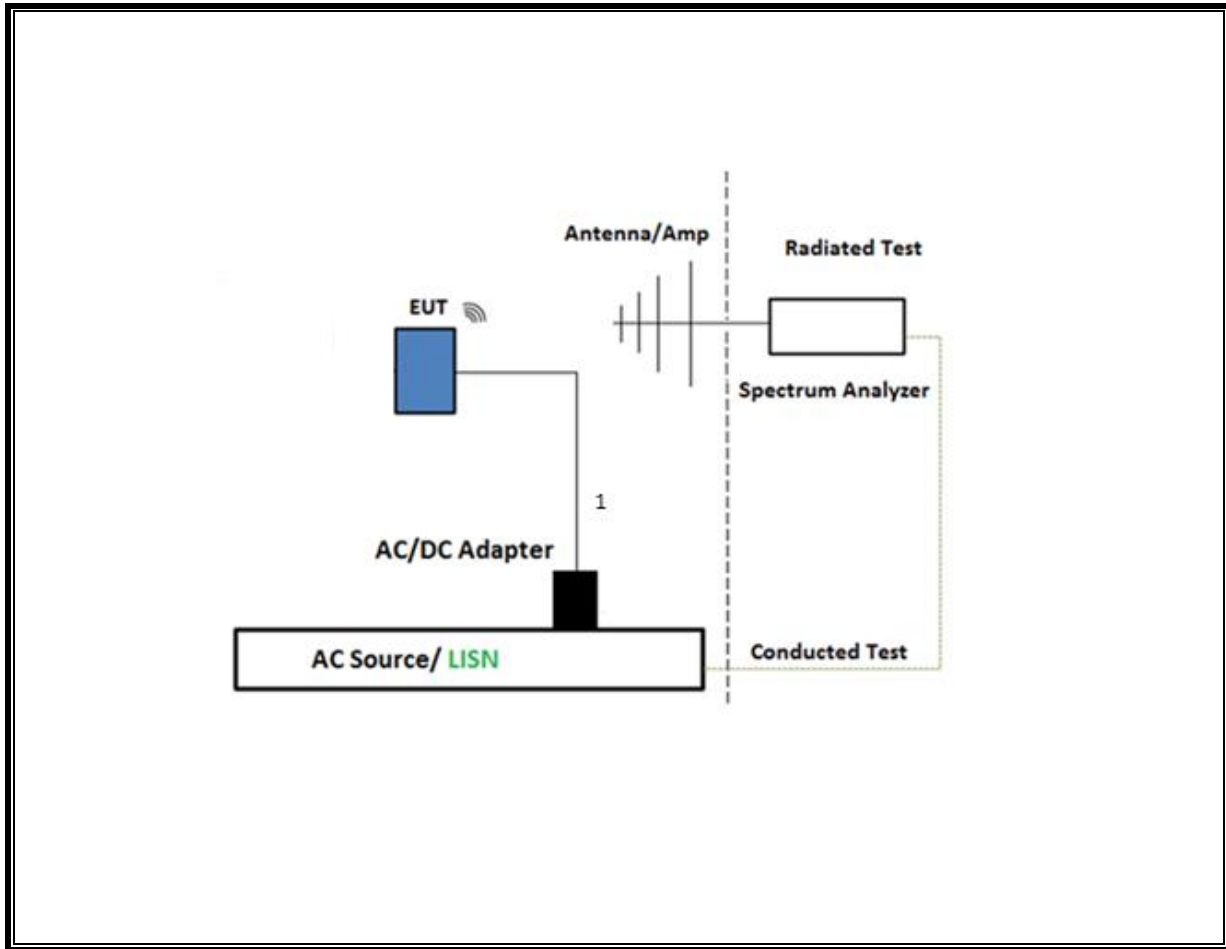

**TEST SETUP- AC LINE CONDUCTED: LAPTOP CONFIGURATION**

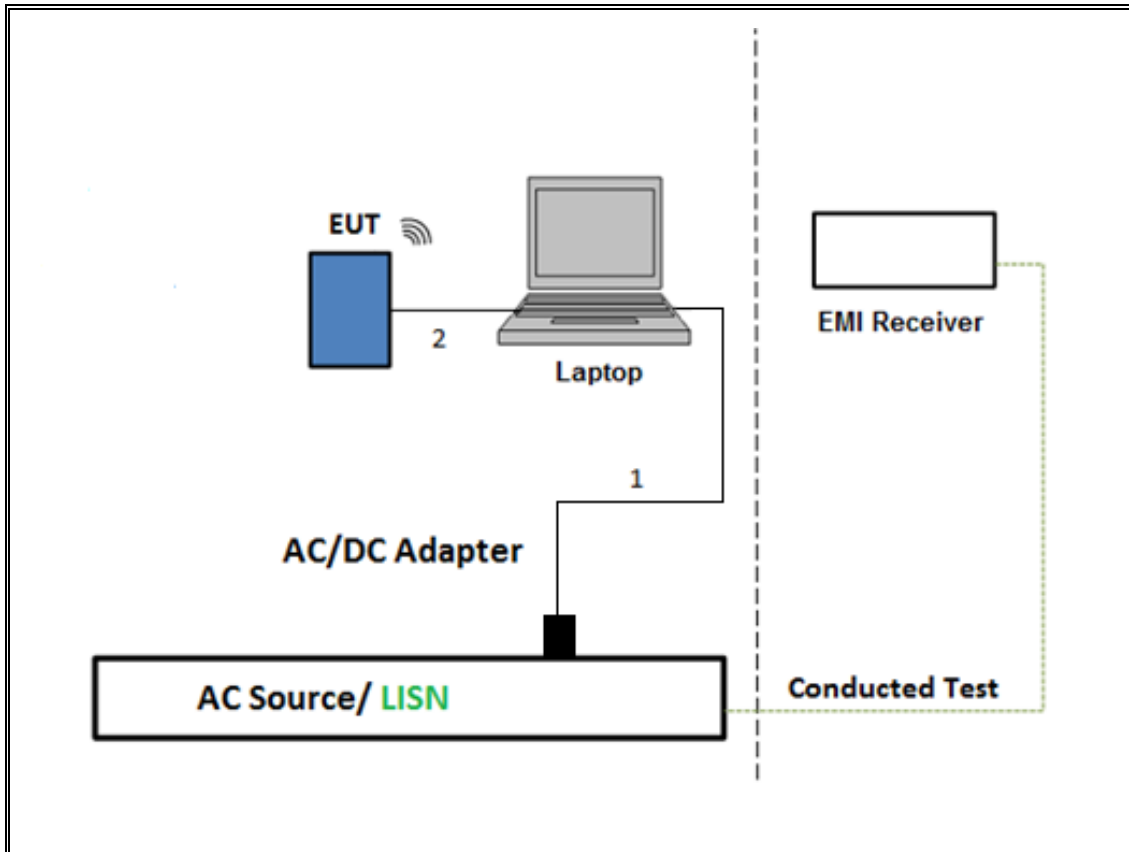

## **6. MEASUREMENT METHOD**

On Time and Duty Cycle: KDB 558074 D01 v04, Section 6.

6 dB BW: KDB 558074 D01 v04, Section 8.1.

99% BW: ANSI C63.10-2013, Section 6.9.3.

Output Power: KDB 558074 D01 v04, Section 9.2.3.2.

Power Spectral Density: KDB 558074 D01 v04, Section 10.2.

Out-of-band emissions in non-restricted bands: KDB 558074 D01 v04, Section 11.1 (b).

Out-of-band emissions in restricted bands: KDB 558074 D01 v04, Section 12.1.

Band-edge: KDB 558074 D01 v04, Section 12.1.

AC Power Line Conducted Emissions: ANSI C63.10-2013, Section 6.2.

## 7. TEST AND MEASUREMENT EQUIPMENT

The following test and measurement equipment was utilized for the tests documented in this report:

Description	Manufacturer	Model	ID Num	Cal Due
Amplifier, 1 to 18GHz	Miteq	AFS42-00101800-25-S-42	T931	02/24/2019
*Amplifier, 1 to 18GHz	Miteq	AFS42-00101800-25-S-42	T1165	06/12/2018
Amplifier, 1 to 18GHz	Miteq	AFS42-00101800-25-S-42	T491	05/19/2019
Amplifier, 1 to 18GHz	Miteq	AFS42-00101800-25-S-42	T740	12/30/2018
Amplifier, 1 to 8GHz	Miteq	AFS42-00101800-25-S-42	T1131	12/30/2018
*Pre-Amp 18-26GHz	Agilent Technology	8449B	T404	07/23/2018
*Antenna, Horn 1-18GHz	ETS Lindgren	3117	T120	07/02/2018
Antenna, Horn 1-18GHz	ETS-Lindgren	3117	T862	05/24/2019
Antenna, Horn 1-18GHz	ETS Lindgren	3117	T346	04/03/2019
Antenna, Horn 1-18GHz	ETS Lindgren	3117	T119	04/03/2019
*Antenna, Horn 1-18GHz	ETS Lindgren	3117	T136	07/02/2018
Antenna Horn, 18 to 26GHz	ARA	MWH-1826	T89	01/18/2019
Antenna, Broadband Hybrid, 30MHz to 2000MHz	Sunol Sciences	JB1	T130	10/16/2018
Spectrum Analyzer, PXA 3Hz to 44GHz	Keysight	N9030A	T340	12/15/2018
Spectrum Analyzer, PXA 3Hz to 44GHz	Keysight	N9030A	T906	02/16/2019
Spectrum Analyzer, PXA, 3Hz to 44GHz	Agilent (Keysight) Technologies	N9030A	T342	02/22/2019
**Power Meter, P-series single channel	Keysight	N1911A	T1268	06/25/2019
Power Sensor	Keysight	N1921A	T1225	04/10/2019
Antenna, Active Loop 9KHz to 30MHz	ETS-Lindgren	6502	T757	09/14/2018
<b>AC Line Conducted</b>				
EMI Test Receiver 9KHz-7GHz	Rohde & Schwarz	ESC17	T1436	01/25/2019
Power Cable, Line Conducted Emissions	UL	PG1	T861	08/31/2018
**LISN for Conducted Emissions CISPR-16	Fischer	50/250-25-2-01	T1310	06/19/2019
<b>UL AUTOMATION SOFTWARE</b>				
Radiated Software	UL	UL EMC	Ver 9.5, April 26, 2016	
Conducted Software	UL	UL EMC	Ver 5.4, October 13, 2016	
AC Line Conducted Software	UL	UL EMC	Ver 9.5, May 26, 2015	

Note:

\*Testing is completed before equipment expiration date.

\*\*Testing began after the calibration date.



## 8. ANTENNA PORT TEST RESULTS

### 8.1. ON TIME AND DUTY CYCLE

#### LIMITS

None; for reporting purposes only.

#### PROCEDURE

KDB 789033 Zero-Span Spectrum Analyzer Method.

#### ON TIME AND DUTY CYCLE RESULTS

Mode	ON Time B (msec)	Period (msec)	Duty Cycle x (linear)	Duty Cycle (%)	Duty Cycle Correction Factor (dB)	1/B Minimum VBW (kHz)
<b>2.4GHz Band</b>						
802.11b 1TX	12.410	12.430	0.998	99.84%	0.00	0.010
802.11n HT20 1TX/2TX	1.920	1.943	0.988	98.82%	0.00	0.010

**DUTY CYCLE PLOTS**

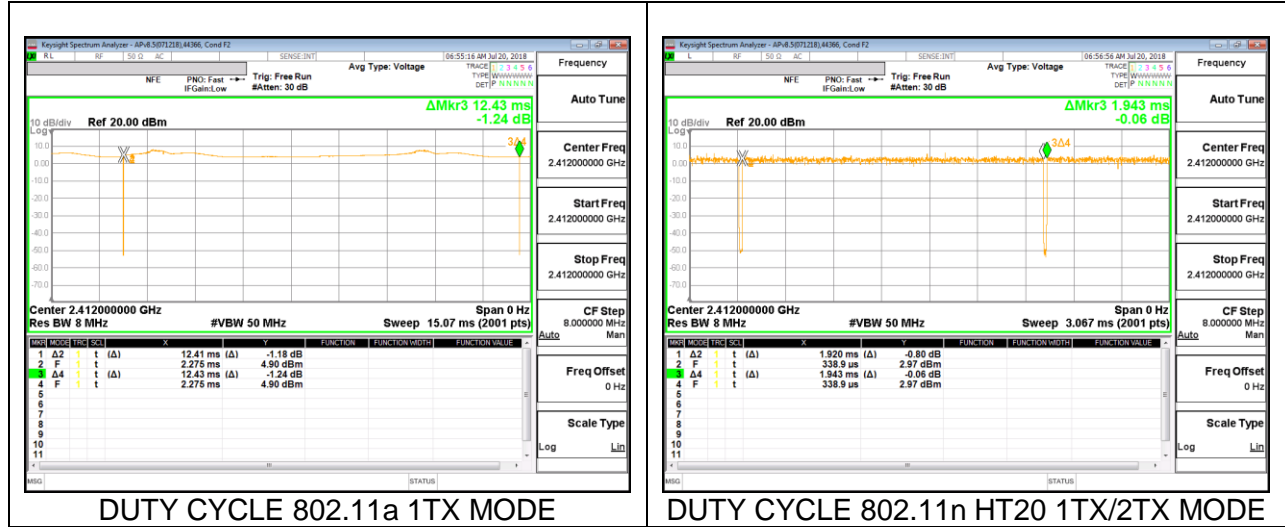

## 8.2. 99% BANDWIDTH

### LIMITS

None; for reporting purposes only.

### RESULTS

#### 8.2.1. 802.11b MODE

##### 1TX Antenna 2 MODE

Channel	Frequency (MHz)	99% Bandwidth (MHz)
Low 1	2412	12.5830
Low 2	2417	12.4080
Mid 6	2437	12.8700
High 11	2462	12.7910
High 12	2467	12.6610
High 13	2472	12.7620

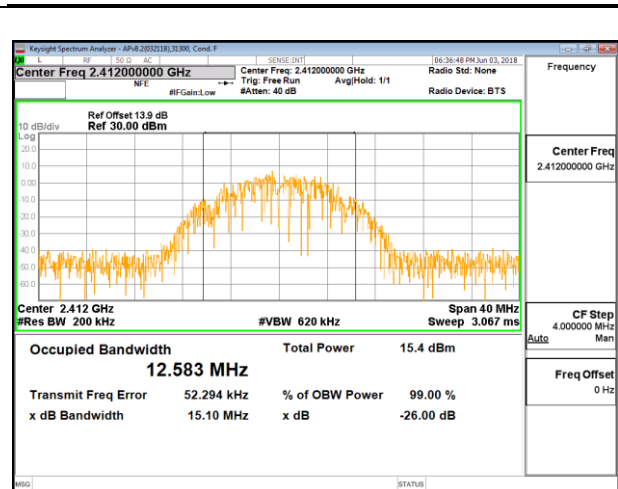

LOW CHANNEL 1

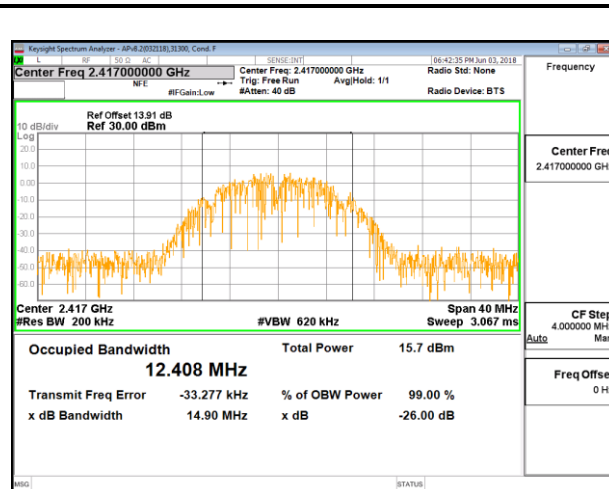

LOW CHANNEL 2

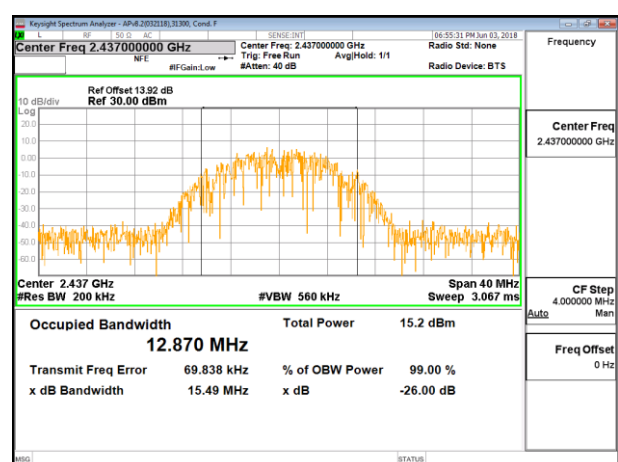

MID CHANNEL 6

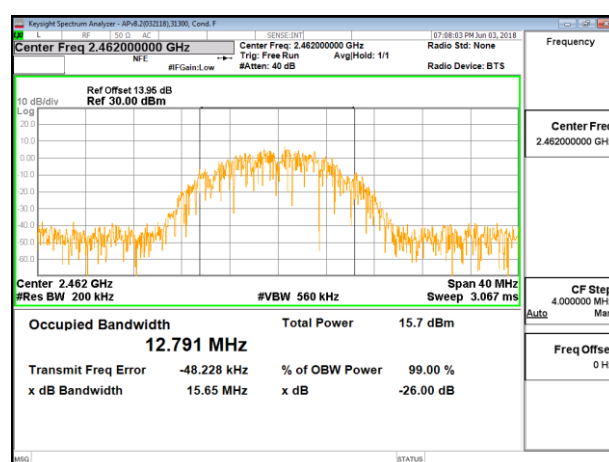

HIGH CHANNEL 11

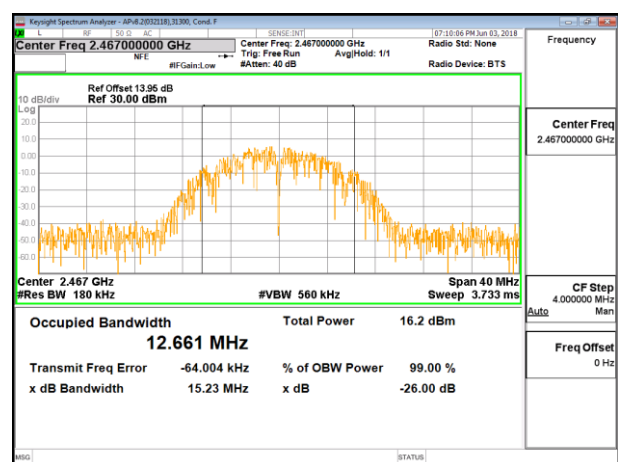

HIGH CHANNEL 12

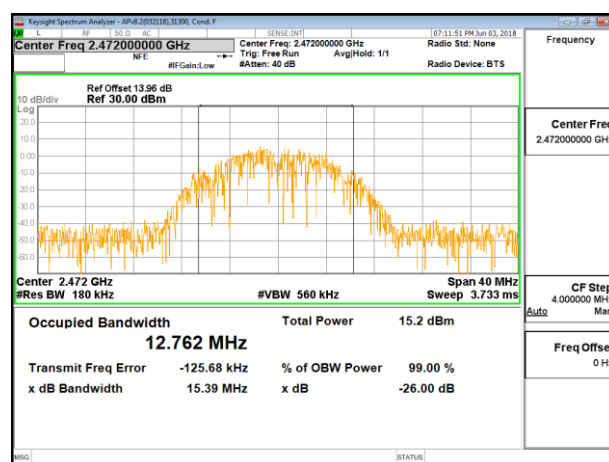

HIGH CHANNEL 13

**1TX Antenna 5 MODE**

Channel	Frequency (MHz)	99% Bandwidth (MHz)
Low 1	2412	12.6500
Low 2	2417	12.6690
Mid 6	2437	12.8400
High 11	2462	12.7880
High 12	2467	12.7660
High 13	2472	12.6210

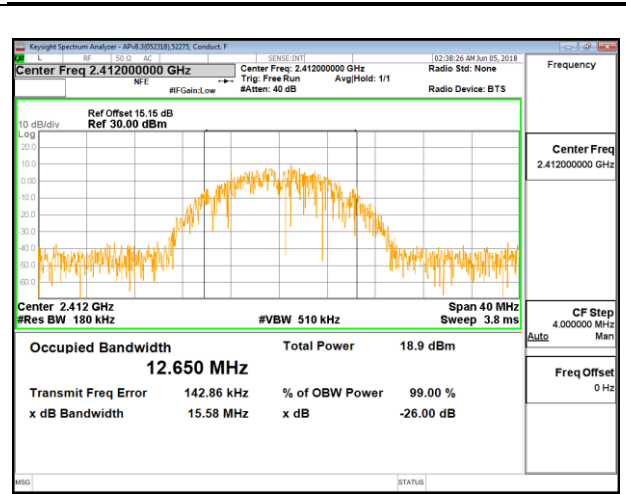

LOW CHANNEL 1

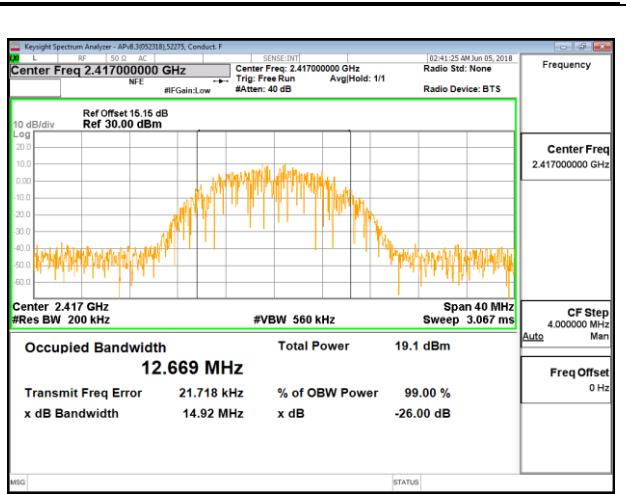

LOW CHANNEL 2

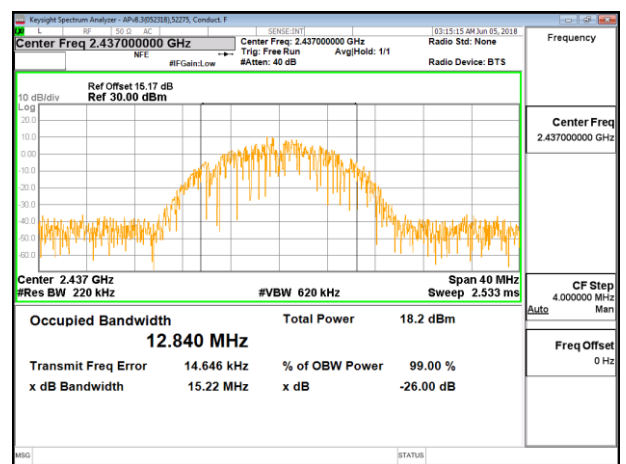

MID CHANNEL 6

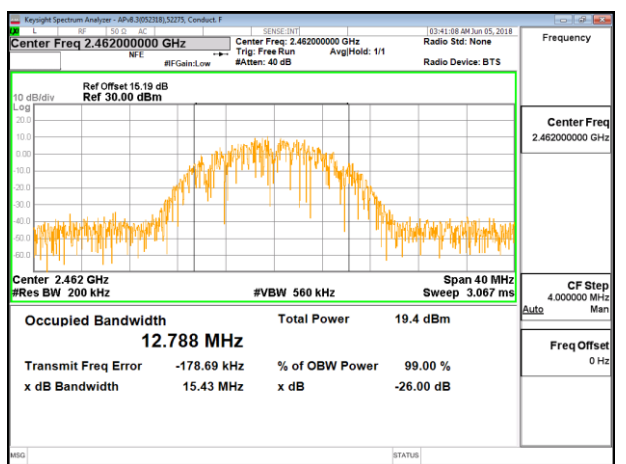

HIGH CHANNEL 11

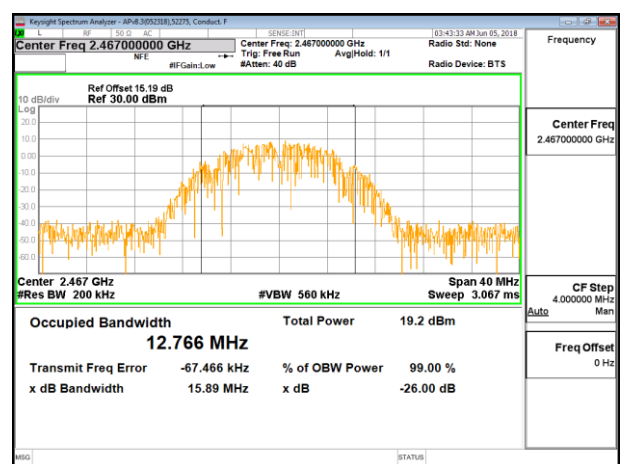

HIGH CHANNEL 12

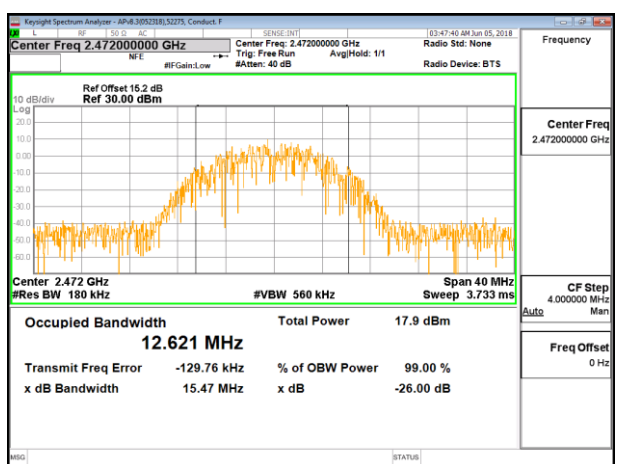

HIGH CHANNEL 13

**8.2.2. 802.11n HT20 MODE**

**1TX Antenna 2 MODE**

Channel	Frequency (MHz)	99% Bandwidth (MHz)
Low 1	2412	17.8120
Low 2	2417	17.6850
Low 3	2422	17.7790
Mid 6	2437	17.8910
High 9	2452	17.7330
High 10	2457	17.8370
High 11	2462	17.7430
High 12	2467	17.6980
High 13	2472	17.8360

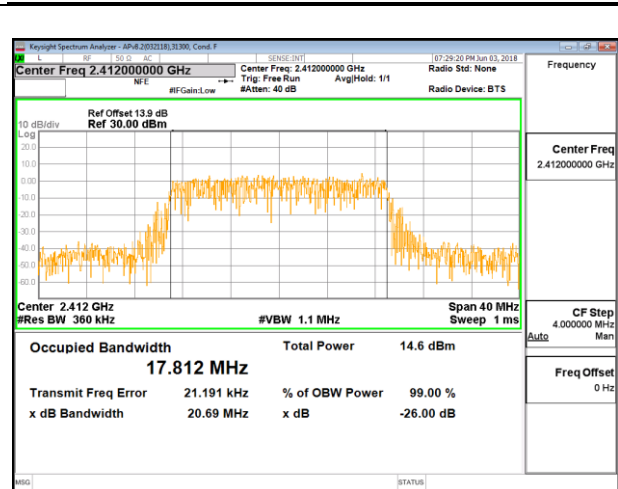

LOW CHANNEL 1

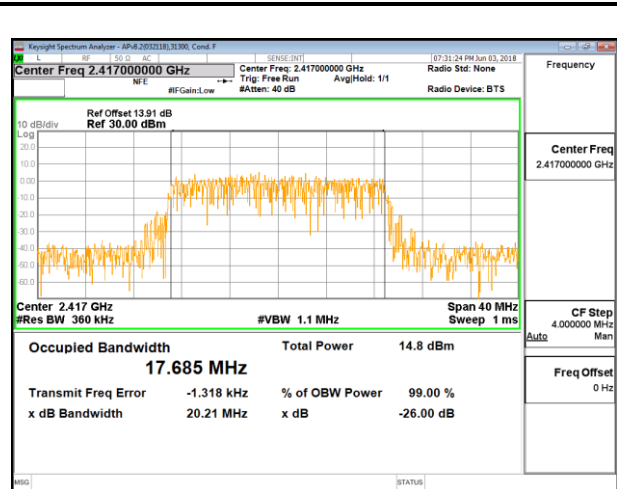

LOW CHANNEL 2

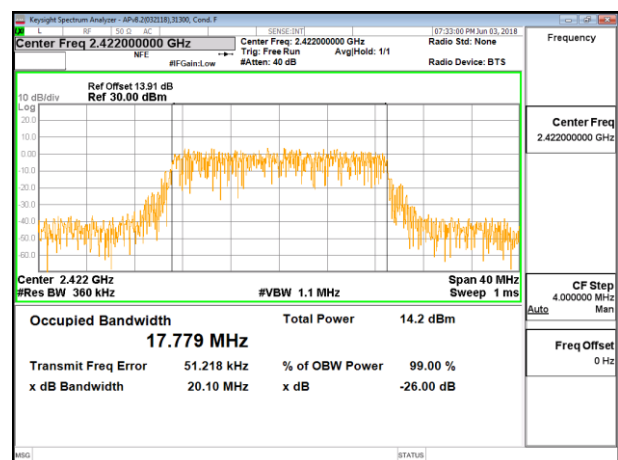

LOW CHANNEL 3

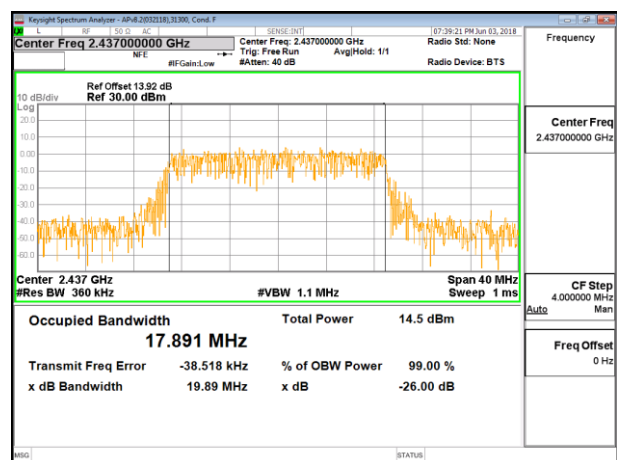

MID CHANNEL 6

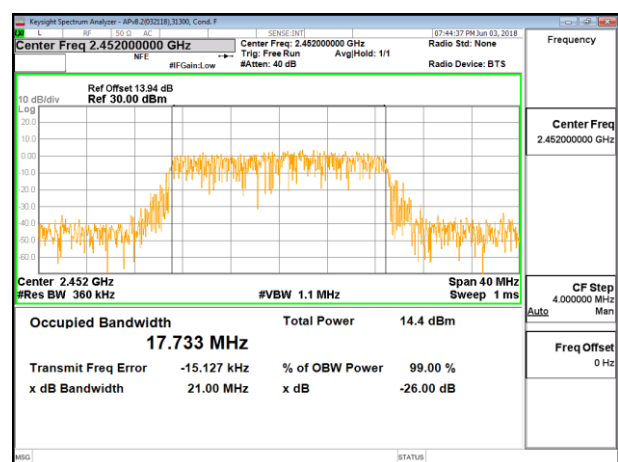

HIGH CHANNEL 9

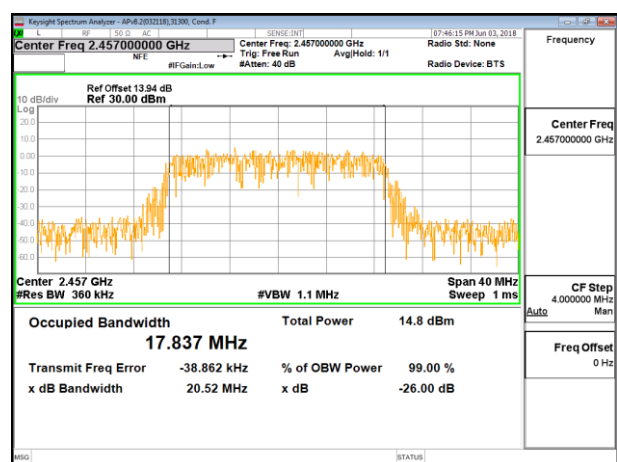

HIGH CHANNEL 10



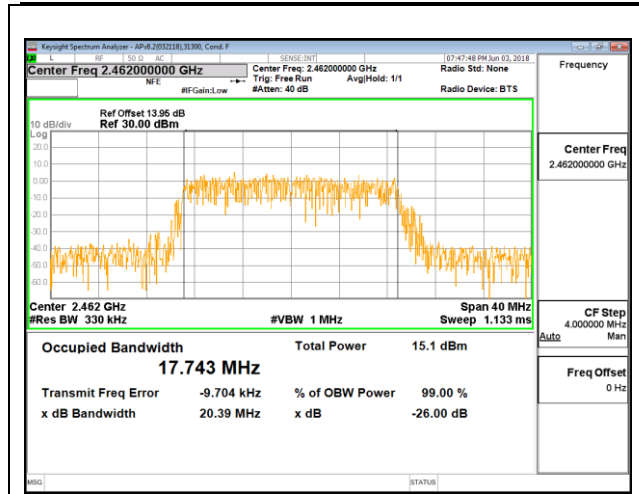

**HIGH CHANNEL 11**

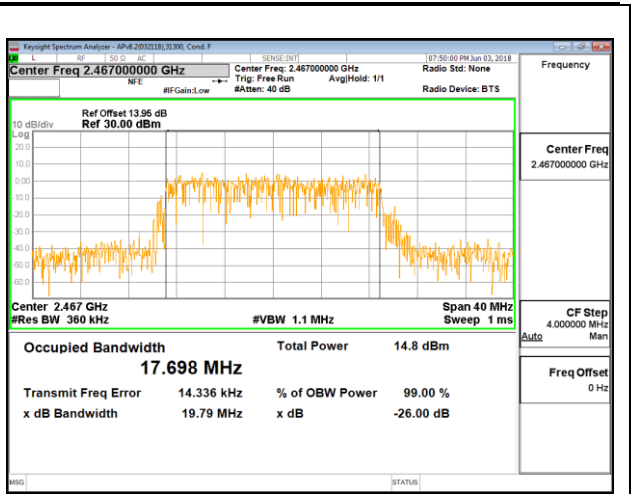

**HIGH CHANNEL 12**

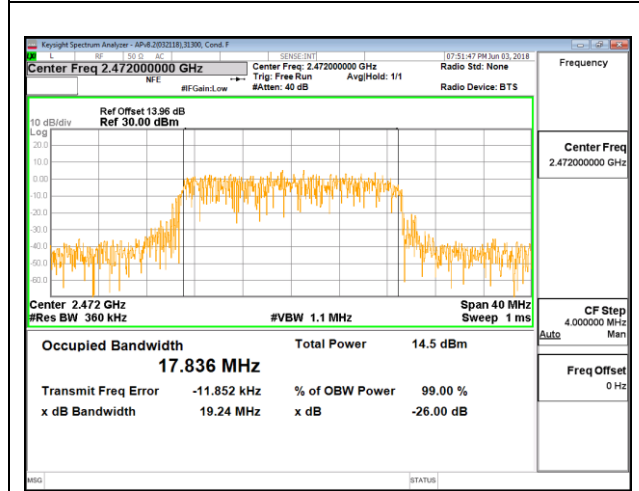

**HIGH CHANNEL 13**

**1TX Antenna 5 MODE**

Channel	Frequency (MHz)	99% Bandwidth (MHz)
Low 1	2412	17.7080
Low 2	2417	17.7550
Low 3	2422	17.8260
Mid 6	2437	17.7940
High 9	2452	17.7280
High 10	2457	17.7130
High 11	2462	17.7650
High 12	2467	17.8270
High 13	2472	17.7210

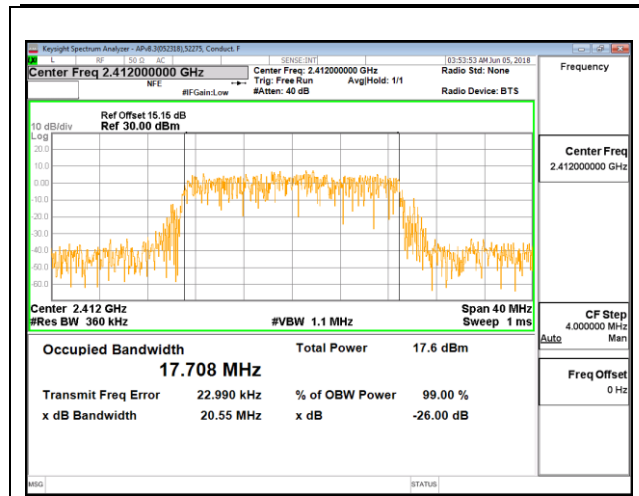

LOW CHANNEL 1

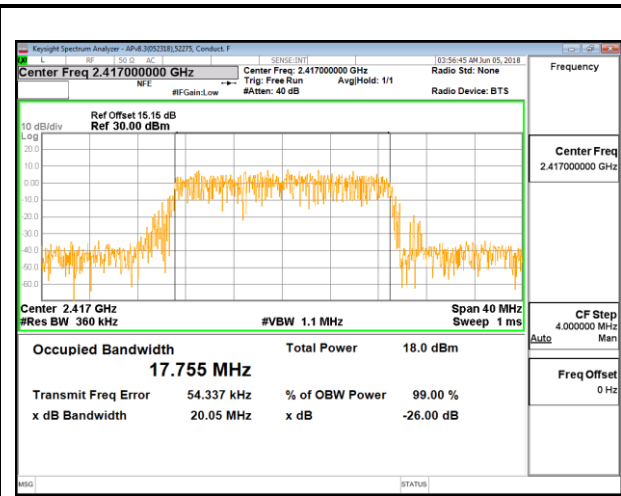

LOW CHANNEL 2

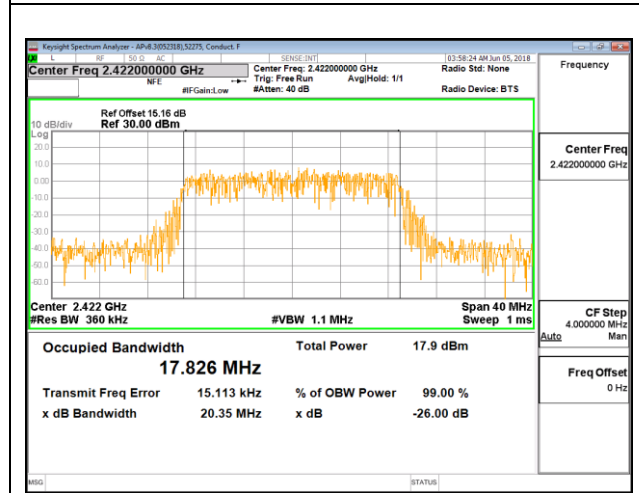

LOW CHANNEL 3

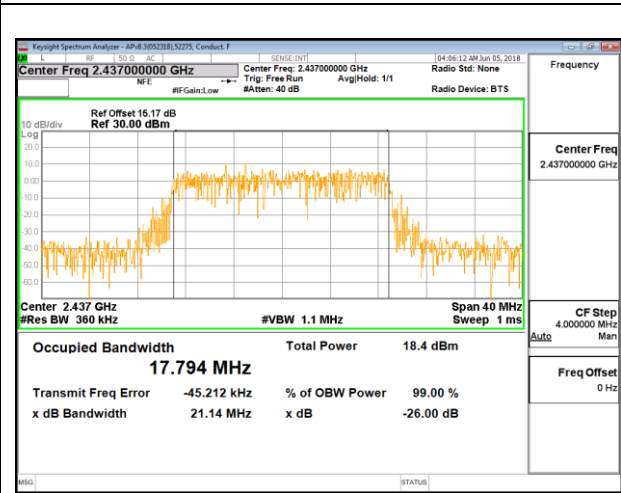

MID CHANNEL 6

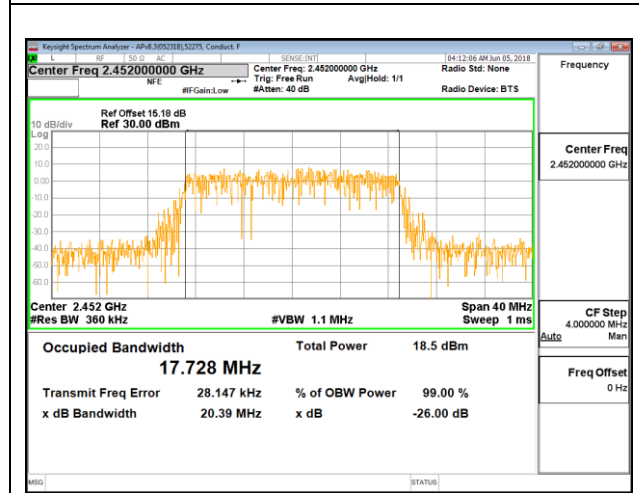

HIGH CHANNEL 9

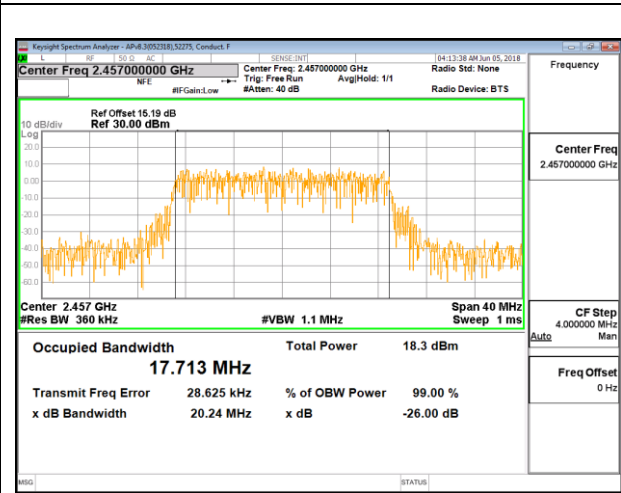

HIGH CHANNEL 10

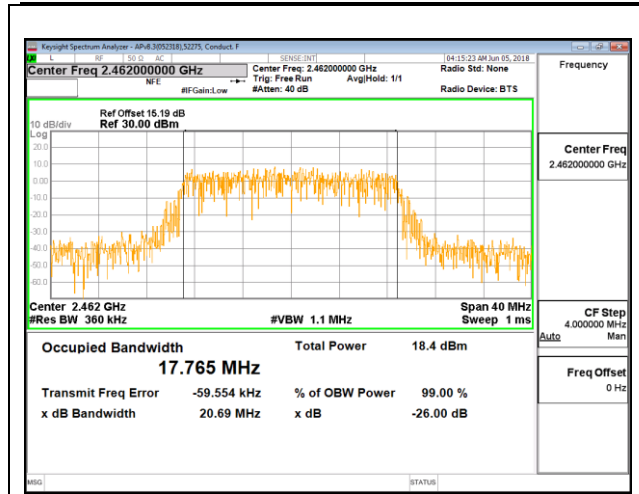

**HIGH CHANNEL 11**

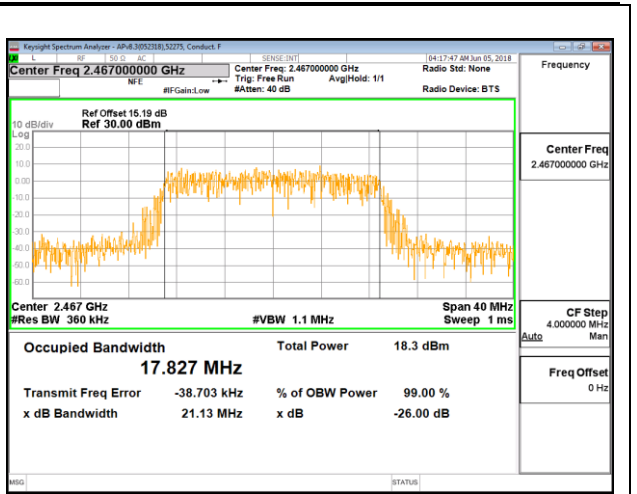

**HIGH CHANNEL 12**

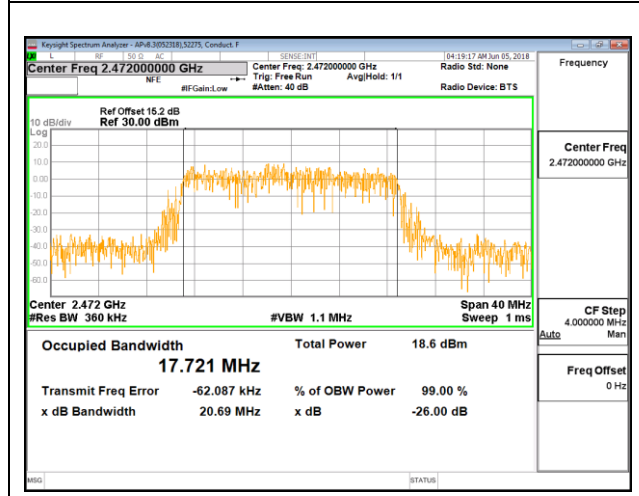

**HIGH CHANNEL 13**

**8.2.3. 2TX Antenna 2 + Antenna 5 CDD MODE**

Channel	Frequency (MHz)	99% Bandwidth ANT 2 (MHz)	99% Bandwidth ANT 5 (MHz)
Low 1	2412	17.6750	17.8150
Low 2	2417	17.7750	17.7230
Low 3	2422	17.8790	17.7340
Low 4	2427	17.8920	17.8650
Mid 6	2437	17.7330	17.9000
High 8	2447	17.7130	17.7880
High 9	2452	17.7260	17.7740
High 10	2457	17.7950	17.7730
High 11	2462	17.7330	17.7750
High 12	2467	17.8300	17.9020
High 13	2472	17.8670	17.8320

### LOW CHANNEL 1

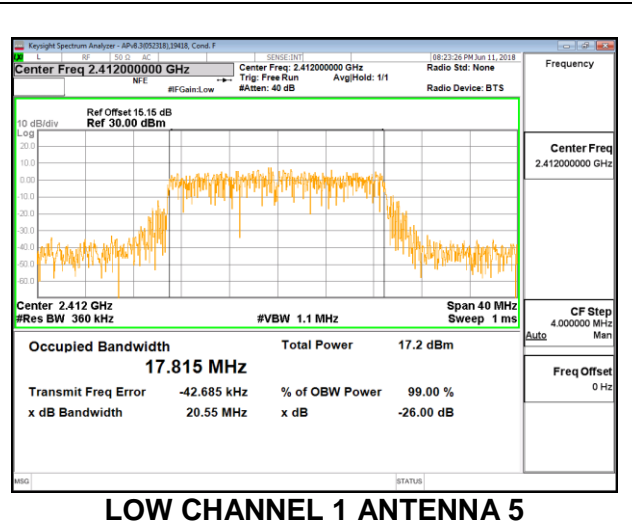
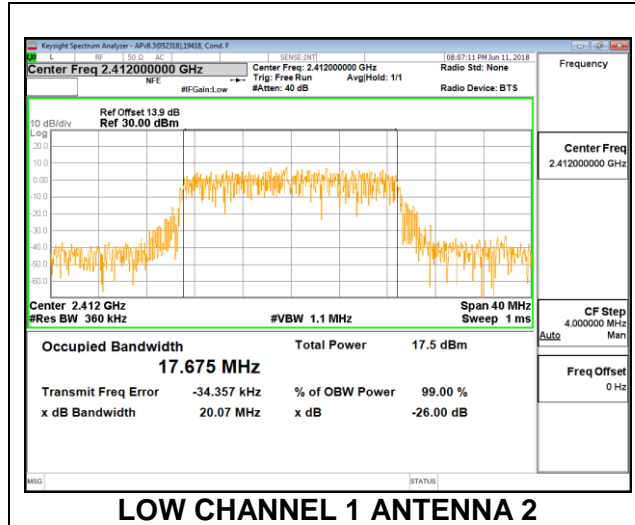

### LOW CHANNEL 2

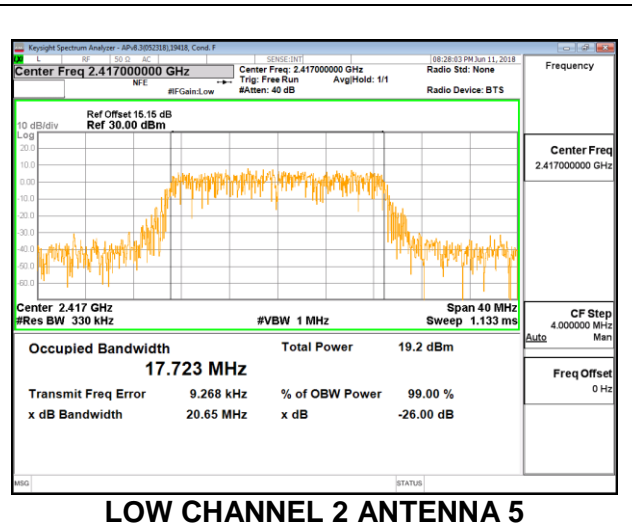
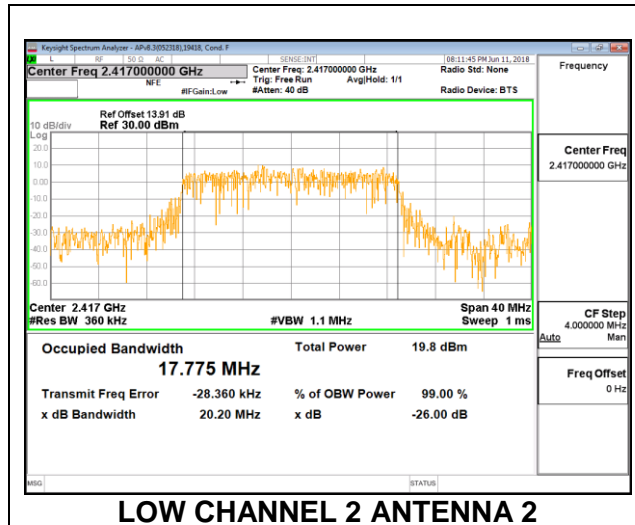

### LOW CHANNEL 3

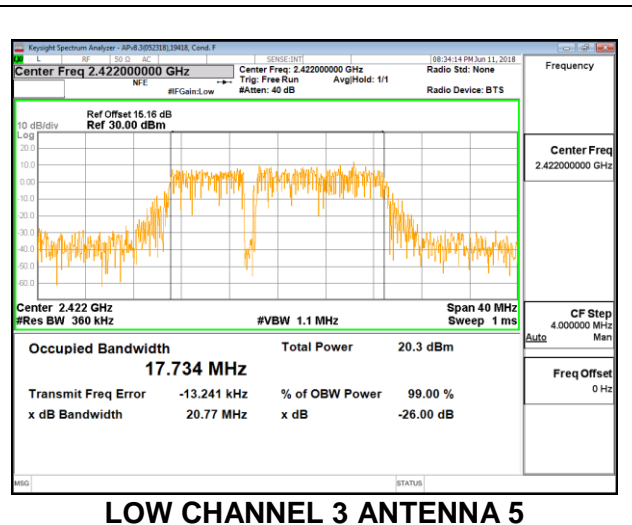
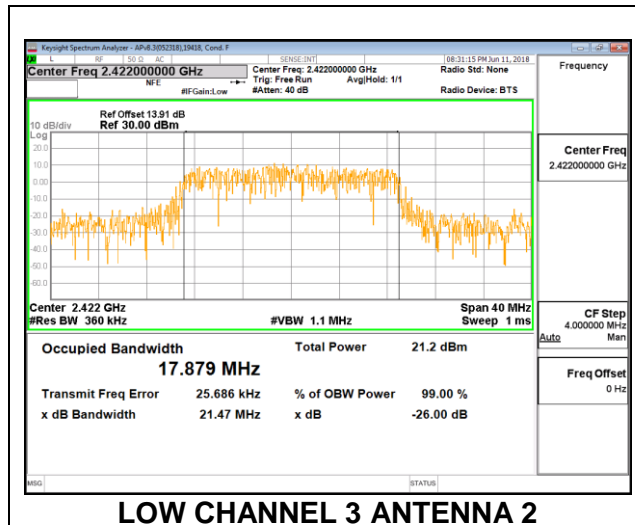

### LOW CHANNEL 4

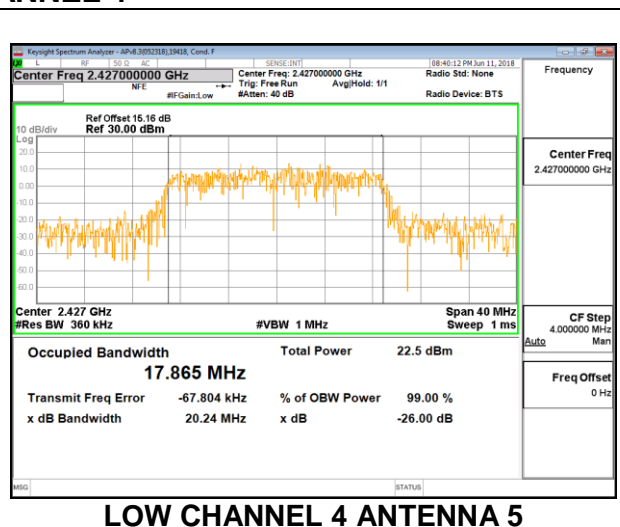
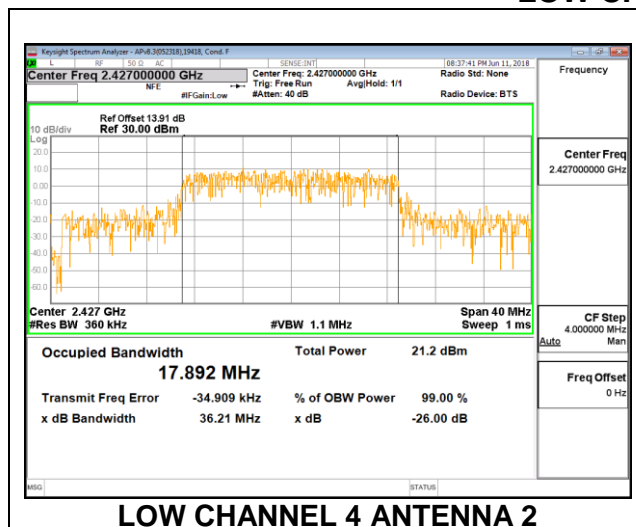

### MID CHANNEL 6

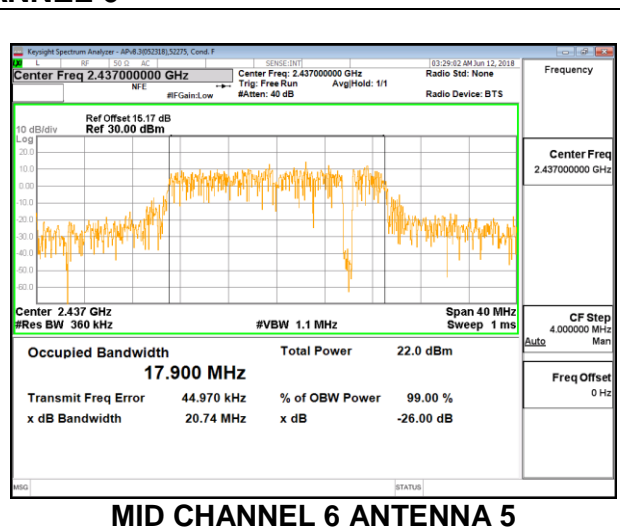
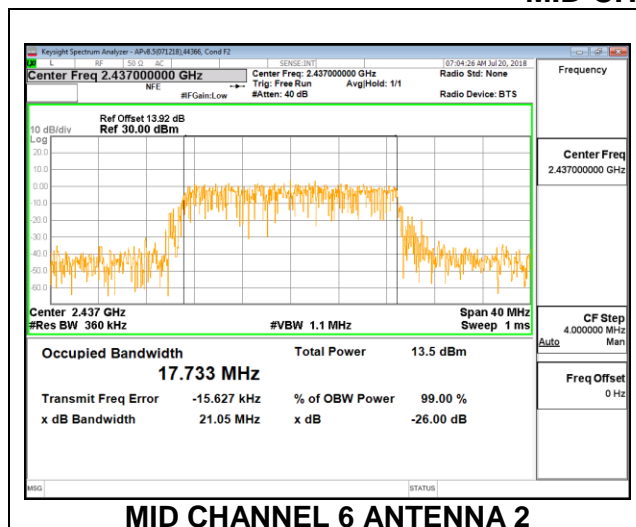

### HIGH CHANNEL 8

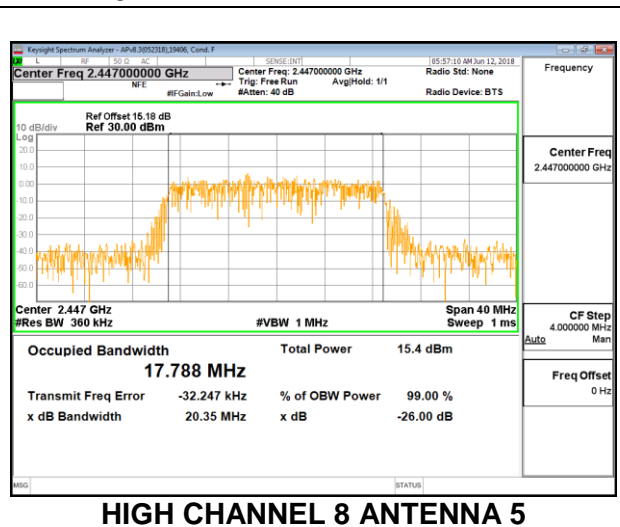
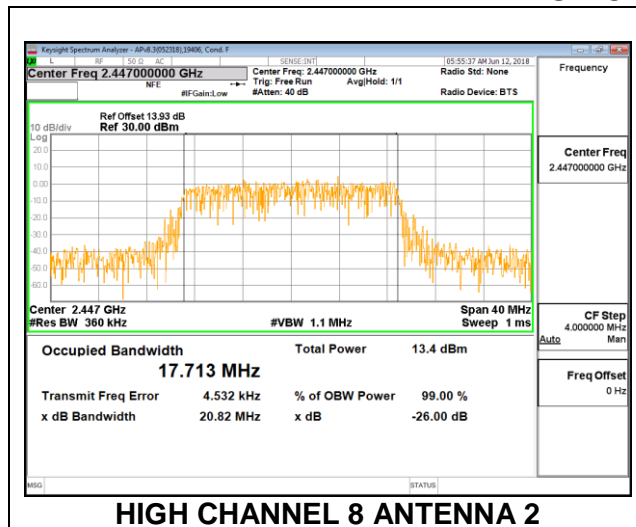

### HIGH CHANNEL 9

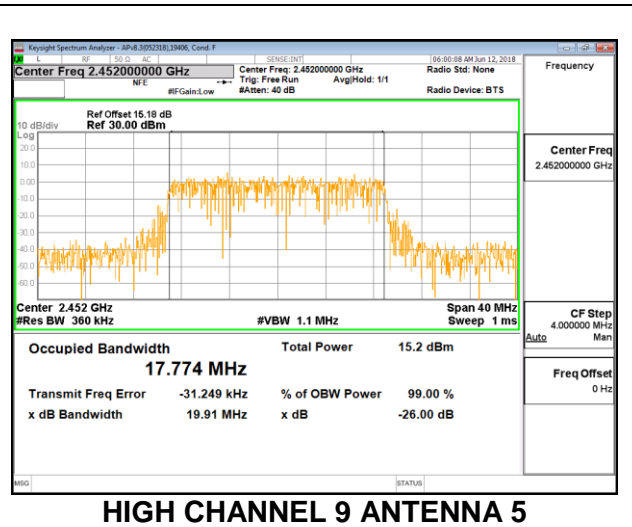
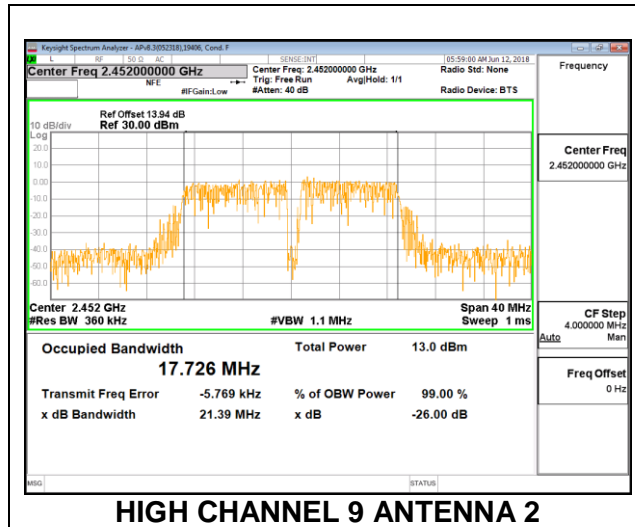

### HIGH CHANNEL 10

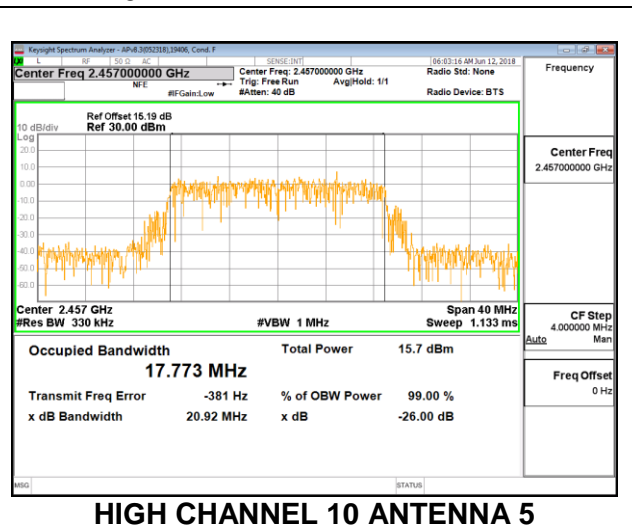
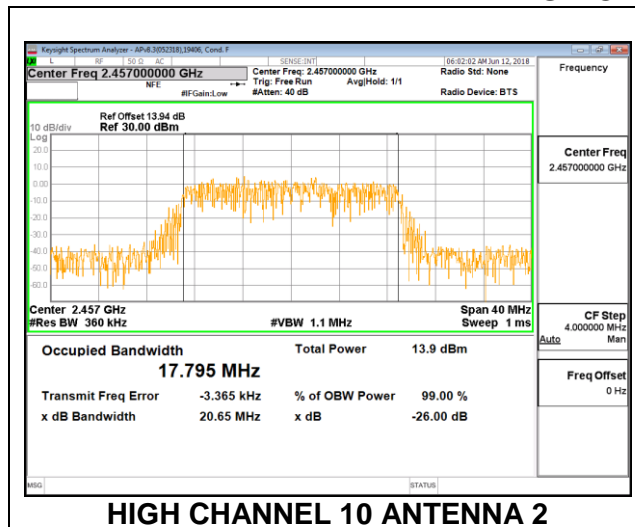

### HIGH CHANNEL 11

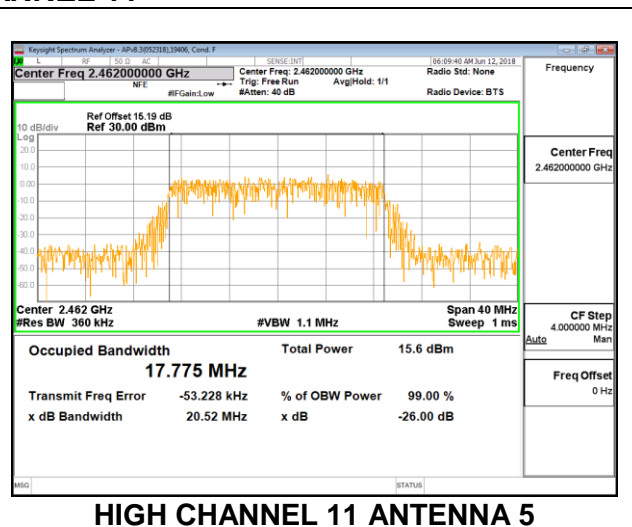
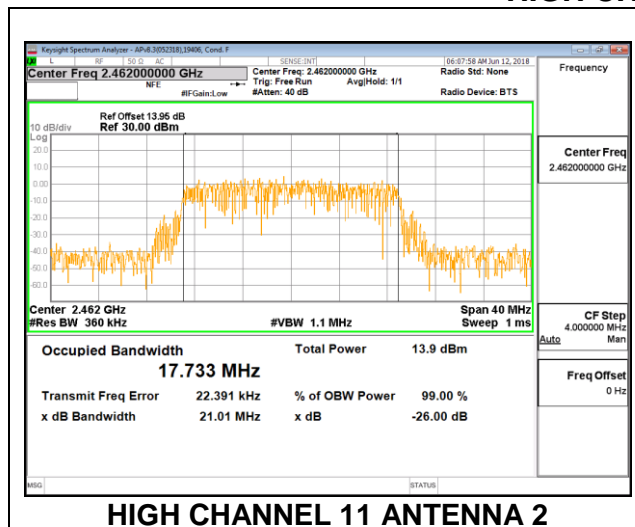



### HIGH CHANNEL 12

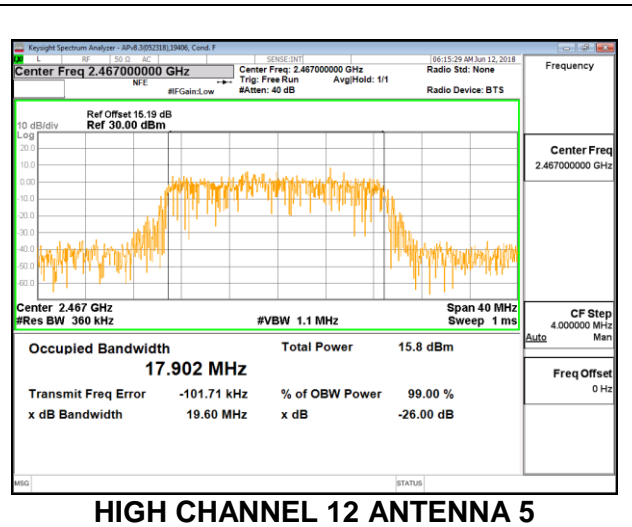
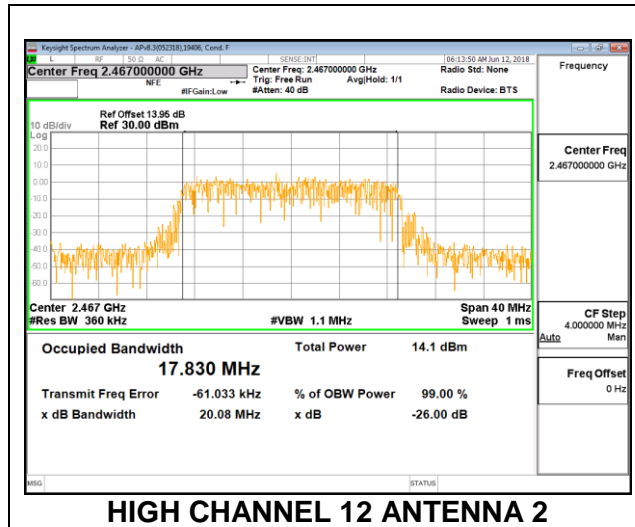

### HIGH CHANNEL 13

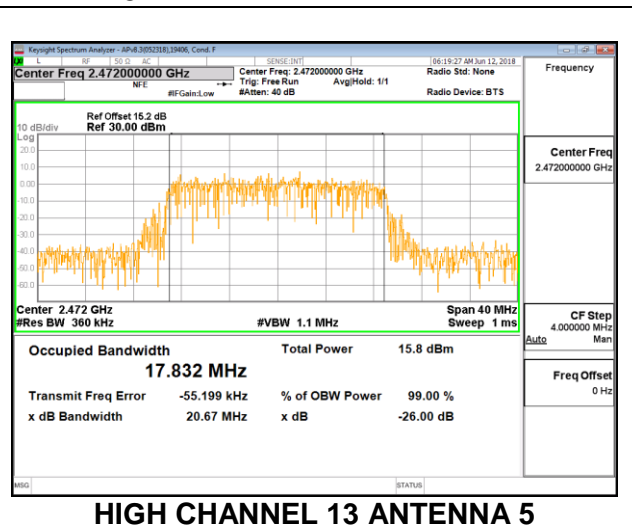
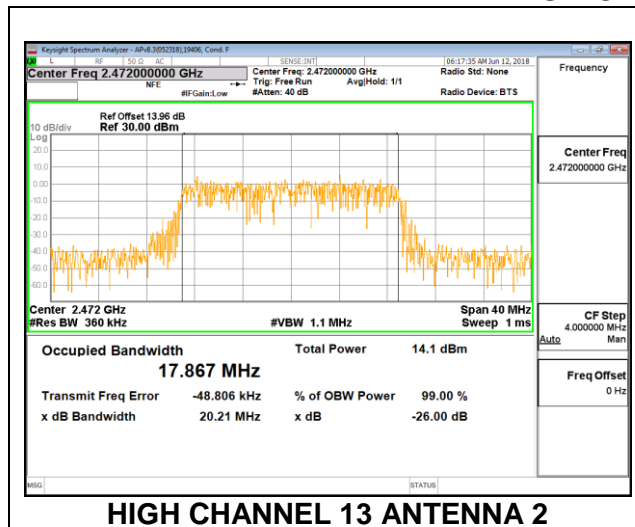

### **8.3. 6 dB BANDWIDTH**

#### **LIMITS**

FCC §15.247 (a) (2)

RSS-247 5.2 (a)

The minimum 6 dB bandwidth shall be at least 500 kHz.

#### **RESULTS**

**8.3.1. 802.11b MODE**

**1TX Antenna 2 MODE**

Channel	Frequency (MHz)	6 dB Bandwidth (MHz)	Minimum Limit (MHz)
Low 1	2412	6.6800	0.5
Low 2	2417	7.1600	0.5
Mid 6	2437	8.1200	0.5
High 11	2462	6.5600	0.5
High 12	2467	6.6000	0.5
High 13	2472	7.6400	0.5

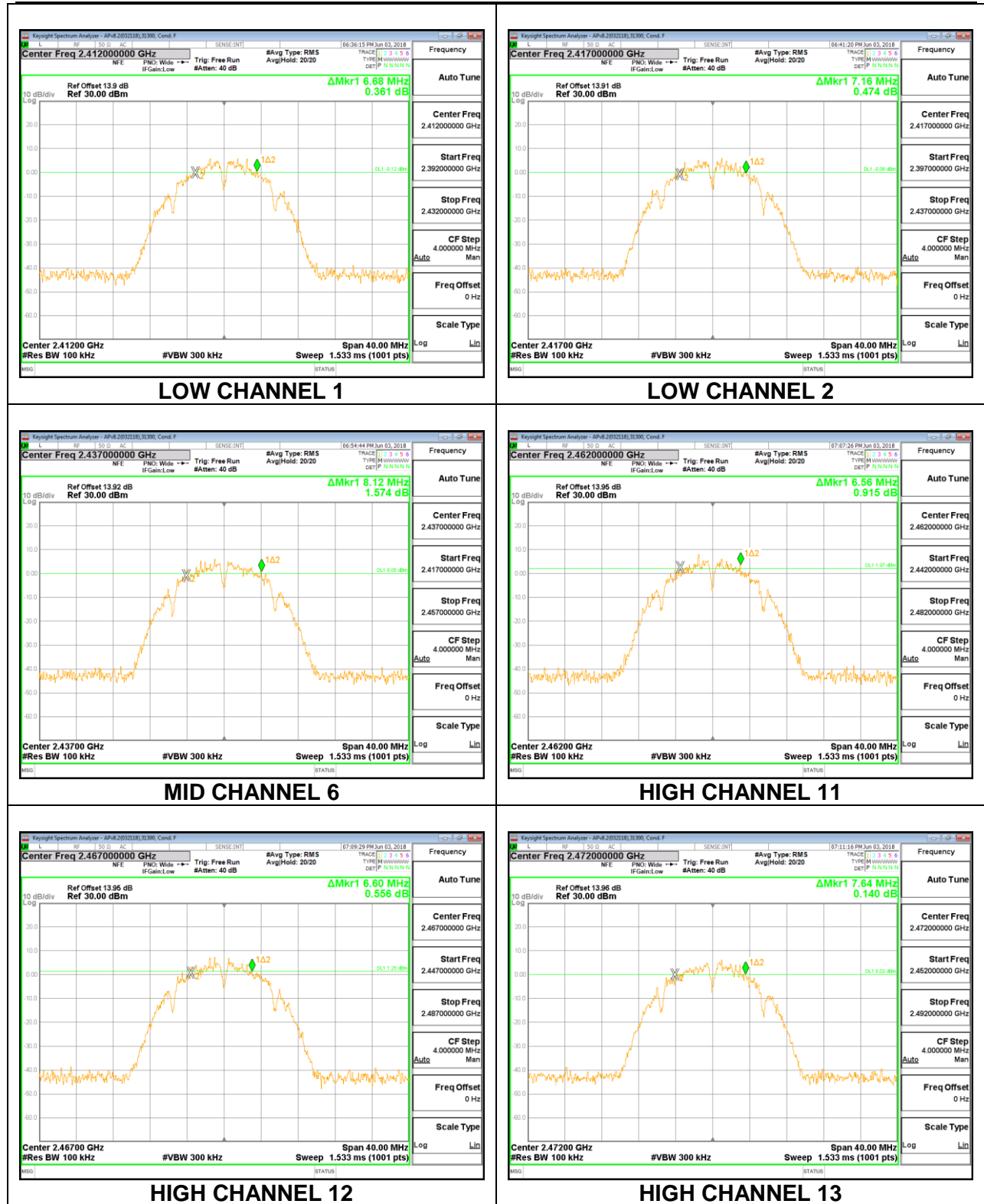

**1TX Antenna 5 MODE**

Channel	Frequency (MHz)	6 dB Bandwidth (MHz)	Minimum Limit (MHz)
Low 1	2412	8.1200	0.5
Low 2	2417	7.8400	0.5
Mid 6	2437	6.8800	0.5
High 11	2462	7.1200	0.5
High 12	2467	7.6000	0.5
High 13	2472	7.5600	0.5

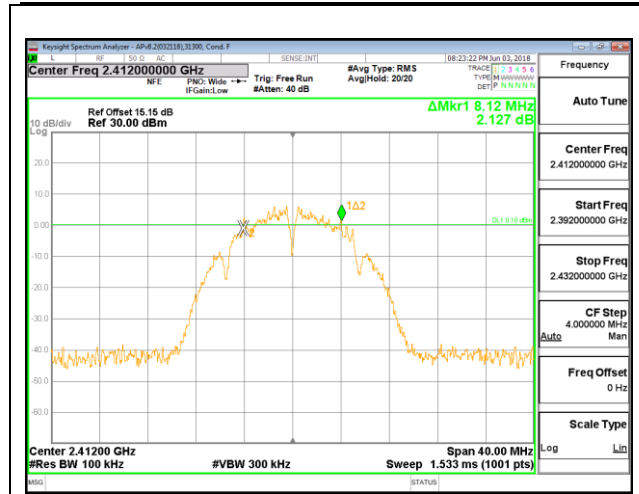

LOW CHANNEL 1

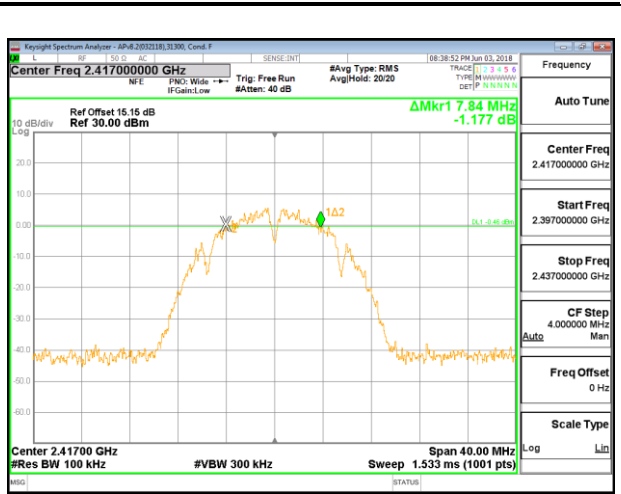

LOW CHANNEL 2

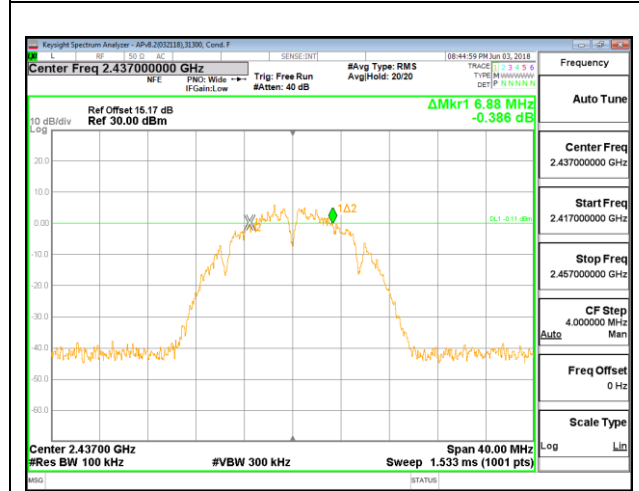

MID CHANNEL 6

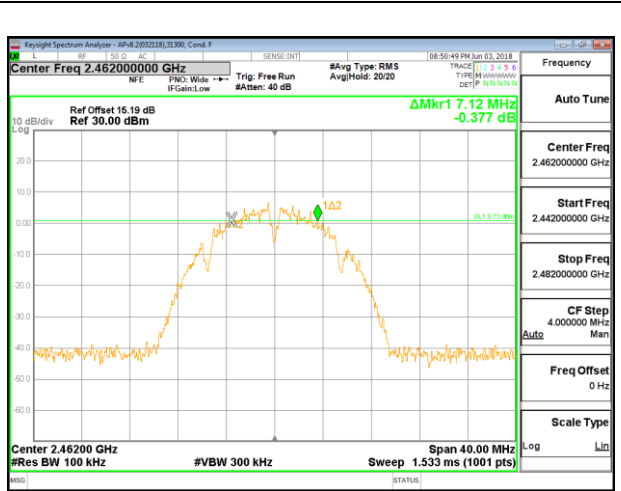

HIGH CHANNEL 11

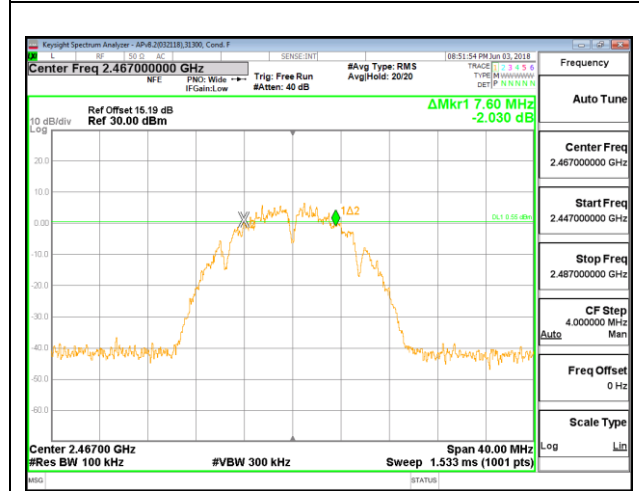

HIGH CHANNEL 12

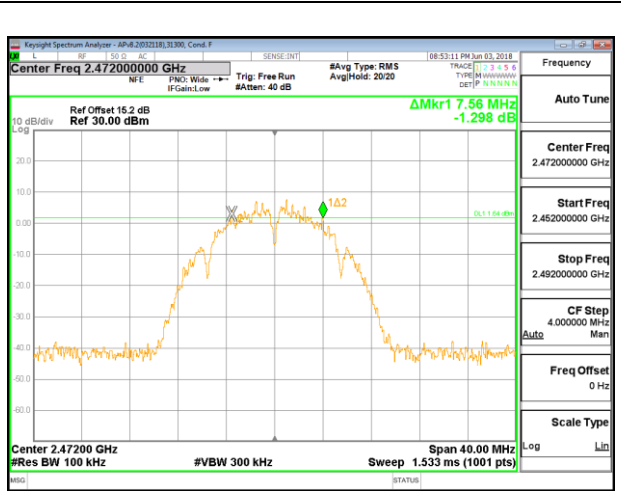

HIGH CHANNEL 13