



# **CERTIFICATION TEST REPORT**

**Report Number. :** 11792137-E4V3

**Applicant :** APPLE, INC.  
1 INFINITE LOOP  
CUPERTINO, CA 95014, U.S.A.

**Model :** A1901

**FCC ID :** BCG-E3175A

**EUT Description :** SMARTPHONE

**Test Standard(s) :** FCC 47 CFR PART 15 SUBPART E

**Date Of Issue:**

August 31, 2017

**Prepared by:**

UL Verification Services Inc.  
47173 Benicia Street  
Fremont, CA 94538, U.S.A.  
TEL: (510) 771-1000  
FAX: (510) 661-0888



NVLAP LAB CODE 200065-0

Revision History

<u>Rev.</u>	<u>Issue Date</u>	<u>Revisions</u>	<u>Revised By</u>
V1	8/10/2017	Initial issue	Chin Pang
V2	8/17/2017	Address TCB's Questions	Chin Pang
V3	8/31/2017	Address TCB's Questions	Chin Pang

## TABLE OF CONTENTS

<b>1. ATTESTATION OF TEST RESULTS .....</b>	<b>11</b>
<b>2. TEST METHODOLOGY .....</b>	<b>12</b>
<b>3. FACILITIES AND ACCREDITATION .....</b>	<b>12</b>
<b>4. CALIBRATION AND UNCERTAINTY .....</b>	<b>13</b>
4.1. MEASURING INSTRUMENT CALIBRATION.....	13
4.2. SAMPLE CALCULATION.....	13
4.3. MEASUREMENT UNCERTAINTY .....	13
<b>5. EQUIPMENT UNDER TEST.....</b>	<b>14</b>
5.1. DESCRIPTION OF EUT.....	14
5.2. MAXIMUM OUTPUT POWER.....	14
5.3. DESCRIPTION OF AVAILABLE ANTENNAS.....	17
5.4. SOFTWARE AND FIRMWARE .....	17
5.5. WORST-CASE CONFIGURATION AND MODE.....	18
5.6. DESCRIPTION OF TEST SETUP .....	20
<b>6. TEST AND MEASUREMENT EQUIPMENT.....</b>	<b>25</b>
<b>7. ON TIME, DUTY CYCLE AND MEASUREMENT METHODS.....</b>	<b>26</b>
7.1. ON TIME AND DUTY CYCLE.....	26
7.2. MEASUREMENT METHODS.....	30
<b>8. ANTENNA PORT TEST RESULTS.....</b>	<b>31</b>
8.1. 11n HT20 UAT 2 SISO MODE IN THE 5.2GHz BAND .....	31
8.1.1. 26 dB BANDWIDTH .....	31
8.1.2. 99% BANDWIDTH.....	34
8.1.3. AVERAGE POWER.....	37
8.1.4. OUTPUT POWER AND PPSD .....	38
8.2. 11n HT20 LAT 3 SISO MODE IN THE 5.2GHz BAND.....	42
8.2.1. 26 dB BANDWIDTH .....	42
8.2.2. 99% BANDWIDTH.....	45
8.2.3. AVERAGE POWER.....	48
8.2.4. OUTPUT POWER AND PPSD .....	49
8.3. 11n HT20 2TX CDD MIMO MODE IN THE 5.2GHz BAND .....	53
8.3.1. 26 dB BANDWIDTH .....	53
8.3.2. 99% BANDWIDTH.....	57
8.3.3. AVERAGE POWER.....	61
8.3.4. OUTPUT POWER AND PPSD .....	62
8.4. 11n HT40 UAT 2 SISO MODE IN THE 5.2GHz BAND .....	68

8.4.1.	26 dB BANDWIDTH .....	68
8.4.2.	99% BANDWIDTH.....	70
8.4.3.	AVERAGE POWER.....	72
8.4.4.	OUTPUT POWER AND PPSD .....	73
8.5.	<i>11n HT40 LAT 3 SISO MODE IN THE 5.2GHz BAND.....</i>	<i>76</i>
8.5.1.	26 dB BANDWIDTH .....	76
8.5.2.	99% BANDWIDTH.....	78
8.5.3.	AVERAGE POWER.....	80
8.5.4.	OUTPUT POWER AND PPSD .....	81
8.6.	<i>11n HT40 2TX CDD MIMO MODE IN THE 5.2GHz BAND.....</i>	<i>84</i>
8.6.1.	26 dB BANDWIDTH .....	84
8.6.2.	99% BANDWIDTH.....	87
8.6.3.	AVERAGE POWER.....	90
8.6.4.	OUTPUT POWER AND PPSD .....	91
8.7.	<i>11ac HT80 UAT 2 SISO MODE IN THE 5.2GHz BAND .....</i>	<i>96</i>
8.7.1.	26 dB BANDWIDTH .....	96
8.7.2.	99% BANDWIDTH.....	98
8.7.3.	AVERAGE POWER.....	100
8.7.4.	OUTPUT POWER AND PPSD .....	101
8.8.	<i>11ac HT80 LAT 3 SISO MODE IN THE 5.2GHz BAND .....</i>	<i>104</i>
8.8.1.	26 dB BANDWIDTH .....	104
8.8.2.	99% BANDWIDTH.....	106
8.8.3.	AVERAGE POWER.....	108
8.8.4.	OUTPUT POWER AND PPSD .....	109
8.9.	<i>11ac HT80 2TX CDD MIMO MODE IN THE 5.2GHz BAND .....</i>	<i>112</i>
8.9.1.	26 dB BANDWIDTH .....	112
8.9.2.	99% BANDWIDTH.....	114
8.9.3.	AVERAGE POWER.....	116
8.9.4.	OUTPUT POWER AND PPSD .....	117
8.10.	<i>11n HT20 UAT 2 SISO MODE IN THE 5.3GHz BAND.....</i>	<i>121</i>
8.10.1.	26 dB BANDWIDTH.....	121
8.10.2.	99% BANDWIDTH.....	124
8.10.3.	AVERAGE POWER .....	127
8.10.4.	OUTPUT POWER AND PPSD.....	128
8.11.	<i>11n HT20 LAT 3 SISO MODE IN THE 5.3GHz BAND .....</i>	<i>132</i>
8.11.1.	26 dB BANDWIDTH.....	132
8.11.2.	99% BANDWIDTH.....	135
8.11.3.	AVERAGE POWER .....	138
8.11.4.	OUTPUT POWER AND PPSD.....	139
8.12.	<i>11n HT20 2TX CDD MIMO MODE IN THE 5.3GHz BAND.....</i>	<i>143</i>
8.12.1.	26 dB BANDWIDTH.....	143
8.12.2.	99% BANDWIDTH.....	147
8.12.3.	AVERAGE POWER .....	151
8.12.4.	OUTPUT POWER AND PPSD.....	152
8.13.	<i>11n HT40 UAT 2 SISO MODE IN THE 5.3GHz BAND.....</i>	<i>157</i>
8.13.1.	26 dB BANDWIDTH.....	157
8.13.2.	99% BANDWIDTH.....	159
8.13.3.	AVERAGE POWER .....	161
8.13.4.	OUTPUT POWER AND PPSD.....	162

8.14.	11n HT40 LAT 3 SISO MODE IN THE 5.3GHz BAND .....	165
8.14.1.	26 dB BANDWIDTH.....	165
8.14.2.	99% BANDWIDTH.....	167
8.14.3.	AVERAGE POWER.....	169
8.14.4.	OUTPUT POWER AND PPSD.....	170
8.15.	11n HT40 2TX CDD MIMO MODE IN THE 5.3GHz BAND.....	173
8.15.1.	26 dB BANDWIDTH.....	173
8.15.2.	99% BANDWIDTH.....	176
8.15.3.	AVERAGE POWER.....	179
8.15.4.	OUTPUT POWER AND PPSD.....	180
8.16.	11ac HT80 UAT 2 SISO MODE IN THE 5.3GHz BAND .....	184
8.16.1.	26 dB BANDWIDTH.....	184
8.16.2.	99% BANDWIDTH.....	186
8.16.3.	AVERAGE POWER.....	188
8.16.4.	OUTPUT POWER AND PPSD.....	189
8.17.	11ac HT80 LAT 3 SISO MODE IN THE 5.3GHz BAND.....	192
8.17.1.	26 dB BANDWIDTH.....	192
8.17.2.	99% BANDWIDTH.....	194
8.17.3.	AVERAGE POWER.....	196
8.17.4.	OUTPUT POWER AND PPSD.....	197
8.18.	11ac HT80 2TX CDD MIMO MODE IN THE 5.3GHz BAND.....	200
8.18.1.	26 dB BANDWIDTH.....	200
8.18.2.	99% BANDWIDTH.....	202
8.18.3.	AVERAGE POWER.....	204
8.18.4.	OUTPUT POWER AND PPSD.....	205
8.19.	11n HT20 UAT 2 SISO MODE IN THE 5.6GHz BAND.....	208
8.19.1.	26 dB BANDWIDTH.....	208
8.19.2.	99% BANDWIDTH.....	211
8.19.3.	AVERAGE POWER.....	214
8.19.4.	OUTPUT POWER AND PPSD.....	215
8.19.5.	11ac HT20 UAT 2 SISO STRADDLE CHANNEL 144 (FCC).....	219
8.19.6.	6 dB BANDWIDTH.....	223
8.20.	11n HT20 LAT 3 SISO MODE IN THE 5.6GHz BAND .....	224
8.20.1.	26 dB BANDWIDTH.....	224
8.20.2.	99% BANDWIDTH.....	227
8.20.3.	AVERAGE POWER.....	230
8.20.4.	OUTPUT POWER AND PPSD.....	231
8.20.5.	11ac HT20 LAT 3 SISO STRADDLE CHANNEL 144 .....	235
8.20.6.	6 dB BANDWIDTH.....	239
8.21.	11n HT20 2TX CDD MIMO MODE IN THE 5.6GHz BAND.....	240
8.21.1.	26 dB BANDWIDTH.....	240
8.21.2.	99% BANDWIDTH.....	245
8.21.3.	AVERAGE POWER.....	250
8.21.4.	OUTPUT POWER AND PPSD.....	251
8.21.5.	11ac HT20 2TX CDD MIMO STRADDLE CHANNEL 144 .....	256
8.21.6.	6 dB BANDWIDTH.....	262
8.22.	11n HT40 UAT 2 SISO MODE IN THE 5.6GHz BAND.....	264
8.22.1.	26 dB BANDWIDTH.....	264
8.22.2.	99% BANDWIDTH.....	267

8.22.3.	AVERAGE POWER .....	270
8.22.4.	OUTPUT POWER AND PPSD.....	271
8.22.5.	11ac HT40 UAT 2 SISO STRADDLE CHANNEL 142 .....	275
8.22.6.	6 dB BANDWIDTH.....	279
8.23.	<i>11n HT40 LAT 3 SISO MODE IN THE 5.6GHz BAND .....</i>	<i>280</i>
8.23.1.	26 dB BANDWIDTH.....	280
8.23.2.	99% BANDWIDTH.....	283
8.23.3.	AVERAGE POWER .....	286
8.23.4.	OUTPUT POWER AND PPSD.....	287
8.23.5.	11ac HT40 LAT 3 SISO STRADDLE CHANNEL 142.....	291
8.23.6.	6 dB BANDWIDTH.....	295
8.24.	<i>11n HT40 2TX CDD MIMO MODE IN THE 5.6GHz BAND.....</i>	<i>296</i>
8.24.1.	26 dB BANDWIDTH.....	296
8.24.2.	99% BANDWIDTH.....	301
8.24.3.	AVERAGE POWER .....	306
8.24.4.	OUTPUT POWER AND PPSD.....	307
8.24.5.	11ac HT40 2TX CDD MIMO STRADDLE CHANNEL 142 .....	312
8.24.6.	6 dB BANDWIDTH.....	318
8.25.	<i>11ac HT80 UAT 2 SISO MODE IN THE 5.6GHz BAND .....</i>	<i>320</i>
8.25.1.	26 dB BANDWIDTH.....	320
8.25.2.	99% BANDWIDTH.....	323
8.25.3.	AVERAGE POWER .....	326
8.25.4.	OUTPUT POWER AND PPSD.....	327
8.25.5.	STRADDLE CHANNEL 138.....	330
8.25.6.	6 dB BANDWIDTH.....	334
8.26.	<i>11ac HT80 LAT 3 SISO MODE IN THE 5.6GHz BAND.....</i>	<i>335</i>
8.26.1.	26 dB BANDWIDTH.....	335
8.26.2.	99% BANDWIDTH.....	338
8.26.3.	AVERAGE POWER .....	341
8.26.4.	OUTPUT POWER AND PPSD.....	342
8.26.5.	STRADDLE CHANNEL 138.....	345
8.26.6.	6 dB BANDWIDTH.....	349
8.27.	<i>11ac HT80 2TX CDD MIMO MODE IN THE 5.6GHz BAND.....</i>	<i>350</i>
8.27.1.	26 dB BANDWIDTH.....	350
8.27.2.	99% BANDWIDTH.....	354
8.27.3.	AVERAGE POWER .....	358
8.27.4.	OUTPUT POWER AND PPSD.....	359
8.27.5.	STRADDLE CHANNEL 138.....	363
8.27.6.	6 dB BANDWIDTH.....	369
8.28.	<i>11n HT20 UAT 2 SISO MODE IN THE 5.8GHz BAND.....</i>	<i>371</i>
8.28.1.	6 dB BANDWIDTH.....	371
8.28.2.	26 dB BANDWIDTH.....	374
8.28.3.	99% BANDWIDTH.....	377
8.28.4.	AVERAGE POWER .....	380
8.28.5.	OUTPUT POWER.....	381
8.28.6.	POWER SPECTRAL DENSITY .....	383
8.29.	<i>11n HT20 LAT 3 SISO MODE IN THE 5.8GHz BAND .....</i>	<i>387</i>
8.29.1.	6 dB BANDWIDTH.....	387
8.29.2.	26 dB BANDWIDTH.....	390
8.29.3.	99% BANDWIDTH.....	393

8.29.4.	AVERAGE POWER .....	396
8.29.5.	OUTPUT POWER.....	397
8.29.6.	POWER SPECTRAL DENSITY .....	399
8.30.	<i>11n HT20 2TX CDD MIMO MODE IN THE 5.8GHz BAND.....</i>	<i>403</i>
8.30.1.	6 dB BANDWIDTH.....	403
8.30.2.	26 dB BANDWIDTH.....	407
8.30.3.	99% BANDWIDTH.....	411
8.30.4.	AVERAGE POWER .....	415
8.30.5.	OUTPUT POWER.....	416
8.30.6.	POWER SPECTRAL DENSITY .....	418
8.31.	<i>11n HT40 UAT 2 SISO MODE IN THE 5.8GHz BAND.....</i>	<i>423</i>
8.31.1.	6 dB BANDWIDTH.....	423
8.31.2.	26 dB BANDWIDTH.....	425
8.31.3.	99% BANDWIDTH.....	427
8.31.4.	AVERAGE POWER .....	429
8.31.5.	OUTPUT POWER.....	430
8.31.6.	POWER SPECTRAL DENSITY .....	432
8.32.	<i>11n HT40 LAT 3 SISO MODE IN THE 5.8GHz BAND .....</i>	<i>435</i>
8.32.1.	6 dB BANDWIDTH.....	435
8.32.2.	26 dB BANDWIDTH.....	437
8.32.3.	99% BANDWIDTH.....	439
8.32.4.	AVERAGE POWER .....	441
8.32.5.	OUTPUT POWER.....	442
8.32.6.	POWER SPECTRAL DENSITY .....	444
8.33.	<i>11n HT40 2TX CDD MIMO MODE IN THE 5.8GHz BAND.....</i>	<i>447</i>
8.33.1.	6 dB BANDWIDTH.....	447
8.33.2.	26 dB BANDWIDTH.....	450
8.33.3.	99% BANDWIDTH.....	453
8.33.4.	AVERAGE POWER .....	456
8.33.5.	OUTPUT POWER.....	457
8.33.6.	POWER SPECTRAL DENSITY .....	459
8.34.	<i>11ac HT80 UAT 2 SISO MODE IN THE 5.8GHz BAND .....</i>	<i>463</i>
8.34.1.	6 dB BANDWIDTH.....	463
8.34.2.	26 dB BANDWIDTH.....	465
8.34.3.	99% BANDWIDTH.....	467
8.34.4.	AVERAGE POWER .....	469
8.34.5.	OUTPUT POWER.....	470
8.34.6.	POWER SPECTRAL DENSITY .....	472
8.35.	<i>11ac HT80 LAT 3 SISO MODE IN THE 5.8GHz BAND.....</i>	<i>475</i>
8.35.1.	6 dB BANDWIDTH.....	475
8.35.2.	26 dB BANDWIDTH.....	477
8.35.3.	99% BANDWIDTH.....	479
8.35.4.	AVERAGE POWER .....	481
8.35.5.	OUTPUT POWER.....	482
8.35.6.	POWER SPECTRAL DENSITY .....	484
8.36.	<i>11ac HT80 2TX CDD MIMO MODE IN THE 5.8GHz BAND.....</i>	<i>487</i>
8.36.1.	6 dB BANDWIDTH.....	487
8.36.2.	26 dB BANDWIDTH.....	489
8.36.3.	99% BANDWIDTH.....	491
8.36.4.	AVERAGE POWER .....	493

8.36.5.	OUTPUT POWER.....	494
8.36.6.	POWER SPECTRAL DENSITY .....	496
<b>9.</b>	<b>RADIATED TEST RESULTS .....</b>	<b>499</b>
9.1.	LIMITS AND PROCEDURE.....	499
9.1.1.	11n HT20 UAT 2 SISO MODE IN THE 5.2GHz BAND .....	500
9.1.2.	11n HT20 LAT 3 SISO MODE IN THE 5.2GHz BAND .....	502
9.1.3.	11n HT20 2TX CDD MIMO MODE IN THE 5.2GHz BAND .....	504
9.1.4.	11n HT40 UAT 2 SISO MODE IN THE 5.2GHz BAND .....	512
9.1.5.	11n HT40 LAT 3 SISO MODE IN THE 5.2GHz BAND .....	514
9.1.6.	11n HT40 2TX CDD MIMO MODE IN THE 5.2GHz BAND .....	516
9.1.7.	11ac HT80 UAT 2 SISO MODE IN THE 5.2GHz BAND .....	522
9.1.8.	11ac HT80 LAT 3 SISO MODE IN THE 5.2GHz BAND .....	524
9.1.9.	11ac HT80 2TX CDD MIMO MODE IN THE 5.2GHz BAND .....	526
9.1.10.	11n HT20 UAT 2 SISO MODE IN THE 5.3GHz BAND.....	530
9.1.11.	11n HT20 LAT 3 SISO MODE IN THE 5.3GHz BAND .....	532
9.1.12.	11n HT20 2TX CDD MIMO MODE IN THE 5.3GHz BAND .....	534
9.1.13.	11n HT40 UAT 2 SISO MODE IN THE 5.3GHz BAND .....	542
9.1.14.	11n HT40 LAT 3 SISO MODE IN THE 5.3GHz BAND .....	544
9.1.15.	11n HT40 2TX CDD MIMO MODE IN THE 5.3GHz BAND .....	546
9.1.16.	11ac HT80 UAT 2 SISO MODE IN THE 5.3GHz BAND .....	552
9.1.17.	11ac HT80 LAT 3 SISO MODE IN THE 5.3GHz BAND.....	554
9.1.18.	11ac HT80 2TX CDD MIMO MODE IN THE 5.3GHz BAND.....	556
9.1.19.	11n HT20 UAT 2 SISO MODE IN THE 5.6GHz BAND.....	560
9.1.20.	11n HT20 LAT 3 SISO MODE IN THE 5.6GHz BAND .....	564
9.1.21.	11n HT20 2TX CDD MIMO MODE IN THE 5.6GHz BAND .....	568
9.1.22.	11ac HT20 2TX CDD MIMO STRADDLE CHANNEL 144 .....	578
9.1.23.	11n HT40 UAT 2 SISO MODE IN THE 5.6GHz BAND.....	580
9.1.24.	11n HT40 2TX CDD MIMO MODE IN THE 5.6GHz BAND .....	588
9.1.25.	11ac HT40 2TX CDD MIMO STRADDLE CHANNEL 142 .....	598
9.1.26.	11ac HT80 UAT 2 SISO MODE IN THE 5.6GHz BAND.....	600
9.1.27.	11ac HT80 LAT 3 SISO MODE IN THE 5.6GHz BAND.....	602
9.1.28.	11ac HT80 2TX CDD MIMO MODE IN THE 5.6GHz BAND.....	604
9.1.29.	11ac HT80 2TX CDD MIMO STRADDLE CHANNEL 138 .....	610
9.1.30.	11n HT20 UAT 2 SISO MODE IN THE 5.8GHz BAND.....	612
9.1.31.	11n HT20 LAT 3 SISO MODE IN THE 5.8GHz BAND .....	616
9.1.32.	11n HT20 2TX CDD MIMO MODE IN THE 5.8GHz BAND .....	620
9.1.33.	11n HT40 UAT 2 SISO MODE IN THE 5.8GHz BAND.....	630
9.1.34.	11n HT40 LAT 3 SISO MODE IN THE 5.8GHz BAND .....	634
9.1.35.	11n HT40 2TX CDD MIMO MODE IN THE 5.8GHz BAND .....	638
9.1.36.	11ac HT80 UAT 2 SISO MODE IN THE 5.8GHz BAND .....	646
9.1.37.	11ac HT80 LAT 3 SISO MODE IN THE 5.8GHz BAND.....	650
9.1.38.	11ac HT80 2TX CDD MIMO MODE IN THE 5.8GHz BAND.....	654
9.2.	WORST-CASE BELOW 1 GHz .....	660
9.3.	WORST-CASE 18 to 26 GHz .....	662
9.4.	WORST-CASE 26 to 40 GHz .....	664
<b>10.</b>	<b>AC POWER LINE CONDUCTED EMISSIONS.....</b>	<b>666</b>
10.1.	EUT POWERED BY AC/DC ADAPTER VIA USB CABLE .....	667
10.2.	EUT POWERED BY HOST PC VIA USB CABLE .....	669



**11. DYNAMIC FREQUENCY SELECTION..... 671**

- 11.1. OVERVIEW ..... 671
  - 11.1.1. LIMITS ..... 671
  - 11.1.2. TEST AND MEASUREMENT SYSTEM ..... 675
  - 11.1.3. TEST ROOM ENVIRONMENT ..... 677
  - 11.1.4. TEST AND MEASUREMENT SOFTWARE ..... 677
  - 11.1.5. SETUP OF EUT (CLIENT MODE) ..... 678
  - 11.1.6. SETUP OF EUT (CLIENT-TO-CLIENT COMMUNICATIONS MODE) ..... 679
  - 11.1.7. SETUP OF EUT (PEER TO PEER MODE) ..... 680
  - 11.1.8. DESCRIPTION OF EUT ..... 682
- 11.2. CLIENT MODE RESULTS FOR 20 MHz BANDWIDTH ..... 684
  - 11.2.1. TEST CHANNEL ..... 684
  - 11.2.2. RADAR WAVEFORM AND TRAFFIC ..... 684
  - 11.2.3. OVERLAPPING CHANNEL TESTS ..... 687
  - 11.2.4. MOVE AND CLOSING TIME ..... 687
- 11.3. CLIENT MODE RESULTS FOR 40 MHz BANDWIDTH ..... 691
  - 11.3.1. TEST CHANNEL ..... 691
  - 11.3.2. RADAR WAVEFORM AND TRAFFIC ..... 691
  - 11.3.3. OVERLAPPING CHANNEL TESTS ..... 694
  - 11.3.4. MOVE AND CLOSING TIME ..... 694
- 11.4. CLIENT MODE RESULTS FOR 80 MHz BANDWIDTH ..... 698
  - 11.4.1. TEST CHANNEL ..... 698
  - 11.4.2. RADAR WAVEFORM AND TRAFFIC ..... 698
  - 11.4.3. OVERLAPPING CHANNEL TESTS ..... 701
  - 11.4.4. MOVE AND CLOSING TIME ..... 701
  - 11.4.5. 30-MINUTE NON-OCCUPANCY PERIOD ..... 705
- 11.5. CLIENT-TO-CLIENT COMMUNICATIONS MODE RESULTS FOR 20 MHz BANDWIDTH  
706
  - 11.5.1. TEST CHANNEL ..... 706
  - 11.5.2. RADAR WAVEFORM AND TRAFFIC ..... 706
  - 11.5.3. OVERLAPPING CHANNEL TESTS ..... 709
  - 11.5.4. MOVE AND CLOSING TIME ..... 709
- 11.6. CLIENT-TO-CLIENT COMMUNICATIONS MODE RESULTS FOR 40 MHz BANDWIDTH  
713
  - 11.6.1. TEST CHANNEL ..... 713
  - 11.6.2. RADAR WAVEFORM AND TRAFFIC ..... 713
  - 11.6.3. OVERLAPPING CHANNEL TESTS ..... 716
  - 11.6.4. MOVE AND CLOSING TIME ..... 716
- 11.7. CLIENT-TO-CLIENT COMMUNICATIONS MODE RESULTS FOR 80 MHz BANDWIDTH  
720
  - 11.7.1. TEST CHANNEL ..... 720
  - 11.7.2. RADAR WAVEFORM AND TRAFFIC ..... 720
  - 11.7.3. OVERLAPPING CHANNEL TESTS ..... 723
  - 11.7.4. MOVE AND CLOSING TIME ..... 723
  - 11.7.5. 30-MINUTE NON-OCCUPANCY PERIOD ..... 727
- 11.8. PEER TO PEER MODE EUT RESULTS FOR 20 MHz BANDWIDTH ..... 728
  - 11.8.1. TEST CHANNEL ..... 728
  - 11.8.2. RADAR WAVEFORM AND TRAFFIC ..... 728
  - 11.8.3. OVERLAPPING CHANNEL TESTS ..... 731

---

11.8.4.	MOVE AND CLOSING TIME .....	731
11.9.	<i>PEER TO PEER MODE EUT RESULTS FOR 40 MHz BANDWIDTH</i> .....	735
11.9.1.	TEST CHANNEL.....	735
11.9.2.	RADAR WAVEFORM AND TRAFFIC .....	735
11.9.3.	OVERLAPPING CHANNEL TESTS .....	738
11.9.4.	MOVE AND CLOSING TIME .....	738
11.10.	<i>PEER TO PEER MODE EUT RESULTS FOR 80 MHz BANDWIDTH</i> .....	742
11.10.1.	TEST CHANNEL.....	742
11.10.2.	RADAR WAVEFORM AND TRAFFIC .....	742
11.10.3.	OVERLAPPING CHANNEL TESTS .....	745
11.10.4.	MOVE AND CLOSING TIME .....	745
11.10.5.	30-MINUTE NON-OCCUPANCY PERIOD.....	749
11.11.	<i>PEER TO PEER MODE PEER SLAVE DEVICE RESULTS FOR 20 MHz BANDWIDTH</i>	750
11.11.1.	TEST CHANNEL.....	750
11.11.2.	RADAR WAVEFORM AND TRAFFIC .....	750
11.11.3.	OVERLAPPING CHANNEL TESTS .....	753
11.11.4.	MOVE AND CLOSING TIME .....	753
11.12.	<i>PEER TO PEER MODE PEER SLAVE DEVICE RESULTS FOR 40 MHz BANDWIDTH</i>	757
11.12.1.	TEST CHANNEL.....	757
11.12.2.	RADAR WAVEFORM AND TRAFFIC .....	757
11.12.3.	OVERLAPPING CHANNEL TESTS .....	760
11.12.4.	MOVE AND CLOSING TIME .....	760
11.13.	<i>PEER TO PEER MODE PEER SLAVE DEVICE RESULTS FOR 80 MHz BANDWIDTH</i>	764
11.13.1.	TEST CHANNEL.....	764
11.13.2.	RADAR WAVEFORM AND TRAFFIC .....	764
11.13.3.	OVERLAPPING CHANNEL TESTS .....	767
11.13.4.	MOVE AND CLOSING TIME .....	767
11.13.5.	30-MINUTE NON-OCCUPANCY PERIOD.....	771
<b>12.</b>	<b>SETUP PHOTOS</b> .....	<b>772</b>

# 1. ATTESTATION OF TEST RESULTS

**COMPANY NAME:** APPLE, INC.  
1 INFINITE LOOP  
CUPERTINO, CA 95014, U.S.A.

**EUT DESCRIPTION:** SMARTPHONE

**MODEL:** A1901

**SERIAL NUMBER:** C39TX016J8QN; C39TM018J578 (DFS)

**DATE TESTED:** MAY 16, 2017 – AUGUST 07, 2017

APPLICABLE STANDARDS	
STANDARD	TEST RESULTS
CFR 47 Part 15 Subpart E	Pass

UL Verification Services Inc. tested the above equipment in accordance with the requirements set forth in the above standards. All indications of Pass/Fail in this report are opinions expressed by UL Verification Services Inc. based on interpretations and/or observations of test results. Measurement Uncertainties were not taken into account and are published for informational purposes only. The test results show that the equipment tested is capable of demonstrating compliance with the requirements as documented in this report.

**Note:** The results documented in this report apply only to the tested sample, under the conditions and modes of operation as described herein. This document may not be altered or revised in any way unless done so by UL Verification Services Inc. and all revisions are duly noted in the revisions section. Any alteration of this document not carried out by UL Verification Services Inc. will constitute fraud and shall nullify the document. This report must not be used by the client to claim product certification, approval, or endorsement by NVLAP, NIST, any agency of the Federal Government, or any agency of any government.

Approved & Released For  
UL Verification Services Inc. By:



Chin Pang  
Senior Engineer  
UL VERIFICATION SERVICES INC.

Prepared By:



Tri Pham  
Test Engineer  
UL VERIFICATION SERVICES INC.

## 2. TEST METHODOLOGY

FCC: The tests documented in this report were performed in accordance with FCC CFR 47 Part 2, FCC CFR 47 Part 15, FCC 14-30, FCC KDB 662911 D01 v02r01, FCC KDB 905462 D02 v02/D03 v01r02/D04 v01/D06 v02/ D07v02, FCC KDB 789033 D02 v01r04, FCC KDB 644545 D03 v01, ANSI C63.10-2013.

## 3. FACILITIES AND ACCREDITATION

The test sites and measurement facilities used to collect data are located at 47173 and 47266 Benicia Street, Fremont, California, USA. Line conducted emissions are measured only at the 47173 address. The following table identifies which facilities were utilized for radiated emission measurements documented in this report. Specific facilities are also identified in the test results sections.

47173 Benicia Street	47266 Benicia Street
<input type="checkbox"/> Chamber A (IC:2324B-1)	<input checked="" type="checkbox"/> Chamber D (IC: 22541-1)
<input type="checkbox"/> Chamber B (IC:2324B-2)	<input checked="" type="checkbox"/> Chamber E (IC: 22541-2)
<input type="checkbox"/> Chamber C (IC:2324B-3)	<input type="checkbox"/> Chamber F (IC: 22541-3)
	<input type="checkbox"/> Chamber G (IC: 22541-4)
	<input type="checkbox"/> Chamber H (IC: 22541-5)

The above test sites and facilities are covered under FCC Test Firm Registration # 208313.

UL Verification Services Inc. is accredited by NVLAP, Laboratory Code 200065-0. The full scope of accreditation can be viewed at <http://ts.nist.gov/standards/scopes/2000650.htm>.

## 4. CALIBRATION AND UNCERTAINTY

### 4.1. MEASURING INSTRUMENT CALIBRATION

The measuring equipment utilized to perform the tests documented in this report has been calibrated in accordance with the manufacturer's recommendations, and is traceable to recognized national standards.

### 4.2. SAMPLE CALCULATION

Where relevant, the following sample calculation is provided:

$$\text{Field Strength (dBuV/m)} = \text{Measured Voltage (dBuV)} + \text{Antenna Factor (dB/m)} + \text{Cable Loss (dB)} - \text{Preamp Gain (dB)}$$

$$36.5 \text{ dBuV} + 18.7 \text{ dB/m} + 0.6 \text{ dB} - 26.9 \text{ dB} = 28.9 \text{ dBuV/m}$$

### 4.3. MEASUREMENT UNCERTAINTY

Where relevant, the following measurement uncertainty levels have been estimated for tests performed on the apparatus:

Where relevant, the following measurement uncertainty levels have been estimated for tests performed on the apparatus:

Parameter	Uncertainty
Worst Case Conducted Disturbance, 9KHz to 0.15 MHz	3.84 dB
Worst Case Conducted Disturbance, 0.15 to 30 MHz	3.65 dB
Worst Case Radiated Disturbance, 9KHz to 30 MHz	3.15 dB
Worst Case Radiated Disturbance, 30 to 1000 MHz	5.36 dB
Worst Case Radiated Disturbance, 1000 to 18000 MHz	4.32 dB
Worst Case Radiated Disturbance, 18000 to 26000 MHz	4.45 dB
Worst Case Radiated Disturbance, 26000 to 40000 MHz	5.24 dB
Occupied Channel Bandwidth	±0.39 %
Time	±0.02 %

Uncertainty figures are valid to a confidence level of 95%.

## 5. EQUIPMENT UNDER TEST

### 5.1. DESCRIPTION OF EUT

The Equipment Under Test is a mobile phone with GSM, GPRS, EGPRS, UMTS, LTE and TD-SCDMA technologies. It also supports IEEE 802.11a/b/g/n/ac, Bluetooth®, GPS and NFC. The device has a built-in inductive charging receiver which is not user accessible. The rechargeable battery is not user accessible.

### 5.2. MAXIMUM OUTPUT POWER

The transmitter has a maximum conducted output power as follows:

NOTE: Covered modes are test reduction modes. The output powers on the “covered modes are equal to or less than the mode referenced and use the same modulation.

#### 5.2GHz Band

Frequency Range (MHz)	Mode	Output Power (dBm)	Output Power (mW)
5180 - 5240	802.11a	Covered by 802.11n HT20 SISO	
	802.11n HT20 SISO	20.95	124.45
	802.11n VHT20 1TX	Covered by 802.11n HT20 SISO	
	802.11n HT20 CDD 2TX	20.91	123.31
	802.11n HT20 STBC/SDM 2TX, 802.11ac VHT20 STBC/SDM 2TX	Covered by 802.11n HT20 2TX CDD	
5190 - 5230	802.11n HT40 SISO	19.39	86.90
	802.11n VHT40 1TX	Covered by 802.11n HT20 SISO	
	802.11n HT40 CDD 2TX	22.33	171.00
	802.11n HT40 STBC/SDM 2TX, 802.11ac VHT40 STBC/SDM 2TX	Covered by 802.11n HT40 2TX CDD	
5210	802.11ac VHT80 SISO	17.36	54.45
	802.11ac VHT80 CDD 2TX	19.33	85.70
	802.11ac VHT80 STBC/SDM 2TX	Covered by 802.11ac VHT80 2TX CDD	

**5.3GHz Band**

Frequency Range (MHz)	Mode	Output Power (dBm)	Output Power (mW)
5260 - 5320	802.11a	Covered by 802.11n HT20 SISO	
	802.11n HT20 SISO	20.88	122.46
	802.11n VHT20 1TX	Covered by 802.11n HT20 SISO	
	802.11n HT20 CDD 2TX	20.91	123.31
	802.11n HT20 STBC/SDM 2TX, 802.11ac VHT20 STBC/SDM 2TX	Covered by 802.11n HT20 2TX CDD	
5270 - 5310	802.11n HT40 SISO	19.48	88.72
	802.11n VHT40 1TX	Covered by 802.11n HT40 SISO	
	802.11n HT40 CDD 2TX	22.26	168.27
	802.11n HT40 STBC/SDM 2TX, 802.11ac VHT40 STBC/SDM 2TX	Covered by 802.11n HT40 2TX CDD	
5290	802.11ac VHT80 SISO	17.47	55.85
	802.11ac VHT80 CDD 2TX	19.39	86.90
	802.11ac VHT80 STBC/SDM 2TX	Covered by 802.11ac HT80 2TX CDD	

**5.6GHz Band**

Frequency Range (MHz)	Mode	Output Power (dBm)	Output Power (mW)
5500 - 5700	802.11a	Covered by 802.11n HT20 SISO	
5500 - 5700	802.11n HT20 SISO	20.94	124.17
	802.11n VHT20 1TX	Covered by 802.11n HT20 SISO	
5720	802.11ac VHT20 SISO (based on UNII-2C band output power)	19.38	86.70
5500 - 5700	802.11n HT20 CDD 2TX	20.86	121.90
	802.11n HT20 STBC/SDM 2TX, 802.11ac VHT20 STBC/SDM 2TX	Covered by 802.11n HT20 CDD 2TX	
5720	802.11ac VHT20 CDD 2TX (based on UNII-2C band output power)	19.02	79.80
	802.11ac VHT20 STBC SISO/2TX (based on UNII-2C band output power)	Covered by 802.11n HT20 2TX CDD	
5510 - 5670	802.11n HT40 SISO	19.47	88.51
	802.11n HT40 1TX	Covered by 802.11n HT40 SISO	
5710	802.11ac VHT40 SISO (based on UNII-2C band output power)	18.92	77.98
5510 - 5670	802.11n HT40 CDD 2TX	22.31	170.22
	802.11n HT40 STBC/SDM 2TX, 802.11ac VHT40 STBC/SDM 2TX	Covered by 802.11n HT40 CDD 2TX	
5710	802.11ac VHT40 CDD 2TX (based on UNII-2C band output power)	21.11	129.12
	802.11ac VHT40 STBC/SDM 2TX	Covered by 802.11ac VHT40 CDD 2TX	
5530-5610	802.11ac VHT80 SISO	19.43	87.70
5690	802.11ac VHT80 SISO (based on UNII-2C band output power)	19.14	82.04
5530-5610	802.11ac VHT80 CDD 2TX	22.34	171.40
	802.11ac VHT80 STBC/SDM 2TX	Covered by 802.11ac VHT80 CDD 2TX	
5690	802.11ac VHT80 CDD 2TX (based on UNII-2C band output power)	22.15	164.06
	802.11ac VHT80 STBC/SDM 2TX	Covered by 802.11ac VHT80 CDD 2TX	



**5.8GHz Band**

Frequency Range (MHz)	Mode	Output Power (dBm)	Output Power (mW)
5745 - 5825	802.11a	Covered by 802.11n HT20 SISO	
	802.11n HT20 SISO	21.46	139.96
	802.11n VHT20 1TX	Covered by 802.11n HT20 SISO	
	802.11n HT20 CDD 2TX	24.40	275.42
	802.11n HT20 STBC/SDM 2TX, 802.11ac VHT20 STBC/SDM 2TX	Covered by 802.11n HT20 CDD 2TX	
5755 - 5795	802.11n HT40 SISO	19.47	88.51
	802.11n VHT40 1TX	Covered by 802.11n HT40 SISO	
	802.11n HT40 CDD 2TX	22.31	170.22
	802.11n HT40 STBC/SDM 2TX, 802.11ac VHT40 STBC/SDM 2TX	Covered by 802.11n HT40 CDD 2TX	
5775	802.11ac VHT80 SISO	19.44	87.90
	802.11ac VHT80 CDD 2TX	22.41	174.18
	802.11ac VHT80 STBC/SDM 2TX	Covered by 802.11ac VHT80 CDD 2TX	

**5.3. DESCRIPTION OF AVAILABLE ANTENNAS**

Frequency Band (GHz)	Antenna Gain (dBi)	
	UAT 2	LAT 3
5.2	-2.72	-7.38
5.3	-3.11	-6.98
5.5	-2.77	-6.89
5.8	-3.57	-6.31

**5.4. SOFTWARE AND FIRMWARE**

The firmware installed in the EUT during testing was version 13.10.452.12

### 5.5. WORST-CASE CONFIGURATION AND MODE

For radiated harmonics spurious below 1GHz, 1-18GHz L/M/H channels, 18-40GHz, and power line conducted emissions were performed with the EUT set at the CDD mode among the CDD/STBC/SDM modes with power setting equal or higher than SISO modes as worst-case scenario.

Radiated band edge, harmonic, and spurious emissions from 1GHz to 18GHz were performed with the EUT was set to transmit at highest power on Low/Middle/High channels.

Radiated emissions below 30MHz, below 1GHz, above 18GHz and power line conducted emissions were performed with the EUT transmits at the channel with the highest output power as worst-case scenario.

For SISO modes, there are two transmission antennas. The antenna used in any given time can be either UAT 2 or LAT 3. Both antenna ports have the same power; output power and PSD measurement for SISO modes on both antennas are reported. For MIMO modes, both UAT 2 and LAT 3 used at the same time.

The fundamental of the EUT was investigated in three orthogonal orientations X (Flatbed), Y (Landscape), Z (Portrait), on both UAT 2 and LAT 3 antennas. In addition, the EUT was also investigated with and without AC/DC charger, headphones & laptop, It was determined that (see table below) was worst-case orientation for both antennas without AC/DC charger, headphones, or laptop; therefore, all final radiated testing was performed with EUT only in (see table below) orientation for 1 - 18GHz and 18 – 40GHz. And for 30-1000MHz EUT was tested with AC/DC charger.

All radiated harmonic 1-18GHz emissions on SISO mode, straddle channels are covered by 2TX MIMO mode with power setting equal or higher than SISO among the CDD/STBC/SDM modes.

Frequency Band (GHz)	Mode	Antenna Port	Worst-case Orientation
5.2-5.8	1TX SISO	UAT 2	Y-Landscape
		LAT 3	Y-Landscape
	2TX MIMO	UAT 2 + LAT 3	Y-Landscape

Worst-case data rates as provided by the client were:

- 802.11a mode: 6 Mbps
- 802.11n HT20 mode: MCS0
- 802.11n HT40 mode: MCS0
- 802.11ac VHT20 mode: MCS0
- 802.11ac VHT40 mode: MCS0
- 802.11ac VHT80 mode: MCS0

802.11ac VHT20 and VHT40 mode are different from 802.11nHT20 and HT40 only in control messages and have the same power settings.

There are two vendors of the WiFi/Bluetooth radio modules: variant 1 and variant 2. The WiFi/Bluetooth radio modules have the same mechanical outline (e.g., the same package dimension and pin-out layout), use the same on-board antenna matching circuit, have an identical antenna structure, and are built and tested to conform to the same specifications and to operate within the same tolerances.

Baseline testing was performed on the two variants to determine the worst case on all conducted power and radiated emissions.

For simultaneous transmission of multiple channels from the same antenna LAT 3 in the 2.4GHz BT/BLE and 5GHz bands, tests were conducted for various configurations having the highest power. No noticeable new emission was found.

## 5.6. DESCRIPTION OF TEST SETUP

### SUPPORT EQUIPMENT

Support Equipment List				
Description	Manufacturer	Model	Serial Number	FCC ID
Laptop AC/DC adapter	Apple	A1344	T1580	NA
Laptop	Apple	A1278	C02HJ0A7DTY4	NA
DC power supply	Lambda	GEN 60-25	SCPV56329	NA

### I/O CABLES (CONDUCTED TEST)

I/O Cable List						
Cable No	Port	# of identical ports	Connector Type	Cable Type	Cable Length (m)	Remarks
1	Antenna	1	SMA	Shielded	1	N/A
2	USB	1	USB	Shielded	1	Laptop to EUT
3	AC	1	AC	Un-shielded	3	N/A
4	Aligator clip	1	minigrabber	Un-Shielded	1	DC power supply to EUT

### I/O CABLES (RADIATED ABOVE 1 GHZ)

I/O Cable List						
Cable No	Port	# of identical ports	Connector Type	Cable Type	Cable Length (m)	Remarks
NA						

### I/O CABLES (AC POWER CONDUCTED TEST AND BELOW 1 GHZ)

I/O Cable List						
Cable No	Port	# of identical ports	Connector Type	Cable Type	Cable Length (m)	Remarks
1	AC	1	AC	Un-shielded	3	N/A

### I/O CABLES (AC LINE CONDUCTED: LAPTOP CONFIGUARTION)

I/O Cable List						
Cable No	Port	# of identical	Connector Type	Cable Type	Cable Length (m)	Remarks
1	AC	1	AC	Un-shielded	3	N/A
2	USB	1	USB	Shielded	1	N/A

**TEST SETUP**

The EUT was tested connected to a host Laptop via USB cable adapter and SMA cable connected to antenna port. Test software exercised the EUT.

**SETUP DIAGRAM**

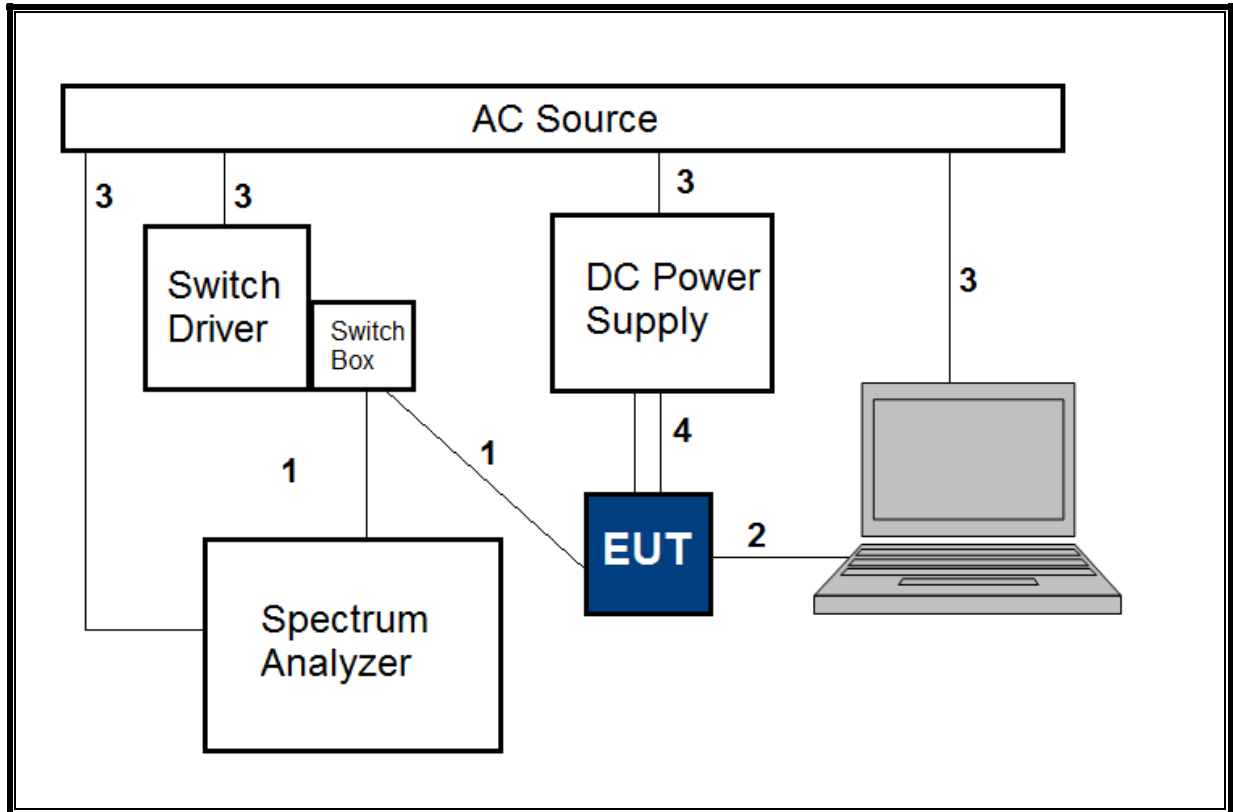

**TEST SETUP- RADIATED-ABOVE 1 GHZ**

The EUT was powered by battery. Test software exercised the EUT.

**SETUP DIAGRAM**

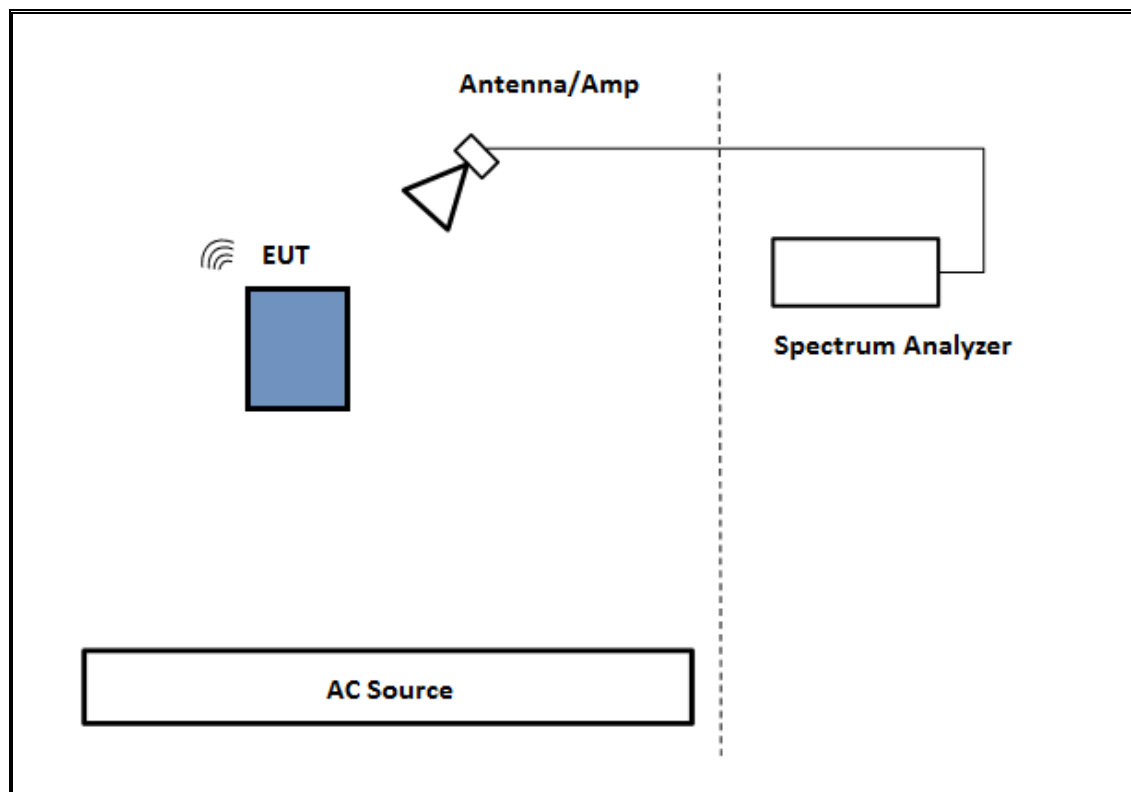

**TEST SETUP- BELOW 1GHZ & AC LINE CONDUCTED TESTS**

The EUT was powered by AC/DC adapter. Test software exercised the EUT.

**SETUP DIAGRAM**

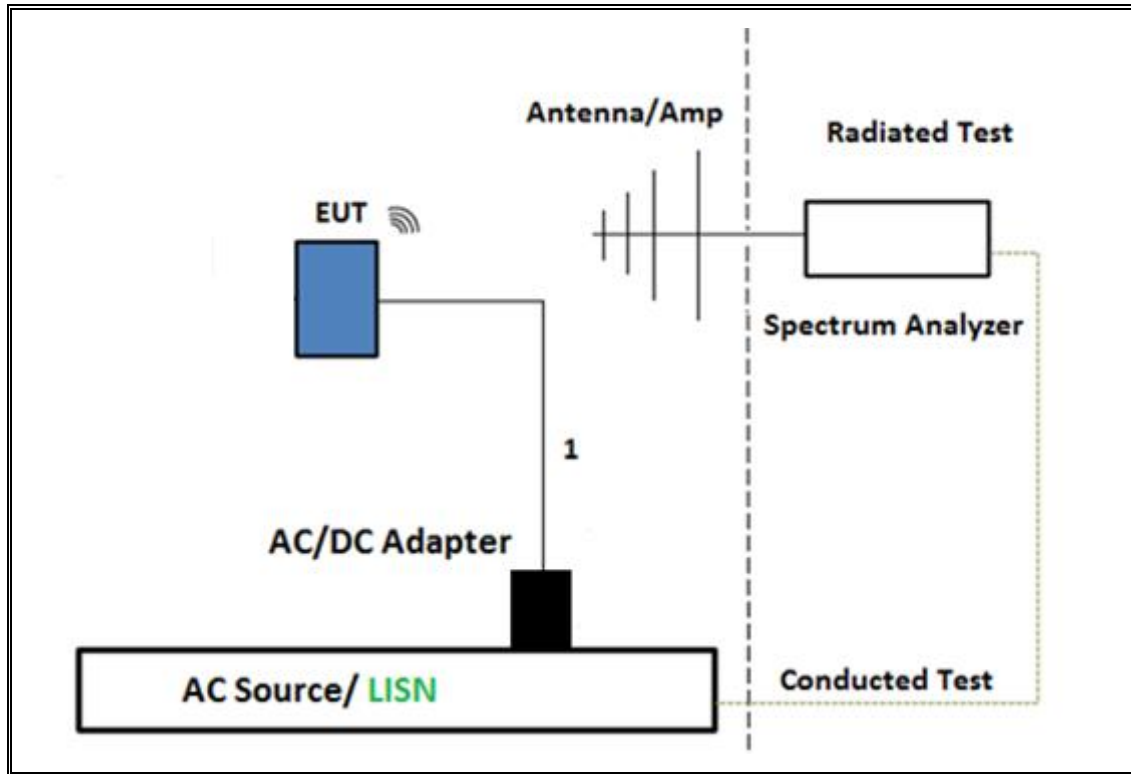

**TEST SETUP- AC LINE CONDUCTED TEST (LAPTOP CONFIGURATION)**

The EUT was tested connected to a host Laptop via USB cable. Test software exercised the EUT.

**SETUP DIAGRAM**

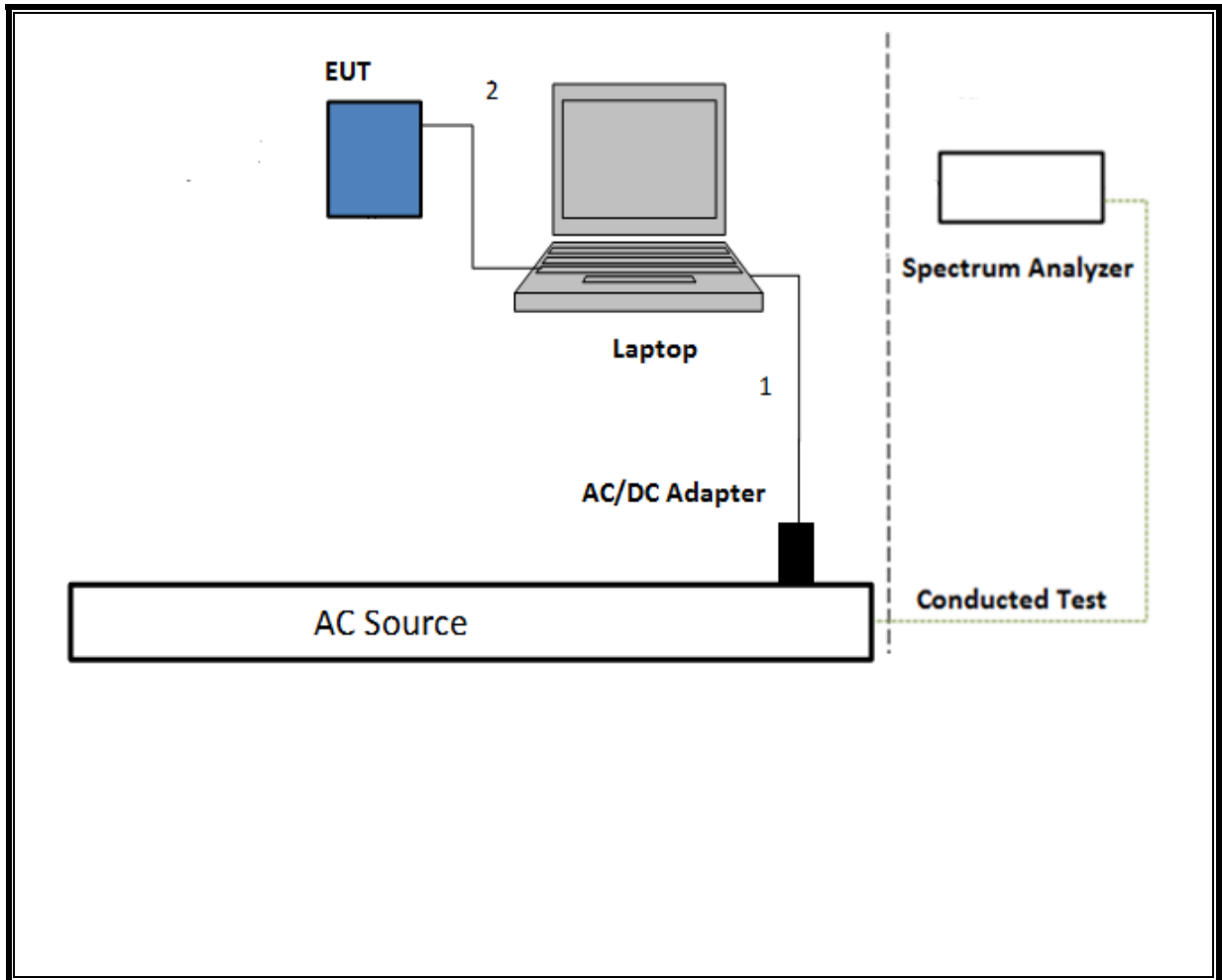



## 6. TEST AND MEASUREMENT EQUIPMENT

TEST EQUIPMENT LIST				
Description	Manufacturer	Model	Asset	Cal Due
Antenna, Horn 1-18GHz	ETS Lindgren	3117	T863	6/9/2018
Amplifier, 1 to 18GHz	Miteq	AFS42-00101800-25-S-42	T741	11/29/2017
Antenna, Horn 1-18GHz	ETS Lindgren	3117	T344	4/20/2018
*Antenna, Broadband Hybrid, 30MHz to 2000MHz	Sunol Sciences	JB3	T900	5/03/2017
Amplifier, 1 to 18GHz, 35dB	Amplical	AMP1G18-35	T1569	9/15/2017
*Amplifier, 10KHz to 1GHz, 32dB	Sonoma	310N	T285	6/20/2017
Spectrum Analyzer, PXA 3Hz to 44GHz	Keysight	N9030A	T1613	12/2/2017
*Antenna Horn, 18 to 26GHz	ARA	MWH-1826	T447	6/16/2017
*Amplifier, 1 to 26.5GHz 23.5dB gain Minimum	Keysight	8449B	T402	7/5/2017
Spectrum Analyzer, 40GHz	Agilent	8564E	T106	9/7/2017
*Antenna, Horn 26.5GHz to 40GHz	ARA	MWH-2640/B	T446	5/25/2017
*Amplifier, 26.5GHz to 40GHz	Miteq	NSP 4000 SP2	T88	4/29/2017
Horn Antenna, 40GHz	ARA	MWH-2640/B	1029	8/19/2017
*Pre-Amp 18-26GHz	Agilent Technology	8449B	T404	7/5/2017
Power Meter, P-series single channel	Keysight	N1912A	T1245	1/05/2018
Power Sensor	Keysight	N1921A	T1224	1/31/2018
AC Line Conducted				
EMI Test Receiver 9Khz-7GHz	Rohde & Schwarz	ESCI7	T1436	01/06/2018
*LISN for Conducted Emissions CISPR-16	Fischer	50/250-25-2-01	T1310	06/08/2017
Power Cable, Line Conducted Emissions	UL	PG1	T861	9/1/2017
UL AUTOMATION SOFTWARE				
Radiated Software	UL	UL EMC	Ver 9.5, April 26, 2016	
Conducted Software	UL	UL EMC	Ver 5.4, October 13, 2016	
AC Line Conducted Software	UL	UL EMC	Ver 9.5, May 26, 2015	

The following test and measurement equipment was utilized for the tests documented in this report:

NOTE: \*testing is completed before equipment calibration expiration date.

## 7. ON TIME, DUTY CYCLE AND MEASUREMENT METHODS

### 7.1. ON TIME AND DUTY CYCLE

#### LIMITS

None; for reporting purposes only.

#### PROCEDURE

KDB 789033 Zero-Span Spectrum Analyzer Method.

#### RESULTS

Mode	ON Time B (msec)	Period (msec)	Duty Cycle x (linear)	Duty Cycle (%)	Duty Cycle Correction Factor (dB)	1/B Minimum VBW (kHz)
802.11n HT20 1TX	1.921	1.940	0.990	99.02%	0.00	0.010
802.11n HT20 CDD 2TX	1.921	1.940	0.990	99.02%	0.00	0.010
802.11n HT40 1TX	0.944	0.965	0.978	97.83%	0.10	1.059
802.11n HT40 CDD 2TX	0.944	0.966	0.978	97.76%	0.10	1.059
802.11ac VHT80 1TX	0.4599	0.4810	0.956	95.61%	0.19	2.174
802.11ac VHT80 CDD 2TX	0.4599	0.4808	0.957	95.65%	0.19	2.174

**DUTY CYCLE PLOTS**

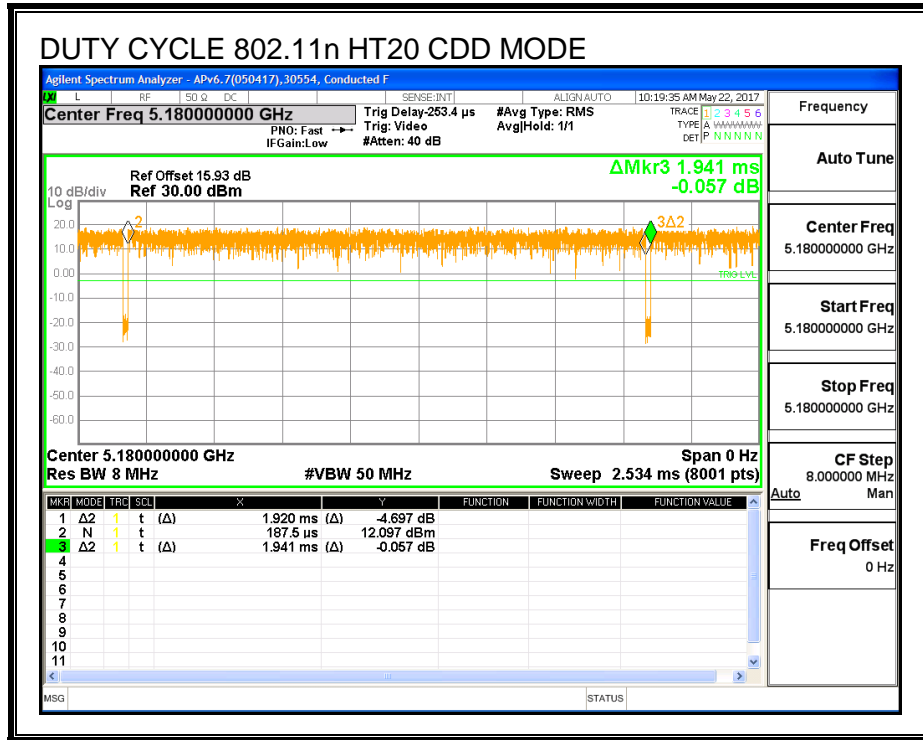
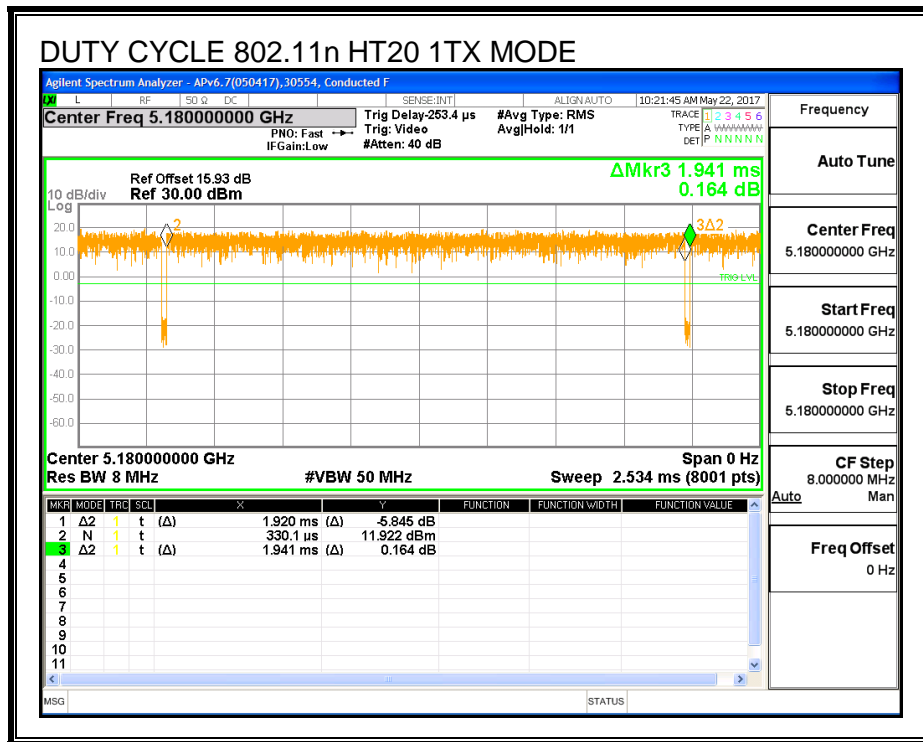

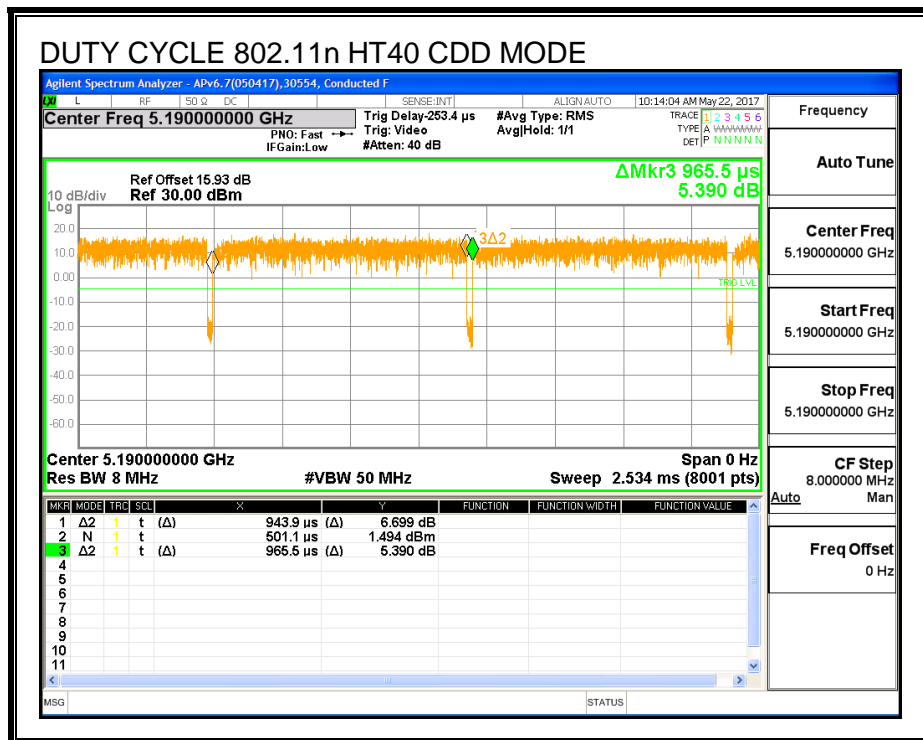
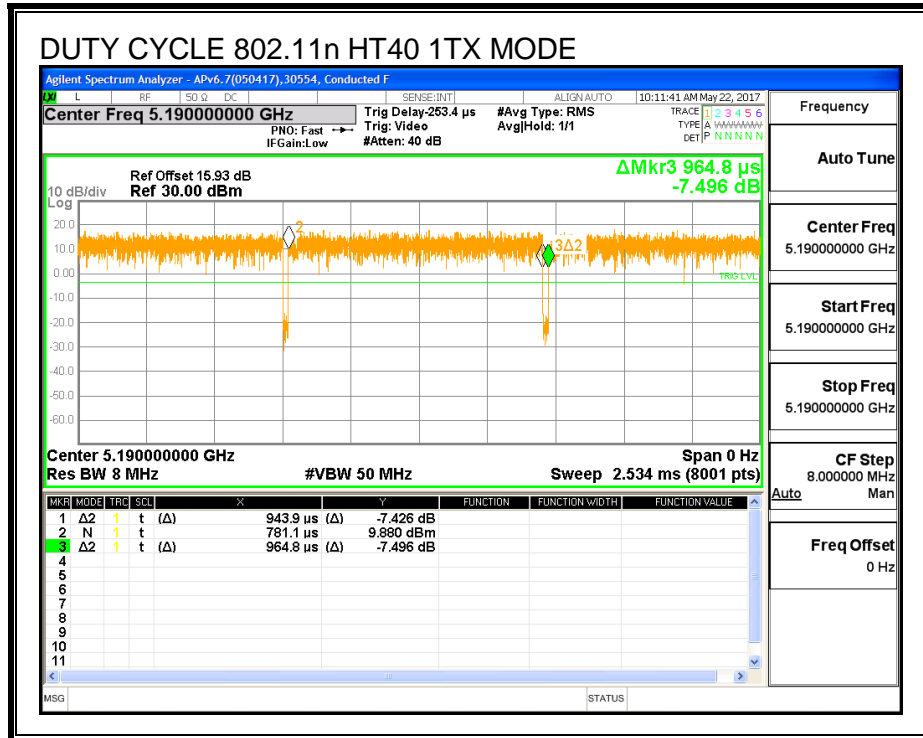

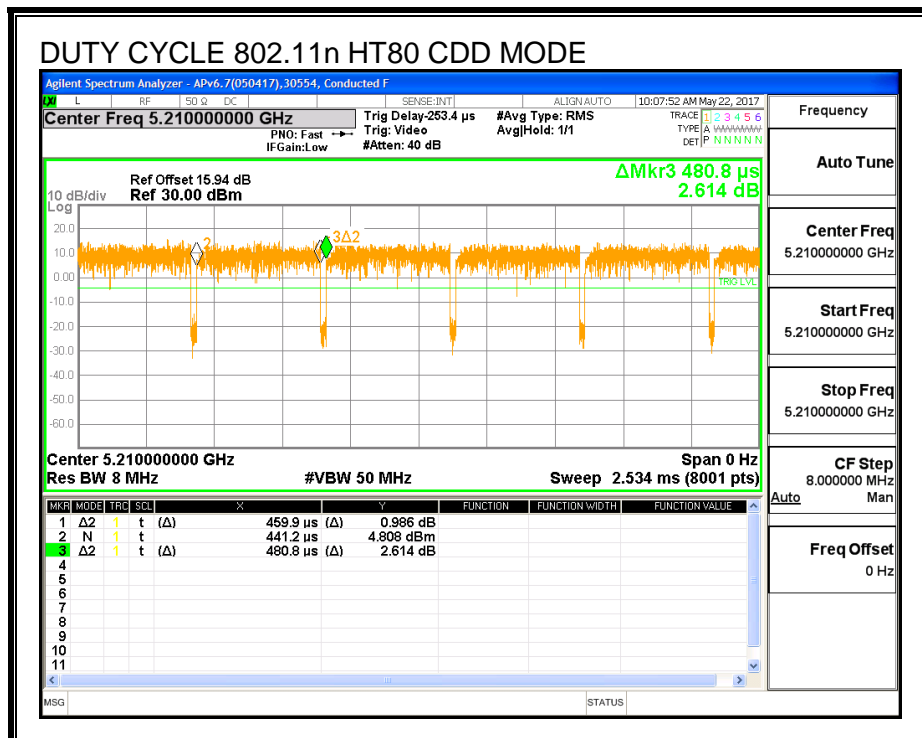
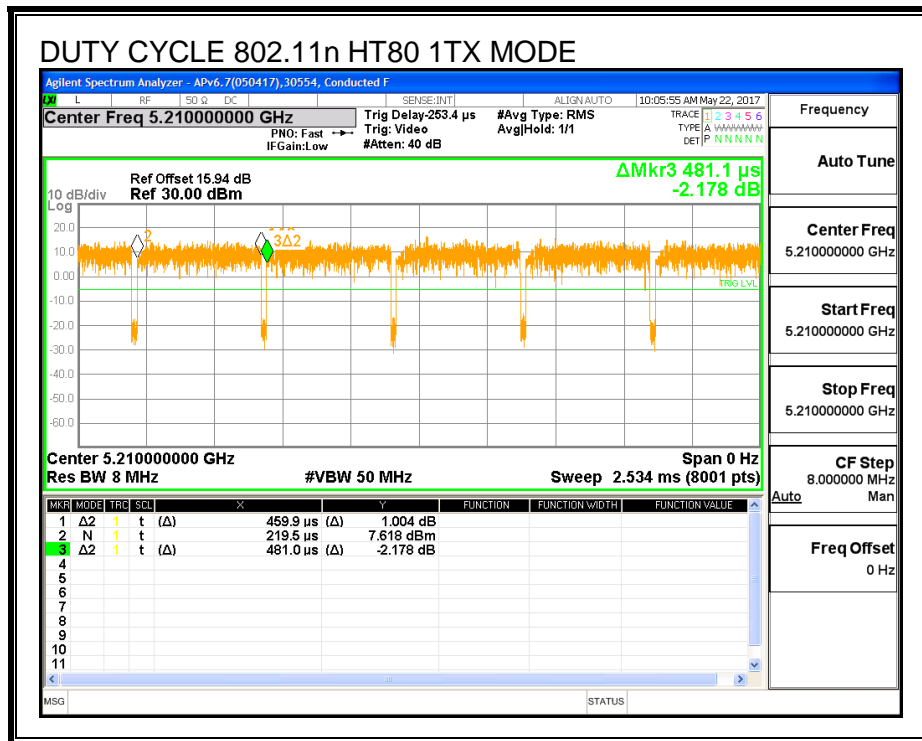

## 7.2. MEASUREMENT METHODS

6 dB Emission BW: KDB 789033 D02 v01r04, Section C.

26 dB Emission BW: KDB 789033 D02 v01r04, Section C.

99% Occupied BW: KDB 789033 D02 v01r04, Section D.

Conducted Output Power: KDB 789033 D02 v01r04, Section E.3.b (Method PM-G).

Power Spectral Density: KDB 789033 D02 v01r04, Section F (Method SA-2).

Unwanted emissions in restricted bands: KDB 789033 D02 v01r04, Sections G.3, G.4, G.5, and G.6.

Unwanted emissions in non-restricted bands: KDB 789033 D02 v01r04, Sections G.3, G.4, and G.5.

Conducted line emissions: C63.10, Clause 6.2

## 8. ANTENNA PORT TEST RESULTS

### 8.1. 11n HT20 UAT 2 SISO MODE IN THE 5.2GHz BAND

#### 8.1.1. 26 dB BANDWIDTH

##### LIMITS

None; for reporting purposes only.

##### RESULTS

Channel	Frequency	26 dB BW UAT 2 (MHz)
Low	5180	21.95
Mid	5200	22.00
High	5240	21.95

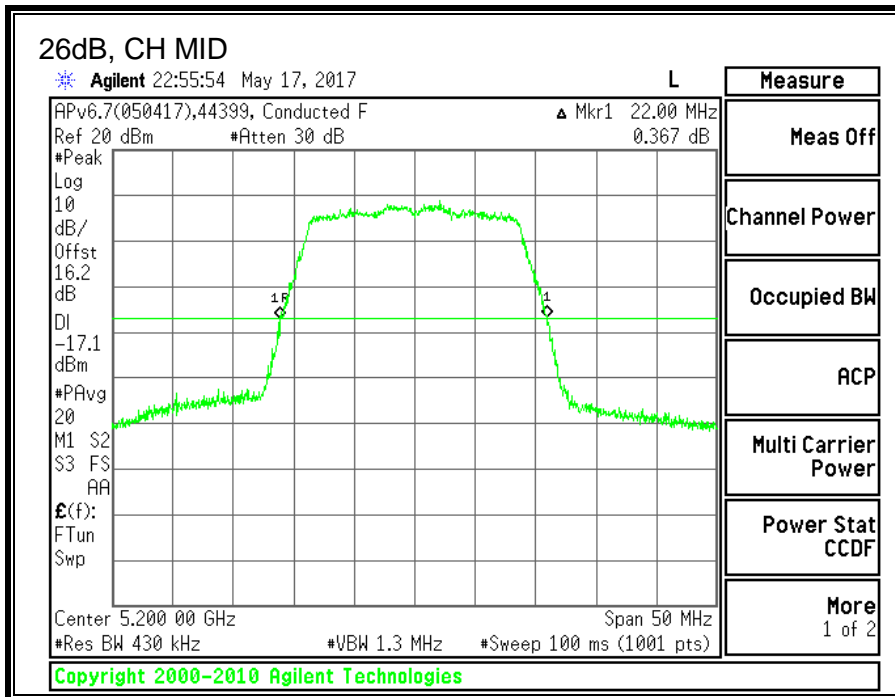
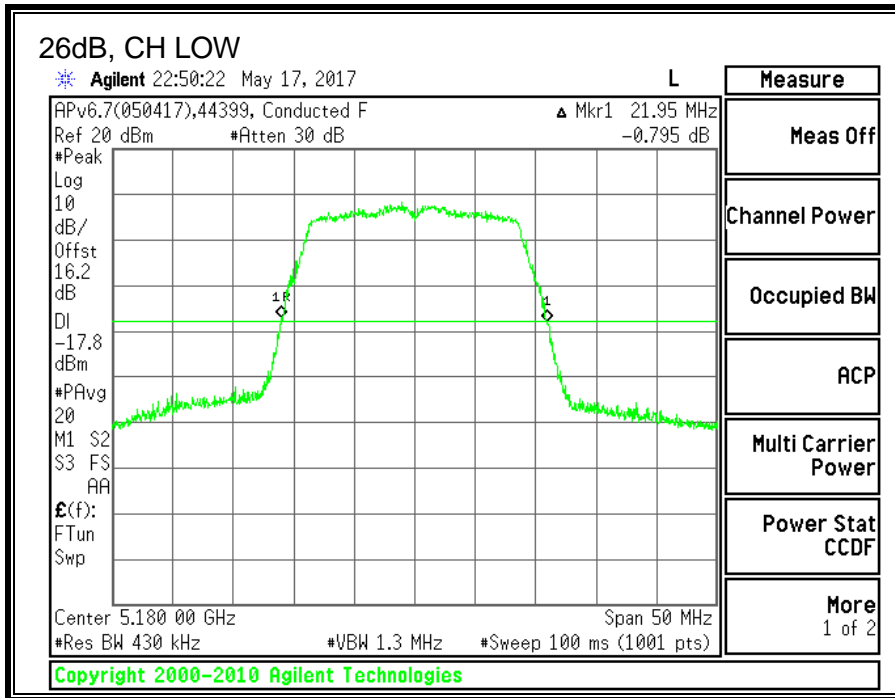



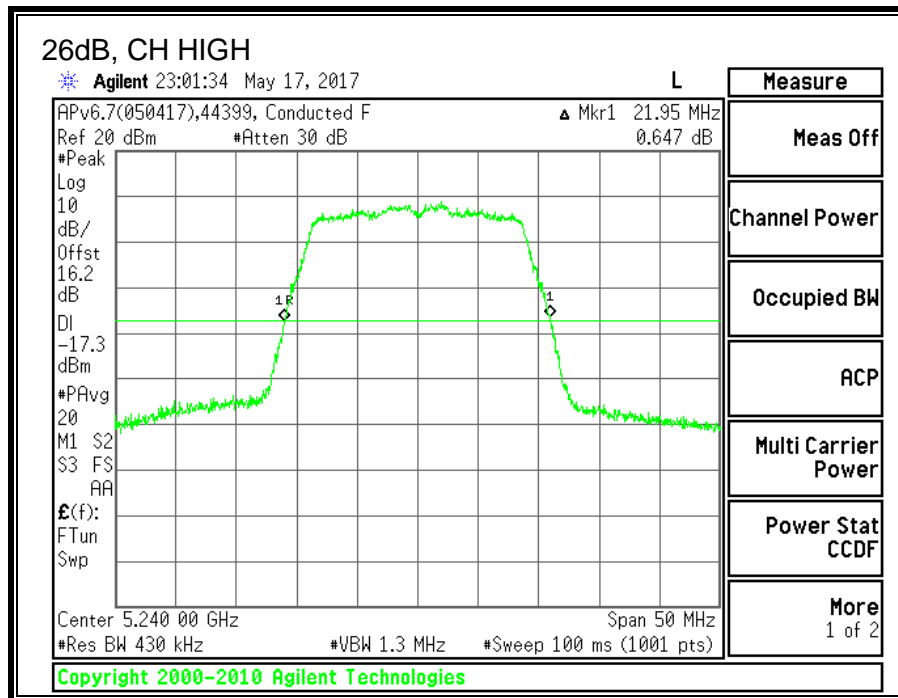

**8.1.2. 99% BANDWIDTH**

**LIMITS**

None; for reporting purposes only.

**RESULTS**

<b>Channel</b>	<b>Frequency</b>	<b>99% BW UAT 2 (MHz)</b>
Low	5180	17.6191
Mid	5200	17.6570
High	5240	17.7020

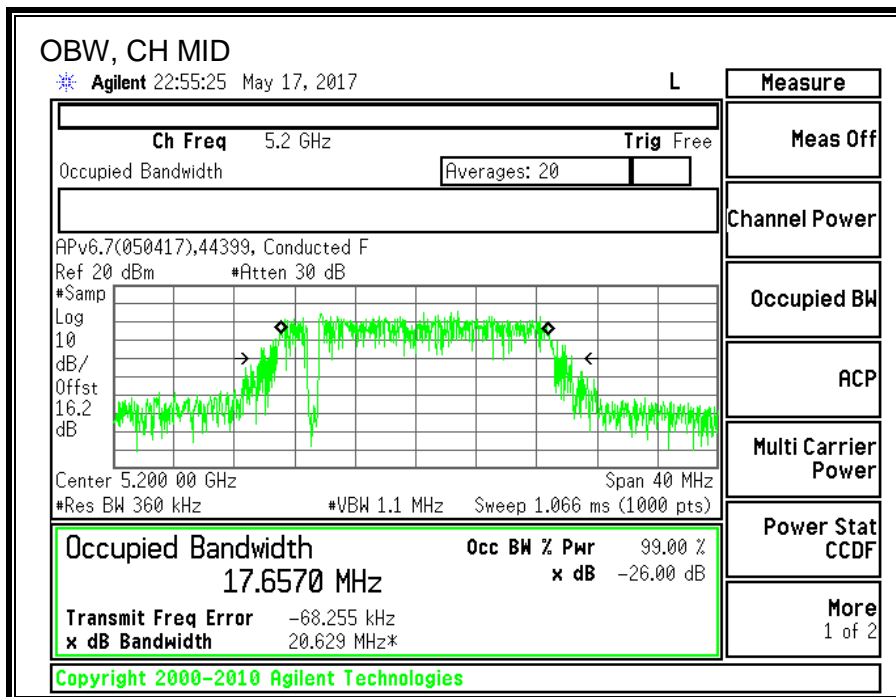
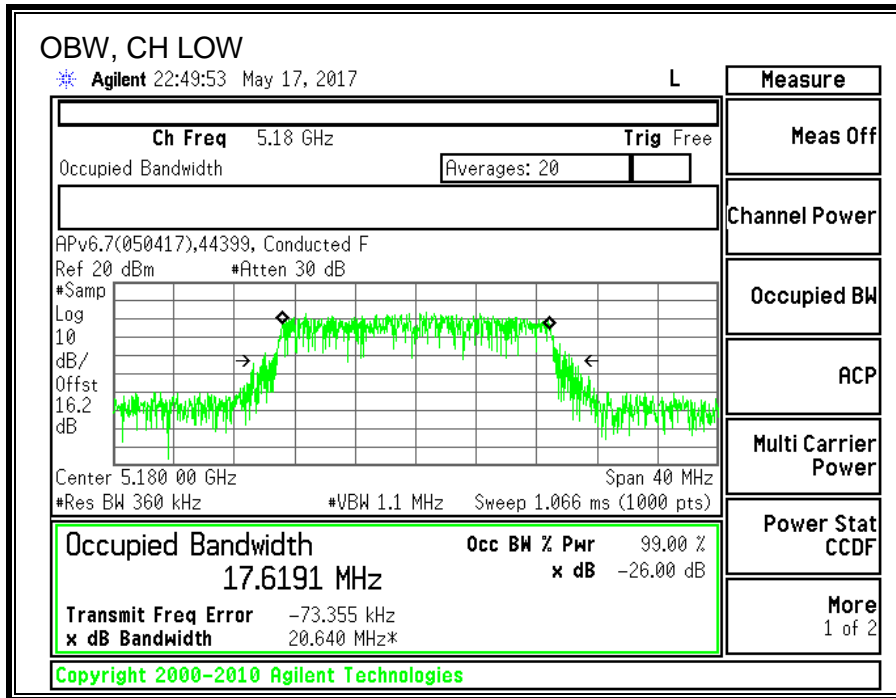

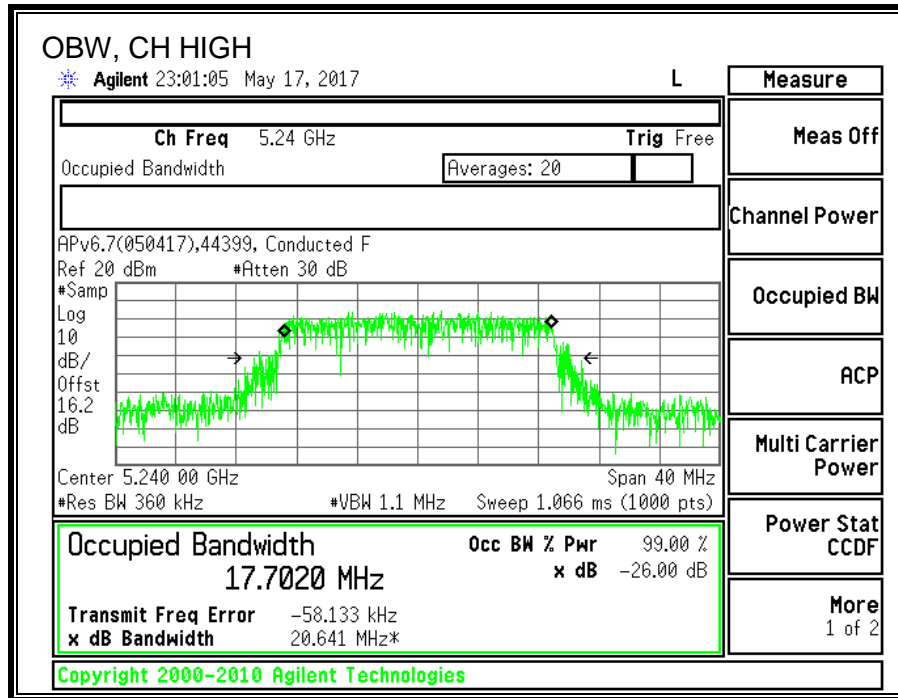

**8.1.3. AVERAGE POWER**

<b>ID:</b>	44366	<b>Date:</b>	7/25/17
------------	-------	--------------	---------

**LIMITS**

None; for reporting purposes only.

**TEST PROCEDURE**

Measurements perform using a wideband gated RF power meter.

**RESULTS**

<b>Channel</b>	<b>Frequency</b>	<b>Power UAT 2 (dBm)</b>
Low	5180	18.85
Mid	5200	20.89
High	5240	20.81

## 8.1.4. OUTPUT POWER AND PPSD

### LIMITS

FCC §15.407 (a) (1)

(i) For an outdoor access point operating in the band 5.15-5.25 GHz, the maximum conducted output power over the frequency band of operation shall not exceed 1 W provided the maximum antenna gain does not exceed 6 dBi. In addition, the maximum power spectral density shall not exceed 17 dBm in any 1 megahertz band. If transmitting antennas of directional gain greater than 6 dBi are used, both the maximum conducted output power and the maximum power spectral density shall be reduced by the amount in dB that the directional gain of the antenna exceeds 6 dBi. The maximum e.i.r.p. at any elevation angle above 30 degrees as measured from the horizon must not exceed 125 mW (21 dBm).

(ii) For an indoor access point operating in the band 5.15-5.25 GHz, the maximum conducted output power over the frequency band of operation shall not exceed 1 W provided the maximum antenna gain does not exceed 6 dBi. In addition, the maximum power spectral density shall not exceed 17 dBm in any 1 megahertz band. If transmitting antennas of directional gain greater than 6 dBi are used, both the maximum conducted output power and the maximum power spectral density shall be reduced by the amount in dB that the directional gain of the antenna exceeds 6 dBi.

(iii) For fixed point-to-point access points operating in the band 5.15-5.25 GHz, the maximum conducted output power over the frequency band of operation shall not exceed 1 W. Fixed point-to-point U-NII devices may employ antennas with directional gain up to 23 dBi without any corresponding reduction in the maximum conducted output power or maximum power spectral density. For fixed point-to-point transmitters that employ a directional antenna gain greater than 23 dBi, a 1 dB reduction in maximum conducted output power and maximum power spectral density is required for each 1 dB of antenna gain in excess of 23 dBi. Fixed, point-to-point operations exclude the use of point-to-multipoint systems, omnidirectional applications, and multiple collocated transmitters transmitting the same information. The operator of the U-NII device, or if the equipment is professionally installed, the installer, is responsible for ensuring that systems employing high gain directional antennas are used exclusively for fixed, point-to-point operations.

(iv) For mobile and portable client devices in the 5.15-5.25 GHz band, the maximum conducted output power over the frequency band of operation shall not exceed 250 mW provided the maximum antenna gain does not exceed 6 dBi. In addition, the maximum power spectral density shall not exceed 11 dBm in any 1 megahertz band. If transmitting antennas of directional gain greater than 6 dBi are used, both the maximum conducted output power and the maximum power spectral density shall be reduced by the amount in dB that the directional gain of the antenna exceeds 6 dBi.

### TEST PROCEDURE

Measurements perform using a wideband gated RF power meter provided that the gate parameters are adjusted such that the power is measured only when the EUT is transmitting at its maximum power control level. Since the measurement is made only during the ON time of the transmitter, no duty cycle correction factor is required.

### DIRECTIONAL ANTENNA GAIN

There is only one transmitter output therefore the directional gain is equal to the antenna gain.

**RESULTS**

**Antenna Gain and Limits**

Channel	Frequency (MHz)	Directional Gain for Power (dBi)	Directional Gain for PSD (dBi)	Power Limit (dBm)	PSD Limit (dBm/1MHz)
Low	5180	-2.72	-2.72	24.00	11.00
Mid	5200	-2.72	-2.72	24.00	11.00
High	5240	-2.72	-2.72	24.00	11.00

<b>Duty Cycle CF (dB)</b>	0.00	<b>Included in Calculations of Corr'd PSD</b>
---------------------------	------	---

**Output Power Results**

Channel	Frequency (MHz)	UAT 2 Meas Power (dBm)	Total Corr'd Power (dBm)	Power Limit (dBm)	Power Margin (dB)
Low	5180	18.85	18.85	24.00	-5.15
Mid	5200	20.89	20.89	24.00	-3.11
High	5240	20.81	20.81	24.00	-3.19

**PSD Results**

Channel	Frequency (MHz)	UAT 2 Meas PSD (dBm/1MHz)	Total Corr'd PSD (dBm/1MHz)	PSD Limit (dBm/1MHz)	PSD Margin (dB)
Low	5180	8.017	8.02	11.00	-2.98
Mid	5200	9.496	9.50	11.00	-1.50
High	5240	9.658	9.66	11.00	-1.34

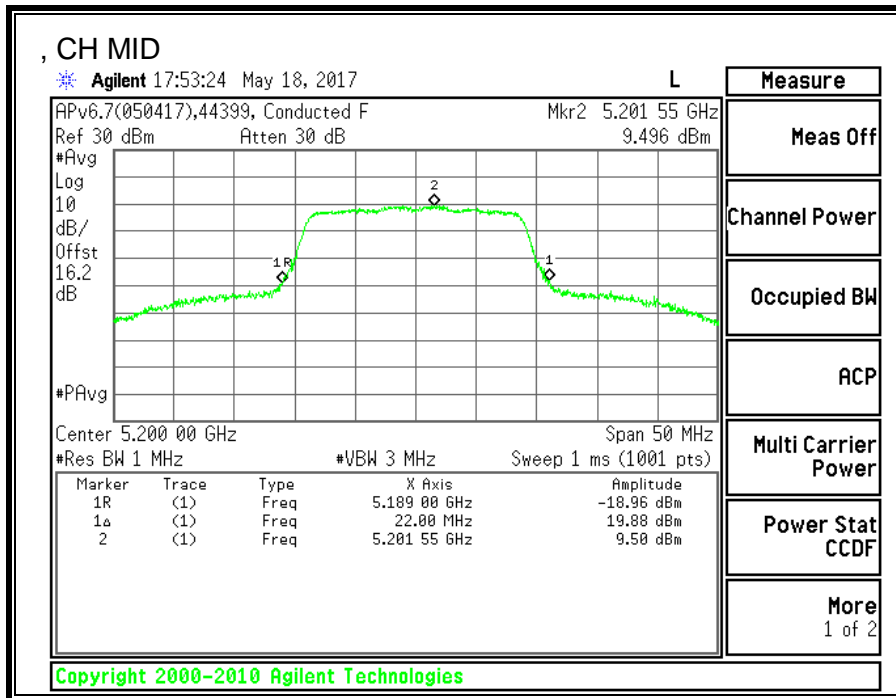
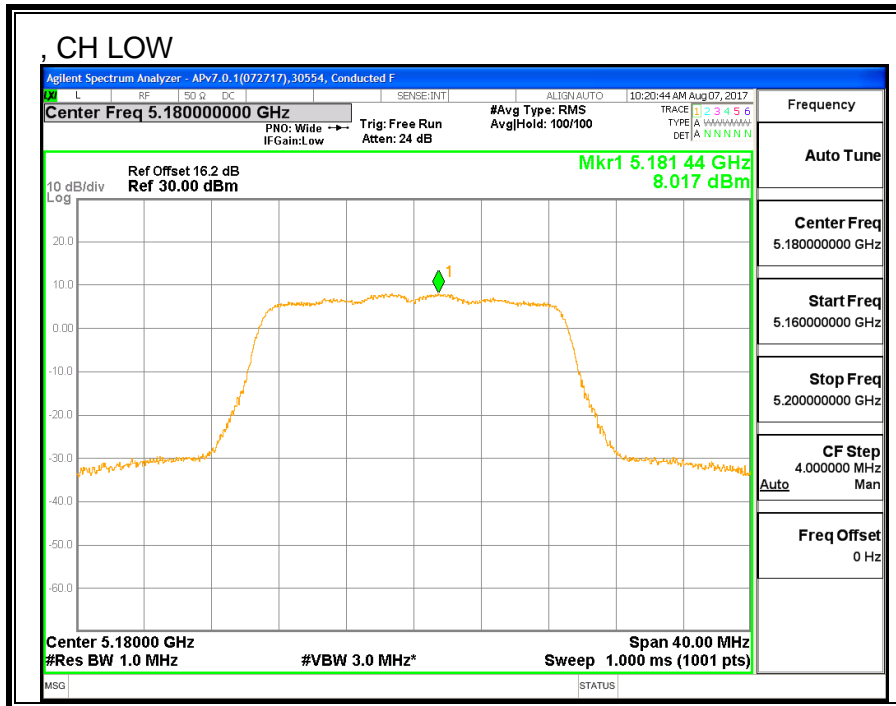



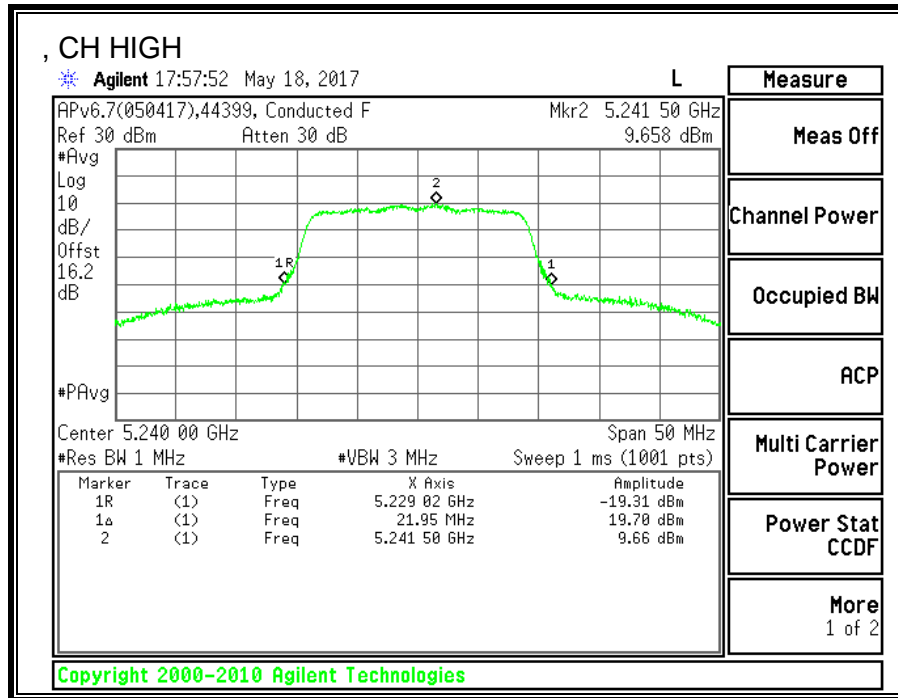

**8.2. 11n HT20 LAT 3 SISO MODE IN THE 5.2GHz BAND**

**8.2.1. 26 dB BANDWIDTH**

**LIMITS**

None; for reporting purposes only.

**RESULTS**

<b>Channel</b>	<b>Frequency</b>	<b>26 dB BW LAT 3 (MHz)</b>
Low	5180	22.00
Mid	5200	21.95
High	5240	21.85

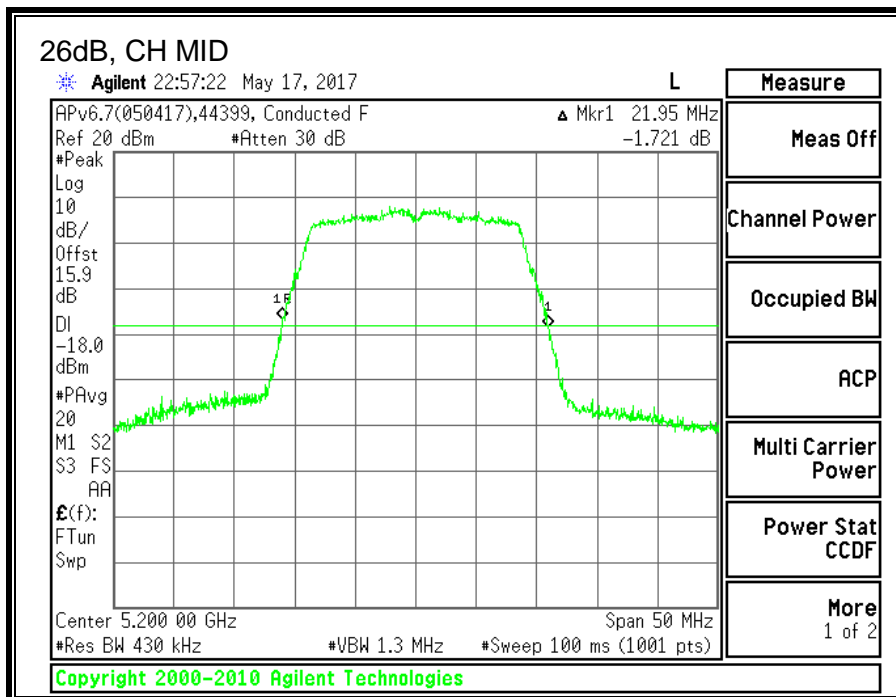
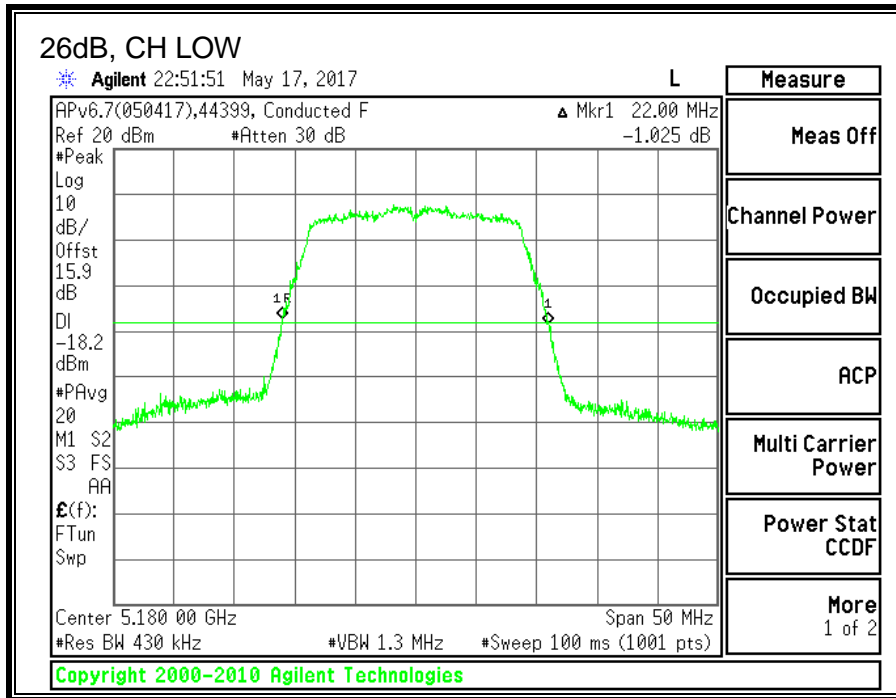

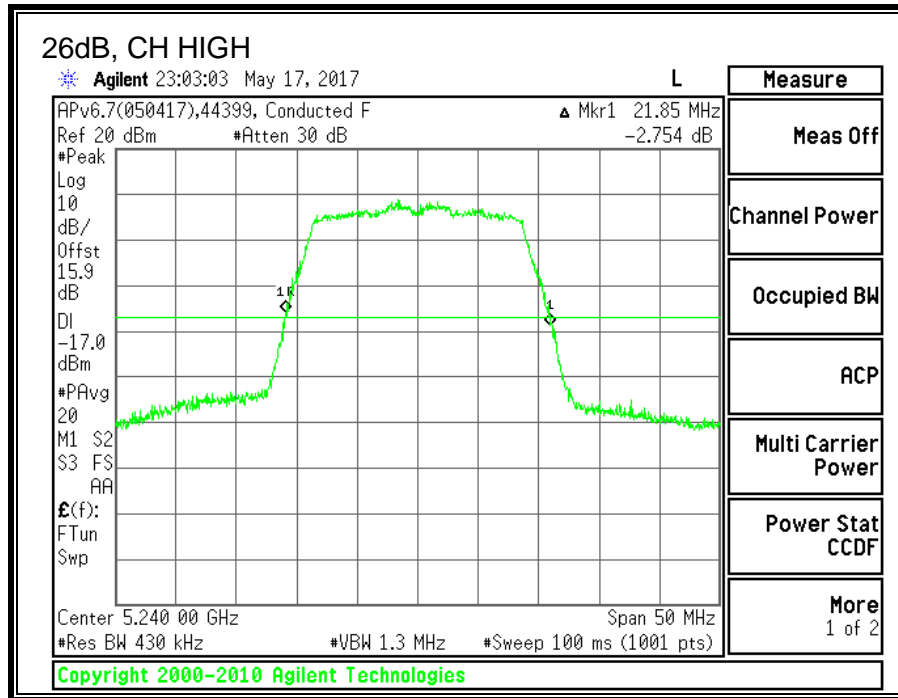

**8.2.2. 99% BANDWIDTH**

**LIMITS**

None; for reporting purposes only.

**RESULTS**

<b>Channel</b>	<b>Frequency</b>	<b>99% BW LAT 3 (MHz)</b>
Low	5180	17.6808
Mid	5200	17.7120
High	5240	17.6323

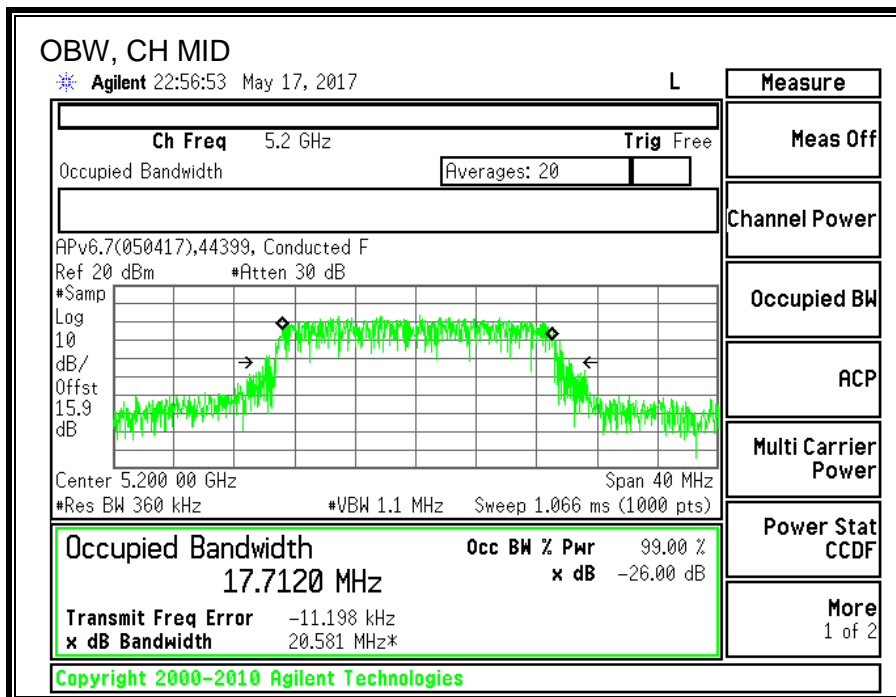
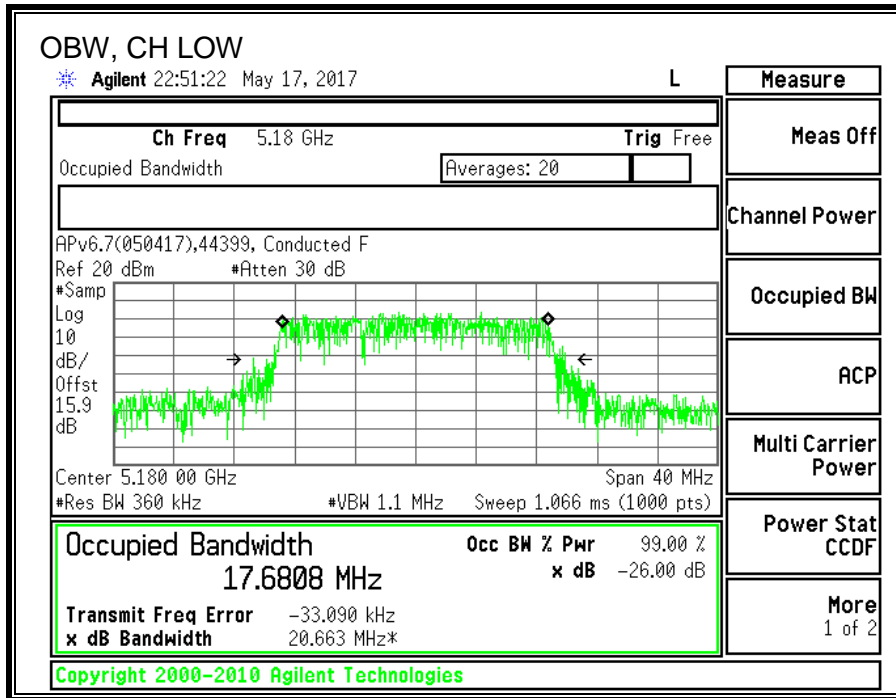

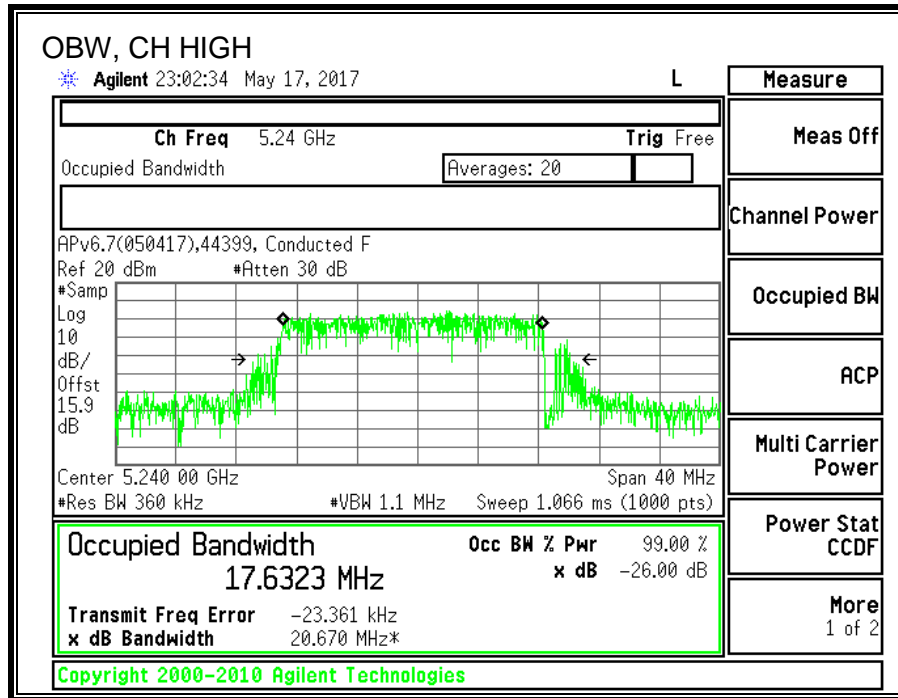

### 8.2.3. AVERAGE POWER

<b>ID:</b>	44366	<b>Date:</b>	7/25/17
------------	-------	--------------	---------

#### LIMITS

None; for reporting purposes only.

#### TEST PROCEDURE

Measurements perform using a wideband gated RF power meter.

#### RESULTS

Channel	Frequency	Power LAT 3 (dBm)
Low	5180	18.89
Mid	5200	20.95
High	5240	20.91



## 8.2.4. OUTPUT POWER AND PPSD

### LIMITS

FCC §15.407 (a) (1)

(i) For an outdoor access point operating in the band 5.15-5.25 GHz, the maximum conducted output power over the frequency band of operation shall not exceed 1 W provided the maximum antenna gain does not exceed 6 dBi. In addition, the maximum power spectral density shall not exceed 17 dBm in any 1 megahertz band. If transmitting antennas of directional gain greater than 6 dBi are used, both the maximum conducted output power and the maximum power spectral density shall be reduced by the amount in dB that the directional gain of the antenna exceeds 6 dBi. The maximum e.i.r.p. at any elevation angle above 30 degrees as measured from the horizon must not exceed 125 mW (21 dBm).

(ii) For an indoor access point operating in the band 5.15-5.25 GHz, the maximum conducted output power over the frequency band of operation shall not exceed 1 W provided the maximum antenna gain does not exceed 6 dBi. In addition, the maximum power spectral density shall not exceed 17 dBm in any 1 megahertz band. If transmitting antennas of directional gain greater than 6 dBi are used, both the maximum conducted output power and the maximum power spectral density shall be reduced by the amount in dB that the directional gain of the antenna exceeds 6 dBi.

(iii) For fixed point-to-point access points operating in the band 5.15-5.25 GHz, the maximum conducted output power over the frequency band of operation shall not exceed 1 W. Fixed point-to-point U-NII devices may employ antennas with directional gain up to 23 dBi without any corresponding reduction in the maximum conducted output power or maximum power spectral density. For fixed point-to-point transmitters that employ a directional antenna gain greater than 23 dBi, a 1 dB reduction in maximum conducted output power and maximum power spectral density is required for each 1 dB of antenna gain in excess of 23 dBi. Fixed, point-to-point operations exclude the use of point-to-multipoint systems, omnidirectional applications, and multiple collocated transmitters transmitting the same information. The operator of the U-NII device, or if the equipment is professionally installed, the installer, is responsible for ensuring that systems employing high gain directional antennas are used exclusively for fixed, point-to-point operations.

(iv) For mobile and portable client devices in the 5.15-5.25 GHz band, the maximum conducted output power over the frequency band of operation shall not exceed 250 mW provided the maximum antenna gain does not exceed 6 dBi. In addition, the maximum power spectral density shall not exceed 11 dBm in any 1 megahertz band. If transmitting antennas of directional gain greater than 6 dBi are used, both the maximum conducted output power and the maximum power spectral density shall be reduced by the amount in dB that the directional gain of the antenna exceeds 6 dBi.

### TEST PROCEDURE

Measurements perform using a wideband gated RF power meter provided that the gate parameters are adjusted such that the power is measured only when the EUT is transmitting at its maximum power control level. Since the measurement is made only during the ON time of the transmitter, no duty cycle correction factor is required.

### DIRECTIONAL ANTENNA GAIN

There is only one transmitter output therefore the directional gain is equal to the antenna gain.

**RESULTS**

**Antenna Gain and Limits**

Channel	Frequency (MHz)	Directional Gain for Power (dBi)	Directional Gain for PSD (dBi)	Power Limit (dBm)	PSD Limit (dBm/1MHz)
Low	5180	-7.38	-7.38	24.00	11.00
Mid	5200	-7.38	-7.38	24.00	11.00
High	5240	-7.38	-7.38	24.00	11.00

<b>Duty Cycle CF (dB)</b>	0.00	<b>Included in Calculations of Corr'd PSD</b>
---------------------------	------	---

**Output Power Results**

Channel	Frequency (MHz)	LAT 3 Meas Power (dBm)	Total Corr'd Power (dBm)	Power Limit (dBm)	Power Margin (dB)
Low	5180	18.89	18.89	24.00	-5.11
Mid	5200	20.95	20.95	24.00	-3.05
High	5240	20.91	20.91	24.00	-3.09

**PSD Results**

Channel	Frequency (MHz)	LAT 3 Meas PSD (dBm/1MHz)	Total Corr'd PSD (dBm/1MHz)	PSD Limit (dBm/1MHz)	PSD Margin (dB)
Low	5180	9.543	9.54	11.00	-1.46
Mid	5200	9.324	9.32	11.00	-1.68
High	5240	9.601	9.60	11.00	-1.40

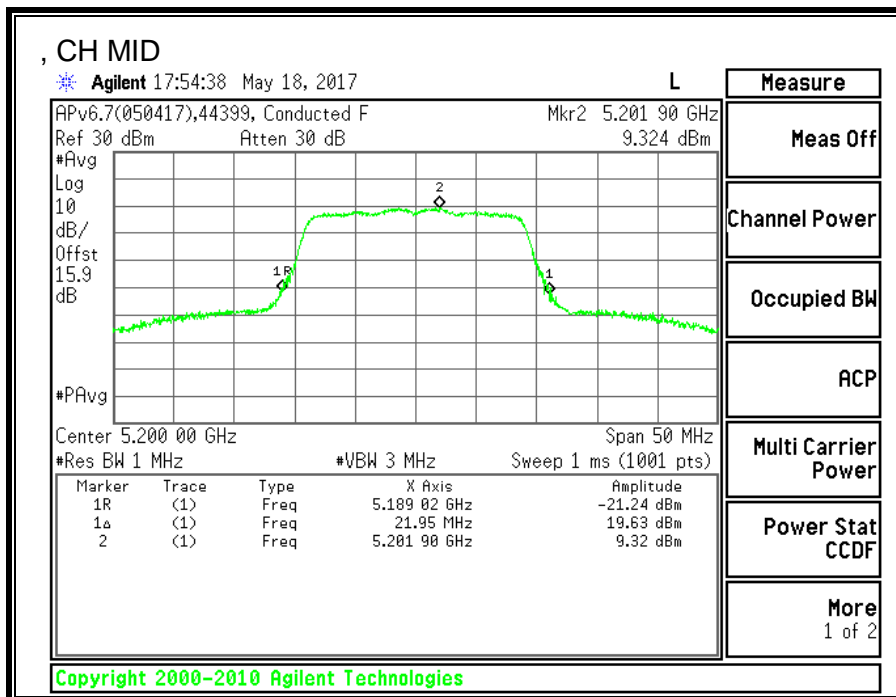
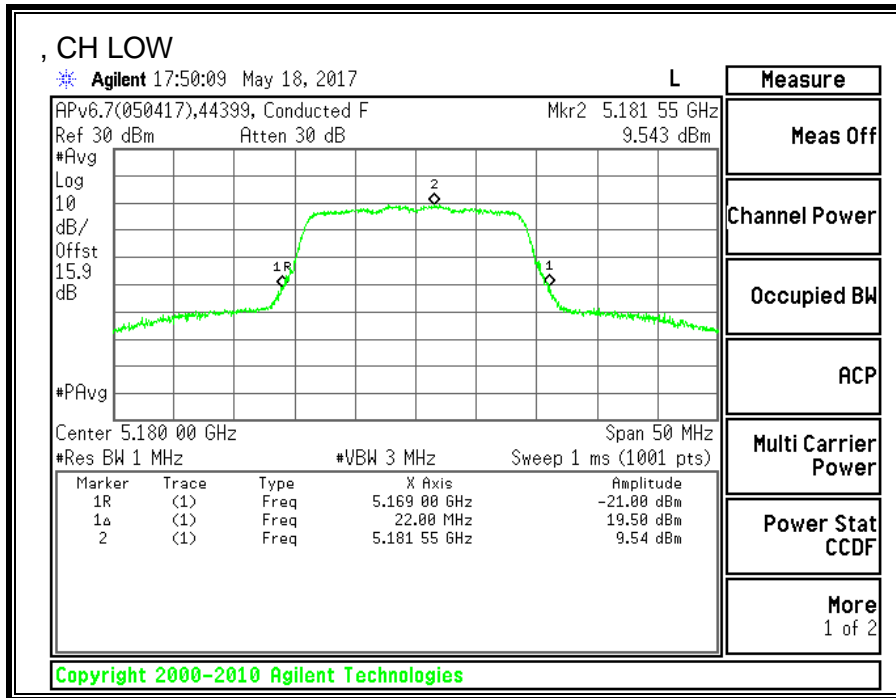

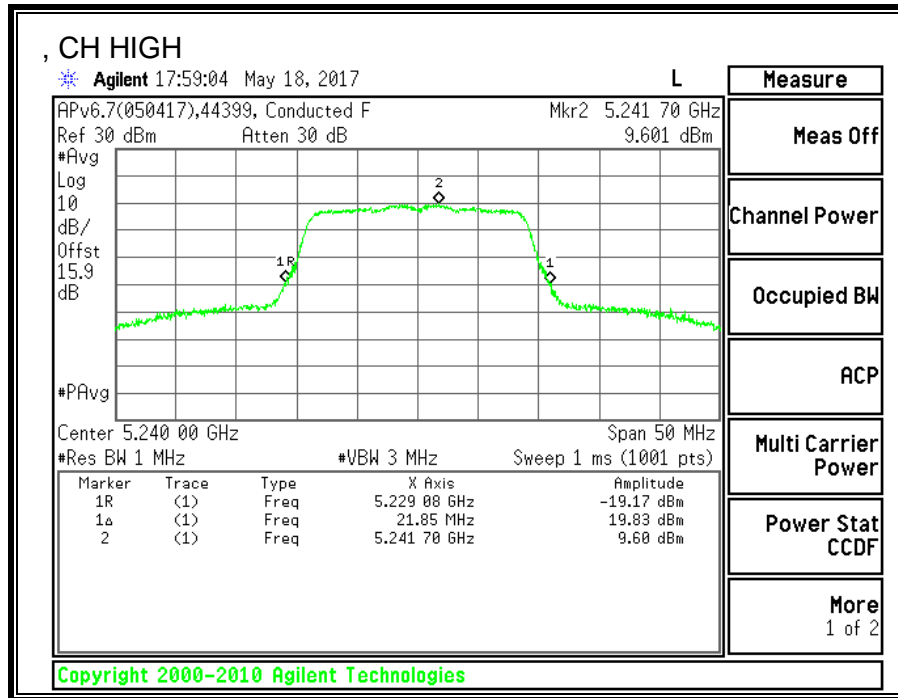

**8.3. 11n HT20 2TX CDD MIMO MODE IN THE 5.2GHz BAND**

**8.3.1. 26 dB BANDWIDTH**

**LIMITS**

None; for reporting purposes only.

**RESULTS**

<b>Channel</b>	<b>Frequency</b>	<b>26 dB BW UAT 2 (MHz)</b>	<b>26 dB BW LAT 3 (MHz)</b>
Low	5180	21.90	21.55
Mid	5200	21.90	21.60
High	5240	21.90	21.60

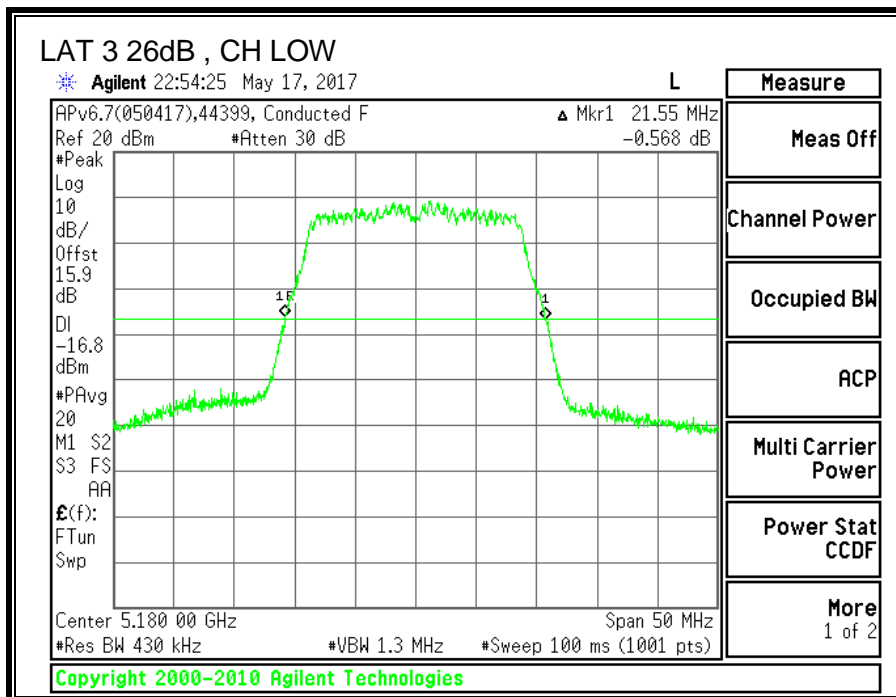
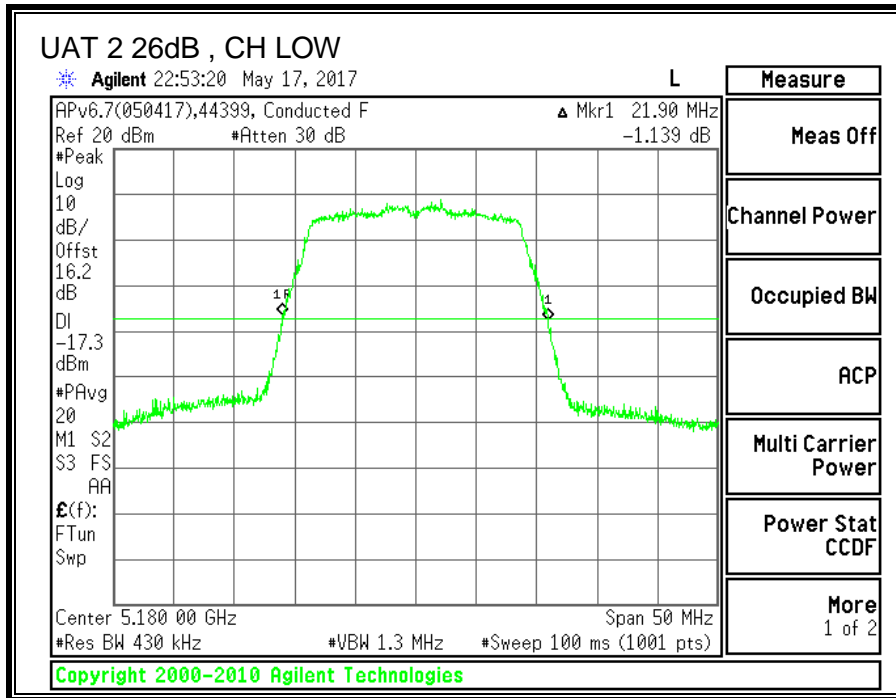

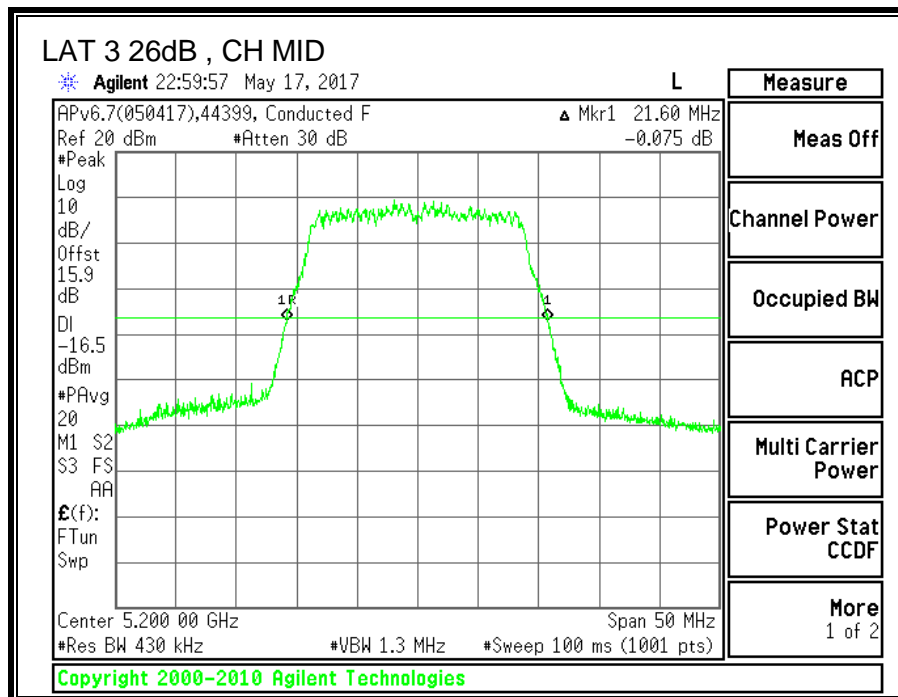
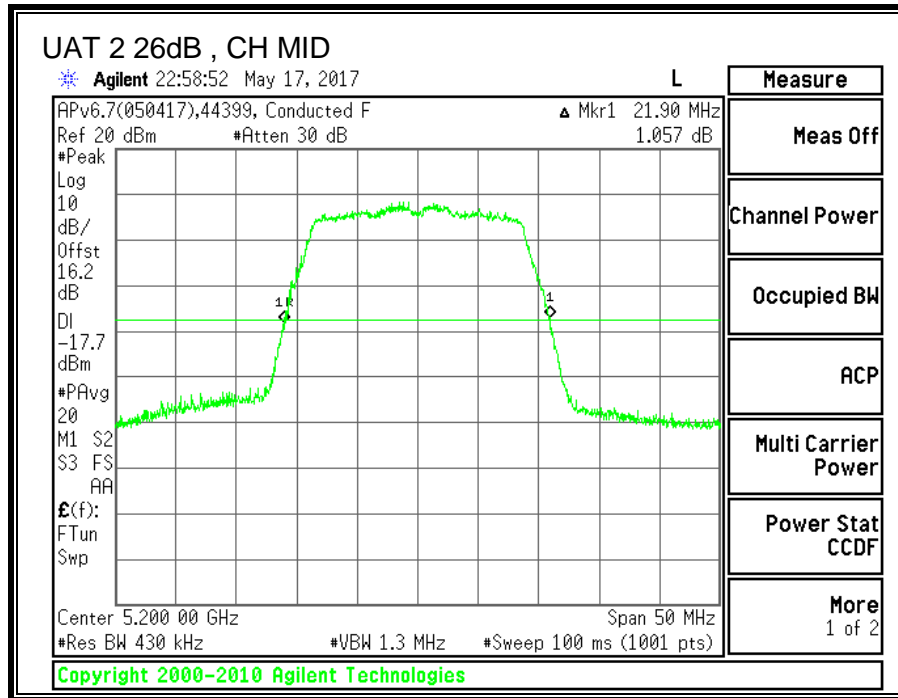

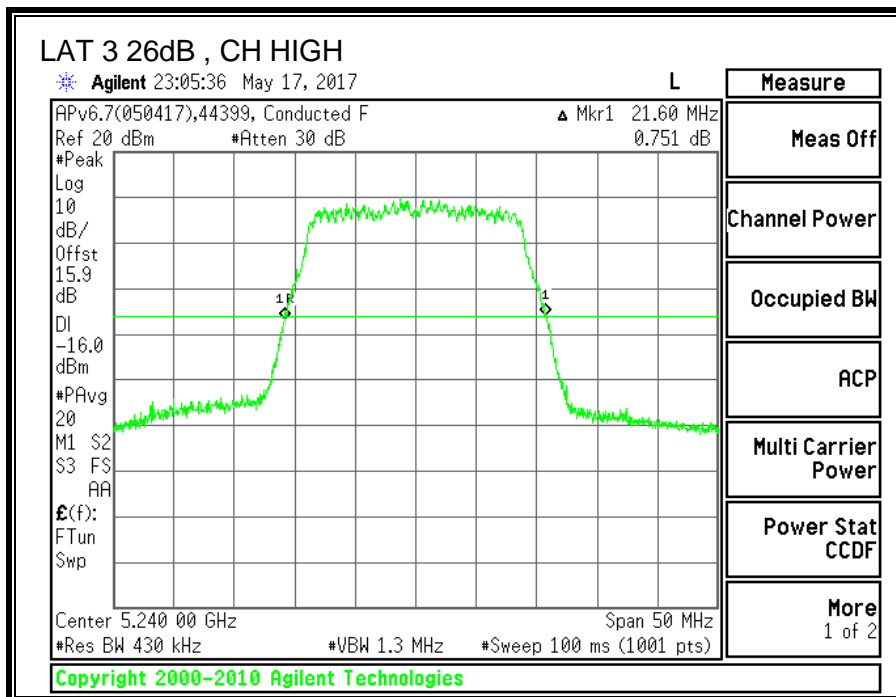
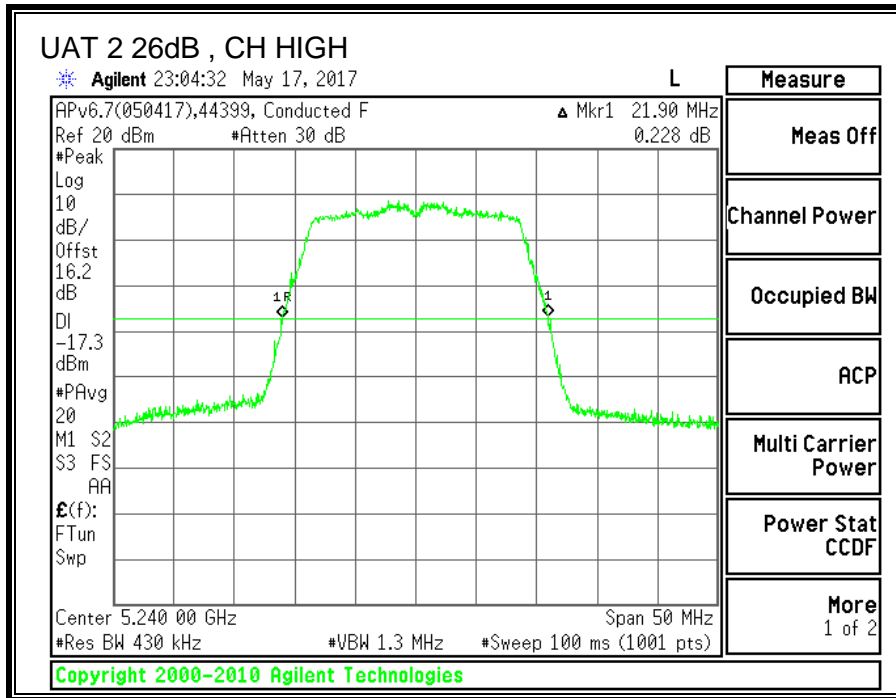



**8.3.2. 99% BANDWIDTH**

**LIMITS**

None; for reporting purposes only.

**RESULTS**

<b>Channel</b>	<b>Frequency</b>	<b>99% BW UAT 2 (MHz)</b>	<b>99% BW LAT 3 (MHz)</b>
Low	5180	17.7329	17.6538
Mid	5200	17.7096	17.6158
High	5240	17.6230	17.6786

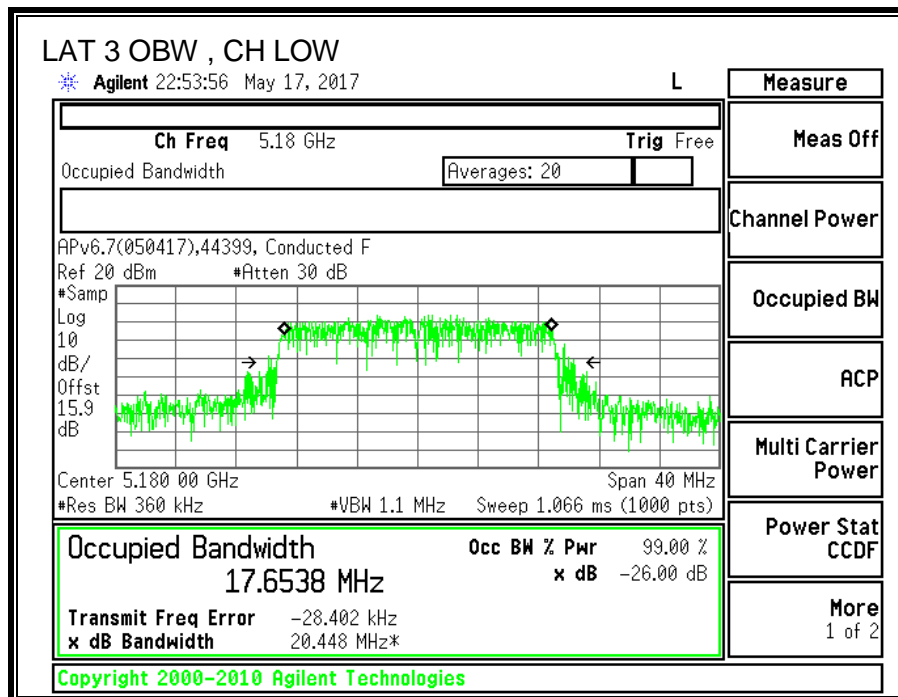
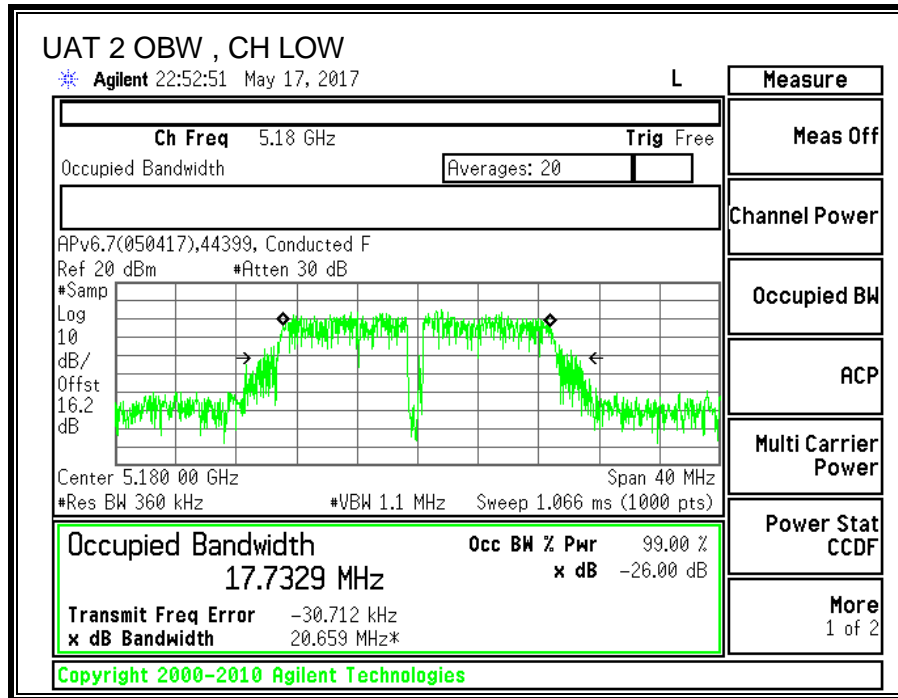

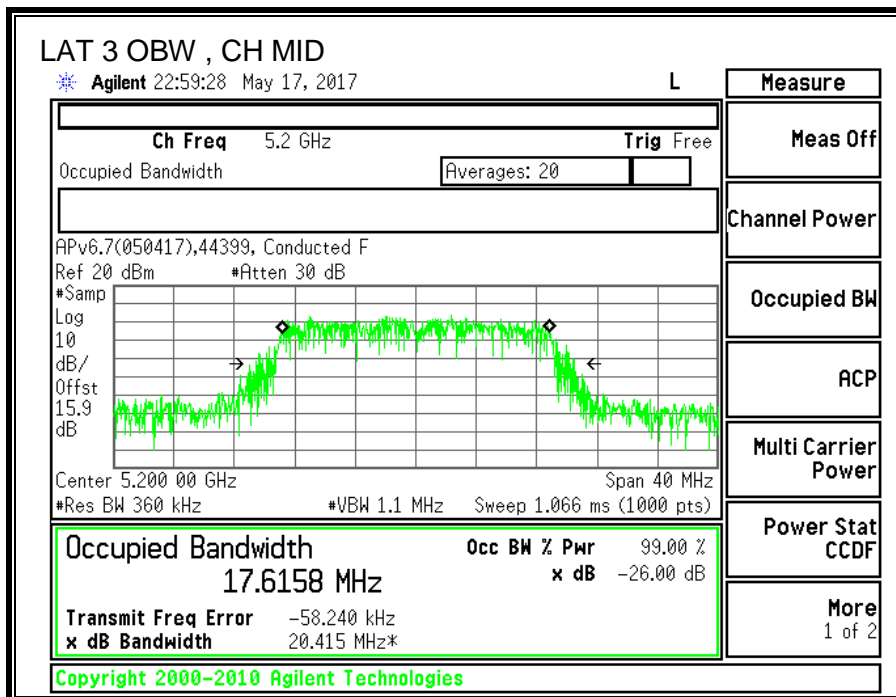
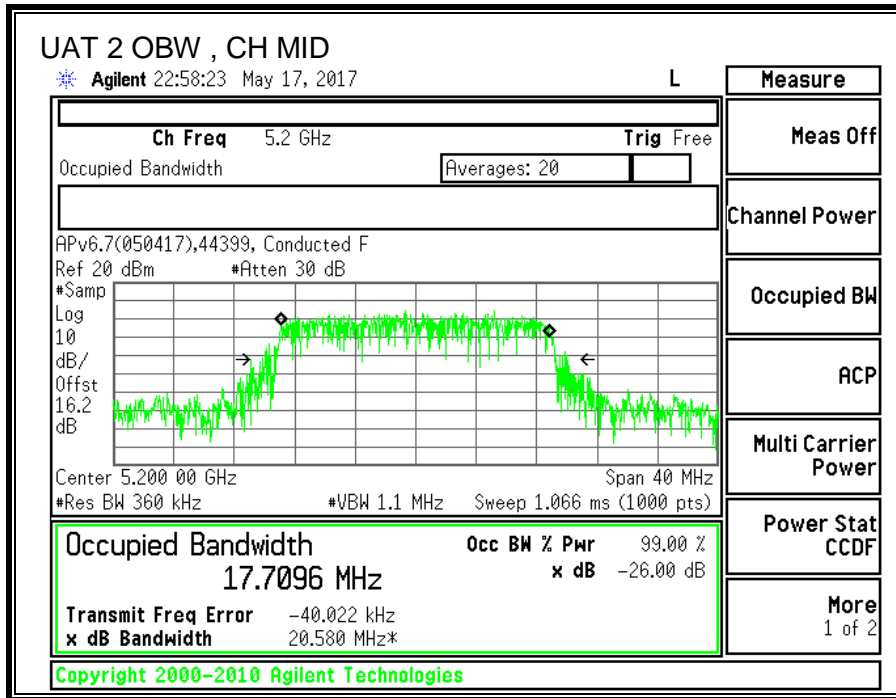

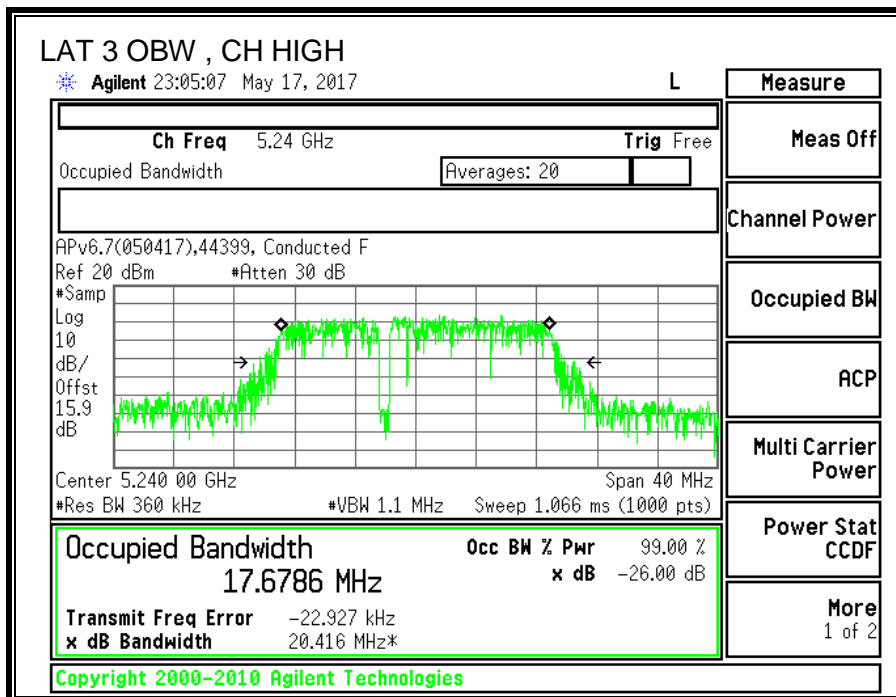
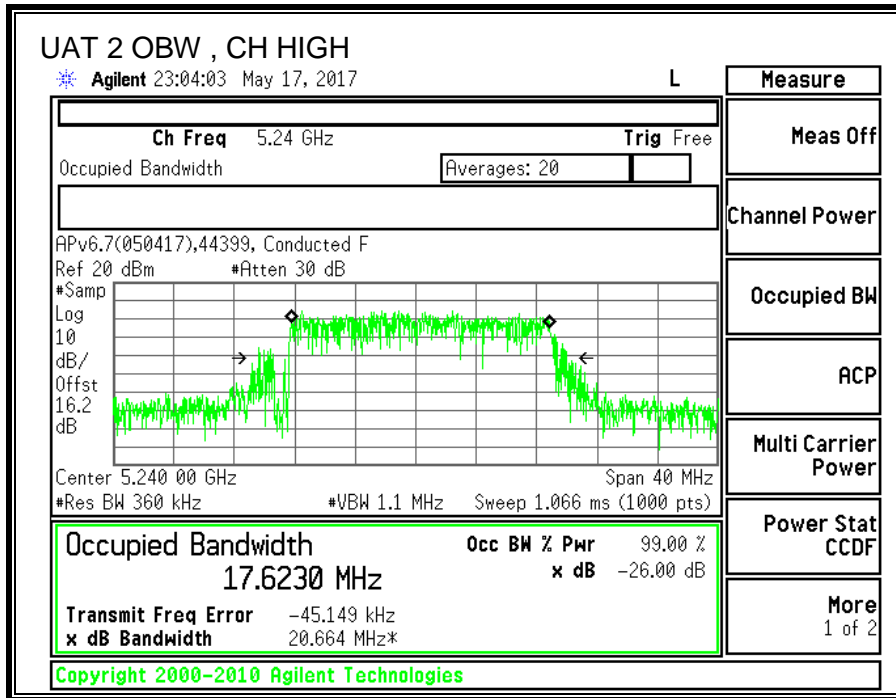

**8.3.3. AVERAGE POWER**

<b>ID:</b>	44366	<b>Date:</b>	7/25/17
------------	-------	--------------	---------

**LIMITS**

None; for reporting purposes only.

**TEST PROCEDURE**

Measurements perform using a wideband gated RF power meter.

**RESULTS**

**Average Power Results**

<b>Channel</b>	<b>Frequency (MHz)</b>	<b>UAT 2 Power (dBm)</b>	<b>LAT 3 Power (dBm)</b>	<b>Total Power (dBm)</b>
Low	5180	17.89	17.91	20.91
Mid	5200	17.79	17.84	20.83
High	5240	17.86	17.92	20.90

### 8.3.4. OUTPUT POWER AND PPSD

#### **LIMITS**

FCC §15.407 (a) (1)

(i) For an outdoor access point operating in the band 5.15-5.25 GHz, the maximum conducted output power over the frequency band of operation shall not exceed 1 W provided the maximum antenna gain does not exceed 6 dBi. In addition, the maximum power spectral density shall not exceed 17 dBm in any 1 megahertz band. If transmitting antennas of directional gain greater than 6 dBi are used, both the maximum conducted output power and the maximum power spectral density shall be reduced by the amount in dB that the directional gain of the antenna exceeds 6 dBi. The maximum e.i.r.p. at any elevation angle above 30 degrees as measured from the horizon must not exceed 125 mW (21 dBm).

(ii) For an indoor access point operating in the band 5.15-5.25 GHz, the maximum conducted output power over the frequency band of operation shall not exceed 1 W provided the maximum antenna gain does not exceed 6 dBi. In addition, the maximum power spectral density shall not exceed 17 dBm in any 1 megahertz band. If transmitting antennas of directional gain greater than 6 dBi are used, both the maximum conducted output power and the maximum power spectral density shall be reduced by the amount in dB that the directional gain of the antenna exceeds 6 dBi.

(iii) For fixed point-to-point access points operating in the band 5.15-5.25 GHz, the maximum conducted output power over the frequency band of operation shall not exceed 1 W. Fixed point-to-point U-NII devices may employ antennas with directional gain up to 23 dBi without any corresponding reduction in the maximum conducted output power or maximum power spectral density. For fixed point-to-point transmitters that employ a directional antenna gain greater than 23 dBi, a 1 dB reduction in maximum conducted output power and maximum power spectral density is required for each 1 dB of antenna gain in excess of 23 dBi. Fixed, point-to-point operations exclude the use of point-to-multipoint systems, omnidirectional applications, and multiple collocated transmitters transmitting the same information. The operator of the U-NII device, or if the equipment is professionally installed, the installer, is responsible for ensuring that systems employing high gain directional antennas are used exclusively for fixed, point-to-point operations.

(iv) For mobile and portable client devices in the 5.15-5.25 GHz band, the maximum conducted output power over the frequency band of operation shall not exceed 250 mW provided the maximum antenna gain does not exceed 6 dBi. In addition, the maximum power spectral density shall not exceed 11 dBm in any 1 megahertz band. If transmitting antennas of directional gain greater than 6 dBi are used, both the maximum conducted output power and the maximum power spectral density shall be reduced by the amount in dB that the directional gain of the antenna exceeds 6 dBi.

#### **TEST PROCEDURE**

Measurements perform using a wideband gated RF power meter provided that the gate parameters are adjusted such that the power is measured only when the EUT is transmitting at its maximum power control level. Since the measurement is made only during the ON time of the transmitter, no duty cycle correction factor is required.

**DIRECTIONAL ANTENNA GAIN**

For Power used uncorrelated gain: The TX chains are uncorrelated and the antenna gain is unequal among the chains. The directional gain is:

<b>UAT 2 Antenna Gain (dBi)</b>	<b>LAT 3 Antenna Gain (dBi)</b>	<b>Uncorrelated Chains Directional Gain (dBi)</b>
-2.72	-7.38	-4.45

For PSD used correlated gain: The TX chains are correlated and the antenna gain is unequal among the chains. The directional gain is:

<b>UAT 2 Antenna Gain (dBi)</b>	<b>LAT 3 Antenna Gain (dBi)</b>	<b>Correlated Chains Directional Gain (dBi)</b>
-2.72	-7.38	-1.73

**RESULTS**

**Antenna Gain and Limits**

Channel	Frequency (MHz)	Directional Gain for Power (dBi)	Directional Gain for PSD (dBi)	Power Limit (dBm)	PSD Limit (dBm/1MHz)
Low	5180	-4.45	-1.73	24.00	11.00
Mid	5200	-4.45	-1.73	24.00	11.00
High	5240	-4.45	-1.73	24.00	11.00

<b>Duty Cycle CF (dB)</b>	0.00	<b>Included in Calculations of Corr'd PSD</b>
---------------------------	------	---

**Output Power Results**

Channel	Frequency (MHz)	UAT 2 Meas Power (dBm)	LAT 3 Meas Power (dBm)	Total Corr'd Power (dBm)	Power Limit (dBm)	Power Margin (dB)
Low	5180	17.890	17.910	20.91	24.00	-3.09
Mid	5200	17.790	17.840	20.83	24.00	-3.17
High	5240	17.860	17.920	20.90	24.00	-3.10

**PSD Results**

Channel	Frequency (MHz)	UAT 2 Meas PSD (dBm/1MHz)	LAT 3 Meas PSD (dBm/1MHz)	Total Corr'd PSD (dBm/1MHz)	PSD Limit (dBm/1MHz)	PSD Margin (dB)
Low	5180	6.175	6.132	9.16	11.00	-1.84
Mid	5200	6.744	6.056	9.42	11.00	-1.58
High	5240	6.798	6.158	9.50	11.00	-1.50



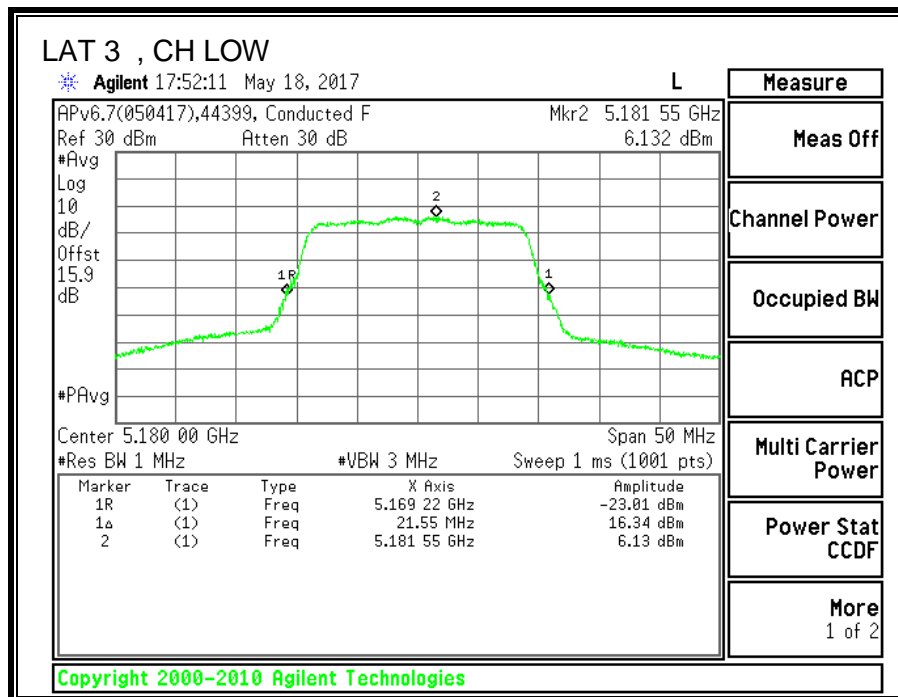
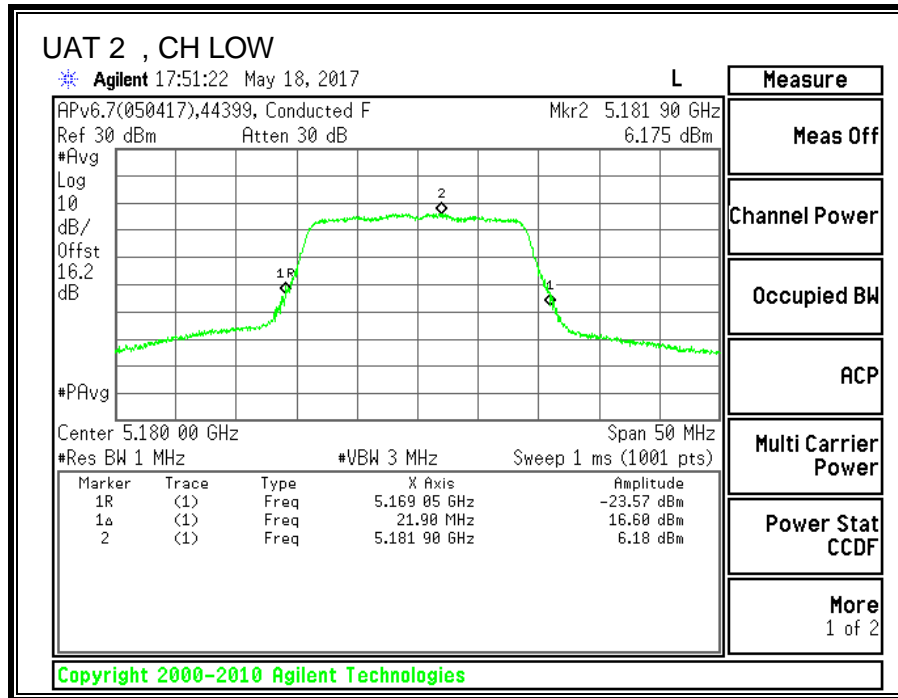

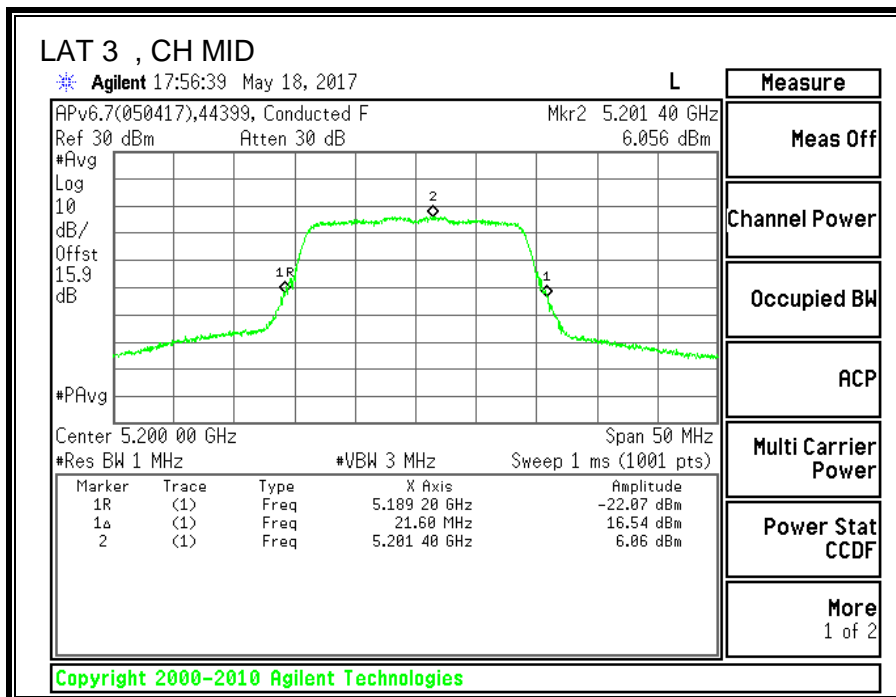
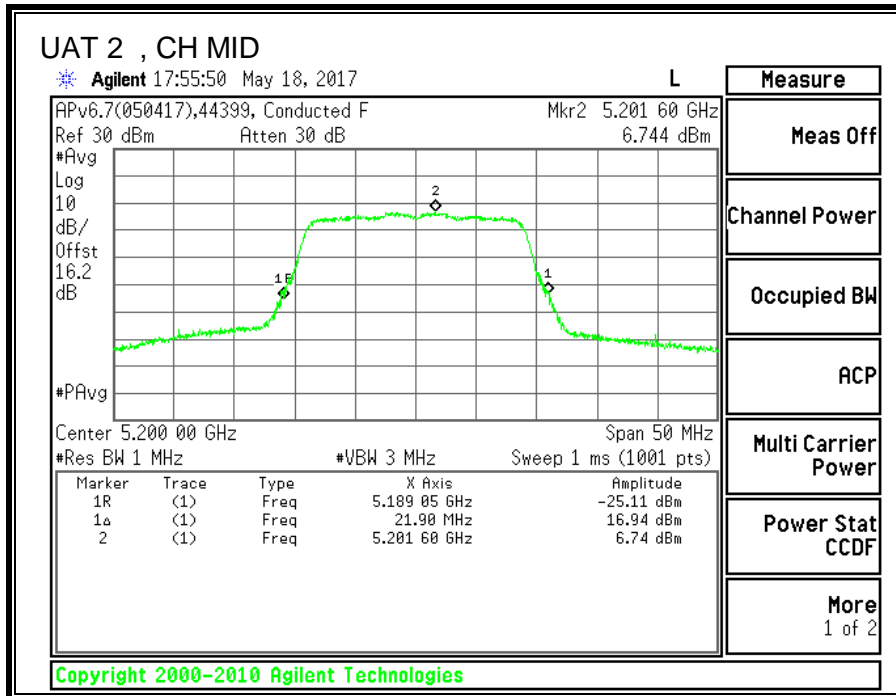

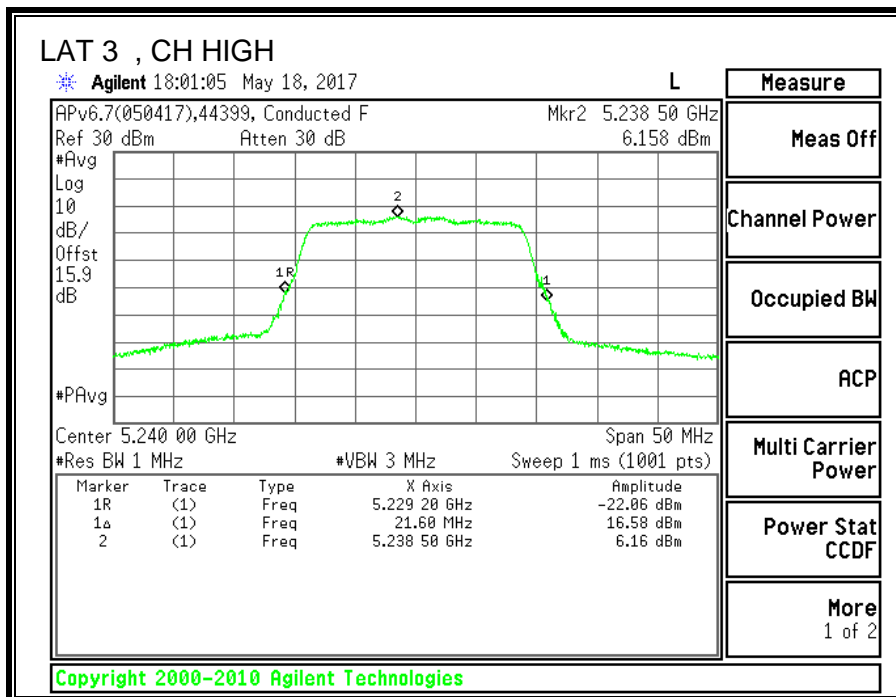
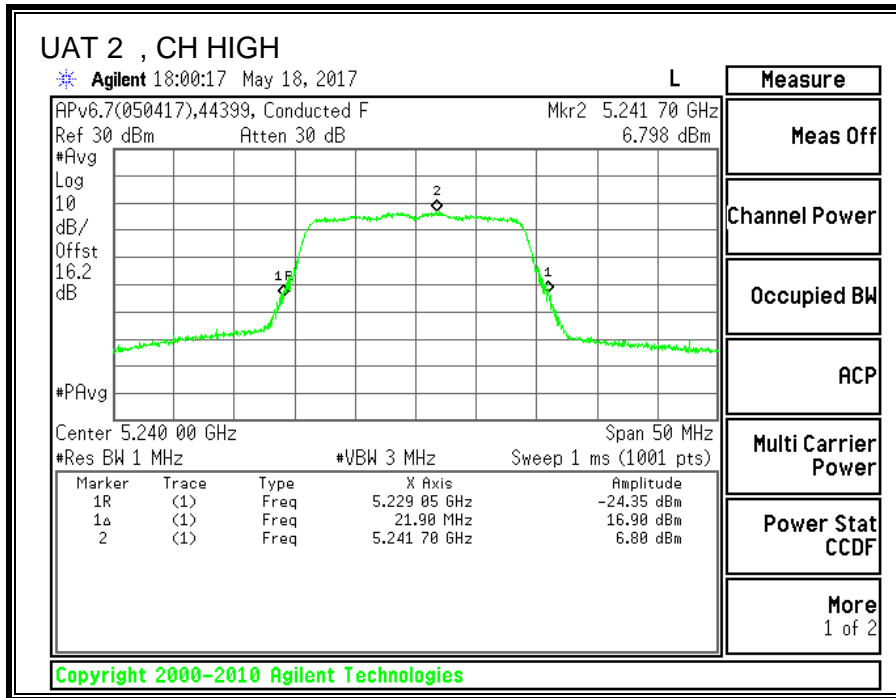

**8.4. 11n HT40 UAT 2 SISO MODE IN THE 5.2GHz BAND**

**8.4.1. 26 dB BANDWIDTH**

**LIMITS**

None; for reporting purposes only.

**RESULTS**

<b>Channel</b>	<b>Frequency</b>	<b>26 dB BW UAT 2 (MHz)</b>
Low	5190	40.7
High	5230	40.6

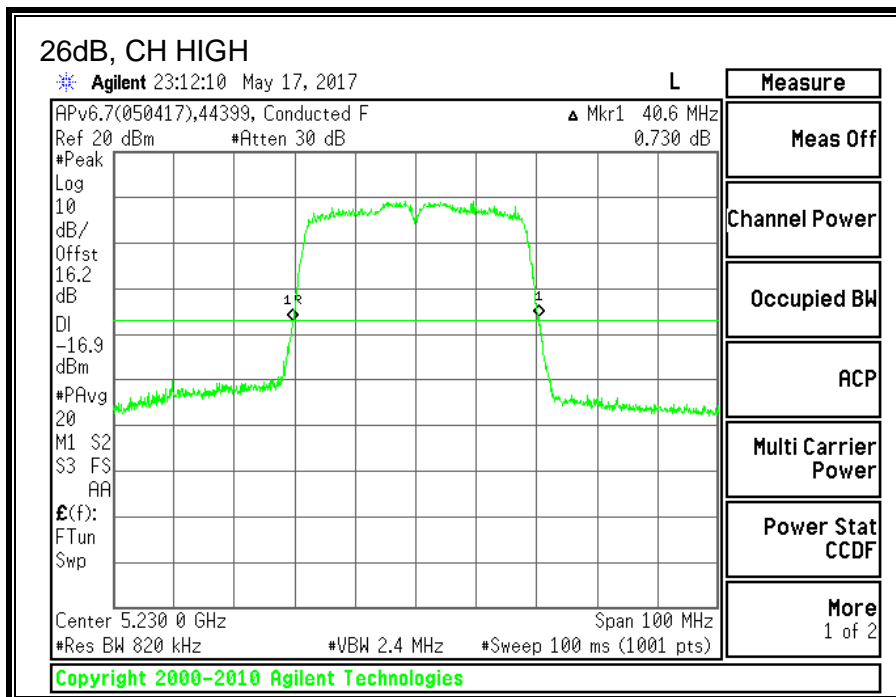
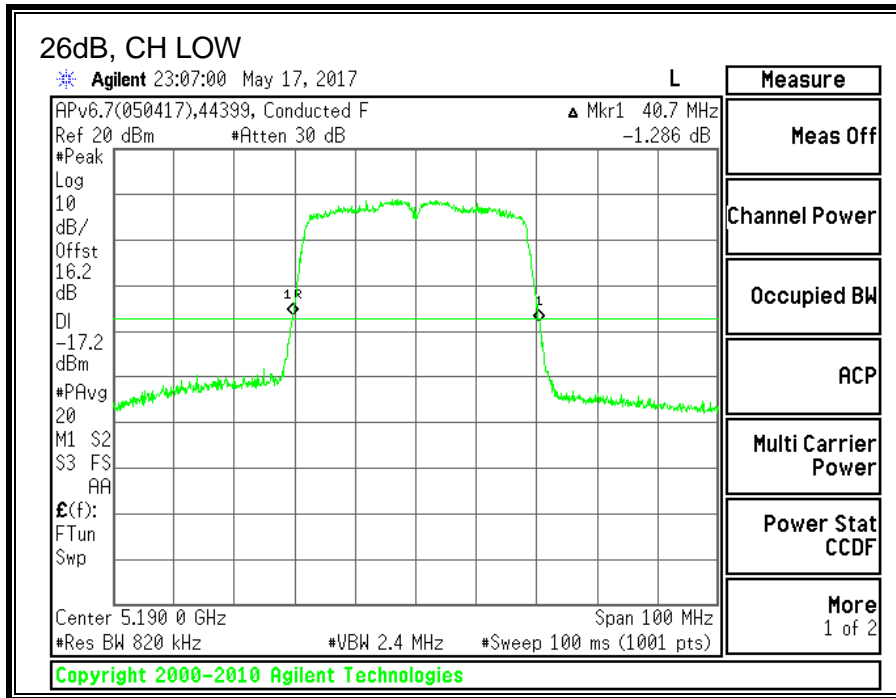

**8.4.2. 99% BANDWIDTH**

**LIMITS**

None; for reporting purposes only.

**RESULTS**

<b>Channel</b>	<b>Frequency</b>	<b>99% BW UAT 2 (MHz)</b>
Low	5190	36.1492
High	5230	36.1516

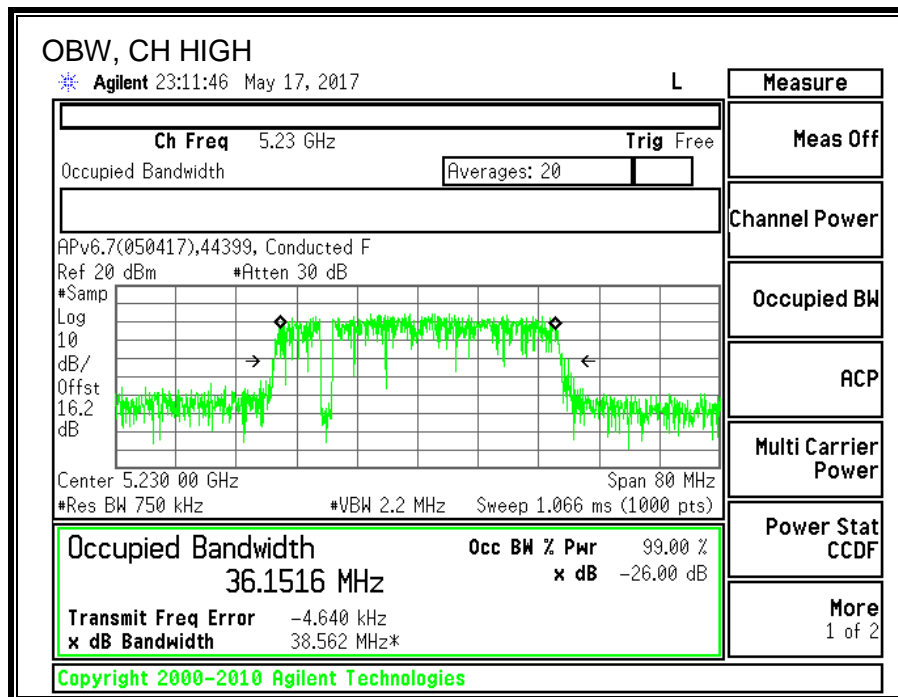
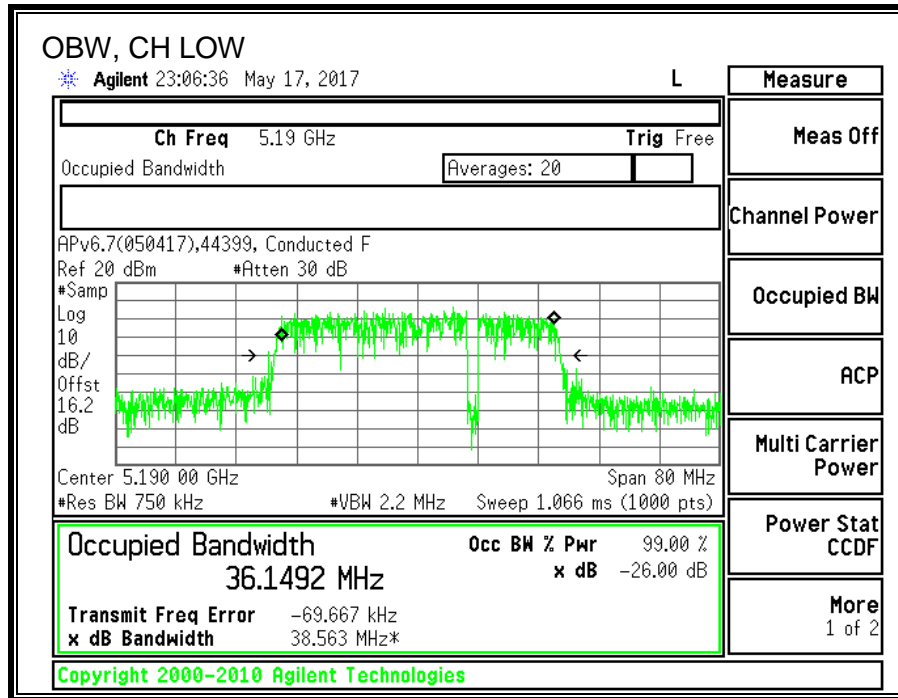

**8.4.3. AVERAGE POWER**

<b>ID:</b>	44366	<b>Date:</b>	7/25/17
------------	-------	--------------	---------

**LIMITS**

None; for reporting purposes only.

**TEST PROCEDURE**

Measurements perform using a wideband gated RF power meter.

**RESULTS**

<b>Channel</b>	<b>Frequency</b>	<b>Power UAT 2 (dBm)</b>
Low	5190	17.88
High	5230	19.31



## 8.4.4. OUTPUT POWER AND PPSD

### LIMITS

FCC §15.407 (a) (1)

(i) For an outdoor access point operating in the band 5.15-5.25 GHz, the maximum conducted output power over the frequency band of operation shall not exceed 1 W provided the maximum antenna gain does not exceed 6 dBi. In addition, the maximum power spectral density shall not exceed 17 dBm in any 1 megahertz band. If transmitting antennas of directional gain greater than 6 dBi are used, both the maximum conducted output power and the maximum power spectral density shall be reduced by the amount in dB that the directional gain of the antenna exceeds 6 dBi. The maximum e.i.r.p. at any elevation angle above 30 degrees as measured from the horizon must not exceed 125 mW (21 dBm).

(ii) For an indoor access point operating in the band 5.15-5.25 GHz, the maximum conducted output power over the frequency band of operation shall not exceed 1 W provided the maximum antenna gain does not exceed 6 dBi. In addition, the maximum power spectral density shall not exceed 17 dBm in any 1 megahertz band. If transmitting antennas of directional gain greater than 6 dBi are used, both the maximum conducted output power and the maximum power spectral density shall be reduced by the amount in dB that the directional gain of the antenna exceeds 6 dBi.

(iii) For fixed point-to-point access points operating in the band 5.15-5.25 GHz, the maximum conducted output power over the frequency band of operation shall not exceed 1 W. Fixed point-to-point U-NII devices may employ antennas with directional gain up to 23 dBi without any corresponding reduction in the maximum conducted output power or maximum power spectral density. For fixed point-to-point transmitters that employ a directional antenna gain greater than 23 dBi, a 1 dB reduction in maximum conducted output power and maximum power spectral density is required for each 1 dB of antenna gain in excess of 23 dBi. Fixed, point-to-point operations exclude the use of point-to-multipoint systems, omnidirectional applications, and multiple collocated transmitters transmitting the same information. The operator of the U-NII device, or if the equipment is professionally installed, the installer, is responsible for ensuring that systems employing high gain directional antennas are used exclusively for fixed, point-to-point operations.

(iv) For mobile and portable client devices in the 5.15-5.25 GHz band, the maximum conducted output power over the frequency band of operation shall not exceed 250 mW provided the maximum antenna gain does not exceed 6 dBi. In addition, the maximum power spectral density shall not exceed 11 dBm in any 1 megahertz band. If transmitting antennas of directional gain greater than 6 dBi are used, both the maximum conducted output power and the maximum power spectral density shall be reduced by the amount in dB that the directional gain of the antenna exceeds 6 dBi.

### TEST PROCEDURE

Measurements perform using a wideband gated RF power meter provided that the gate parameters are adjusted such that the power is measured only when the EUT is transmitting at its maximum power control level. Since the measurement is made only during the ON time of the transmitter, no duty cycle correction factor is required.

### DIRECTIONAL ANTENNA GAIN

There is only one transmitter output therefore the directional gain is equal to the antenna gain.

**RESULTS**

**Antenna Gain and Limits**

Channel	Frequency (MHz)	Directional Gain for Power (dBi)	Directional Gain for PSD (dBi)	Power Limit (dBm)	PSD Limit (dBm/1MHz)
Low	5190	-2.72	-2.72	24.00	11.00
High	5230	-2.72	-2.72	24.00	11.00

<b>Duty Cycle CF (dB)</b>	0.10	<b>Included in Calculations of Corr'PSD</b>
---------------------------	------	---

**Output Power Results**

Channel	Frequency (MHz)	UAT 2 Meas Power (dBm)	Total Corr'd Power (dBm)	Power Limit (dBm)	Power Margin (dB)
Low	5190	17.88	17.88	24.00	-6.12
High	5230	19.31	19.31	24.00	-4.69

**PSD Results**

Channel	Frequency (MHz)	UAT 2 Meas PSD (dBm/1MHz)	Total Corr'd PSD (dBm/1MHz)	PSD Limit (dBm/1MHz)	PSD Margin (dB)
Low	5190	6.450	6.55	11.00	-4.45
High	5230	6.680	6.78	11.00	-4.22

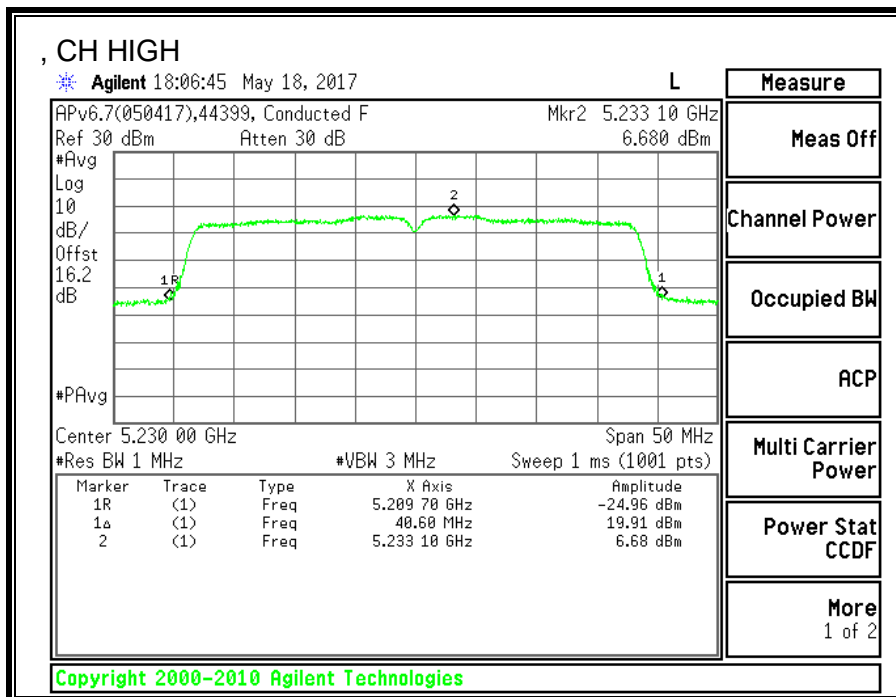
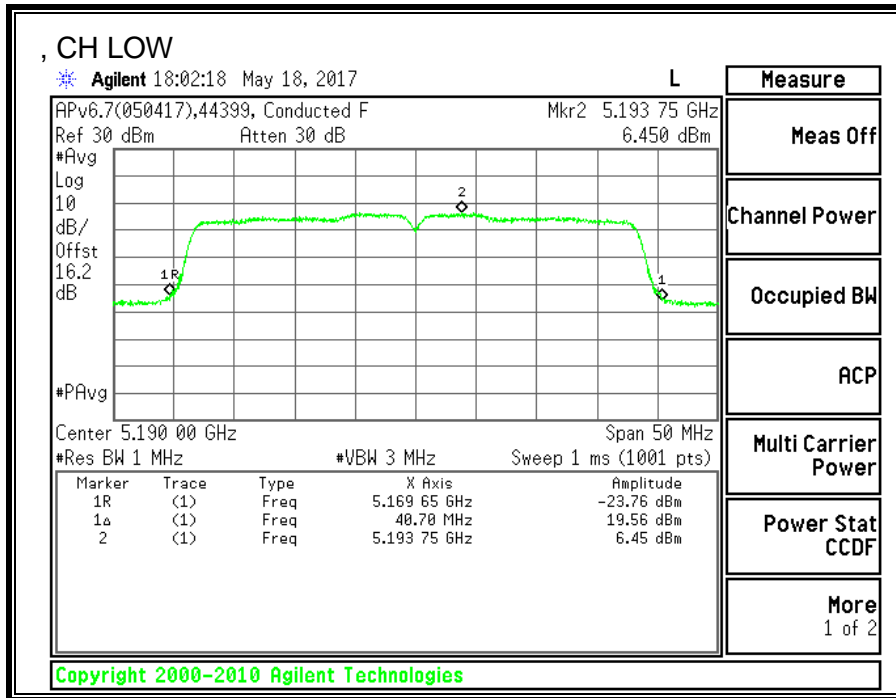

**8.5. 11n HT40 LAT 3 SISO MODE IN THE 5.2GHz BAND**

**8.5.1. 26 dB BANDWIDTH**

**LIMITS**

None; for reporting purposes only.

**RESULTS**

<b>Channel</b>	<b>Frequency</b>	<b>26 dB BW LAT 3 (MHz)</b>
Low	5190	40.8
High	5230	40.7

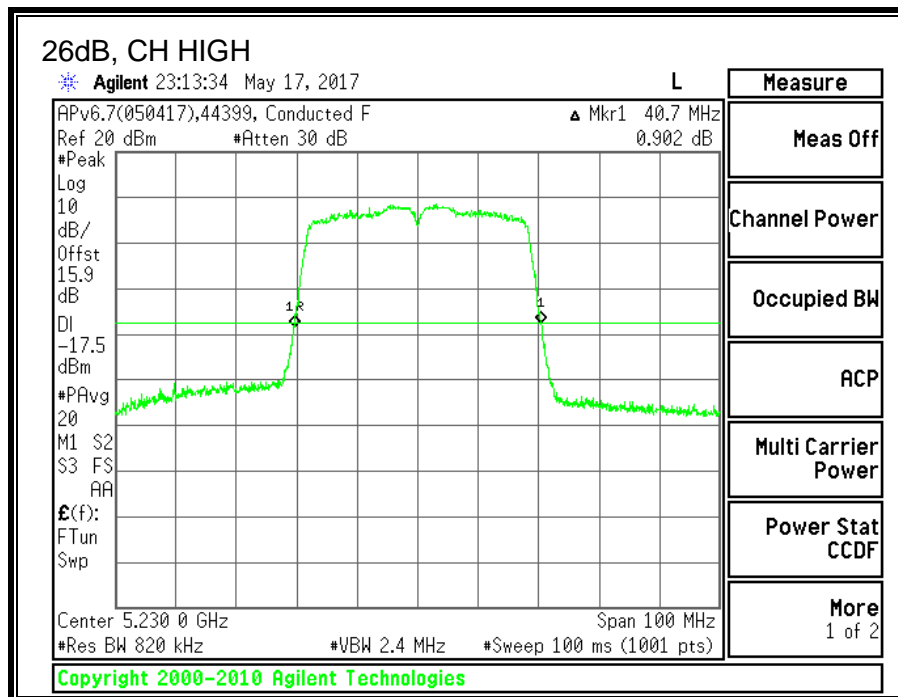
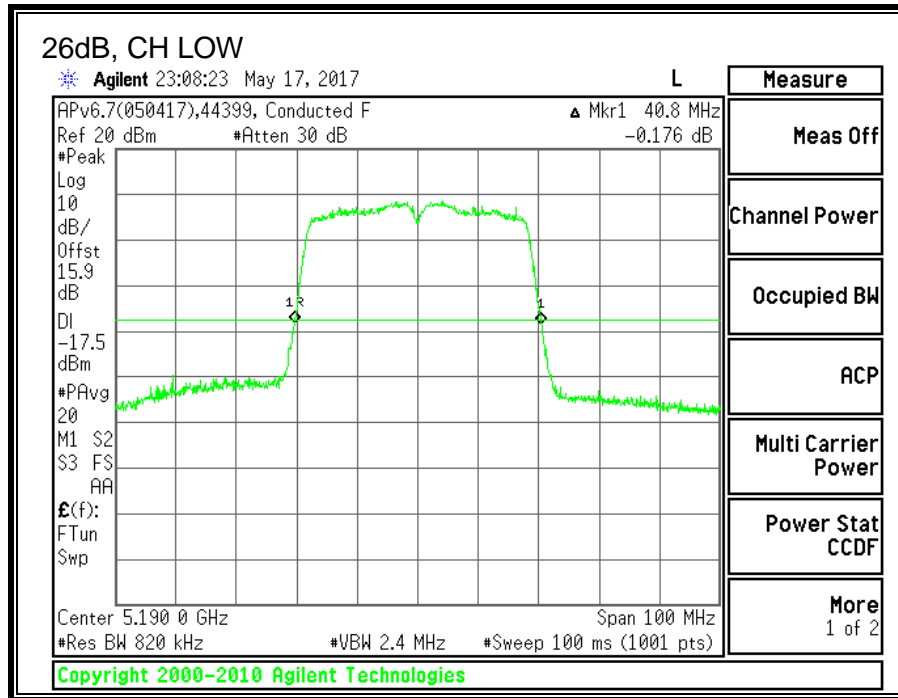

**8.5.2. 99% BANDWIDTH**

**LIMITS**

None; for reporting purposes only.

**RESULTS**

<b>Channel</b>	<b>Frequency</b>	<b>99% BW LAT 3 (MHz)</b>
Low	5190	36.0970
High	5230	36.1244

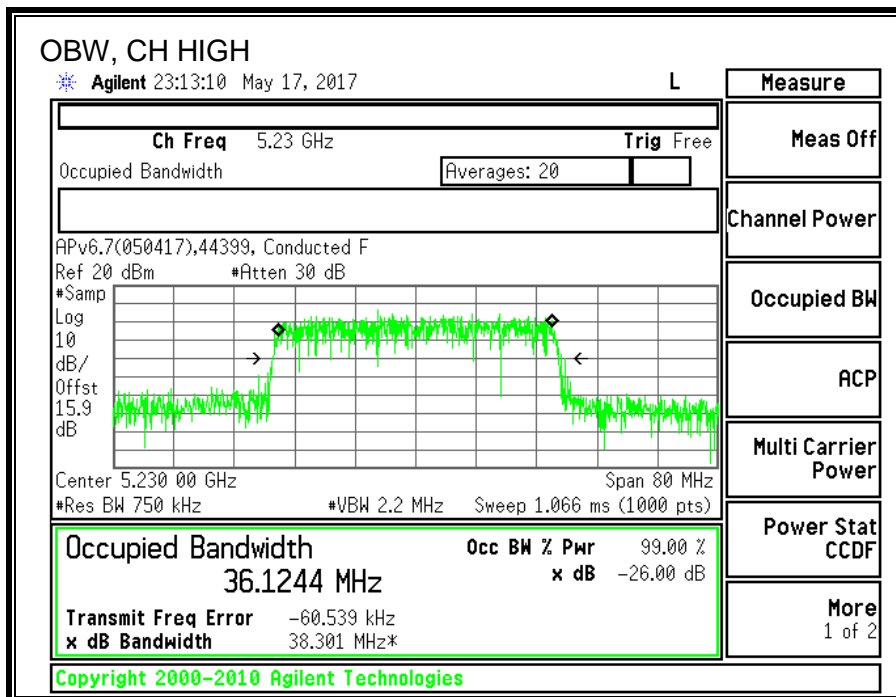
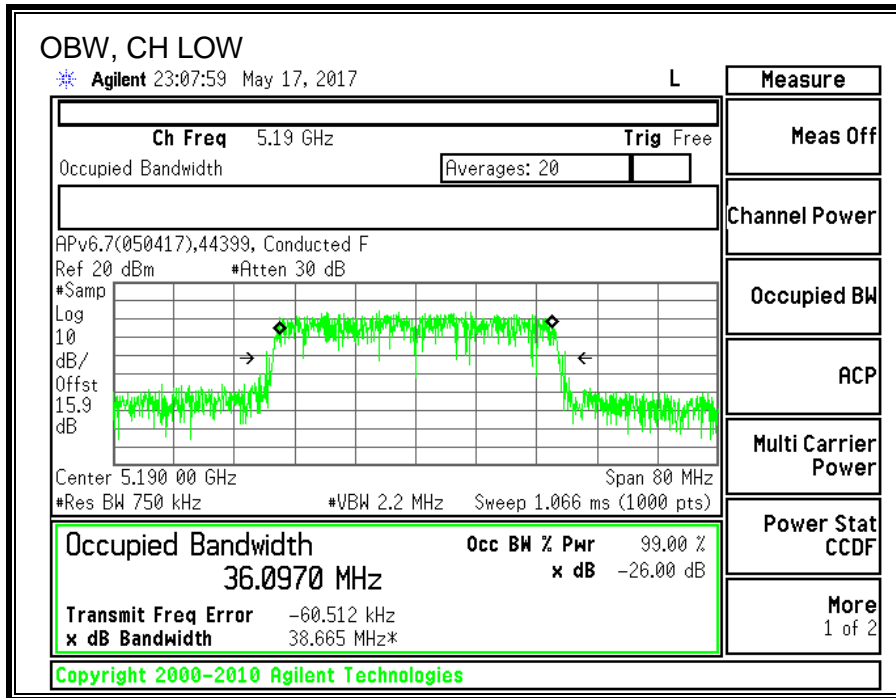

**8.5.3. AVERAGE POWER**

<b>ID:</b>	44366	<b>Date:</b>	7/25/17
------------	-------	--------------	---------

**LIMITS**

None; for reporting purposes only.

**TEST PROCEDURE**

Measurements perform using a wideband gated RF power meter.

**RESULTS**

<b>Channel</b>	<b>Frequency</b>	<b>Power LAT 3 (dBm)</b>
Low	5190	17.83
High	5230	19.39



## 8.5.4. OUTPUT POWER AND PPSD

### **LIMITS**

FCC §15.407 (a) (1)

(i) For an outdoor access point operating in the band 5.15-5.25 GHz, the maximum conducted output power over the frequency band of operation shall not exceed 1 W provided the maximum antenna gain does not exceed 6 dBi. In addition, the maximum power spectral density shall not exceed 17 dBm in any 1 megahertz band. If transmitting antennas of directional gain greater than 6 dBi are used, both the maximum conducted output power and the maximum power spectral density shall be reduced by the amount in dB that the directional gain of the antenna exceeds 6 dBi. The maximum e.i.r.p. at any elevation angle above 30 degrees as measured from the horizon must not exceed 125 mW (21 dBm).

(ii) For an indoor access point operating in the band 5.15-5.25 GHz, the maximum conducted output power over the frequency band of operation shall not exceed 1 W provided the maximum antenna gain does not exceed 6 dBi. In addition, the maximum power spectral density shall not exceed 17 dBm in any 1 megahertz band. If transmitting antennas of directional gain greater than 6 dBi are used, both the maximum conducted output power and the maximum power spectral density shall be reduced by the amount in dB that the directional gain of the antenna exceeds 6 dBi.

(iii) For fixed point-to-point access points operating in the band 5.15-5.25 GHz, the maximum conducted output power over the frequency band of operation shall not exceed 1 W. Fixed point-to-point U-NII devices may employ antennas with directional gain up to 23 dBi without any corresponding reduction in the maximum conducted output power or maximum power spectral density. For fixed point-to-point transmitters that employ a directional antenna gain greater than 23 dBi, a 1 dB reduction in maximum conducted output power and maximum power spectral density is required for each 1 dB of antenna gain in excess of 23 dBi. Fixed, point-to-point operations exclude the use of point-to-multipoint systems, omnidirectional applications, and multiple collocated transmitters transmitting the same information. The operator of the U-NII device, or if the equipment is professionally installed, the installer, is responsible for ensuring that systems employing high gain directional antennas are used exclusively for fixed, point-to-point operations.

(iv) For mobile and portable client devices in the 5.15-5.25 GHz band, the maximum conducted output power over the frequency band of operation shall not exceed 250 mW provided the maximum antenna gain does not exceed 6 dBi. In addition, the maximum power spectral density shall not exceed 11 dBm in any 1 megahertz band. If transmitting antennas of directional gain greater than 6 dBi are used, both the maximum conducted output power and the maximum power spectral density shall be reduced by the amount in dB that the directional gain of the antenna exceeds 6 dBi.

### **TEST PROCEDURE**

Measurements perform using a wideband gated RF power meter provided that the gate parameters are adjusted such that the power is measured only when the EUT is transmitting at its maximum power control level. Since the measurement is made only during the ON time of the transmitter, no duty cycle correction factor is required.

### **DIRECTIONAL ANTENNA GAIN**

There is only one transmitter output therefore the directional gain is equal to the antenna gain.

**RESULTS**

**Antenna Gain and Limits**

Channel	Frequency (MHz)	Directional Gain for Power (dBi)	Directional Gain for PSD (dBi)	Power Limit (dBm)	PSD Limit (dBm/1MHz)
Low	5190	-7.38	-7.38	24.00	11.00
High	5230	-7.38	-7.38	24.00	11.00

<b>Duty Cycle CF (dB)</b>	0.10	<b>Included in Calculations of Corr'PSD</b>
---------------------------	------	---

**Output Power Results**

Channel	Frequency (MHz)	LAT 3 Meas Power (dBm)	Total Corr'd Power (dBm)	Power Limit (dBm)	Power Margin (dB)
Low	5190	17.83	17.83	24.00	-6.17
High	5230	19.39	19.39	24.00	-4.61

**PSD Results**

Channel	Frequency (MHz)	LAT 3 Meas PSD (dBm/1MHz)	Total Corr'd PSD (dBm/1MHz)	PSD Limit (dBm/1MHz)	PSD Margin (dB)
Low	5190	6.665	6.77	11.00	-4.24
High	5230	6.798	6.90	11.00	-4.10

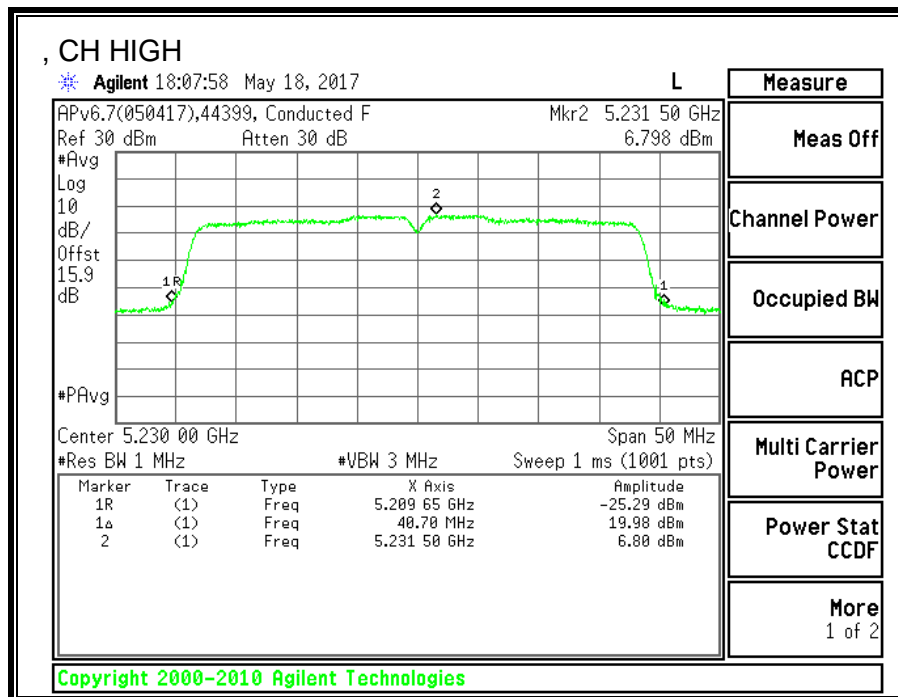
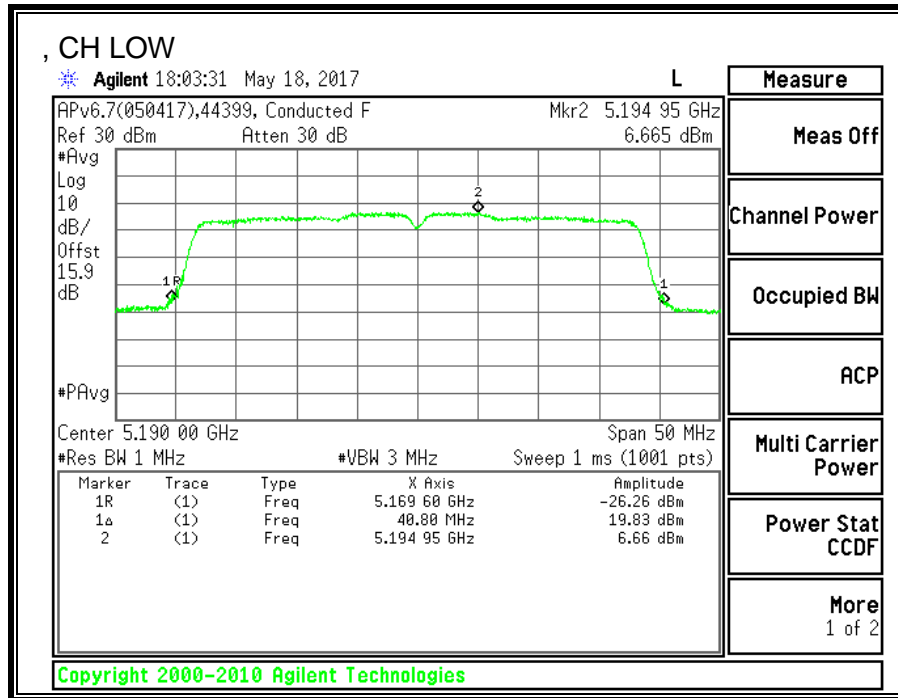

**8.6. 11n HT40 2TX CDD MIMO MODE IN THE 5.2GHz BAND**

**8.6.1. 26 dB BANDWIDTH**

**LIMITS**

None; for reporting purposes only.

**RESULTS**

<b>Channel</b>	<b>Frequency</b>	<b>26 dB BW UAT 2 (MHz)</b>	<b>26 dB BW LAT 3 (MHz)</b>
Low	5190	40.7	40.1
High	5230	40.7	40.2

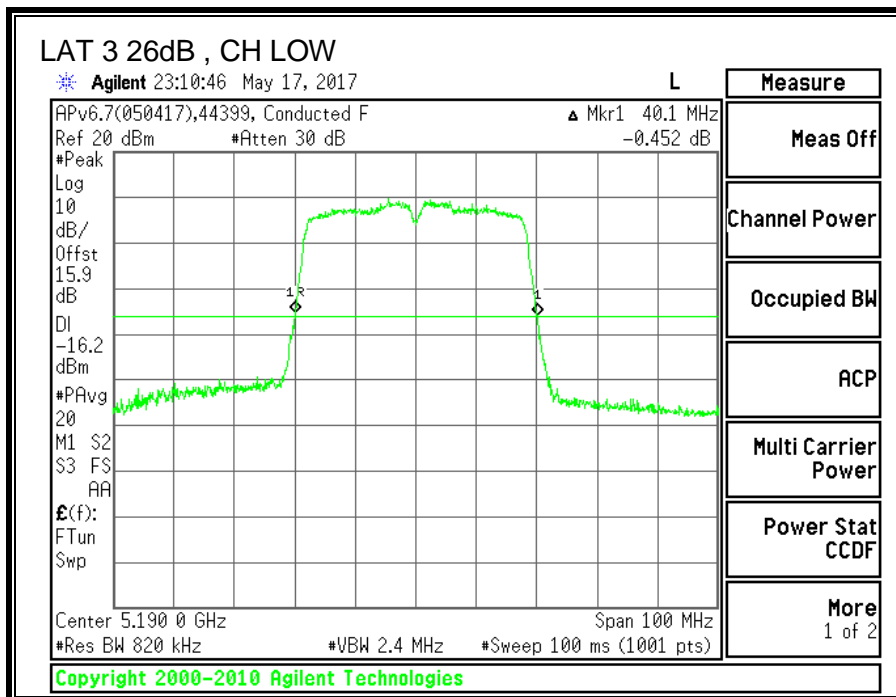
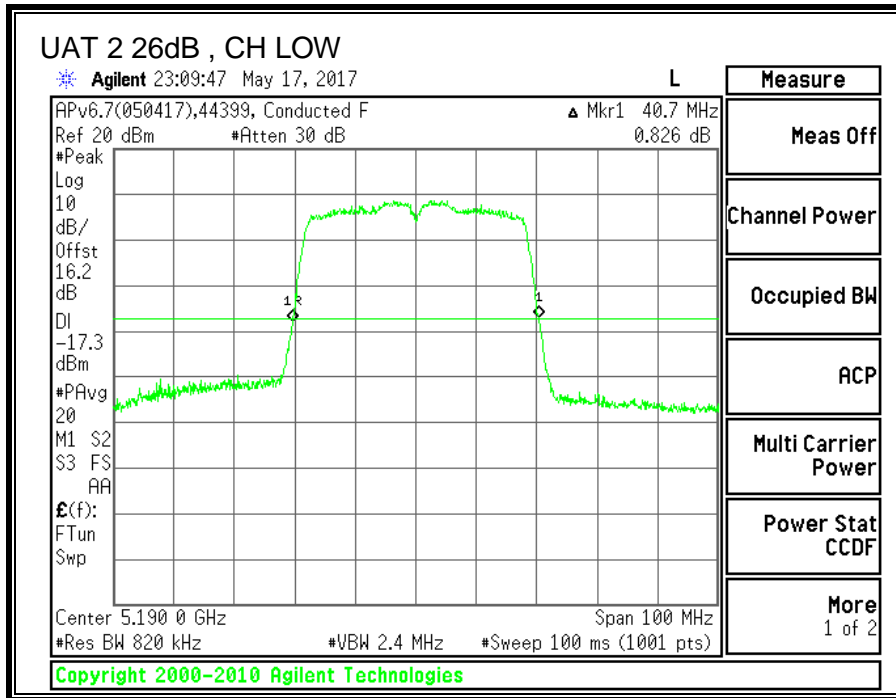

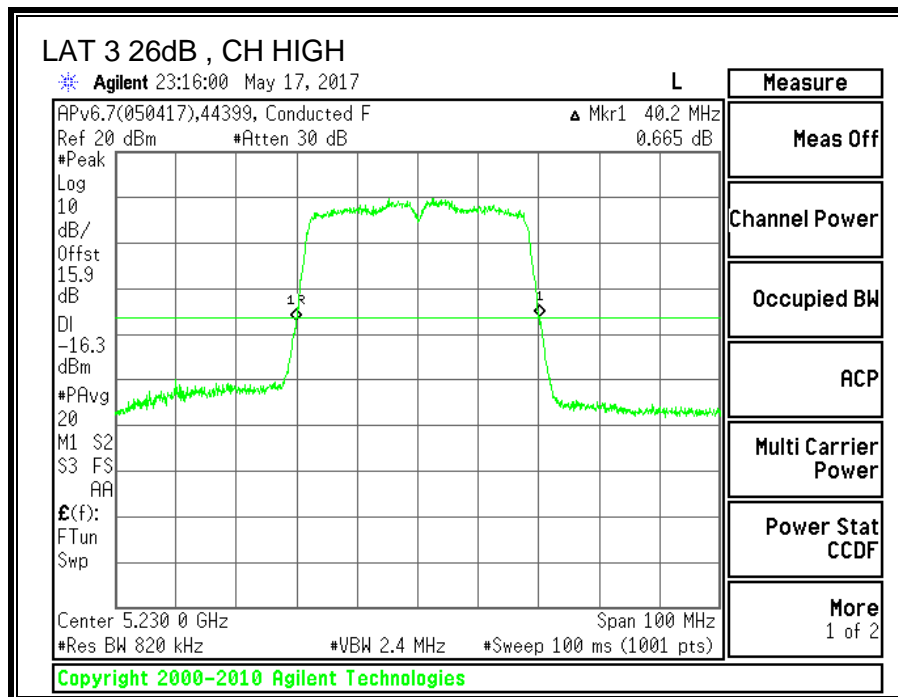
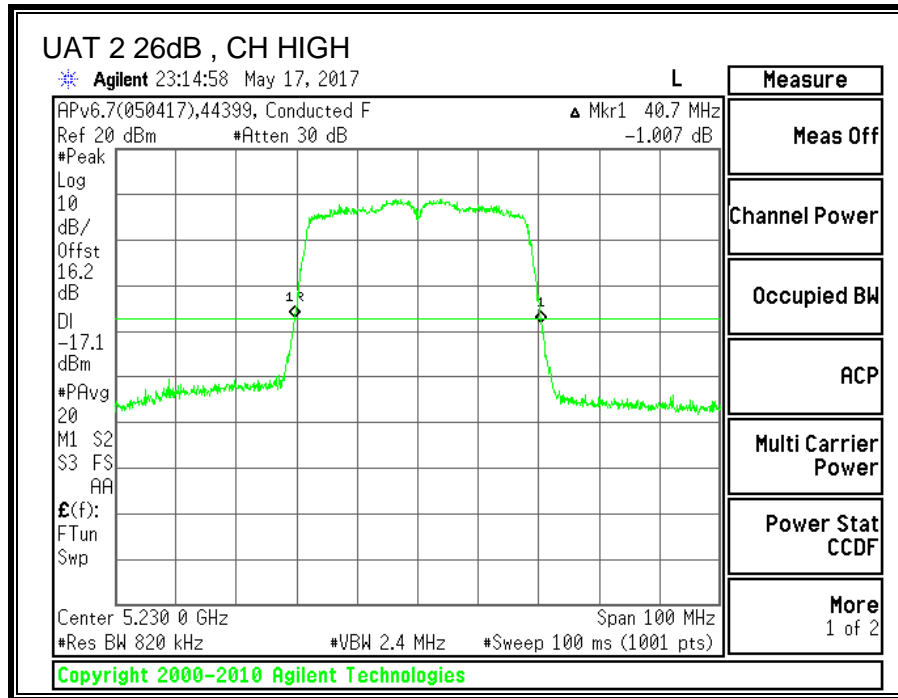

**8.6.2. 99% BANDWIDTH**

**LIMITS**

None; for reporting purposes only.

**RESULTS**

<b>Channel</b>	<b>Frequency</b>	<b>99% BW UAT 2 (MHz)</b>	<b>99% BW LAT 3 (MHz)</b>
Low	5190	36.1228	36.1142
High	5230	36.1415	36.1707

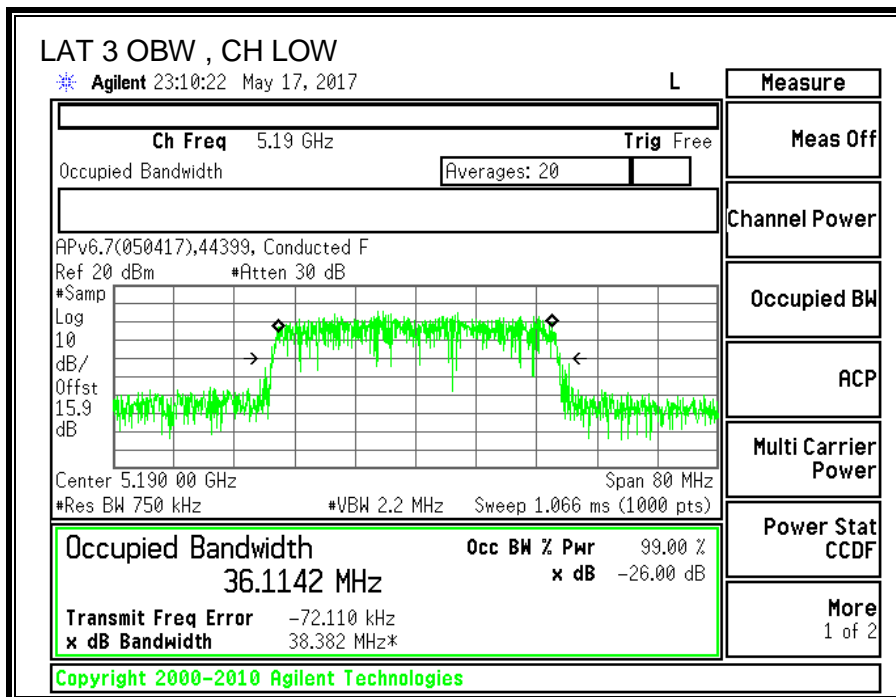
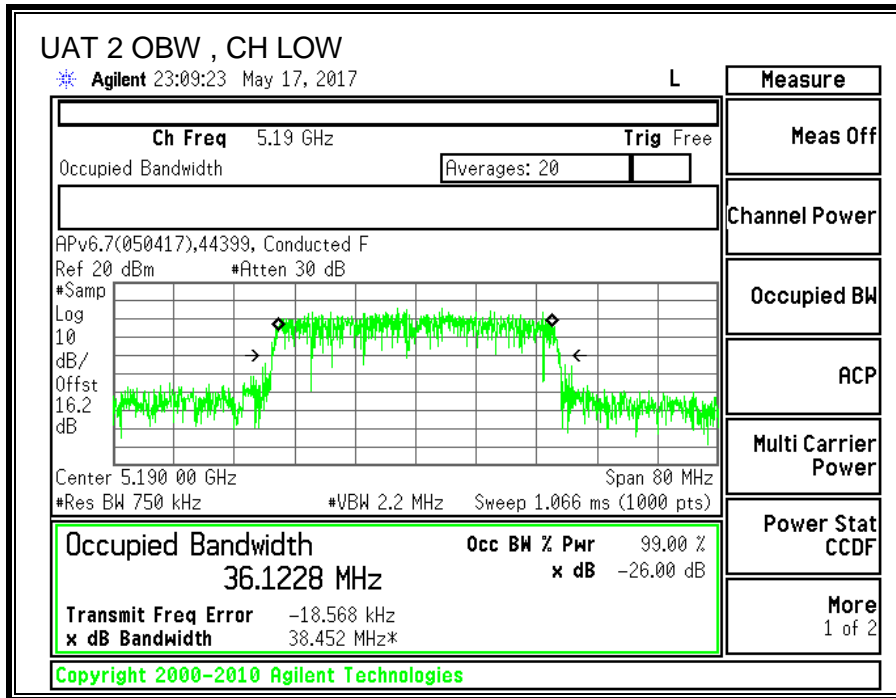



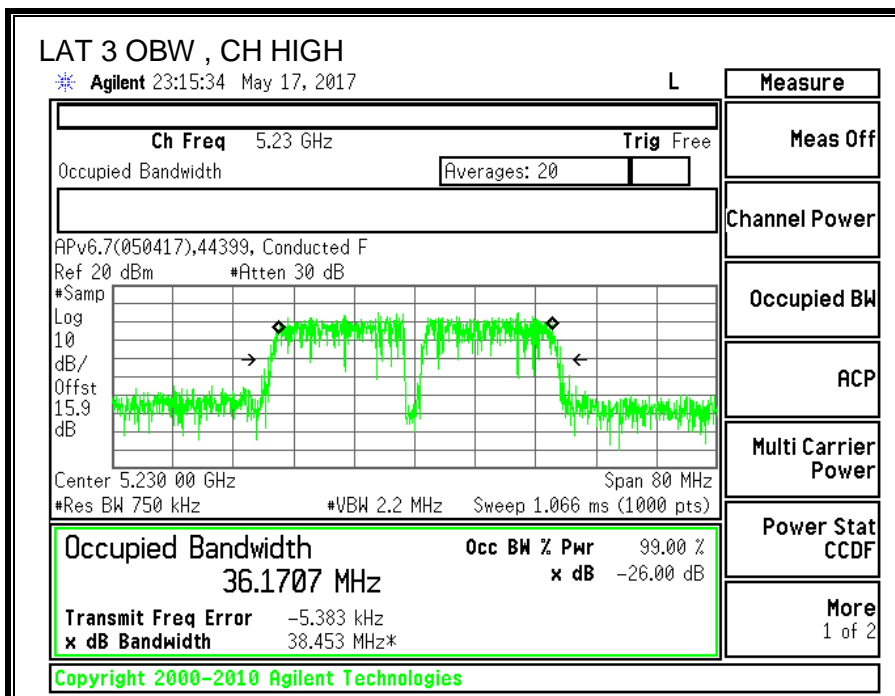
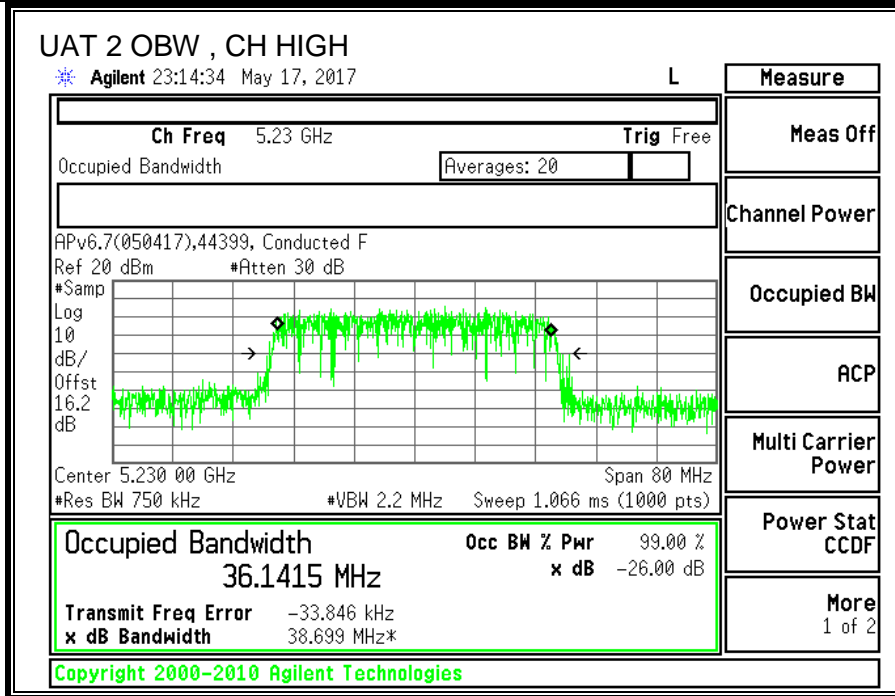

**8.6.3. AVERAGE POWER**

<b>ID:</b>	44366	<b>Date:</b>	7/25/17
------------	-------	--------------	---------

**LIMITS**

None; for reporting purposes only.

**TEST PROCEDURE**

Measurements perform using a wideband gated RF power meter.

**RESULTS**

**Average Power Results**

<b>Channel</b>	<b>Frequency (MHz)</b>	<b>UAT 2 Power (dBm)</b>	<b>LAT 3 Power (dBm)</b>	<b>Total Power (dBm)</b>
Low	5190	16.87	16.75	19.82
High	5230	19.31	19.32	22.33

## 8.6.4. OUTPUT POWER AND PPSD

### LIMITS

FCC §15.407 (a) (1)

(i) For an outdoor access point operating in the band 5.15-5.25 GHz, the maximum conducted output power over the frequency band of operation shall not exceed 1 W provided the maximum antenna gain does not exceed 6 dBi. In addition, the maximum power spectral density shall not exceed 17 dBm in any 1 megahertz band. If transmitting antennas of directional gain greater than 6 dBi are used, both the maximum conducted output power and the maximum power spectral density shall be reduced by the amount in dB that the directional gain of the antenna exceeds 6 dBi. The maximum e.i.r.p. at any elevation angle above 30 degrees as measured from the horizon must not exceed 125 mW (21 dBm).

(ii) For an indoor access point operating in the band 5.15-5.25 GHz, the maximum conducted output power over the frequency band of operation shall not exceed 1 W provided the maximum antenna gain does not exceed 6 dBi. In addition, the maximum power spectral density shall not exceed 17 dBm in any 1 megahertz band. If transmitting antennas of directional gain greater than 6 dBi are used, both the maximum conducted output power and the maximum power spectral density shall be reduced by the amount in dB that the directional gain of the antenna exceeds 6 dBi.

(iii) For fixed point-to-point access points operating in the band 5.15-5.25 GHz, the maximum conducted output power over the frequency band of operation shall not exceed 1 W. Fixed point-to-point U-NII devices may employ antennas with directional gain up to 23 dBi without any corresponding reduction in the maximum conducted output power or maximum power spectral density. For fixed point-to-point transmitters that employ a directional antenna gain greater than 23 dBi, a 1 dB reduction in maximum conducted output power and maximum power spectral density is required for each 1 dB of antenna gain in excess of 23 dBi. Fixed, point-to-point operations exclude the use of point-to-multipoint systems, omnidirectional applications, and multiple collocated transmitters transmitting the same information. The operator of the U-NII device, or if the equipment is professionally installed, the installer, is responsible for ensuring that systems employing high gain directional antennas are used exclusively for fixed, point-to-point operations.

(iv) For mobile and portable client devices in the 5.15-5.25 GHz band, the maximum conducted output power over the frequency band of operation shall not exceed 250 mW provided the maximum antenna gain does not exceed 6 dBi. In addition, the maximum power spectral density shall not exceed 11 dBm in any 1 megahertz band. If transmitting antennas of directional gain greater than 6 dBi are used, both the maximum conducted output power and the maximum power spectral density shall be reduced by the amount in dB that the directional gain of the antenna exceeds 6 dBi.

### TEST PROCEDURE

Measurements perform using a wideband gated RF power meter provided that the gate parameters are adjusted such that the power is measured only when the EUT is transmitting at its maximum power control level. Since the measurement is made only during the ON time of the transmitter, no duty cycle correction factor is required.

**DIRECTIONAL ANTENNA GAIN**

For Power used uncorrelated gain: The TX chains are uncorrelated and the antenna gain is unequal among the chains. The directional gain is:

<b>UAT 2 Antenna Gain (dBi)</b>	<b>LAT 3 Antenna Gain (dBi)</b>	<b>Uncorrelated Chains Directional Gain (dBi)</b>
-2.72	-7.37	-4.45

For PSD used correlated gain: The TX chains are correlated and the antenna gain is unequal among the chains. The directional gain is:

<b>UAT 2 Antenna Gain (dBi)</b>	<b>LAT 3 Antenna Gain (dBi)</b>	<b>Correlated Chains Directional Gain (dBi)</b>
-2.72	-7.38	-1.73

**RESULTS**

**Antenna Gain and Limits**

Channel	Frequency (MHz)	Directional Gain for Power (dBi)	Directional Gain for PSD (dBi)	Power Limit (dBm)	PSD Limit (dBm/1MHz)
Low	5190	-4.45	-1.73	24.00	11.00
High	5230	-4.45	-1.73	24.00	11.00

<b>Duty Cycle CF (dB)</b>	0.10	<b>Included in Calculations of Corr'd PSD</b>
---------------------------	------	---

**Output Power Results**

Channel	Frequency (MHz)	UAT 2 Meas Power (dBm)	LAT 3 Meas Power (dBm)	Total Corr'd Power (dBm)	Power Limit (dBm)	Power Margin (dB)
Low	5190	16.87	16.75	19.82	24.00	-4.18
High	5230	19.31	19.32	22.33	24.00	-1.67

**PSD Results**

Channel	Frequency (MHz)	UAT 2 Meas PSD (dBm/1MHz)	LAT 3 Meas PSD (dBm/1MHz)	Total Corr'd PSD (dBm/1MHz)	PSD Limit (dBm/1MHz)	PSD Margin (dB)
Low	5190	5.205	5.019	8.22	11.00	-2.78
High	5230	5.145	4.648	8.01	11.00	-2.99

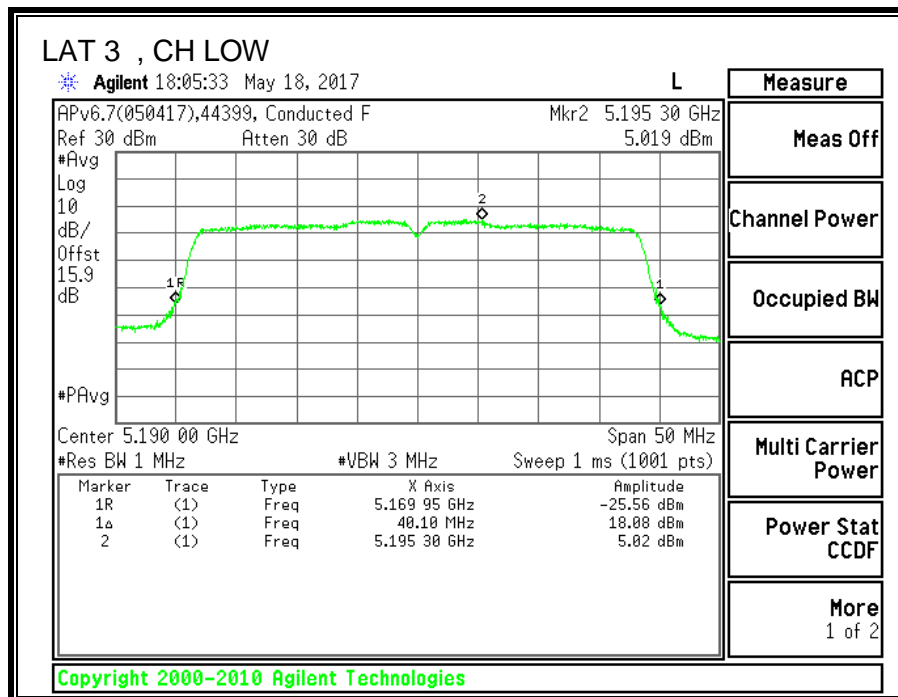
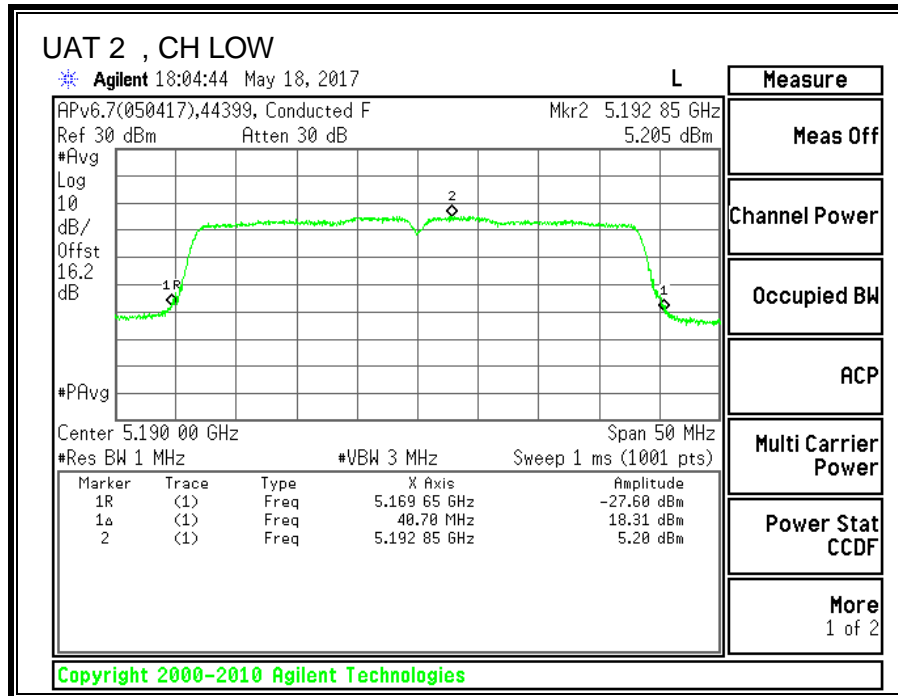

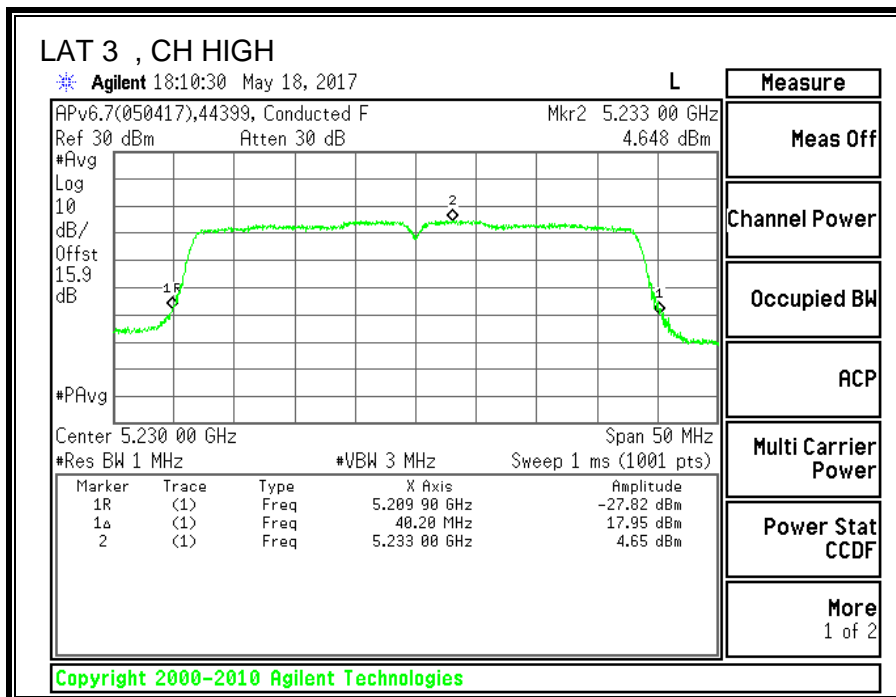
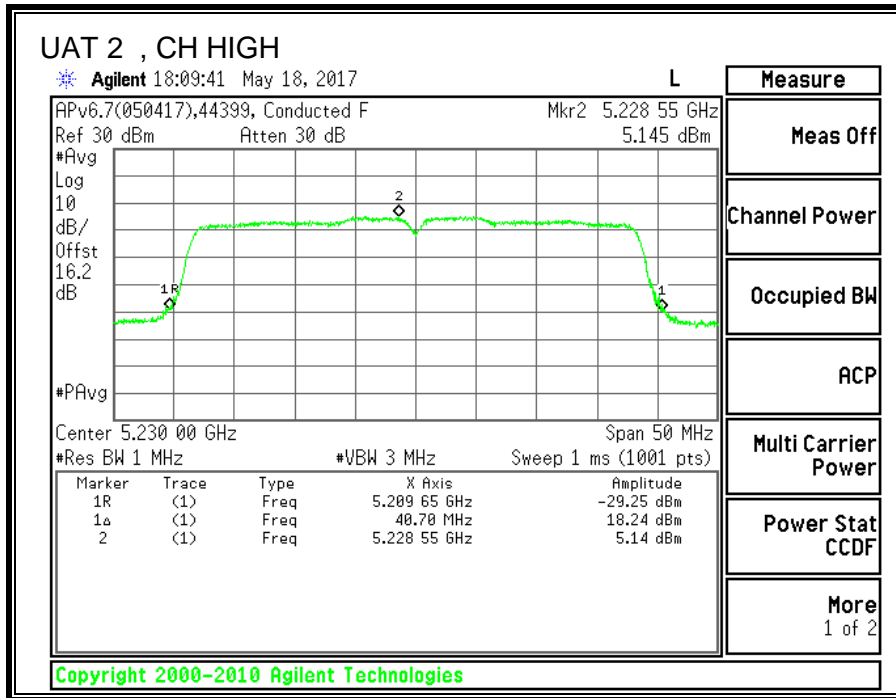

**8.7. 11ac HT80 UAT 2 SISO MODE IN THE 5.2GHz BAND**

**8.7.1. 26 dB BANDWIDTH**

**LIMITS**

None; for reporting purposes only.

**RESULTS**

<b>Channel</b>	<b>Frequency</b>	<b>26 dB BW UAT 2 (MHz)</b>
Mid	5210	82.4



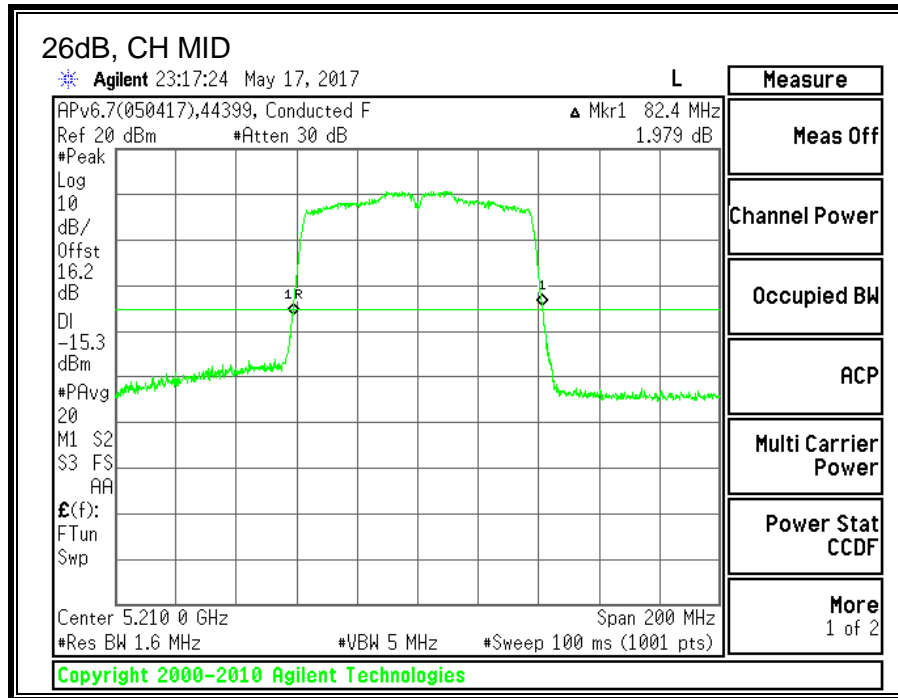

---

### 8.7.2. 99% BANDWIDTH

#### LIMITS

None; for reporting purposes only.

#### RESULTS

Channel	Frequency	99% BW UAT 2 (MHz)
Mid	5210	75.0891

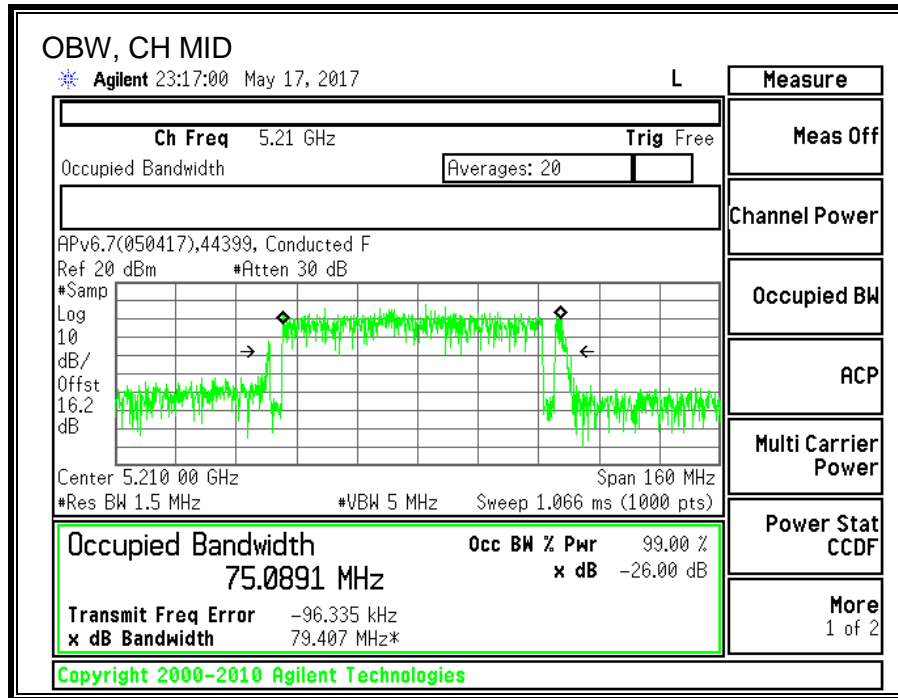

**8.7.3. AVERAGE POWER**

<b>ID:</b>	44366	<b>Date:</b>	7/25/17
------------	-------	--------------	---------

**LIMITS**

None; for reporting purposes only.

**TEST PROCEDURE**

Measurements perform using a wideband gated RF power meter.

**RESULTS**

Channel	Frequency	Power UAT 2 (dBm)
Mid	5210	17.36

## 8.7.4. OUTPUT POWER AND PPSD

### LIMITS

FCC §15.407 (a) (1)

(i) For an outdoor access point operating in the band 5.15-5.25 GHz, the maximum conducted output power over the frequency band of operation shall not exceed 1 W provided the maximum antenna gain does not exceed 6 dBi. In addition, the maximum power spectral density shall not exceed 17 dBm in any 1 megahertz band. If transmitting antennas of directional gain greater than 6 dBi are used, both the maximum conducted output power and the maximum power spectral density shall be reduced by the amount in dB that the directional gain of the antenna exceeds 6 dBi. The maximum e.i.r.p. at any elevation angle above 30 degrees as measured from the horizon must not exceed 125 mW (21 dBm).

(ii) For an indoor access point operating in the band 5.15-5.25 GHz, the maximum conducted output power over the frequency band of operation shall not exceed 1 W provided the maximum antenna gain does not exceed 6 dBi. In addition, the maximum power spectral density shall not exceed 17 dBm in any 1 megahertz band. If transmitting antennas of directional gain greater than 6 dBi are used, both the maximum conducted output power and the maximum power spectral density shall be reduced by the amount in dB that the directional gain of the antenna exceeds 6 dBi.

(iii) For fixed point-to-point access points operating in the band 5.15-5.25 GHz, the maximum conducted output power over the frequency band of operation shall not exceed 1 W. Fixed point-to-point U-NII devices may employ antennas with directional gain up to 23 dBi without any corresponding reduction in the maximum conducted output power or maximum power spectral density. For fixed point-to-point transmitters that employ a directional antenna gain greater than 23 dBi, a 1 dB reduction in maximum conducted output power and maximum power spectral density is required for each 1 dB of antenna gain in excess of 23 dBi. Fixed, point-to-point operations exclude the use of point-to-multipoint systems, omnidirectional applications, and multiple collocated transmitters transmitting the same information. The operator of the U-NII device, or if the equipment is professionally installed, the installer, is responsible for ensuring that systems employing high gain directional antennas are used exclusively for fixed, point-to-point operations.

(iv) For mobile and portable client devices in the 5.15-5.25 GHz band, the maximum conducted output power over the frequency band of operation shall not exceed 250 mW provided the maximum antenna gain does not exceed 6 dBi. In addition, the maximum power spectral density shall not exceed 11 dBm in any 1 megahertz band. If transmitting antennas of directional gain greater than 6 dBi are used, both the maximum conducted output power and the maximum power spectral density shall be reduced by the amount in dB that the directional gain of the antenna exceeds 6 dBi.

### TEST PROCEDURE

Measurements perform using a wideband gated RF power meter provided that the gate parameters are adjusted such that the power is measured only when the EUT is transmitting at its maximum power control level. Since the measurement is made only during the ON time of the transmitter, no duty cycle correction factor is required.

### DIRECTIONAL ANTENNA GAIN

There is only one transmitter output therefore the directional gain is equal to the antenna gain.

**RESULTS**

**Antenna Gain and Limits**

Channel	Frequency (MHz)	Directional Gain for Power (dBi)	Directional Gain for PSD (dBi)	Power Limit (dBm)	PSD Limit (dBm/1MHz)
Mid	5210	-2.72	-2.72	24.00	11.00

<b>Duty Cycle CF (dB)</b>	0.19	<b>Included in Calculations of Corr'd PSD</b>
---------------------------	------	---

**Output Power Results**

Channel	Frequency (MHz)	UAT 2 Meas Power (dBm)	Total Corr'd Power (dBm)	Power Limit (dBm)	Power Margin (dB)
Mid	5210	17.36	17.36	24.00	-6.64

**PSD Results**

Channel	Frequency (MHz)	UAT 2 Meas PSD (dBm/1MHz)	Total Corr'd PSD (dBm/1MHz)	PSD Limit (dBm/1MHz)	PSD Margin (dB)
Mid	5210	4.261	4.45	11.00	-6.55

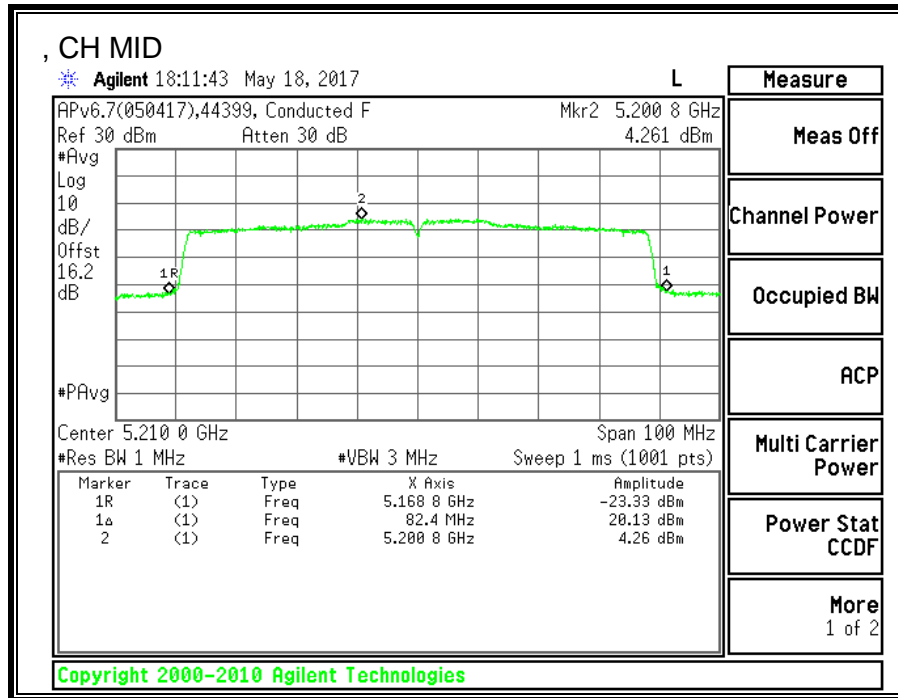

**8.8. 11ac HT80 LAT 3 SISO MODE IN THE 5.2GHz BAND**

**8.8.1. 26 dB BANDWIDTH**

**LIMITS**

None; for reporting purposes only.

**RESULTS**

<b>Channel</b>	<b>Frequency</b>	<b>26 dB BW LAT 3 (MHz)</b>
Mid	5210	82.2



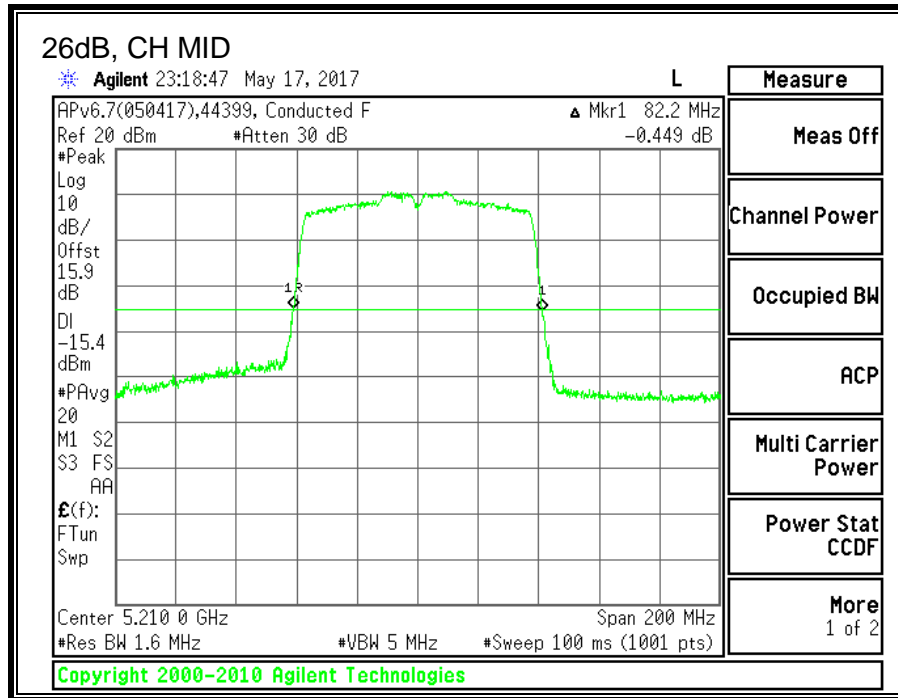

**8.8.2. 99% BANDWIDTH**

**LIMITS**

None; for reporting purposes only.

**RESULTS**

<b>Channel</b>	<b>Frequency</b>	<b>99% BW LAT 3 (MHz)</b>
Mid	5210	75.1889

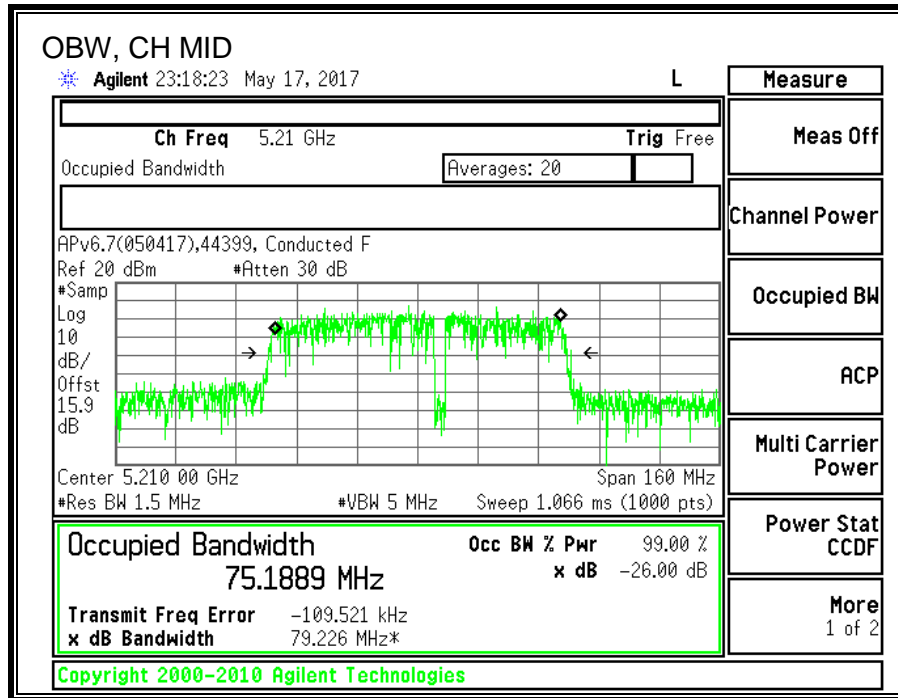

**8.8.3. AVERAGE POWER**

<b>ID:</b>	44366	<b>Date:</b>	7/25/17
------------	-------	--------------	---------

**LIMITS**

None; for reporting purposes only.

**TEST PROCEDURE**

Measurements perform using a wideband gated RF power meter.

**RESULTS**

<b>Channel</b>	<b>Frequency</b>	<b>Power LAT 3 (dBm)</b>
Mid	5210	17.23

## 8.8.4. OUTPUT POWER AND PPSD

### LIMITS

FCC §15.407 (a) (1)

(i) For an outdoor access point operating in the band 5.15-5.25 GHz, the maximum conducted output power over the frequency band of operation shall not exceed 1 W provided the maximum antenna gain does not exceed 6 dBi. In addition, the maximum power spectral density shall not exceed 17 dBm in any 1 megahertz band. If transmitting antennas of directional gain greater than 6 dBi are used, both the maximum conducted output power and the maximum power spectral density shall be reduced by the amount in dB that the directional gain of the antenna exceeds 6 dBi. The maximum e.i.r.p. at any elevation angle above 30 degrees as measured from the horizon must not exceed 125 mW (21 dBm).

(ii) For an indoor access point operating in the band 5.15-5.25 GHz, the maximum conducted output power over the frequency band of operation shall not exceed 1 W provided the maximum antenna gain does not exceed 6 dBi. In addition, the maximum power spectral density shall not exceed 17 dBm in any 1 megahertz band. If transmitting antennas of directional gain greater than 6 dBi are used, both the maximum conducted output power and the maximum power spectral density shall be reduced by the amount in dB that the directional gain of the antenna exceeds 6 dBi.

(iii) For fixed point-to-point access points operating in the band 5.15-5.25 GHz, the maximum conducted output power over the frequency band of operation shall not exceed 1 W. Fixed point-to-point U-NII devices may employ antennas with directional gain up to 23 dBi without any corresponding reduction in the maximum conducted output power or maximum power spectral density. For fixed point-to-point transmitters that employ a directional antenna gain greater than 23 dBi, a 1 dB reduction in maximum conducted output power and maximum power spectral density is required for each 1 dB of antenna gain in excess of 23 dBi. Fixed, point-to-point operations exclude the use of point-to-multipoint systems, omnidirectional applications, and multiple collocated transmitters transmitting the same information. The operator of the U-NII device, or if the equipment is professionally installed, the installer, is responsible for ensuring that systems employing high gain directional antennas are used exclusively for fixed, point-to-point operations.

(iv) For mobile and portable client devices in the 5.15-5.25 GHz band, the maximum conducted output power over the frequency band of operation shall not exceed 250 mW provided the maximum antenna gain does not exceed 6 dBi. In addition, the maximum power spectral density shall not exceed 11 dBm in any 1 megahertz band. If transmitting antennas of directional gain greater than 6 dBi are used, both the maximum conducted output power and the maximum power spectral density shall be reduced by the amount in dB that the directional gain of the antenna exceeds 6 dBi.

### TEST PROCEDURE

Measurements perform using a wideband gated RF power meter provided that the gate parameters are adjusted such that the power is measured only when the EUT is transmitting at its maximum power control level. Since the measurement is made only during the ON time of the transmitter, no duty cycle correction factor is required.

### DIRECTIONAL ANTENNA GAIN

There is only one transmitter output therefore the directional gain is equal to the antenna gain.

**RESULTS**

**Antenna Gain and Limits**

Channel	Frequency (MHz)	Directional Gain for Power (dBi)	Directional Gain for PSD (dBi)	Power Limit (dBm)	PSD Limit (dBm/1MHz)
Mid	5210	-7.38	-7.38	24.00	11.00

<b>Duty Cycle CF (dB)</b>	0.19	<b>Included in Calculations of Corr'd PSD</b>
---------------------------	------	---

**Output Power Results**

Channel	Frequency (MHz)	LAT 3 Meas Power (dBm)	Total Corr'd Power (dBm)	Power Limit (dBm)	Power Margin (dB)
Mid	5210	17.23	17.23	24.00	-6.77

**PSD Results**

Channel	Frequency (MHz)	LAT 3 Meas PSD (dBm/1MHz)	Total Corr'd PSD (dBm/1MHz)	PSD Limit (dBm/1MHz)	PSD Margin (dB)
Mid	5210	3.862	4.052	11.00	-6.95

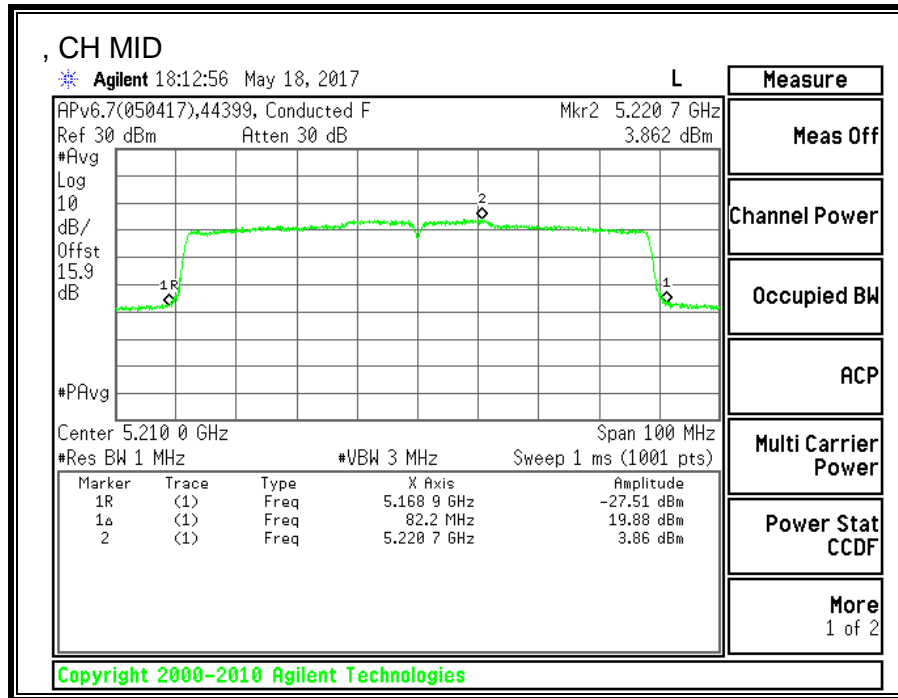

**8.9. 11ac HT80 2TX CDD MIMO MODE IN THE 5.2GHz BAND**

**8.9.1. 26 dB BANDWIDTH**

**LIMITS**

None; for reporting purposes only.

**RESULTS**

<b>Channel</b>	<b>Frequency</b>	<b>26 dB BW UAT 2 (MHz)</b>	<b>26 dB BW LAT 3 (MHz)</b>
Mid	5210	82.4	82



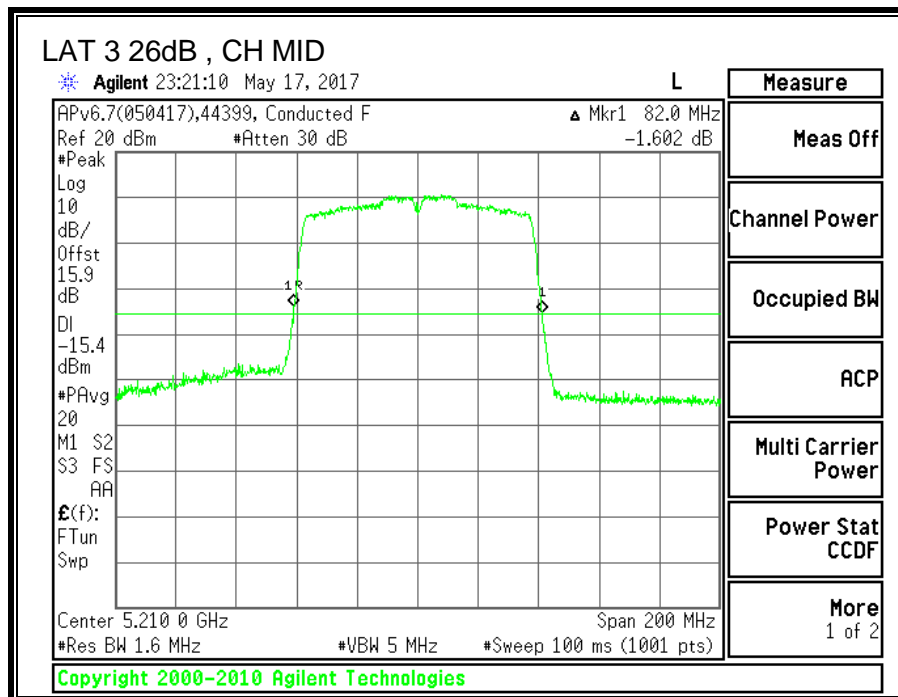
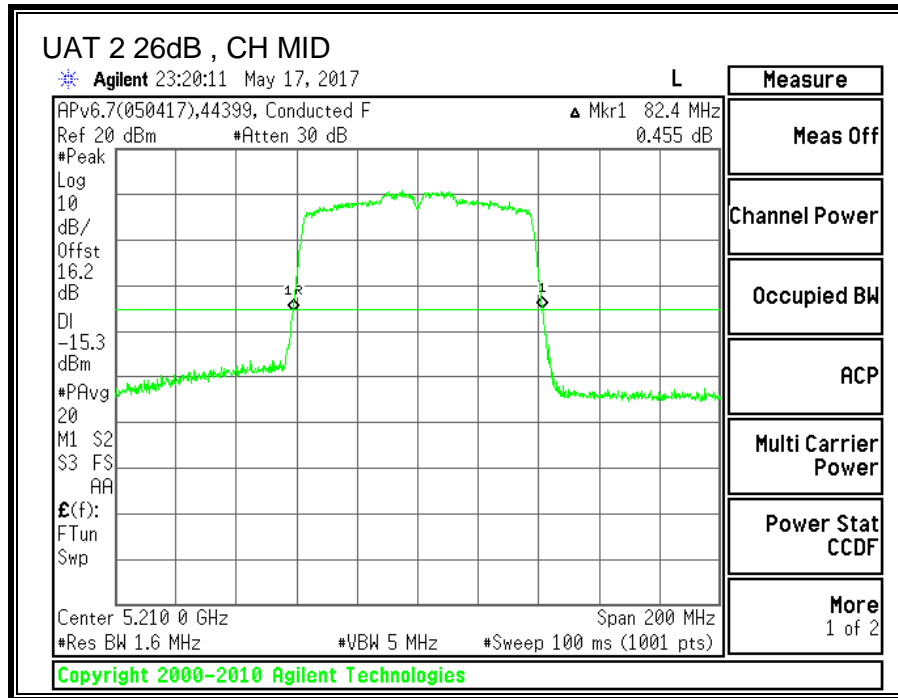

**8.9.2. 99% BANDWIDTH**

**LIMITS**

None; for reporting purposes only.

**RESULTS**

<b>Channel</b>	<b>Frequency</b>	<b>99% BW UAT 2 (MHz)</b>	<b>99% BW LAT 3 (MHz)</b>
Mid	5210	75.4145	74.9460

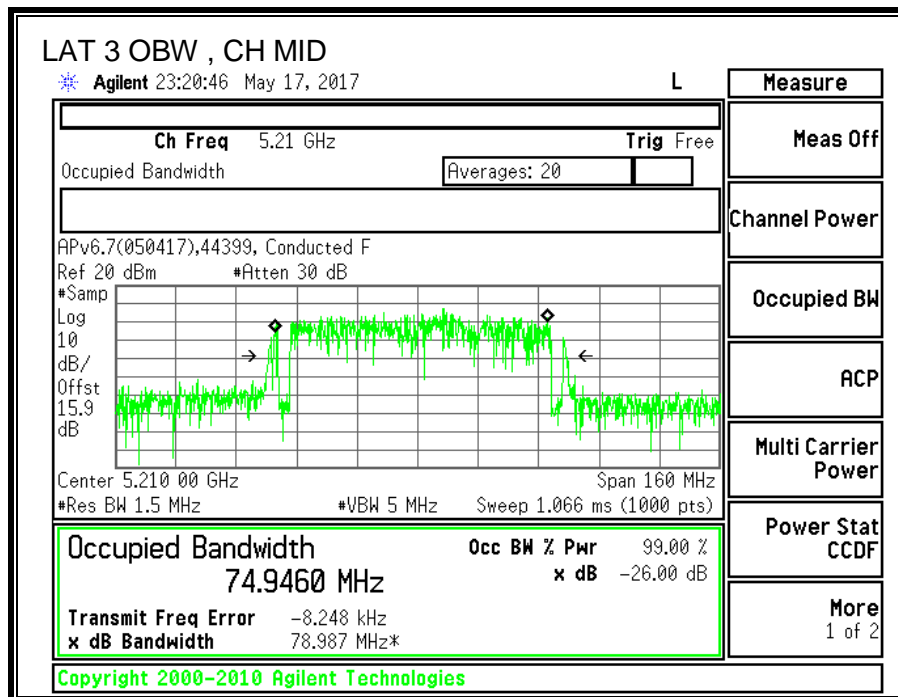
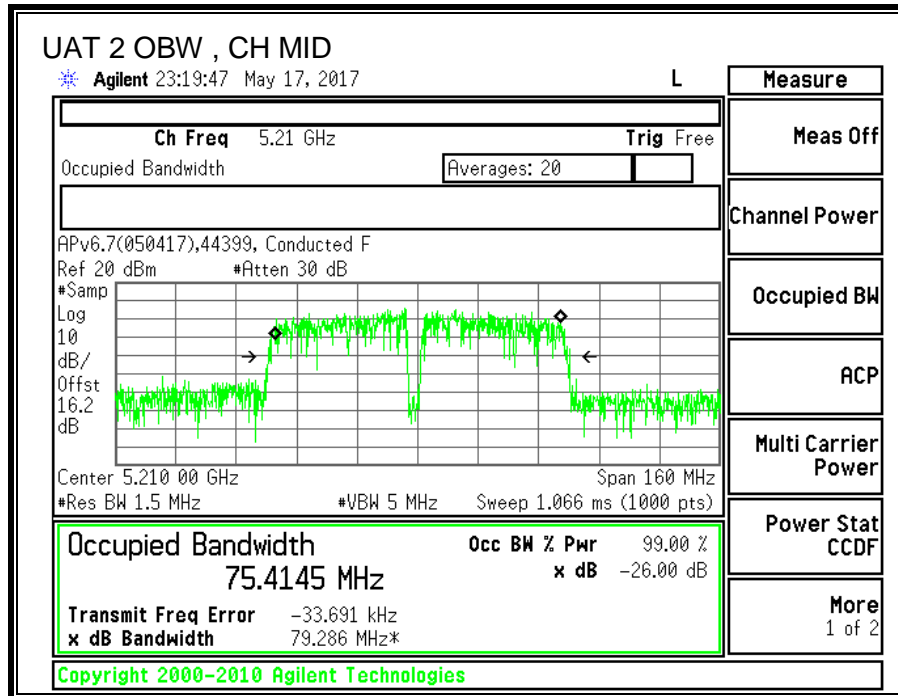

**8.9.3. AVERAGE POWER**

<b>ID:</b>	44366	<b>Date:</b>	7/25/17
------------	-------	--------------	---------

**LIMITS**

None; for reporting purposes only.

**TEST PROCEDURE**

Measurements perform using a wideband gated RF power meter.

**RESULTS**

<b>Channel</b>	<b>Frequency (MHz)</b>	<b>UAT 2 Power (dBm)</b>	<b>LAT 3 Power (dBm)</b>	<b>Total Power (dBm)</b>
Mid	5210	16.28	16.35	19.33

## 8.9.4. OUTPUT POWER AND PPSD

### LIMITS

FCC §15.407 (a) (1)

(i) For an outdoor access point operating in the band 5.15-5.25 GHz, the maximum conducted output power over the frequency band of operation shall not exceed 1 W provided the maximum antenna gain does not exceed 6 dBi. In addition, the maximum power spectral density shall not exceed 17 dBm in any 1 megahertz band. If transmitting antennas of directional gain greater than 6 dBi are used, both the maximum conducted output power and the maximum power spectral density shall be reduced by the amount in dB that the directional gain of the antenna exceeds 6 dBi. The maximum e.i.r.p. at any elevation angle above 30 degrees as measured from the horizon must not exceed 125 mW (21 dBm).

(ii) For an indoor access point operating in the band 5.15-5.25 GHz, the maximum conducted output power over the frequency band of operation shall not exceed 1 W provided the maximum antenna gain does not exceed 6 dBi. In addition, the maximum power spectral density shall not exceed 17 dBm in any 1 megahertz band. If transmitting antennas of directional gain greater than 6 dBi are used, both the maximum conducted output power and the maximum power spectral density shall be reduced by the amount in dB that the directional gain of the antenna exceeds 6 dBi.

(iii) For fixed point-to-point access points operating in the band 5.15-5.25 GHz, the maximum conducted output power over the frequency band of operation shall not exceed 1 W. Fixed point-to-point U-NII devices may employ antennas with directional gain up to 23 dBi without any corresponding reduction in the maximum conducted output power or maximum power spectral density. For fixed point-to-point transmitters that employ a directional antenna gain greater than 23 dBi, a 1 dB reduction in maximum conducted output power and maximum power spectral density is required for each 1 dB of antenna gain in excess of 23 dBi. Fixed, point-to-point operations exclude the use of point-to-multipoint systems, omnidirectional applications, and multiple collocated transmitters transmitting the same information. The operator of the U-NII device, or if the equipment is professionally installed, the installer, is responsible for ensuring that systems employing high gain directional antennas are used exclusively for fixed, point-to-point operations.

(iv) For mobile and portable client devices in the 5.15-5.25 GHz band, the maximum conducted output power over the frequency band of operation shall not exceed 250 mW provided the maximum antenna gain does not exceed 6 dBi. In addition, the maximum power spectral density shall not exceed 11 dBm in any 1 megahertz band. If transmitting antennas of directional gain greater than 6 dBi are used, both the maximum conducted output power and the maximum power spectral density shall be reduced by the amount in dB that the directional gain of the antenna exceeds 6 dBi.

### TEST PROCEDURE

Measurements perform using a wideband gated RF power meter provided that the gate parameters are adjusted such that the power is measured only when the EUT is transmitting at its maximum power control level. Since the measurement is made only during the ON time of the transmitter, no duty cycle correction factor is required.

**DIRECTIONAL ANTENNA GAIN**

For Power used uncorrelated gain: The TX chains are uncorrelated and the antenna gain is unequal among the chains. The directional gain is:

<b>UAT 2 Antenna Gain (dBi)</b>	<b>LAT 3 Antenna Gain (dBi)</b>	<b>Uncorrelated Chains Directional Gain (dBi)</b>
-2.72	-7.38	-4.45

For PSD used correlated gain: The TX chains are correlated and the antenna gain is unequal among the chains. The directional gain is:

<b>UAT 2 Antenna Gain (dBi)</b>	<b>LAT 3 Antenna Gain (dBi)</b>	<b>Correlated Chains Directional Gain (dBi)</b>
-2.72	-7.38	-1.73

**RESULTS**

**Antenna Gain and Limits**

Channel	Frequency (MHz)	Directional Gain for Power (dBi)	Directional Gain for PSD (dBi)	Power Limit (dBm)	PSD Limit (dBm/1MHz)
Mid	5210	-4.45	-1.73	24.00	11.00

Duty Cycle CF (dB)	0.19	Included in Calculations of Corr'd PSD
--------------------	------	--

**Output Power Results**

Channel	Frequency (MHz)	UAT 2 Meas Power (dBm)	LAT 3 Meas Power (dBm)	Total Corr'd Power (dBm)	Power Limit (dBm)	Power Margin (dB)
Mid	5210	16.28	16.35	19.33	24.00	-4.67

**PSD Results**

Channel	Frequency (MHz)	UAT 2 Meas PSD (dBm/1MHz)	LAT 3 Meas PSD (dBm/1MHz)	Total Corr'd PSD (dBm/1MHz)	PSD Limit (dBm/1MHz)	PSD Margin (dB)
Mid	5210	3.213	2.610	6.12	11.00	-4.88

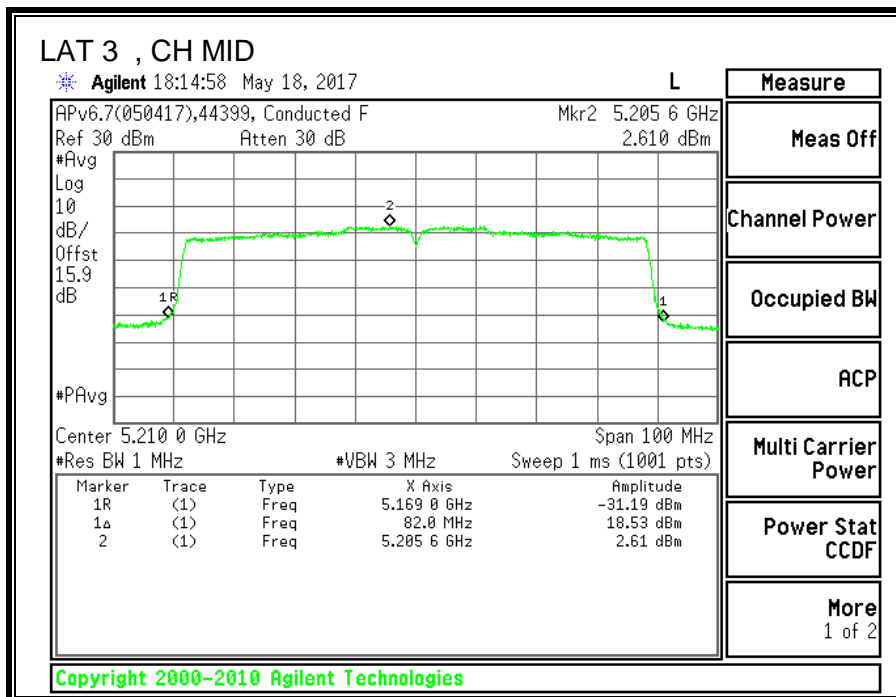
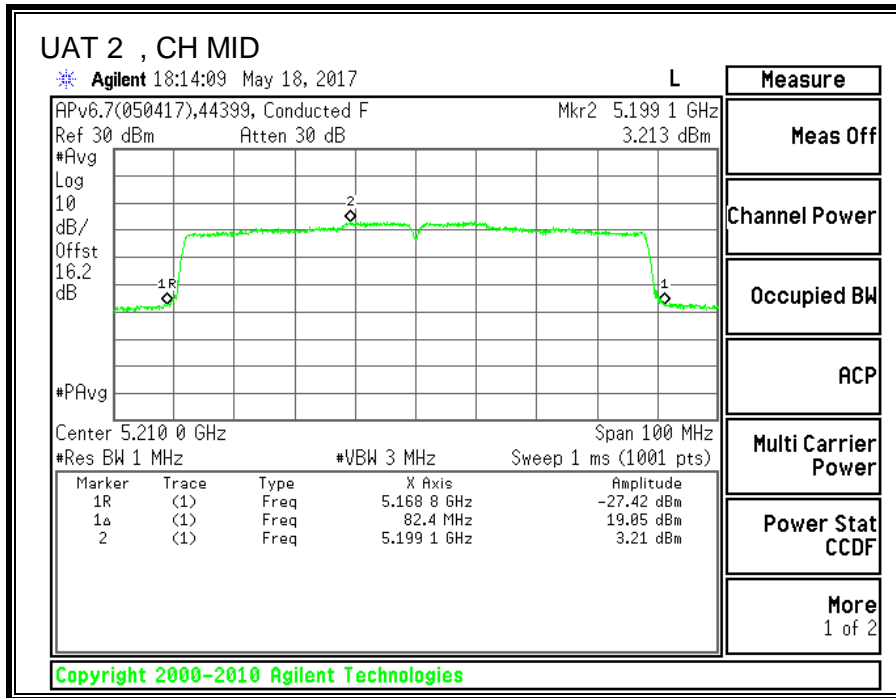



**8.10. 11n HT20 UAT 2 SISO MODE IN THE 5.3GHz BAND**

**8.10.1. 26 dB BANDWIDTH**

**LIMITS**

None; for reporting purposes only.

**RESULTS**

<b>Channel</b>	<b>Frequency</b>	<b>26 dB BW UAT 2 (MHz)</b>
Low	5260	22.05
Mid	5300	21.90
High	5320	21.85

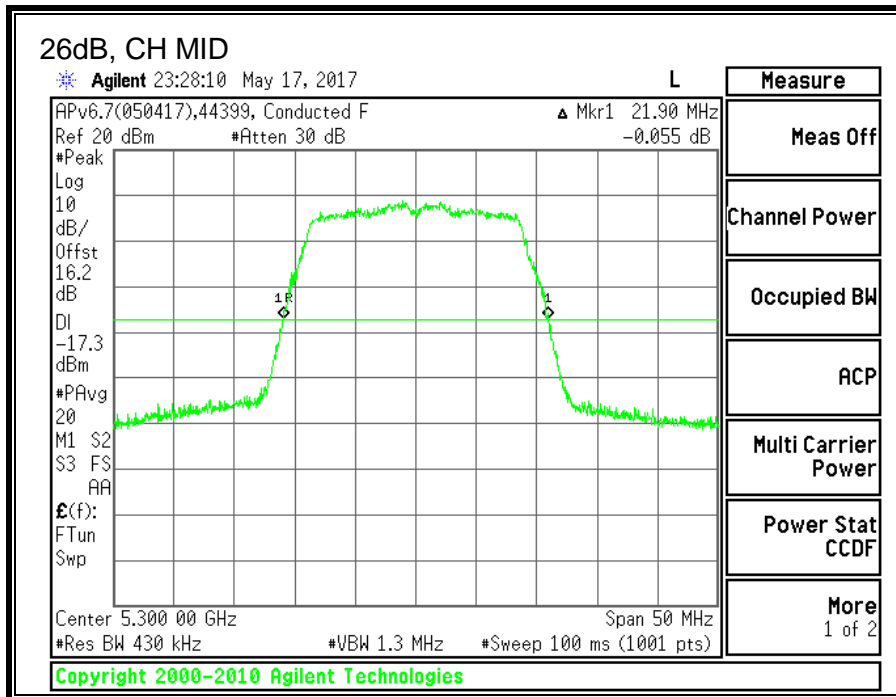
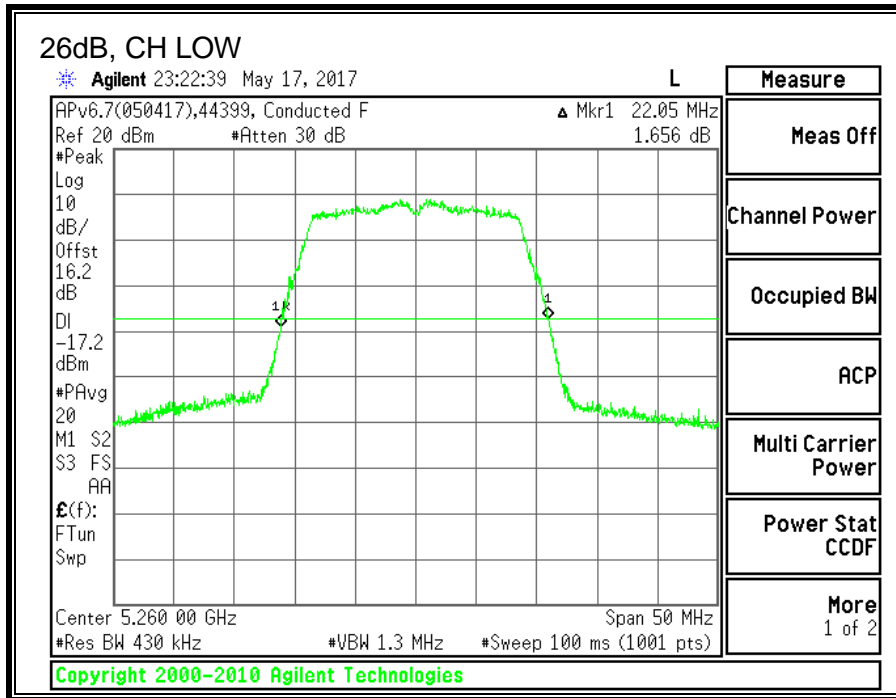

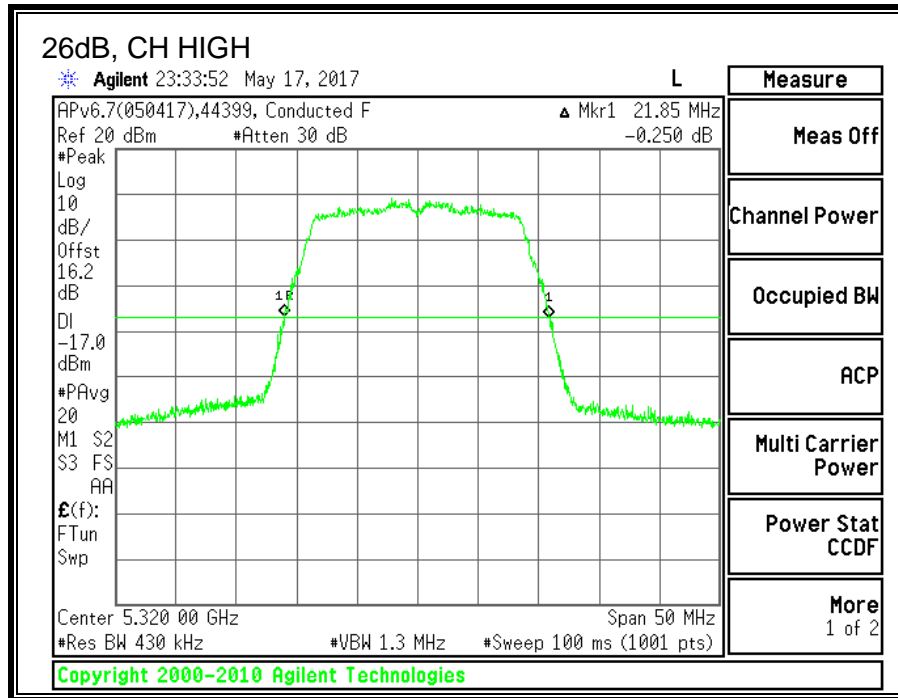

**8.10.2. 99% BANDWIDTH**

**LIMITS**

None; for reporting purposes only.

**RESULTS**

<b>Channel</b>	<b>Frequency</b>	<b>99% BW UAT 2 (MHz)</b>
Low	5260	17.6353
Mid	5300	17.6988
High	5320	17.7191

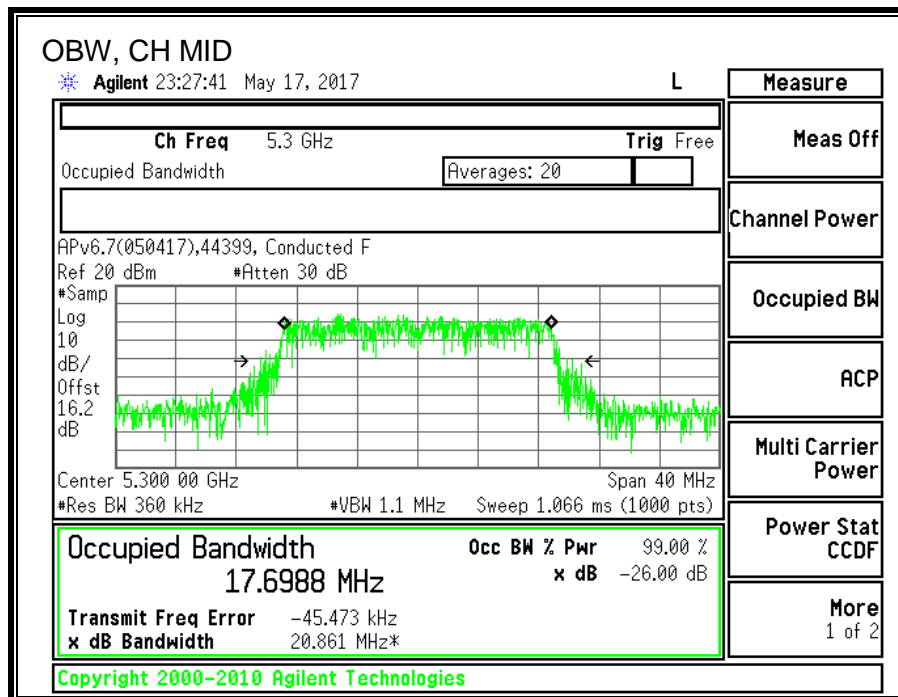
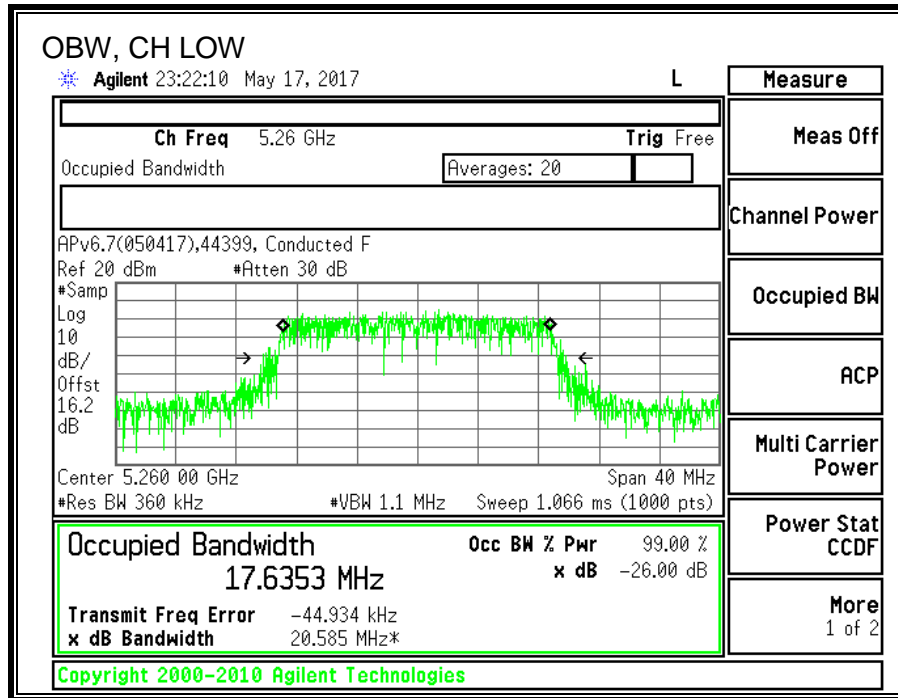

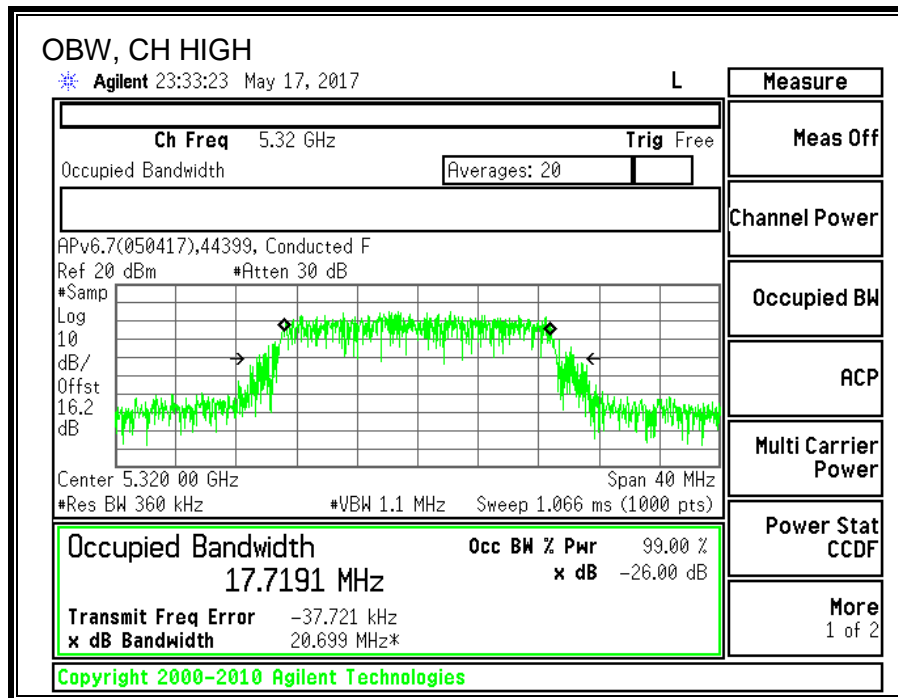

**8.10.3. AVERAGE POWER**

<b>ID:</b>	44366	<b>Date:</b>	7/25/17
------------	-------	--------------	---------

**LIMITS**

None; for reporting purposes only.

**TEST PROCEDURE**

Measurements perform using a wideband gated RF power meter.

**RESULTS**

<b>Channel</b>	<b>Frequency</b>	<b>Power UAT 2 (dBm)</b>
Low	5260	20.88
Mid	5300	20.78
High	5320	18.89

---

#### **8.10.4. OUTPUT POWER AND PPSD**

##### **LIMITS**

FCC §15.407 (a) (2)

For the band 5.25–5.35 GHz, the maximum conducted output power over the frequency band of operation shall not exceed the lesser of 250 mW or  $11 \text{ dBm} + 10 \log B$ , where B is the 26-dB emission bandwidth in MHz. In addition, the maximum power spectral density shall not exceed 11 dBm in any 1-MHz band. If transmitting antennas of directional gain greater than 6 dBi are used, both the maximum conducted output power and the peak power spectral density shall be reduced by the amount in dB that the directional gain of the antenna exceeds 6 dBi.

##### **TEST PROCEDURE**

Measurements perform using a wideband gated RF power meter provided that the gate parameters are adjusted such that the power is measured only when the EUT is transmitting at its maximum power control level. Since the measurement is made only during the ON time of the transmitter, no duty cycle correction factor is required.

##### **DIRECTIONAL ANTENNA GAIN**

There is only one transmitter output therefore the directional gain is equal to the antenna gain.



**RESULTS**

**Bandwidth, Antenna Gain, and Limits**

Channel	Frequency (MHz)	Min 26 dB BW (MHz)	Min 99% BW (MHz)	Directional Gain (dBi)	Power Limit (dBm)	PSD Limit (dBm/1MHz)
Low	5260	22.050	17.635	-3.11	23.46	11.00
Mid	5300	21.900	17.699	-3.11	23.48	11.00
High	5320	21.850	17.719	-3.11	23.48	11.00

<b>Duty Cycle CF (dB)</b>	0.00	Included in Calculations of Corr'd PSD
---------------------------	------	--

**Output Power Results**

Channel	Frequency (MHz)	UAT 2 Meas Power (dBm)	Total Corr'd Power (dBm)	Power Limit (dBm)	Power Margin (dB)
Low	5260	20.88	20.88	23.46	-2.58
Mid	5300	20.78	20.78	23.48	-2.70
High	5320	18.89	18.89	23.48	-4.59

**PSD Results**

Channel	Frequency (MHz)	UAT 2 Meas PSD (dBm/1MHz)	Total Corr'd PSD (dBm/1MHz)	PSD Limit (dBm/1MHz)	PSD Margin (dB)
Low	5260	9.976	9.98	11.00	-1.02
Mid	5300	9.878	9.88	11.00	-1.12
High	5320	9.856	9.86	11.00	-1.14

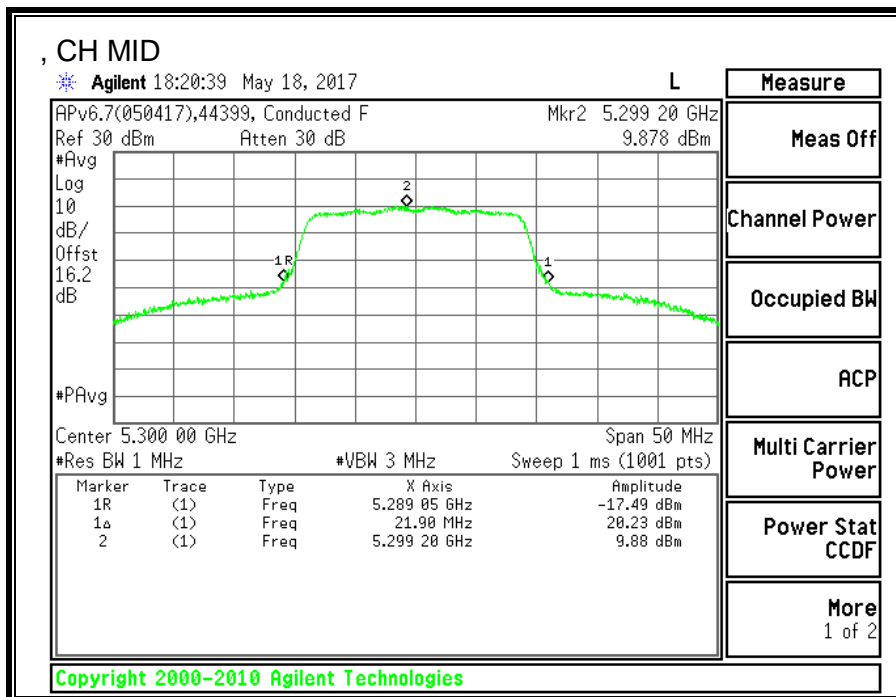
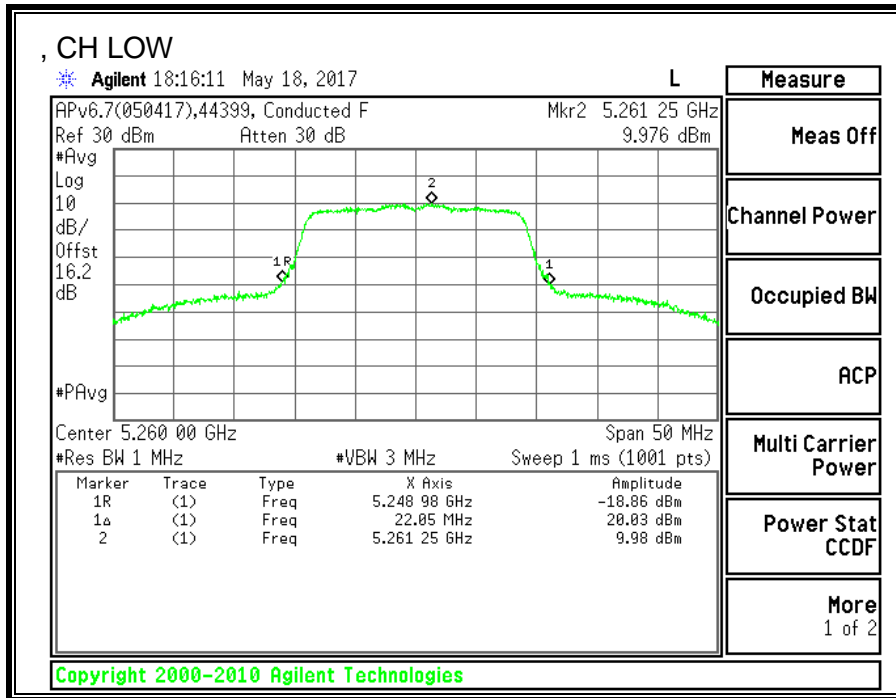

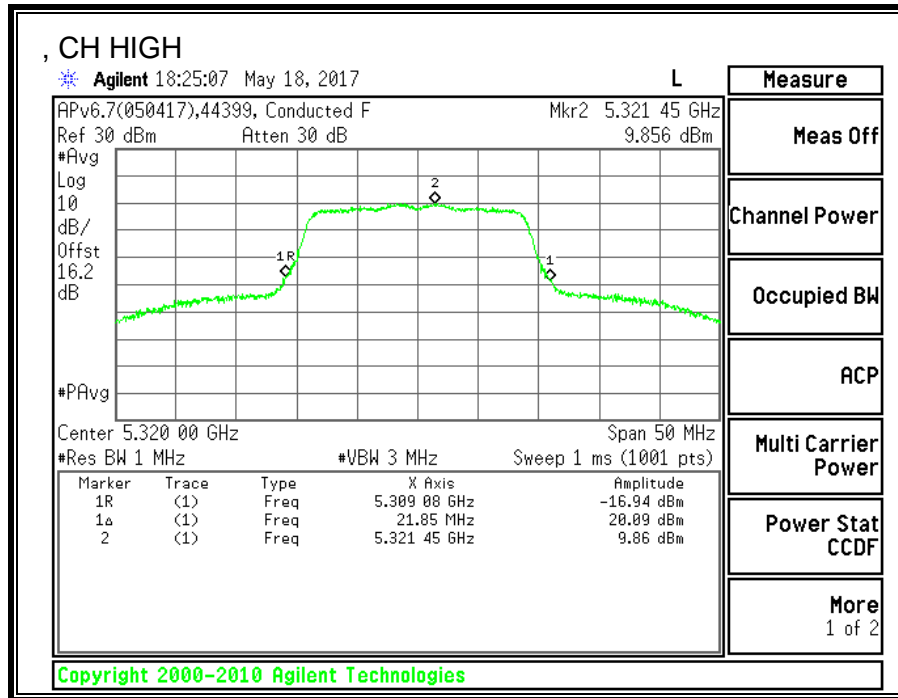

**8.11. 11n HT20 LAT 3 SISO MODE IN THE 5.3GHz BAND**

**8.11.1. 26 dB BANDWIDTH**

**LIMITS**

None; for reporting purposes only.

**RESULTS**

<b>Channel</b>	<b>Frequency</b>	<b>26 dB BW LAT 3 (MHz)</b>
Low	5260	22.10
Mid	5300	22.05
High	5320	21.95

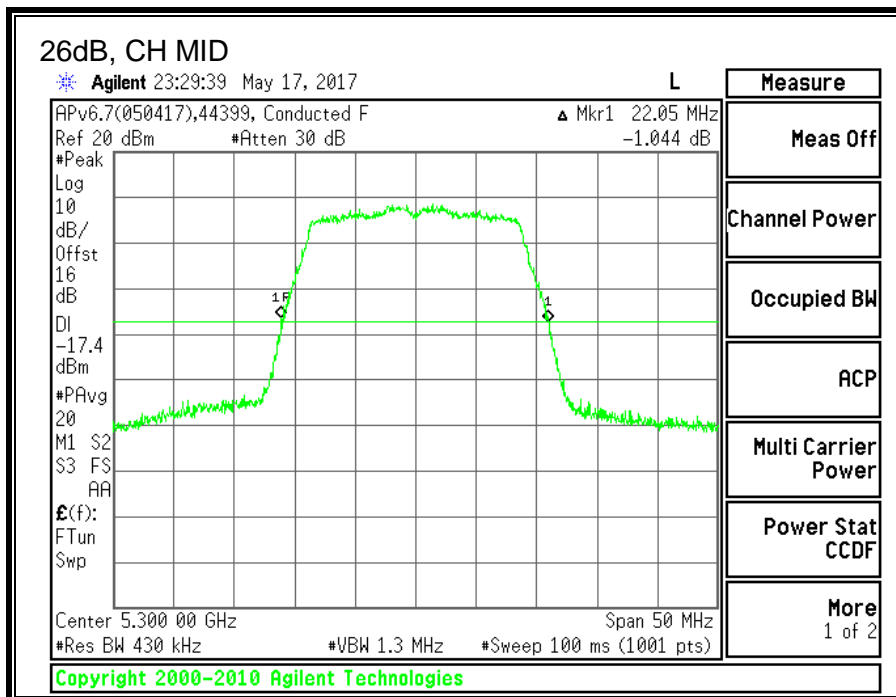
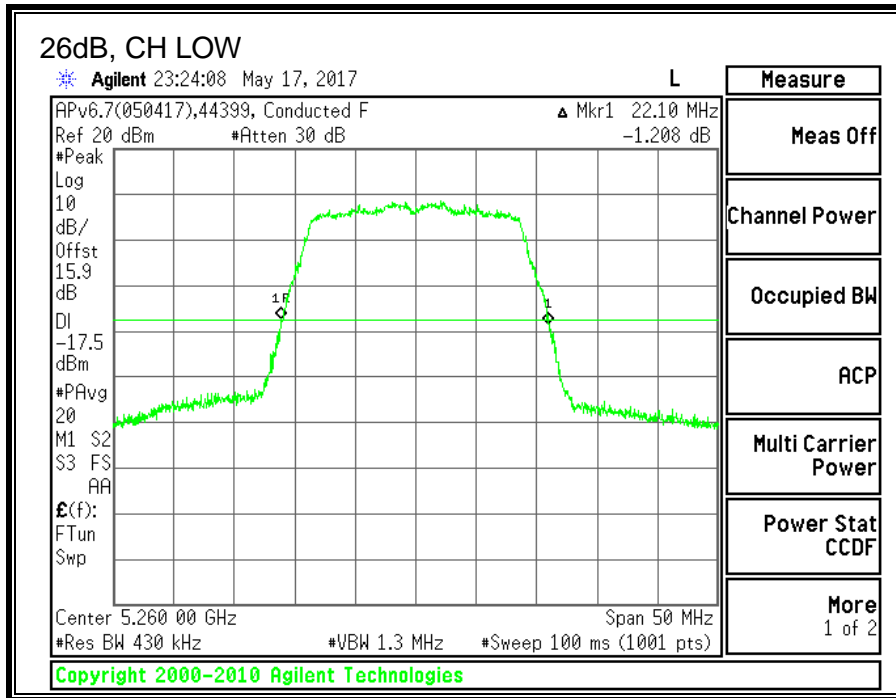

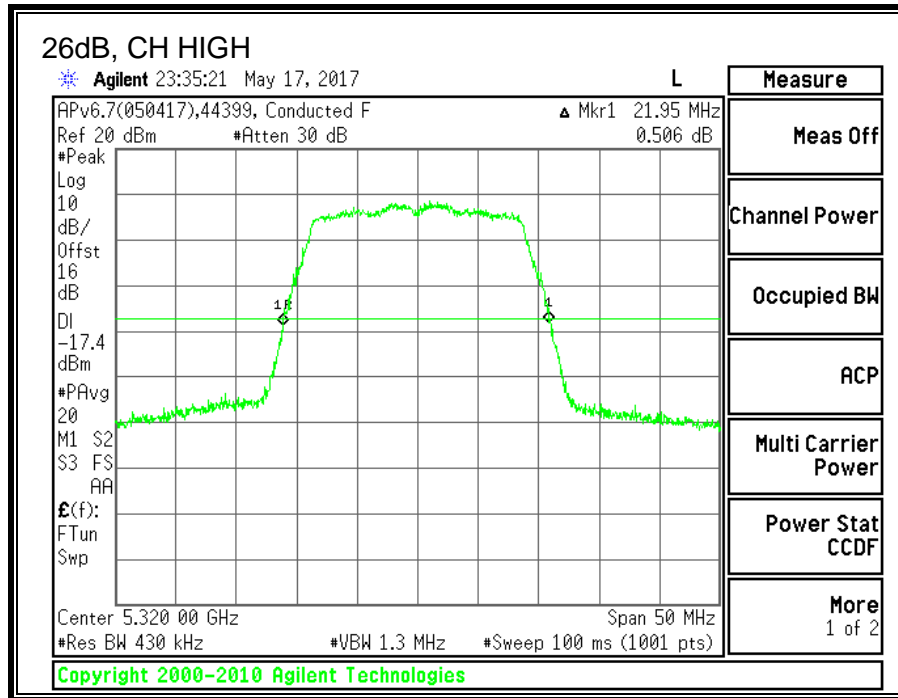

**8.11.2. 99% BANDWIDTH**

**LIMITS**

None; for reporting purposes only.

**RESULTS**

<b>Channel</b>	<b>Frequency</b>	<b>99% BW LAT 3 (MHz)</b>
Low	5260	17.7240
Mid	5300	17.7013
High	5320	17.7123

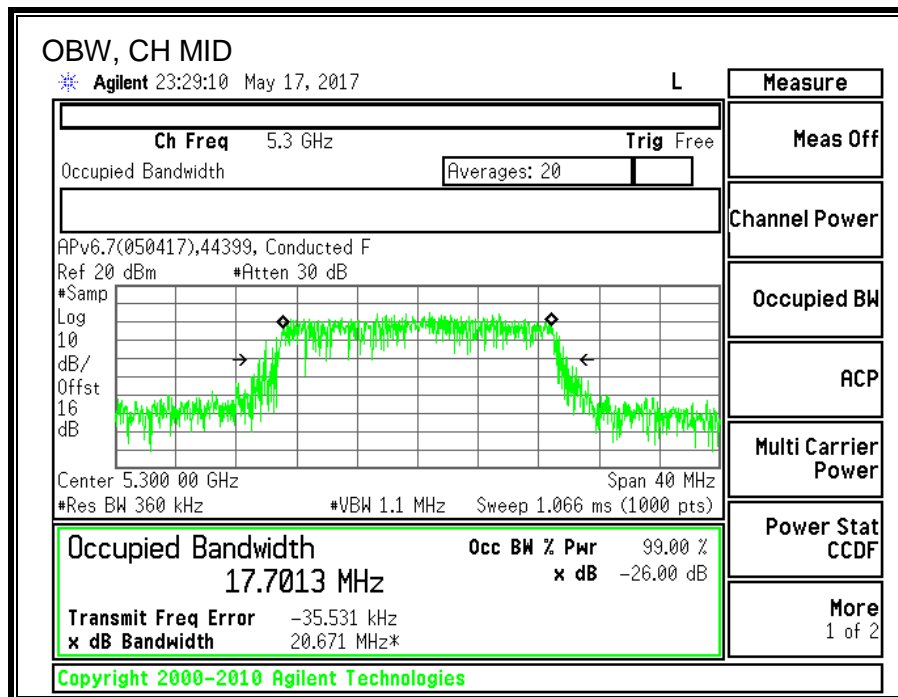
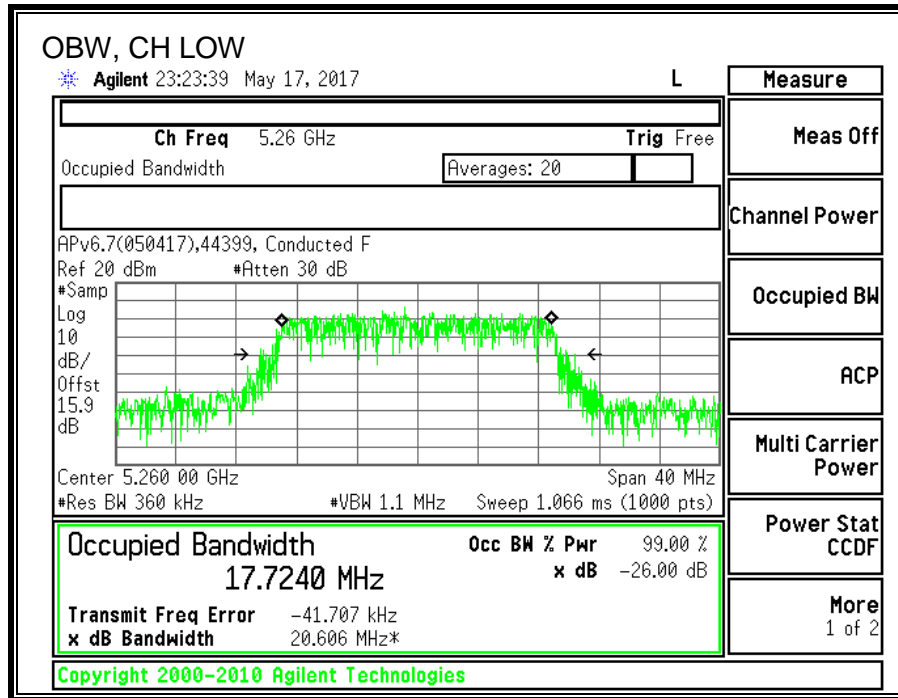



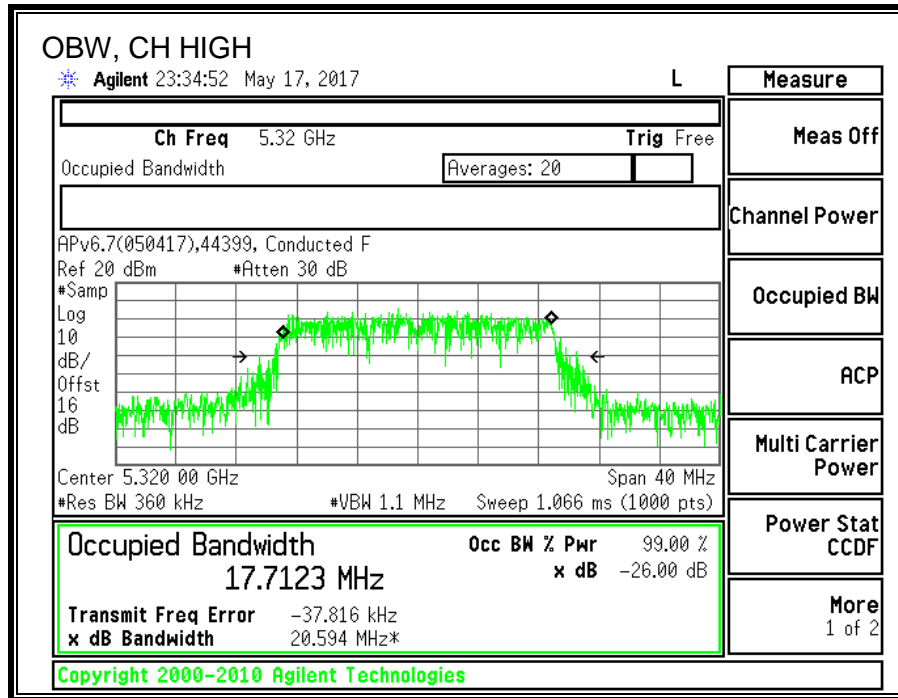

**8.11.3. AVERAGE POWER**

<b>ID:</b>	44366	<b>Date:</b>	7/25/17
------------	-------	--------------	---------

**LIMITS**

None; for reporting purposes only.

**TEST PROCEDURE**

Measurements perform using a wideband gated RF power meter.

**RESULTS**

<b>Channel</b>	<b>Frequency</b>	<b>Power LAT 3 (dBm)</b>
Low	5260	20.83
Mid	5300	20.77
High	5320	18.83

---

#### **8.11.4. OUTPUT POWER AND PPSD**

##### **LIMITS**

FCC §15.407 (a) (2)

For the band 5.25–5.35 GHz, the maximum conducted output power over the frequency band of operation shall not exceed the lesser of 250 mW or  $11 \text{ dBm} + 10 \log B$ , where B is the 26–dB emission bandwidth in MHz. In addition, the maximum power spectral density shall not exceed 11 dBm in any 1–MHz band. If transmitting antennas of directional gain greater than 6 dBi are used, both the maximum conducted output power and the peak power spectral density shall be reduced by the amount in dB that the directional gain of the antenna exceeds 6 dBi.

##### **TEST PROCEDURE**

Measurements perform using a wideband gated RF power meter provided that the gate parameters are adjusted such that the power is measured only when the EUT is transmitting at its maximum power control level. Since the measurement is made only during the ON time of the transmitter, no duty cycle correction factor is required.

##### **DIRECTIONAL ANTENNA GAIN**

There is only one transmitter output therefore the directional gain is equal to the antenna gain.

**RESULTS**

**Bandwidth, Antenna Gain, and Limits**

Channel	Frequency (MHz)	Min 26 dB BW (MHz)	Min 99% BW (MHz)	Directional Gain (dBi)	Power Limit (dBm)	PSD Limit (dBm/1MHz)
Low	5260	22.100	17.724	-6.98	23.49	11.00
Mid	5300	22.050	17.701	-6.98	23.48	11.00
High	5320	21.950	17.712	-6.98	23.48	11.00

<b>Duty Cycle CF (dB)</b>	0.00	<b>Included in Calculations of Corr'd PSD</b>
---------------------------	------	---

**Output Power Results**

Channel	Frequency (MHz)	LAT 3 Meas Power (dBm)	Total Corr'd Power (dBm)	Power Limit (dBm)	Power Margin (dB)
Low	5260	20.83	20.83	23.49	-2.66
Mid	5300	20.77	20.77	23.48	-2.71
High	5320	18.83	18.83	23.48	-4.65

**PSD Results**

Channel	Frequency (MHz)	LAT 3 Meas PSD (dBm/1MHz)	Total Corr'd PSD (dBm/1MHz)	PSD Limit (dBm/1MHz)	PSD Margin (dB)
Low	5260	10.058	10.06	11.00	-0.94
Mid	5300	9.925	9.93	11.00	-1.08
High	5320	9.760	9.76	11.00	-1.24

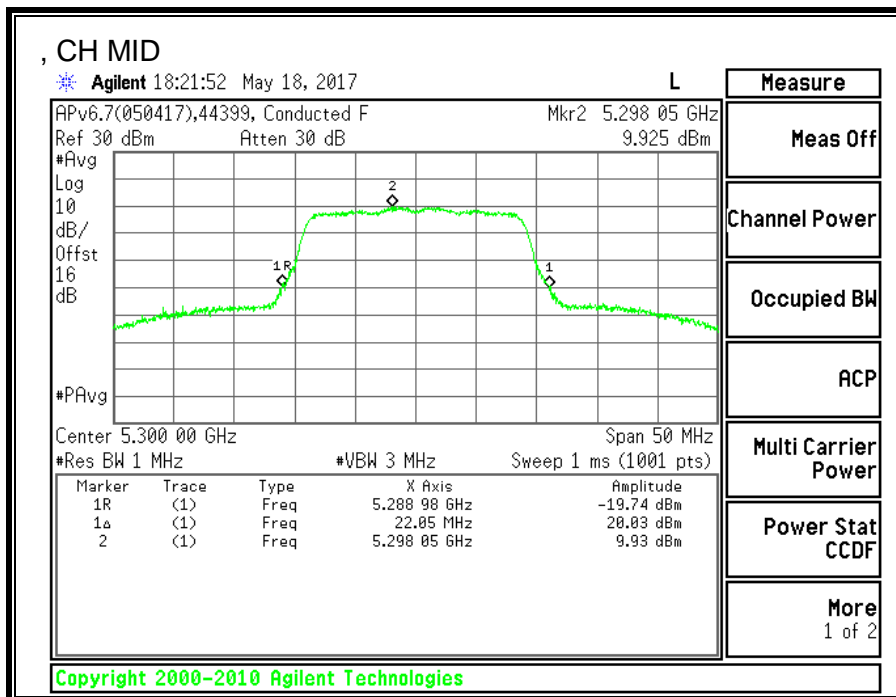
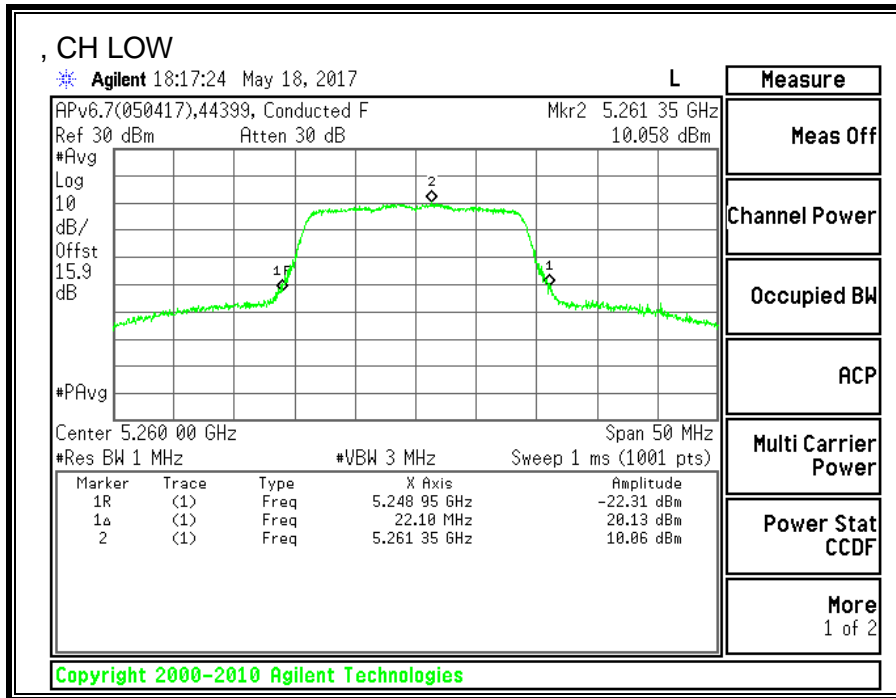

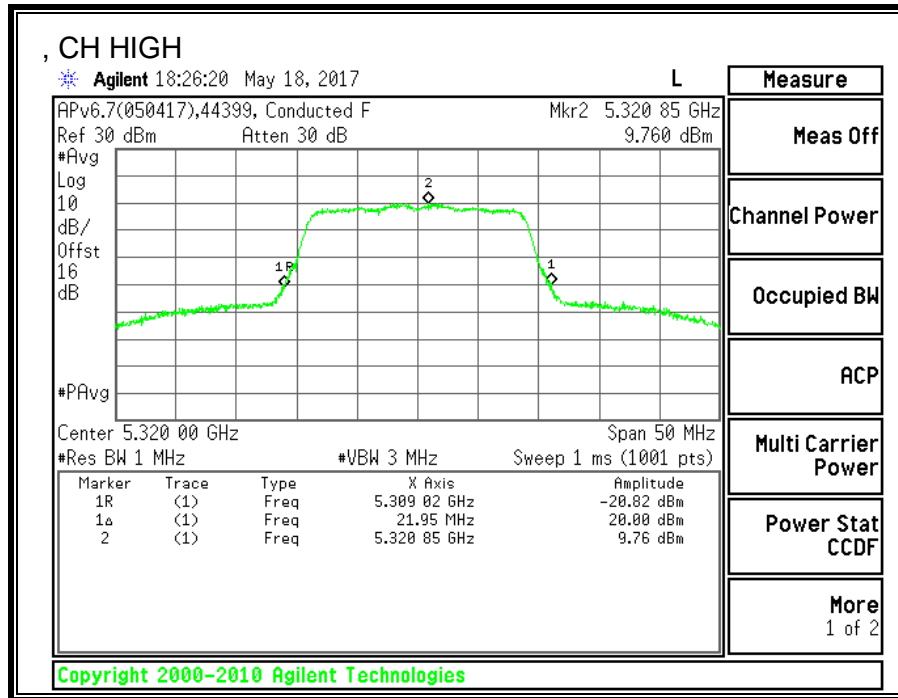

**8.12. 11n HT20 2TX CDD MIMO MODE IN THE 5.3GHz BAND**

**8.12.1. 26 dB BANDWIDTH**

**LIMITS**

None; for reporting purposes only.

**RESULTS**

<b>Channel</b>	<b>Frequency</b>	<b>26 dB BW UAT 2 (MHz)</b>	<b>26 dB BW LAT 3 (MHz)</b>
Low	5260	21.90	21.65
Mid	5300	21.80	21.50
High	5320	21.95	21.65

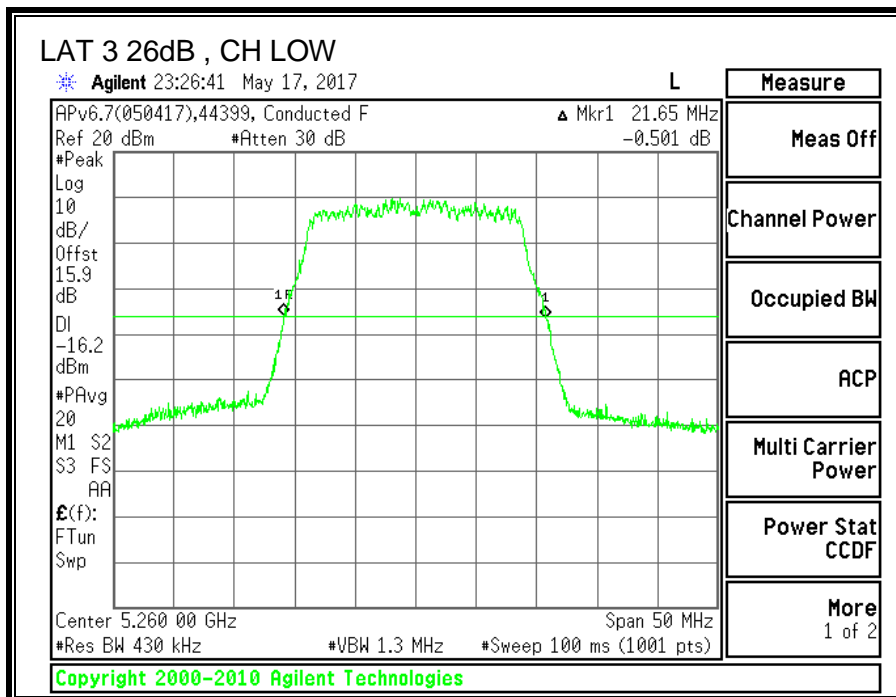
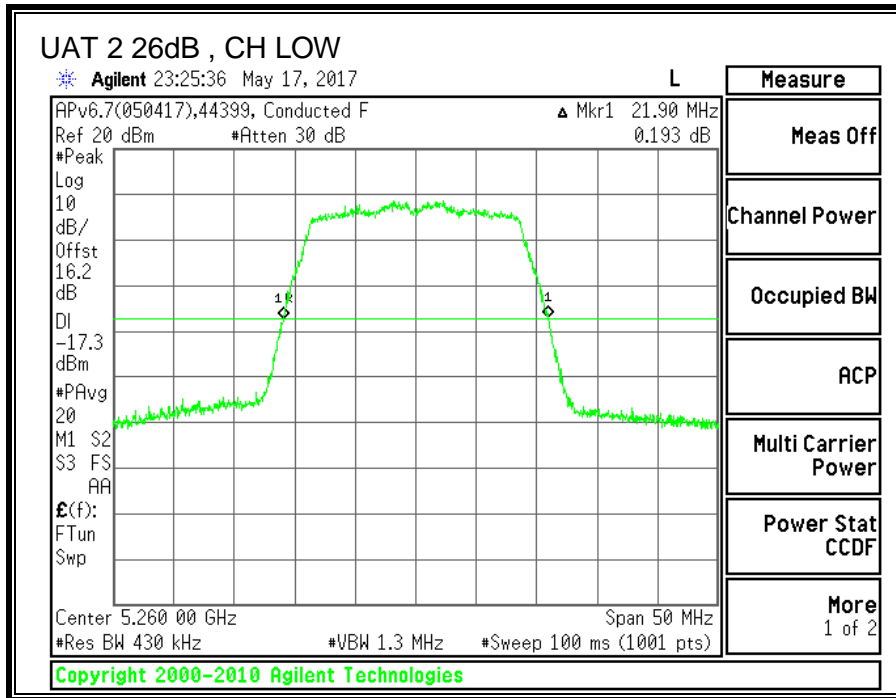



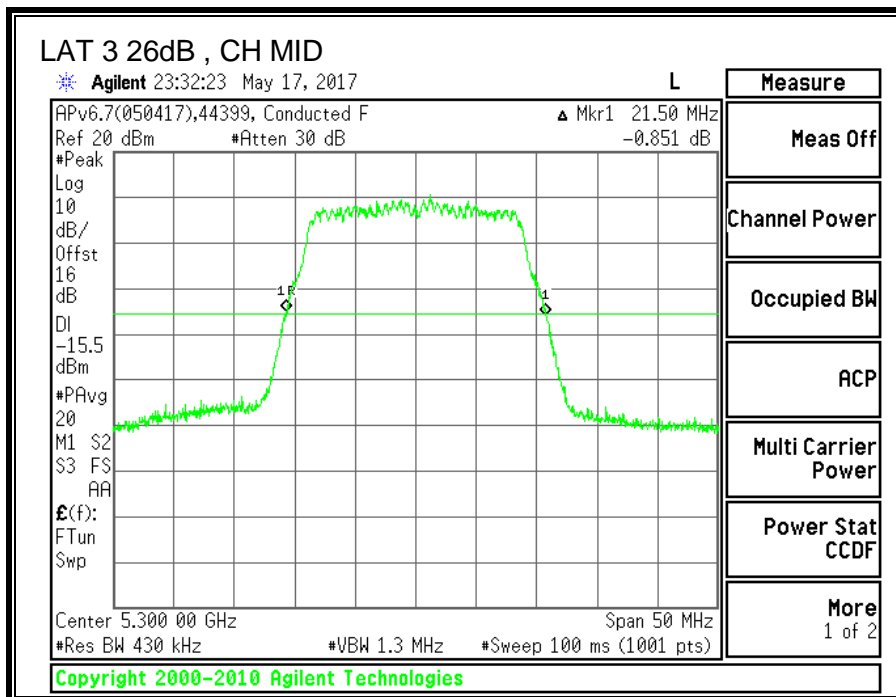
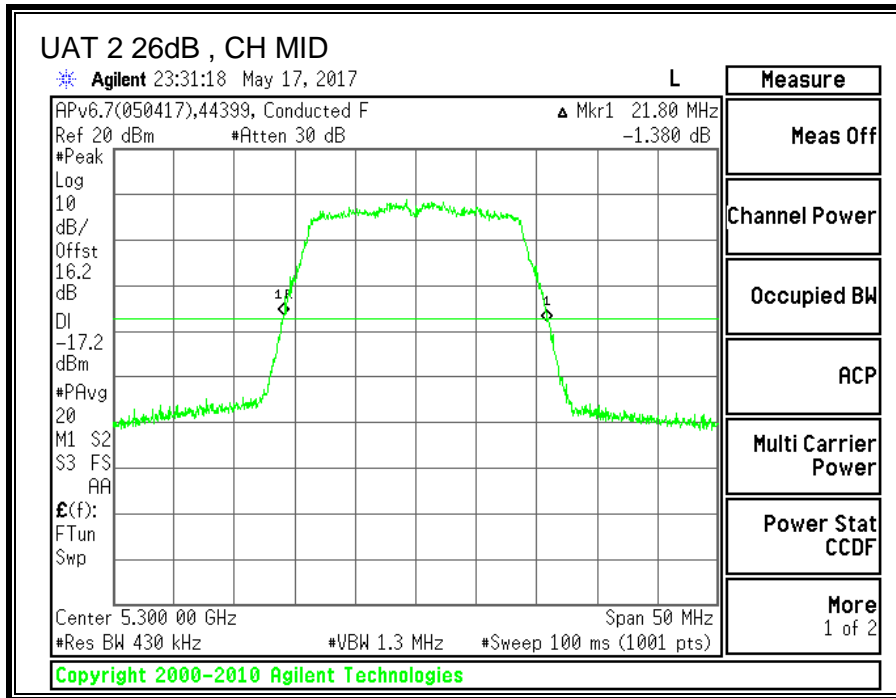

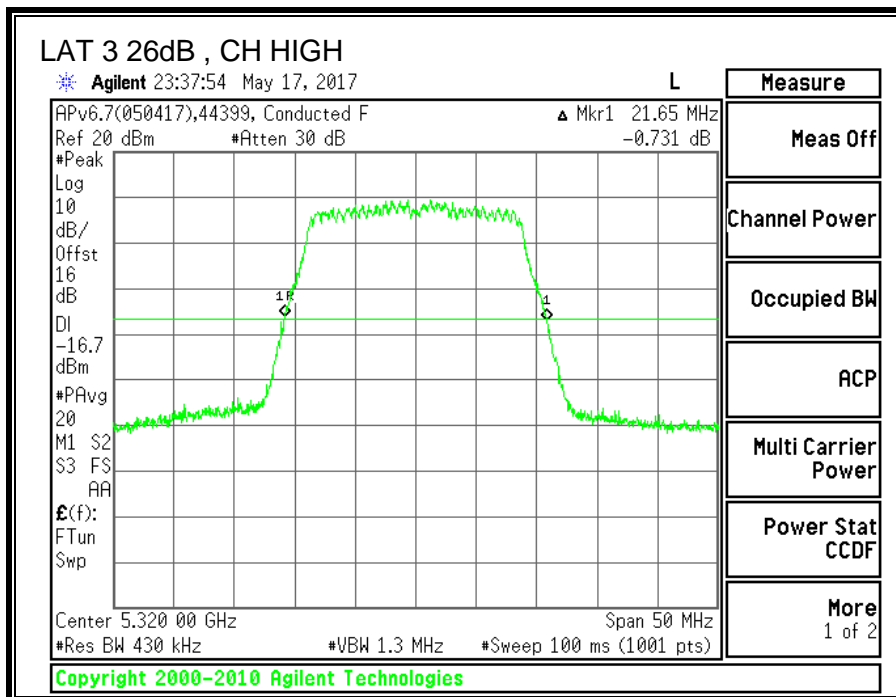
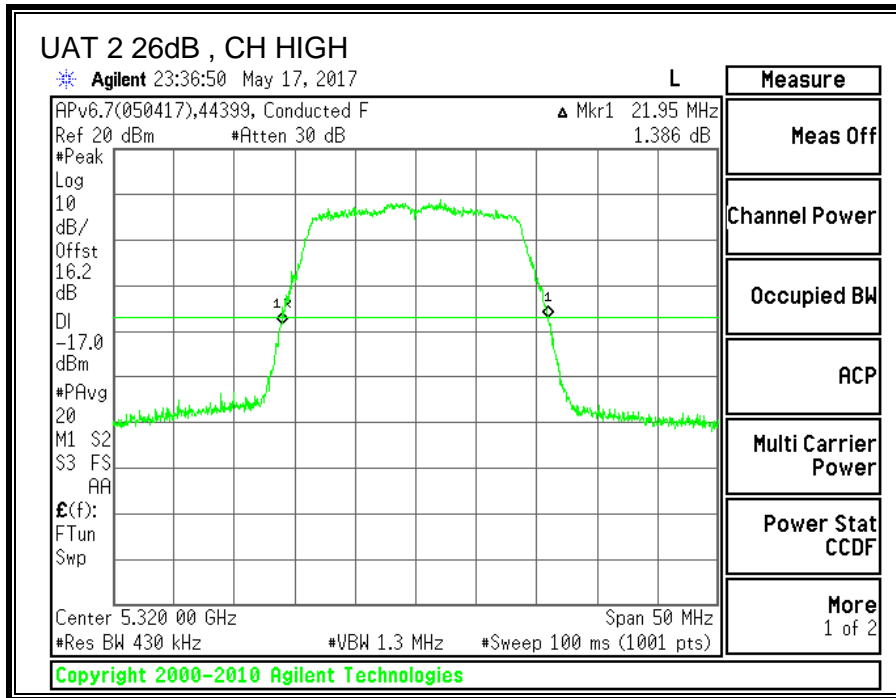

**8.12.2. 99% BANDWIDTH**

**LIMITS**

None; for reporting purposes only.

**RESULTS**

<b>Channel</b>	<b>Frequency</b>	<b>99% BW UAT 2 (MHz)</b>	<b>99% BW LAT 3 (MHz)</b>
Low	5260	17.6426	17.7091
Mid	5300	17.7031	17.6743
High	5320	17.6553	17.7100

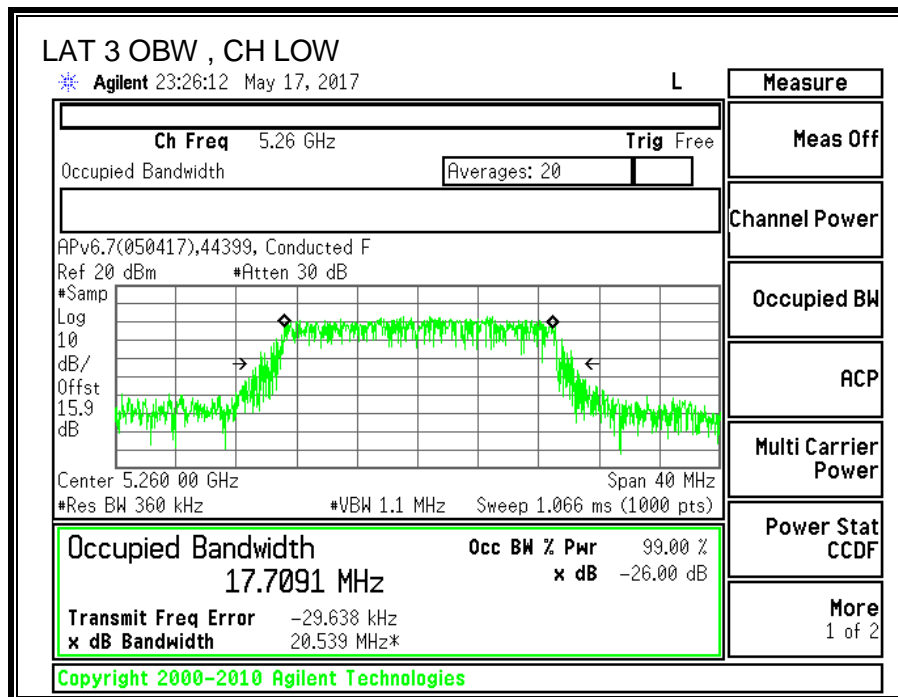
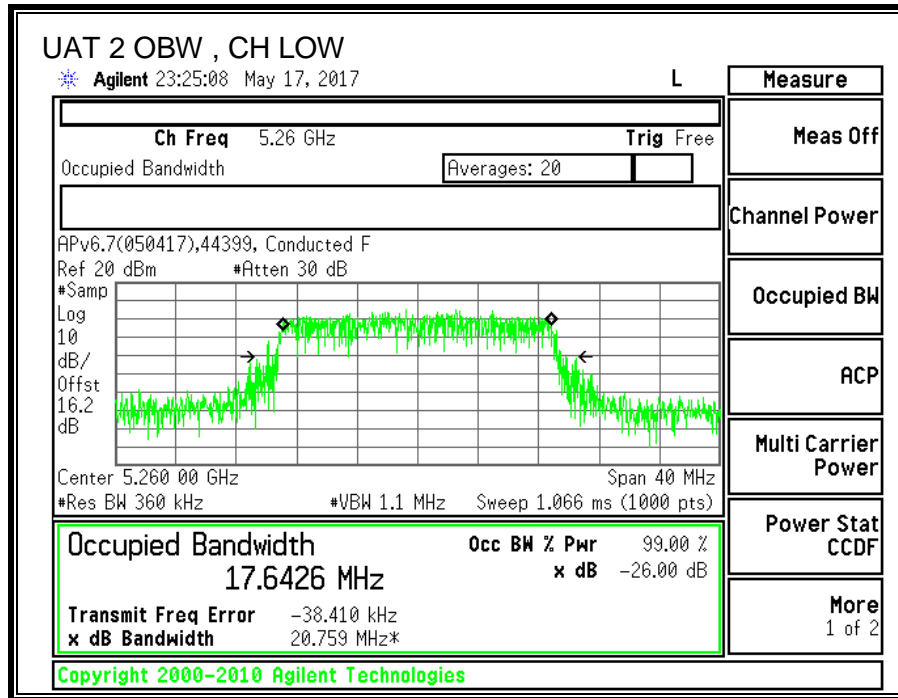

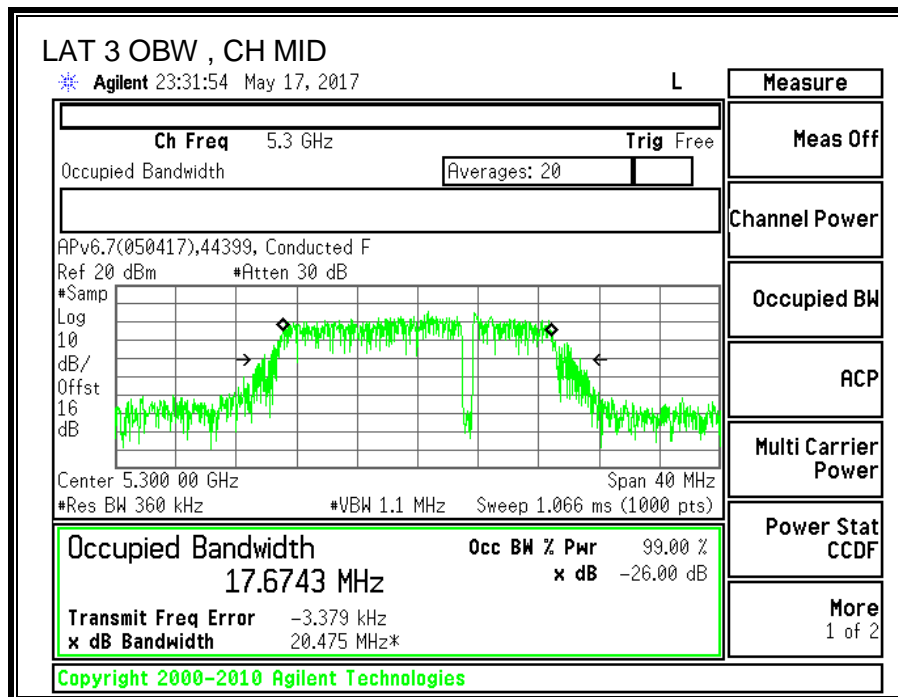
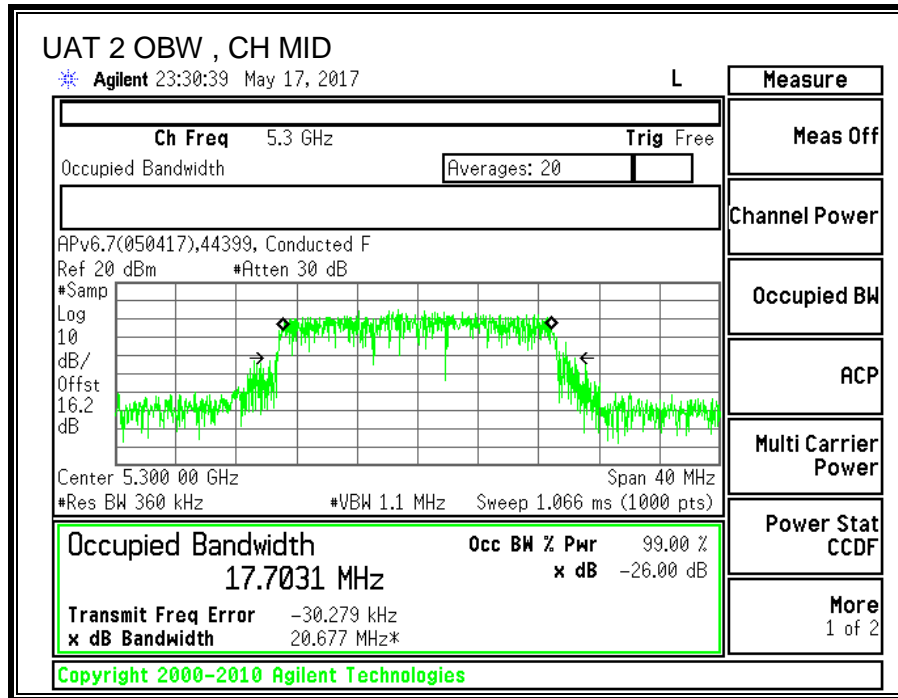

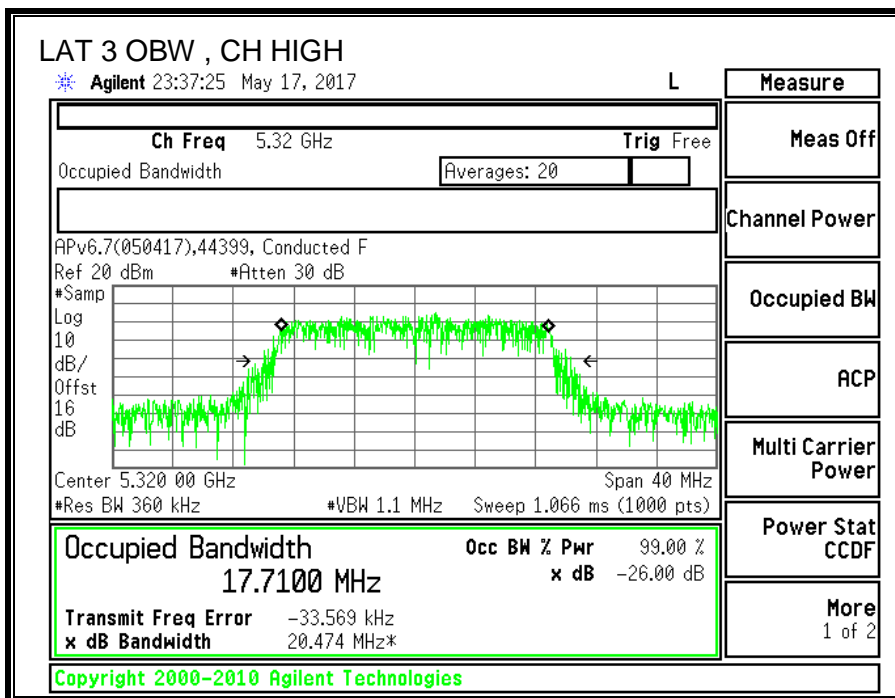
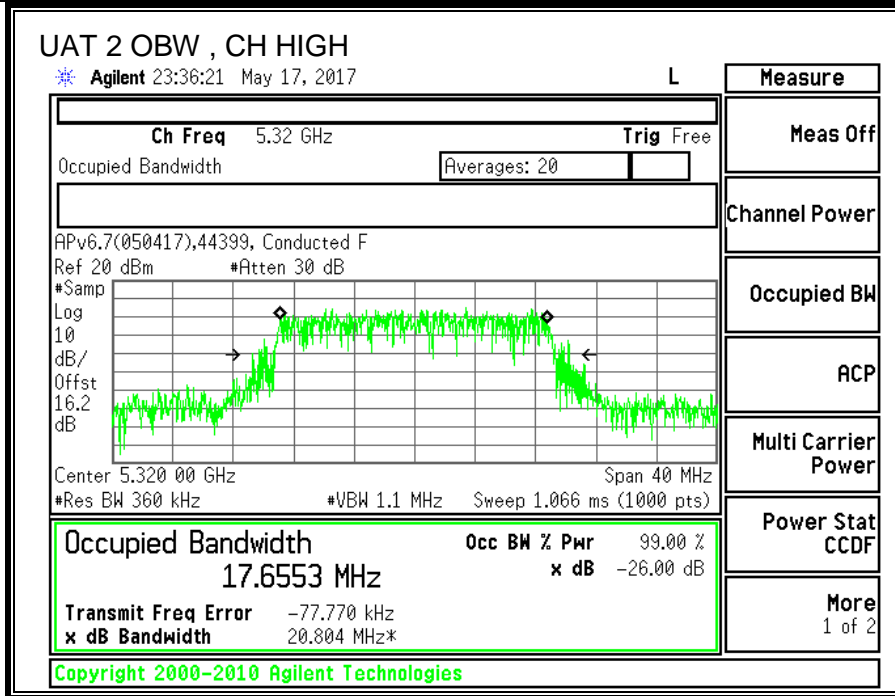

**8.12.3. AVERAGE POWER**

<b>ID:</b>	44366	<b>Date:</b>	7/25/17
------------	-------	--------------	---------

**LIMITS**

None; for reporting purposes only.

**TEST PROCEDURE**

Measurements perform using a wideband gated RF power meter.

**RESULTS**

**Average Power Results**

<b>Channel</b>	<b>Frequency (MHz)</b>	<b>UAT 2 Power (dBm)</b>	<b>LAT 3 Power (dBm)</b>	<b>Total Power (dBm)</b>
Low	5260	17.81	17.97	20.90
Mid	5300	17.80	17.88	20.85
High	5320	17.84	17.95	20.91

**8.12.4. OUTPUT POWER AND PPSD**

**LIMITS**

FCC §15.407 (a) (2)

For the band 5.25–5.35 GHz, the maximum conducted output power over the frequency band of operation shall not exceed the lesser of 250 mW or 11 dBm + 10 log B, where B is the 26–dB emission bandwidth in MHz. In addition, the maximum power spectral density shall not exceed 11 dBm in any 1–MHz band. If transmitting antennas of directional gain greater than 6 dBi are used, both the maximum conducted output power and the peak power spectral density shall be reduced by the amount in dB that the directional gain of the antenna exceeds 6 dBi.

**TEST PROCEDURE**

Measurements perform using a wideband gated RF power meter provided that the gate parameters are adjusted such that the power is measured only when the EUT is transmitting at its maximum power control level. Since the measurement is made only during the ON time of the transmitter, no duty cycle correction factor is required.

**DIRECTIONAL ANTENNA GAIN**

For Power used uncorrelated gain: The TX chains are uncorrelated and the antenna gain is unequal among the chains. The directional gain is:

<b>UAT 2 Antenna Gain (dBi)</b>	<b>LAT 3 Antenna Gain (dBi)</b>	<b>Uncorrelated Chains Directional Gain (dBi)</b>
-3.11	-6.98	-4.63

For PSD used correlated gain: The TX chains are correlated and the antenna gain is unequal among the chains. The directional gain is:

<b>UAT 2 Antenna Gain (dBi)</b>	<b>LAT 3 Antenna Gain (dBi)</b>	<b>Correlated Chains Directional Gain (dBi)</b>
-3.11	-6.98	-1.82



**RESULTS**

**Bandwidth, Antenna Gain and Limits**

Channel	Frequency (MHz)	Min 26 dB BW (MHz)	Min 99% BW (MHz)	Directional Gain for Power (dBi)	Directional Gain for PSD (dBi)	Power Limit (dBm)	PSD Limit (dBm/1MHz)
Low	5260	21.65	17.643	-4.63	-1.82	23.47	11.00
Mid	5300	21.50	17.674	-4.63	-1.82	23.47	11.00
High	5320	21.65	17.6553	-4.63	-1.82	23.47	11.00

<b>Duty Cycle CF (dB)</b>	0.00	<b>Included in Calculations of Corr'd PSD</b>
---------------------------	------	---

**Output Power Results**

Channel	Frequency (MHz)	UAT 2 Meas Power (dBm)	LAT 3 Meas Power (dBm)	Total Corr'd Power (dBm)	Power Limit (dBm)	Power Margin (dB)
Low	5260	17.81	17.97	20.90	23.47	-2.56
Mid	5300	17.80	17.88	20.85	23.47	-2.62
High	5320	17.84	17.95	20.91	23.47	-2.56

**PSD Results**

Channel	Frequency (MHz)	UAT 2 Meas PSD (dBm/1MHz)	LAT 3 Meas PSD (dBm/1MHz)	Total Corr'd PSD (dBm/1MHz)	PSD Limit (dBm/1MHz)	PSD Margin (dB)
Low	5260	6.976	5.981	9.52	11.00	-1.48
Mid	5300	6.573	6.458	9.53	11.00	-1.47
High	5320	6.923	6.863	9.90	11.00	-1.10

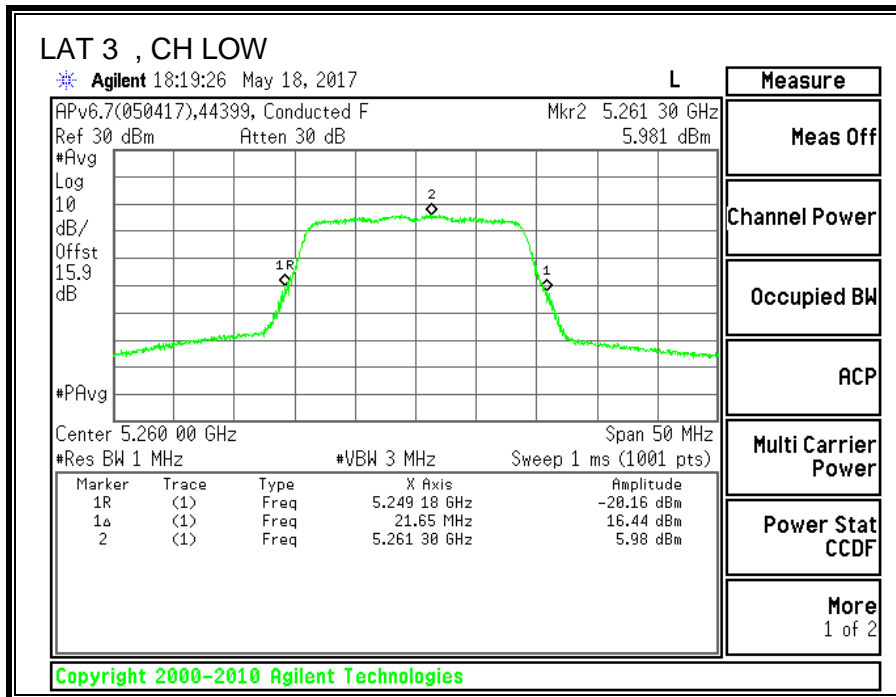
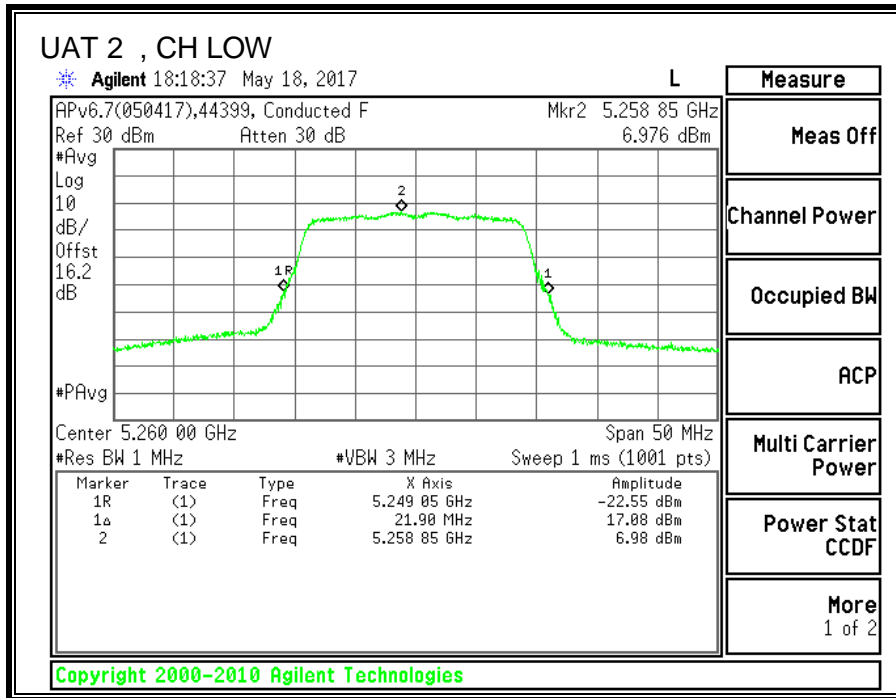

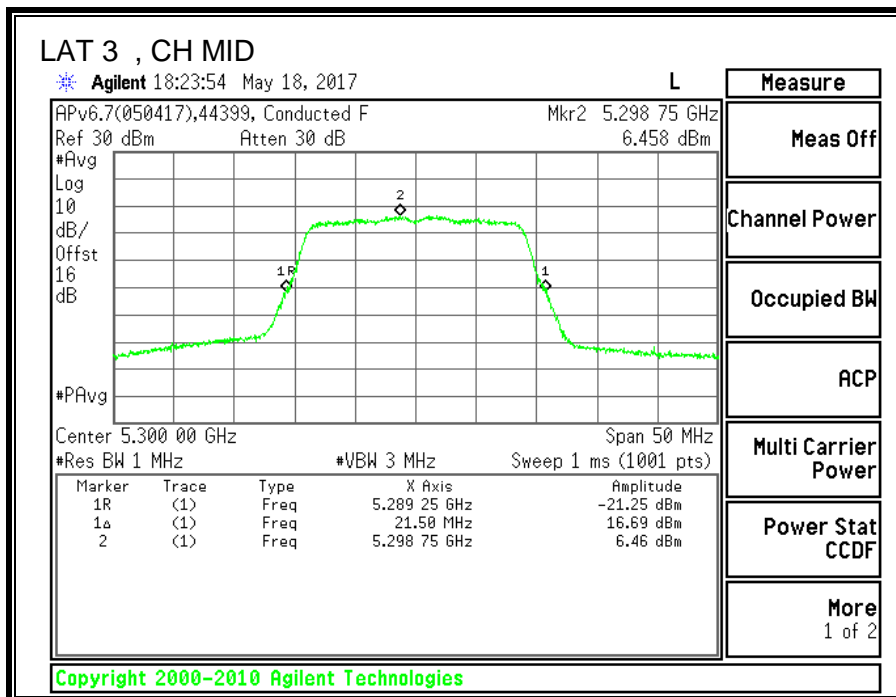
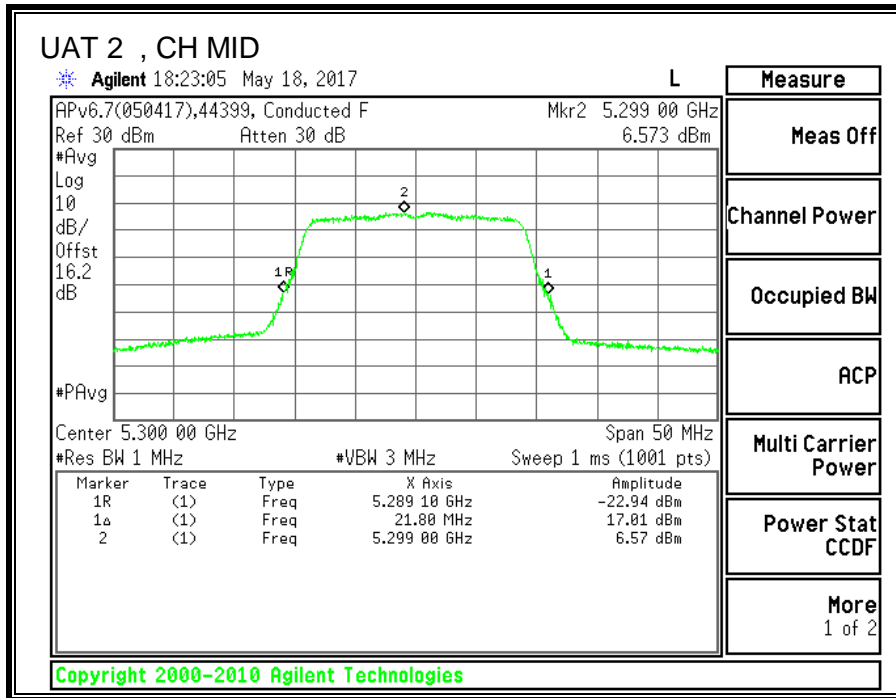

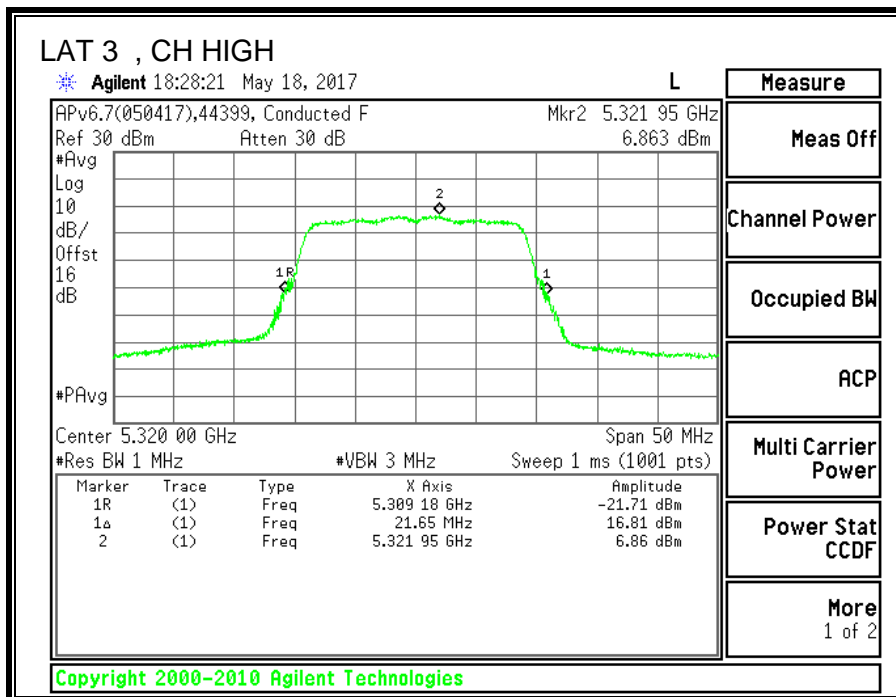
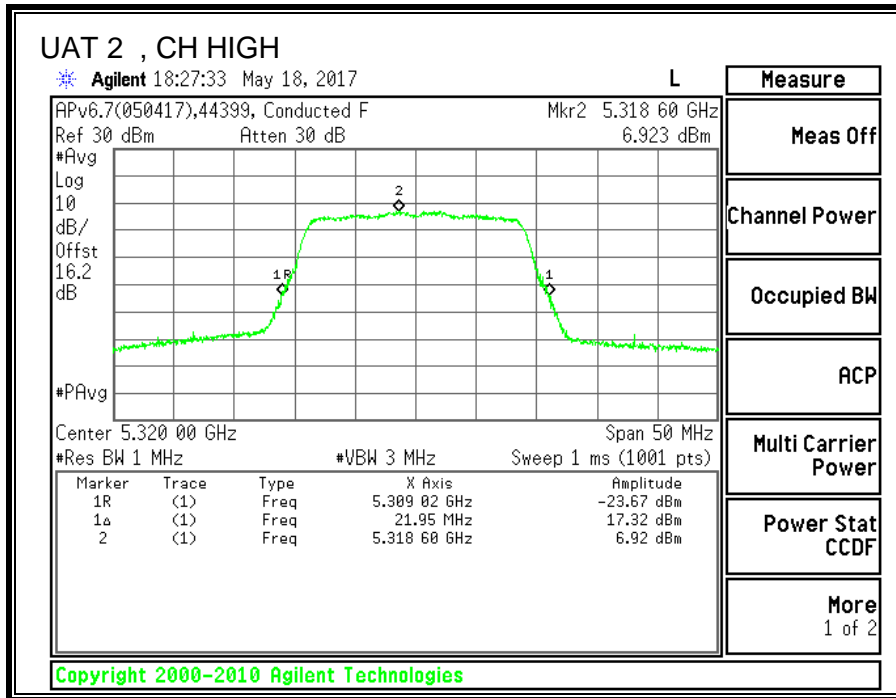

**8.13. 11n HT40 UAT 2 SISO MODE IN THE 5.3GHz BAND**

**8.13.1. 26 dB BANDWIDTH**

**LIMITS**

None; for reporting purposes only.

**RESULTS**

<b>Channel</b>	<b>Frequency</b>	<b>26 dB BW UAT 2 (MHz)</b>
Low	5270	40.5
High	5310	40.6

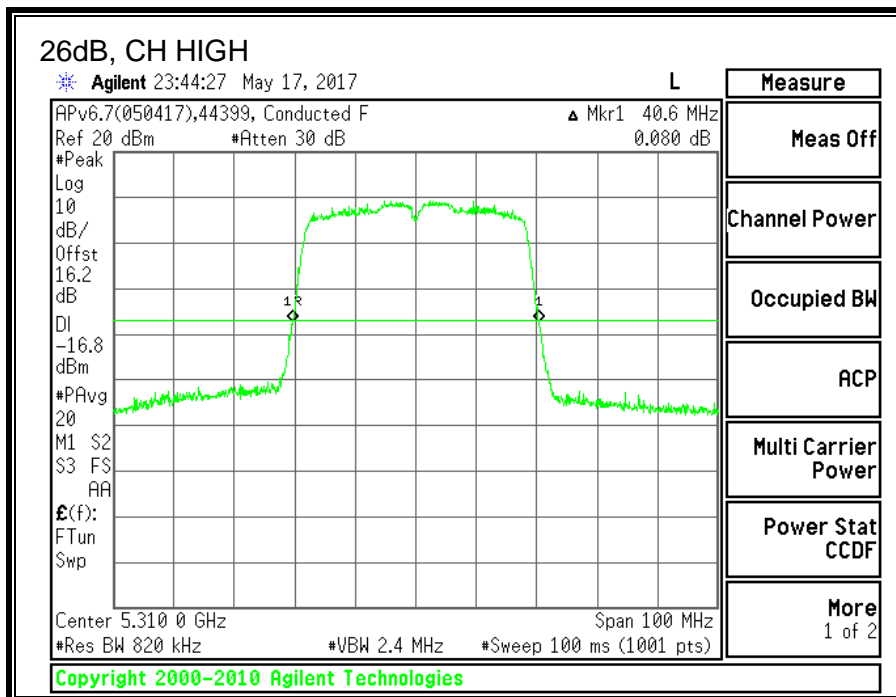
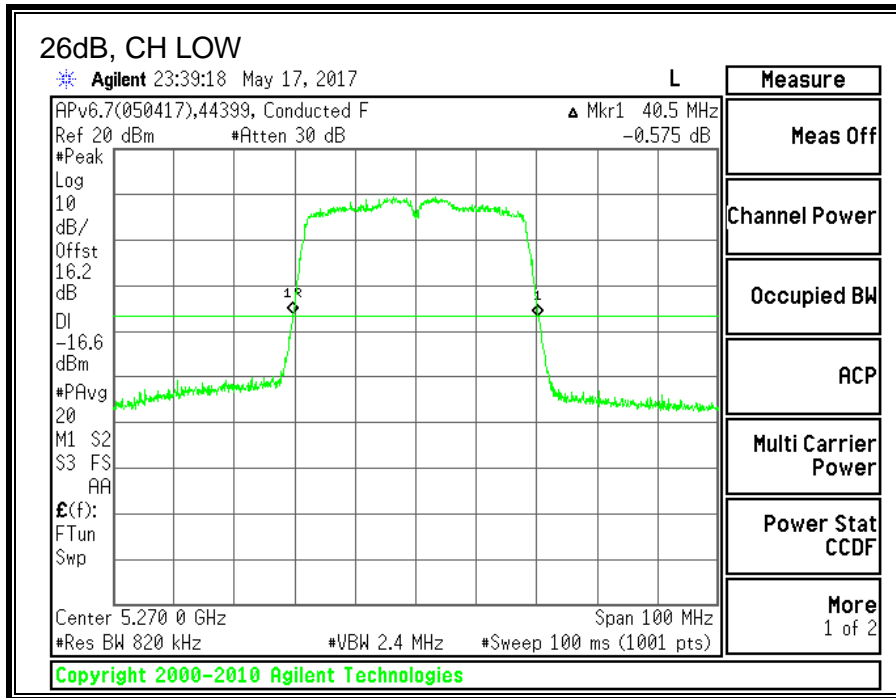

**8.13.2. 99% BANDWIDTH**

**LIMITS**

None; for reporting purposes only.

**RESULTS**

<b>Channel</b>	<b>Frequency</b>	<b>99% BW UAT 2 (MHz)</b>
Low	5270	36.0842
High	5310	36.1662

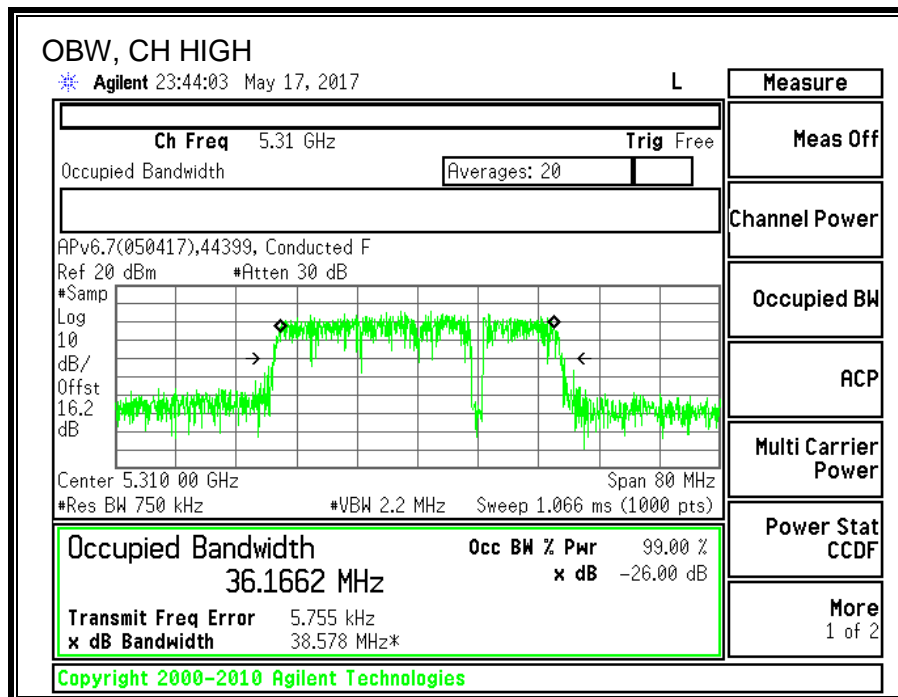
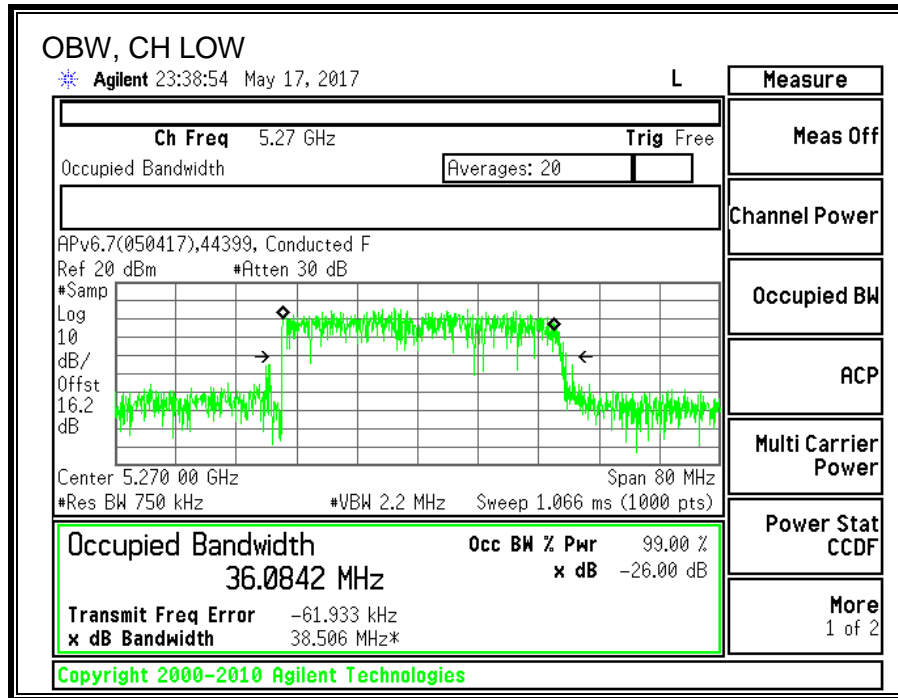



**8.13.3. AVERAGE POWER**

<b>ID:</b>	44366	<b>Date:</b>	7/25/17
------------	-------	--------------	---------

**LIMITS**

None; for reporting purposes only.

**TEST PROCEDURE**

Measurements perform using a wideband gated RF power meter.

**RESULTS**

Channel	Frequency	Power UAT 2 (dBm)
Low	5270	19.48
High	5310	17.77

---

### **8.13.4. OUTPUT POWER AND PPSD**

#### **LIMITS**

FCC §15.407 (a) (2)

For the band 5.25–5.35 GHz, the maximum conducted output power over the frequency band of operation shall not exceed the lesser of 250 mW or  $11 \text{ dBm} + 10 \log B$ , where B is the 26-dB emission bandwidth in MHz. In addition, the maximum power spectral density shall not exceed 11 dBm in any 1-MHz band. If transmitting antennas of directional gain greater than 6 dBi are used, both the maximum conducted output power and the peak power spectral density shall be reduced by the amount in dB that the directional gain of the antenna exceeds 6 dBi.

#### **TEST PROCEDURE**

Measurements perform using a wideband gated RF power meter provided that the gate parameters are adjusted such that the power is measured only when the EUT is transmitting at its maximum power control level. Since the measurement is made only during the ON time of the transmitter, no duty cycle correction factor is required.

#### **DIRECTIONAL ANTENNA GAIN**

There is only one transmitter output therefore the directional gain is equal to the antenna gain.

**RESULTS**

**Bandwidth, Antenna Gain, and Limits**

Channel	Frequency (MHz)	Min 26 dB BW (MHz)	Min 99% BW (MHz)	Directional Gain (dBi)	Power Limit (dBm)	PSD Limit (dBm/1MHz)
Low	5270	40.50	36.08	-3.11	24.00	11.00
High	5310	40.60	36.17	-3.11	24.00	11.00

<b>Duty Cycle CF (dB)</b>	0.10	<b>Included in Calculations of Corr'd PSD</b>
---------------------------	------	---

**Output Power Results**

Channel	Frequency (MHz)	UAT 2 Meas Power (dBm)	Total Corr'd Power (dBm)	Power Limit (dBm)	Power Margin (dB)
Low	5270	19.48	19.48	24.00	-4.52
High	5310	17.77	17.77	24.00	-6.23

**PSD Results**

Channel	Frequency (MHz)	UAT 2 Meas PSD (dBm/1MHz)	Total Corr'd PSD (dBm/1MHz)	PSD Limit (dBm/1MHz)	PSD Margin (dB)
Low	5270	7.155	7.255	11.00	-3.75
High	5310	7.204	7.304	11.00	-3.70

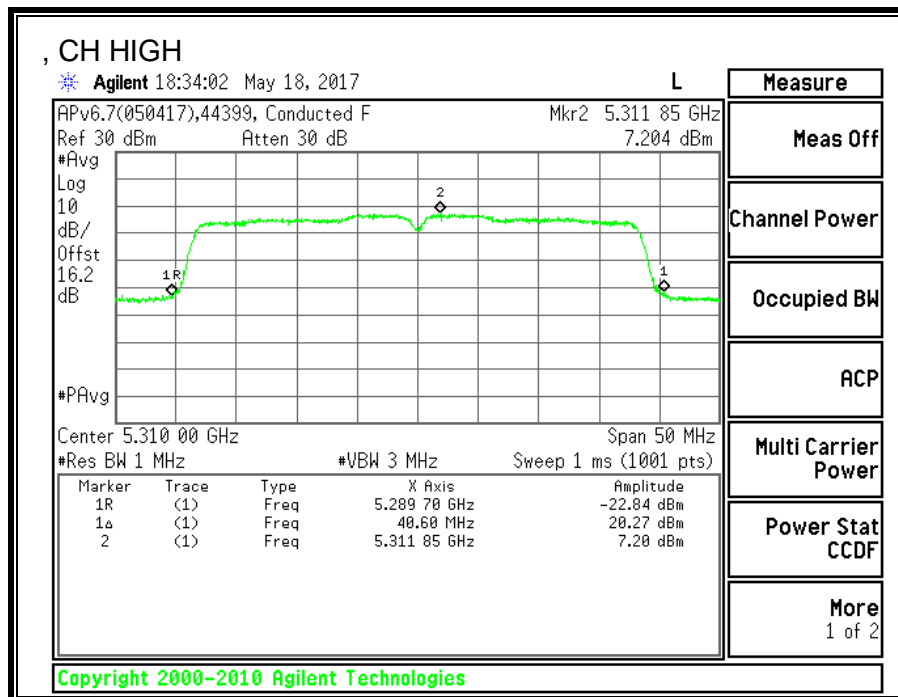
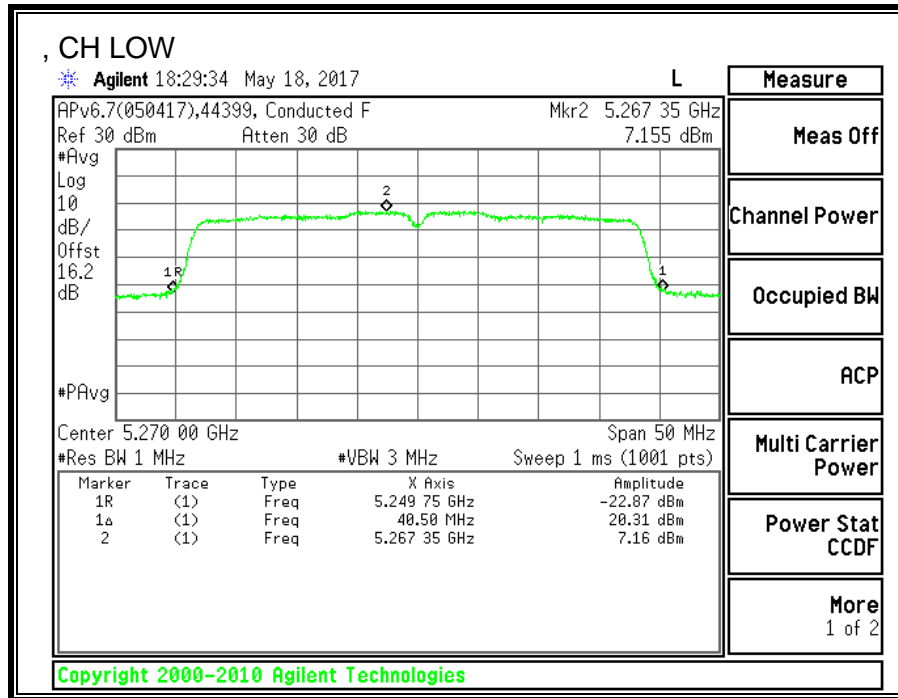

**8.14. 11n HT40 LAT 3 SISO MODE IN THE 5.3GHz BAND**

**8.14.1. 26 dB BANDWIDTH**

**LIMITS**

None; for reporting purposes only.

**RESULTS**

<b>Channel</b>	<b>Frequency</b>	<b>26 dB BW LAT 3 (MHz)</b>
Low	5270	40.7
High	5310	40.6

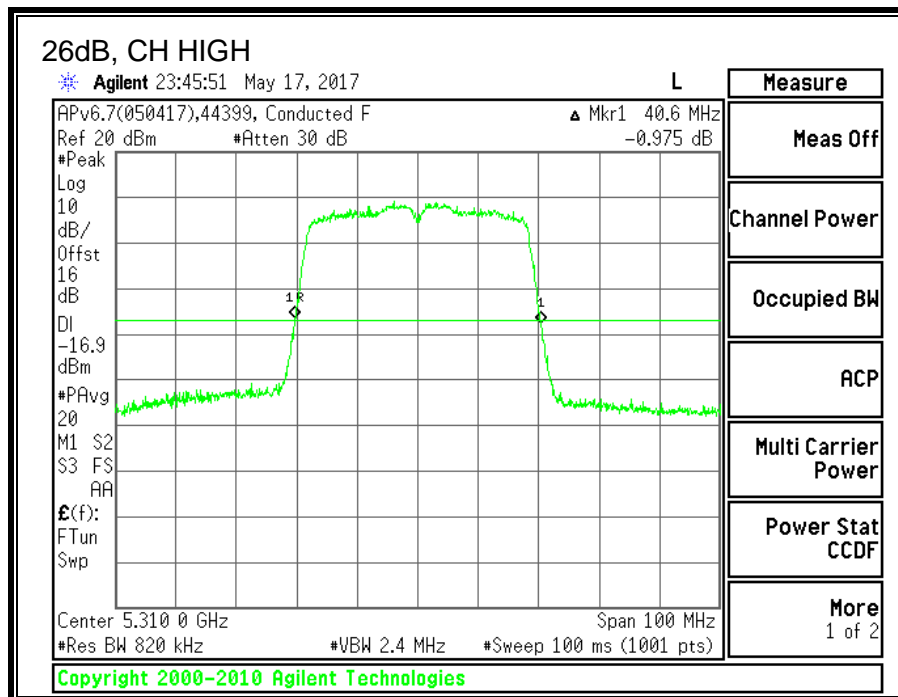
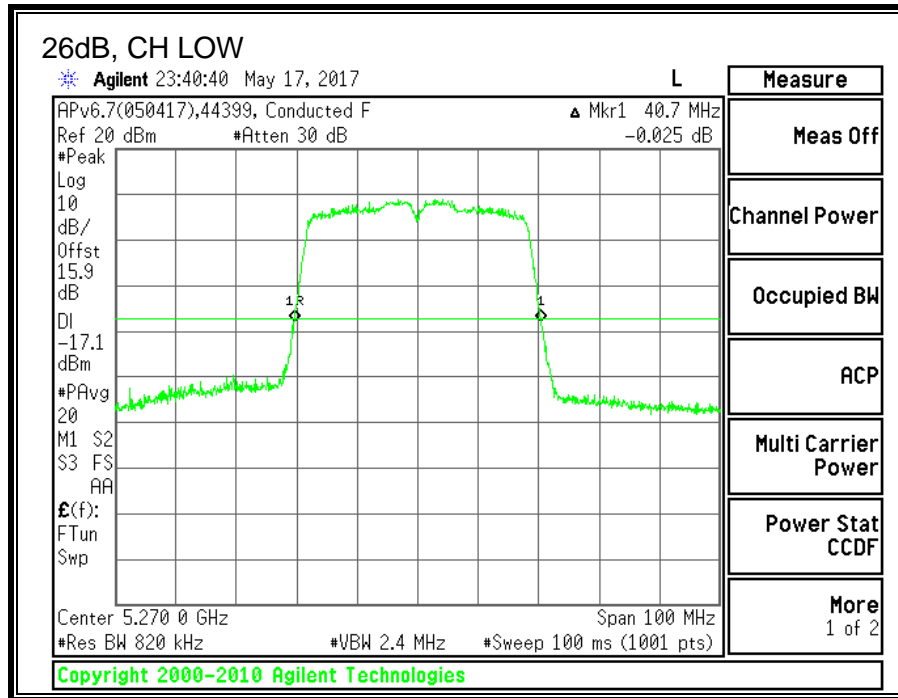

**8.14.2. 99% BANDWIDTH**

**LIMITS**

None; for reporting purposes only.

**RESULTS**

<b>Channel</b>	<b>Frequency</b>	<b>99% BW LAT 3 (MHz)</b>
Low	5270	36.0580
High	5310	36.1331

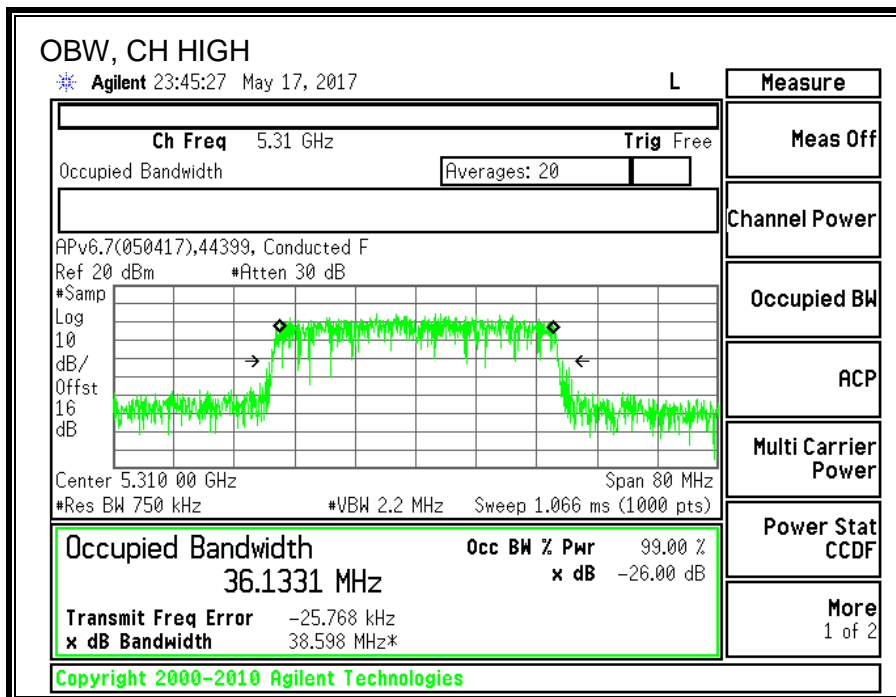
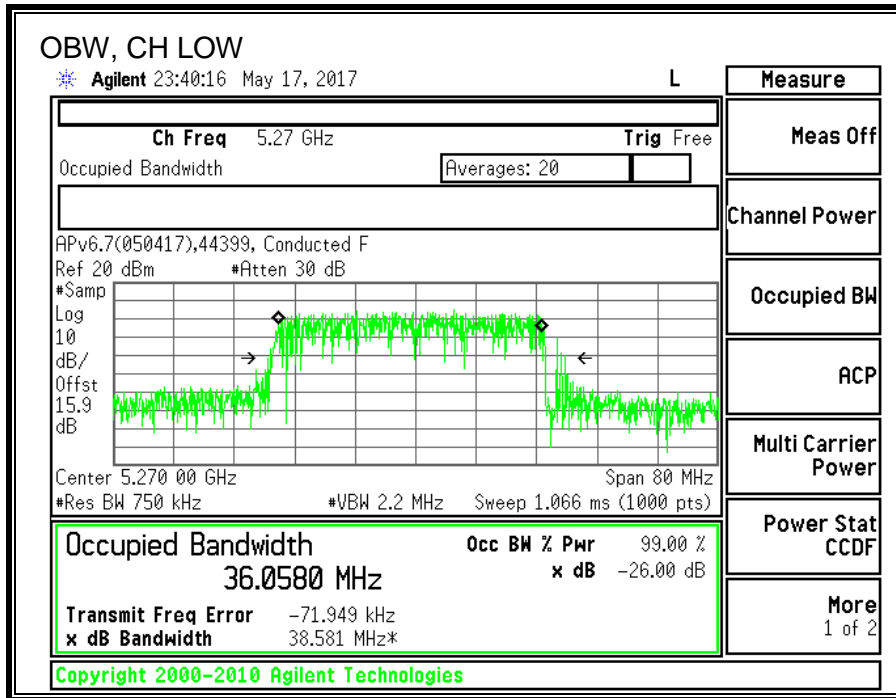



**8.14.3. AVERAGE POWER**

<b>ID:</b>	44366	<b>Date:</b>	7/25/17
------------	-------	--------------	---------

**LIMITS**

None; for reporting purposes only.

**TEST PROCEDURE**

Measurements perform using a wideband gated RF power meter.

**RESULTS**

Channel	Frequency	Power LAT 3 (dBm)
Low	5270	19.40
High	5310	17.92

---

#### **8.14.4. OUTPUT POWER AND PPSD**

##### **LIMITS**

FCC §15.407 (a) (2)

For the band 5.25–5.35 GHz, the maximum conducted output power over the frequency band of operation shall not exceed the lesser of 250 mW or  $11 \text{ dBm} + 10 \log B$ , where B is the 26–dB emission bandwidth in MHz. In addition, the maximum power spectral density shall not exceed 11 dBm in any 1–MHz band. If transmitting antennas of directional gain greater than 6 dBi are used, both the maximum conducted output power and the peak power spectral density shall be reduced by the amount in dB that the directional gain of the antenna exceeds 6 dBi.

##### **TEST PROCEDURE**

Measurements perform using a wideband gated RF power meter provided that the gate parameters are adjusted such that the power is measured only when the EUT is transmitting at its maximum power control level. Since the measurement is made only during the ON time of the transmitter, no duty cycle correction factor is required.

##### **DIRECTIONAL ANTENNA GAIN**

There is only one transmitter output therefore the directional gain is equal to the antenna gain.

**RESULTS**

**Bandwidth, Antenna Gain, and Limits**

Channel	Frequency (MHz)	Min 26 dB BW (MHz)	Min 99% BW (MHz)	Directional Gain (dBi)	Power Limit (dBm)	PSD Limit (dBm/1MHz)
Low	5270	40.70	36.06	-6.98	24.00	11.00
High	5310	40.60	36.13	-6.98	24.00	11.00

<b>Duty Cycle CF (dB)</b>	0.10	<b>Included in Calculations of Corr'd PSD</b>
---------------------------	------	---

**Output Power Results**

Channel	Frequency (MHz)	LAT 3 Meas Power (dBm)	Total Corr'd Power (dBm)	Power Limit (dBm)	Power Margin (dB)
Low	5270	19.40	19.40	24.00	-4.60
High	5310	17.92	17.92	24.00	-6.08

**PSD Results**

Channel	Frequency (MHz)	LAT 3 Meas PSD (dBm/1MHz)	Total Corr'd PSD (dBm/1MHz)	PSD Limit (dBm/1MHz)	PSD Margin (dB)
Low	5270	7.082	7.182	11.00	-3.82
High	5310	7.277	7.377	11.00	-3.62

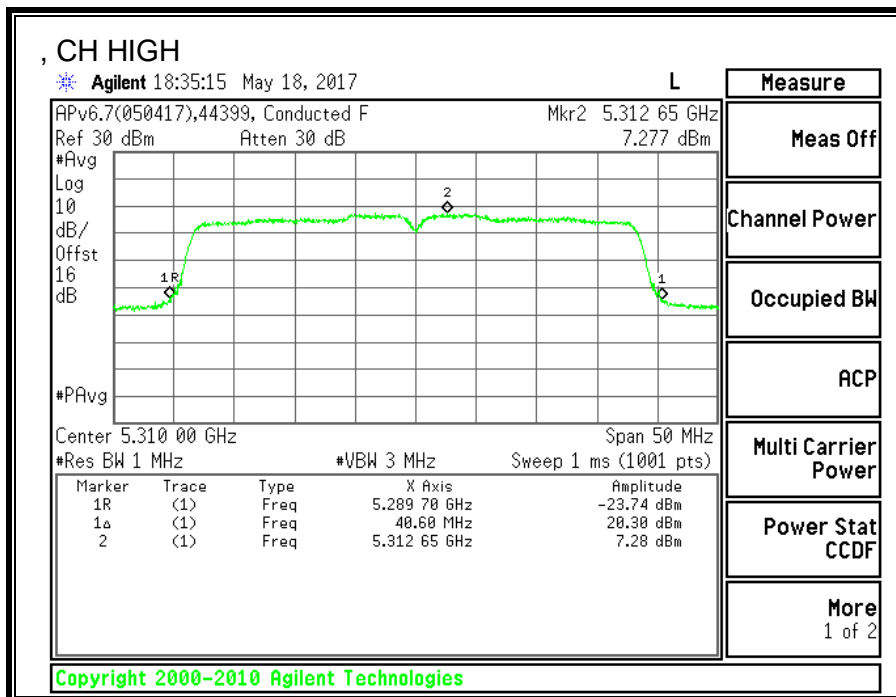
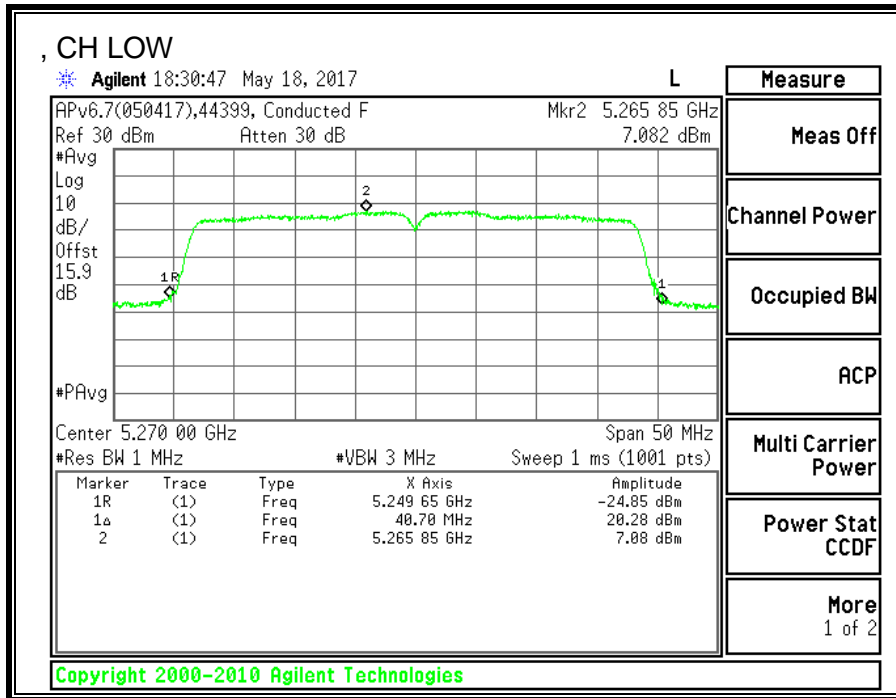

**8.15. 11n HT40 2TX CDD MIMO MODE IN THE 5.3GHz BAND**

**8.15.1. 26 dB BANDWIDTH**

**LIMITS**

None; for reporting purposes only.

**RESULTS**

<b>Channel</b>	<b>Frequency</b>	<b>26 dB BW UAT 2 (MHz)</b>	<b>26 dB BW LAT 3 (MHz)</b>
Low	5270	40.6	40.1
High	5310	40.5	40.1

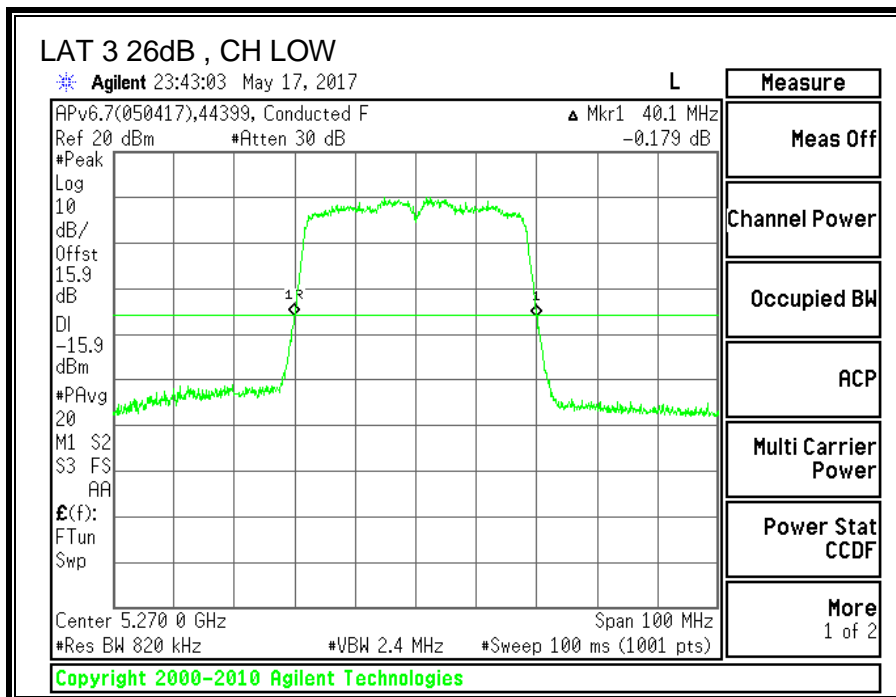
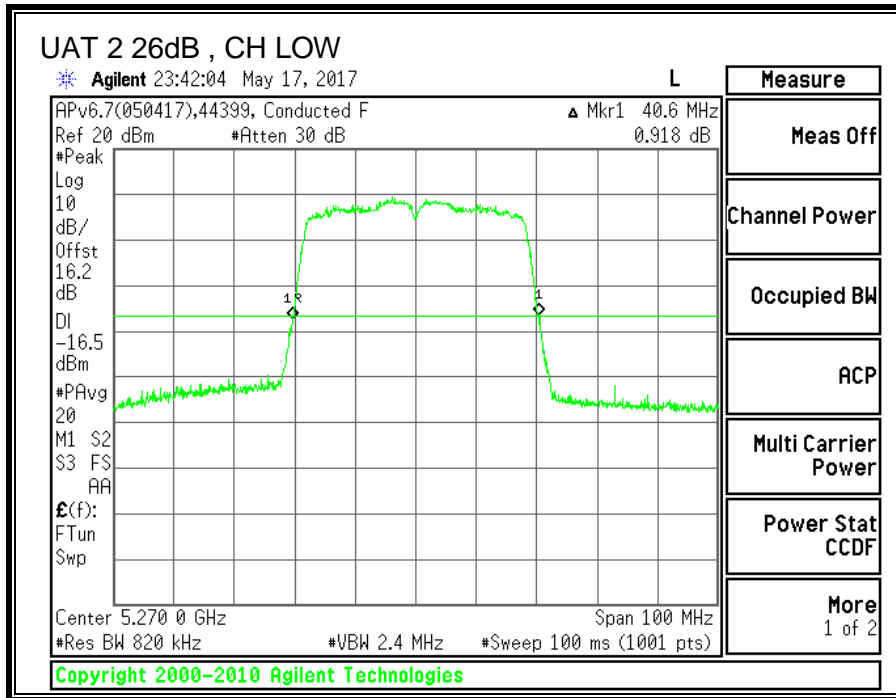

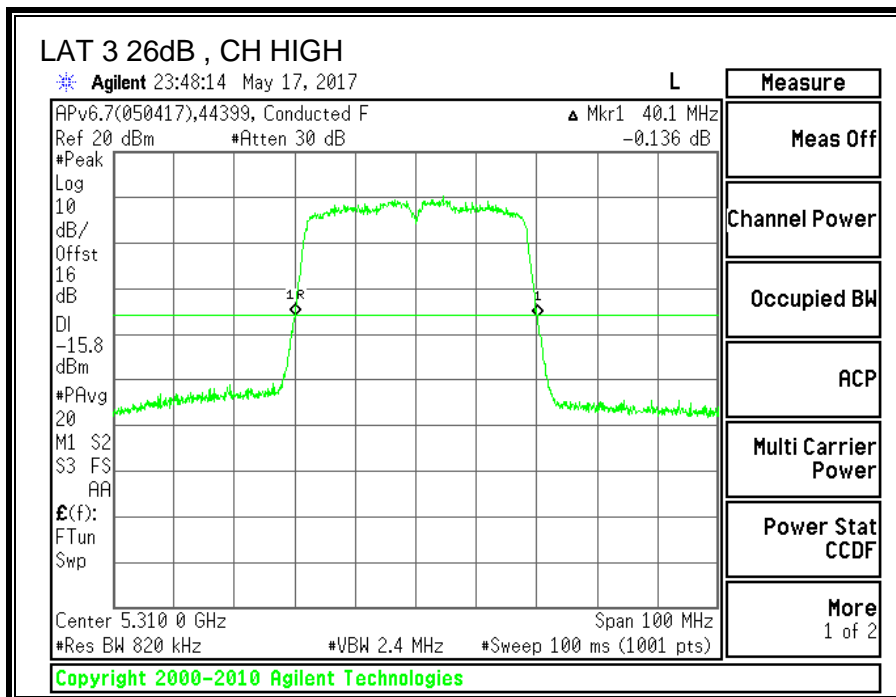
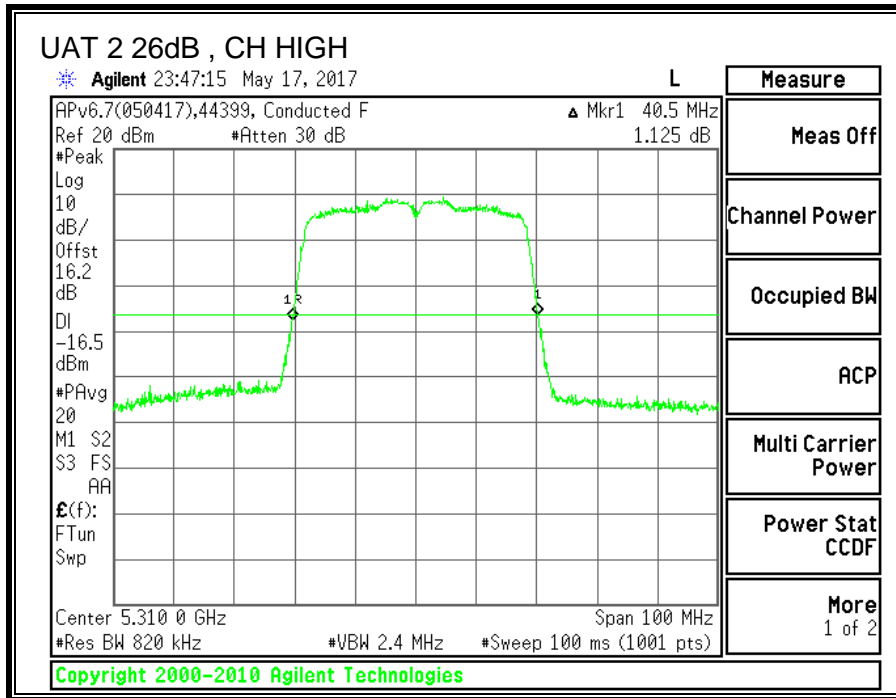

**8.15.2. 99% BANDWIDTH**

**LIMITS**

None; for reporting purposes only.

**RESULTS**

Channel	Frequency	99% BW UAT 2 (MHz)	99% BW LAT 3 (MHz)
Low	5270	36.0868	36.1364
High	5310	36.1817	36.2163



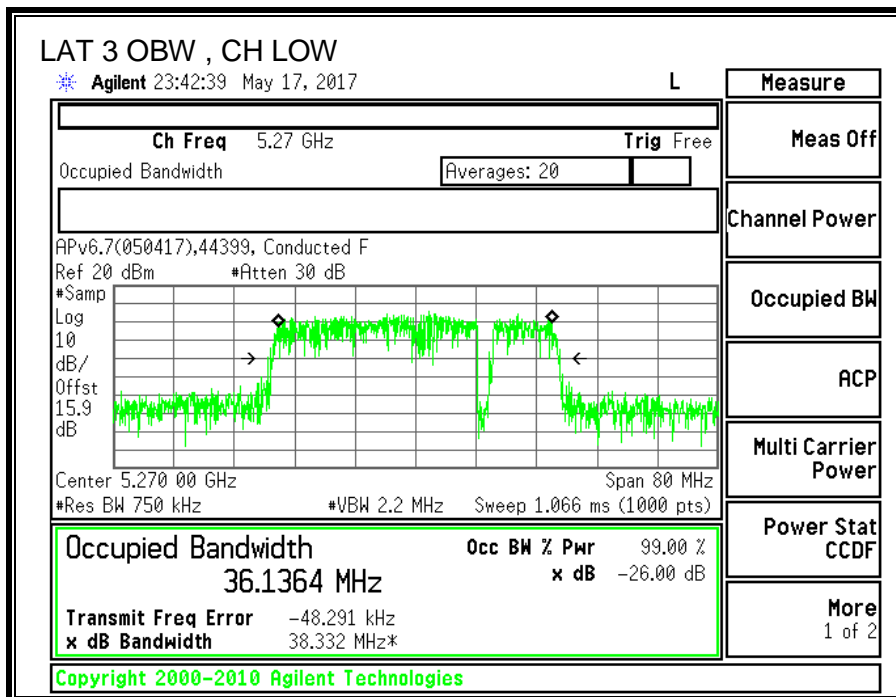
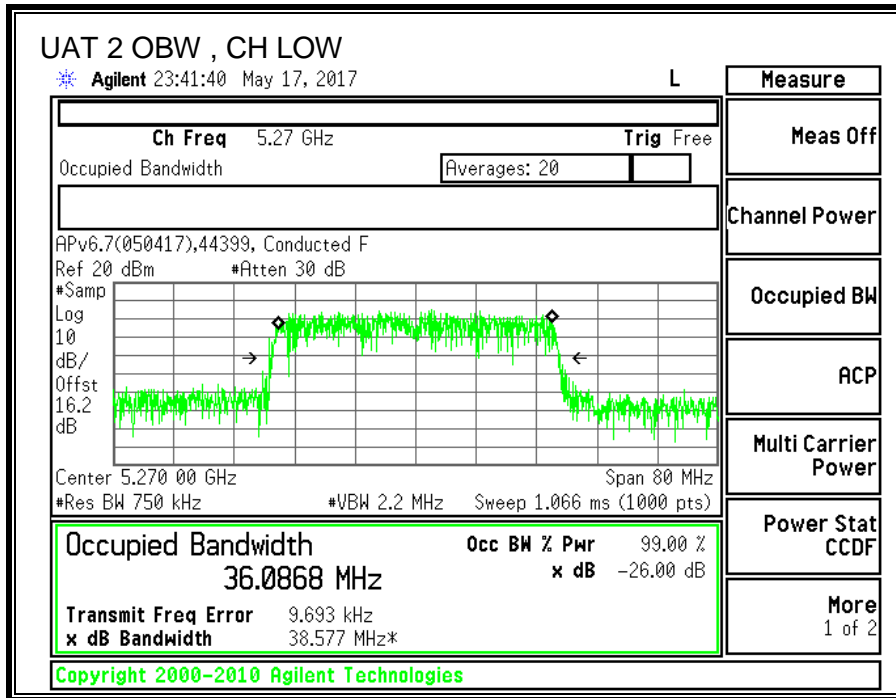

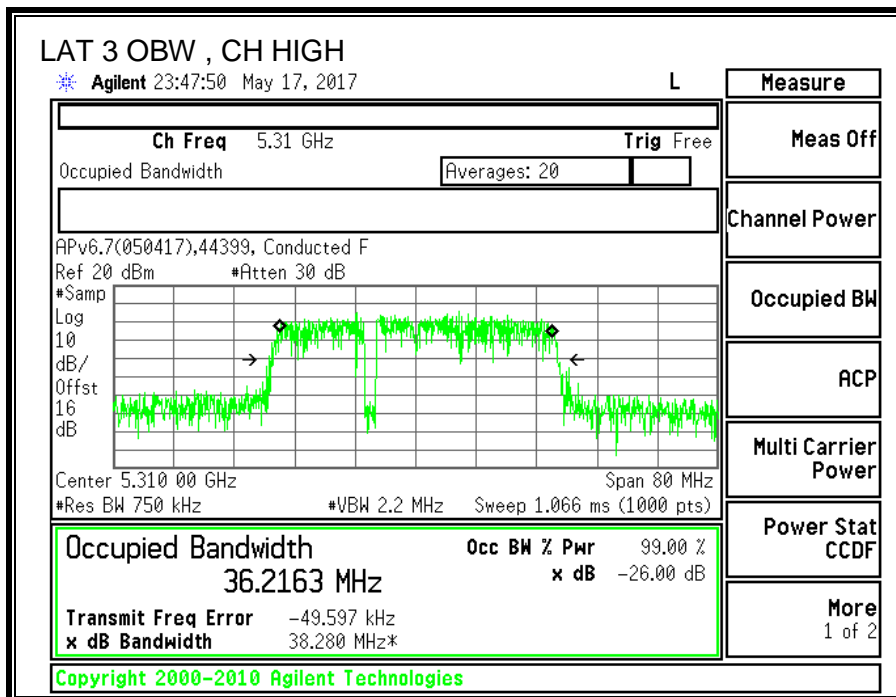
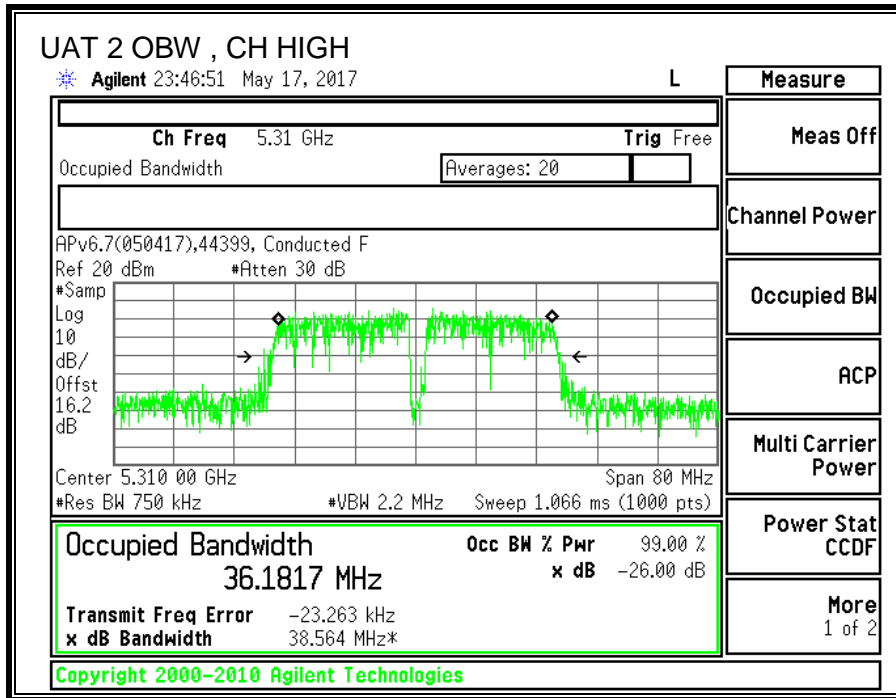

**8.15.3. AVERAGE POWER**

<b>ID:</b>	44366	<b>Date:</b>	7/25/17
------------	-------	--------------	---------

**LIMITS**

None; for reporting purposes only.

**TEST PROCEDURE**

Measurements perform using a wideband gated RF power meter.

**RESULTS**

**Average Power Results**

<b>Channel</b>	<b>Frequency (MHz)</b>	<b>UAT 2 Power (dBm)</b>	<b>LAT 3 Power (dBm)</b>	<b>Total Power (dBm)</b>
Low	5270	19.27	19.23	22.26
High	5310	16.77	16.94	19.87

**8.15.4. OUTPUT POWER AND PPSD**

**LIMITS**

FCC §15.407 (a) (2)

For the band 5.25–5.35 GHz, the maximum conducted output power over the frequency band of operation shall not exceed the lesser of 250 mW or  $11 \text{ dBm} + 10 \log B$ , where B is the 26–dB emission bandwidth in MHz. In addition, the maximum power spectral density shall not exceed 11 dBm in any 1–MHz band. If transmitting antennas of directional gain greater than 6 dBi are used, both the maximum conducted output power and the peak power spectral density shall be reduced by the amount in dB that the directional gain of the antenna exceeds 6 dBi.

**TEST PROCEDURE**

Measurements perform using a wideband gated RF power meter provided that the gate parameters are adjusted such that the power is measured only when the EUT is transmitting at its maximum power control level. Since the measurement is made only during the ON time of the transmitter, no duty cycle correction factor is required.

**DIRECTIONAL ANTENNA GAIN**

For Power used uncorrelated gain: The TX chains are uncorrelated and the antenna gain is unequal among the chains. The directional gain is:

UAT 2 Antenna Gain (dBi)	LAT 3 Antenna Gain (dBi)	Uncorrelated Chains Directional Gain (dBi)
-3.11	-6.98	-4.63

For PSD used correlated gain: The TX chains are correlated and the antenna gain is unequal among the chains. The directional gain is:

UAT 2 Antenna Gain (dBi)	LAT 3 Antenna Gain (dBi)	Correlated Chains Directional Gain (dBi)
-3.11	-6.98	-1.82

**RESULTS**

**Bandwidth, Antenna Gain and Limits**

Channel	Frequency (MHz)	Min 26 dB BW (MHz)	Min 99% BW (MHz)	Directional Gain for Power (dBi)	Directional Gain for PSD (dBi)	Power Limit (dBm)	PSD Limit (dBm/1MHz)
Low	5270	40.100	36.087	-4.63	-1.82	24.00	11.00
High	5310	40.100	36.182	-4.63	-1.82	24.00	11.00

<b>Duty Cycle CF (dB)</b>	0.10	<b>Included in Calculations of Corr'd PSD</b>
---------------------------	------	---

**Output Power Results**

Channel	Frequency (MHz)	UAT 2 Meas Power (dBm)	LAT 3 Meas Power (dBm)	Total Corr'd Power (dBm)	Power Limit (dBm)	Power Margin (dB)
Low	5270	19.17	19.23	22.21	24.00	-1.79
High	5310	16.77	16.94	19.87	24.00	-4.13

**PSD Results**

Channel	Frequency (MHz)	UAT 2 Meas PSD (dBm/1MHz)	LAT 3 Meas PSD (dBm/1MHz)	Total Corr'd PSD (dBm/1MHz)	PSD Limit (dBm/1MHz)	PSD Margin (dB)
Low	5270	5.468	5.299	8.49	11.00	-2.51
High	5310	5.950	5.408	8.80	11.00	-2.20

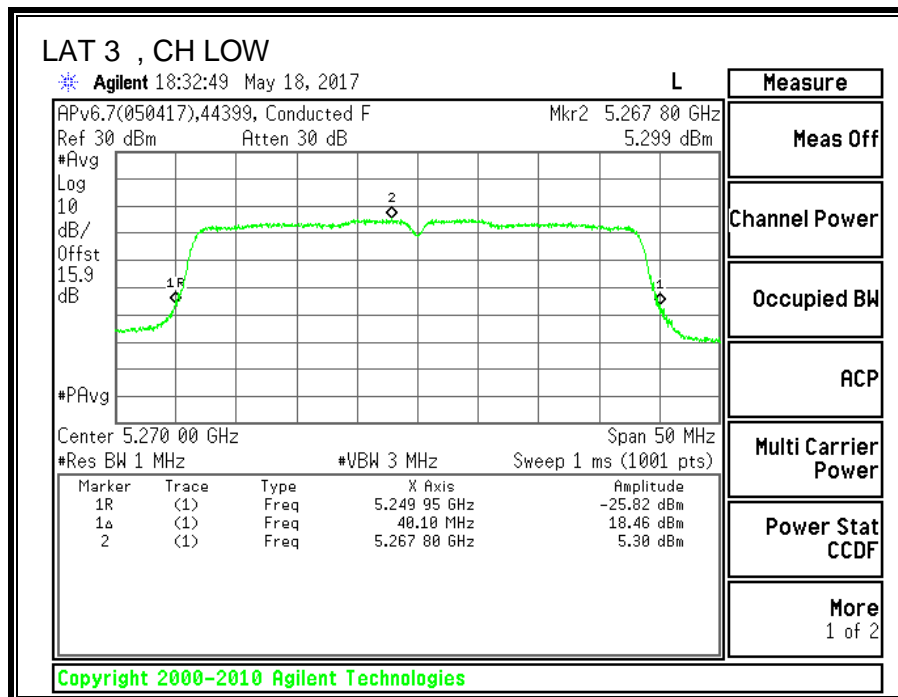
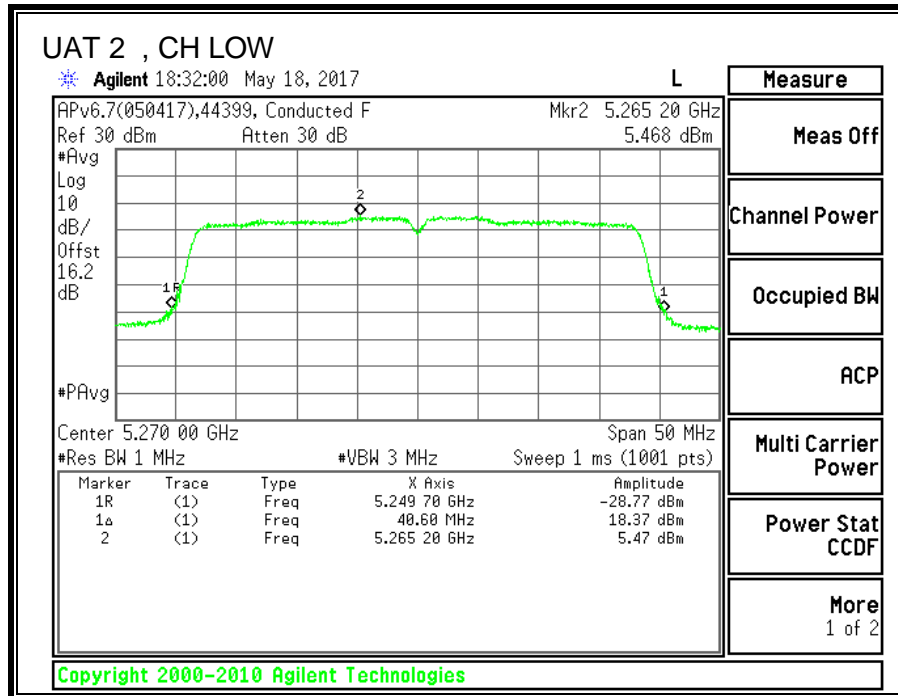

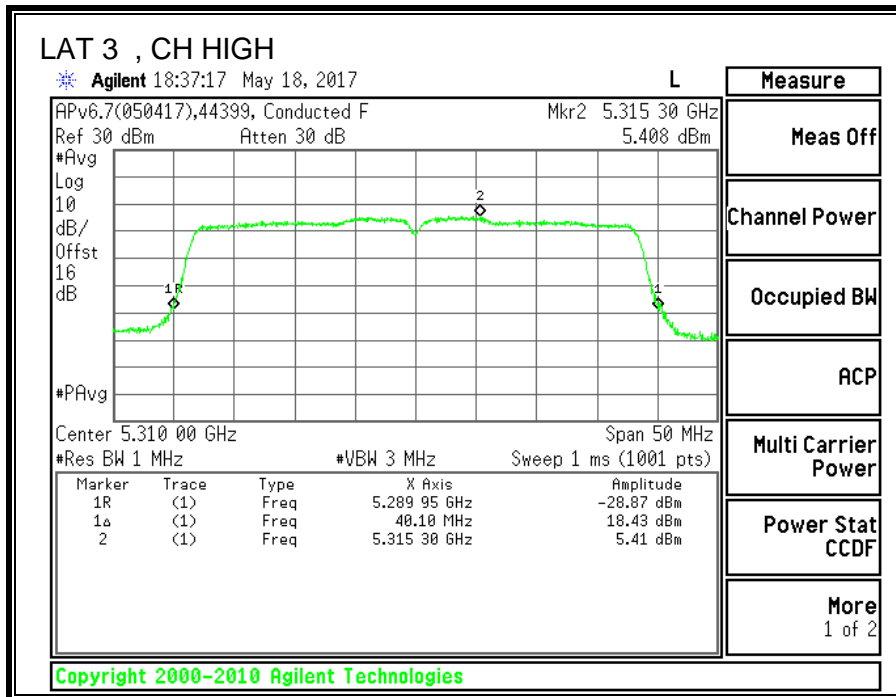
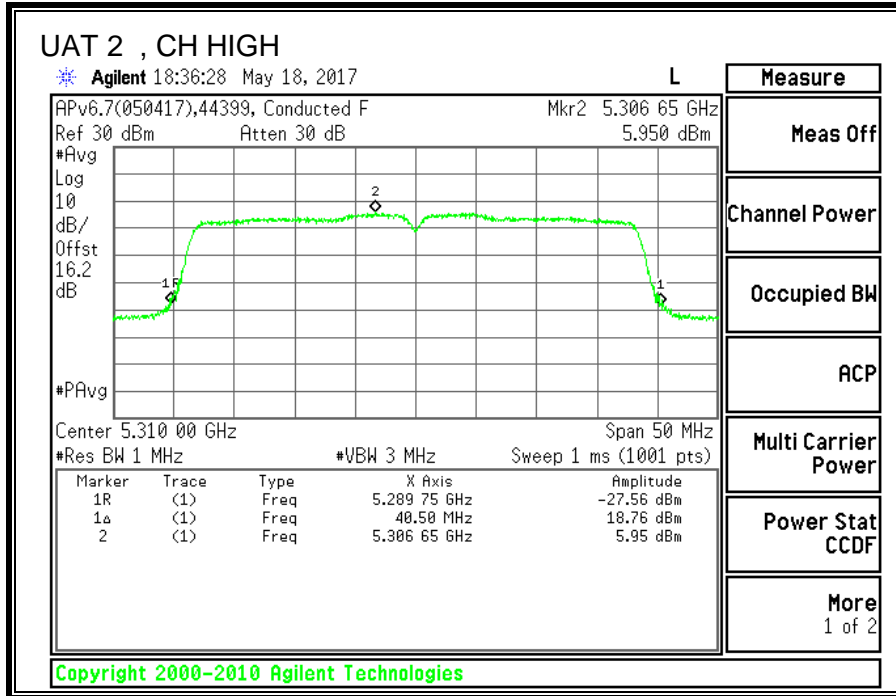

**8.16. 11ac HT80 UAT 2 SISO MODE IN THE 5.3GHz BAND**

**8.16.1. 26 dB BANDWIDTH**

**LIMITS**

None; for reporting purposes only.

**RESULTS**

<b>Channel</b>	<b>Frequency</b>	<b>26 dB BW UAT 2 (MHz)</b>
Mid	5290	82.4



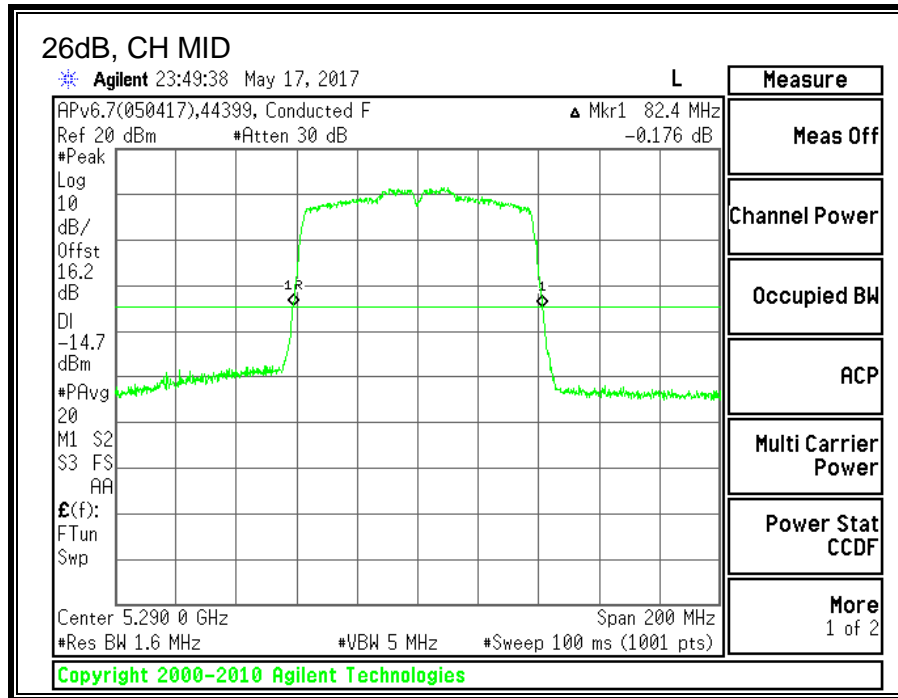

**8.16.2. 99% BANDWIDTH**

**LIMITS**

None; for reporting purposes only.

**RESULTS**

<b>Channel</b>	<b>Frequency</b>	<b>99% BW UAT 2 (MHz)</b>
Mid	5290	75.1947

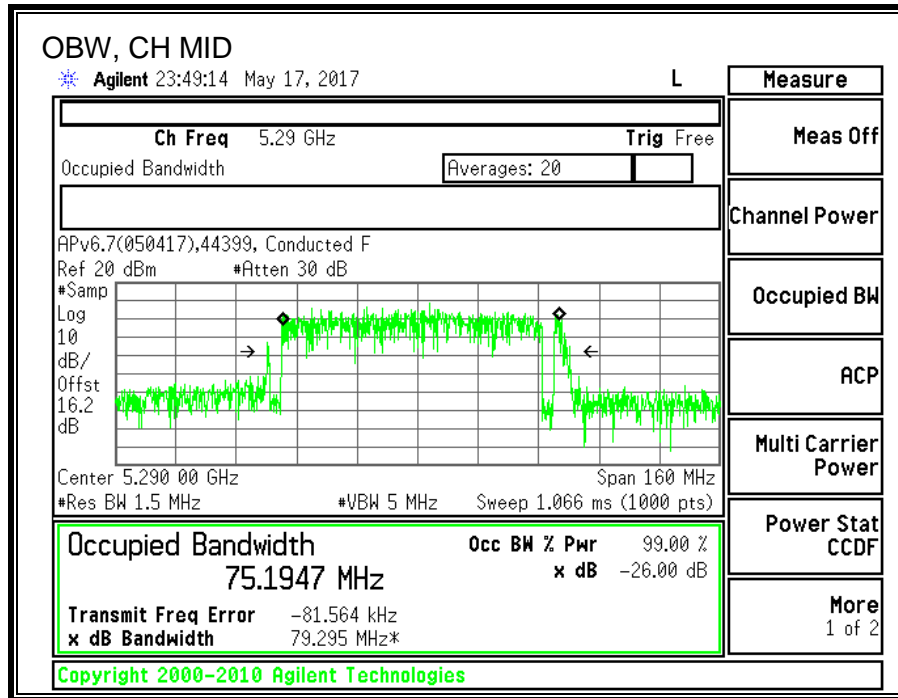

**8.16.3. AVERAGE POWER**

<b>ID:</b>	44366	<b>Date:</b>	7/25/17
------------	-------	--------------	---------

**LIMITS**

None; for reporting purposes only.

**TEST PROCEDURE**

Measurements perform using a wideband gated RF power meter.

**RESULTS**

<b>Channel</b>	<b>Frequency</b>	<b>Power UAT 2 (dBm)</b>
Mid	5290	17.32

---

## 8.16.4. OUTPUT POWER AND PPSD

### **LIMITS**

FCC §15.407 (a) (2)

For the band 5.25–5.35 GHz, the maximum conducted output power over the frequency band of operation shall not exceed the lesser of 250 mW or  $11 \text{ dBm} + 10 \log B$ , where B is the 26–dB emission bandwidth in MHz. In addition, the maximum power spectral density shall not exceed 11 dBm in any 1–MHz band. If transmitting antennas of directional gain greater than 6 dBi are used, both the maximum conducted output power and the peak power spectral density shall be reduced by the amount in dB that the directional gain of the antenna exceeds 6 dBi.

### **TEST PROCEDURE**

Measurements perform using a wideband gated RF power meter provided that the gate parameters are adjusted such that the power is measured only when the EUT is transmitting at its maximum power control level. Since the measurement is made only during the ON time of the transmitter, no duty cycle correction factor is required.

### **DIRECTIONAL ANTENNA GAIN**

There is only one transmitter output therefore the directional gain is equal to the antenna gain.

**RESULTS**

**Bandwidth, Antenna Gain, and Limits**

Channel	Frequency (MHz)	Min 26 dB BW (MHz)	Min 99% BW (MHz)	Directional Gain (dBi)	Power Limit (dBm)	PSD Limit (dBm/1MHz)
Mid	5290	82.40	75.19	-3.11	24.00	11.00

Duty Cycle CF (dB)	0.19	Included in Calculations of Corr'd PSD
--------------------	------	--

**Output Power Results**

Channel	Frequency (MHz)	UAT 2 Meas Power (dBm)	Total Corr'd Power (dBm)	Power Limit (dBm)	Power Margin (dB)
Mid	5290	17.32	17.32	24.00	-6.68

**PPSD Results**

Channel	Frequency (MHz)	UAT 2 Meas PSD (dBm/1MHz)	Total Corr'd PSD (dBm/1MHz)	PSD Limit (dBm/1MHz)	PSD Margin (dB)
Mid	5290	4.40	4.59	11.00	-6.41

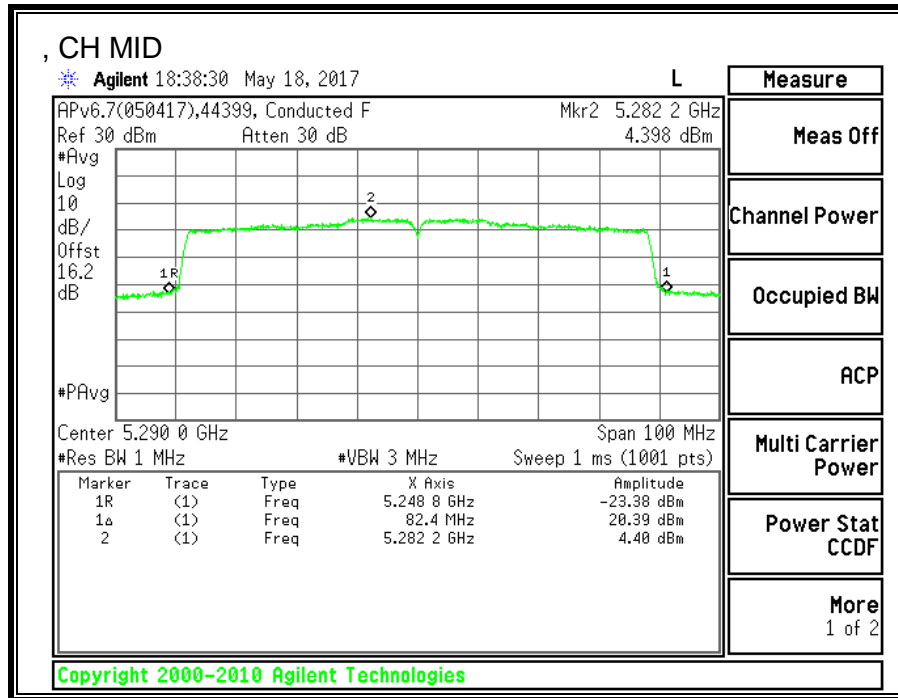

**8.17. 11ac HT80 LAT 3 SISO MODE IN THE 5.3GHz BAND**

**8.17.1. 26 dB BANDWIDTH**

**LIMITS**

None; for reporting purposes only.

**RESULTS**

<b>Channel</b>	<b>Frequency</b>	<b>26 dB BW LAT 3 (MHz)</b>
Mid	5290	82.4



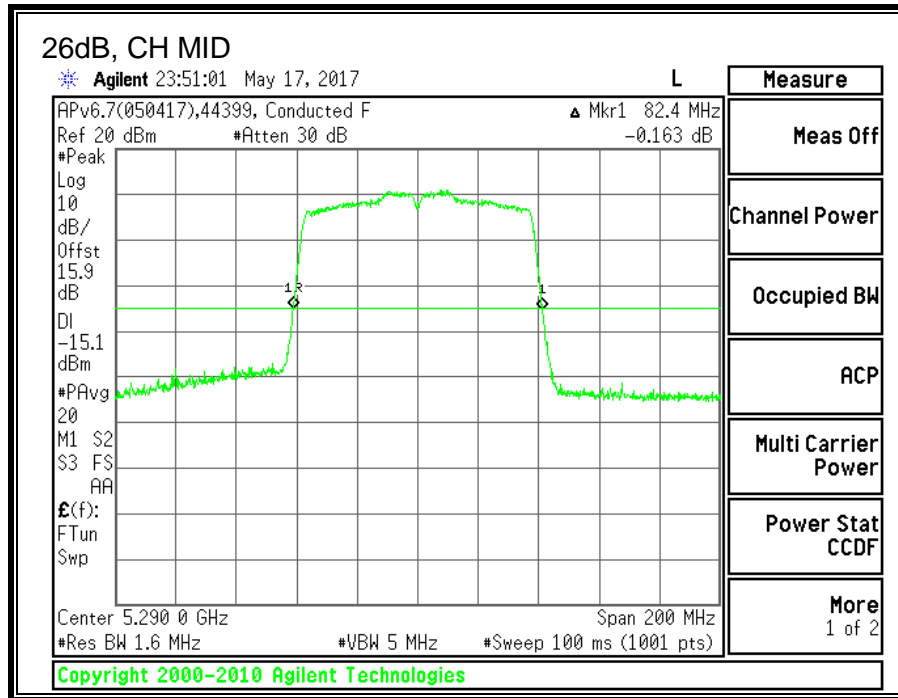

**8.17.2. 99% BANDWIDTH**

**LIMITS**

None; for reporting purposes only.

**RESULTS**

<b>Channel</b>	<b>Frequency</b>	<b>99% BW LAT 3 (MHz)</b>
Mid	5290	75.1687

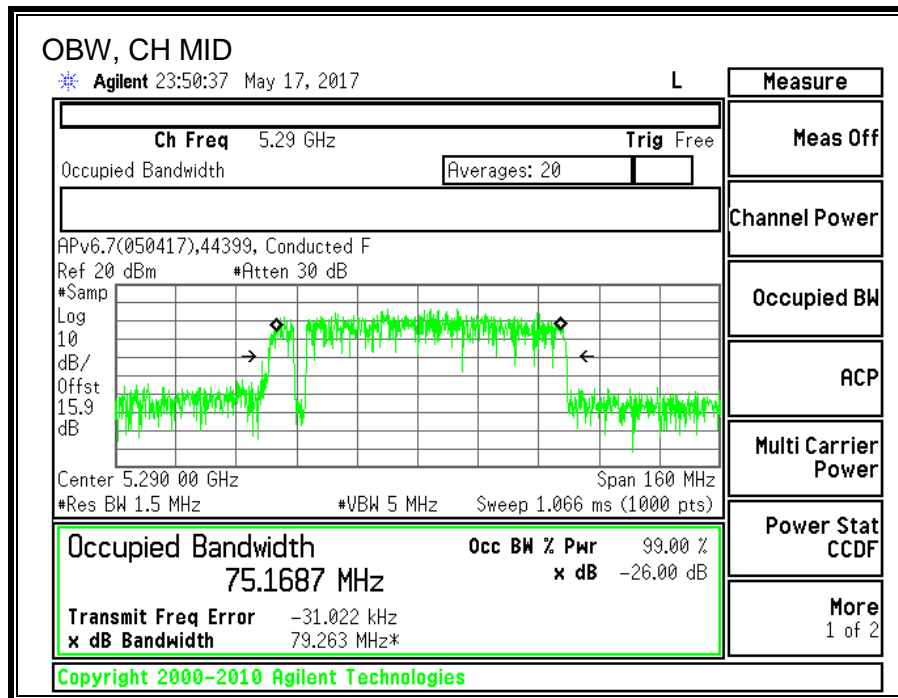

**8.17.3. AVERAGE POWER**

<b>ID:</b>	44366	<b>Date:</b>	7/25/17
------------	-------	--------------	---------

**LIMITS**

None; for reporting purposes only.

**TEST PROCEDURE**

Measurements perform using a wideband gated RF power meter.

**RESULTS**

Channel	Frequency	Power LAT 3 (dBm)
Mid	5290	17.47

---

## 8.17.4. OUTPUT POWER AND PPSD

### **LIMITS**

FCC §15.407 (a) (2)

For the band 5.25–5.35 GHz, the maximum conducted output power over the frequency band of operation shall not exceed the lesser of 250 mW or  $11 \text{ dBm} + 10 \log B$ , where B is the 26-dB emission bandwidth in MHz. In addition, the maximum power spectral density shall not exceed 11 dBm in any 1-MHz band. If transmitting antennas of directional gain greater than 6 dBi are used, both the maximum conducted output power and the peak power spectral density shall be reduced by the amount in dB that the directional gain of the antenna exceeds 6 dBi.

### **TEST PROCEDURE**

Measurements perform using a wideband gated RF power meter provided that the gate parameters are adjusted such that the power is measured only when the EUT is transmitting at its maximum power control level. Since the measurement is made only during the ON time of the transmitter, no duty cycle correction factor is required.

### **DIRECTIONAL ANTENNA GAIN**

There is only one transmitter output therefore the directional gain is equal to the antenna gain.

**RESULTS**

**Bandwidth, Antenna Gain, and Limits**

Channel	Frequency (MHz)	Min 26 dB BW (MHz)	Min 99% BW (MHz)	Directional Gain (dBi)	Power Limit (dBm)	PSD Limit (dBm/1MHz)
Mid	5290	82.40	75.17	-6.98	24.00	11.00

<b>Duty Cycle CF (dB)</b>	0.19	<b>Included in Calculations of Corr'd PSD</b>
---------------------------	------	---

**Output Power Results**

Channel	Frequency (MHz)	LAT 3 Meas Power (dBm)	Total Corr'd Power (dBm)	Power Limit (dBm)	Power Margin (dB)
Mid	5290	17.47	17.47	24.00	-6.53

**PPSD Results**

Channel	Frequency (MHz)	LAT 3 Meas PSD (dBm/1MHz)	Total Corr'd PSD (dBm/1MHz)	PSD Limit (dBm/1MHz)	PSD Margin (dB)
Mid	5290	4.37	4.56	11.00	-6.44

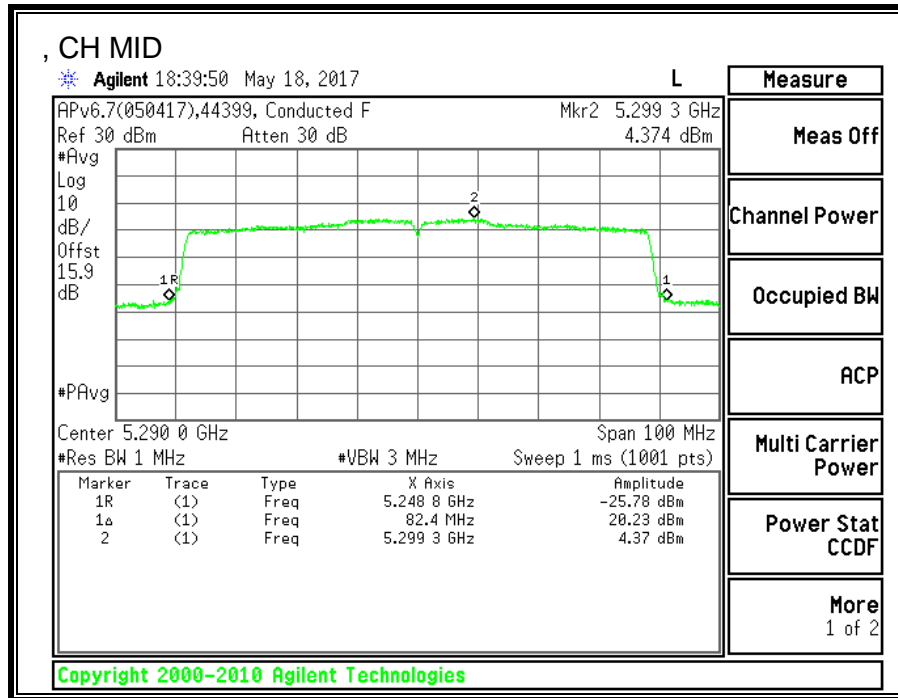

**8.18. 11ac HT80 2TX CDD MIMO MODE IN THE 5.3GHz BAND**

**8.18.1. 26 dB BANDWIDTH**

**LIMITS**

None; for reporting purposes only.

**RESULTS**

<b>Channel</b>	<b>Frequency</b>	<b>26 dB BW UAT 2 (MHz)</b>	<b>26 dB BW LAT 3 (MHz)</b>
Mid	5290	82.4	82.0