



CERTIFICATION TEST REPORT

Report Number. : 11696948-E3V4

Applicant : APPLE, INC.
1 INFINITE LOOP
CUPERTINO, CA 95014, U.S.A.

Model : A1864 & A1899

FCC ID : BCG-E3160A

IC : 579C-E3160A

EUT Description : SMARTPHONE

Test Standard(s) : FCC 47 CFR PART 15 SUBPART C
INDUSTRY CANADA RSS - 247 ISSUE 2

Date Of Issue:
August 21, 2017

Prepared by:
UL Verification Services Inc.
47173 Benicia Street
Fremont, CA 94538, U.S.A.
TEL: (510) 771-1000
FAX: (510) 661-0888



NVLAP LAB CODE 200065-0

Revision History

<u>Rev.</u>	<u>Issue Date</u>	<u>Revisions</u>	<u>Revised By</u>
V1	7/14/2017	Initial Issue	Mengistu Mekuria
V2	7/25/2017	Address TCB's Questions	Chin Pang
V3	8/2/2017	Added correlated antenna gain to PSD	Francisco Guarnero
V4	8/21/2017	2 nd TCB Review Questions	Francisco Guarnero

TABLE OF CONTENTS

1. ATTESTATION OF TEST RESULTS	5
2. TEST METHODOLOGY	6
3. FACILITIES AND ACCREDITATION	6
4. CALIBRATION AND UNCERTAINTY	6
4.1. <i>MEASURING INSTRUMENT CALIBRATION</i>	<i>6</i>
4.2. <i>SAMPLE CALCULATION</i>	<i>6</i>
4.3. <i>MEASUREMENT UNCERTAINTY.....</i>	<i>7</i>
5. EQUIPMENT UNDER TEST	8
5.1. <i>DESCRIPTION OF EUT</i>	<i>8</i>
5.2. <i>DIFFERENCE IN MODEL NUMBER.....</i>	<i>8</i>
5.3. <i>MAXIMUM OUTPUT POWER.....</i>	<i>8</i>
5.4. <i>DESCRIPTION OF AVAILABLE ANTENNAS</i>	<i>8</i>
5.5. <i>SOFTWARE AND FIRMWARE.....</i>	<i>8</i>
5.6. <i>WORST-CASE CONFIGURATION AND MODE.....</i>	<i>9</i>
5.7. <i>DESCRIPTION OF TEST SETUP.....</i>	<i>10</i>
5.8. <i>DESCRIPTION OF TEST SETUP.....</i>	<i>15</i>
6. TEST AND MEASUREMENT EQUIPMENT	19
7. MEASUREMENT METHODS	20
8. ANTENNA PORT TEST RESULTS	21
8.1. <i>ON TIME AND DUTY CYCLE.....</i>	<i>21</i>
8.2. <i>11b UAT 1 SISO MODE IN THE 2.4GHz BAND</i>	<i>24</i>
8.2.1. <i>6 dB BANDWIDTH.....</i>	<i>24</i>
8.2.2. <i>99% BANDWIDTH.....</i>	<i>29</i>
8.2.3. <i>AVERAGE POWER</i>	<i>34</i>
8.2.4. <i>OUTPUT POWER</i>	<i>35</i>
8.2.5. <i>POWER SPECTRAL DENSITY</i>	<i>37</i>
8.2.6. <i>CONDUCTED BANDEDGE AND SPURIOUS EMISSIONS.....</i>	<i>42</i>
8.3. <i>11b LAT 3 SISO MODE IN THE 2.4GHz BAND.....</i>	<i>51</i>
8.3.1. <i>6 dB BANDWIDTH.....</i>	<i>51</i>
8.3.2. <i>99% BANDWIDTH.....</i>	<i>56</i>
8.3.3. <i>AVERAGE POWER</i>	<i>61</i>
8.3.4. <i>OUTPUT POWER</i>	<i>62</i>
8.3.5. <i>POWER SPECTRAL DENSITY</i>	<i>64</i>
8.3.6. <i>CONDUCTED BANDEDGE AND SPURIOUS EMISSIONS.....</i>	<i>69</i>

8.4. 11n HT20 UAT 1 SISO MODE IN THE 2.4GHz BAND.....78
8.4.1. 6 dB BANDWIDTH.....78
8.4.2. 99% BANDWIDTH.....84
8.4.3. AVERAGE POWER.....90
8.4.4. OUTPUT POWER.....91
8.4.5. POWER SPECTRAL DENSITY.....93
8.4.6. CONDUCTED BANDEDGE AND SPURIOUS EMISSIONS.....99
8.5. 11n HT20 LAT 3 SISO MODE IN THE 2.4GHz BAND.....109
8.5.1. 6 dB BANDWIDTH.....109
8.5.2. 99% BANDWIDTH.....115
8.5.3. AVERAGE POWER.....121
8.5.4. OUTPUT POWER.....122
8.5.5. POWER SPECTRAL DENSITY.....124
8.5.6. CONDUCTED BANDEDGE AND SPURIOUS EMISSIONS.....130
8.6. 11n HT20 2TX CDD MODE IN THE 2.4 GHz BAND.....140
8.6.1. 6 dB BANDWIDTH.....140
8.6.2. 99% BANDWIDTH.....151
8.6.3. AVERAGE POWER.....162
8.6.4. OUTPUT POWER.....163
8.6.5. POWER SPECTRAL DENSITY.....165
8.6.6. CONDUCTED BANDEDGE AND SPURIOUS EMISSIONS.....175
9. RADIATED TEST RESULTS.....194
9.1. LIMITS AND PROCEDURE.....194
9.2. TRANSMITTER ABOVE 1 GHz.....195
9.2.1. 11b UAT 1 SISO MODE IN THE 2.4GHz BAND.....195
9.2.2. 11b LAT 3 SISO MODE IN THE 2.4GHz BAND.....209
9.2.3. 11n HT20 UAT 1 SISO MODE IN THE 2.4GHz BAND.....223
9.2.4. 11n HT20 LAT 3 SISO MODE IN THE 2.4GHz BAND.....233
9.2.5. 11n HT20 2TX CDD MIMO MODE IN THE 2.4GHz BAND.....243
9.3. WORST-CASE BELOW 1 GHz.....259
9.4. WORST-CASE 18 to 26 GHz.....261
10. AC POWER LINE CONDUCTED EMISSIONS.....263
10.1. EUT POWERED BY AC/DC ADAPTER VIA USB CABLE.....264
10.2. EUT POWERED BY HOST PC VIA USB CABLE.....266
11. SETUP PHOTOS.....268

1. ATTESTATION OF TEST RESULTS

COMPANY NAME: APPLE, INC.
1 INFINITE LOOP
CUPERTINO, CA 95014, U.S.A.

EUT DESCRIPTION: SMARTPHONE

MODEL: A1864, A1899

SERIAL NUMBER: C39TQ00FJ6KP

DATE TESTED: MARCH 08, 2017 – July 21, 2017

APPLICABLE STANDARDS	
STANDARD	TEST RESULTS
CFR 47 Part 15 Subpart C	Pass
INDUSTRY CANADA RSS-247 Issue 2	Pass
INDUSTRY CANADA RSS-GEN Issue 4	Pass

UL Verification Services Inc. tested the above equipment in accordance with the requirements set forth in the above standards. All indications of Pass/Fail in this report are opinions expressed by UL Verification Services Inc. based on interpretations and/or observations of test results. Measurement Uncertainties were not taken into account and are published for informational purposes only. The test results show that the equipment tested is capable of demonstrating compliance with the requirements as documented in this report.

Note: The results documented in this report apply only to the tested sample, under the conditions and modes of operation as described herein. This document may not be altered or revised in any way unless done so by UL Verification Services Inc. and all revisions are duly noted in the revisions section. Any alteration of this document not carried out by UL Verification Services Inc. will constitute fraud and shall nullify the document. This report must not be used by the client to claim product certification, approval, or endorsement by NVLAP, NIST, any agency of the Federal Government, or any agency of any government.

Approved & Released For
UL Verification Services Inc. By:

Prepared By:

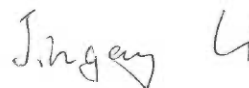

CHIN PANG
SENIOR ENGINEER
UL VERIFICATION SERVICES INC.

JINGANG LI
TEST ENGINEER
UL VERIFICATION SERVICES INC.

2. TEST METHODOLOGY

The tests documented in this report were performed in accordance with FCC CFR 47 Part 2, FCC CFR 47 Part 15, KDB 558074 D01 v04, ANSI C63.10-2013, MIMO KDB 662911, RSS-GEN Issue 4, and RSS-247 Issue 2.

3. FACILITIES AND ACCREDITATION

The test sites and measurement facilities used to collect data are located at 47173 and 47266 Benicia Street, Fremont, California, USA. Line conducted emissions are measured only at the 47173 address. The following table identifies which facilities were utilized for radiated emission measurements documented in this report. Specific facilities are also identified in the test results sections.

47173 Benicia Street		47266 Benicia Street	
<input type="checkbox"/>	Chamber A (IC:2324B-1)	<input checked="" type="checkbox"/>	Chamber D (IC:22541-1)
<input type="checkbox"/>	Chamber B (IC:2324B-2)	<input type="checkbox"/>	Chamber E (IC: 22541-2)
<input type="checkbox"/>	Chamber C (IC:2324B-3)	<input checked="" type="checkbox"/>	Chamber F (IC: 22541-3)
		<input checked="" type="checkbox"/>	Chamber G (IC: 22541-4)
		<input type="checkbox"/>	Chamber H (IC: 22541-5)

The above test sites and facilities are covered under FCC Test Firm Registration # 208313.

UL Verification Services Inc. is accredited by NVLAP, Laboratory Code 200065-0. The full scope of accreditation can be viewed at <http://ts.nist.gov/standards/scopes/2000650.htm>.

4. CALIBRATION AND UNCERTAINTY

4.1. MEASURING INSTRUMENT CALIBRATION

The measuring equipment utilized to perform the tests documented in this report has been calibrated in accordance with the manufacturer's recommendations, and is traceable to recognized national standards.

4.2. SAMPLE CALCULATION

Where relevant, the following sample calculation is provided:
 Field Strength (dBuV/m) = Measured Voltage (dBuV) + Antenna Factor (dB/m) + Cable Loss (dB) – Preamp Gain (dB)
 36.5 dBuV + 18.7 dB/m + 0.6 dB – 26.9 dB = 28.9 dBuV/m

4.3. MEASUREMENT UNCERTAINTY

Where relevant, the following measurement uncertainty levels have been estimated for tests performed on the apparatus:

Parameter	Uncertainty
Worst Case Conducted Disturbance, 9KHz to 0.15 MHz	3.84 dB
Worst Case Conducted Disturbance, 0.15 to 30 MHz	3.65 dB
Worst Case Radiated Disturbance, 9KHz to 30 MHz	3.15 dB
Worst Case Radiated Disturbance, 30 to 1000 MHz	5.36 dB
Worst Case Radiated Disturbance, 1000 to 18000 MHz	4.32 dB
Worst Case Radiated Disturbance, 18000 to 26000 MHz	4.45 dB
Worst Case Radiated Disturbance, 26000 to 40000 MHz	5.24 dB
Occupied Channel Bandwidth	±0.39 %

Uncertainty figures are valid to a confidence level of 95%.

5. EQUIPMENT UNDER TEST

5.1. DESCRIPTION OF EUT

The equipment under test is a mobile phone with GSM, GPRS, EGPRS, UMTS, LTE and TD-SCDMA technologies. It also supports IEEE 802.11a/b/g/n/ac, Bluetooth®, GPS and NFC. The device has a built-in inductive charging receiver which is not user accessible. The rechargeable battery is not user accessible.

5.2. DIFFERENCE IN MODEL NUMBER

Model A1864 and A1899 are exactly the same. Two models numbers are allocated for marketing and logistic purpose only.

5.3. MAXIMUM OUTPUT POWER

The transmitter has a maximum conducted peak output power as follows:

Frequency Range (MHz)	Mode	Output Power (dBm)	Output Power (mW)
2412 - 2472	802.11b 1TX	24.85	305.49
2412 - 2472	802.11g 1TX	Covered by HT20 1TX	
2412 - 2472	802.11g 2TX	Covered by HT20 2TX CDD	
2412 - 2472	802.11n HT20 1TX	27.56	570.16
2412 - 2472	802.11n HT20 2TX CDD	29.75	944.06

5.4. DESCRIPTION OF AVAILABLE ANTENNAS

Frequency Band (GHz)	Antenna Gain (dBi)	
	UAT 1 (Primary)	LAT 3 (Diversity)
2.4	1.01	-2.24

5.5. SOFTWARE AND FIRMWARE

The firmware installed in the EUT during testing was version 13.10.452.12

5.6. WORST-CASE CONFIGURATION AND MODE

Radiated band edge, harmonic, and spurious emissions from 1GHz to 18GHz were performed with the EUT set to transmit at highest power on Low/Middle/High channels.

Radiated emissions below 30MHz, below 1GHz, above 18GHz and power line conducted emissions were performed with the EUT transmits at the channel with the highest output power as worst-case scenario.

For g and HT20 modes, radiated harmonics spurious and power line conducted emissions were performed with the EUT set at the CDD mode among the CDD/STBC/SDM modes with power setting equal or higher than SISO modes as worst-case scenario

The fundamental of the EUT was investigated in three orthogonal orientations X/Y/Z on both UAT 1 and LAT 3 antennas, In addition, the EUT was also investigated with and without AC/DC charger, headphones & laptop. It was determined that Y (Landscape) orientation was the worst-case orientation for both antennas without AC/DC charger, headphones, or laptop; therefore, all final radiated testing was performed with EUT only in Y orientation for 1 - 18GHz and 18 – 26GHz. EUT was tested with AC/DC charger for 30MHz – 1000MHz testin

Worst-case data rates as provided by the client were:

802.11b mode: 1 Mbps
802.11g mode: 6 Mbps
802.11n HT20mode: MCS0

The following modes have the same target power and use the same modulation (OFDM). Therefore, 802.11g 1TX and 802.11g 2TX are covered by 802.11n HT20 1TX and 802.11n HT20 2TX CDD respectively.

- 802.11g and 802.11n HT20 1TX
- 802.11g 2TX and 802.11n HT20 2TX CDD

For simultaneous transmission of multiple channels from the same antenna in the 2.4GHz and 5GHz bands, baseline was investigated for various configurations tested with the highest power. The result was determined to be the b mode and channel 36 combination transmission were the worst case.

There are two vendors of the WiFi/Bluetooth radio modules: variant 1 and variant 2. The Wi-Fi/Bluetooth radio modules have the same mechanical outline (e.g., the same package dimension and pin-out layout), use the same on-board antenna matching circuit, have an identical antenna structure, and are built and tested to conform to the same specifications and to operate within the same tolerances.

Baseline testing was performed on the two variants to determine the worst case on all conducted power and radiated emissions.

5.7. DESCRIPTION OF TEST SETUP

SUPPORT EQUIPMENT

Support Equipment List				
Description	Manufacturer	Model	Serial Number	FCC ID
Laptop AC/DC adapter	Liteon Technology	PA-1450-BA1	B123	NA
Laptop	Apple	MackBook Air 4	NA	NA

I/O CABLES (CONDUCTED TEST)

I/O Cable List						
Cable No	Port	# of identical ports	Connector Type	Cable Type	Cable Length (m)	Remarks
1	Antenna	1	SMA	Un-Shielded	0.2	To spectrum Analyzer
2	USB	1	USB	Shielded	1	N/A
3	AC	1	AC	Un-shielded	3	N/A

I/O CABLES (RADIATED ABOVE 1 GHZ)

I/O Cable List						
Cable No	Port	# of identical ports	Connector Type	Cable Type	Cable Length (m)	Remarks
NA						

I/O CABLES (AC POWER CONDUCTED TEST AND BELOW 1 GHZ)

I/O Cable List						
Cable No	Port	# of identical ports	Connector Type	Cable Type	Cable Length (m)	Remarks
1	AC	1	AC	Un-shielded	3	N/A

I/O CABLES (AC LINE CONDUCTED: LAPTOP CONFIGUARTION)

I/O Cable List						
Cable No	Port	# of identical	Connector Type	Cable Type	Cable Length (m)	Remarks
1	AC	1	AC	Un-shielded	3	N/A
2	USB	1	USB	Shielded	1	N/A

TEST SETUP

The EUT was tested connected to a host Laptop via USB cable adapter and spectrum analyzer to antenna port. Test software exercised the EUT.

SETUP DIAGRAM

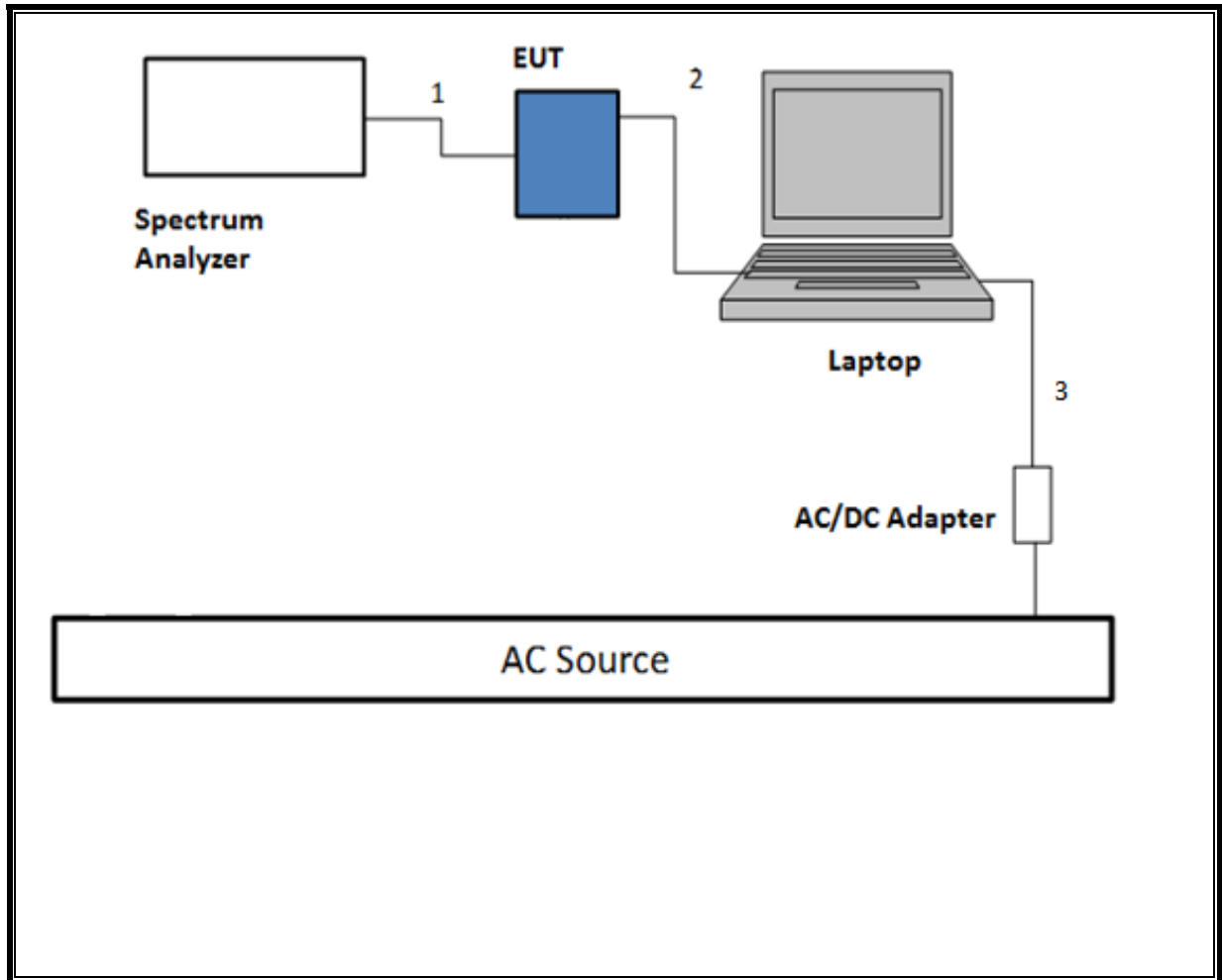

TEST SETUP- RADIATED-ABOVE 1 GHZ

The EUT was powered by battery. Test software exercised the EUT.

SETUP DIAGRAM

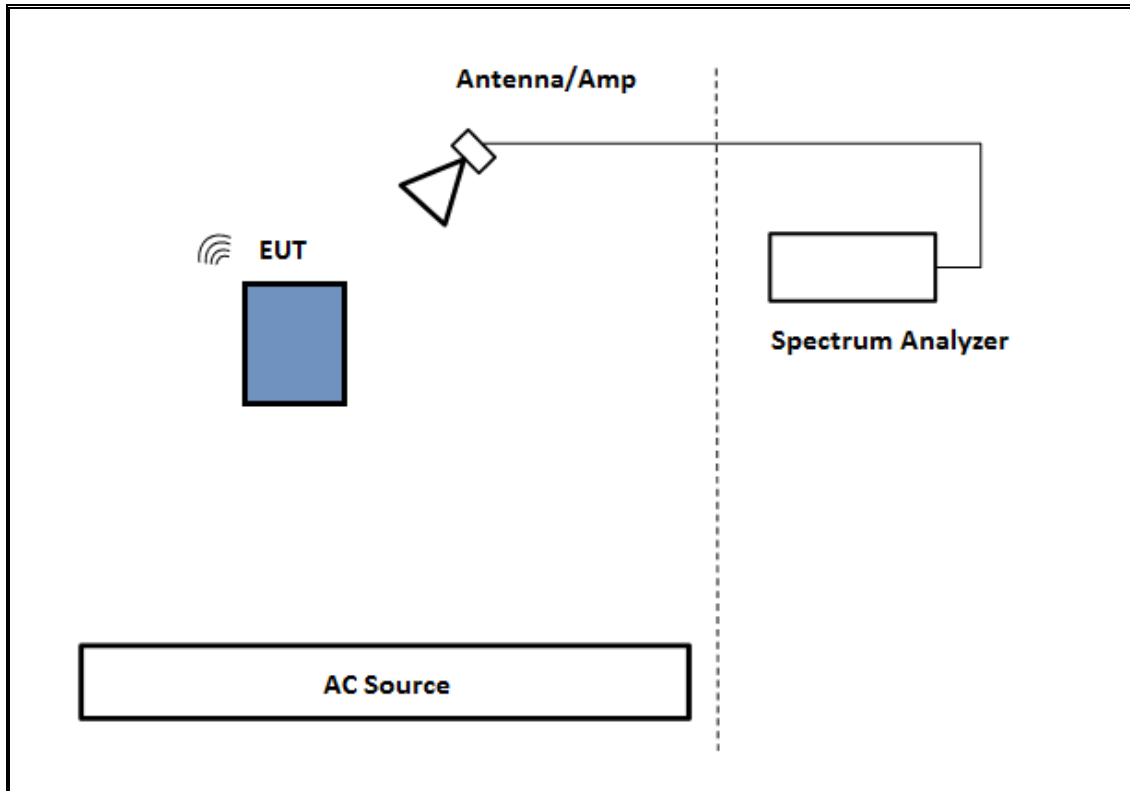

TEST SETUP- BELOW 1GHZ & AC LINE CONDUCTED TESTS

The EUT was powered by AC/DC adapter. Test software exercised the EUT.

SETUP DIAGRAM

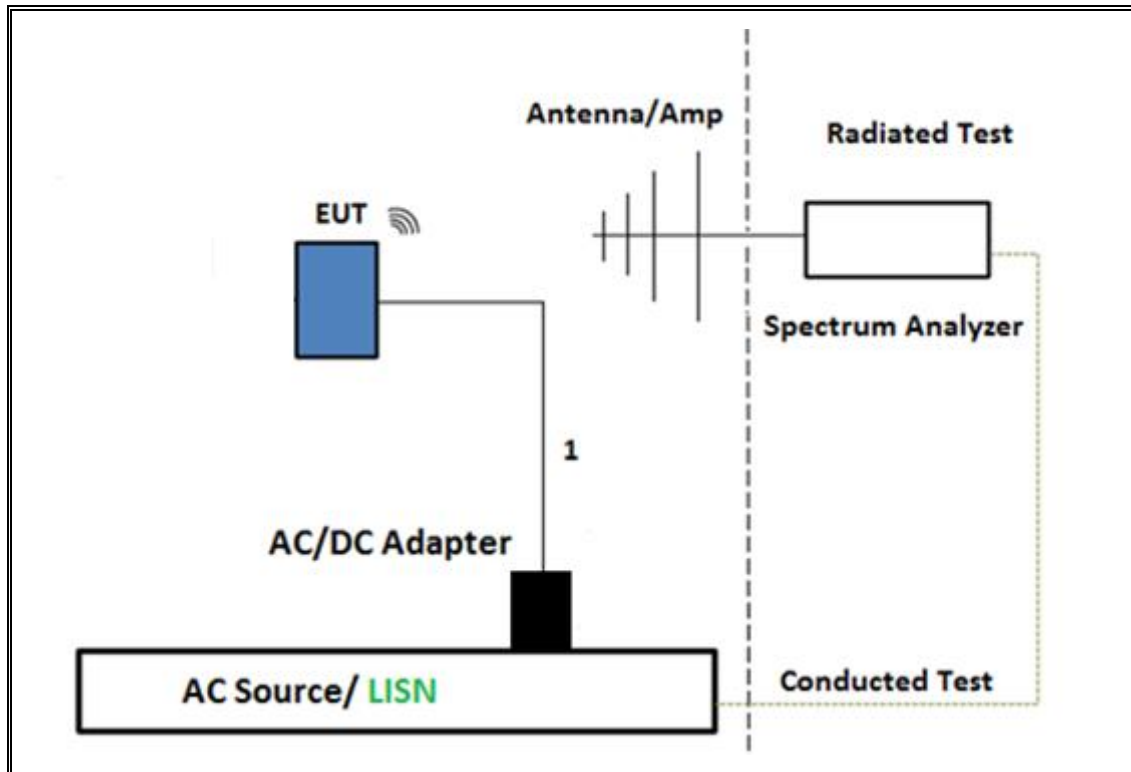

TEST SETUP- AC LINE CONDUCTED TEST (LAPTOP CONFIGURATION)

The EUT was tested connected to a host Laptop via USB cable adapter and spectrum analyzer to antenna port. Test software exercised the EUT.

SETUP DIAGRAM

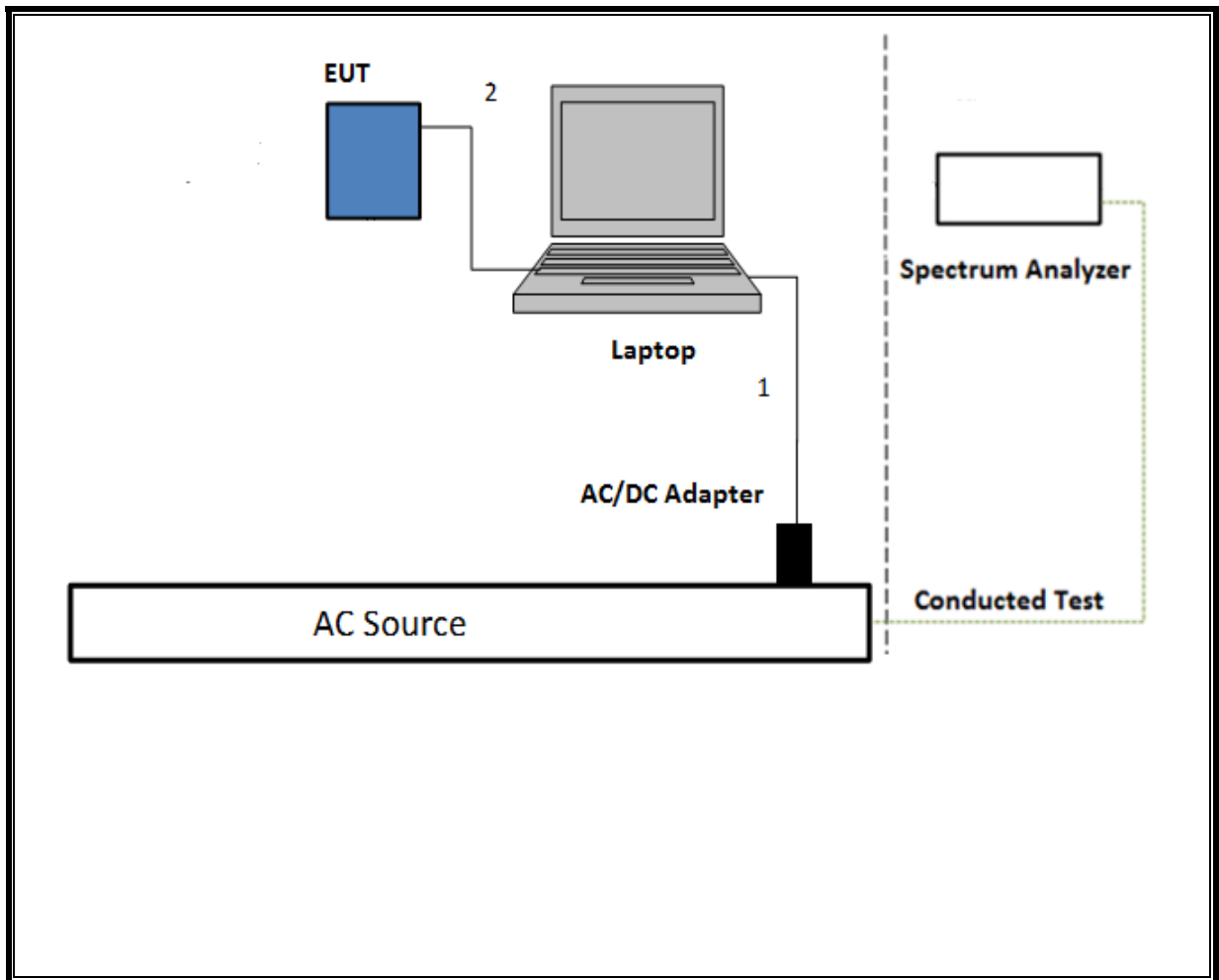

5.8. DESCRIPTION OF TEST SETUP

SUPPORT EQUIPMENT

Support Equipment List				
Description	Manufacturer	Model	Serial Number	FCC ID
Laptop AC/DC adapter	Liteon Technology	PA-1450-BA1	B123	NA
Laptop	Apple	MackBook Air 4	NA	NA
Dongle	N/A	N/A	HDG1409226823	NA

I/O CABLES (CONDUCTED TEST)

I/O Cable List						
Cable No	Port	# of identical ports	Connector Type	Cable Type	Cable Length (m)	Remarks
1	Antenna	1	SMA	Un-Shielded	0.2	To spectrum Analyzer
2	USB	1	USB	Shielded	1	N/A
3	AC	1	AC	Un-shielded	3	N/A

I/O CABLES (RADIATED ABOVE 1 GHZ)

I/O Cable List						
Cable No	Port	# of identical ports	Connector Type	Cable Type	Cable Length (m)	Remarks
None Used						

I/O CABLES (AC POWER CONDUCTED TEST AND BELOW 1 GHZ)

I/O Cable List						
Cable No	Port	# of identical ports	Connector Type	Cable Type	Cable Length (m)	Remarks
1	AC	1	AC	Un-shielded	3	N/A

TEST SETUP

The EUT was tested connected to a host Laptop via USB cable adapter and spectrum analyzer to antenna port. Test software exercised the EUT.

SETUP DIAGRAM

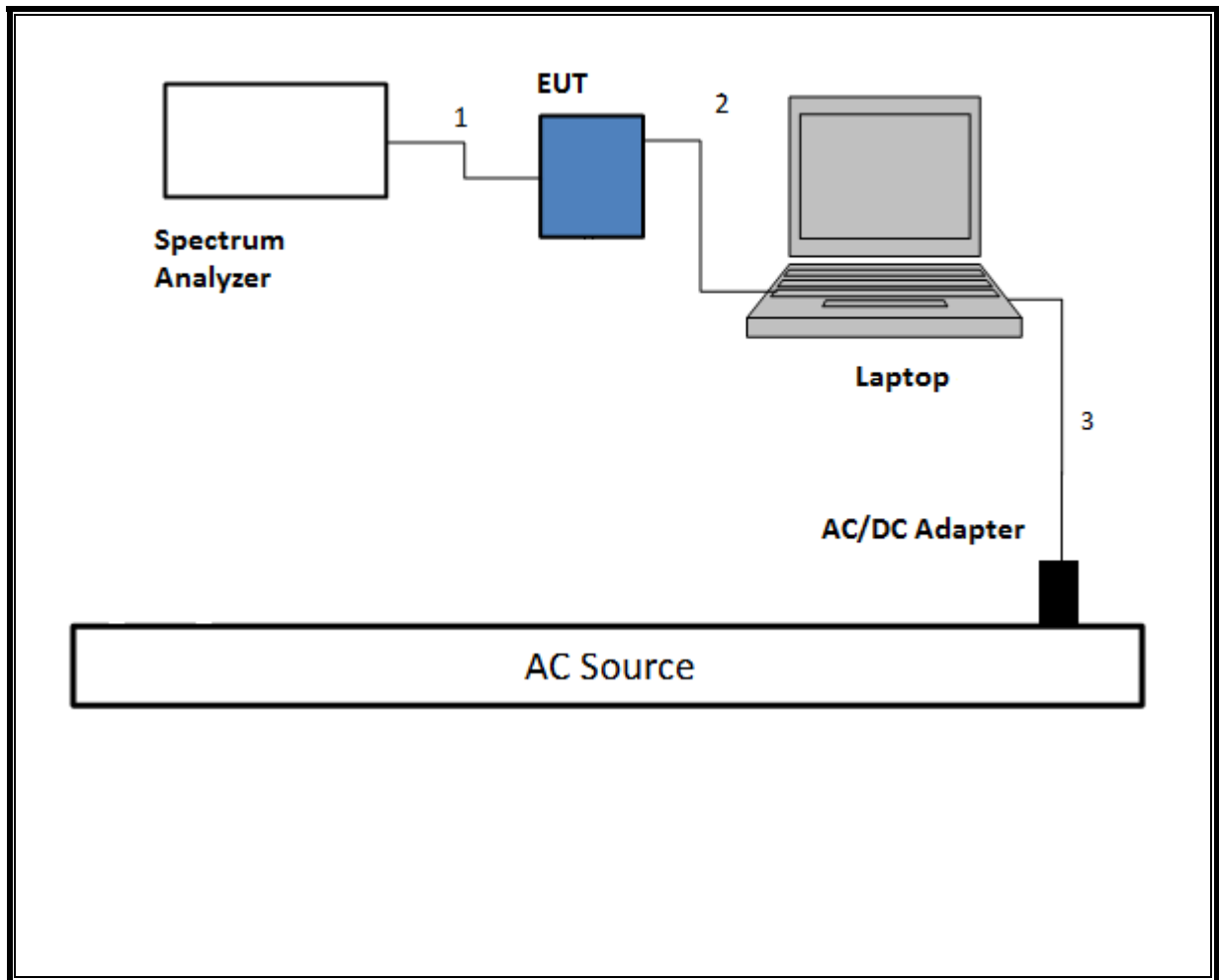

TEST SETUP- RADIATED-ABOVE 1 GHZ

The EUT was tested battery powered. Test software exercised the EUT.

SETUP DIAGRAM

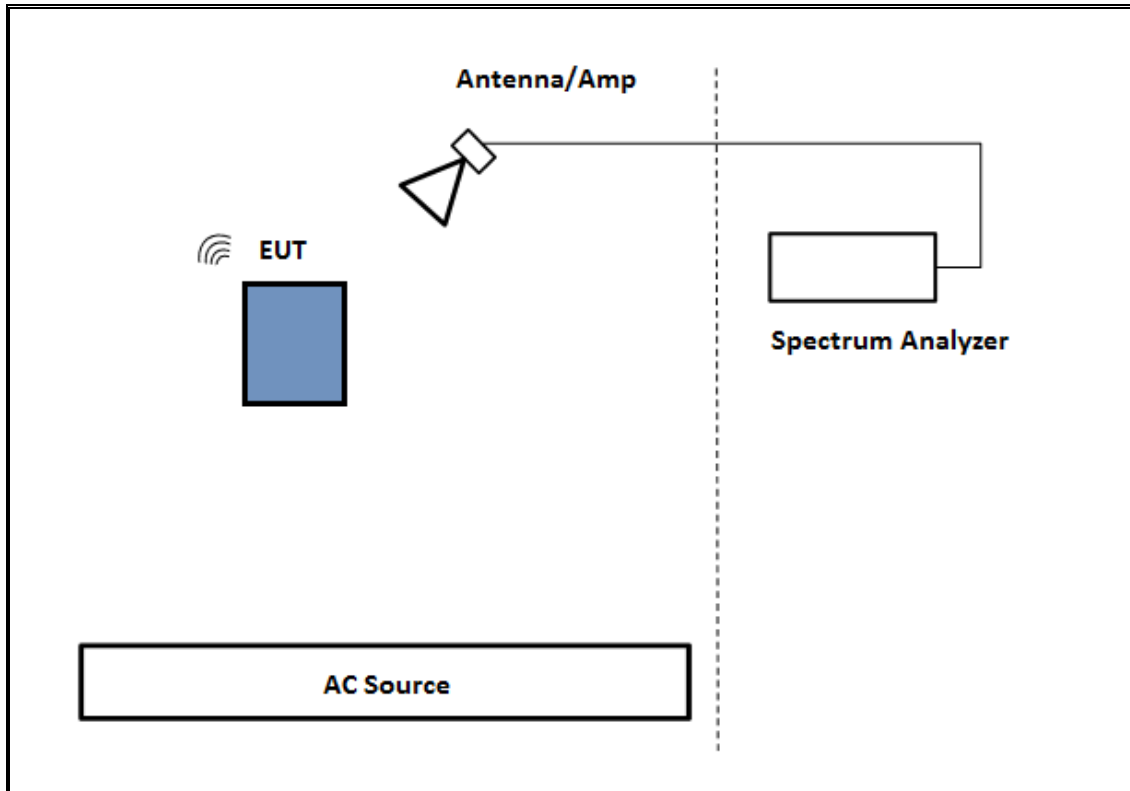

TEST SETUP- BELOW 1GHZ & AC LINE CONDUCTED TESTS

The EUT was powered by AC/DC adapter. Test software exercised the EUT.

SETUP DIAGRAM

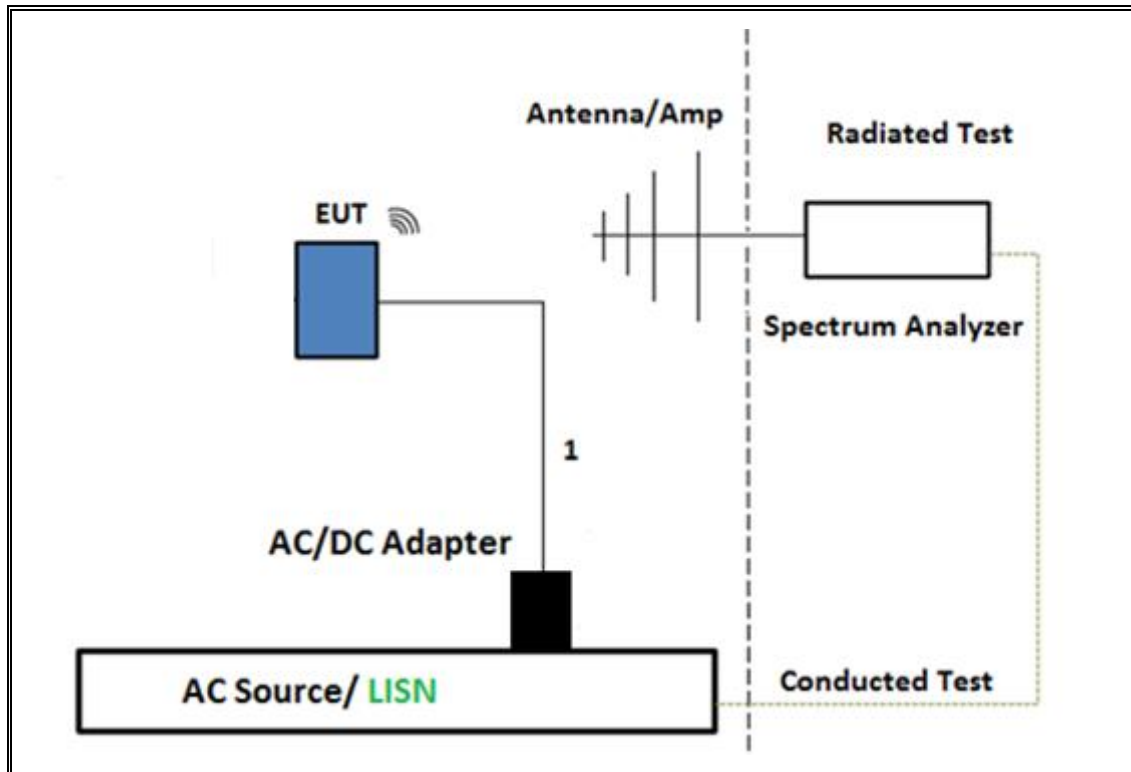

6. TEST AND MEASUREMENT EQUIPMENT

The following test and measurement equipment was utilized for the tests documented in this report:

TEST EQUIPMENT LIST				
Description	Manufacturer	Model	Asset	Cal Due
Antenna, Horn 1-18GHz	ETS Lindgren	3117	T862	4/20/2018
Amplifier, 1 to 18GHz	Miteq	AFS42-00101800-25-S-42	T740	11/29/17
Spectrum Analyzer, PXA 3Hz to 44GHz	Keysight	N9030A	T340	12/14/2017
Antenna, Horn 1-18GHz	ETS Lindgren	3117	T119	3/28/2018
Antenna, Broadband Hybrid, 30MHz to 2000MHz	Sunol Sciences	JB1	T122	1/31/2018
Amplifier, 1 to 18GHz	Miteq	AFS42-00101800-25-S-42	T742	11/29/2017
*Amplifier, 10KHz to 1GHz, 32dB	Sonoma	310N	T173	6/17/2017
Spectrum Analyzer, PXA 3Hz to 44GHz	Keysight	N9030A	T1113	12/20/2017
Antenna, Horn 1-18GHz	ETS Lindgren	3117	T345	4/14/2018
*Amplifier, 1 to 18GHz	Miteq	AFS42-00101800-25-S-42	T491	5/31/2017
*Antenna Horn, 18 to 26GHz	ARA	MWH-1826	T447	6/16/2017
Spectrum Analyzer, 40GHz	Agilent	8564E	T106	9/7/2017
*Pre-Amp 18-26GHz	Agilent Technology	8449B	T404	7/5/2017
Spectrum Analyzer, PXA 3Hz to 44GHz	Keysight	N9030A-544	T341	10/25/2017
Power Meter, P-series single channel	Keysight	N1912A	T1245	1/05/2018
Power Sensor	Keysight	N1921A	T1224	1/31/2018
Spectrum Analyzer, PXA, 3Hz to 44GHz	Agilent (Keysight) Technologies	N9030A	T339	09/22/2017
AC Line Conducted				
EMI Test Receiver 9Khz-7GHz	Rohde & Schwarz	ESCI7	T1436	01/06/2018
*LISN for Conducted Emissions CISPR-16	Fischer	50/250-25-2-01	T1310	06/08/2017
Power Cable, Line Conducted Emissions	UL	PG1	T861	9/1/2017
UL AUTOMATION SOFTWARE				
Radiated Software	UL	UL EMC	Ver 9.5, April 26, 2016	
Conducted Software	UL	UL EMC	Ver 5.4, October 13, 2016	
AC Line Conducted Software	UL	UL EMC	Ver 9.5, May 26, 2015	

NOTE: * Testing is completed before equipment calibration expiration date.

7. MEASUREMENT METHODS

6 dB BW: KDB 558074 D01 v04, Section 8.1.

Output Power: KDB 558074 D01 v04, Section 9.1.3.

Power Spectral Density: KDB 558074 D01 v04, Section 10.2.

Out-of-band emissions in non-restricted bands: KDB 558074 D01 v04, Section 11.0.

Out-of-band emissions in restricted bands: KDB 558074 D01 v04, Section 12.1.

Band-edge: KDB 558074 D01 v04, Section 12.1.

Conducted line emissions: C63.10, Clause 6.2

8. ANTENNA PORT TEST RESULTS

8.1. ON TIME AND DUTY CYCLE

LIMITS

None; for reporting purposes only.

PROCEDURE

KDB 558074 Zero-Span Spectrum Analyzer Method.

ON TIME AND DUTY CYCLE RESULTS

Mode	ON Time B (msec)	Period (msec)	Duty Cycle x (linear)	Duty Cycle (%)	Duty Cycle Correction Factor (dB)	1/B Minimum VBW (kHz)
2.4GHz Band						
802.11b 1TX	128.2	128.2	1.000	100.00%	0.00	0.010
802.11n HT20 1TX	1.913	1.938	0.987	98.71%	0.00	0.010
802.11n HT20 CDD	1.915	1.938	0.988	98.81%	0.00	0.010

DUTY CYCLE PLOTS

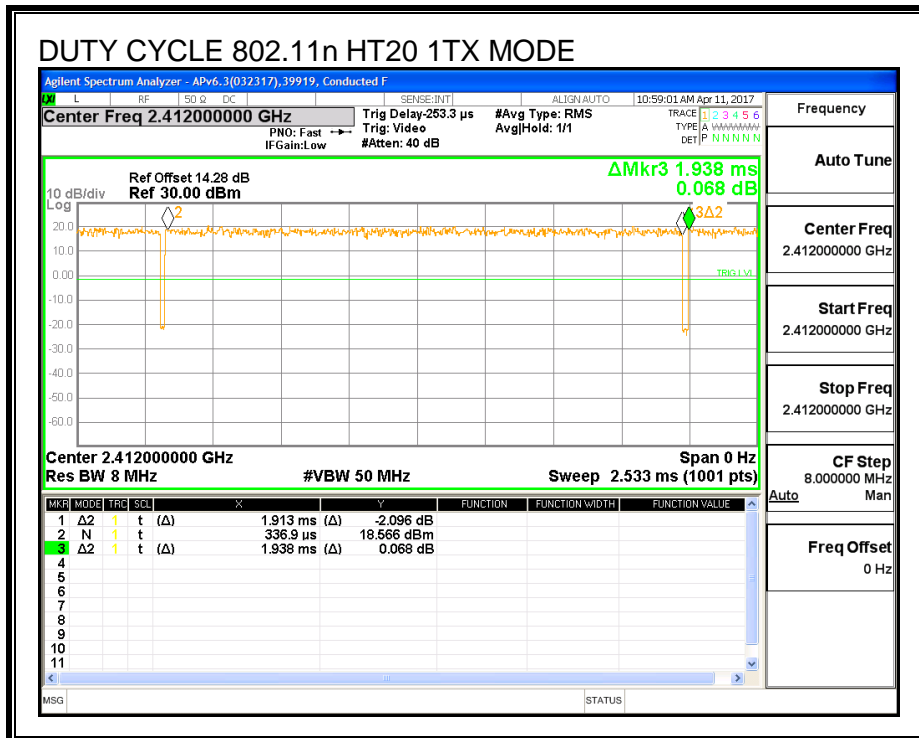
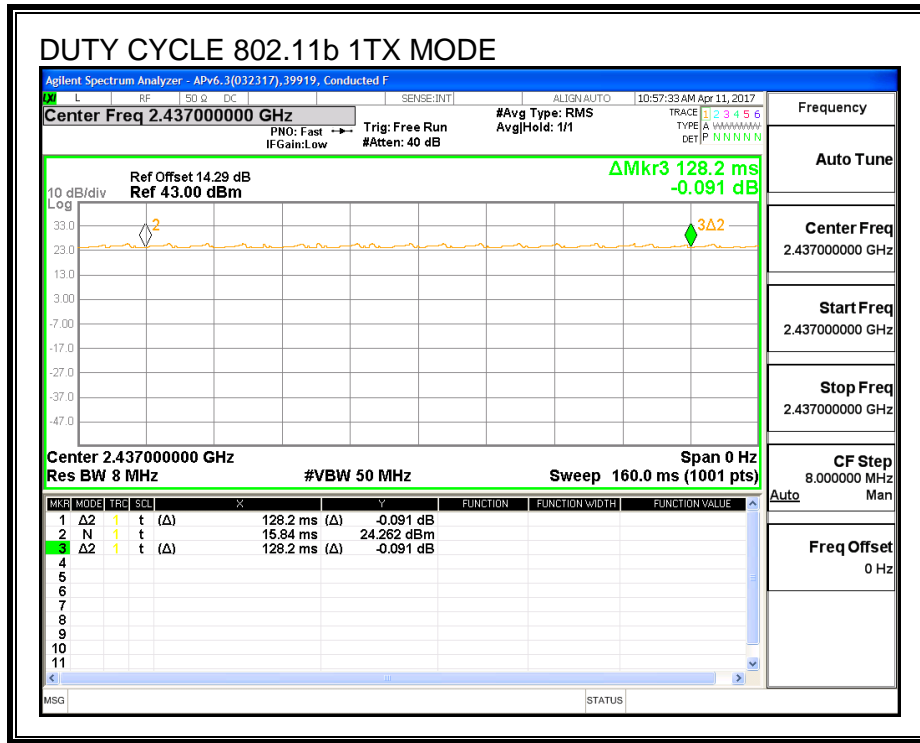

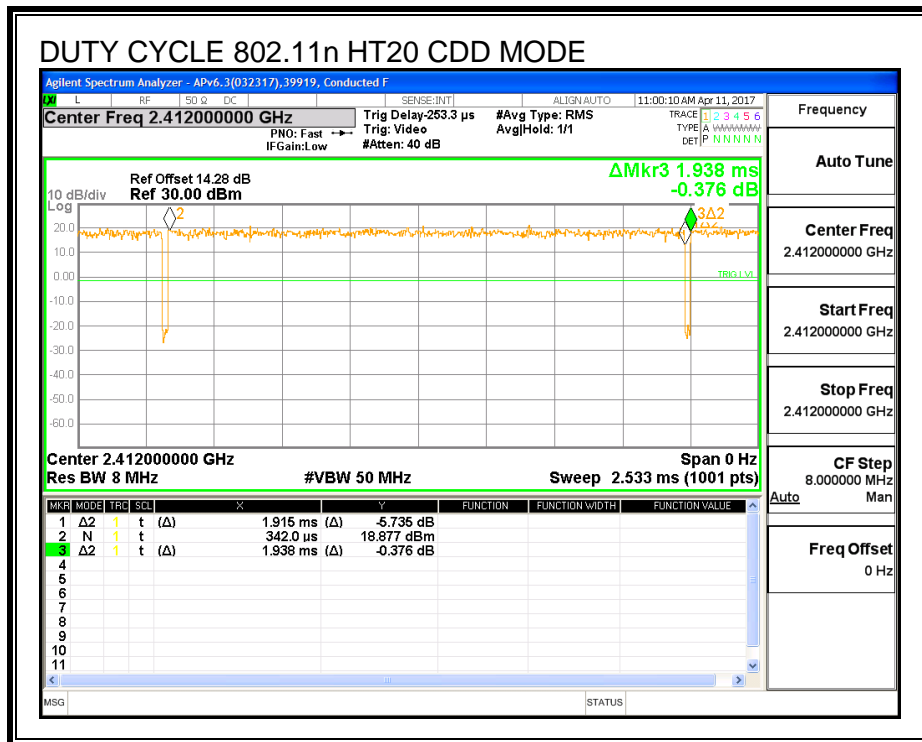

8.2. 11b UAT 1 SISO MODE IN THE 2.4GHz BAND

8.2.1. 6 dB BANDWIDTH

LIMITS

FCC §15.247 (a) (2)

IC RSS-247 (5.2) (a)

The minimum 6 dB bandwidth shall be at least 500 kHz.

RESULTS

Channel	Frequency	6 dB BW UAT 1 (MHz)	Minimum Limit (MHz)
Low_1	2412	8.540	0.5
Low_2	2417	9.01	0.5
Low_3	2422	8.54	0.5
Middle_6	2437	7.590	0.5
High_10	2457	6.575	0.5
High_11	2462	8.070	0.5
High_12	2467	8.060	0.5
High_13	2472	7.045	0.5

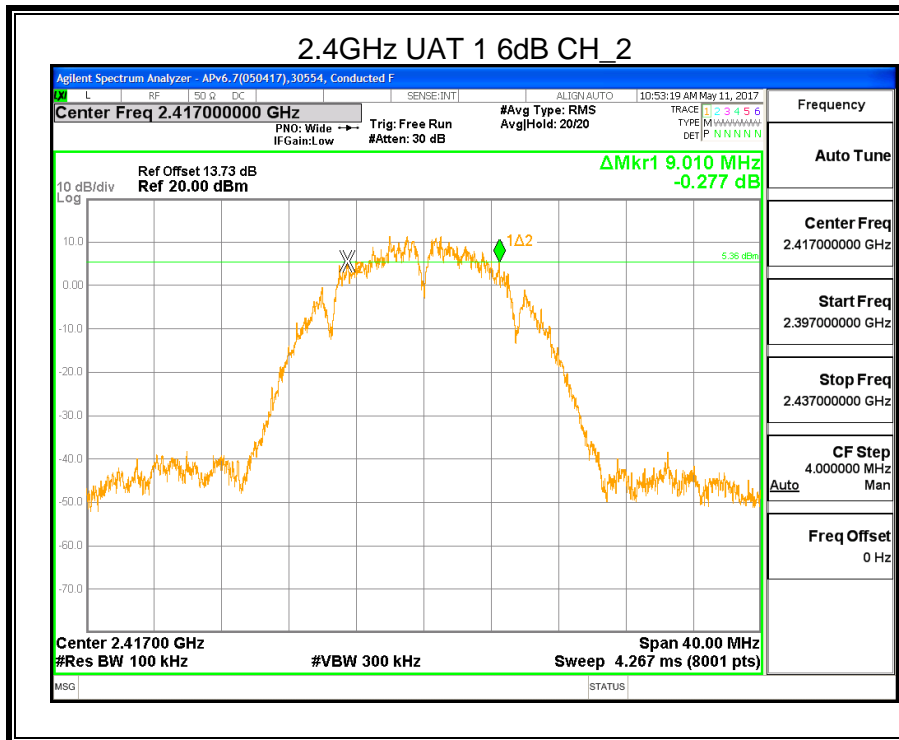
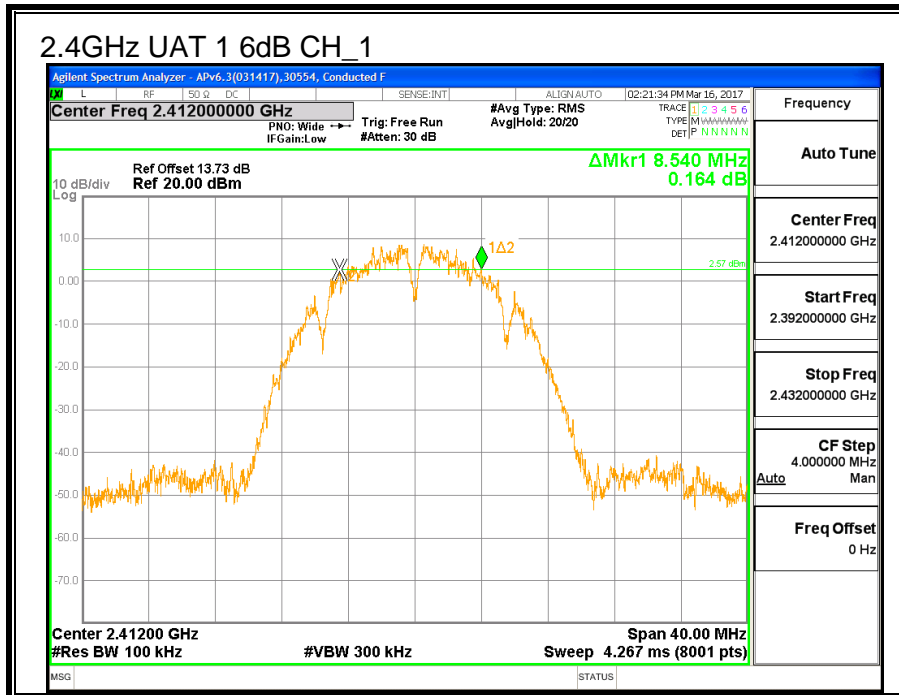

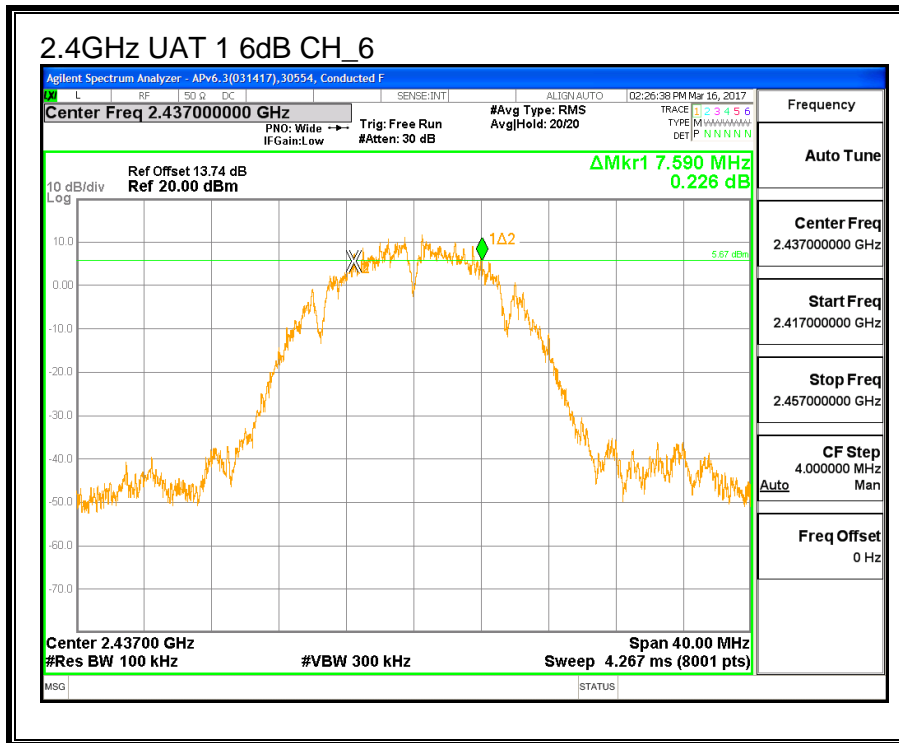
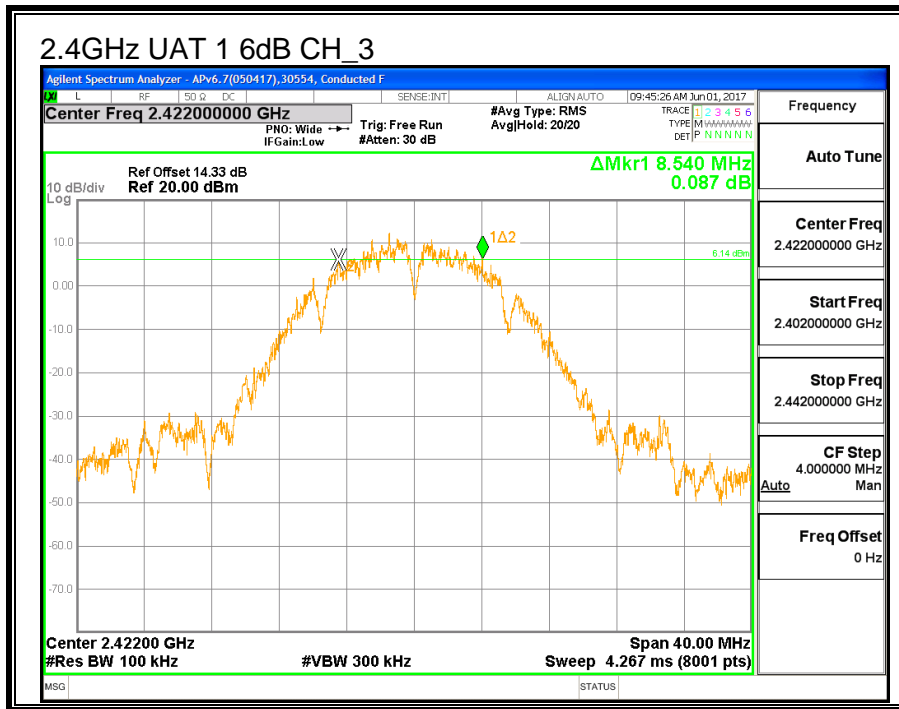

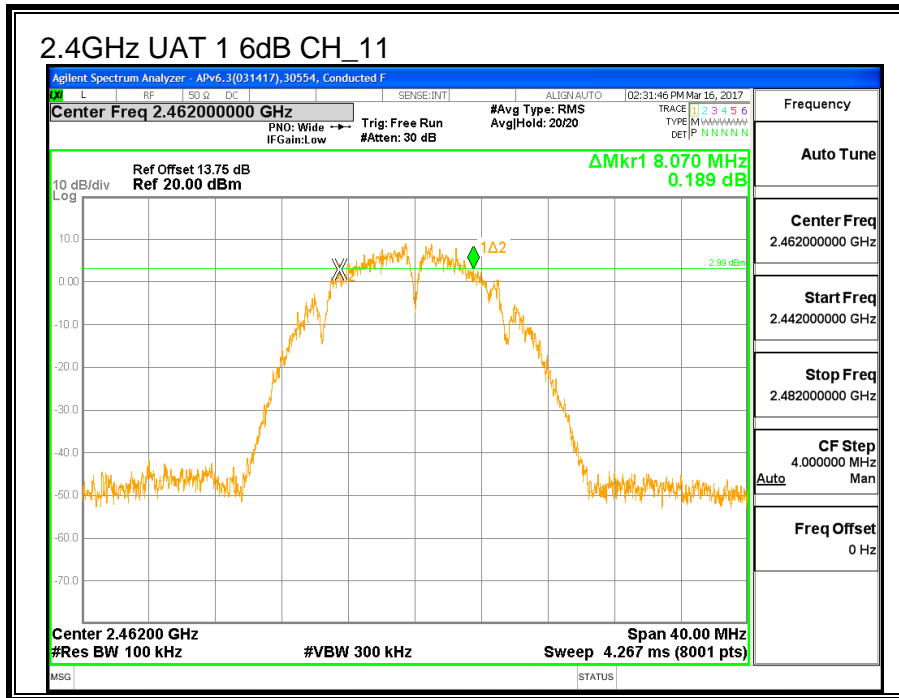
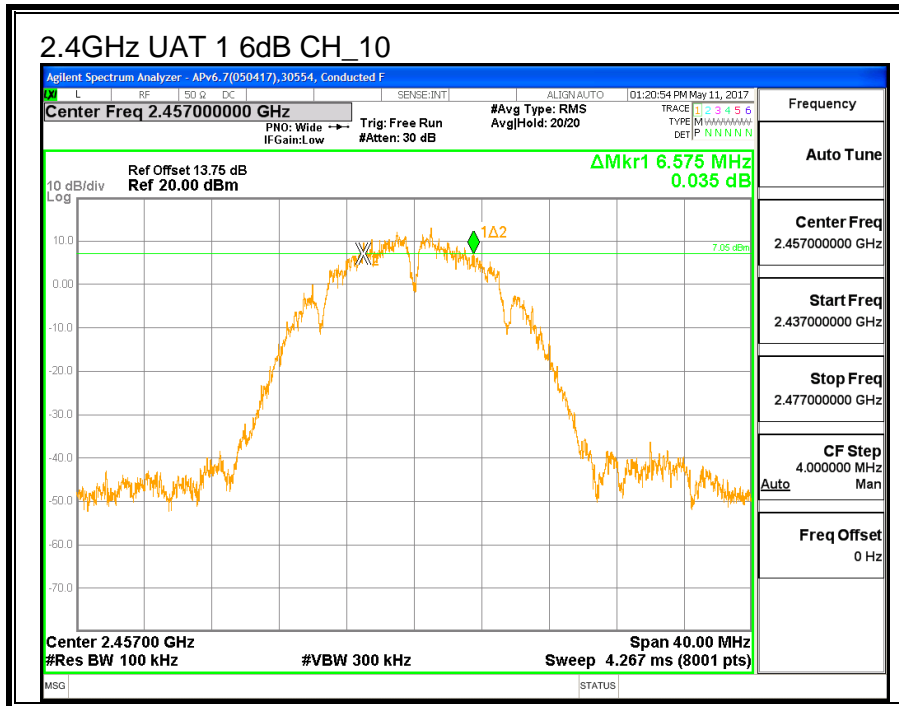

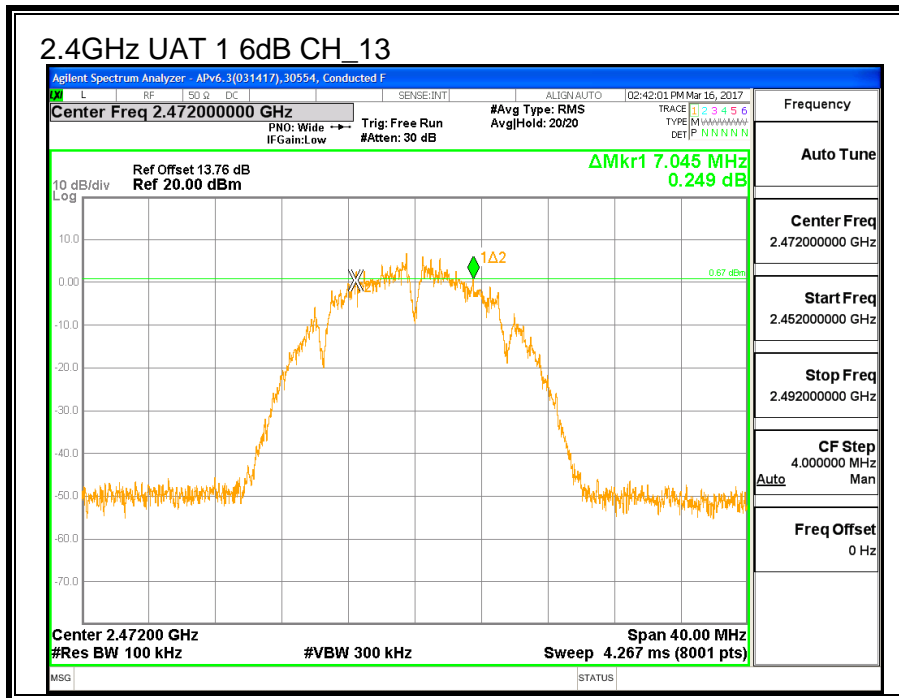
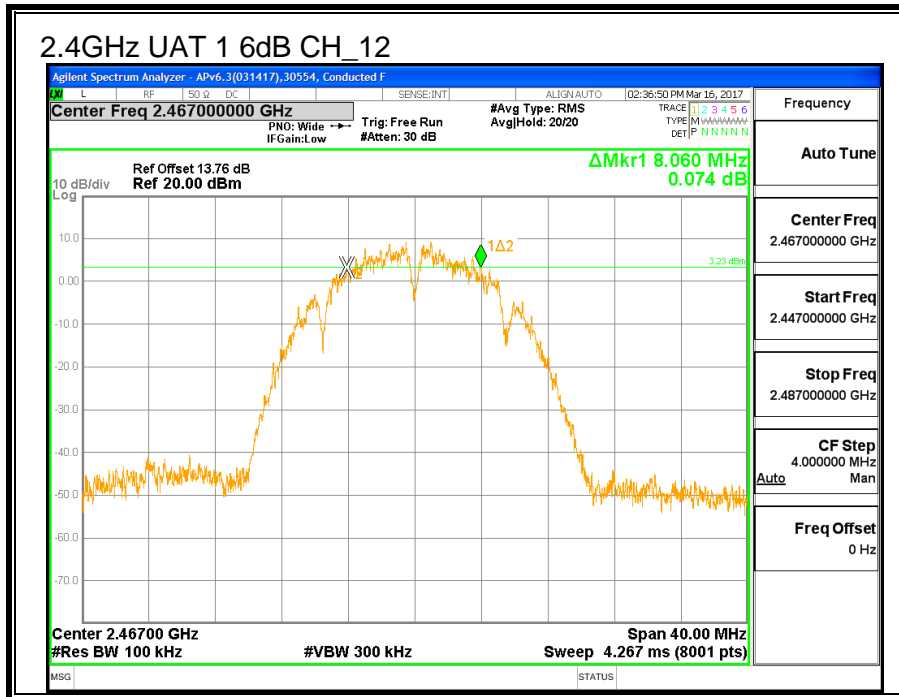

8.2.2. 99% BANDWIDTH

LIMITS

None; for reporting purposes only.

RESULTS

Channel	Frequency (MHz)	99% Bandwidth UAT 1 (MHz)
Low_1	2412	12.434
Low_2	2417	12.511
Low_3	2422	13.271
Middle_6	2437	12.645
High_10	2457	12.568
High_11	2462	12.271
High_12	2467	12.711
High_13	2472	12.529

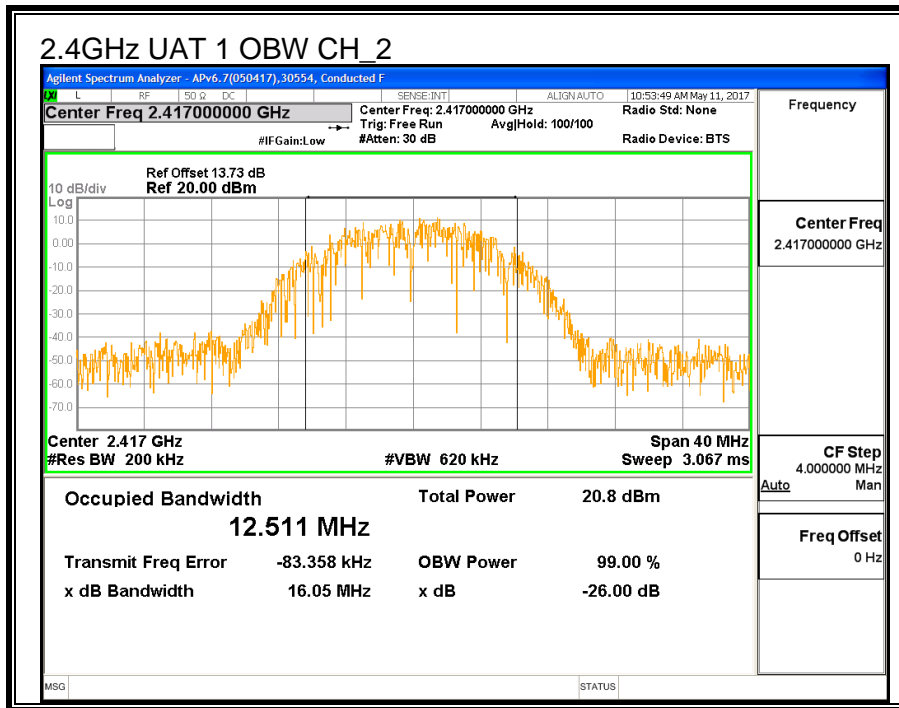
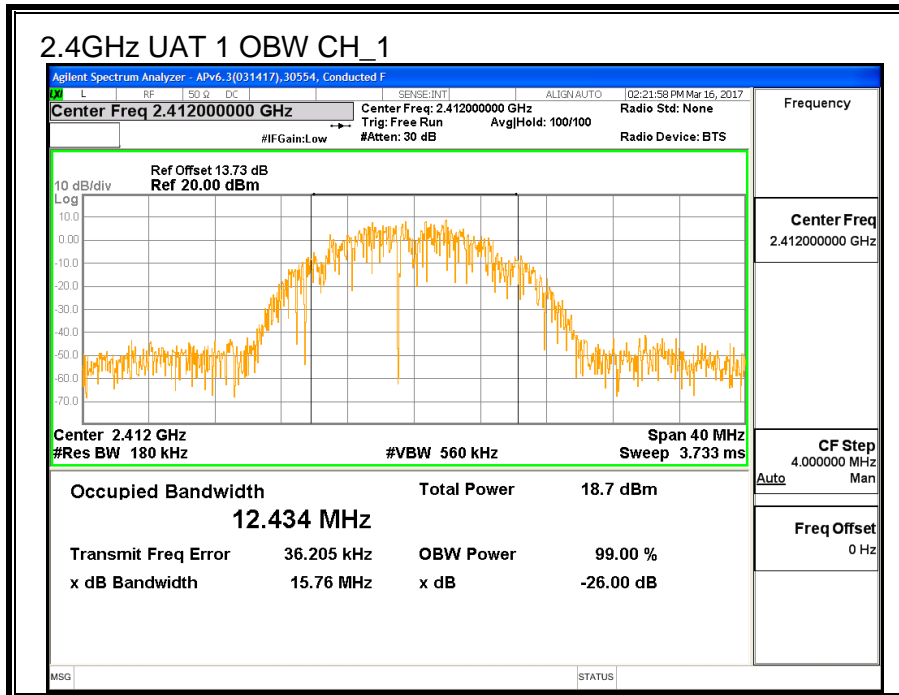

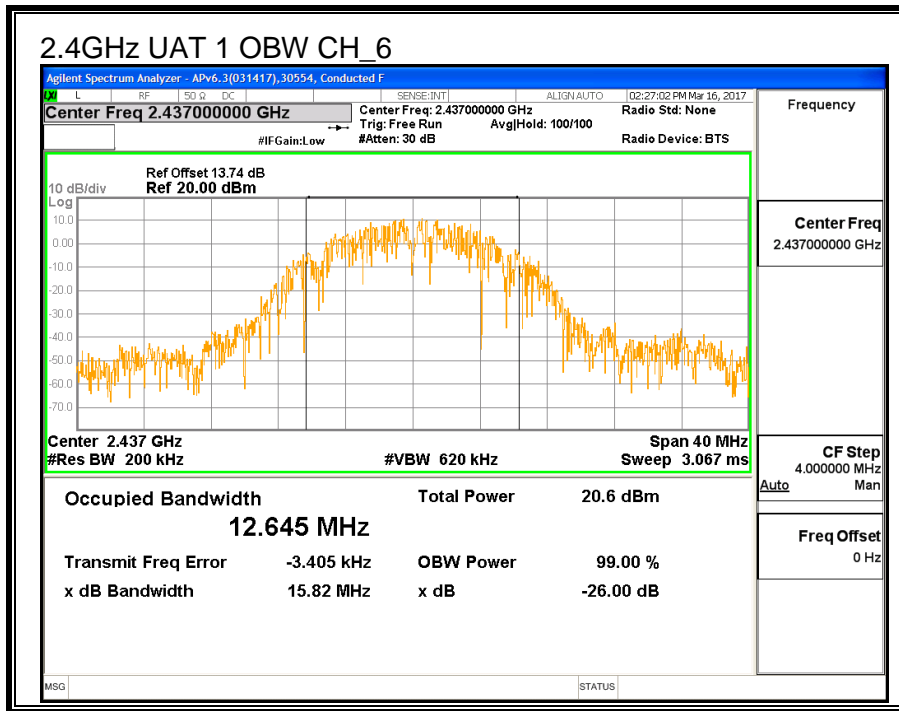
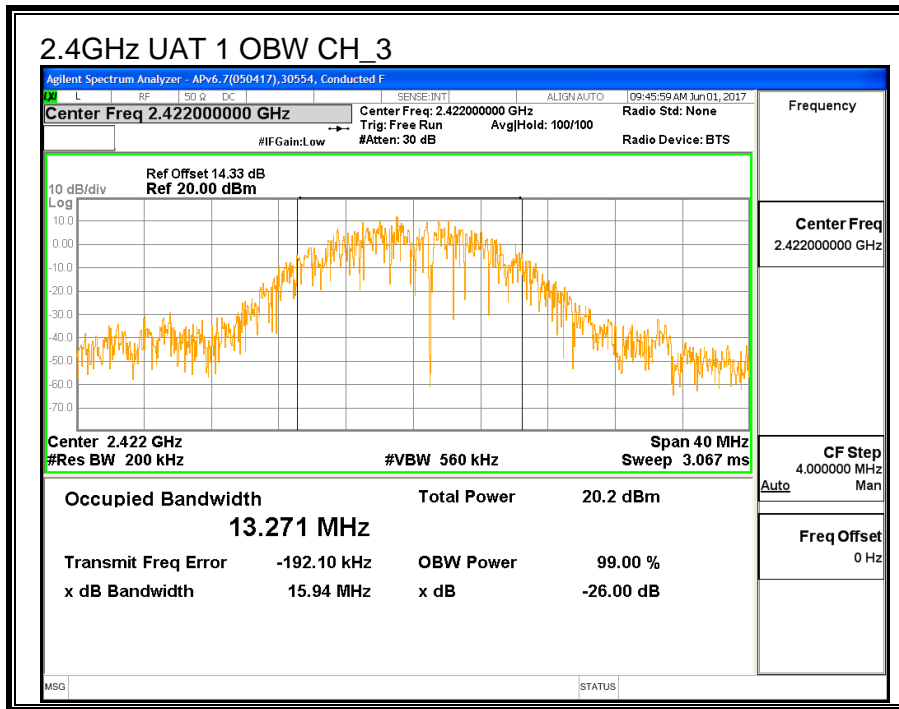

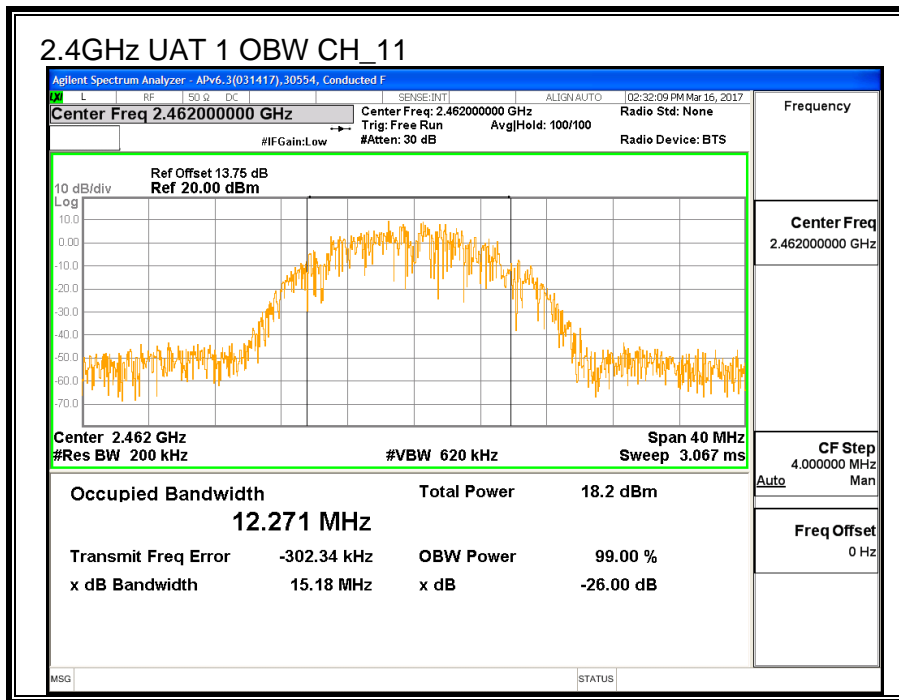
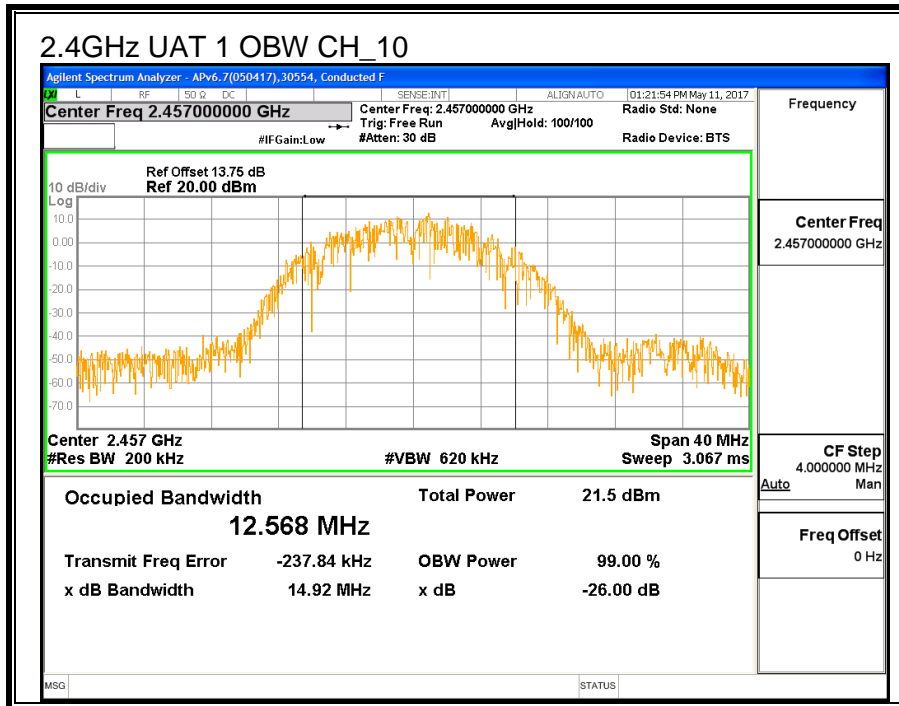

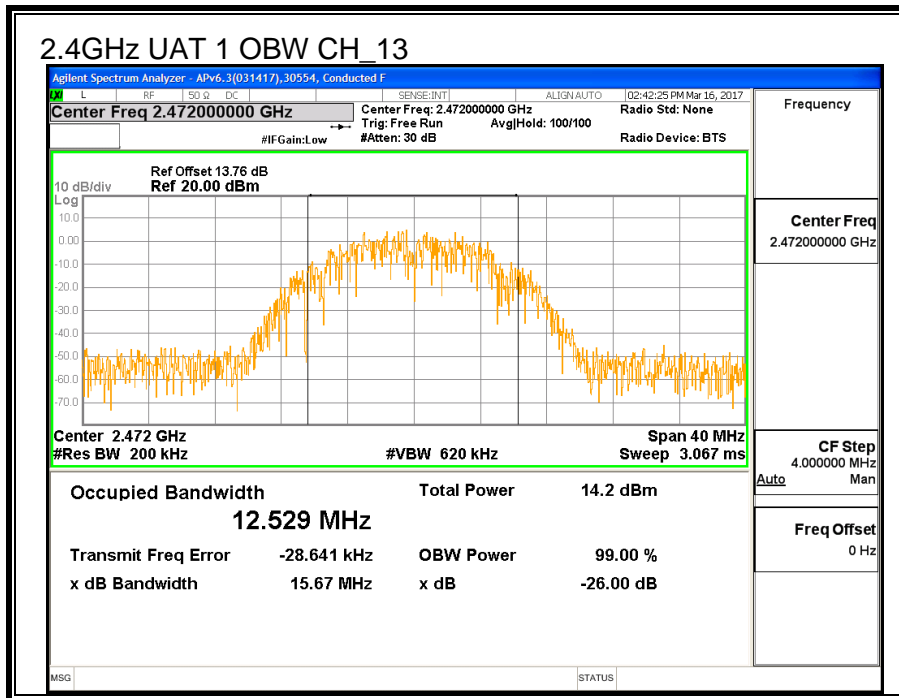
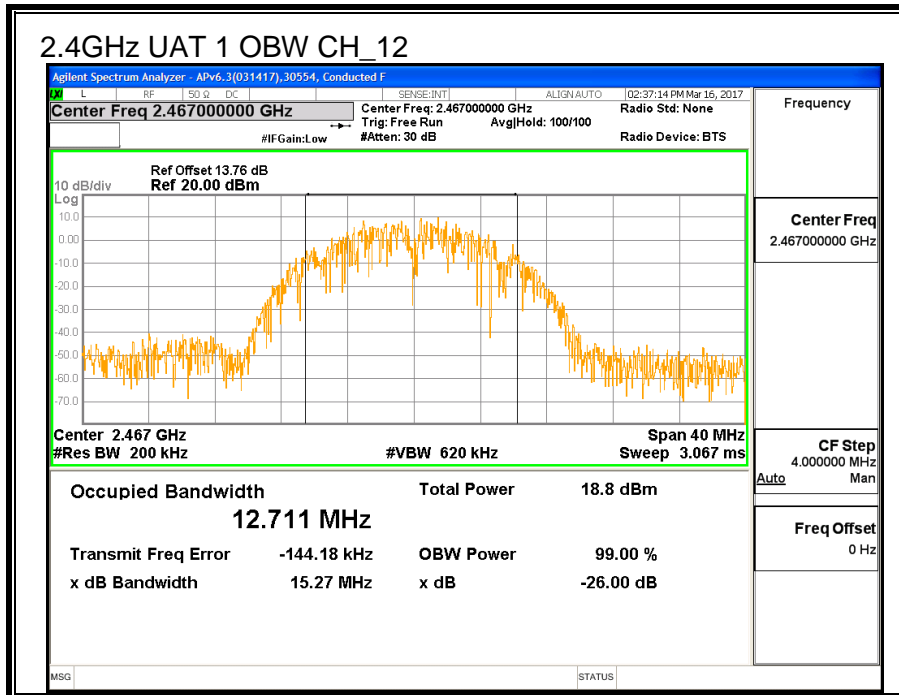

8.2.3. AVERAGE POWER

ID:	39472	Date:	7/07/17
------------	-------	--------------	---------

LIMITS

None; for reporting purposes only.

RESULTS

Channel	Frequency (MHz)	Power UAT 1 (MHz)
Low_1	2412	19.97
Low_2	2417	21.12
Low_3	2422	21.32
Middle_6	2437	21.35
High_10	2457	21.40
High_11	2462	20.78
High_12	2467	18.42
High_13	2472	14.75

8.2.4. OUTPUT POWER

ID:	30554	Date:	6/14/2017
------------	-------	--------------	-----------

LIMITS

FCC §15.247

IC RSS-247 (5.4) (d)

For systems using digital modulation in the 2400–2483.5 MHz, and 5725–5850 MHz bands: 1 Watt, based on the use of antennas with directional gains that do not exceed 6 dBi. If transmitting antennas of directional gain greater than 6 dBi are used, the conducted output power from the intentional radiator shall be reduced by the amount in dB that the directional gain of the antenna exceeds 6 dBi.

DIRECTIONAL ANTENNA GAIN

There is only one transmitter output therefore the directional gain is equal to the antenna gain.

RESULTS

Limits

Channel	Frequency (MHz)	Directional Gain (dBi)	FCC Power Limit (dBm)	IC Power Limit (dBm)	IC EIRP Limit (dBm)	Max Power (dBm)
Low_1	2412	1.01	30.00	30	36	30.00
Low_2	2417	1.01	30.00	30	36	30.00
Low_3	2422	1.01	30.00	30	36	30.00
Mid_6	2437	1.01	30.00	30	36	30.00
High_10	2457	1.01	30.00	30	36	30.00
High_11	2462	1.01	30.00	30	36	30.00
High_12	2467	1.01	30.00	30	36	30.00
High_13	2472	1.01	30.00	30	36	30.00

Duty Cycle CF (dB)	0.00	Included in Calculations of Corr'd Power
---------------------------	------	---

Results

Channel	Frequency (MHz)	Meas Power (dBm)	Total Corr'd Power (dBm)	Power Limit (dBm)	Margin (dB)
Low_1	2412	23.42	23.42	30.00	-6.58
Low_2	2417	24.57	24.57	30.00	-5.43
Low_3	2422	24.77	24.77	30.00	-5.23
Mid_6	2437	24.80	24.80	30.00	-5.20
High_10	2457	24.85	24.85	30.00	-5.15
High_11	2462	24.23	24.23	30.00	-5.77
High_12	2467	21.87	21.87	30.00	-8.13
High_13	2472	18.20	18.20	30.00	-11.80

8.2.5. POWER SPECTRAL DENSITY

LIMITS

FCC §15.247

IC RSS-247 (5.2) (b)

For digitally modulated systems, the power spectral density conducted from the intentional radiator to the antenna shall not be greater than 8 dBm in any 3 KHz band during any time interval of continuous transmissions.

RESULTS

Duty Cycle CF (dB)	0.00	Included in Calculations of Corr'd PSD
---------------------------	------	---

PSD Results

Channel	Frequency (MHz)	Meas (dBm/3kHz)	Total Corr'd PSD (dBm/3kHz)	Limit (dBm/3kHz)	Margin (dB)
Low_1	2412	-1.71	-1.71	8.0	-9.7
Low_2	2417	-2.06	-2.06	10.0	-12.1
Low_3	2422	-2.01	-2.01	10.0	-12.0
Mid_6	2437	-1.25	-1.25	8.0	-9.3
High_10	2457	0.54	0.54	8.0	-7.5
High_11	2462	-3.89	-3.89	8.0	-11.9
High_12	2467	-4.26	-4.26	8.0	-12.3
High_13	2472	-7.85	-7.85	8.0	-15.9

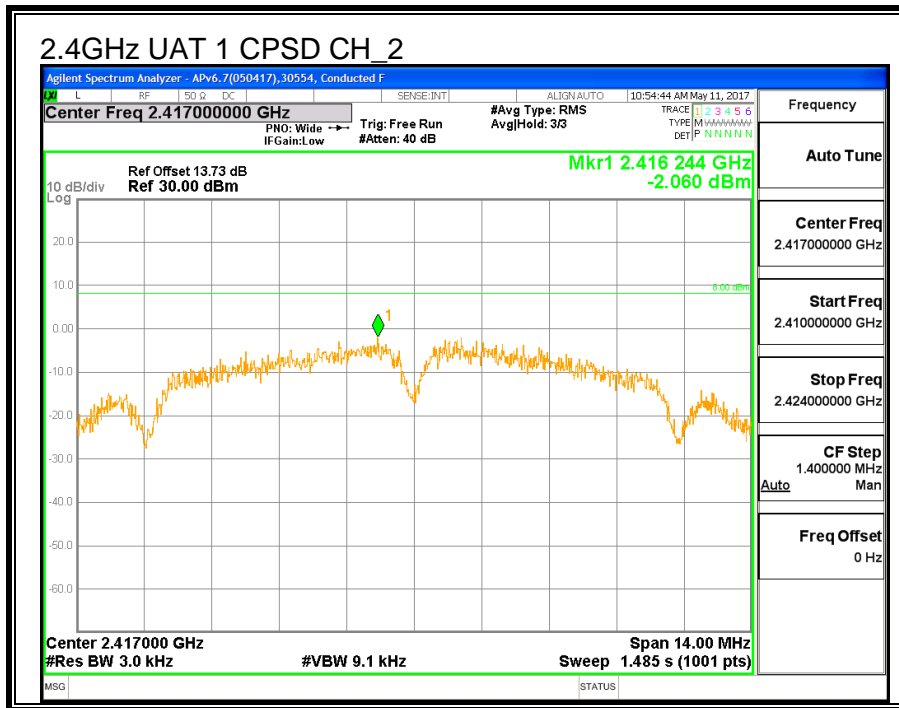
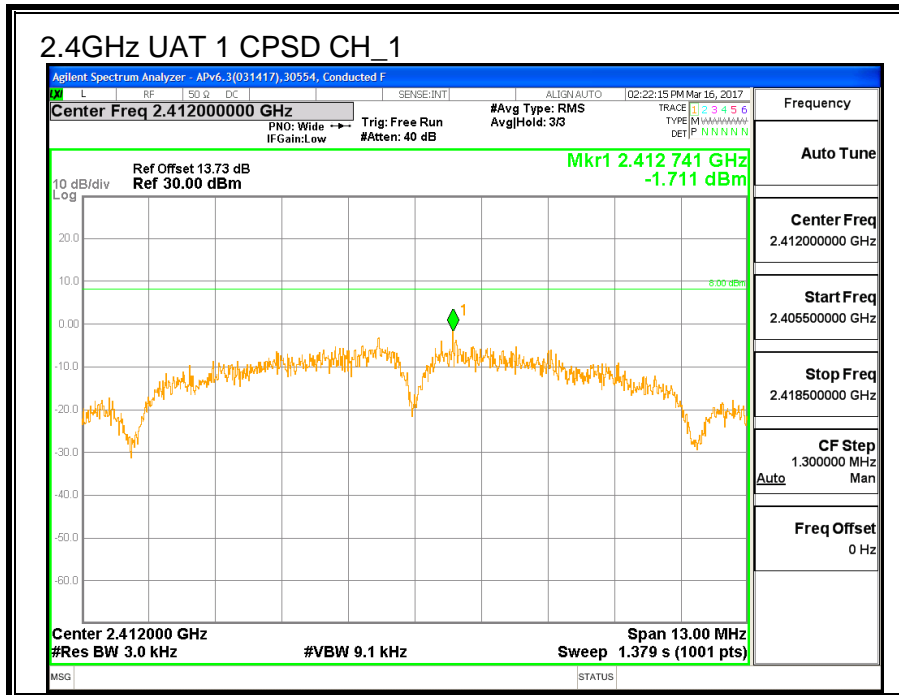

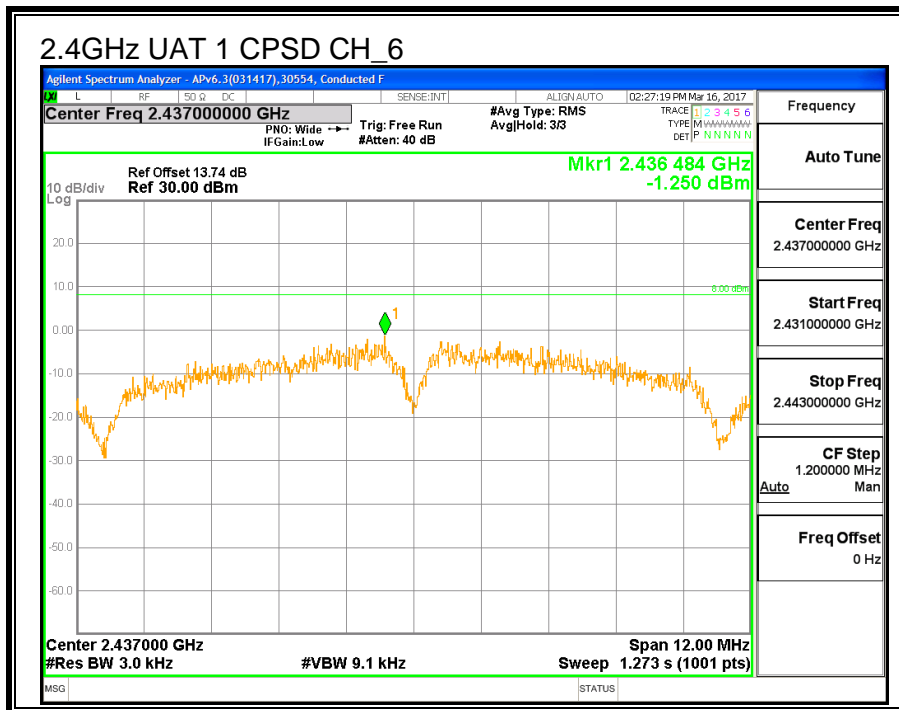
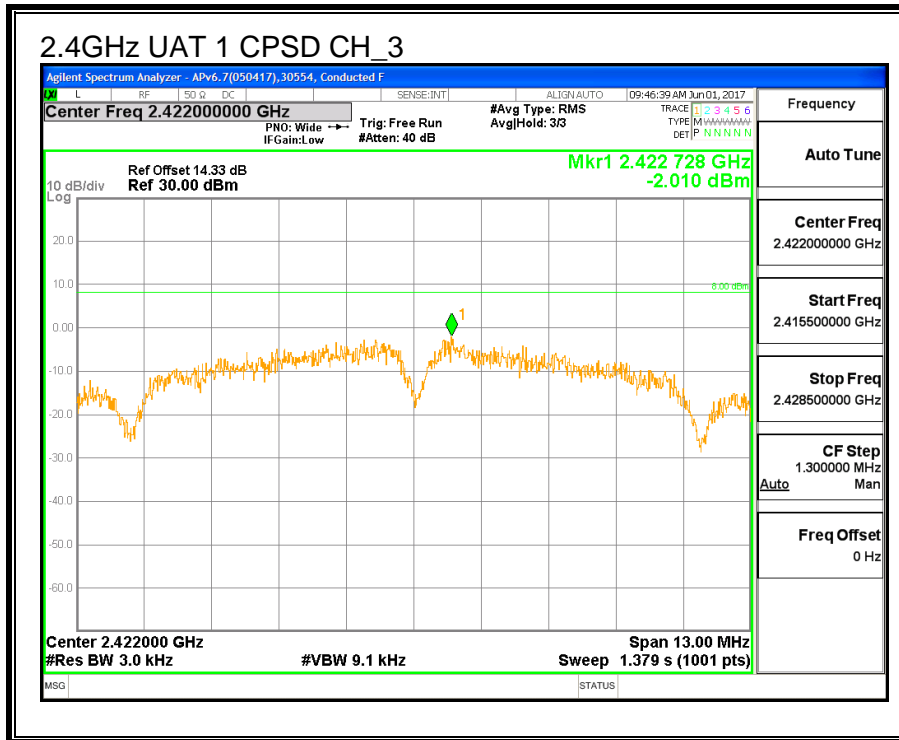

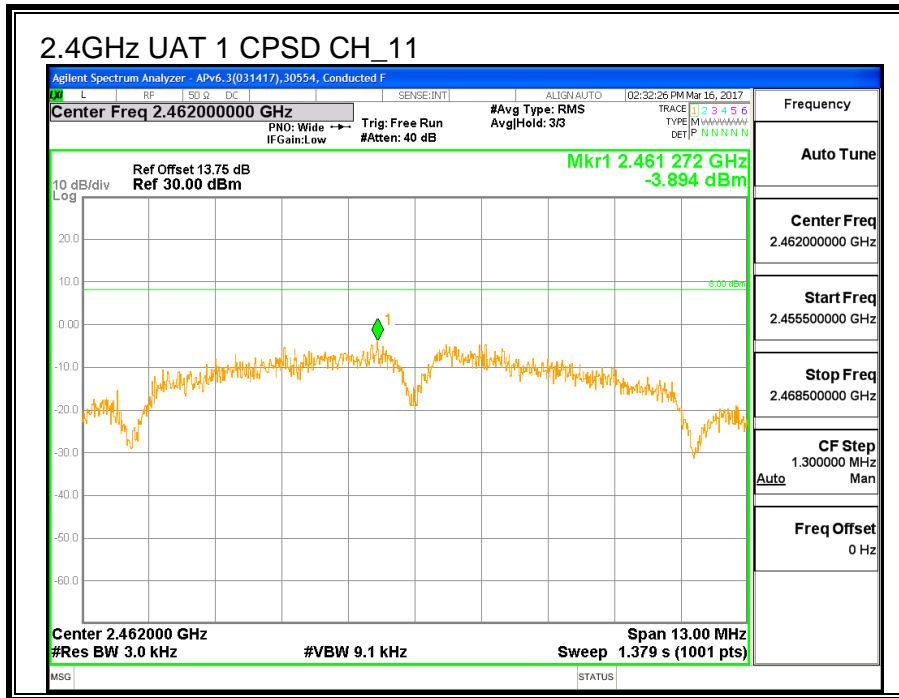
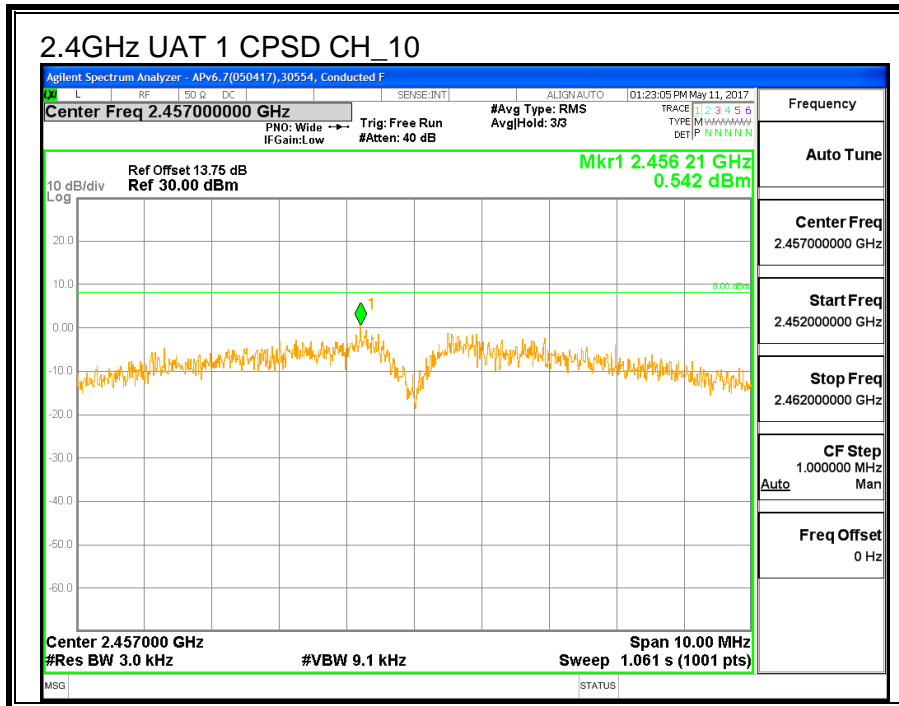

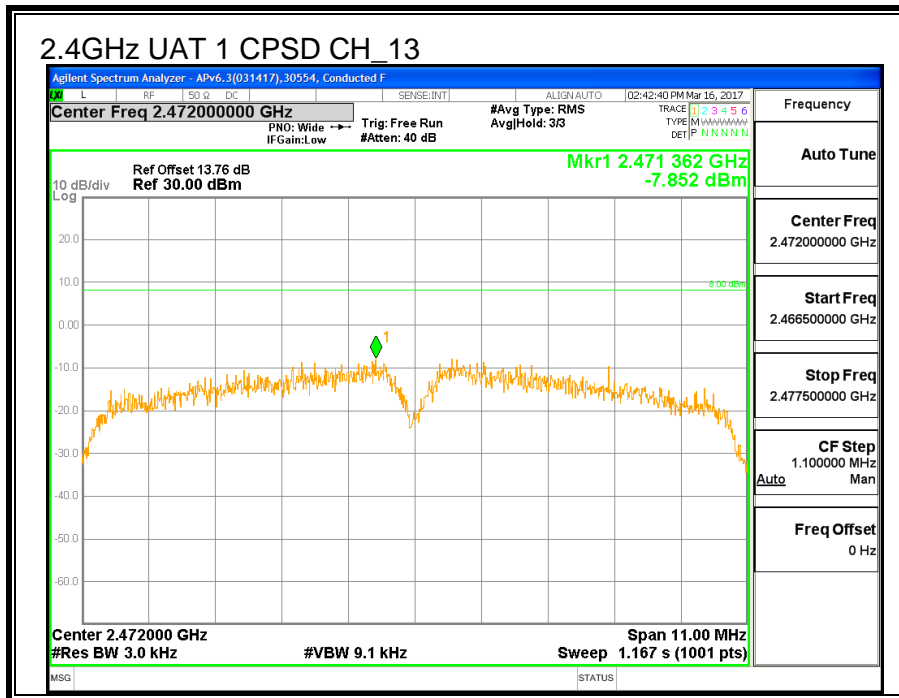
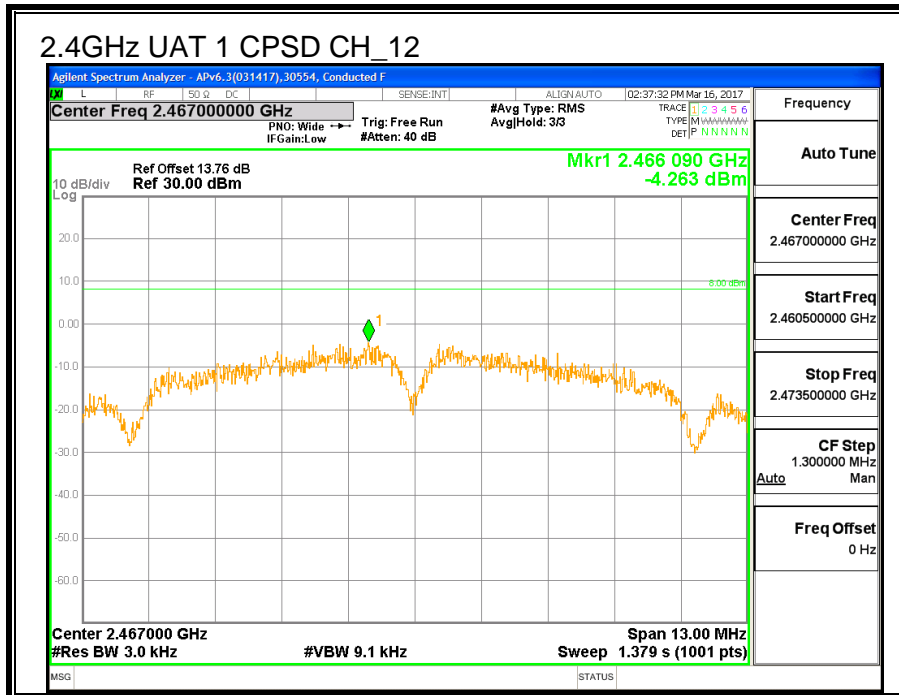

8.2.6. CONDUCTED BANDEDGE AND SPURIOUS EMISSIONS

LIMITS

FCC §15.247 (d)

IC RSS-247 (5.5)

In any 100 kHz bandwidth outside the frequency band in which the spread spectrum or digitally modulated intentional radiator is operating, the radio frequency power that is produced by the intentional radiator shall be at least 20 dB below that in the 100 kHz bandwidth within the band that contains the highest level of the desired power, based on either an RF conducted or a radiated measurement, provided the transmitter demonstrates compliance with the peak conducted power limits. If the transmitter complies with the conducted power limits based on the use of RMS averaging over a time interval, as permitted under paragraph (b)(3) of this section, the attenuation required under this paragraph shall be 30 dB instead of 20 dB. Attenuation below the general limits specified in §15.209(a) is not required.

RESULTS

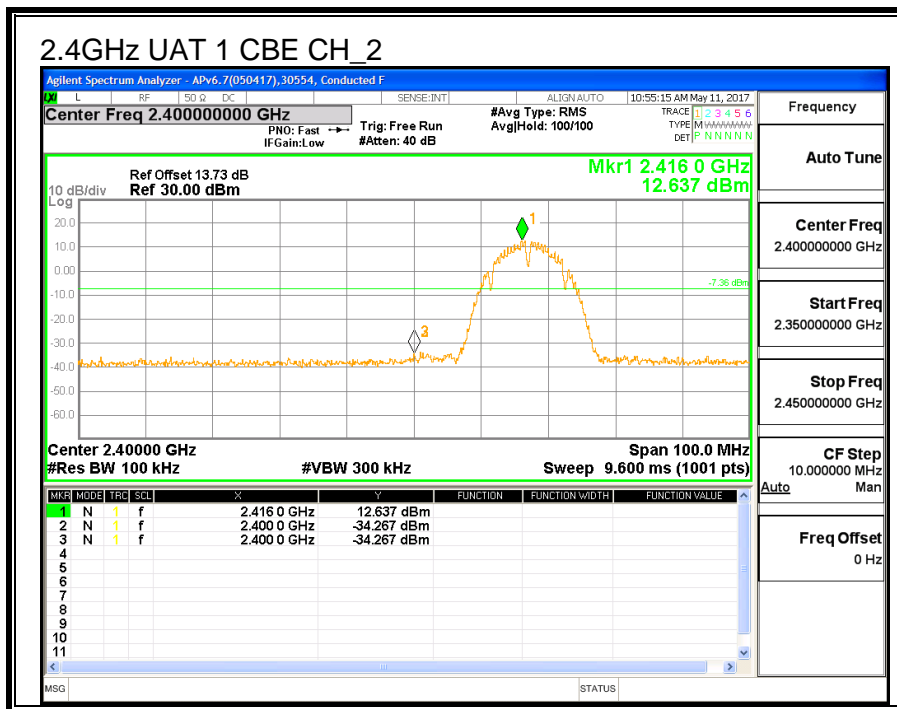
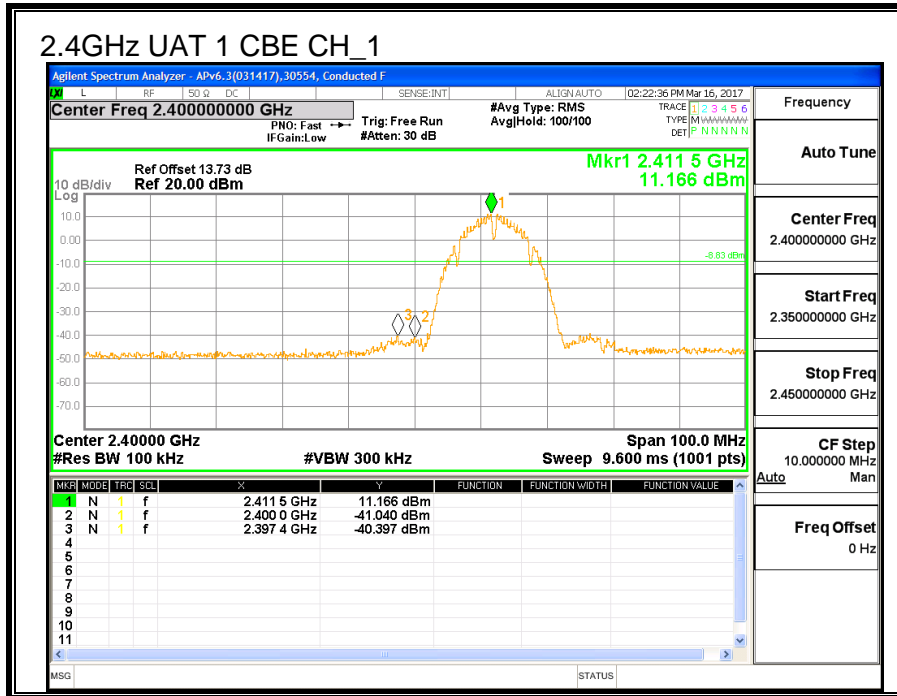

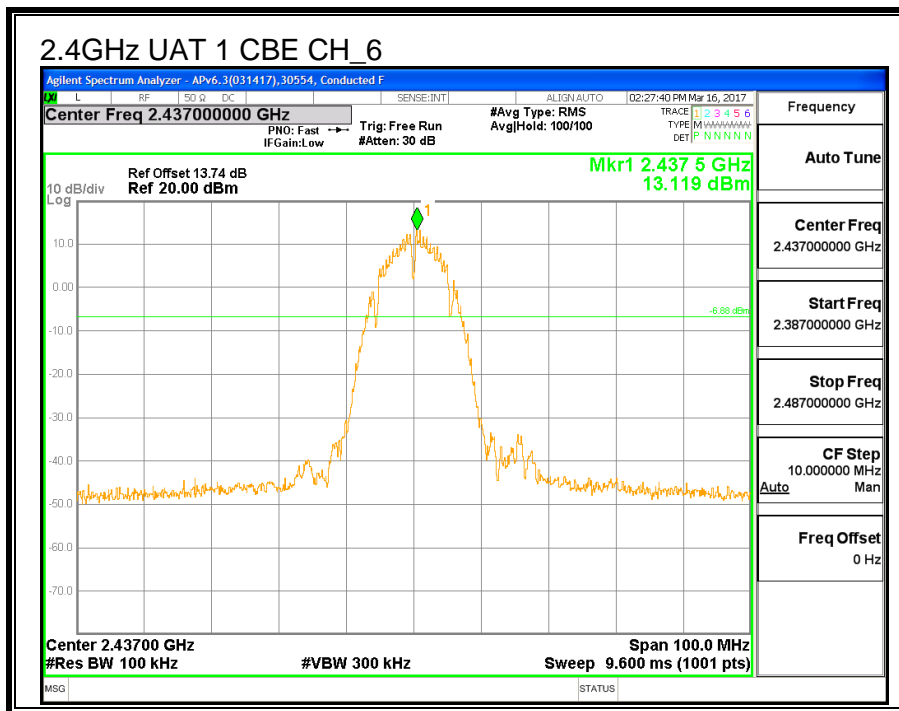
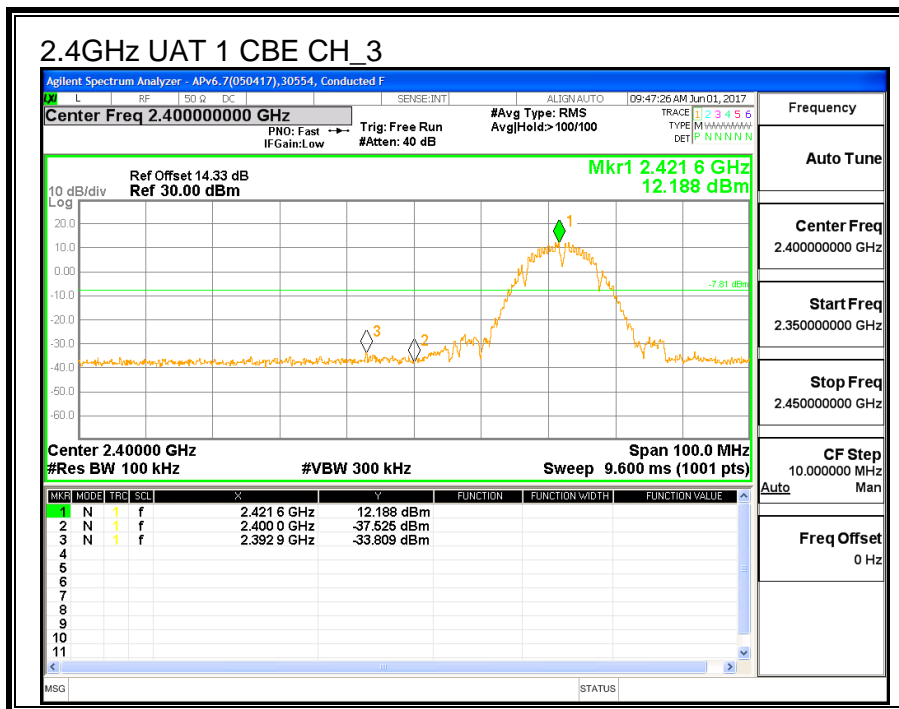

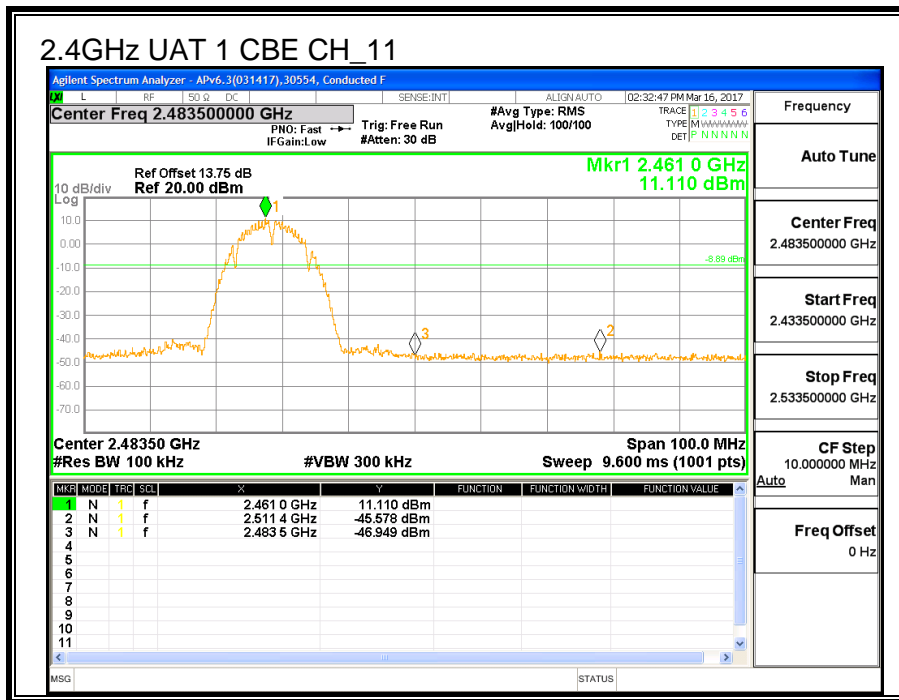
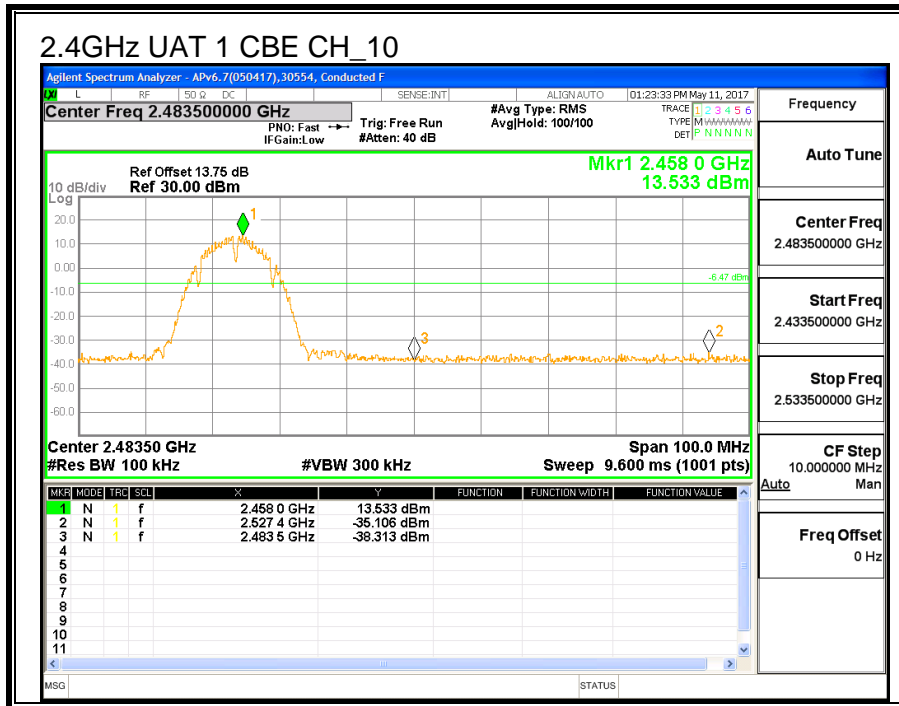

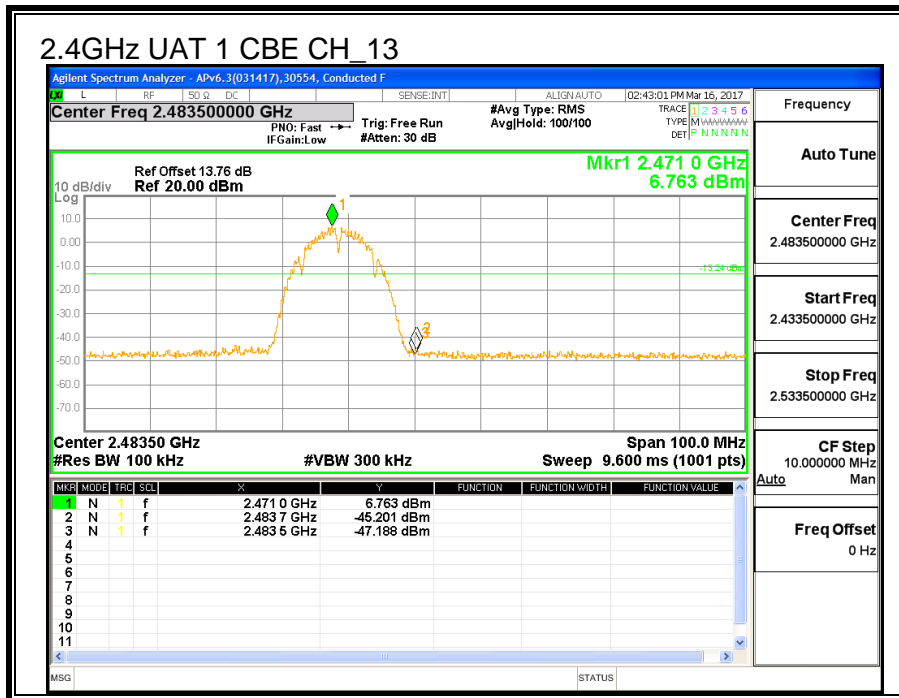
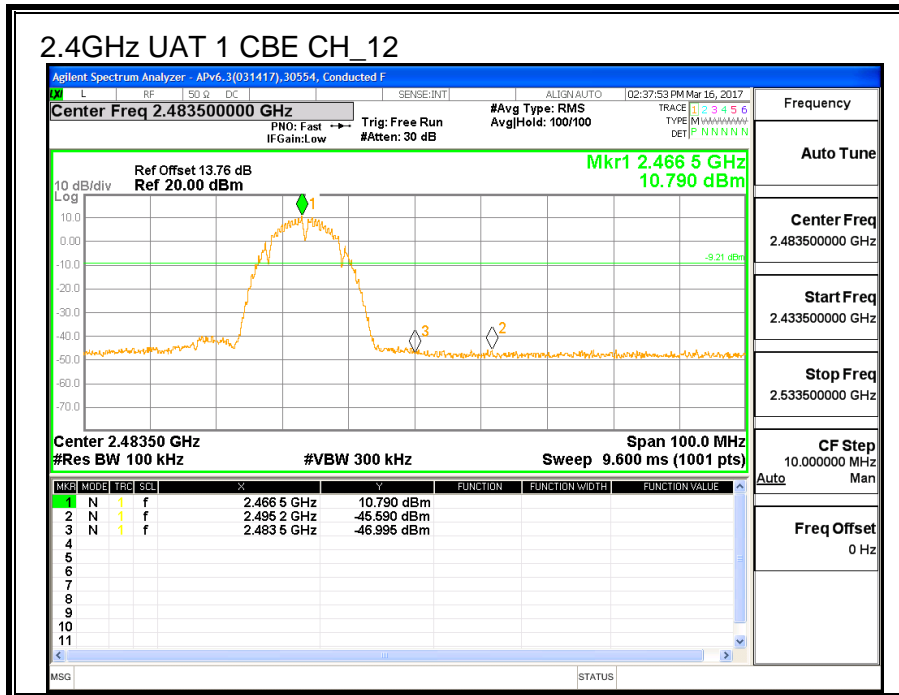

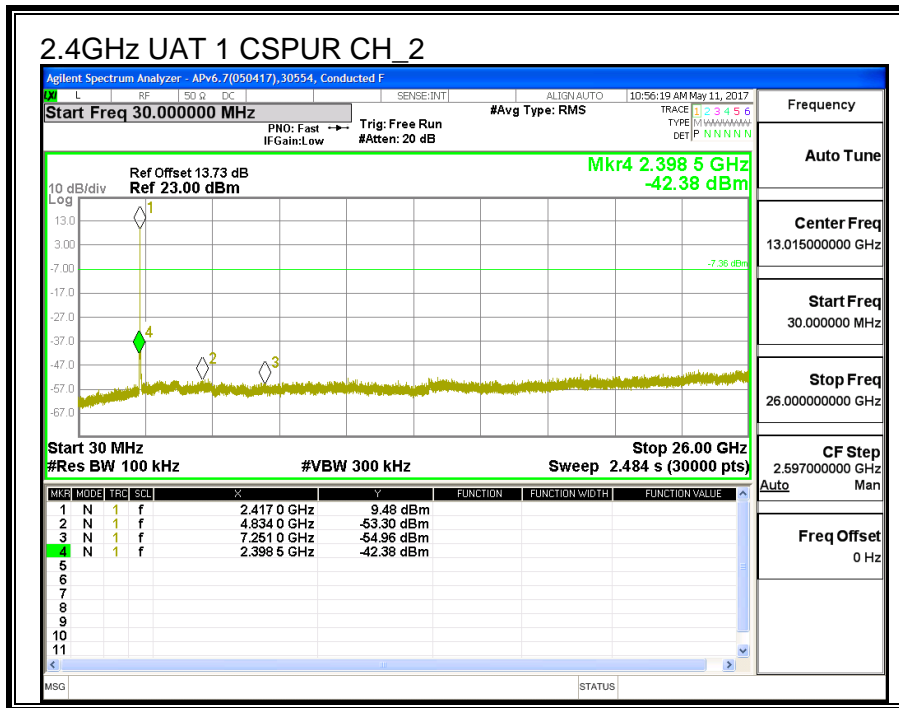
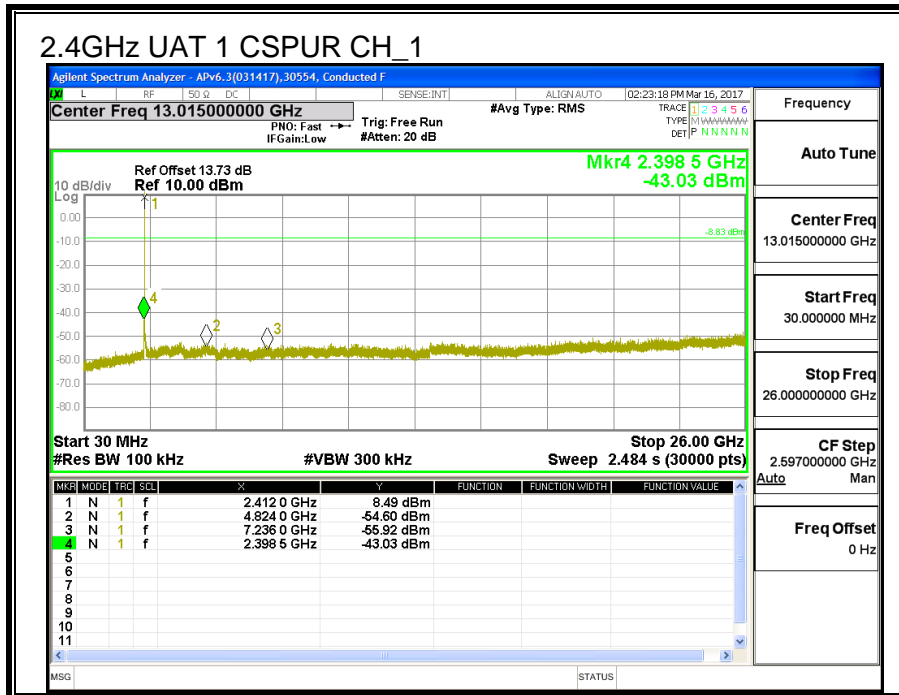

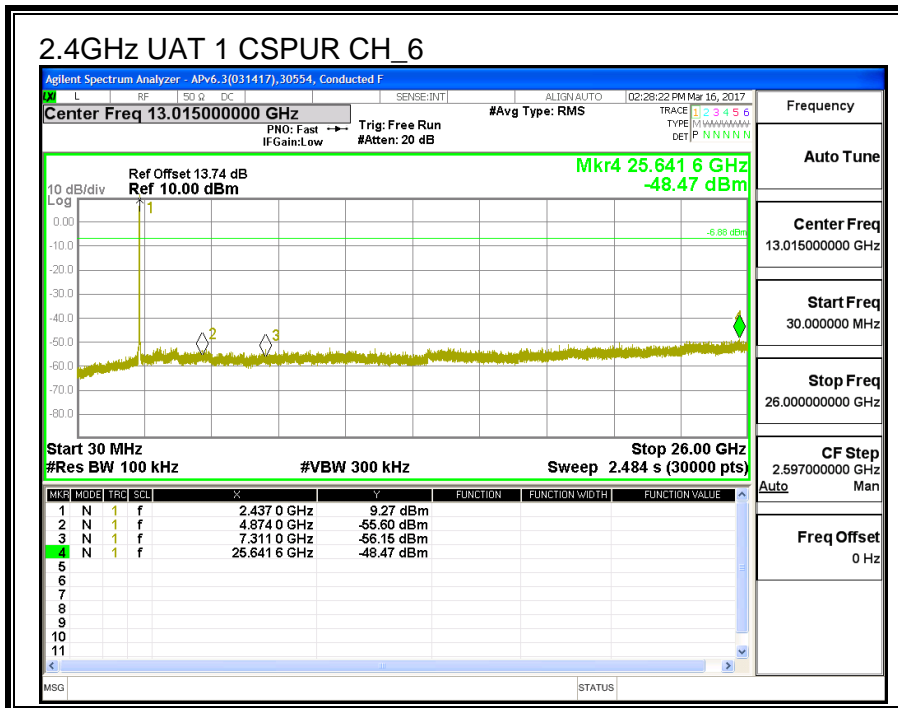
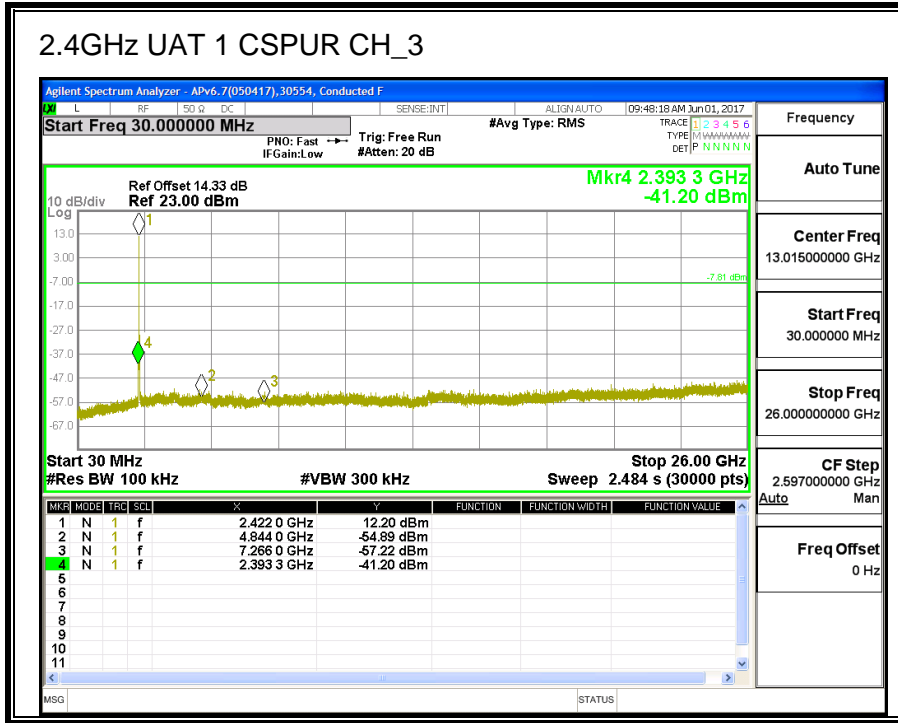

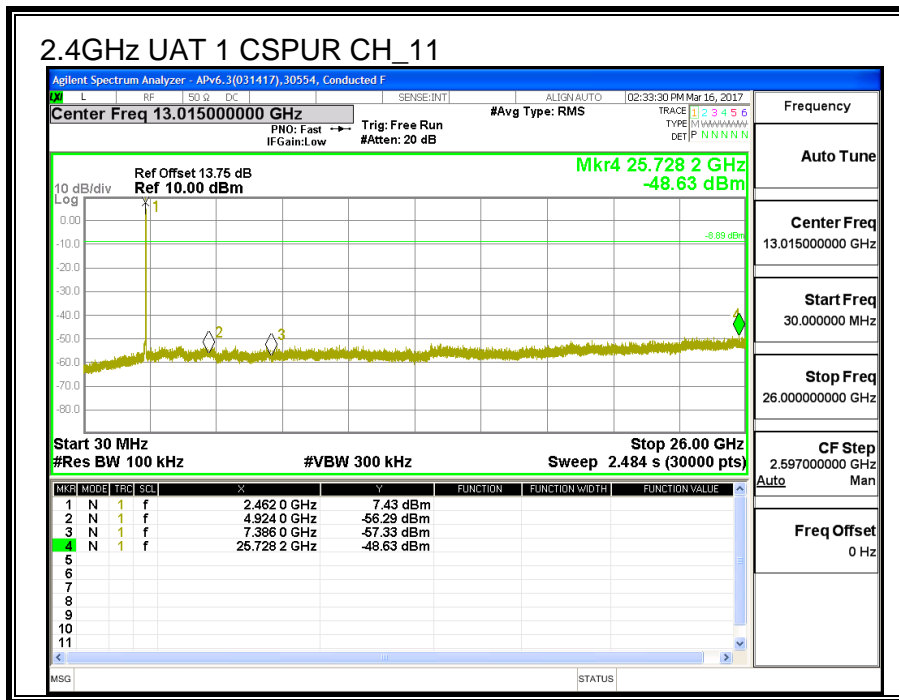
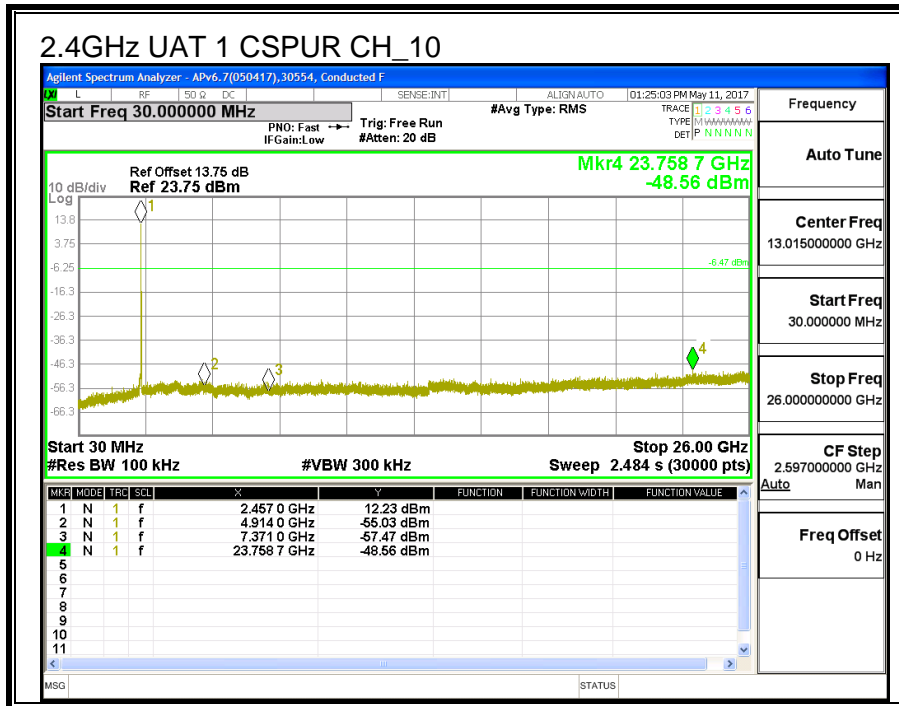

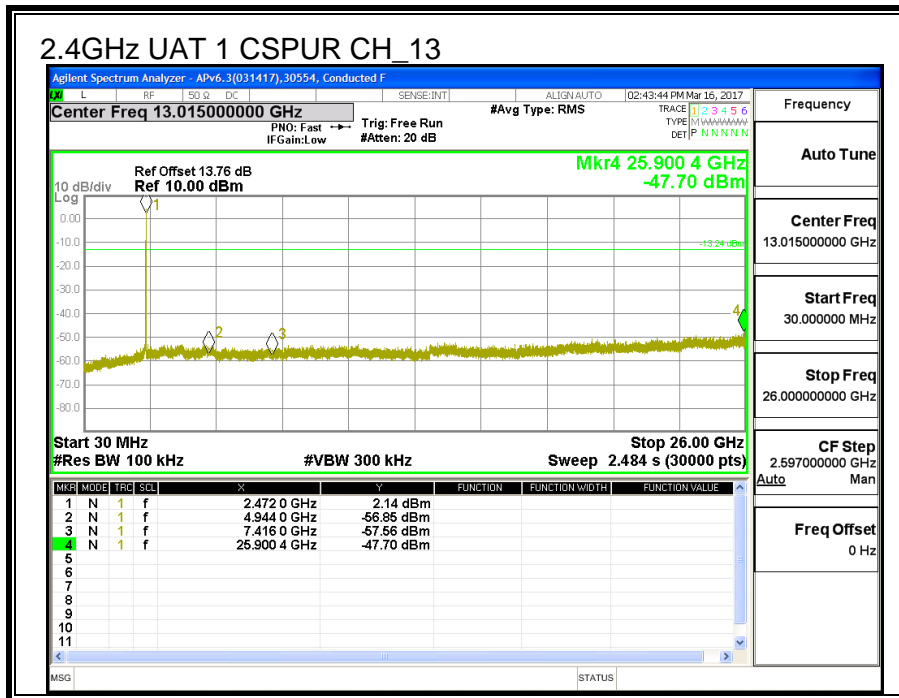
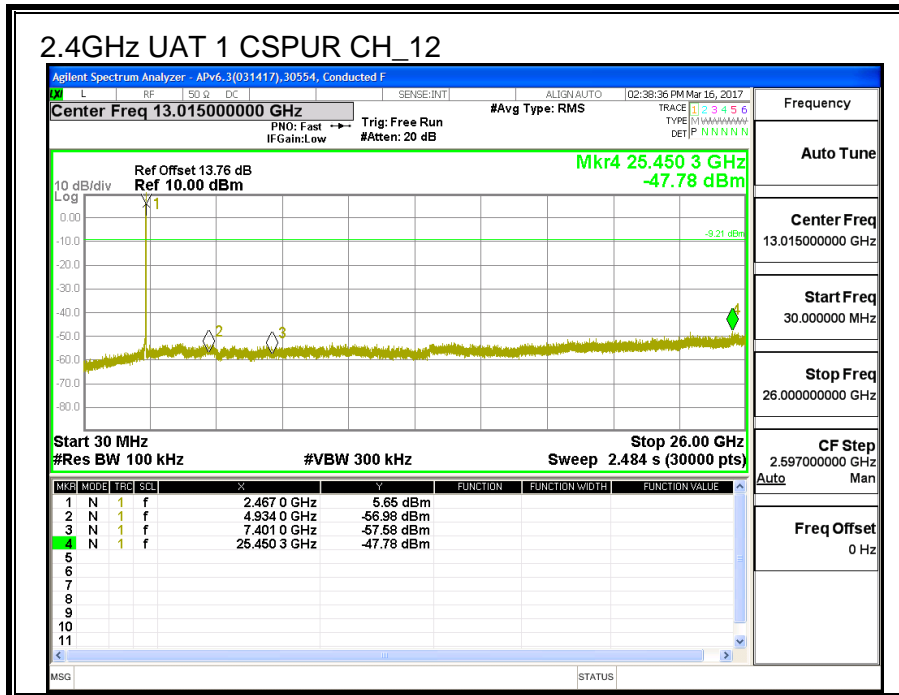

8.3. 11b LAT 3 SISO MODE IN THE 2.4GHz BAND

8.3.1. 6 dB BANDWIDTH

LIMITS

FCC §15.247 (a) (2)

IC RSS-247 (5.2) (a)

The minimum 6 dB bandwidth shall be at least 500 kHz.

RESULTS

Channel	Frequency	6 dB BW LAT3 (MHz)	Minimum Limit (MHz)
Low_1	2412	7.155	0.5
Low_2	2417	8.535	0.5
Low_3	2422	7.08	0.5
Middle_6	2437	9.570	0.5
High_10	2457	9.02	0.5
High_11	2462	6.600	0.5
High_12	2467	8.050	0.5
High_13	2472	6.990	0.5

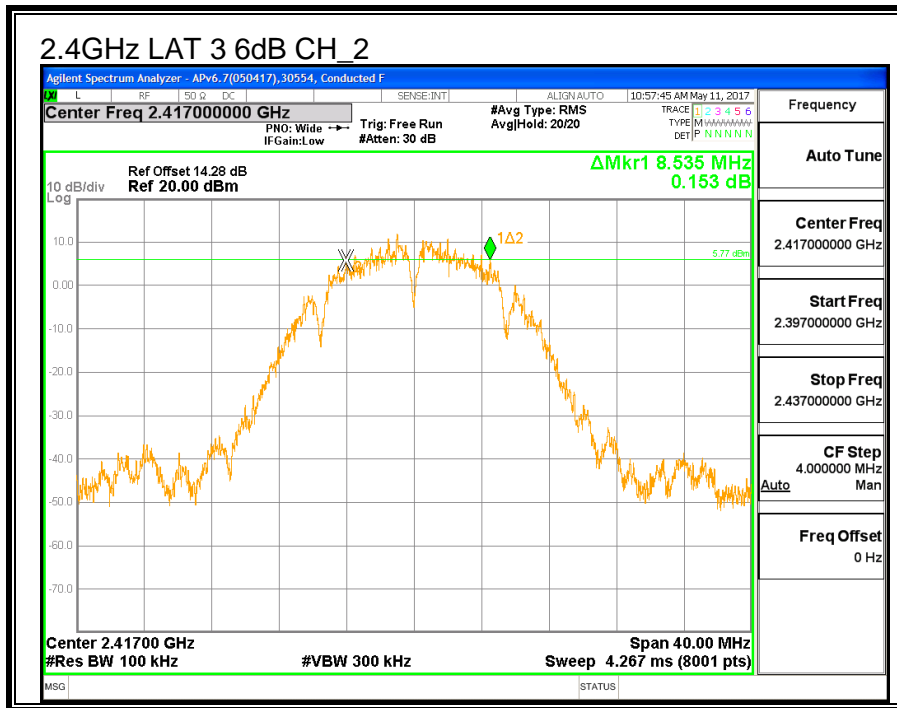
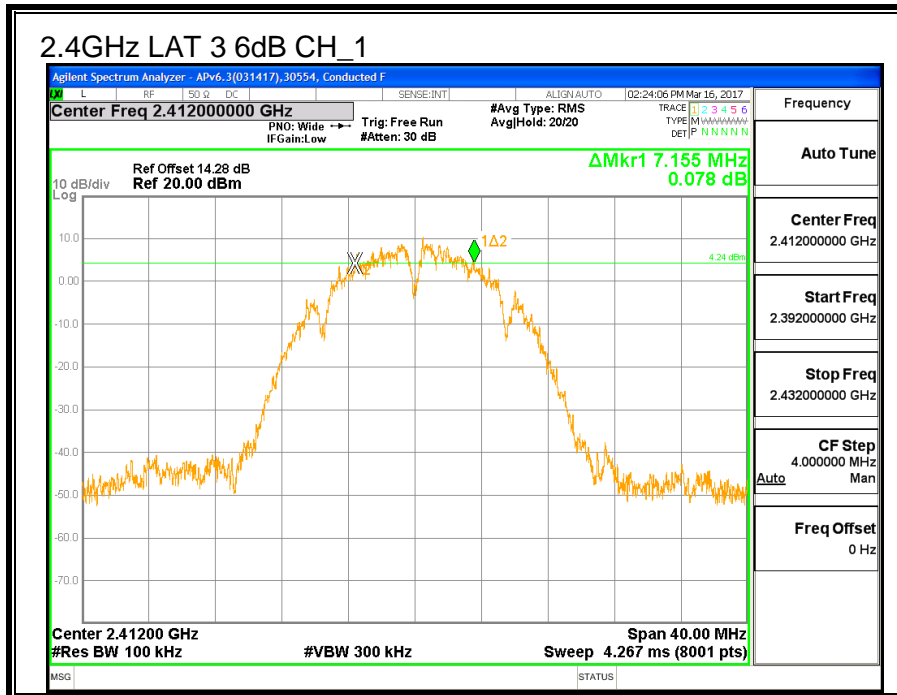

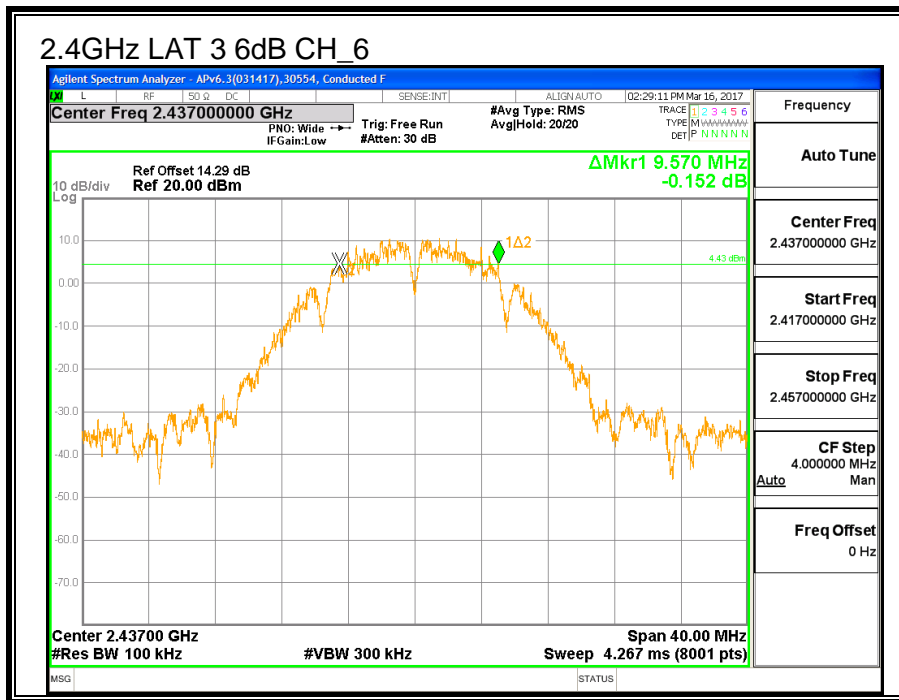
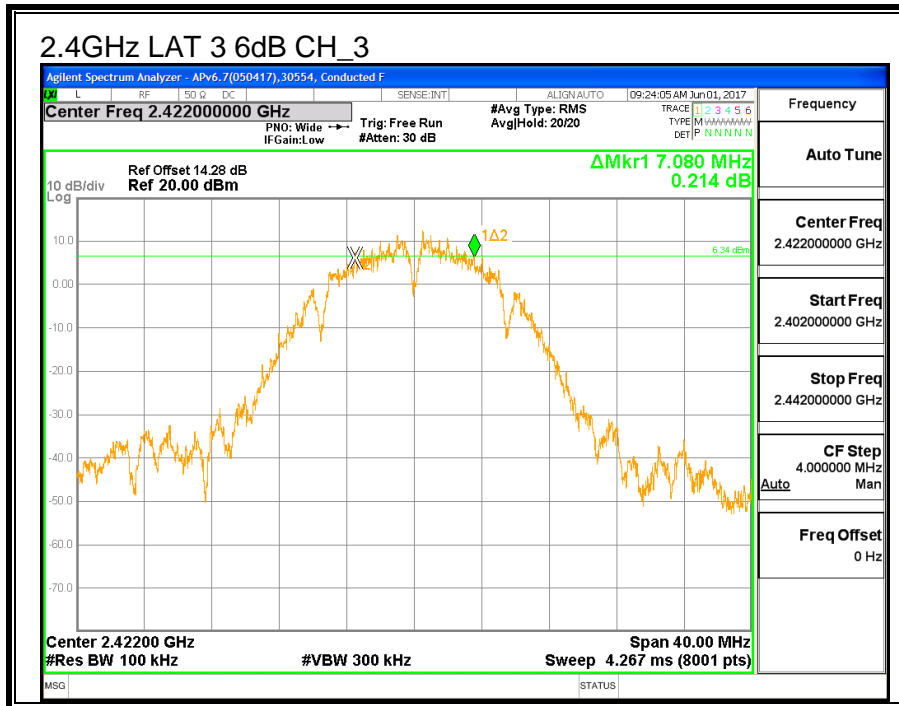

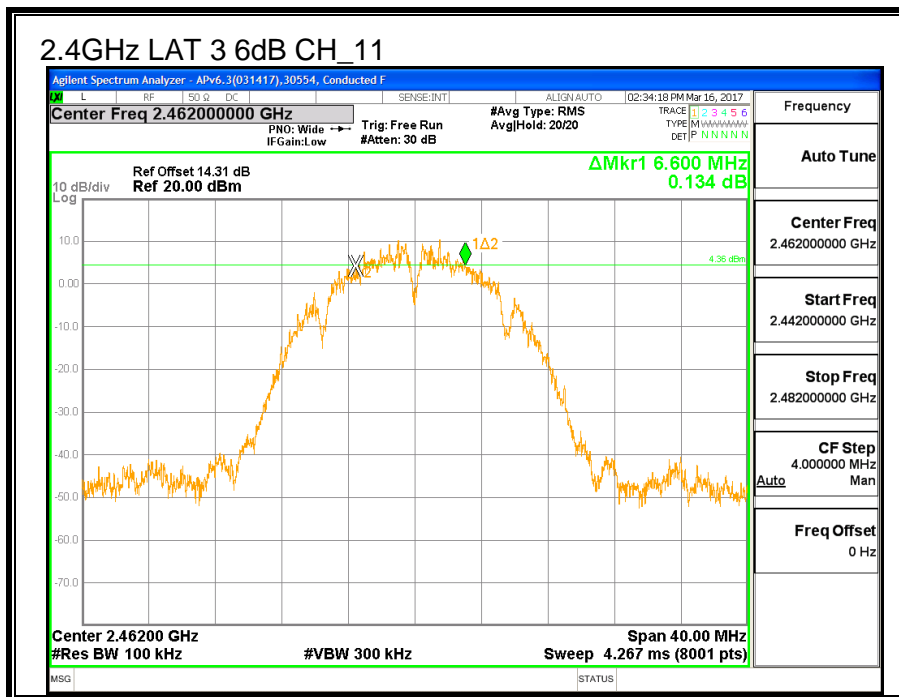
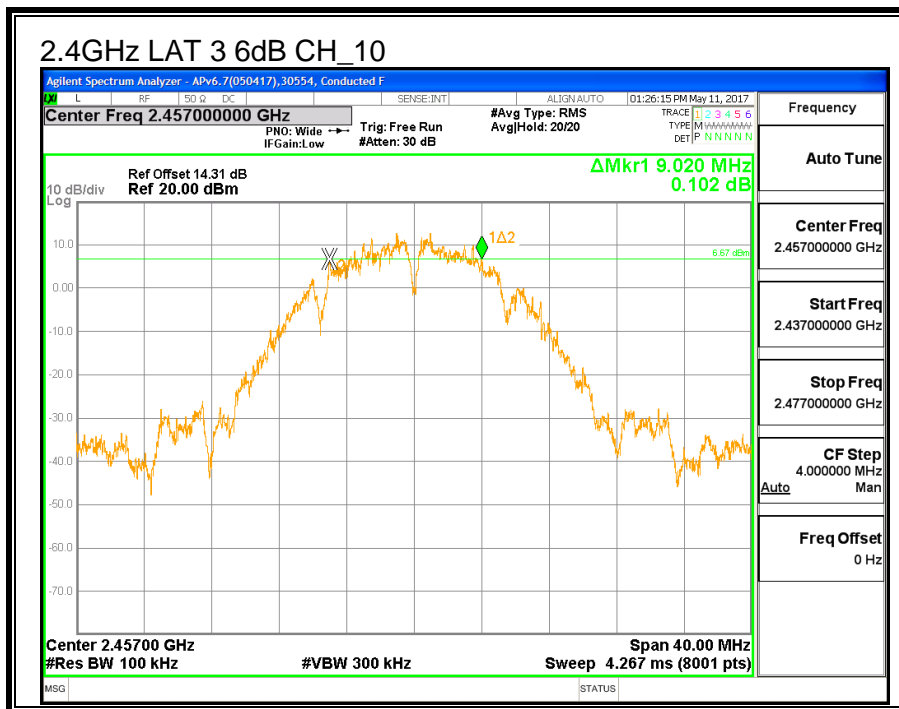

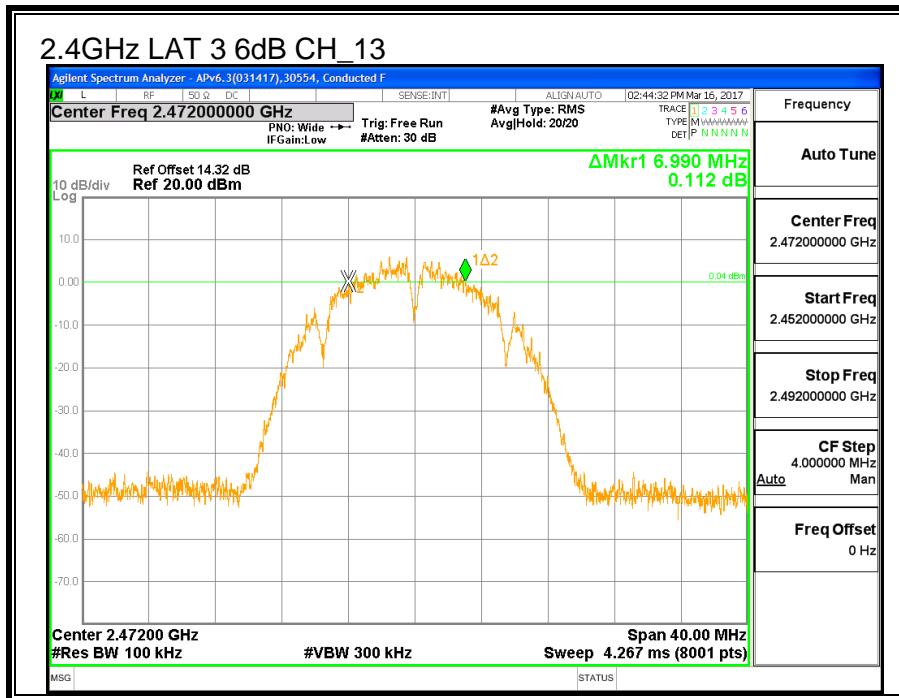
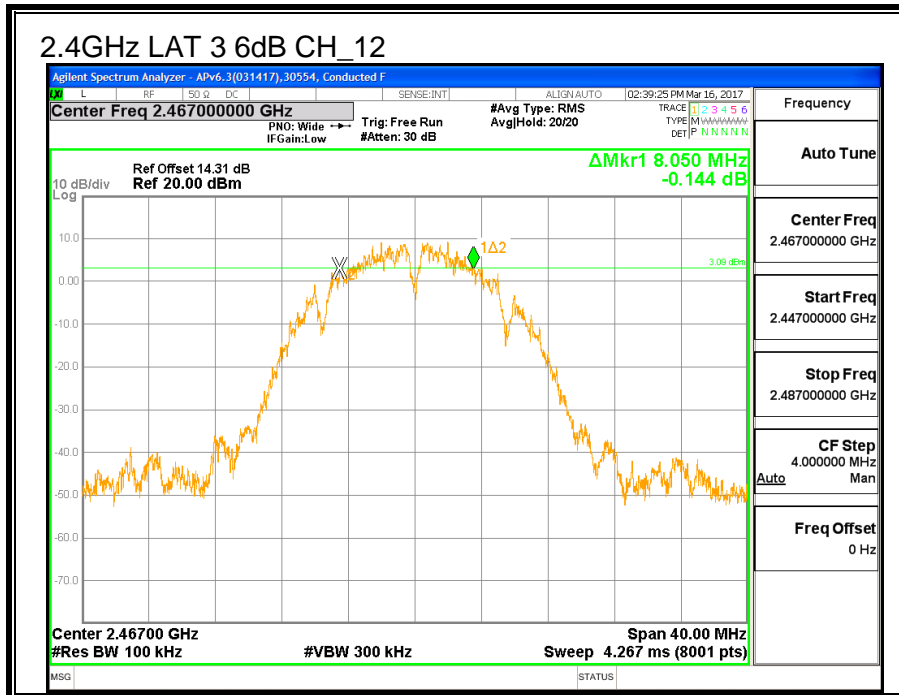

8.3.2. 99% BANDWIDTH

LIMITS

None; for reporting purposes only.

RESULTS

Channel	Frequency (MHz)	99% Bandwidth LAT 3 (MHz)
Low_1	2412	12.600
Low_2	2417	13.131
Low_3	2422	12.923
Middle_6	2437	13.668
High_10	2457	13.29
High_11	2462	12.646
High_12	2467	12.577
High_13	2472	12.253

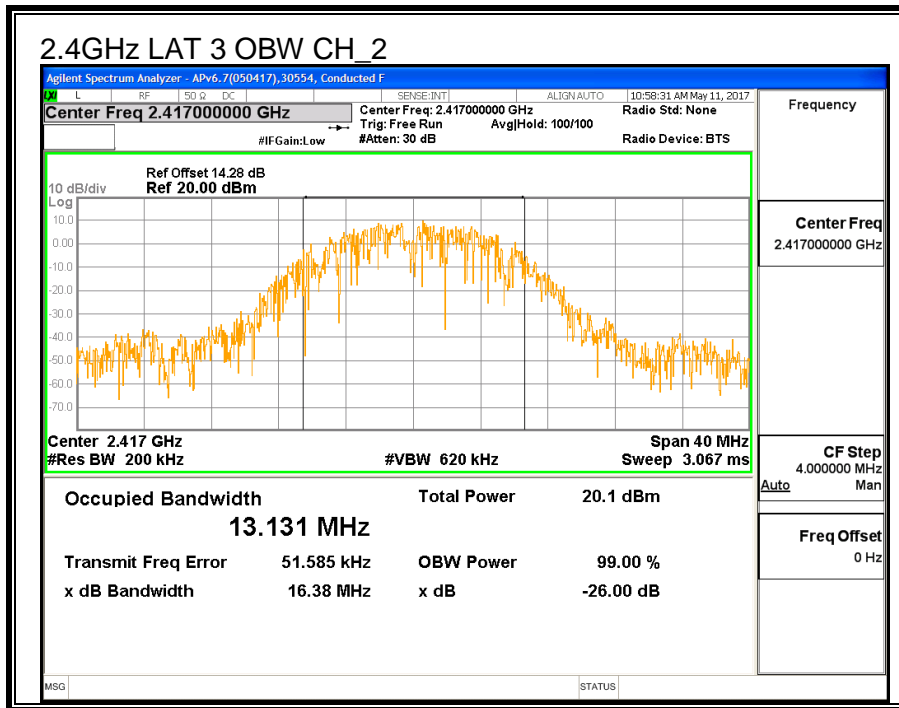
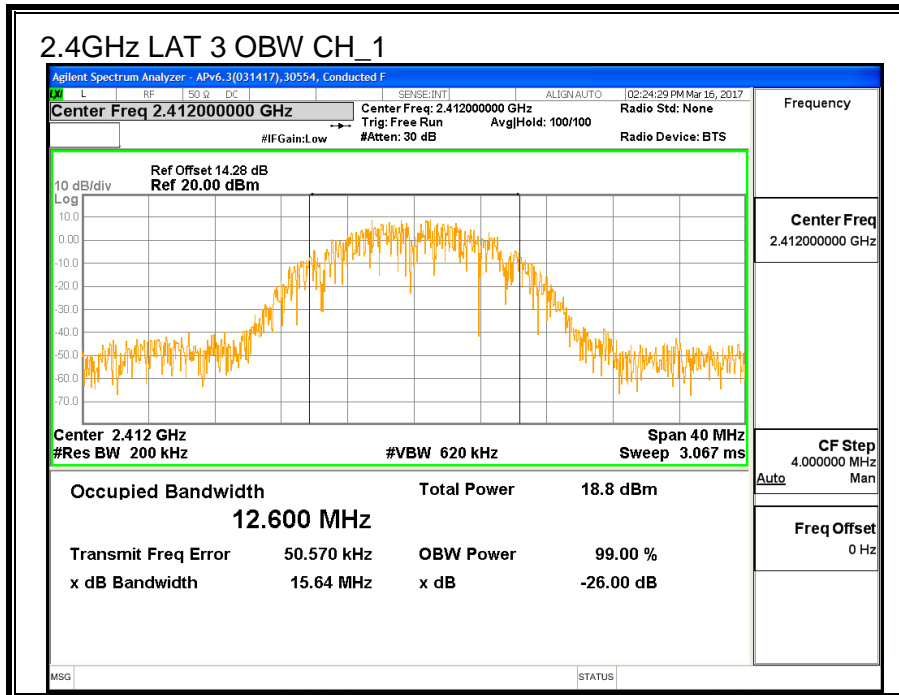

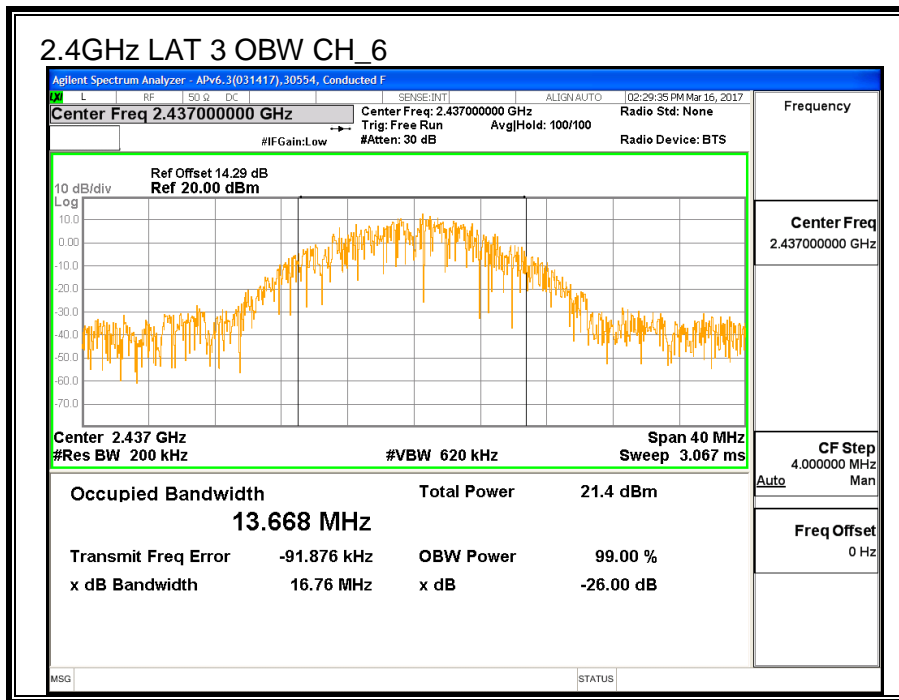
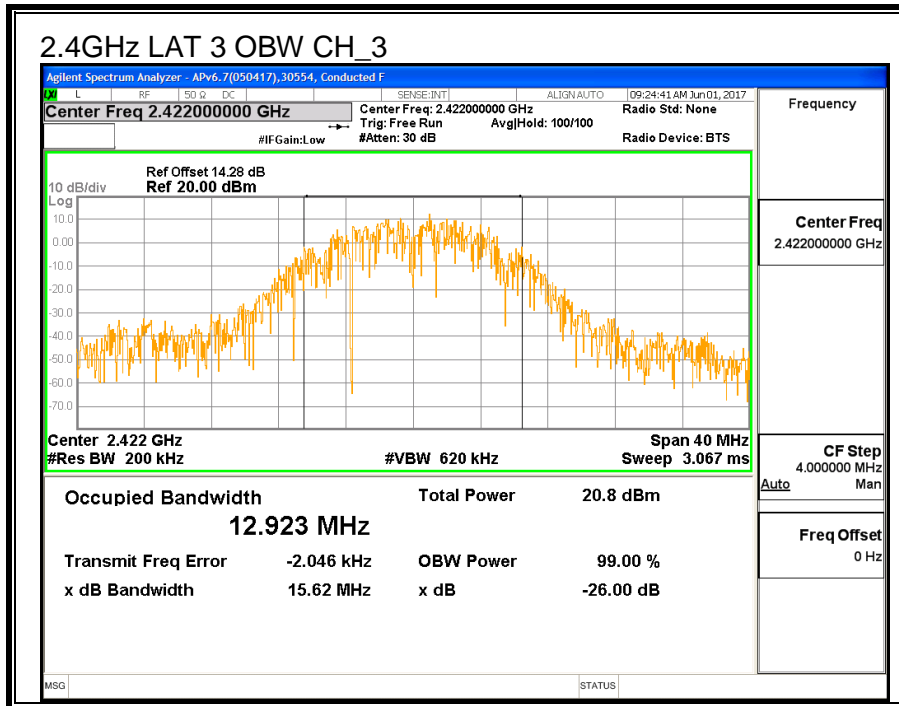

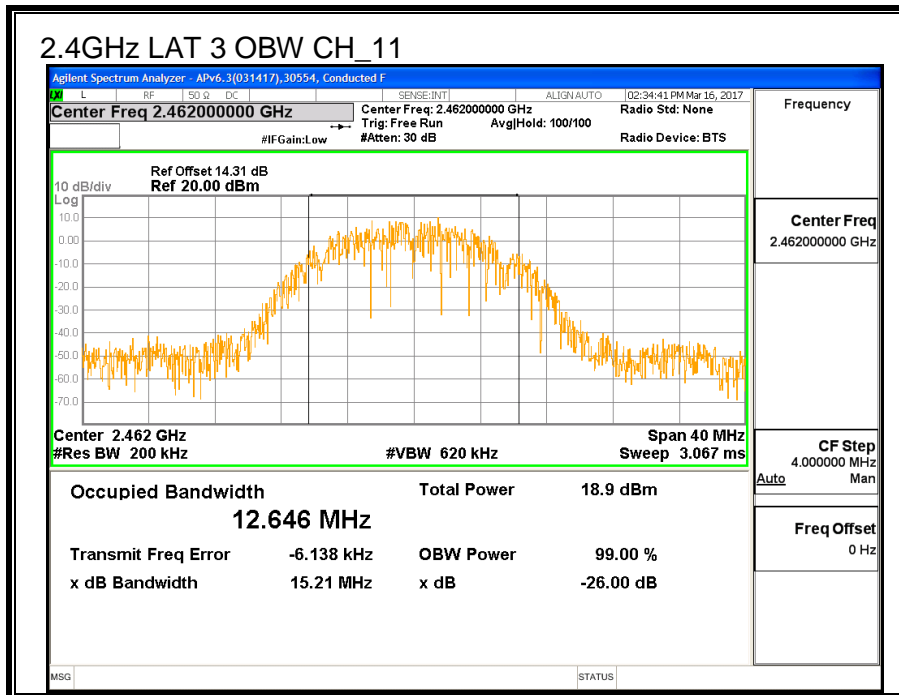
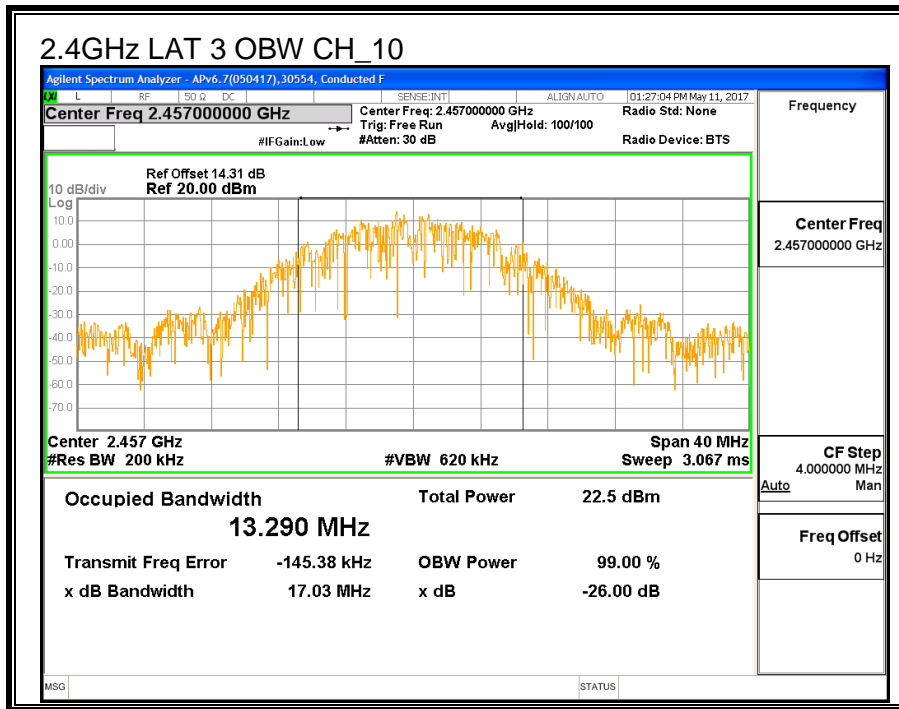

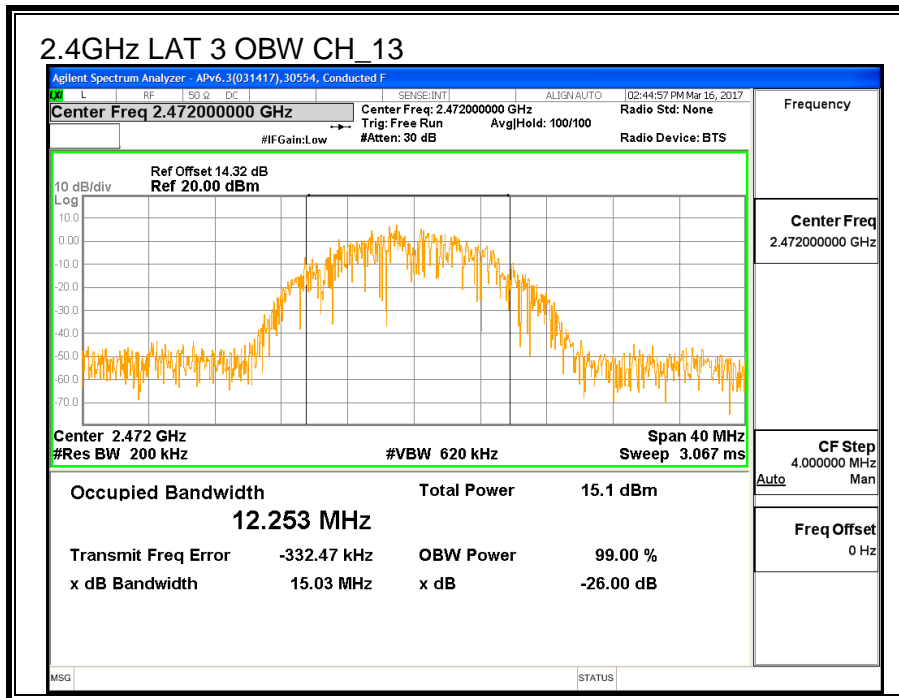
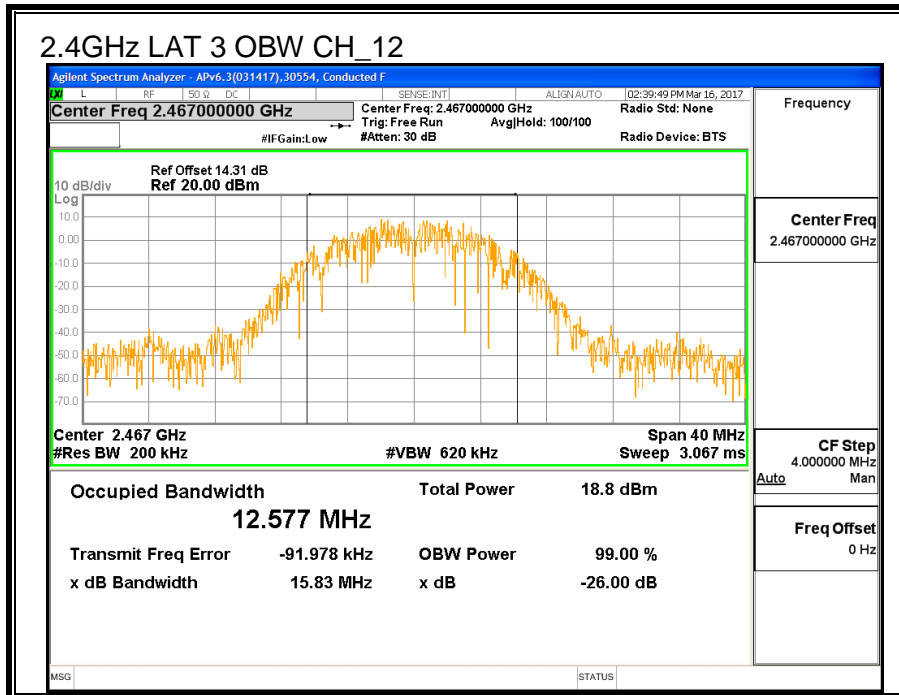

8.3.3. AVERAGE POWER

ID:	30554	Date:	6/14/2017
------------	-------	--------------	-----------

LIMITS

None; for reporting purposes only.

RESULTS

Channel	Frequency (MHz)	Power LAT 3 (MHz)
Low_1	2412	19.78
Low_2	2417	21.17
Low_3	2422	21.30
Middle_6	2437	21.35
High_10	2457	21.32
High_11	2462	20.87
High_12	2467	18.40
High_13	2472	14.79

8.3.4. OUTPUT POWER

ID:	30554	Date:	6/14/2017
------------	-------	--------------	-----------

LIMITS

FCC §15.247

IC RSS-247 (5.4) (d)

For systems using digital modulation in the 2400–2483.5 MHz, and 5725–5850 MHz bands: 1 Watt, based on the use of antennas with directional gains that do not exceed 6 dBi. If transmitting antennas of directional gain greater than 6 dBi are used, the conducted output power from the intentional radiator shall be reduced by the amount in dB that the directional gain of the antenna exceeds 6 dBi.

DIRECTIONAL ANTENNA GAIN

There is only one transmitter output therefore the directional gain is equal to the antenna gain.

RESULTS

Limits

Channel	Frequency (MHz)	Directional Gain (dBi)	FCC Power Limit (dBm)	IC Power Limit (dBm)	IC EIRP Limit (dBm)	Max Power (dBm)
Low_1	2412	-2.24	30.00	30	36	30.00
Low_2	2417	-2.24	30.00	30	36	30.00
Low_3	2422	-2.24	30.00	30	36	30.00
Mid_6	2437	-2.24	30.00	30	36	30.00
High_10	2457	-2.24	30.00	30	36	30.00
High_11	2462	-2.24	30.00	30	36	30.00
High_12	2467	-2.24	30.00	30	36	30.00
High_13	2472	-2.24	30.00	30	36	30.00

Duty Cycle CF (dB)	0.00	Included in Calculations of Corr'd Power
---------------------------	------	---

Results

Channel	Frequency (MHz)	Meas Power (dBm)	Total Corr'd Power (dBm)	Power Limit (dBm)	Margin (dB)
Low_1	2412	23.23	23.23	30.00	-6.77
Low_2	2417	24.62	24.62	30.00	-5.38
Low_3	2422	24.75	24.75	30.00	-5.25
Mid_6	2437	24.80	24.80	30.00	-5.20
High_10	2457	24.76	24.76	30.00	-5.24
High_11	2462	24.32	24.32	30.00	-5.68
High_12	2467	21.85	21.85	30.00	-8.15
High_13	2472	18.24	18.24	30.00	-11.76

8.3.5. POWER SPECTRAL DENSITY

LIMITS

FCC §15.247

IC RSS-247 (5.2) (b)

For digitally modulated systems, the power spectral density conducted from the intentional radiator to the antenna shall not be greater than 8 dBm in any 3 KHz band during any time interval of continuous transmissions.

RESULTS

Duty Cycle CF (dB)	0.00	Included in Calculations of Corr'd PSD
---------------------------	------	---

PSD Results

Channel	Frequency (MHz)	Meas (dBm/3kHz)	Total Corr'd PSD (dBm/3kHz)	Limit (dBm/3kHz)	Margin (dB)
Low_1	2412	-2.05	-2.05	8.0	-10.1
Low_2	2417	-0.76	-0.76	8.0	-8.8
Low_3	2422	-1.63	-1.63	8.0	-9.6
Mid_6	2437	-2.35	-2.35	8.0	-10.4
High_10	2457	-0.54	-0.54	8.0	-8.5
High_11	2462	-3.45	-3.45	8.0	-11.4
High_12	2467	-3.11	-3.11	8.0	-11.1
High_13	2472	-6.86	-6.86	8.0	-14.9

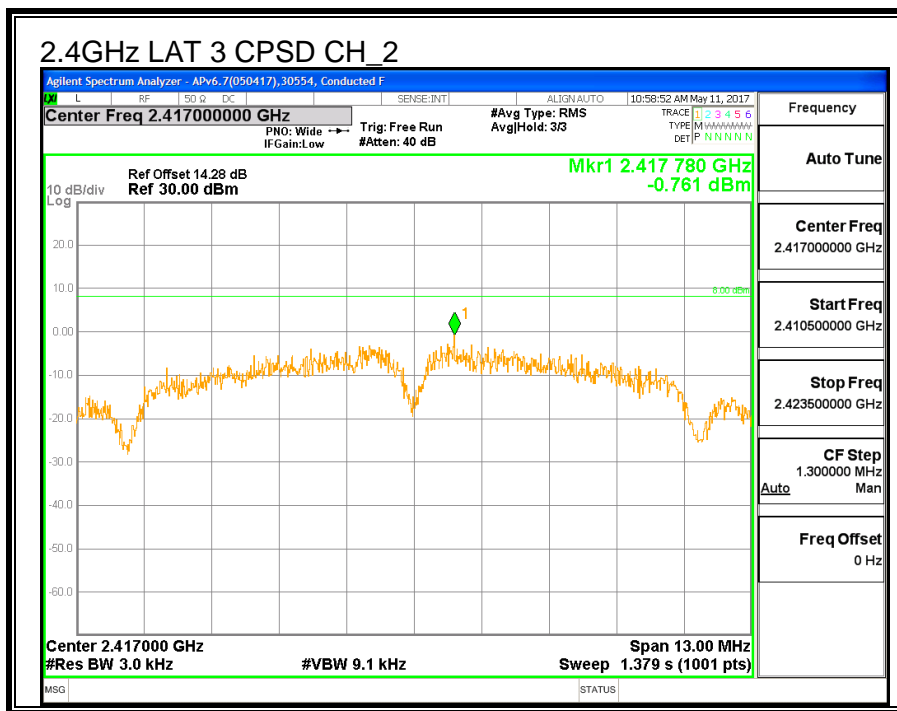
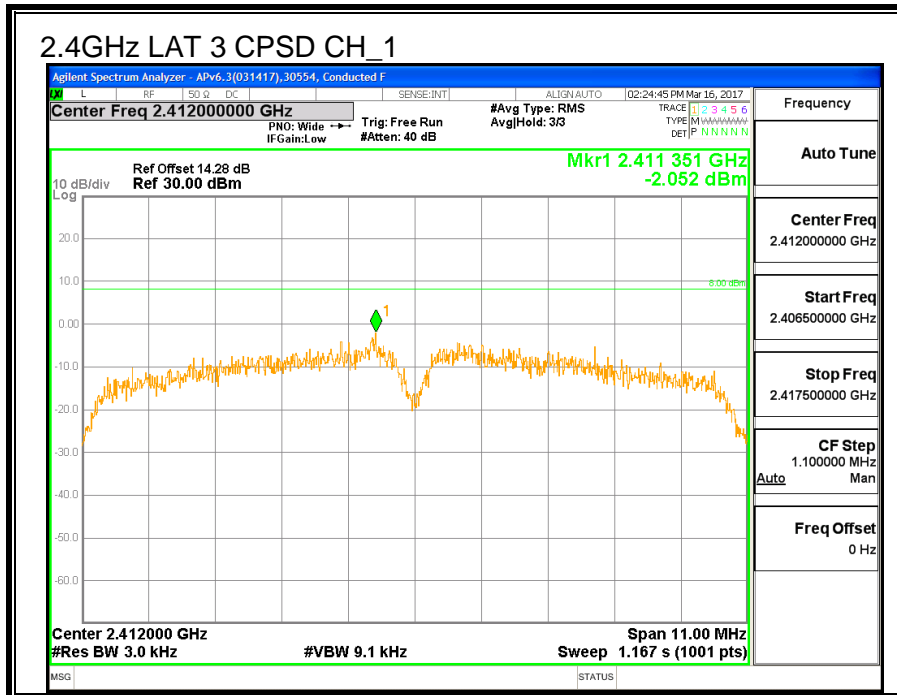

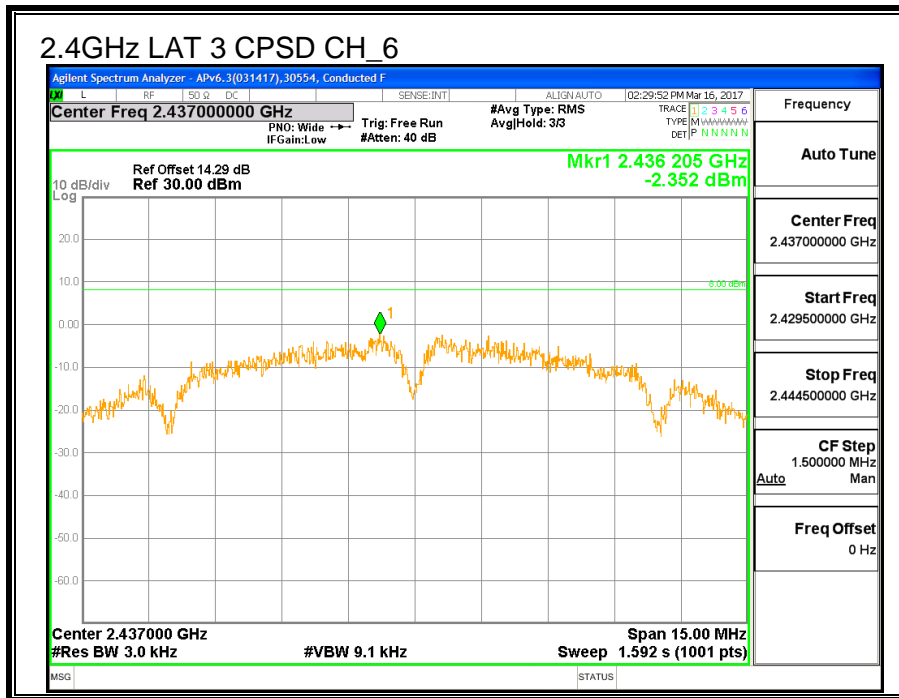
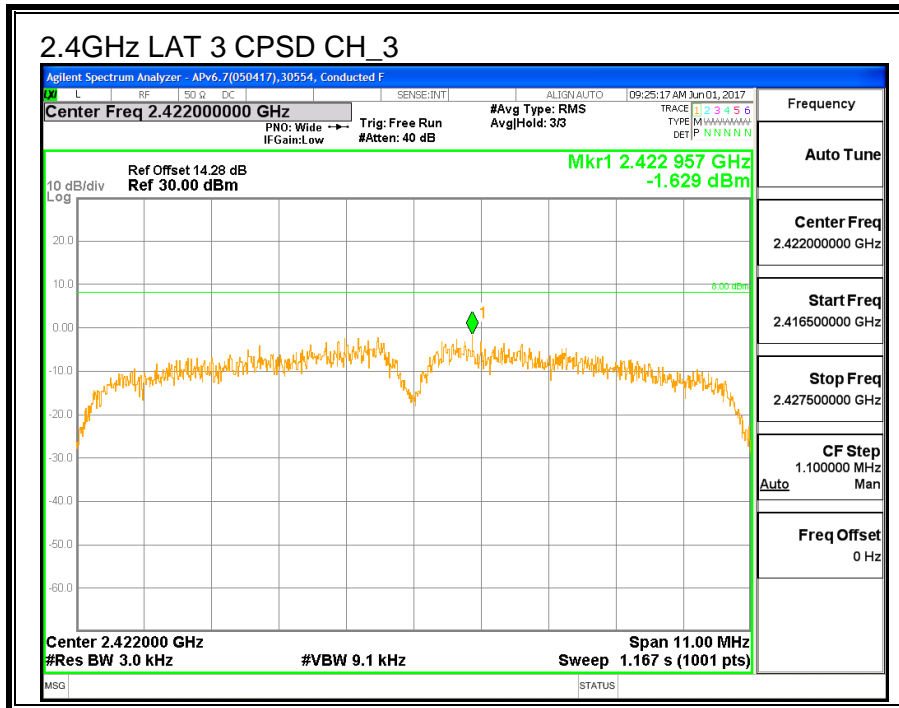

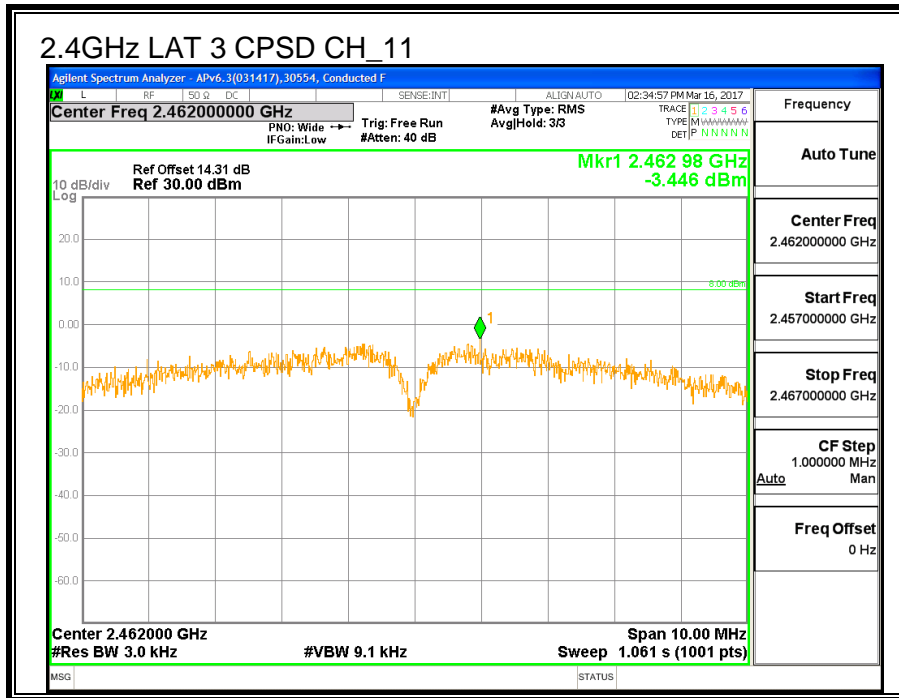
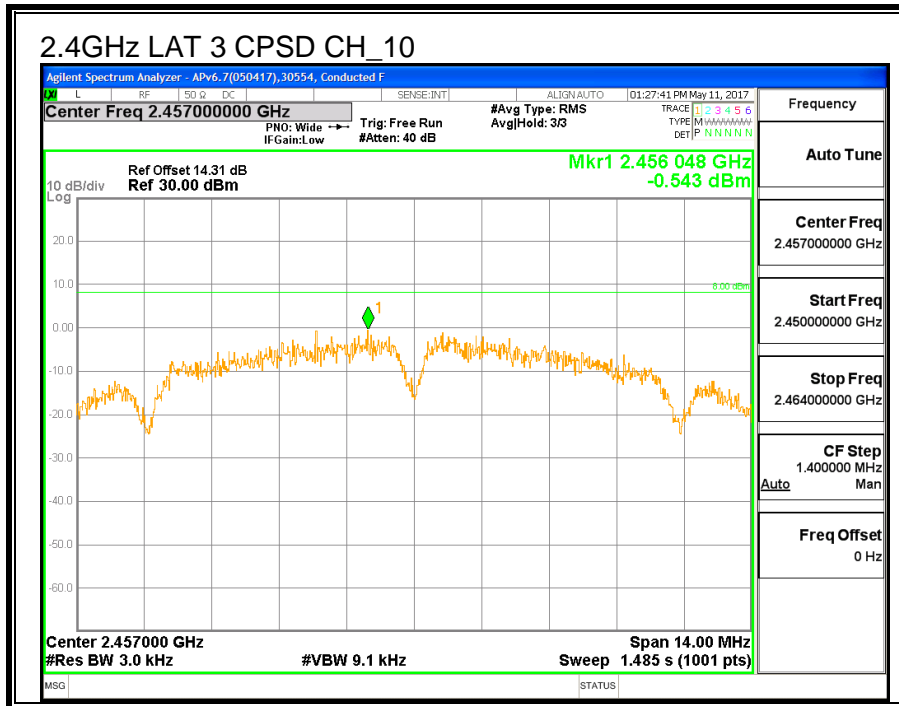

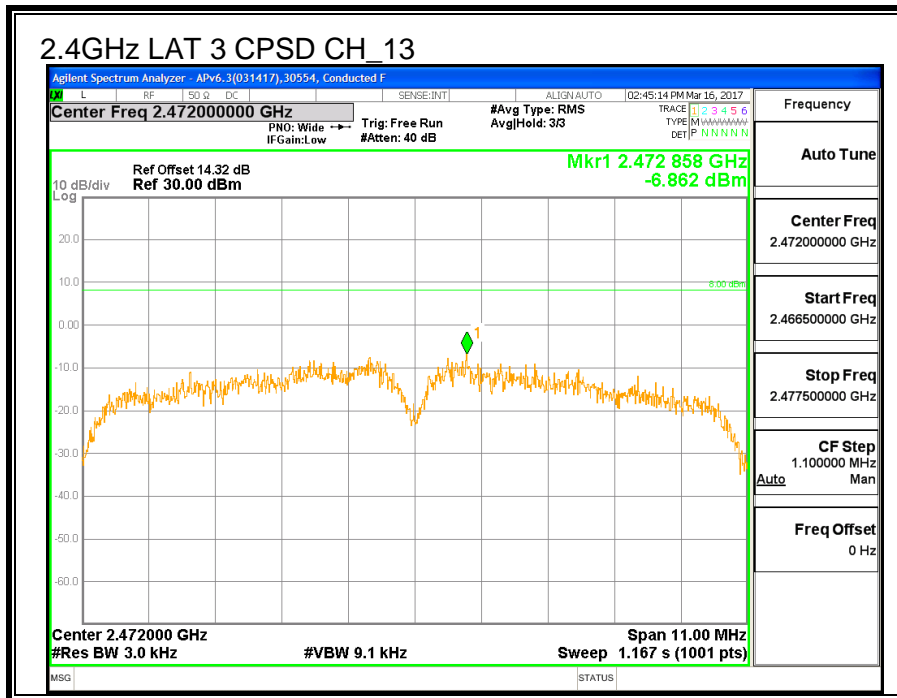
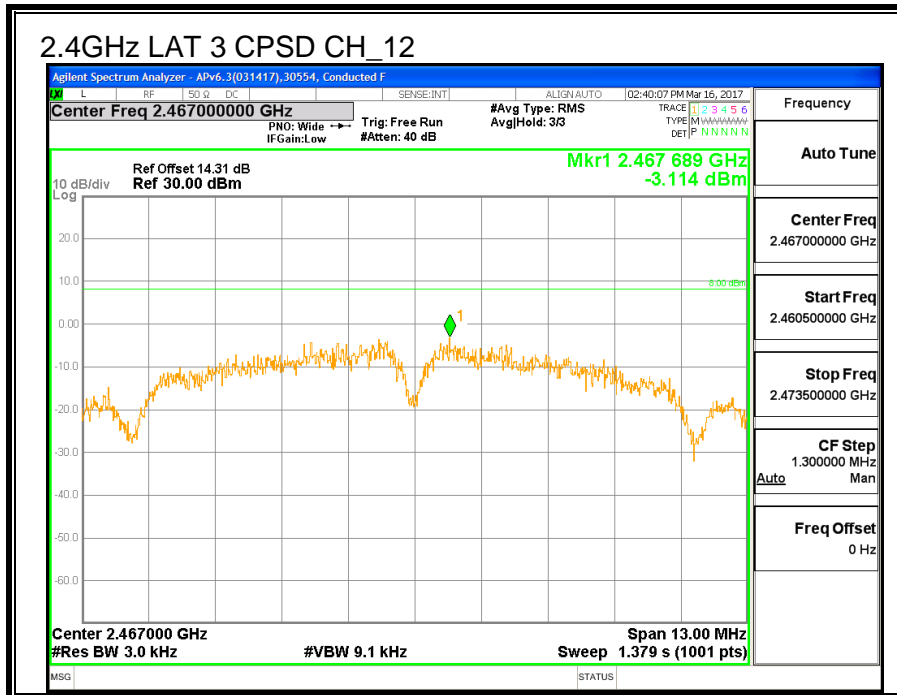

8.3.6. CONDUCTED BANDEGE AND SPURIOUS EMISSIONS

LIMITS

FCC §15.247 (d)

IC RSS-247 (5.5)

In any 100 kHz bandwidth outside the frequency band in which the spread spectrum or digitally modulated intentional radiator is operating, the radio frequency power that is produced by the intentional radiator shall be at least 20 dB below that in the 100 kHz bandwidth within the band that contains the highest level of the desired power, based on either an RF conducted or a radiated measurement, provided the transmitter demonstrates compliance with the peak conducted power limits. If the transmitter complies with the conducted power limits based on the use of RMS averaging over a time interval, as permitted under paragraph (b)(3) of this section, the attenuation required under this paragraph shall be 30 dB instead of 20 dB. Attenuation below the general limits specified in §15.209(a) is not required.

RESULTS

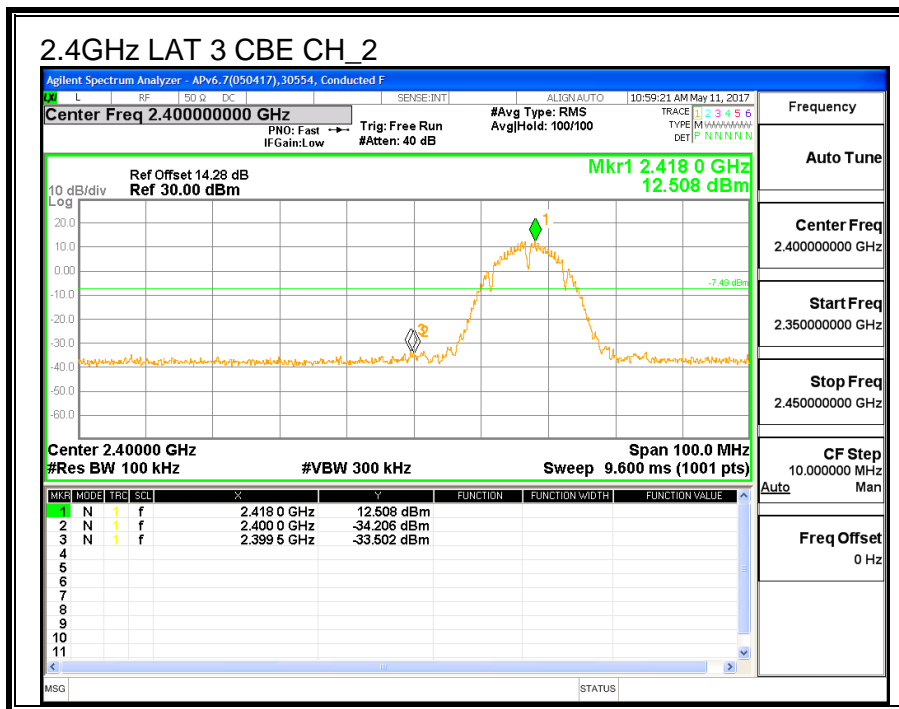
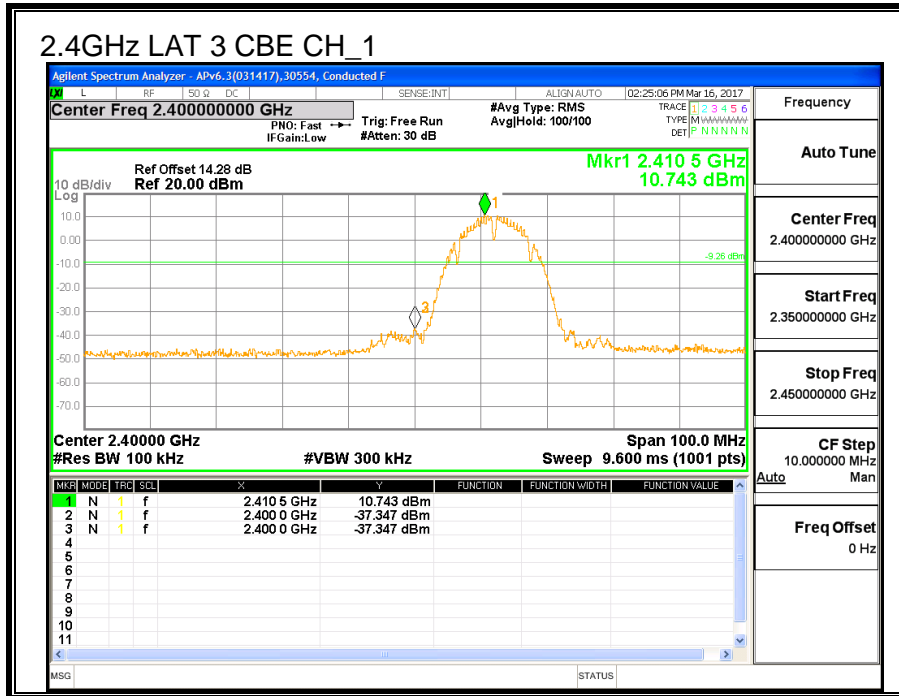

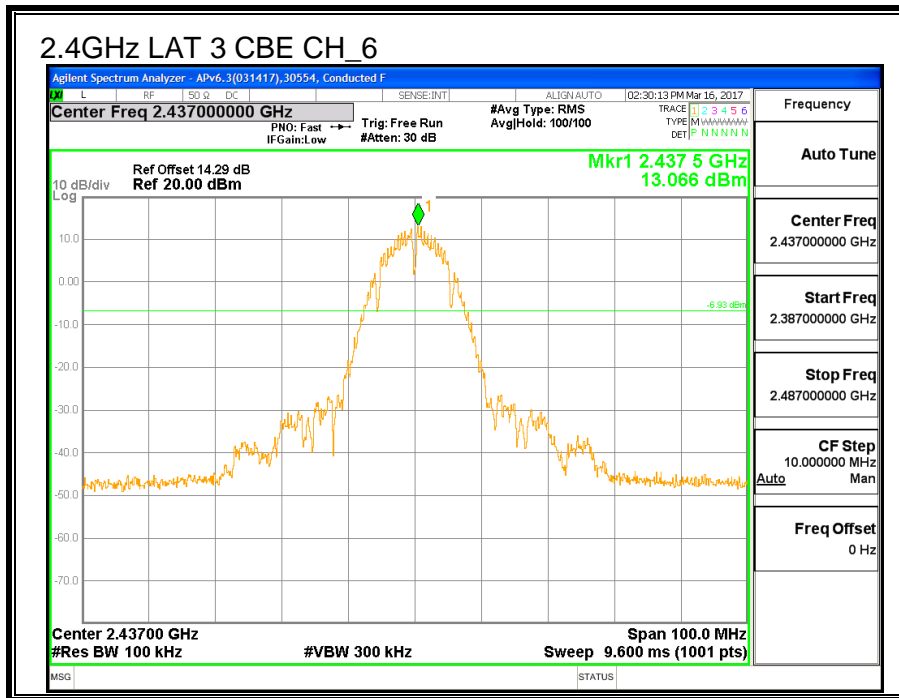
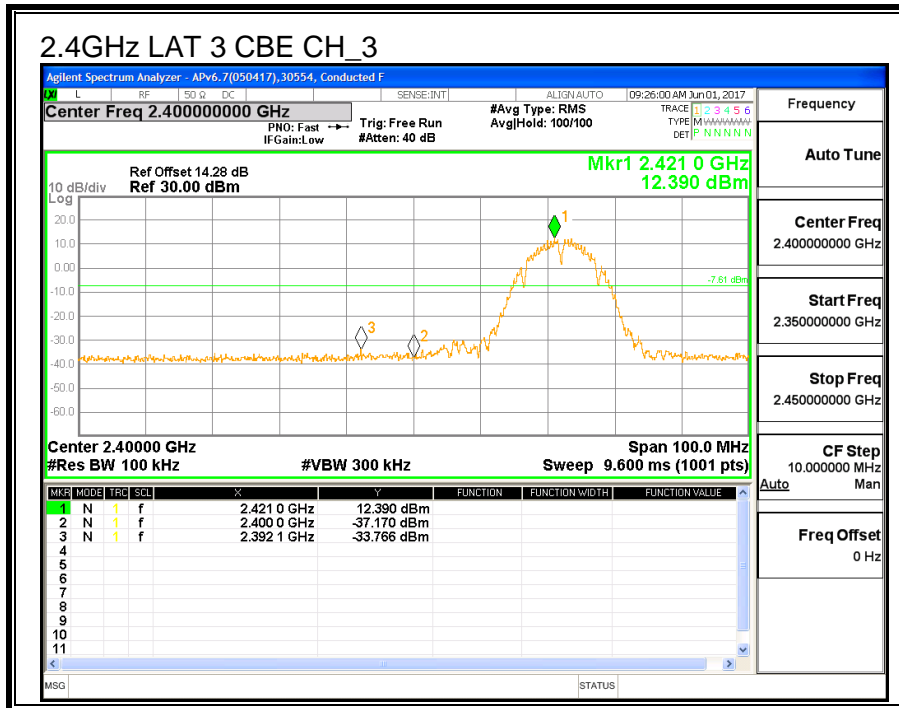

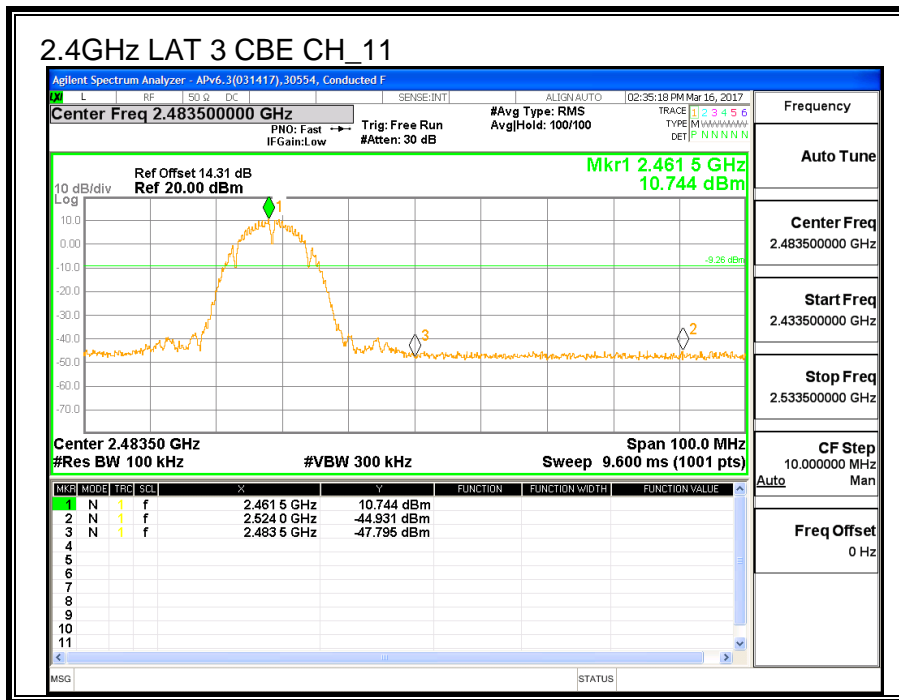
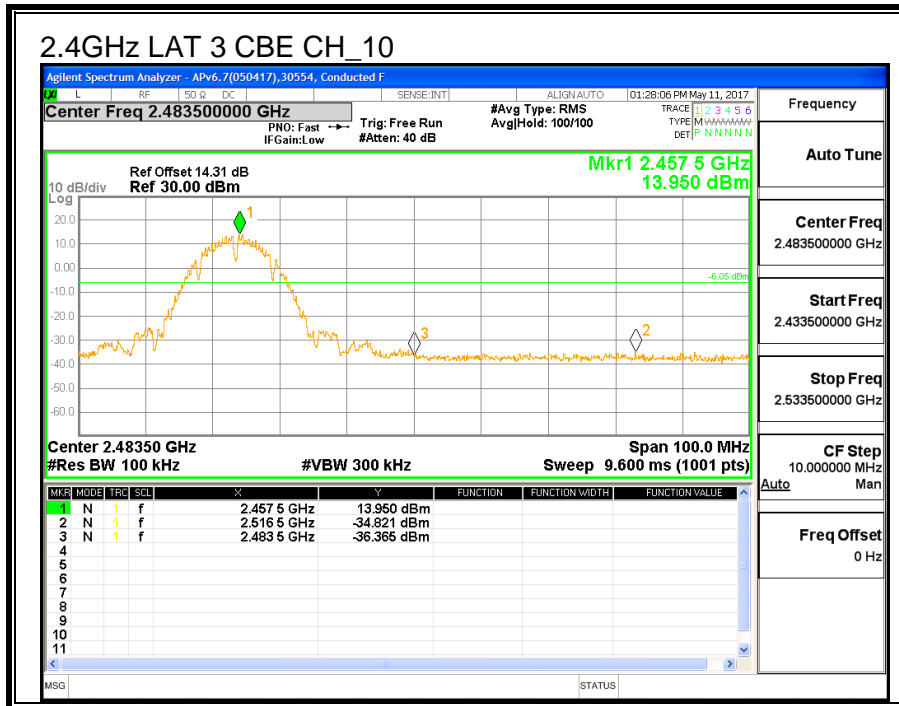

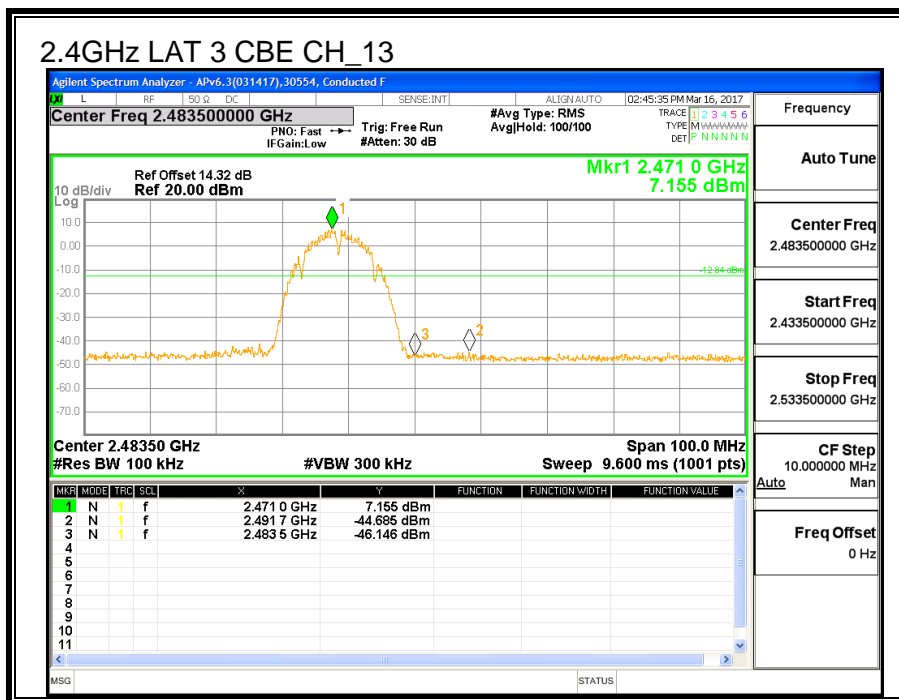
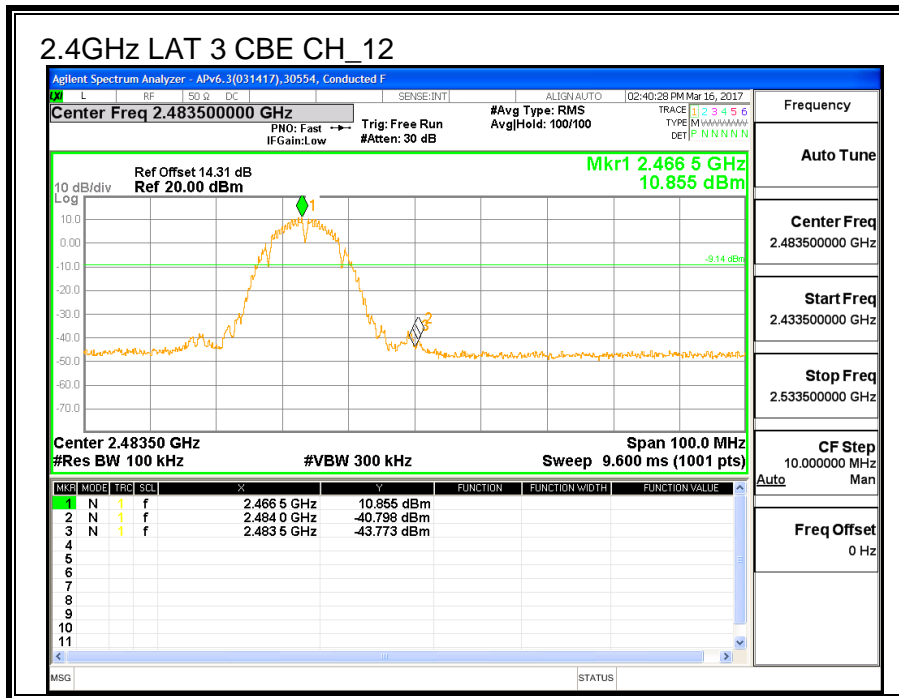

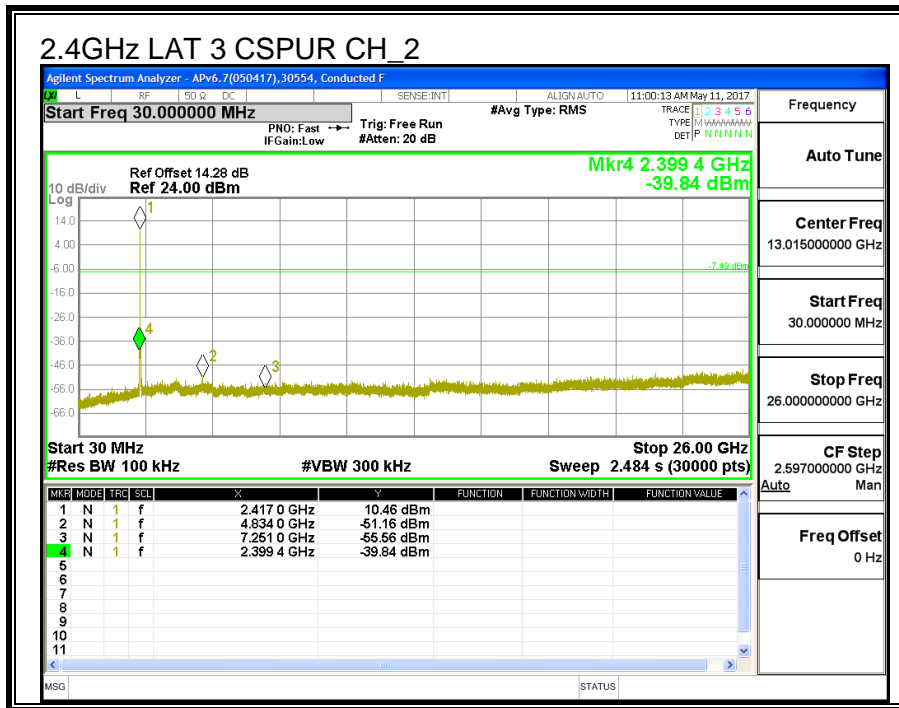
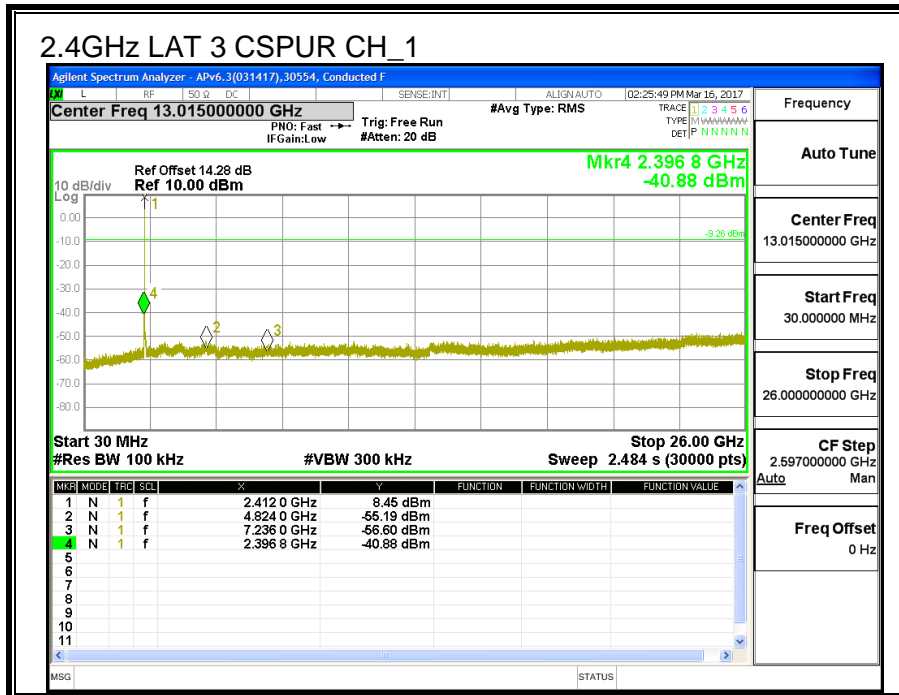

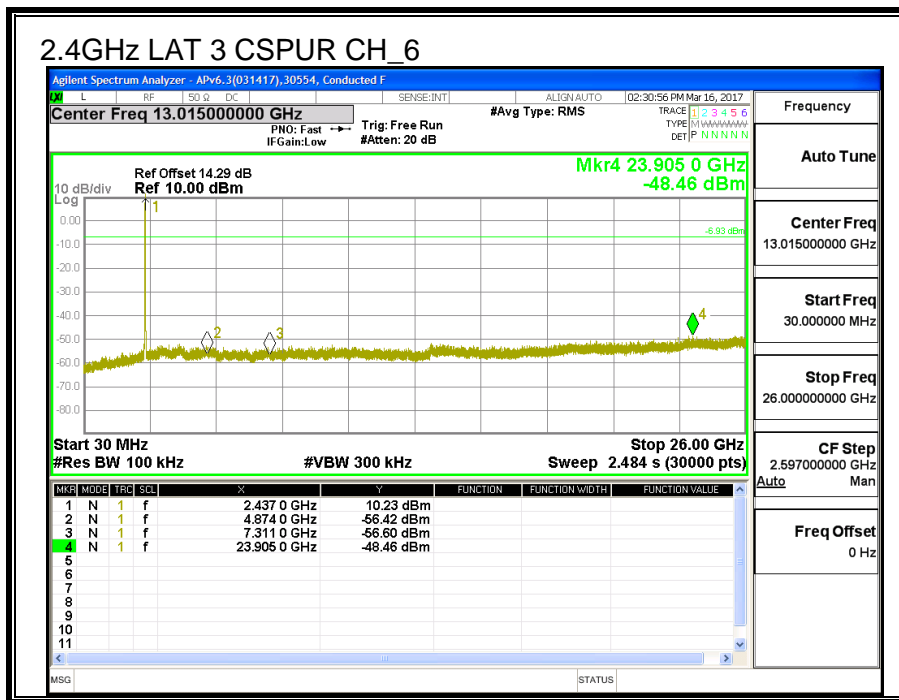
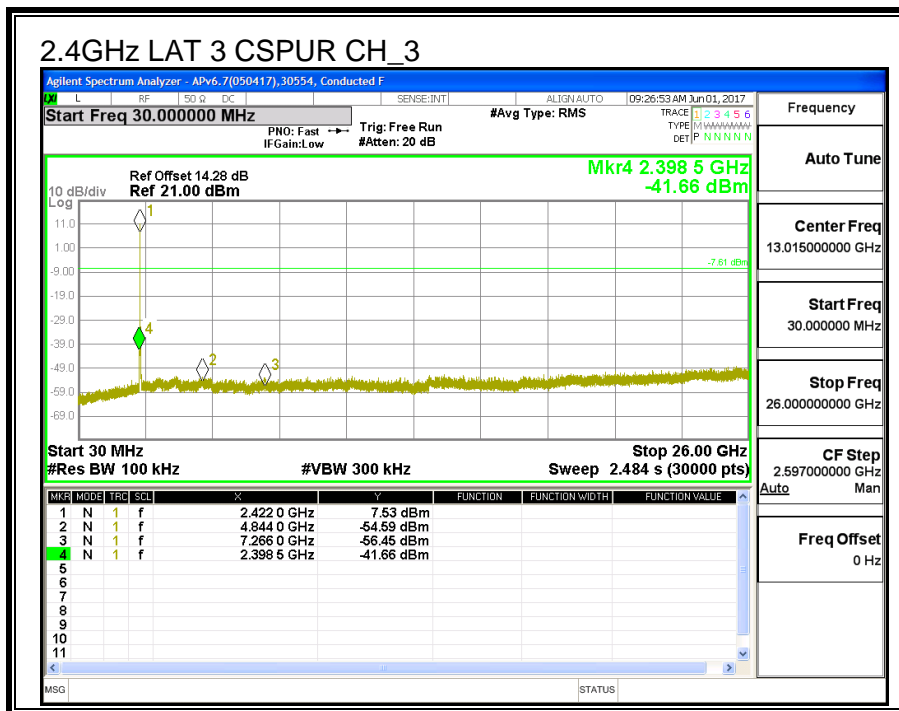

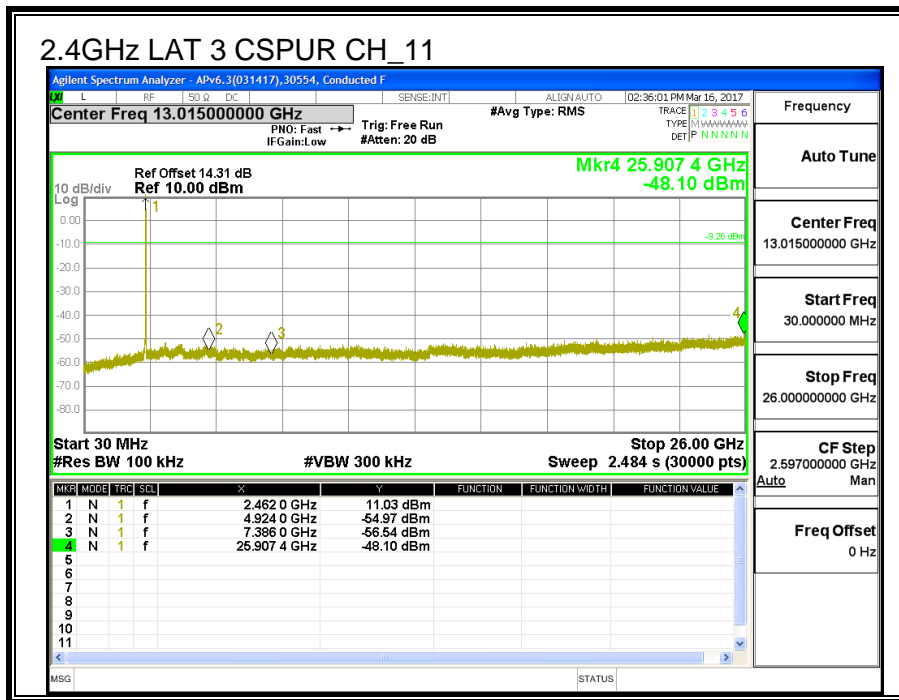
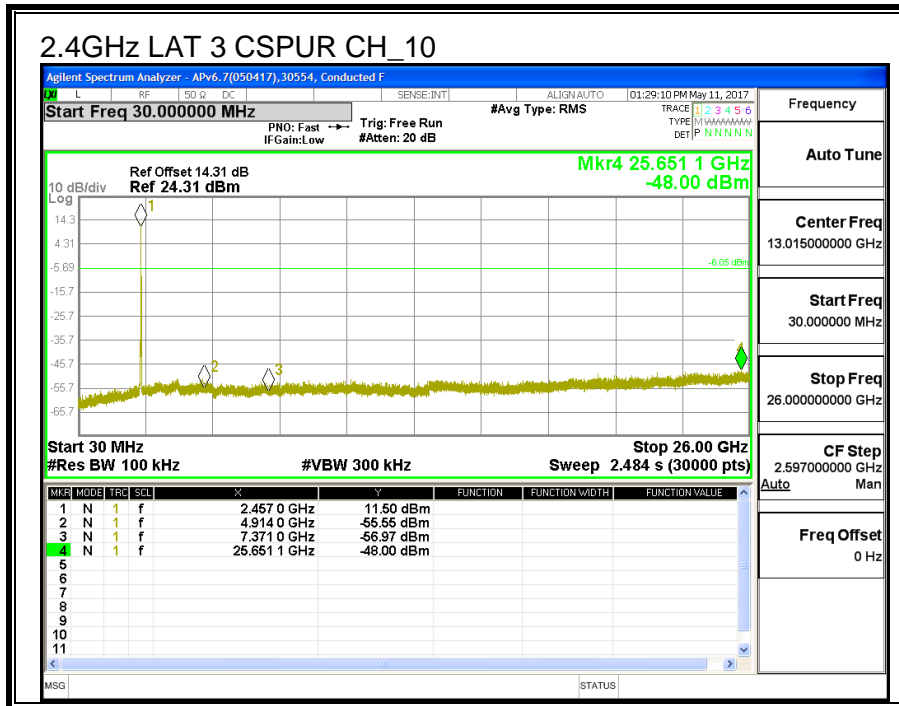

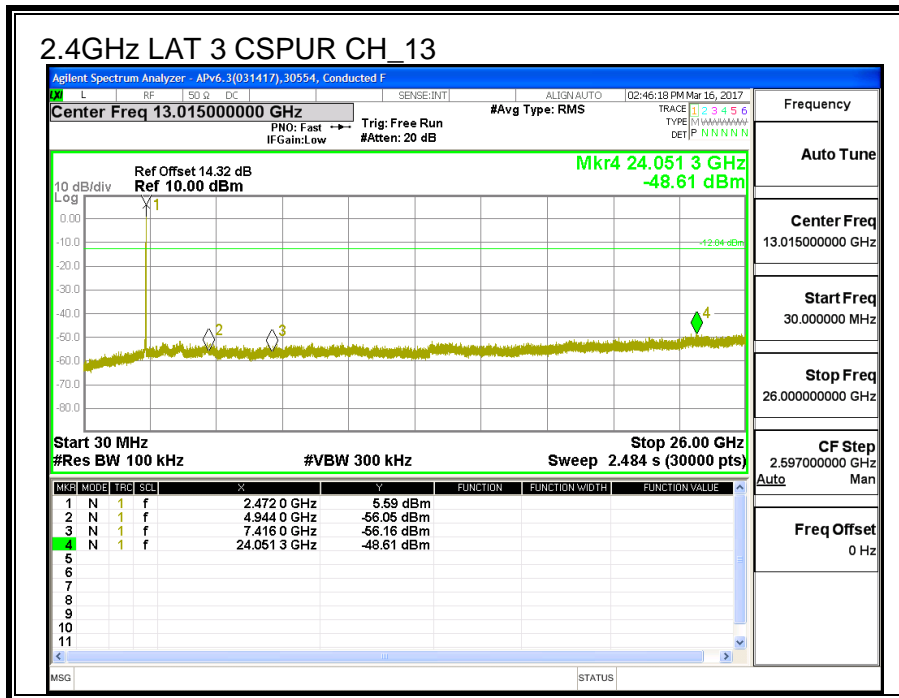
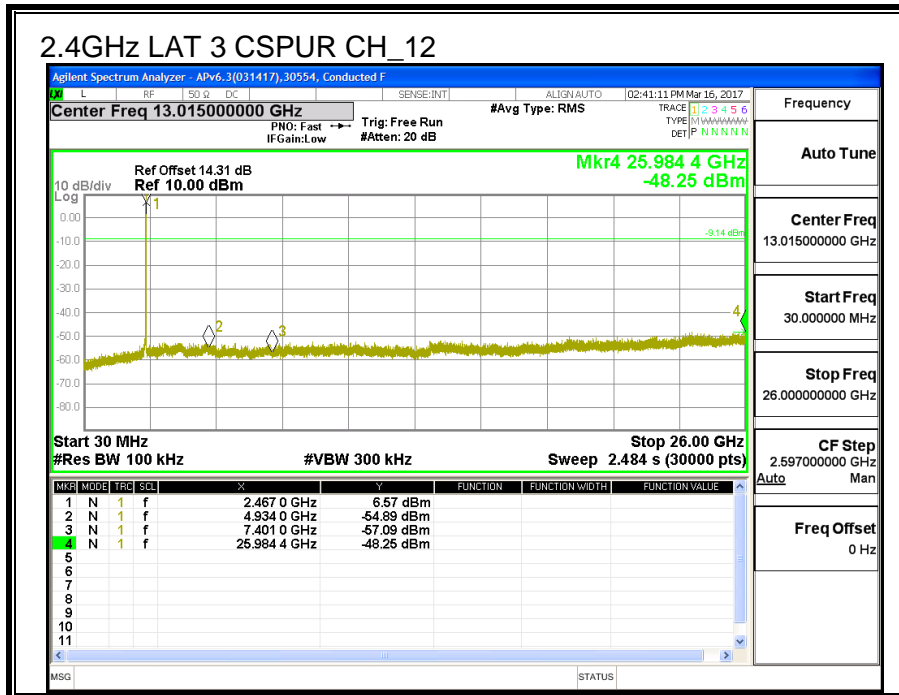

8.4. 11n HT20 UAT 1 SISO MODE IN THE 2.4GHz BAND

8.4.1. 6 dB BANDWIDTH

LIMITS

FCC §15.247 (a) (2)

IC RSS-247 (5.2) (a)

The minimum 6 dB bandwidth shall be at least 500 kHz.

RESULTS

Channel	Frequency	6 dB BW UAT 1 (MHz)	Minimum Limit (MHz)
Low_1	2412	16.500	0.5
Low_2	2417	17.110	0.5
Low_3	2422	17.605	0.5
Middle_6	2437	17.570	0.5
High_9	2452	17.63	0.5
High_10	2457	17.590	0.5
High_11	2462	14.895	0.5
High_12	2467	17.355	0.5
High_13	2472	15.785	0.5

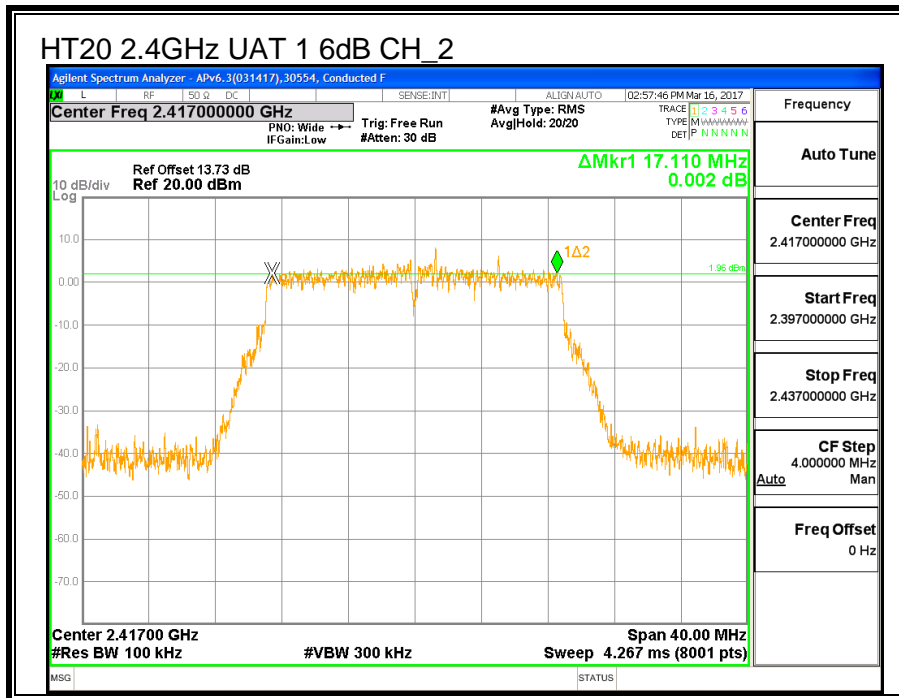
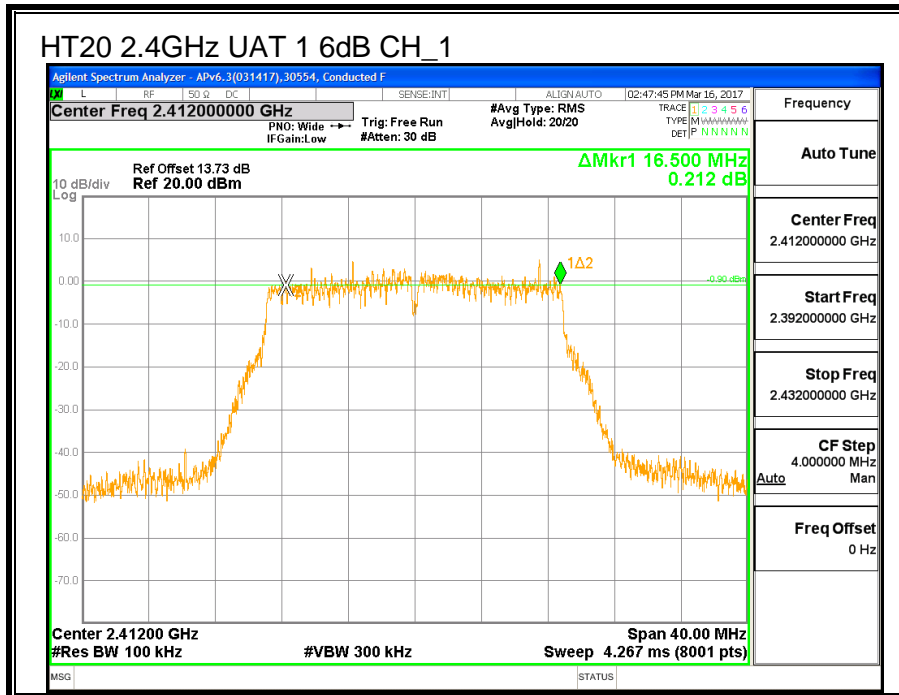

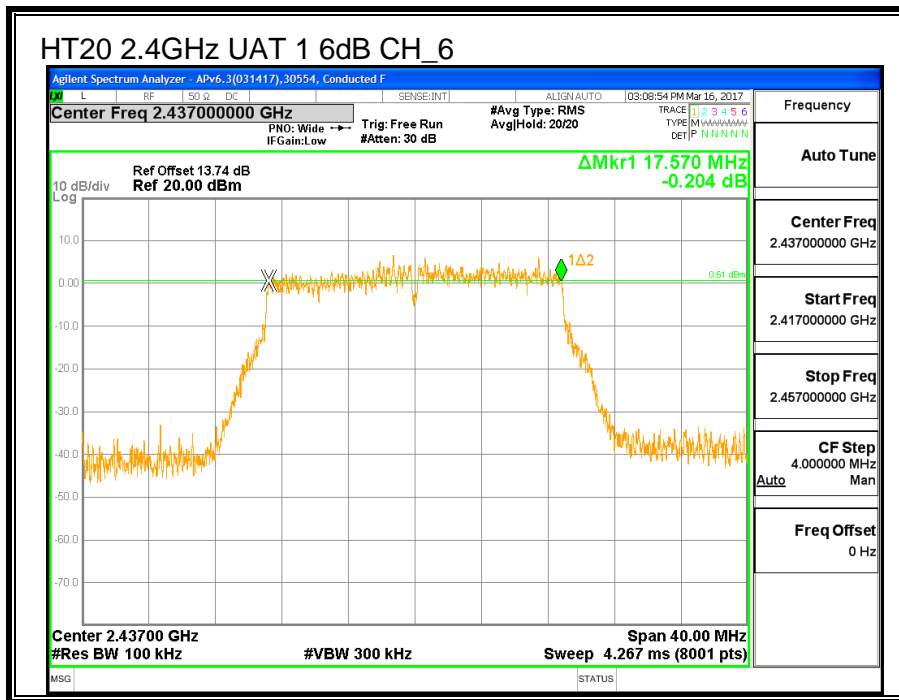
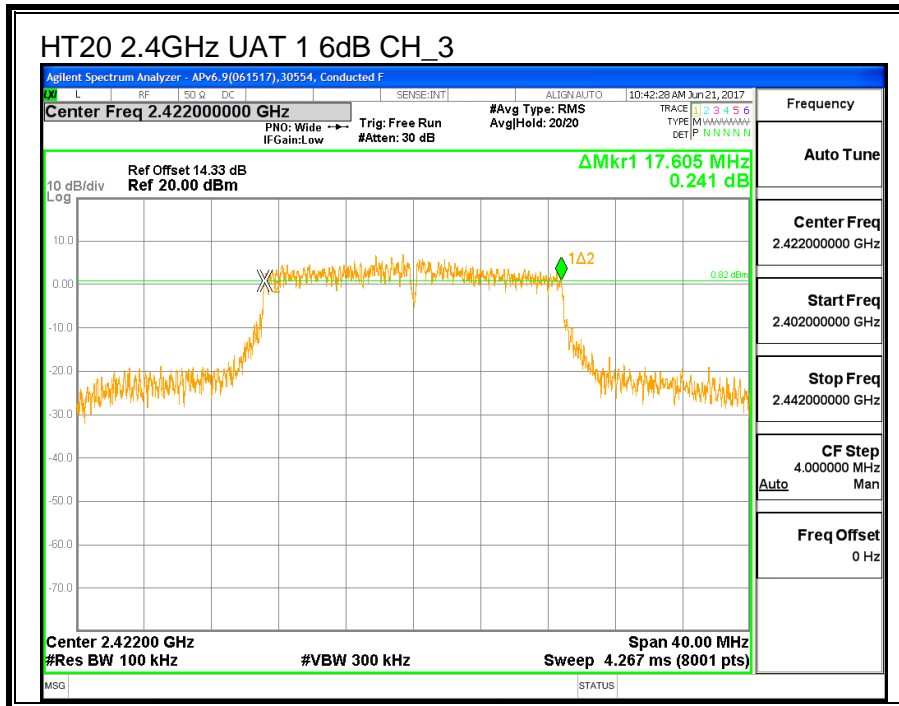

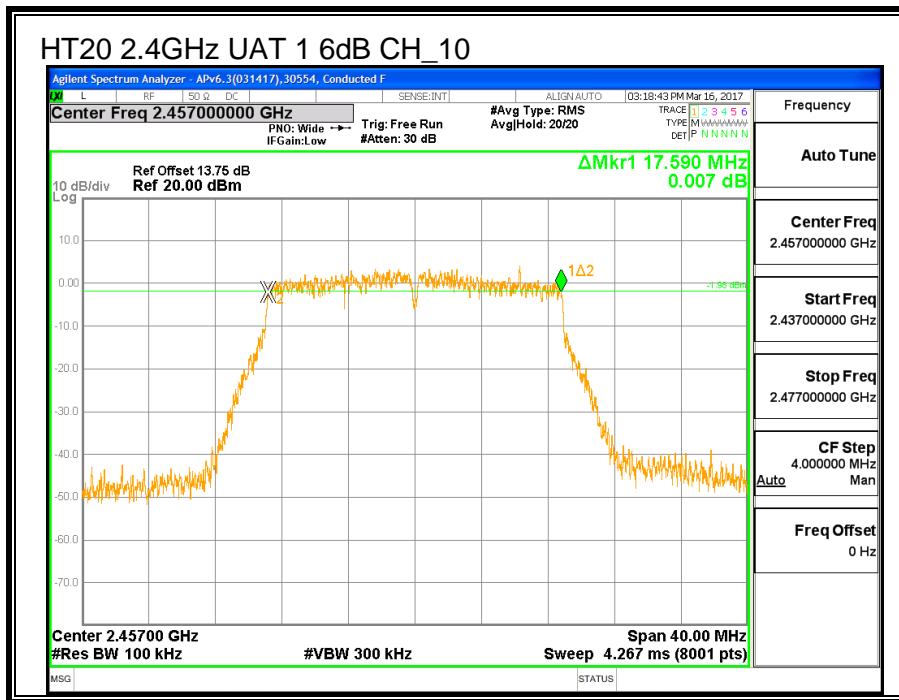
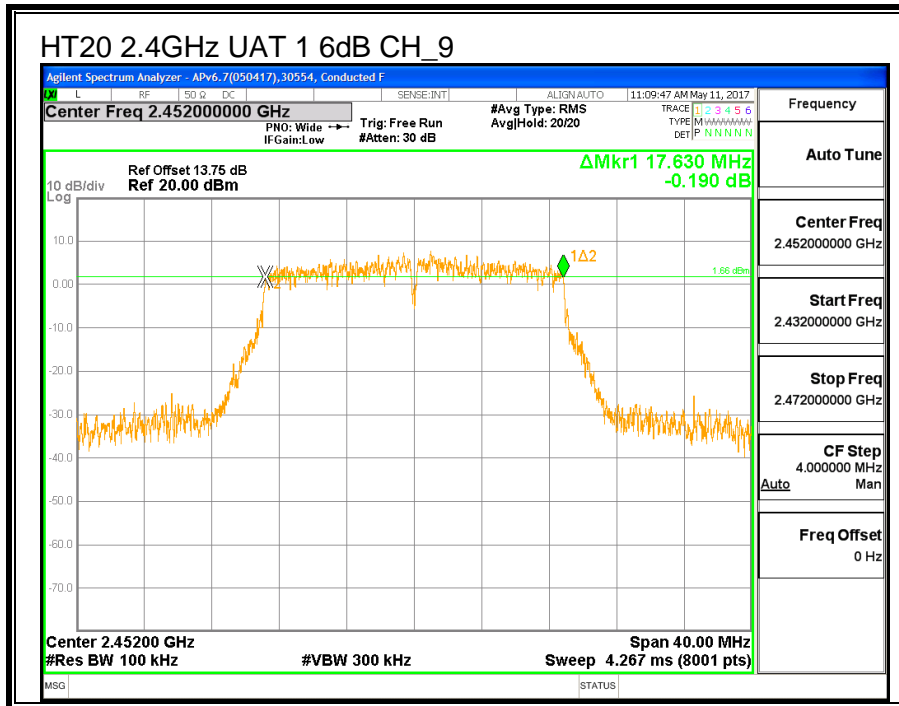

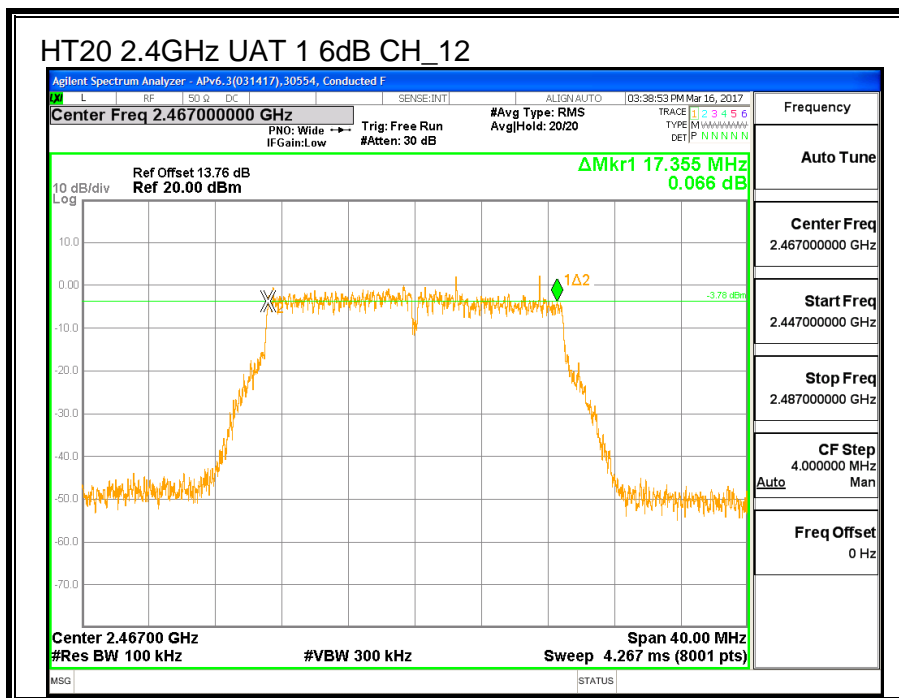
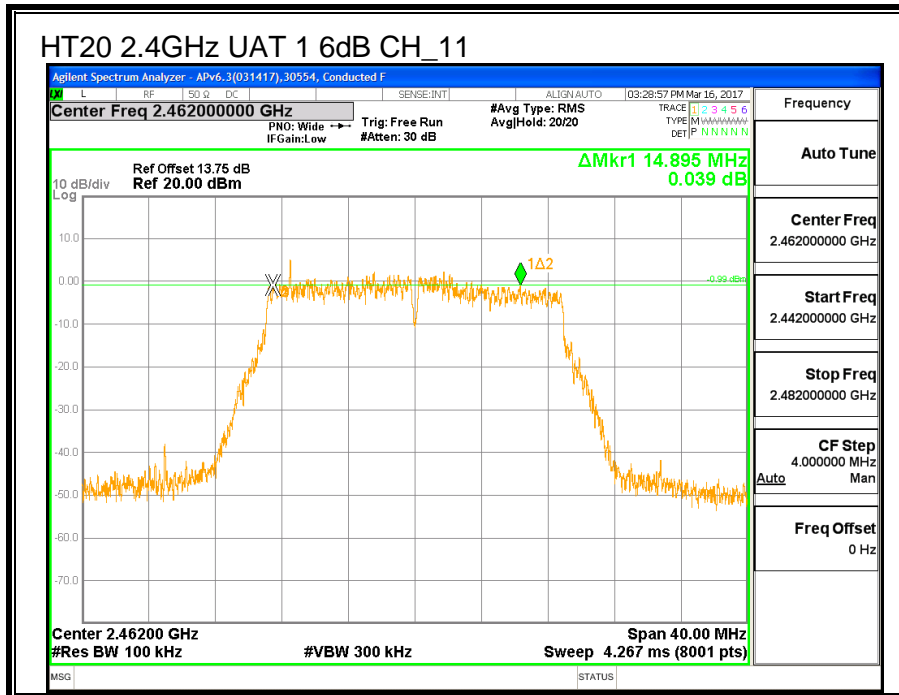

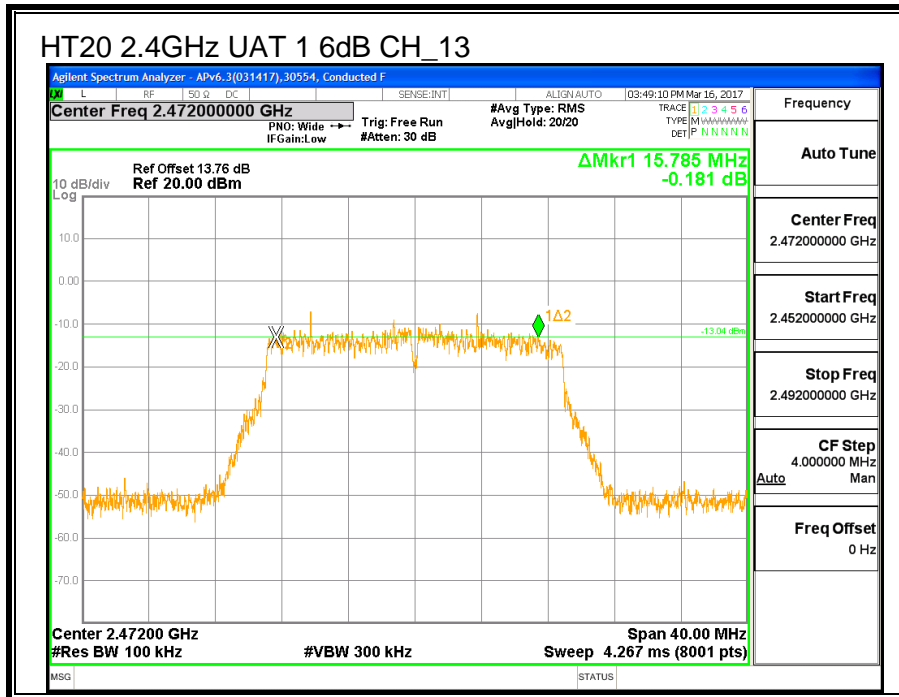

8.4.2. 99% BANDWIDTH

LIMITS

None; for reporting purposes only.

RESULTS

Channel	Frequency (MHz)	99% Bandwidth UAT 1 (MHz)
Low_1	2412	17.663
Low_2	2417	17.928
Low_3	2422	17.783
Middle_6	2437	17.761
High_9	2452	17.730
High_10	2457	17.622
High_11	2462	17.700
High_12	2467	17.791
High_13	2472	17.865

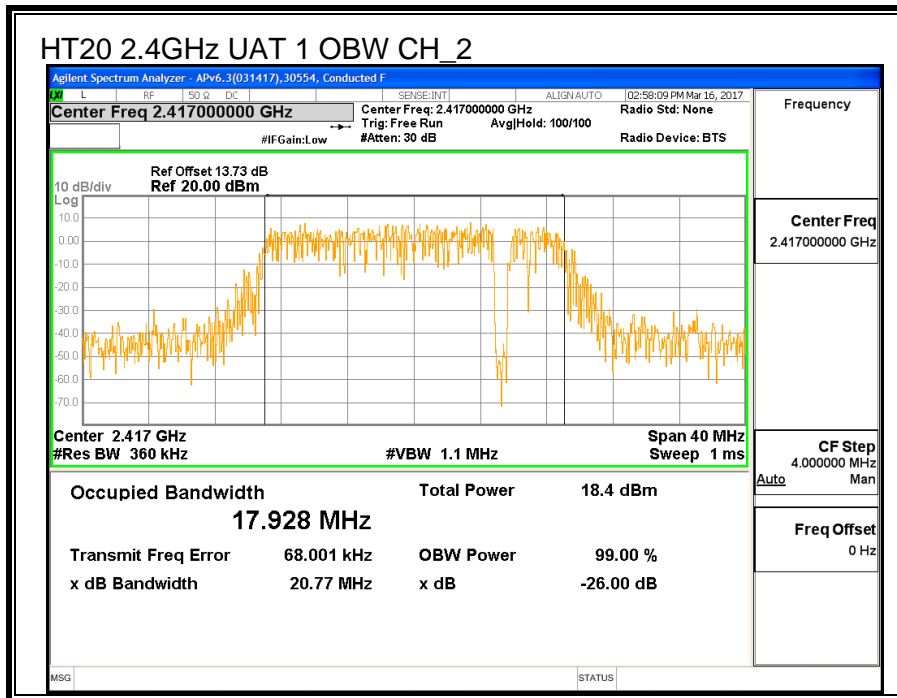
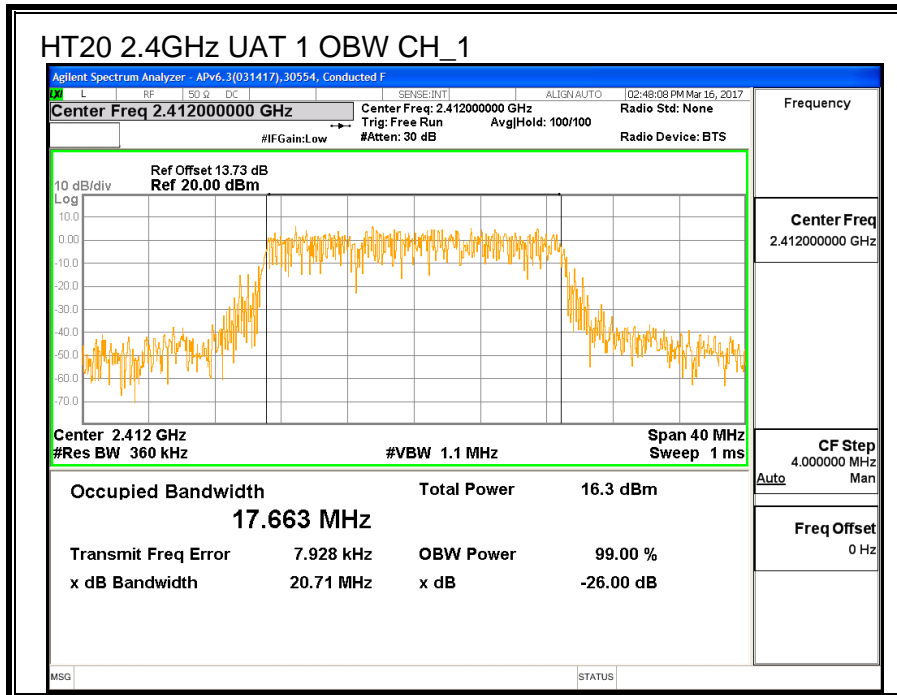

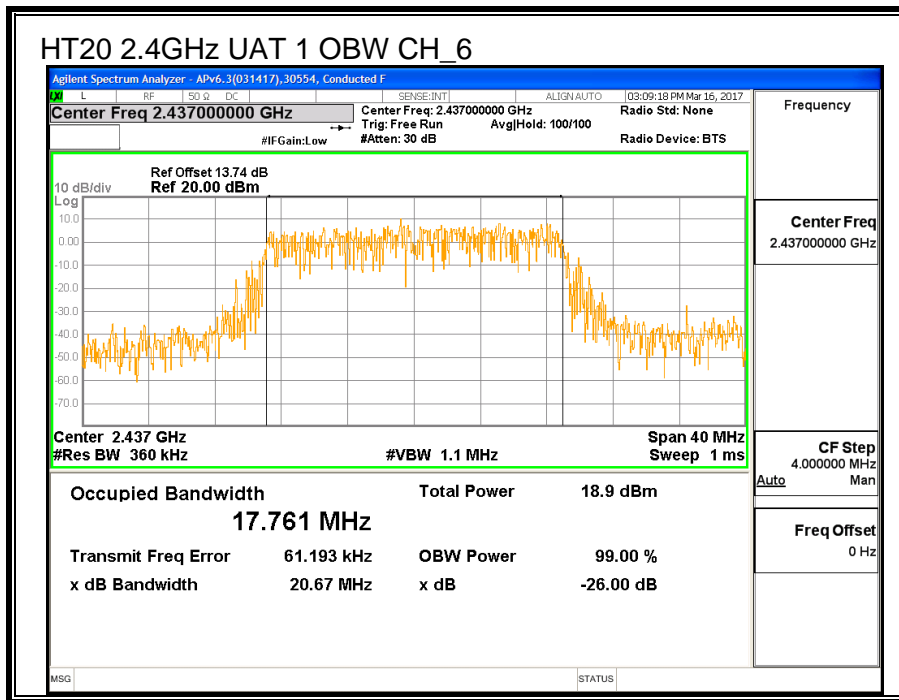
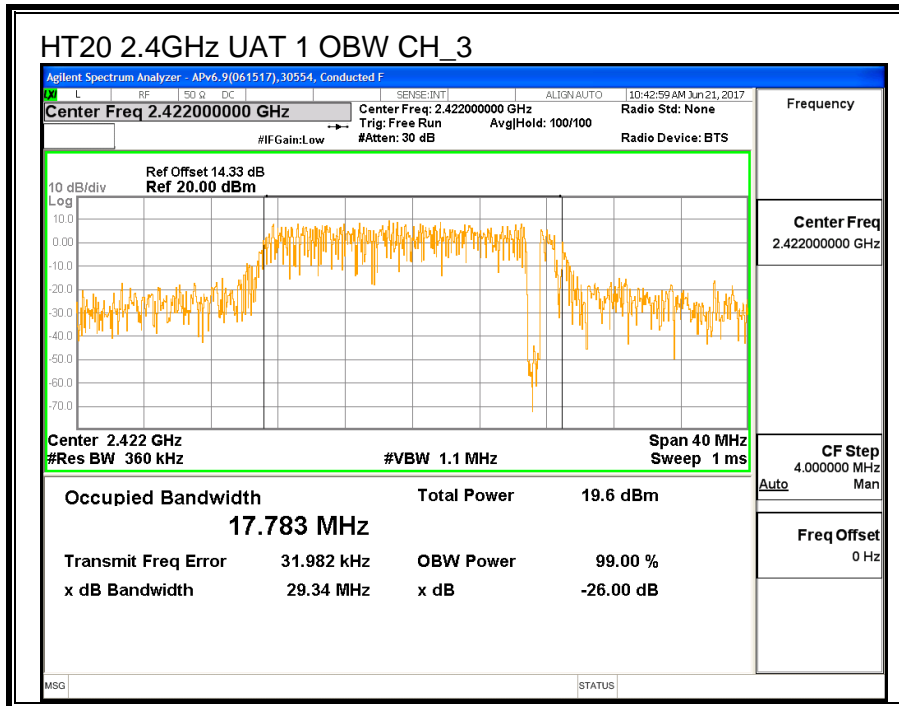

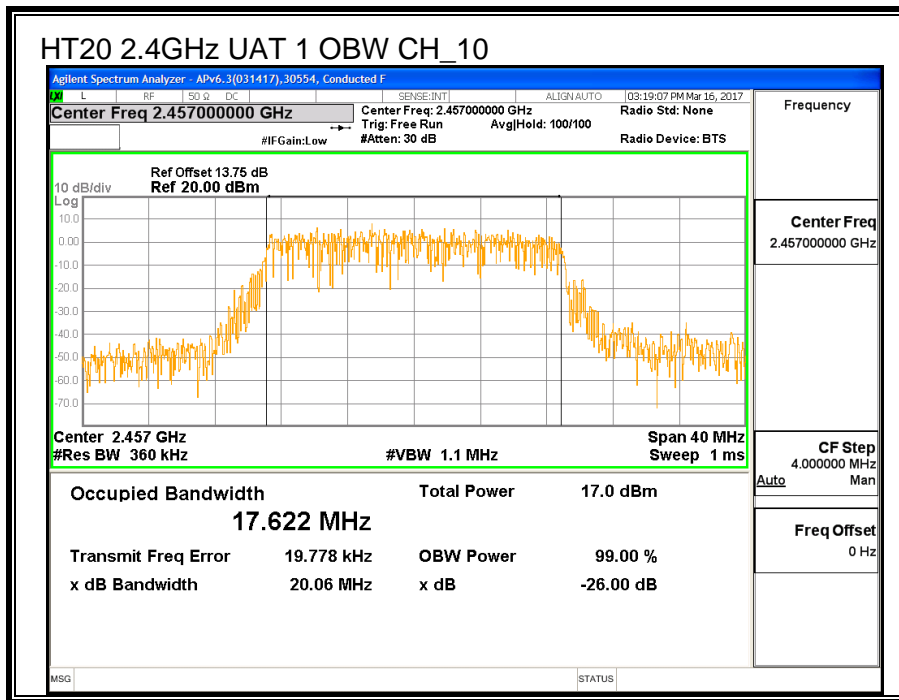
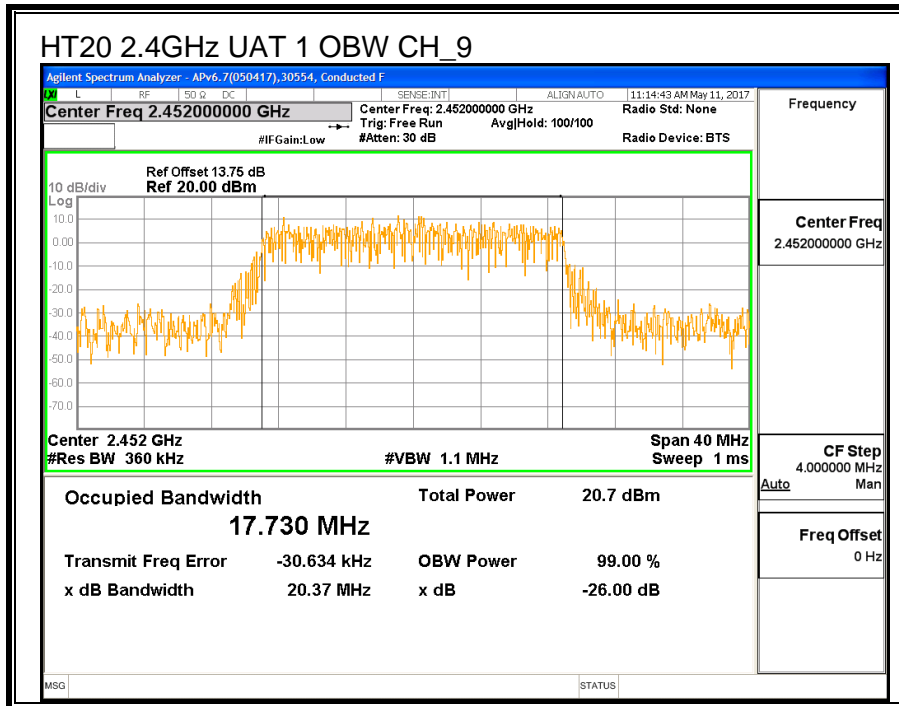

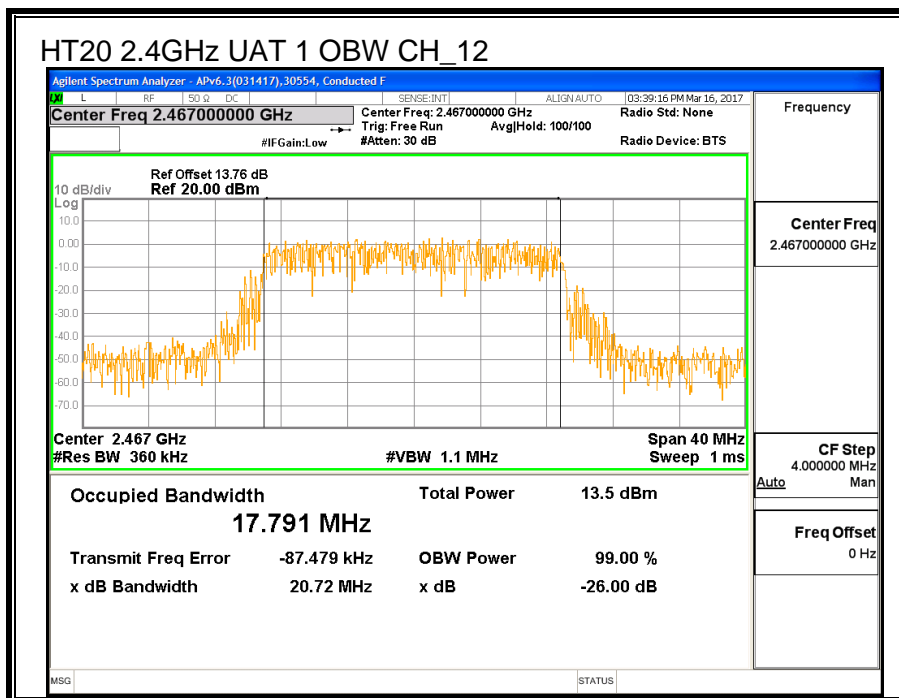
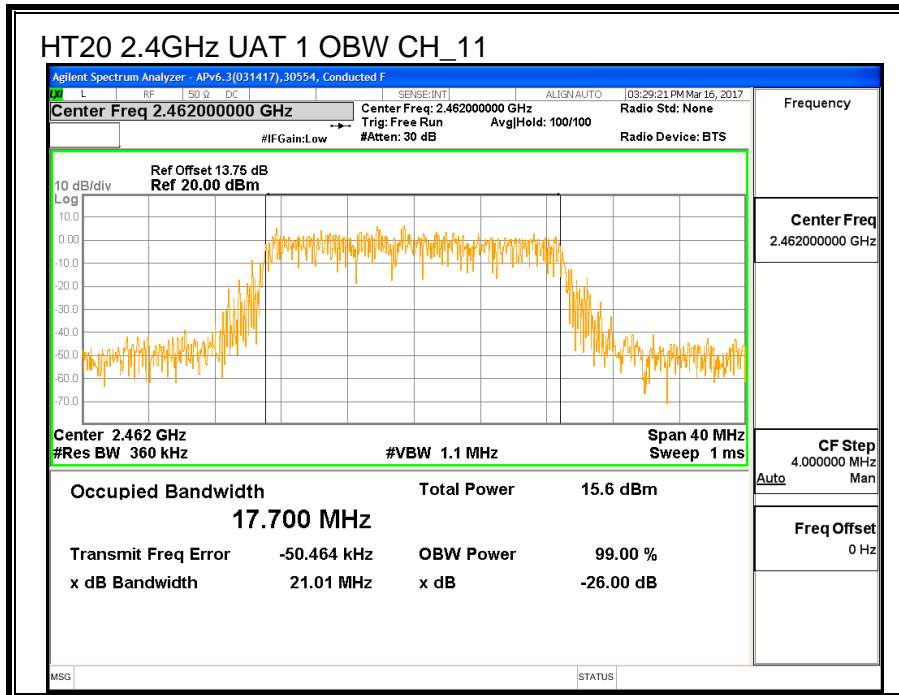

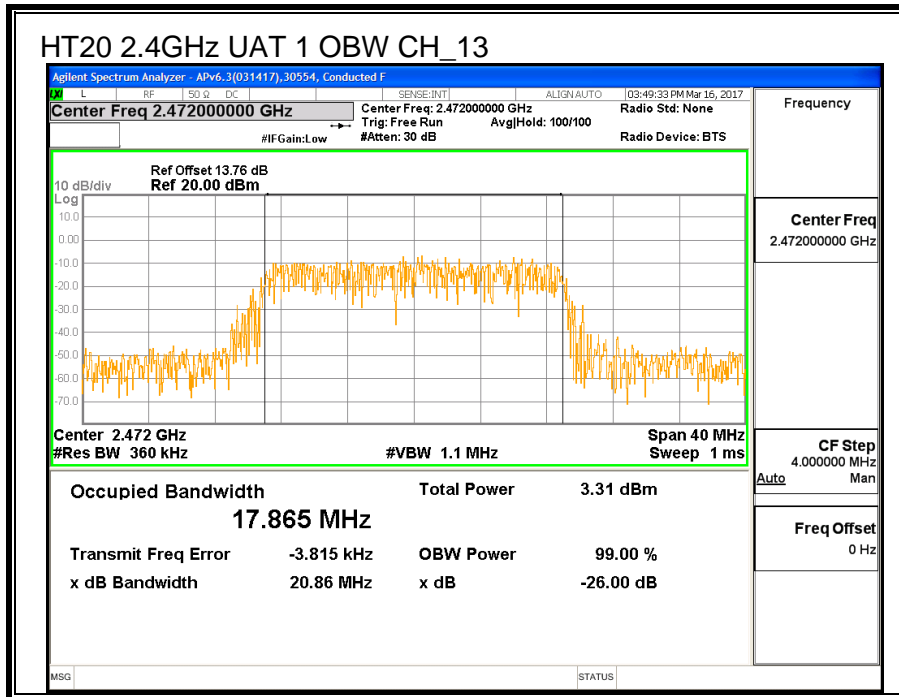

8.4.3. AVERAGE POWER

ID:	30554	Date:	6/14/2017
------------	-------	--------------	-----------

LIMITS

None; for reporting purposes only.

RESULTS

Channel	Frequency (MHz)	Power UAT 1 (MHz)
Low_1	2412	15.73
Low_2	2417	18.32
Low_3	2422	19.88
Middle_6	2437	20.86
High_9	2452	19.83
High_10	2457	17.32
High_11	2462	15.86
High_12	2467	13.34
High_13	2472	3.96

8.4.4. OUTPUT POWER

ID:	30554	Date:	6/14/2017
------------	-------	--------------	-----------

LIMITS

FCC §15.247

IC RSS-247 (5.4) (d)

For systems using digital modulation in the 2400–2483.5 MHz, and 5725–5850 MHz bands: 1 Watt, based on the use of antennas with directional gains that do not exceed 6 dBi. If transmitting antennas of directional gain greater than 6 dBi are used, the conducted output power from the intentional radiator shall be reduced by the amount in dB that the directional gain of the antenna exceeds 6 dBi.

DIRECTIONAL ANTENNA GAIN

There is only one transmitter output therefore the directional gain is equal to the antenna gain.

RESULTS

Limits

Channel	Frequency (MHz)	Directional Gain (dBi)	FCC Power Limit (dBm)	IC Power Limit (dBm)	IC EIRP Limit (dBm)	Max Power (dBm)
Low_1	2412	1.01	30.00	30	36	30.00
Low_2	2417	1.01	30.00	30	36	30.00
Low_3	2422	1.01	30.00	30	36	30.00
Mid	2437	1.01	30.00	30	36	30.00
High_9	2452	1.01	30.00	30	36	30.00
High_10	2457	1.01	30.00	30	36	30.00
High_11	2462	1.01	30.00	30	36	30.00
High_12	2467	1.01	30.00	30	36	30.00
High_13	2472	1.01	30.00	30	36	30.00

Duty Cycle CF (dB)	0.00	Included in Calculations of Corr'd Power
---------------------------	------	---

Results

Channel	Frequency (MHz)	Meas Power (dBm)	Total Corr'd Power (dBm)	Power Limit (dBm)	Margin (dB)
Low_1	2412	22.23	22.23	30.00	-7.77
Low_2	2417	24.82	24.82	30.00	-5.18
Low_3	2422	26.56	26.56	30.00	-3.44
Mid	2437	27.23	27.23	30.00	-2.77
High_9	2452	26.33	26.33	30.00	-3.67
High_10	2457	23.82	23.82	30.00	-6.18
High_11	2462	22.36	22.36	30.00	-7.64
High_12	2467	19.84	19.84	30.00	-10.16
High_13	2472	10.46	10.46	30.00	-19.54

8.4.5. POWER SPECTRAL DENSITY

LIMITS

FCC §15.247

IC RSS-247 (5.2) (b)

For digitally modulated systems, the power spectral density conducted from the intentional radiator to the antenna shall not be greater than 8 dBm in any 3 KHz band during any time interval of continuous transmissions.

RESULTS

Duty Cycle CF (dB)	0.00	Included in Calculations of Corr'd PSD
---------------------------	------	---

PSD Results

Channel	Frequency (MHz)	Meas (dBm/3kHz)	Total Corr'd PSD (dBm/3kHz)	Limit (dBm/3kHz)	Margin (dB)
Low_1	2412	-8.91	-8.91	8.0	-16.9
Low_2	2417	-7.03	-7.03	8.0	-15.0
Low_3	2422	-5.61	-5.61	8.0	-13.6
Mid	2437	-6.48	-6.48	8.0	-14.5
High_9	2452	-4.77	-4.77	8.0	-12.8
High_10	2457	-8.19	-8.19	8.0	-16.2
High_11	2462	-9.36	-9.36	8.0	-17.4
High_12	2467	-12.12	-12.12	8.0	-20.1
High_13	2472	-22.27	-22.27	8.0	-30.3

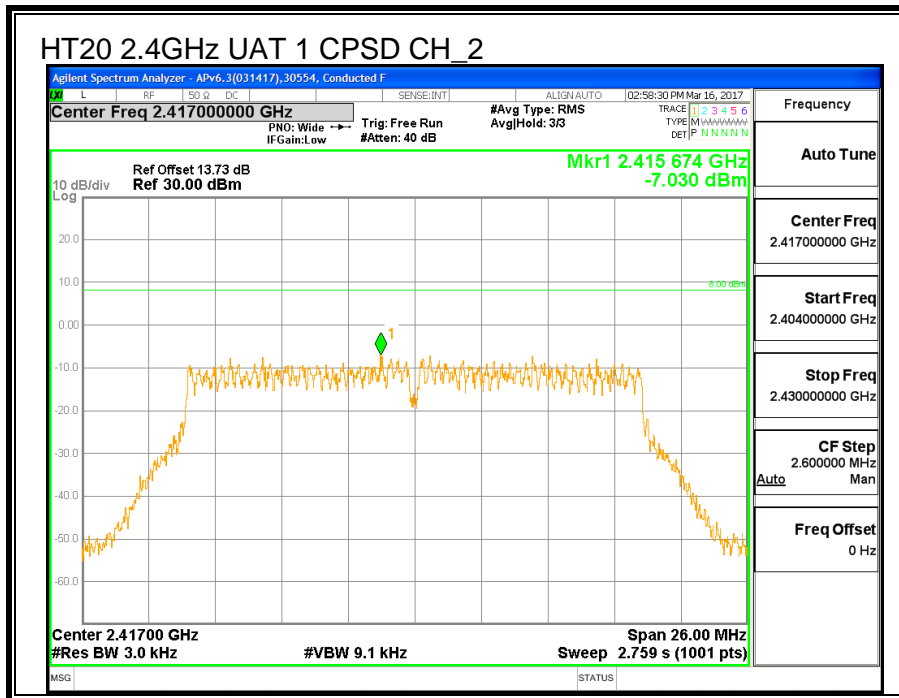
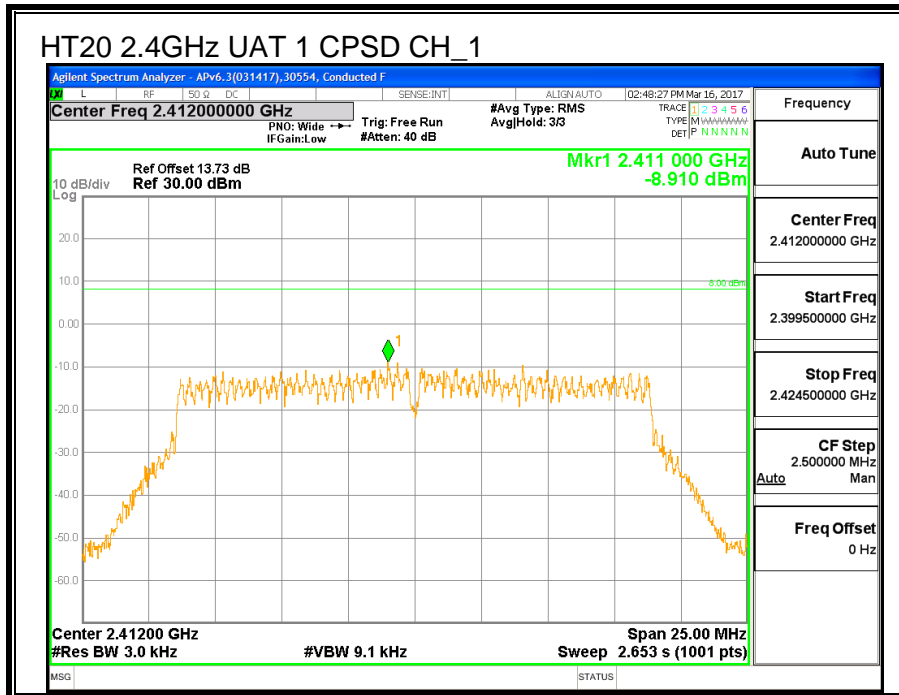

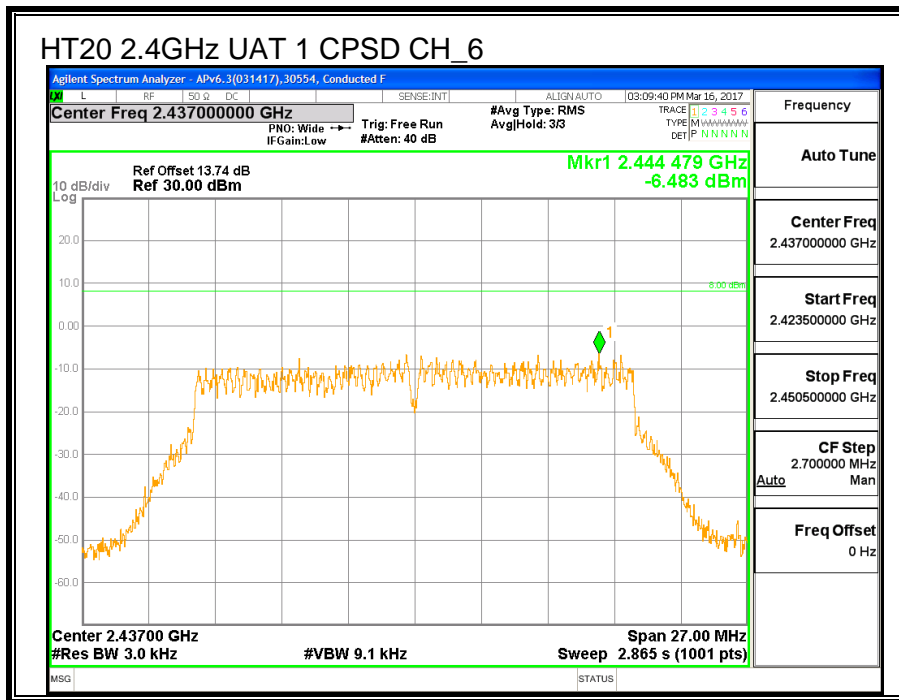
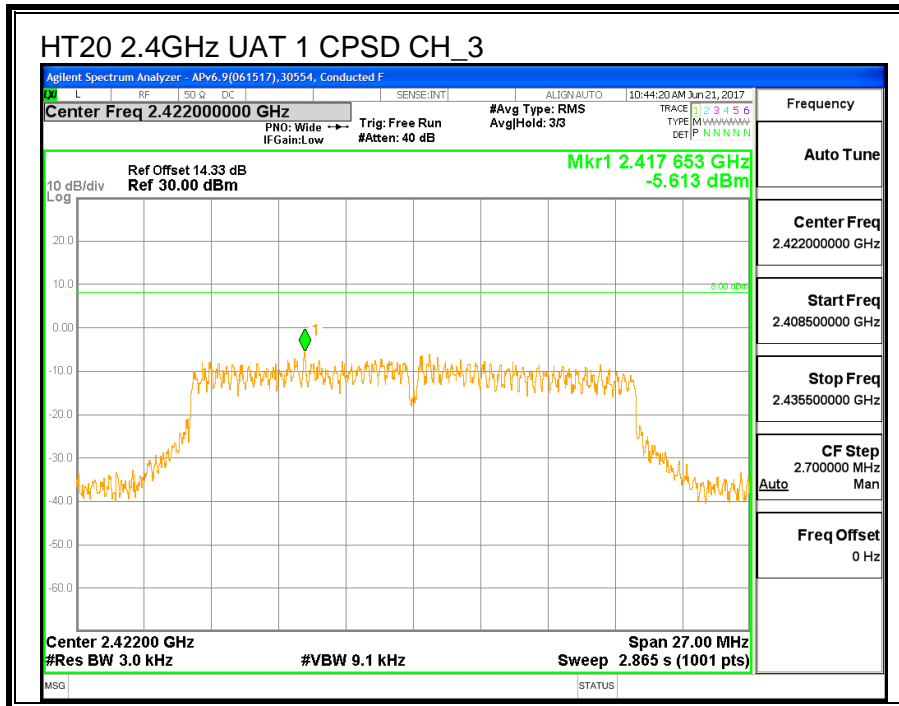

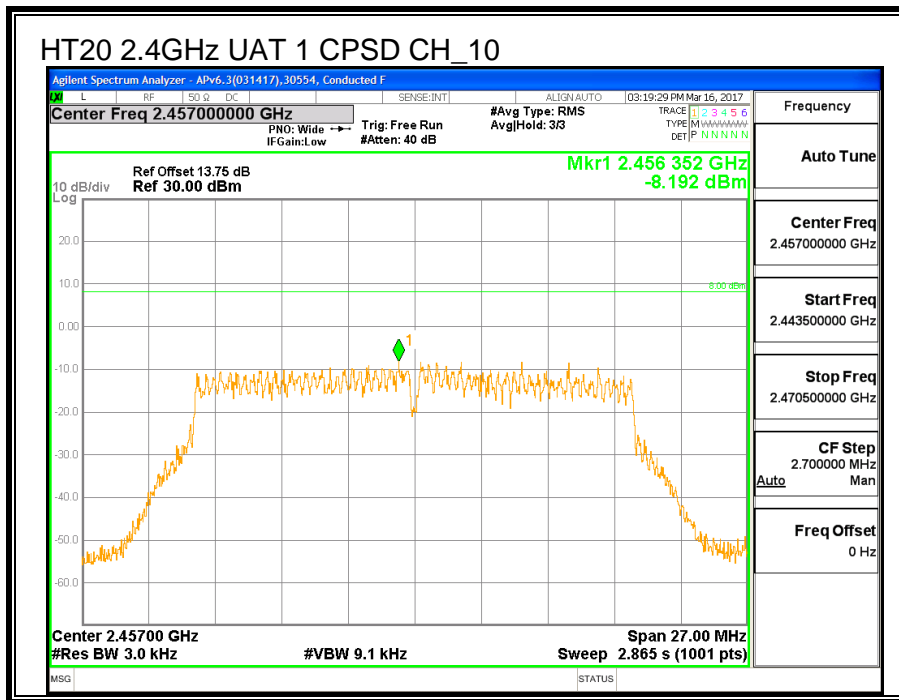
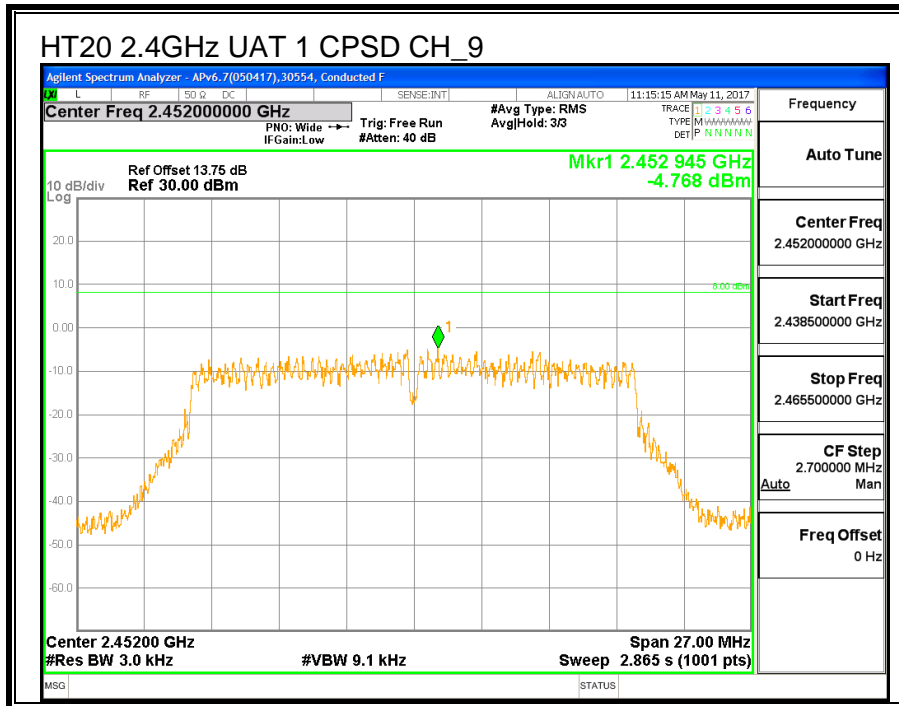

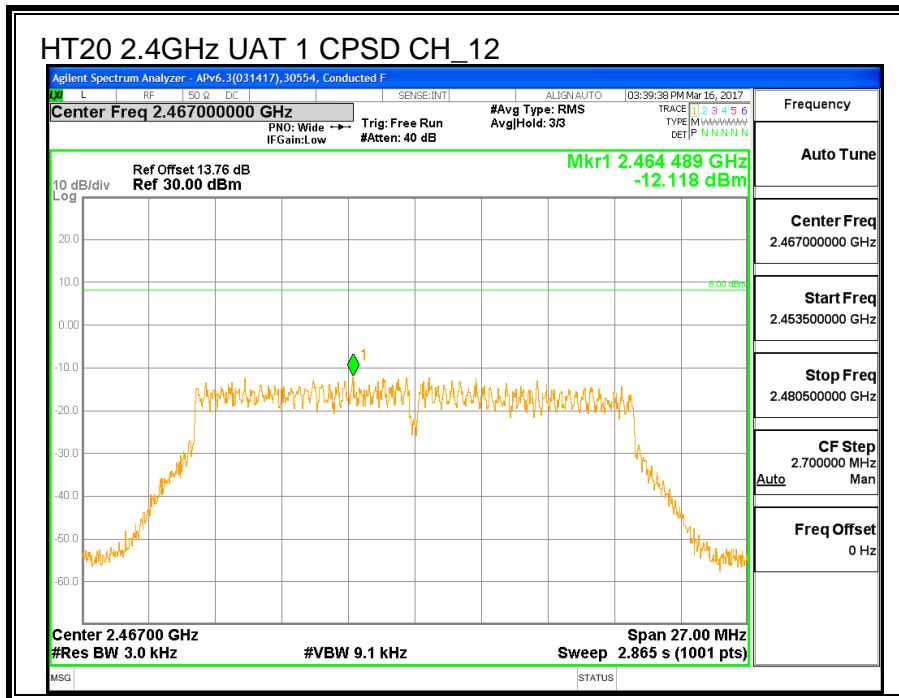
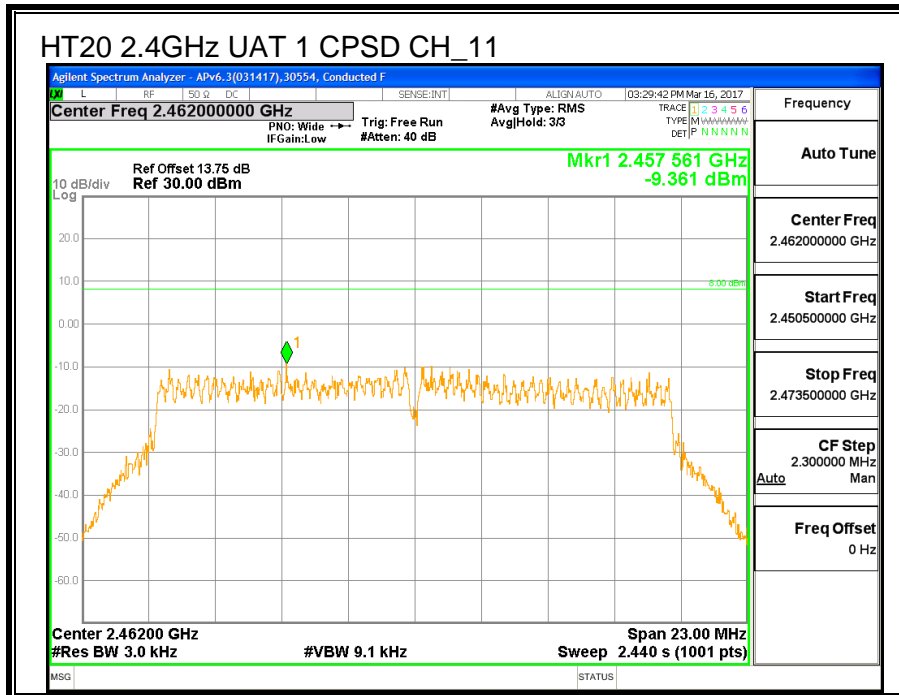

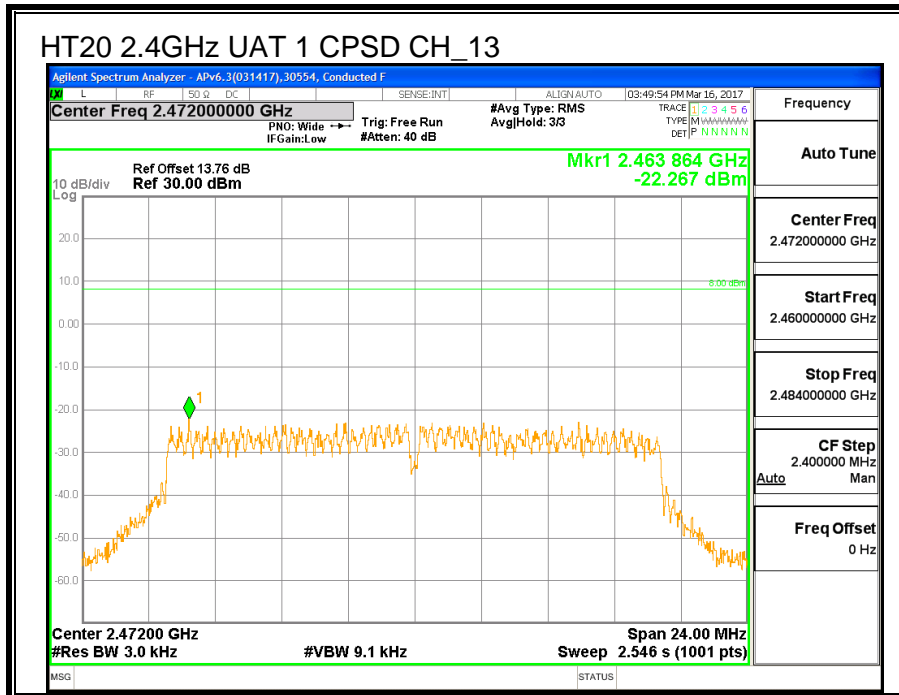

8.4.6. CONDUCTED BANDEDGE AND SPURIOUS EMISSIONS

LIMITS

FCC §15.247 (d)

IC RSS-247 (5.5)

In any 100 kHz bandwidth outside the frequency band in which the spread spectrum or digitally modulated intentional radiator is operating, the radio frequency power that is produced by the intentional radiator shall be at least 20 dB below that in the 100 kHz bandwidth within the band that contains the highest level of the desired power, based on either an RF conducted or a radiated measurement, provided the transmitter demonstrates compliance with the peak conducted power limits. If the transmitter complies with the conducted power limits based on the use of RMS averaging over a time interval, as permitted under paragraph (b)(3) of this section, the attenuation required under this paragraph shall be 30 dB instead of 20 dB. Attenuation below the general limits specified in §15.209(a) is not required.

RESULTS

