



**FCC CFR47 PART 15 SUBPART C
INDUSTRY CANADA RSS-210 ISSUE 8**

CERTIFICATION TEST REPORT

FOR

Cellular Phone with Bluetooth and WLAN Radios

MODEL: A1586

**FCC ID: BCG-E2816A
IC: 579C-E2816A**

REPORT NUMBER: 14U17673-E3 Revision C

ISSUE DATE: : AUGUST 02, 2014

Prepared for
**APPLE, INC.
1 INFINITE LOOP
CUPERTINO, CA 95014, U.S.A.**

Prepared by
**UL VERIFICATION SERVICES INC.
47173 BENICIA STREET
FREMONT, CA 94538, U.S.A.
TEL: (510) 771-1000
FAX: (510) 661-0888**



NVLAP LAB CODE 200065-0

Revision History

<u>Rev.</u>	<u>Issue Date</u>	<u>Revisions</u>	<u>Revised By</u>
--	7/10/14	Initial Issue	F. de Anda
A	7/23/14	Update- Section 10.4,; Section 11	D. Garcia
B	7/29/14	Update: to referenced reports	F. de Anda
C	08/02/14	Address TCB Questions	T. Lee

TABLE OF CONTENTS

1. ATTESTATION OF TEST RESULTS	4
2. TEST METHODOLOGY	5
3. FACILITIES AND ACCREDITATION	5
4. CALIBRATION AND UNCERTAINTY	5
5. EQUIPMENT UNDER TEST	7
5.1. <i>DESCRIPTION OF EUT</i>	7
5.2. <i>MAXIMUM OUTPUT POWER</i>	7
5.3. <i>DESCRIPTION OF AVAILABLE ANTENNAS</i>	7
5.4. <i>SOFTWARE AND FIRMWARE.....</i>	7
5.5. <i>WORST-CASE CONFIGURATION AND MODE.....</i>	7
5.6. <i>DESCRIPTION OF TEST SETUP.....</i>	8
6. TEST AND MEASUREMENT EQUIPMENT	12
7. MEASUREMENT METHODS	13
8. ON TIME, DUTY CYCLE AND MEASUREMENT METHODS	14
8.1. <i>ON TIME AND DUTY CYCLE RESULTS.....</i>	14
8.2. <i>DUTY CYCLE PLOTS</i>	15
9. ANTENNA PORT TEST RESULTS	16
9.1. <i>6 dB BANDWIDTH.....</i>	16
9.2. <i>99% BANDWIDTH.....</i>	19
9.3. <i>OUTPUT POWER</i>	22
9.4. <i>AVERAGE POWER.....</i>	25
9.5. <i>POWER SPECTRAL DENSITY.....</i>	26
9.6. <i>CONDUCTED SPURIOUS EMISSIONS.....</i>	29
10. RADIATED TEST RESULTS.....	33
10.1. <i>LIMITS AND PROCEDURE.....</i>	33
10.2. <i>TRANSMITTER ABOVE 1 GHz.....</i>	34
10.3. <i>WORST-CASE ABOVE 18 GHz</i>	44
10.4. <i>WORST-CASE BELOW 1 GHz.....</i>	45
11. AC POWER LINE CONDUCTED EMISSIONS.....	48
12. SETUP PHOTOS.....	52

1. ATTESTATION OF TEST RESULTS

COMPANY NAME: APPLE, INC.
1 INFINITE LOOP
CUPERTINO, CA 95014, U.S.A.

EUT DESCRIPTION: Cellular Phone with Bluetooth and WLAN Radios

MODEL: A1586

SERIAL NUMBER: C39MF01KFY6W - Conducted, C39MN06LG337 – Radiated

DATE TESTED: APRIL 10-JUNE 10, 2014

APPLICABLE STANDARDS	
STANDARD	TEST RESULTS
CFR 47 Part 15 Subpart C	Pass
INDUSTRY CANADA RSS-210 Issue 8 Annex 8	Pass
INDUSTRY CANADA RSS-GEN Issue 3	Pass

UL Verification Services Inc. tested the above equipment in accordance with the requirements set forth in the above standards. All indications of Pass/Fail in this report are opinions expressed by UL Verification Services based on interpretations and/or observations of test results. Measurement Uncertainties were not taken into account and are published for informational purposes only. The test results show that the equipment tested is capable of demonstrating compliance with the requirements as documented in this report.

Note: The results documented in this report apply only to the tested sample, under the conditions and modes of operation as described herein. This document may not be altered or revised in any way unless done so by UL Verification Services and all revisions are duly noted in the revisions section. Any alteration of this document not carried out by UL Verification Services will constitute fraud and shall nullify the document. This report must not be used by the client to claim product certification, approval, or endorsement by NVLAP, NIST, any agency of the Federal Government, or any agency of any government.

Approved & Released For
UL Verification Services Inc. By:



David Garcia
Senior Engineer
UL Verification Services Inc.

Tested By:

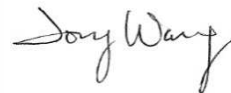

Tony Wang
Lab Engineer
UL Verification Services Inc

2. TEST METHODOLOGY

The tests documented in this report were performed in accordance with ANSI C63.10-2009, FCC CFR 47 Part 2, FCC CFR 47 Part 15, RSS-GEN Issue 3, and RSS-210 Issue 8.

3. FACILITIES AND ACCREDITATION

The test sites and measurement facilities used to collect data are located at 47173 and 47266 Benicia Street, Fremont, California, USA. Line conducted emissions are measured only at the 47173 address. The following table identifies which facilities were utilized for radiated emission measurements documented in this report. Specific facilities are also identified in the test results sections.

47173 Benicia Street	47266 Benicia Street
<input type="checkbox"/> Chamber A	<input checked="" type="checkbox"/> Chamber D
<input type="checkbox"/> Chamber B	<input checked="" type="checkbox"/> Chamber E
<input type="checkbox"/> Chamber C	<input type="checkbox"/> Chamber F
	<input type="checkbox"/> Chamber G
	<input type="checkbox"/> Chamber H

UL Verification Services Inc. is accredited by NVLAP, Laboratory Code 200065-0. The full scope of accreditation can be viewed at <http://ts.nist.gov/standards/scopes/2000650.htm>.

4. CALIBRATION AND UNCERTAINTY

4.1. MEASURING INSTRUMENT CALIBRATION

The measuring equipment utilized to perform the tests documented in this report has been calibrated in accordance with the manufacturer's recommendations, and is traceable to recognized national standards.

4.2. SAMPLE CALCULATION

Where relevant, the following sample calculation is provided:

$$\begin{aligned} \text{Field Strength (dBuV/m)} &= \text{Measured Voltage (dBuV)} + \text{Antenna Factor (dB/m)} + \\ &\text{Cable Loss (dB)} - \text{Preamp Gain (dB)} \\ 36.5 \text{ dBuV} + 18.7 \text{ dB/m} + 0.6 \text{ dB} - 26.9 \text{ dB} &= 28.9 \text{ dBuV/m} \end{aligned}$$

4.3. MEASUREMENT UNCERTAINTY

Where relevant, the following measurement uncertainty levels have been estimated for tests performed on the apparatus:

PARAMETER	UNCERTAINTY
Conducted Disturbance, 0.15 to 30 MHz	± 3.52 dB
Radiated Disturbance, 30 to 1000 MHz	± 4.94 dB

Uncertainty figures are valid to a confidence level of 95%.

5. EQUIPMENT UNDER TEST

5.1. DESCRIPTION OF EUT

Model A1586 is a mobile phone with multimedia functions (music, application support, and video), Cellular GSM/GPRS/EGPRS/CDMA2000/EVDO Rev.A/ EVDO Rev.B/WCDMA/HSPA+/DC-HSDPA/LTE FDD & Carrier Aggregation/TDD/TD-SCDMA radio, IEEE 802.11a/b/g/n/ac radio, Bluetooth radio and NFC. The rechargeable battery is not user accessible.

5.2. MAXIMUM OUTPUT POWER

The transmitter has a maximum peak conducted output power as follows:

Frequency Range (MHz)	Mode	Output Power (dBm)	Output Power (mW)
2402 - 2480	BLE	12.06	16.07

5.3. DESCRIPTION OF AVAILABLE ANTENNAS

The radio utilizes a PiFA antenna, with a maximum gain of -.38dBi.

5.4. SOFTWARE AND FIRMWARE

The test utility software used during testing was Bluetool 1.8.5

5.5. WORST-CASE CONFIGURATION AND MODE

The worst-case mode and channel used for 30-1000 MHz radiated and power line conducted emissions was including headset, AC charger and the mode and channel with the highest output power.

The worst-position was the EUT with highest emissions. To determine the worst-case, the EUT is a portable device that has three orientations; therefore X, Y and Z orientations have been investigated with AC adapter and Headset, and the worst case was found to be at X (Flatbed) position without AC adapter and headset.

There are three vendors of the WiFi/Bluetooth radio modules: variant 1, variant 2 and variant 3 and they have the same mechanical outline, same on board antenna, matching circuit, antenna structure and same specification. Baseline testing was performed on all three variants to determine the worst case on all conducted power and radiated emissions.

5.6. DESCRIPTION OF TEST SETUP

SUPPORT EQUIPMENT

Support Equipment List				
Description	Manufacturer	Model	Serial Number	FCC ID
AC/DC adapter	Apple	A1401	60812	NA
Earphone	Apple	NA	NA	NA
Laptop	Apple	A1278	C02HJ0A7DTY4	NA

I/O CABLES (CONDUCTED TEST)

I/O Cable List						
Cable No	Port	# of identical ports	Connector Type	Cable Type	Cable Length (m)	Remarks
1	Antenna	1	SMA	Un-Shielded	0.1	to spectrum Analyzer
2	USB	1	USB	Shielded	1m	To EUT

I/O CABLES (RADIATED ABOVE 1 GHZ)

I/O Cable List						
Cable No	Port	# of identical ports	Connector Type	Cable Type	Cable Length (m)	Remarks
None used						

I/O CABLES (BELOW 1GHZ & AC LINE CONDUCTED TESTS)

I/O Cable List						
Cable No	Port	# of identical ports	Connector Type	Cable Type	Cable Length (m)	Remarks
1	AC	1	US115	Un-Shielded	80cm	NA
2	DC	1	USB	Un-Shielded	1m	NA
3	Audio	1	Jack	Un-Shielded	0.5m	NA

TEST SETUP- CONDUCTED PORT

The EUT was tested connected to a host Laptop via USB cable adapter and spectrum analyzer to antenna port. Test software exercised the EUT.

SETUP DIAGRAM

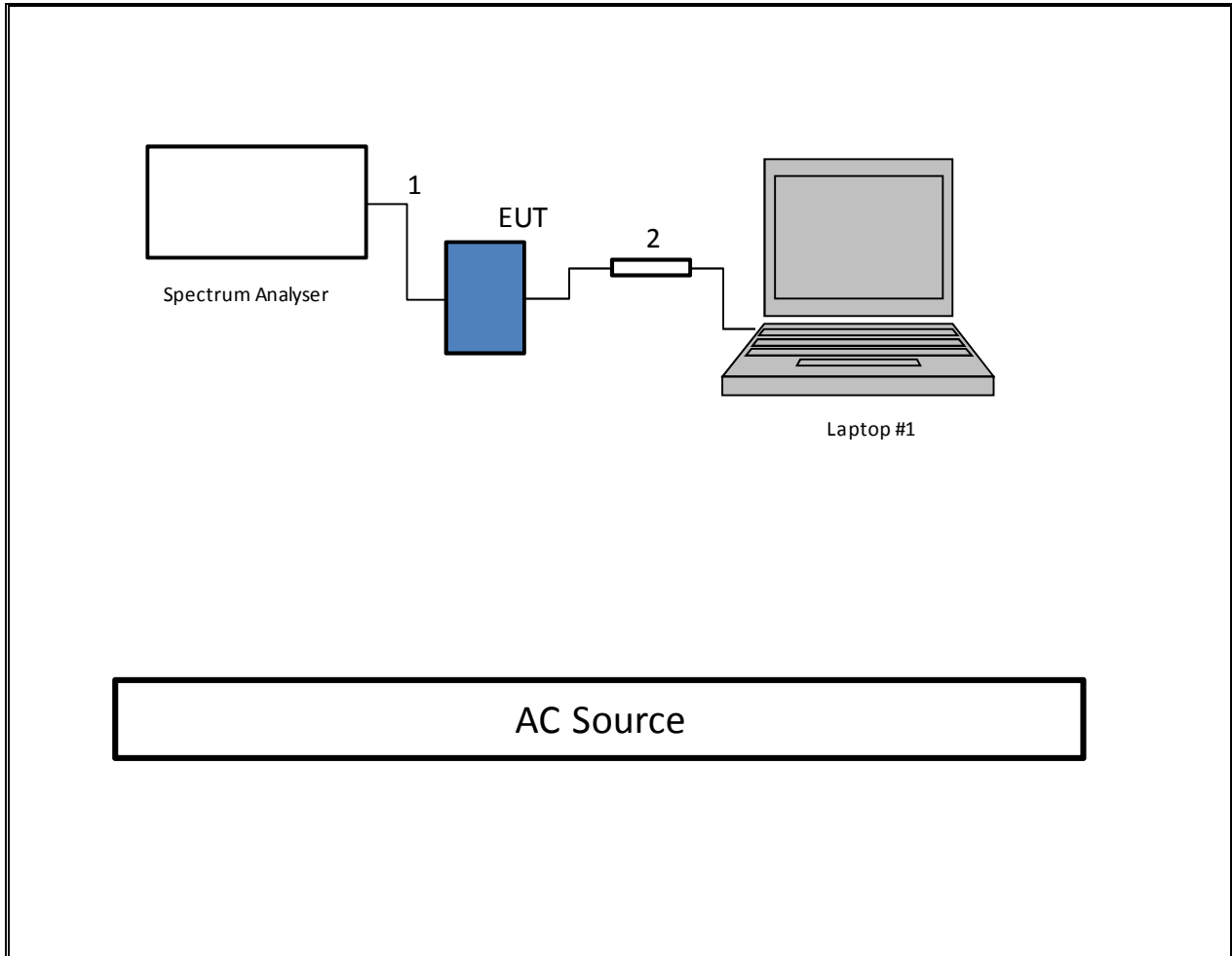

TEST SETUP- RADIATED-ABOVE 1 GHZ

The EUT was tested battery powered. Test software exercised the EUT.

SETUP DIAGRAM

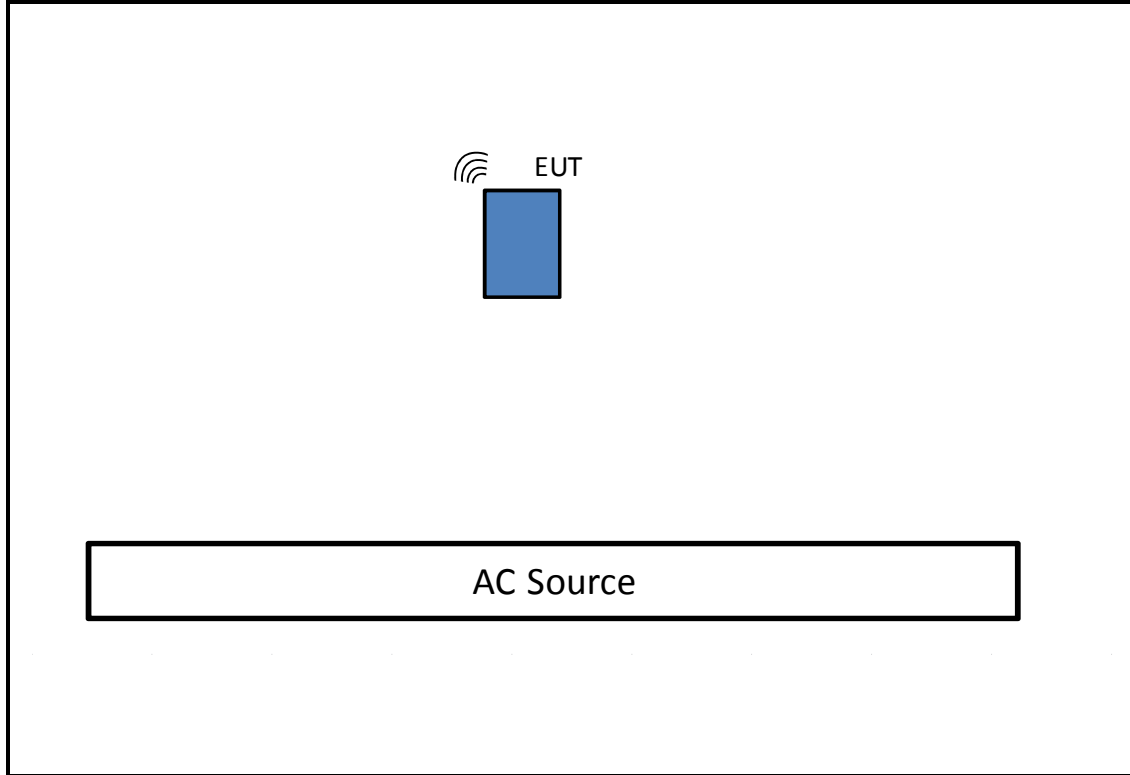

TEST SETUP- BELOW 1GHZ & AC LINE CONDUCTED TESTS

The EUT was tested with earphones connected and powered by AC adapter. Test software exercised the EUT.

SETUP DIAGRAM

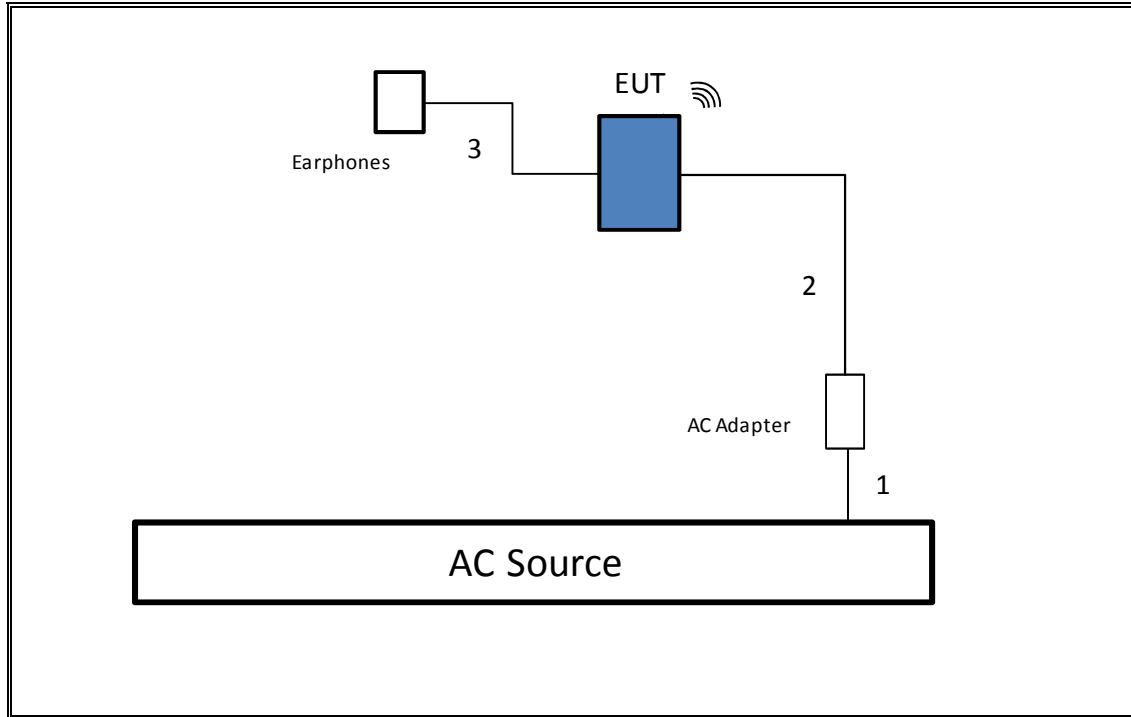

6. TEST AND MEASUREMENT EQUIPMENT

The following test and measurement equipment was utilized for the tests documented in this report:

TEST EQUIPMENT LIST				
Description	Manufacturer	Model	Asset	Cal Due
Antenna, Horn, 18 GHz	ETS Lindgren	3117	F00131	02/18/15
Antenna, Horn, 26.5 GHz	ARA	MWH-1826/B	C00589	11/26/14
Peak / Average Power Sensor	Agilent / HP	N1911A	F00153	03/06/15
Wideband Power Sensor	Agilent	N1921A	F00361	10/02/14
Peak Power Meter	Agilent / HP	E9323A	F00025	04/03/15
Spectrum Analyzer, 44 GHz	Agilent / HP	N9030A	F00129	02/22/15
Spectrum Analyzer, 40 GHz	Agilent	8564E	C00951	07/29/14
Antenna, Bilog, 2 GHz	Sunol Sciences	JB1	F00168	03/28/15
Preamplifier, 1300 MHz	Sonoma	310	F00008	05/27/15
Preamplifier, 26.5 GHz	Agilent / HP	8449B	F00165	03/25/15
EMI Test Receiver, 9 kHz-7 GHz	R & S	ESCI 7	F00092	09/05/14

7. MEASUREMENT METHODS

6 dB BW: KDB 558074 D01.

Output Power: KDB 558074 D01.

Power Spectral Density: KDB 558074 D01.

Out-of-band emissions in non-restricted bands: KDB 558074 D01.

Out-of-band emissions in restricted bands: KDB 558074 D01.

7.1.1.

8. ON TIME, DUTY CYCLE AND MEASUREMENT METHODS

LIMITS

None; for reporting purposes only.

PROCEDURE

KDB 789033 Zero-Span Spectrum Analyzer Method.

8.1. ON TIME AND DUTY CYCLE RESULTS

Mode	ON Time B (msec)	Period (msec)	Duty Cycle x (linear)	Duty Cycle (%)	Duty Cycle Correction Factor (dB)	1/B Minimum VBW (kHz)
BLE	0.390	0.626	0.623	62.3%	2.055	2.564

8.2. DUTY CYCLE PLOTS

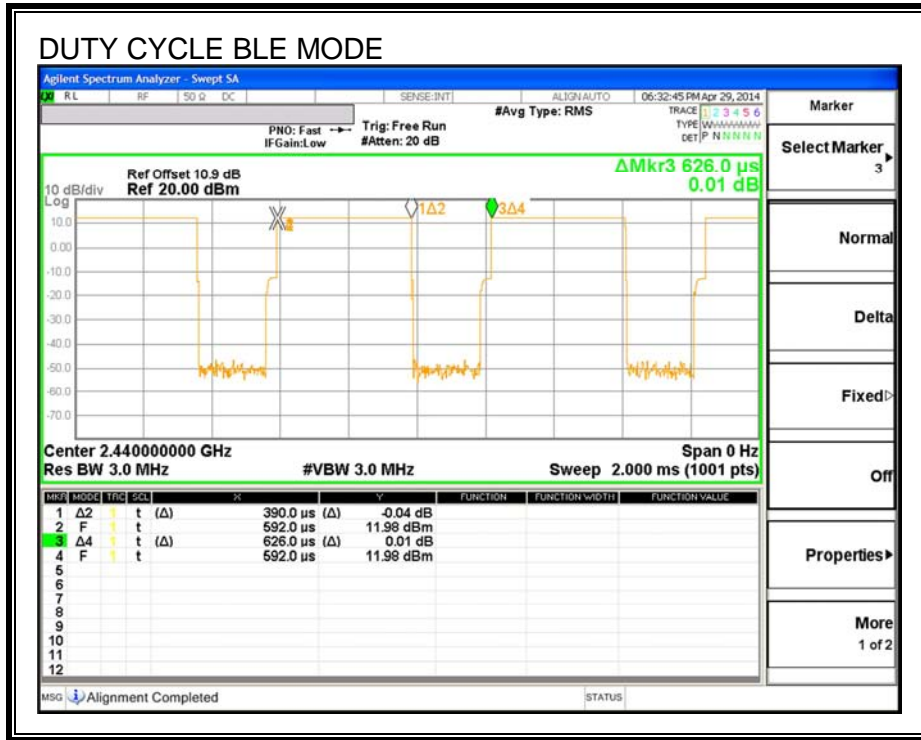

9. ANTENNA PORT TEST RESULTS

9.1. 6 dB BANDWIDTH

LIMITS

FCC §15.247 (a) (2)

The minimum 6 dB bandwidth shall be at least 500 kHz.

TEST PROCEDURE

KDB 558074 D01 v03r01 "Guidance for Performing Compliance Measurements on Digital Transmission Systems (DTS) Operating Under 15.247".

RESULTS

Channel	Frequency (MHz)	6 dB Bandwidth (KHz)	Minimum Limit (KHz)
Low	2402	717.000	500.0
Middle	2440	751.500	500.0
High	2480	715.500	500.0

6 dB BANDWIDTH

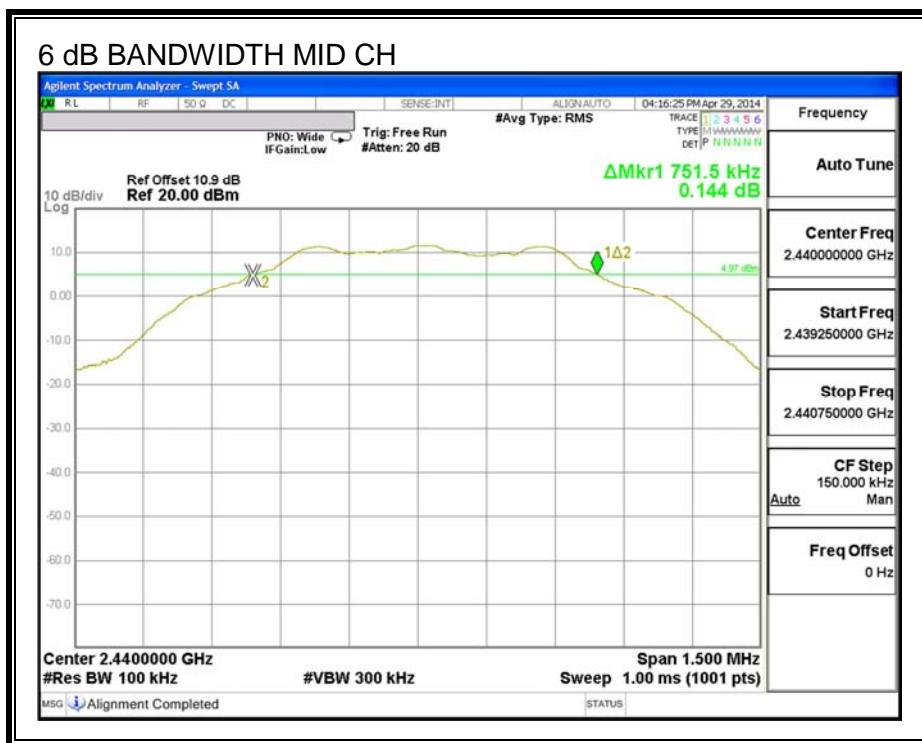
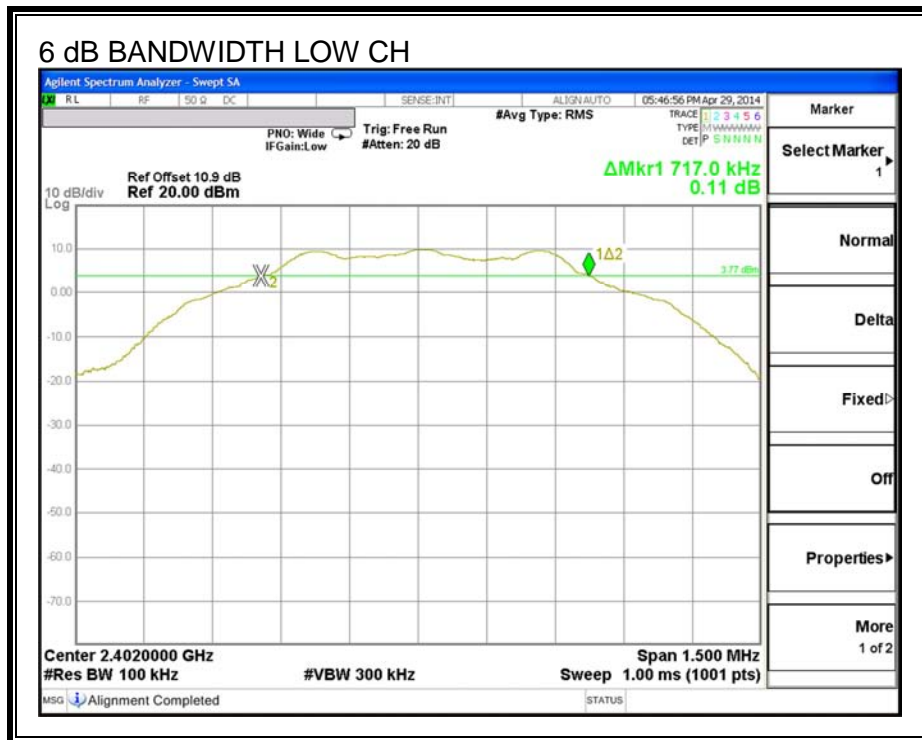

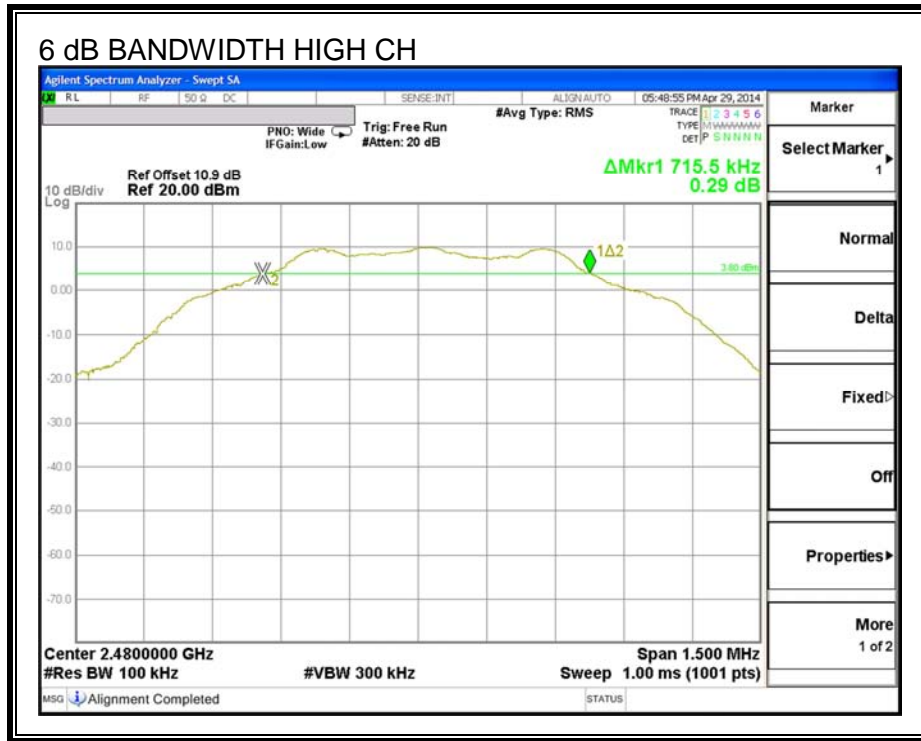

9.2. 99% BANDWIDTH

LIMIT

None; for reporting purposes only.

TEST PROCEDURE

The transmitter output is connected to the spectrum analyzer. The RBW is set to 1% to 3% of the 99 % bandwidth and to 1% of the span. The VBW is set to 3 times the RBW. The sweep time is coupled. The spectrum analyzer internal 99% bandwidth function is utilized.

RESULTS

Channel	Frequency (MHz)	99% Bandwidth (MHz)
Low	2402	1.0420
Middle	2440	1.0727
High	2480	1.0509

99% BANDWIDTH

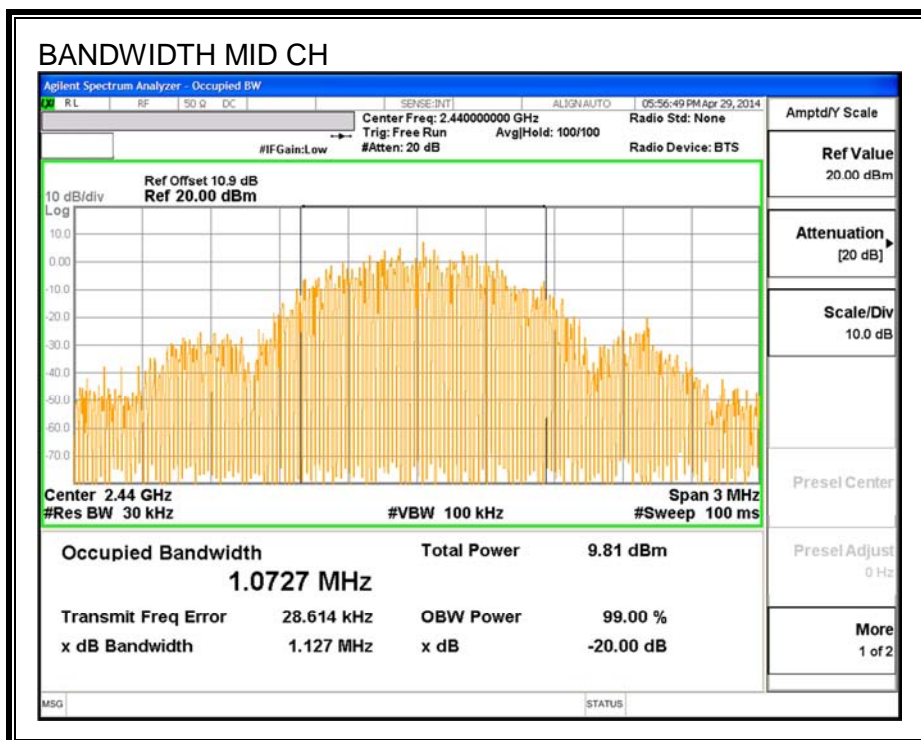
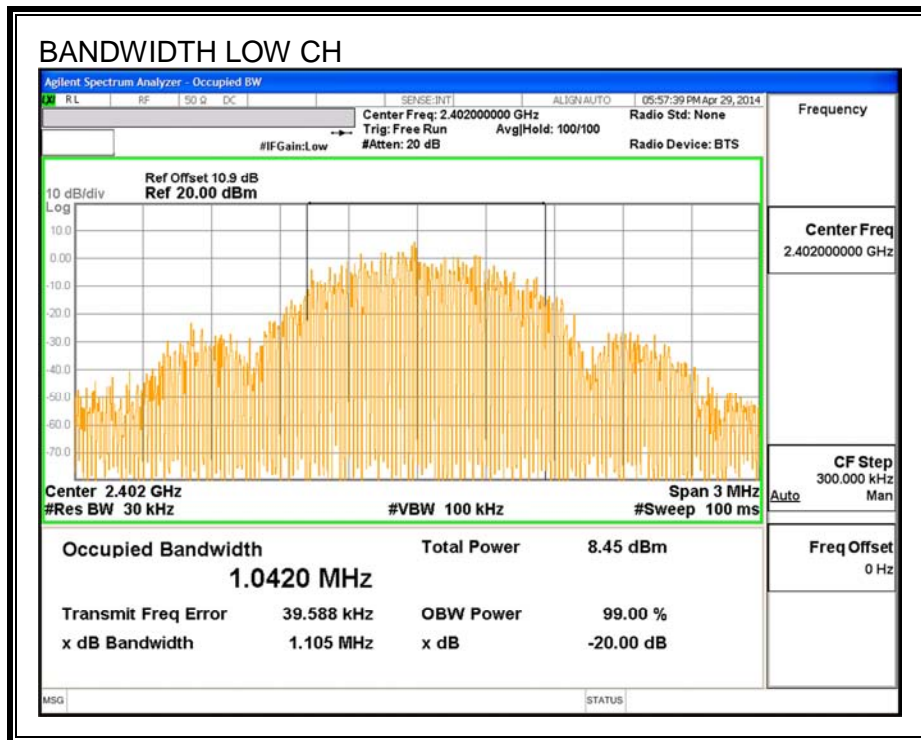

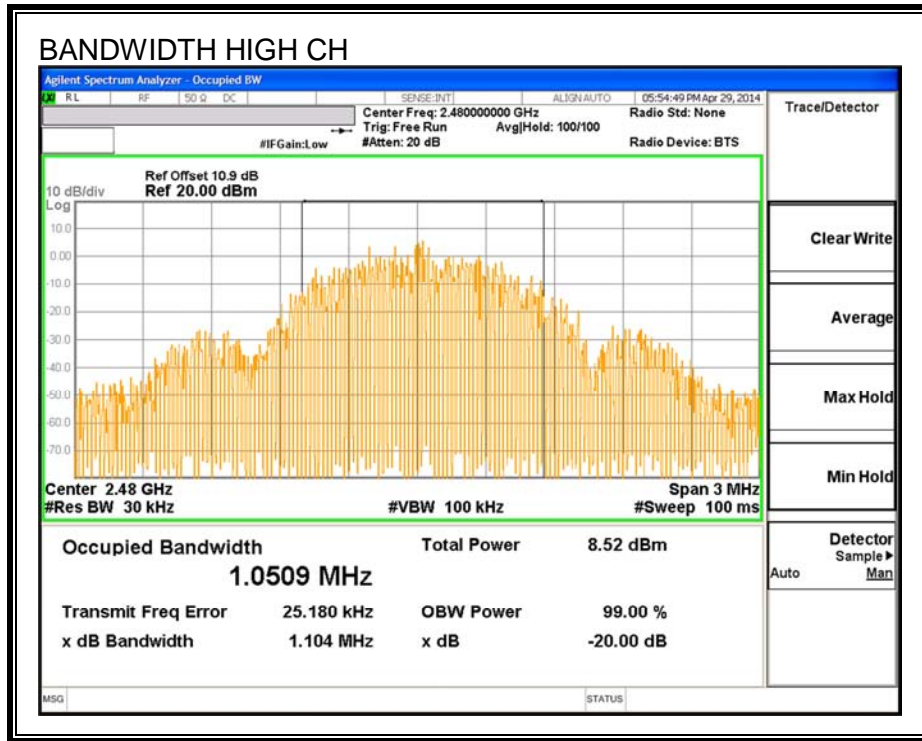

9.3. OUTPUT POWER

LIMIT

§15.247 (b) (1)

The maximum antenna gain is less than 6 dBi, therefore the limit is 30 dBm.

TEST PROCEDURE

KDB 558074 D01 v03r01 "Guidance for Performing Compliance Measurements on Digital Transmission Systems (DTS) Operating Under 15.247".

RESULTS

Channel	Frequency (MHz)	Output Power (dBm)	Limit (dBm)	Margin (dB)
Low	2402	10.280	30	-19.72
Middle	2440	12.060	30	-17.94
High	2480	10.380	30	-19.62

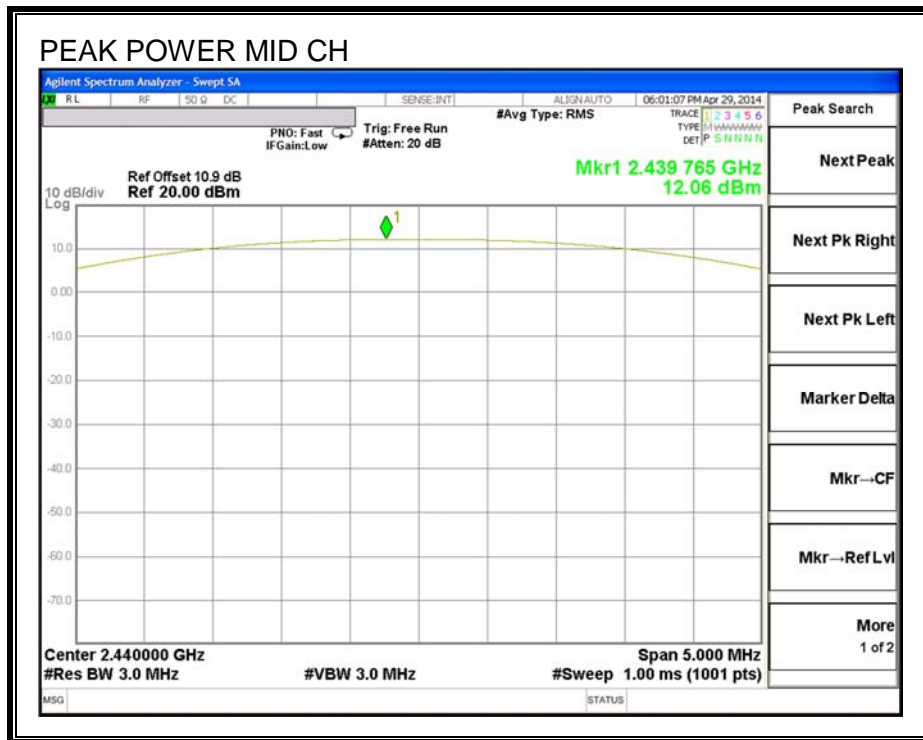
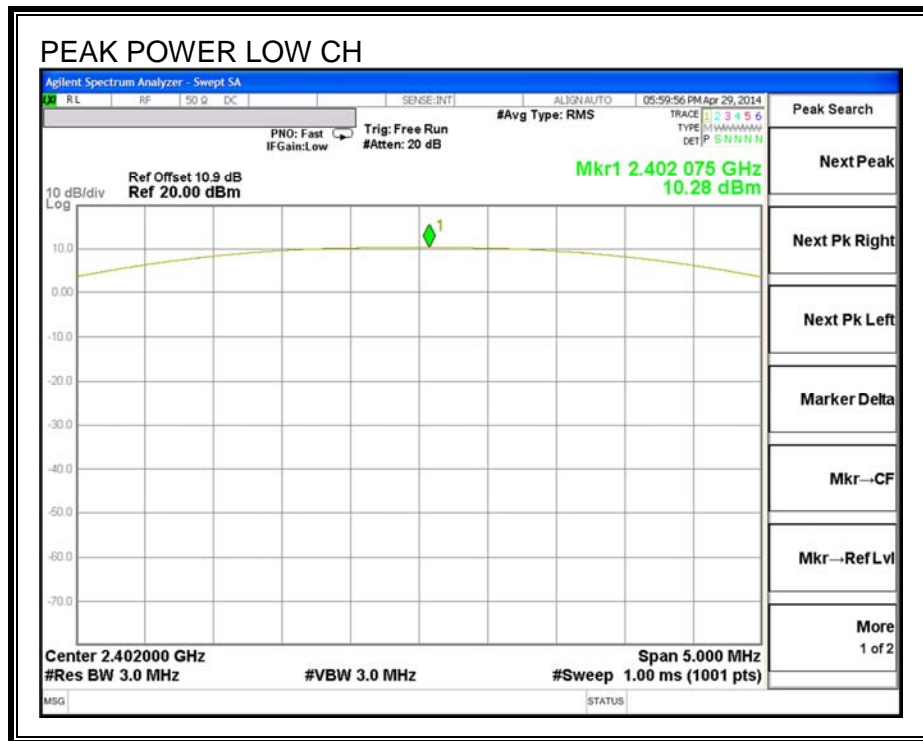

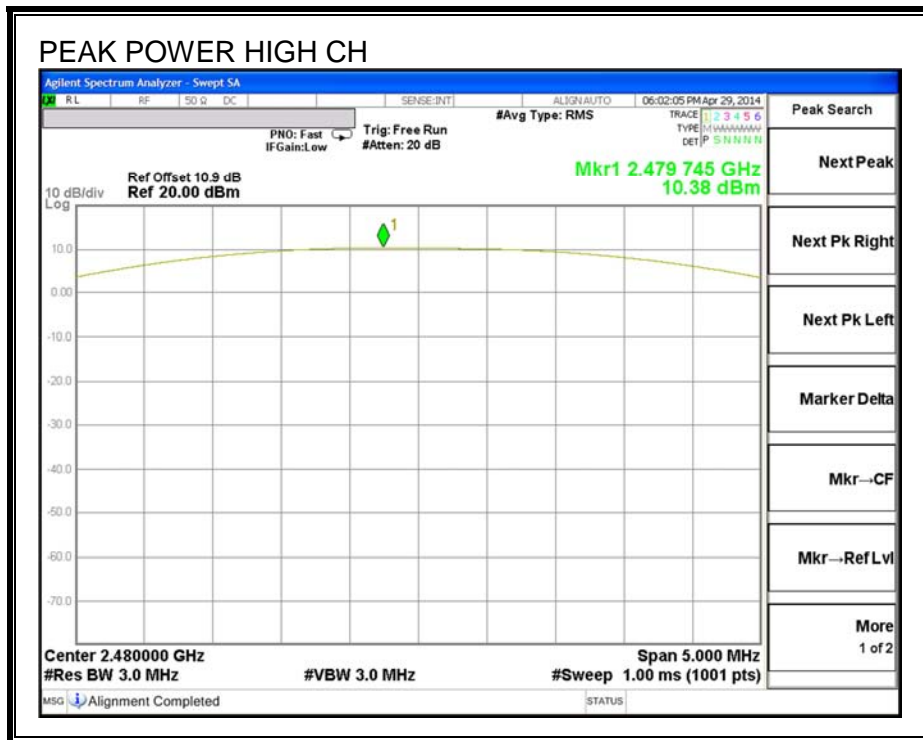

9.4. AVERAGE POWER

LIMIT

None; for reporting purposes only.

TEST PROCEDURE

The transmitter output is connected to a power meter.

RESULTS

The cable assembly insertion loss of 10.5 dB (including 10 dB pad and 0.5 dB cable) was entered as an offset in the power meter to allow for direct reading of power.

Channel	Frequency (MHz)	Average Power (dBm)
Low	2402	10.12
Middle	2440	11.95
High	2480	10.30

9.5. POWER SPECTRAL DENSITY

LIMITS

FCC §15.247 (e)

The power spectral density conducted from the transmitter to the antenna shall not be greater than 8 dBm in any 3 kHz band during any time interval of continuous transmission.

TEST PROCEDURE

KDB 558074 D01 v03r01 "Guidance for Performing Compliance Measurements on Digital Transmission Systems (DTS) Operating Under 15.247".

RESULTS

Channel	Frequency (MHz)	PPSD (dBm)	Limit (dBm)	Margin (dB)
Low	2402	-3.47	8	-11.47
Middle	2440	-2.00	8	-10.00
High	2480	-3.62	8	-11.62

POWER SPECTRAL DENSITY

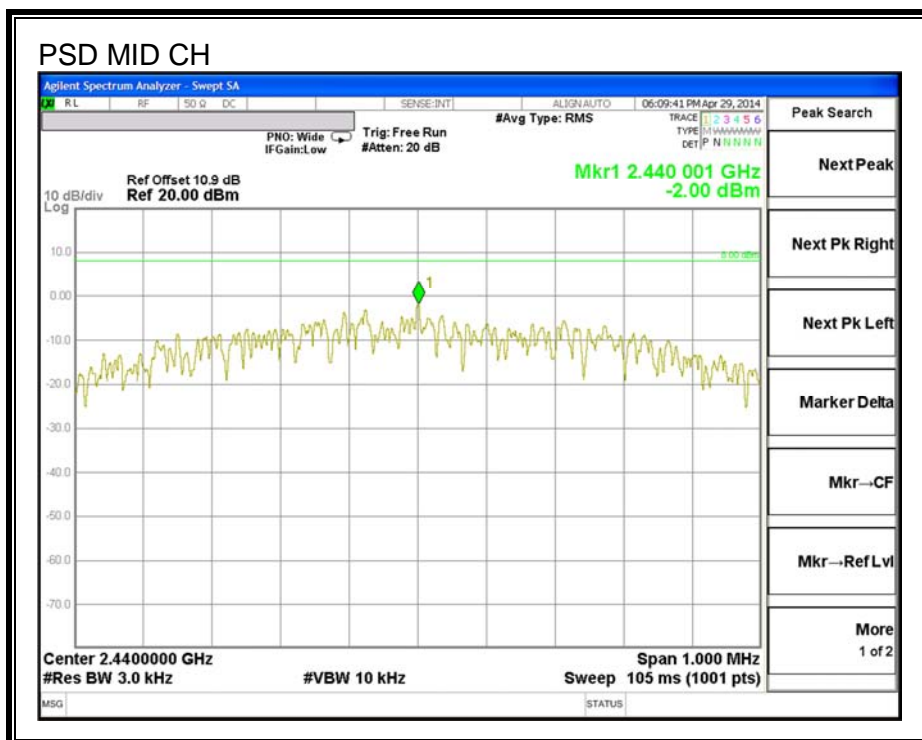
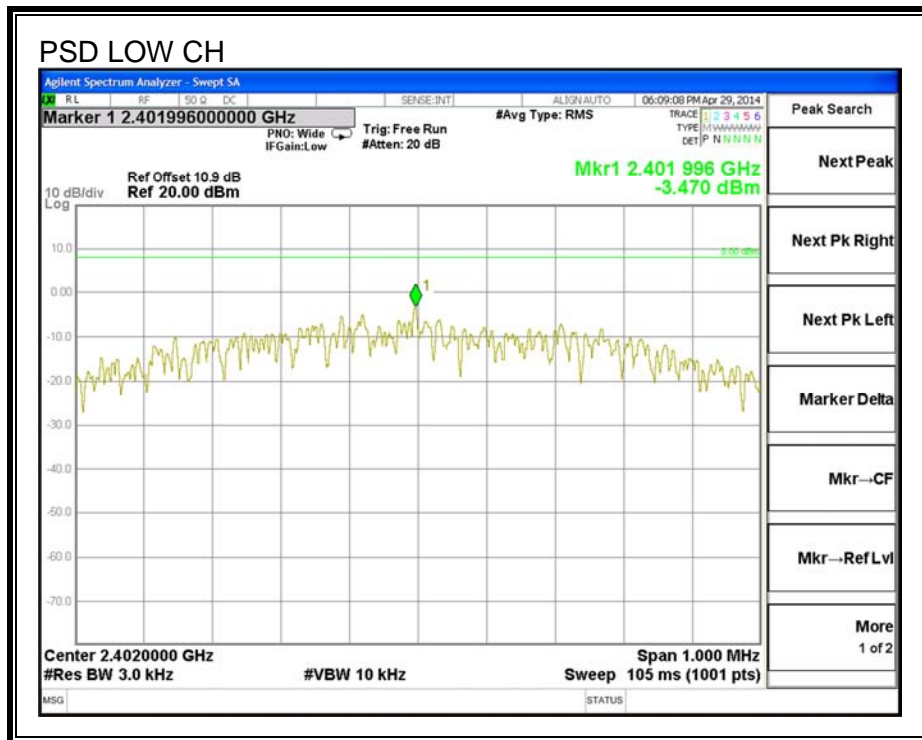

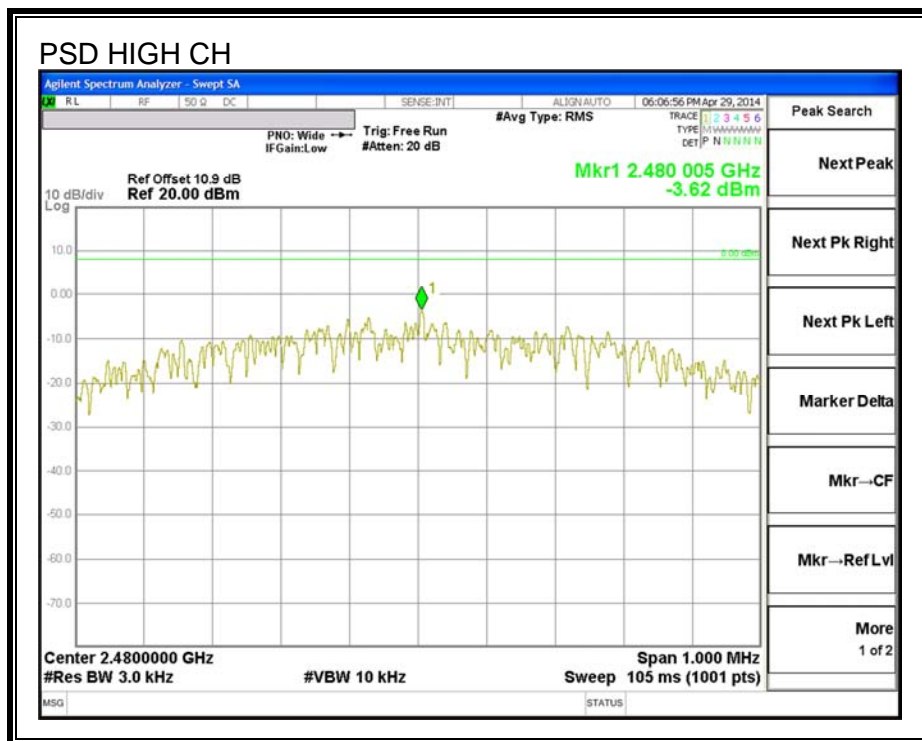

9.6. CONDUCTED SPURIOUS EMISSIONS

LIMITS

FCC §15.247 (d)

IC RSS-210 A8.5

Output power was measured based on the use of a peak measurement, therefore the required attenuation is 20 dB.

TEST PROCEDURE

KDB 558074 D01 v03r01 "Guidance for Performing Compliance Measurements on Digital Transmission Systems (DTS) Operating Under 15.247".

RESULTS

SPURIOUS EMISSIONS, LOW CHANNEL

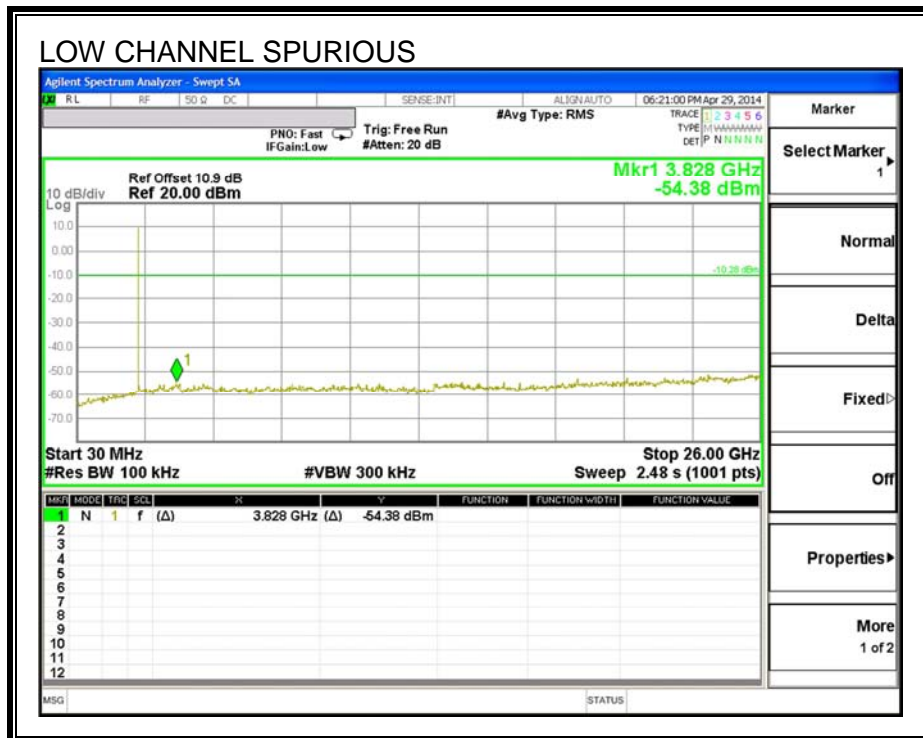
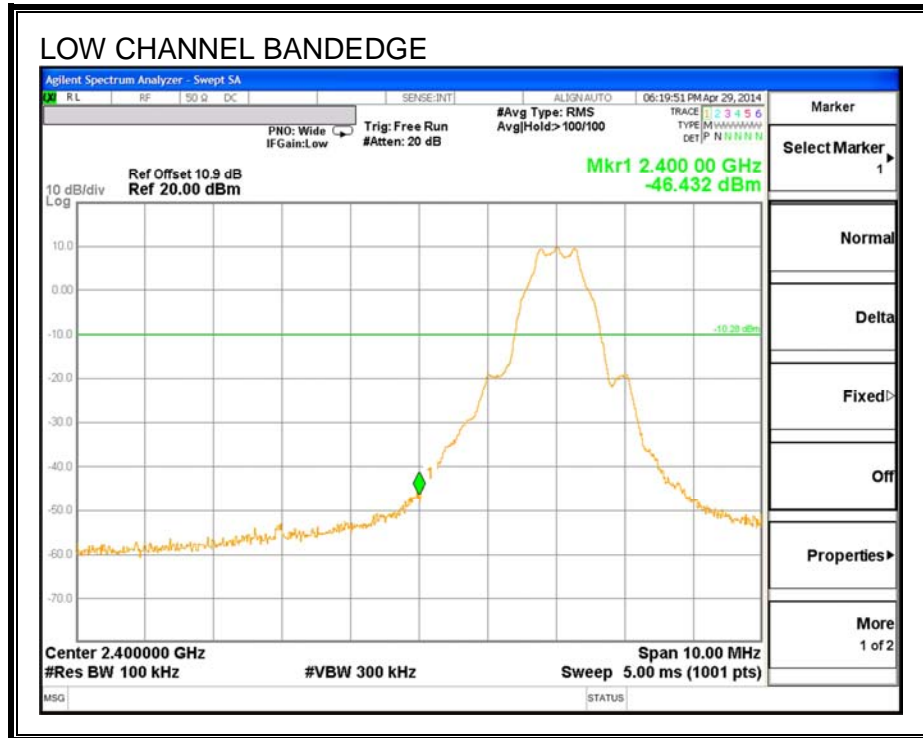

SPURIOUS EMISSIONS, MID CHANNEL

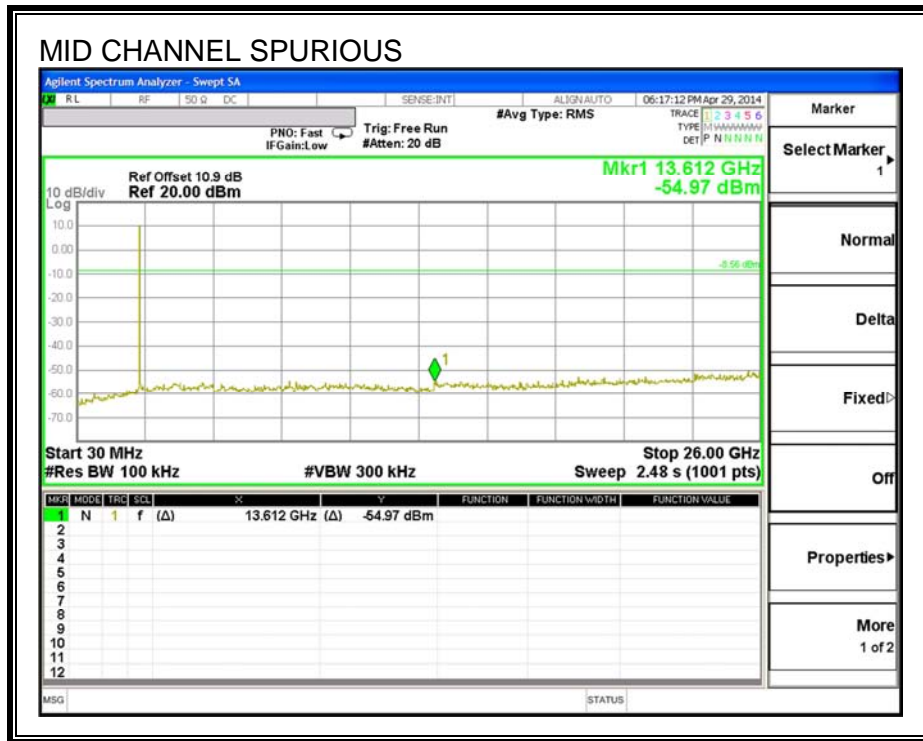
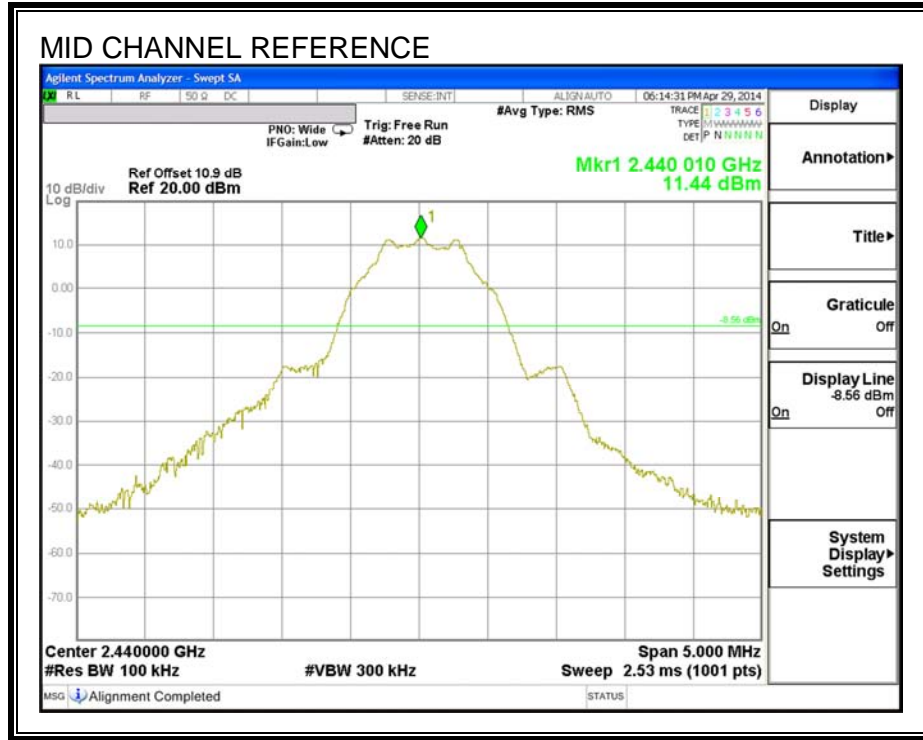

SPURIOUS EMISSIONS, HIGH CHANNEL

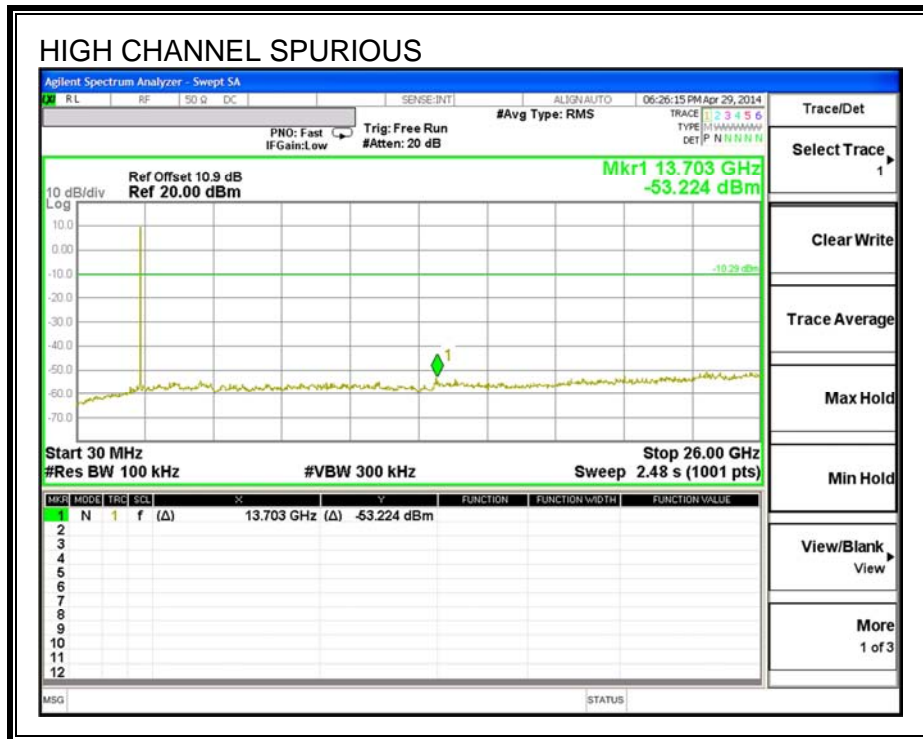
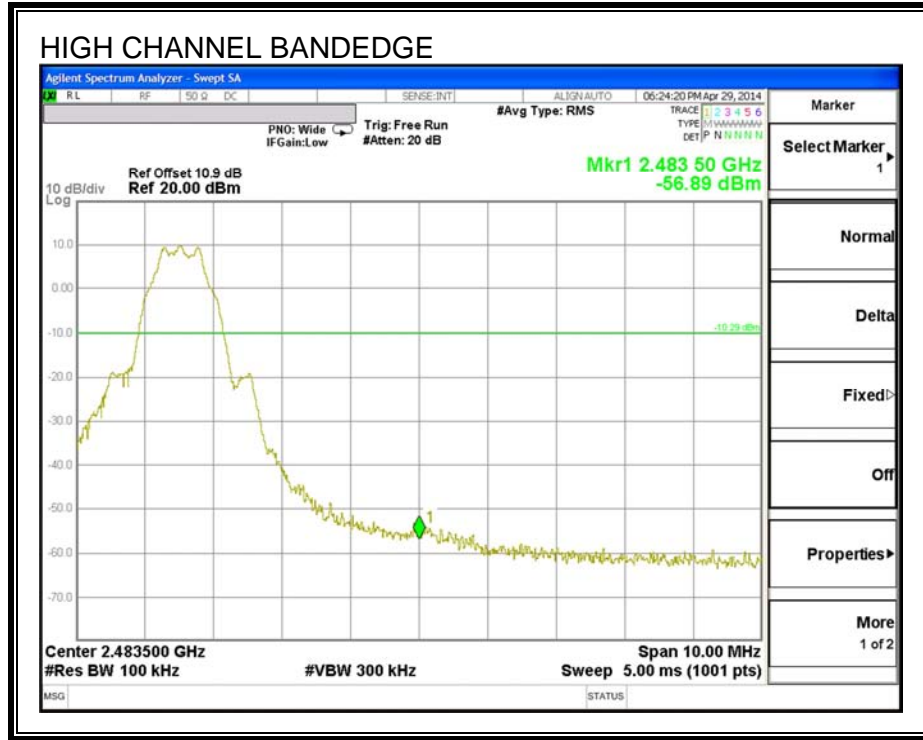

10. RADIATED TEST RESULTS

10.1. LIMITS AND PROCEDURE

LIMITS

FCC §15.205 and §15.209

IC RSS-210 Clause 2.6 (Transmitter)

IC RSS-GEN Clause 6 (Receiver)

Frequency Range (MHz)	Field Strength Limit (uV/m) at 3 m	Field Strength Limit (dBuV/m) at 3 m
30 - 88	100	40
88 - 216	150	43.5
216 - 960	200	46
Above 960	500	54

TEST PROCEDURE

The EUT is placed on a non-conducting table 80 cm above the ground plane. The antenna to EUT distance is 3 meters. The EUT is configured in accordance with ANSI C63.4. The EUT is set to transmit in a continuous mode.

For measurements below 1 GHz the resolution bandwidth is set to 100 kHz for peak detection measurements or 120 kHz for quasi-peak detection measurements. Peak detection is used unless otherwise noted as quasi-peak.

For measurements above 1 GHz the resolution bandwidth is set to 1 MHz, then the video bandwidth is set to 1 MHz for peak measurements and 10 Hz for average measurements.

For 2.4 GHz band, the spectrum from 30 MHz to 26 GHz is investigated with the transmitter set to the lowest, middle, and highest channels in the 2.4 GHz band.

The frequency range of interest is monitored at a fixed antenna height and EUT azimuth. The EUT is rotated through 360 degrees to maximize emissions received. The antenna is scanned from 1 to 4 meters above the ground plane to further maximize the emission. Measurements are made with the antenna polarized in both the vertical and the horizontal positions.

10.2. TRANSMITTER ABOVE 1 GHz

RESTRICTED BANDEDGE (LOW CHANNEL, HORIZONTAL)

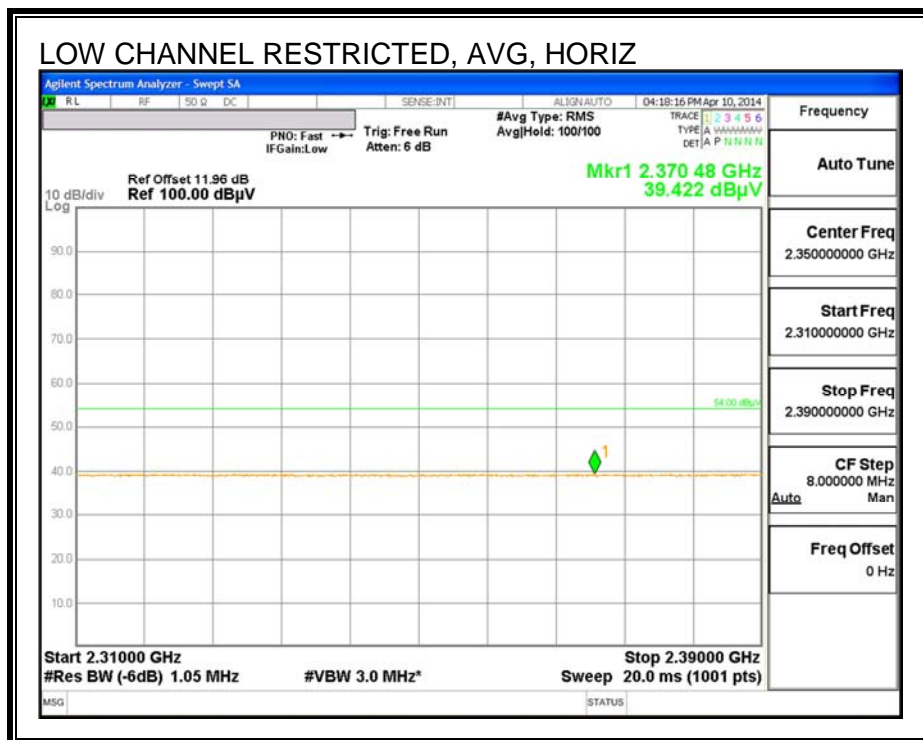
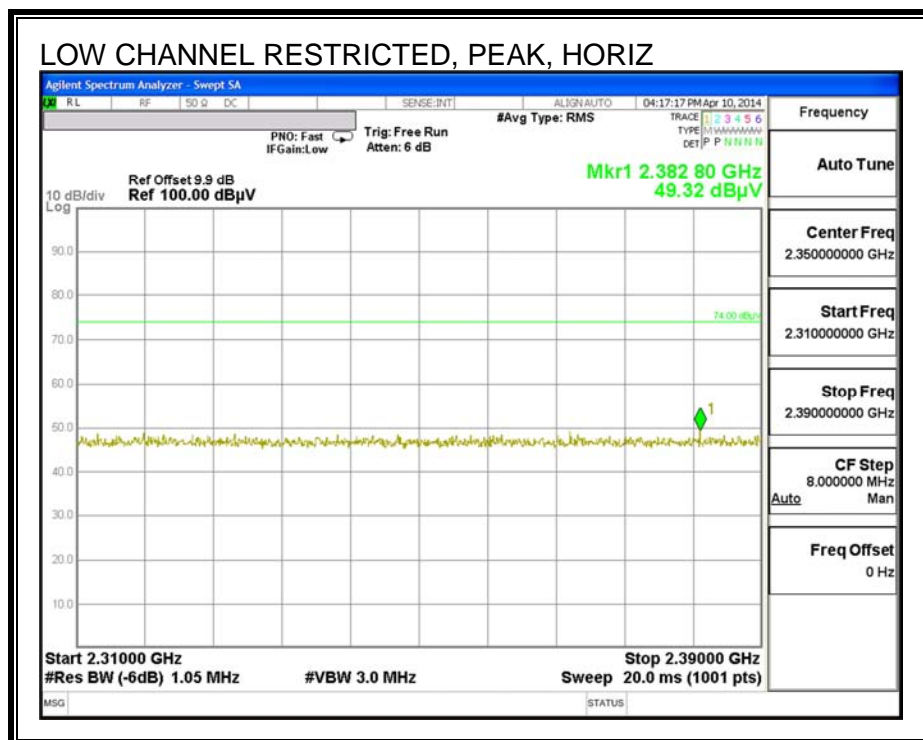

RESTRICTED BANDEDGE (LOW CHANNEL, VERTICAL)

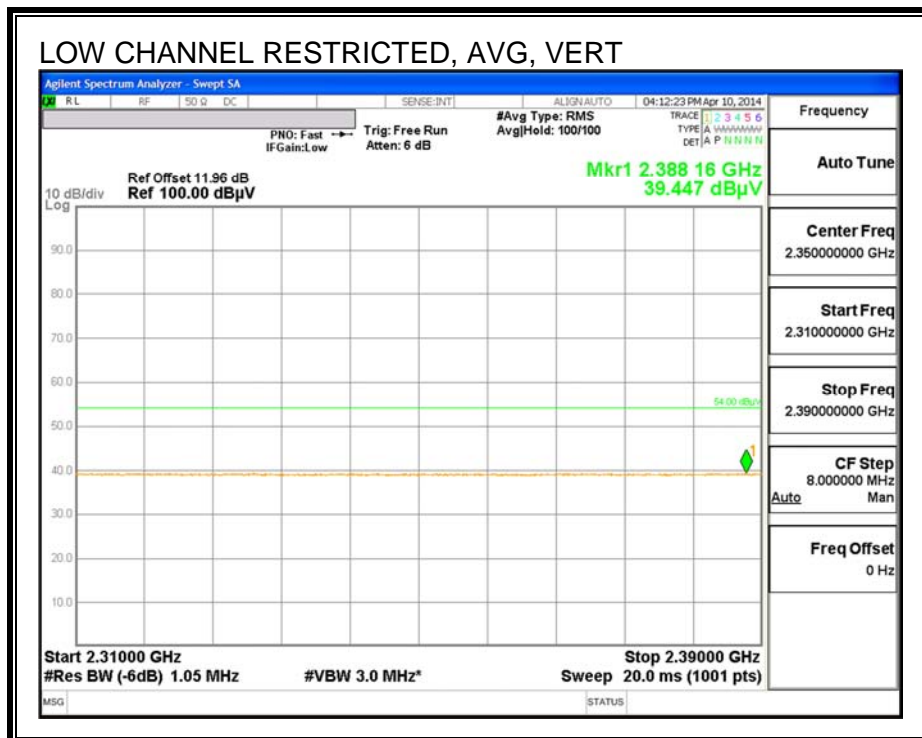
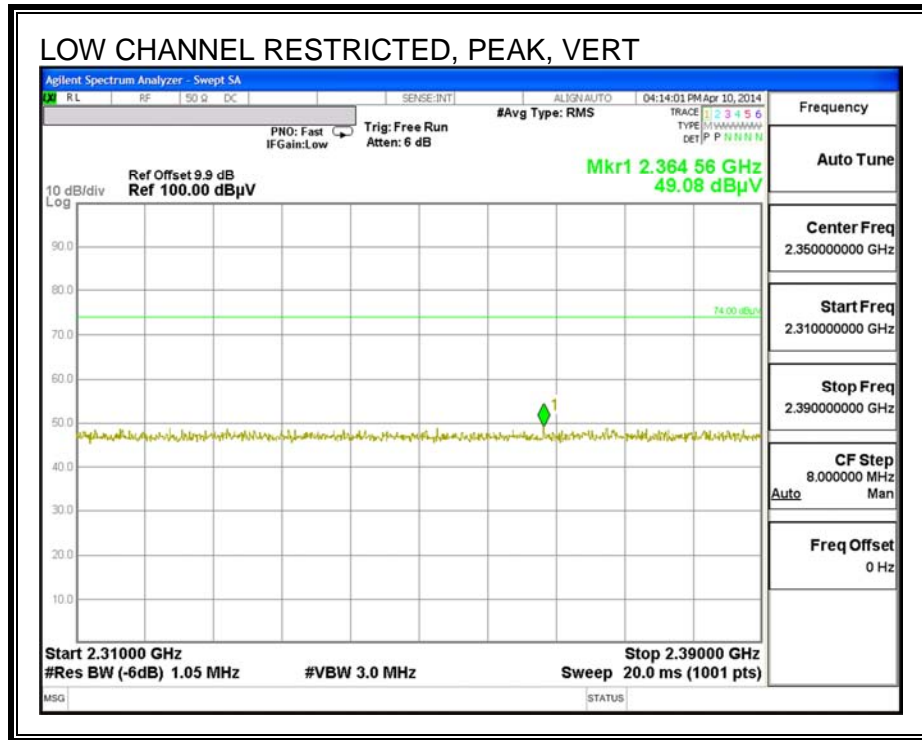

RESTRICTED BANDEDGE (HIGH CHANNEL, HORIZONTAL)

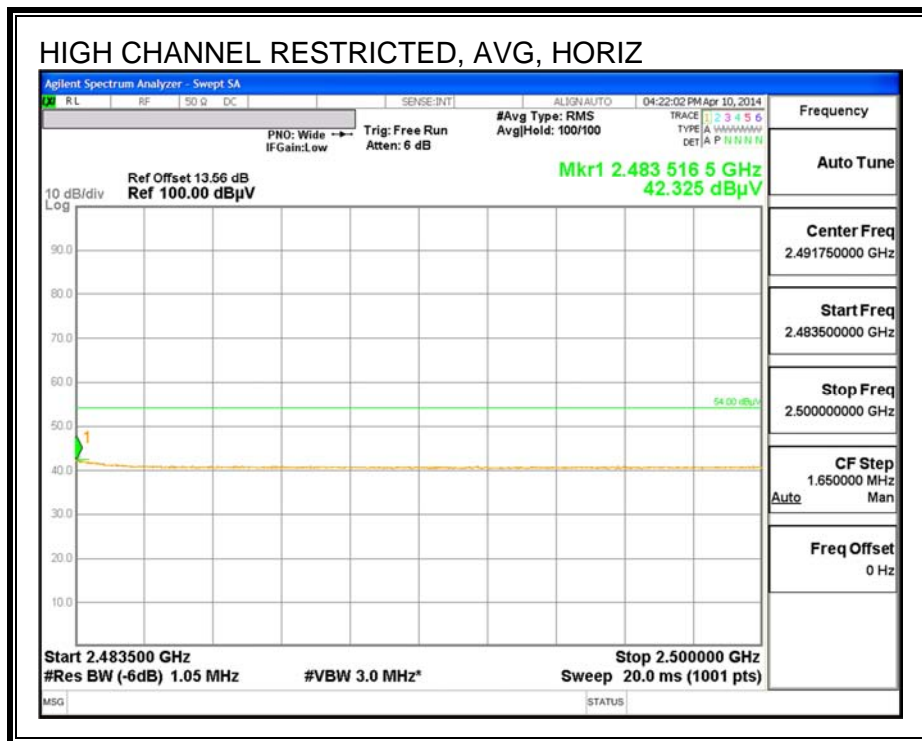
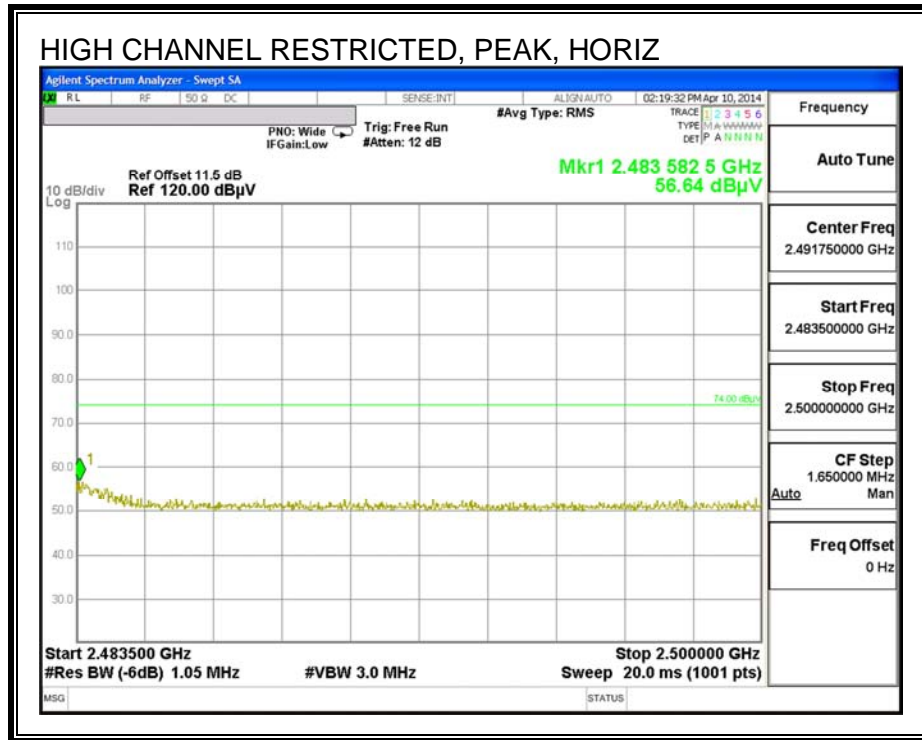

RESTRICTED BANDEDGE (HIGH CHANNEL, VERTICAL)

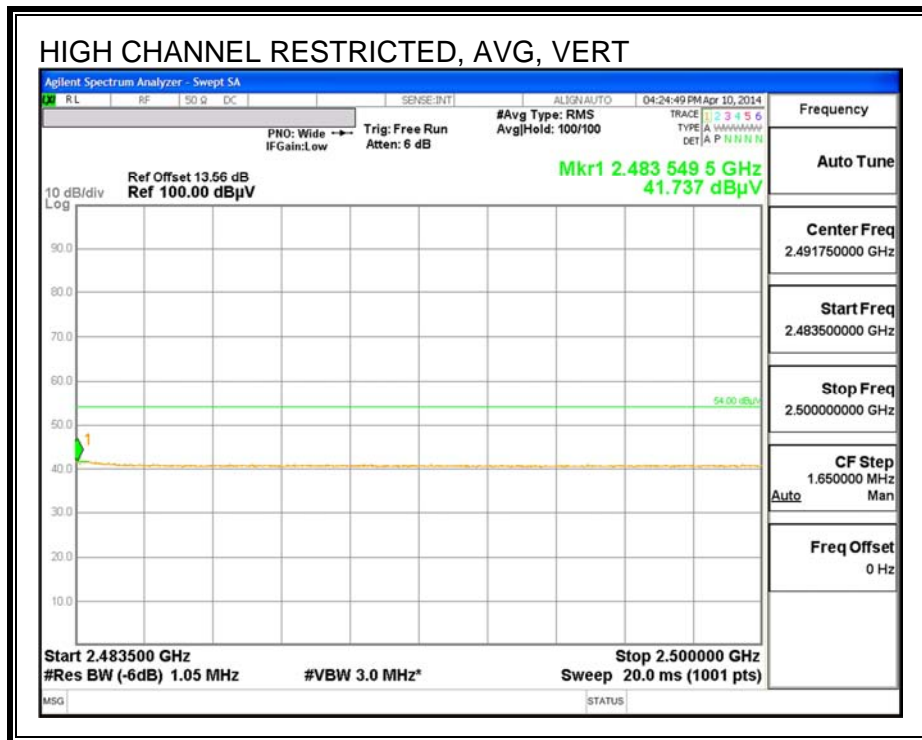
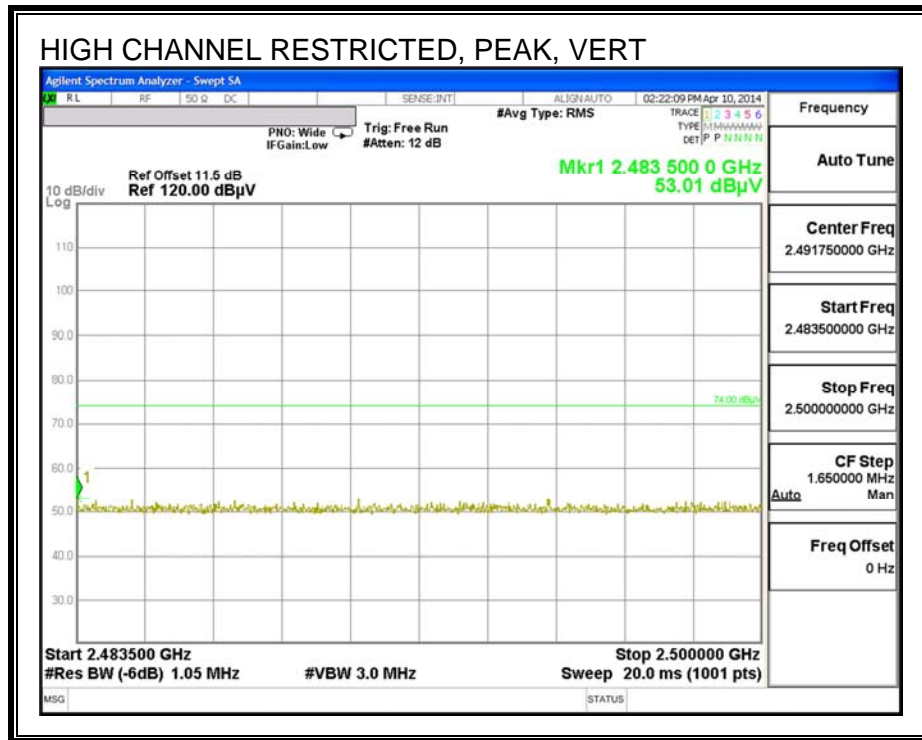

LOW CHANNEL HARMONICS AND SPURIOUS EMISSIONS

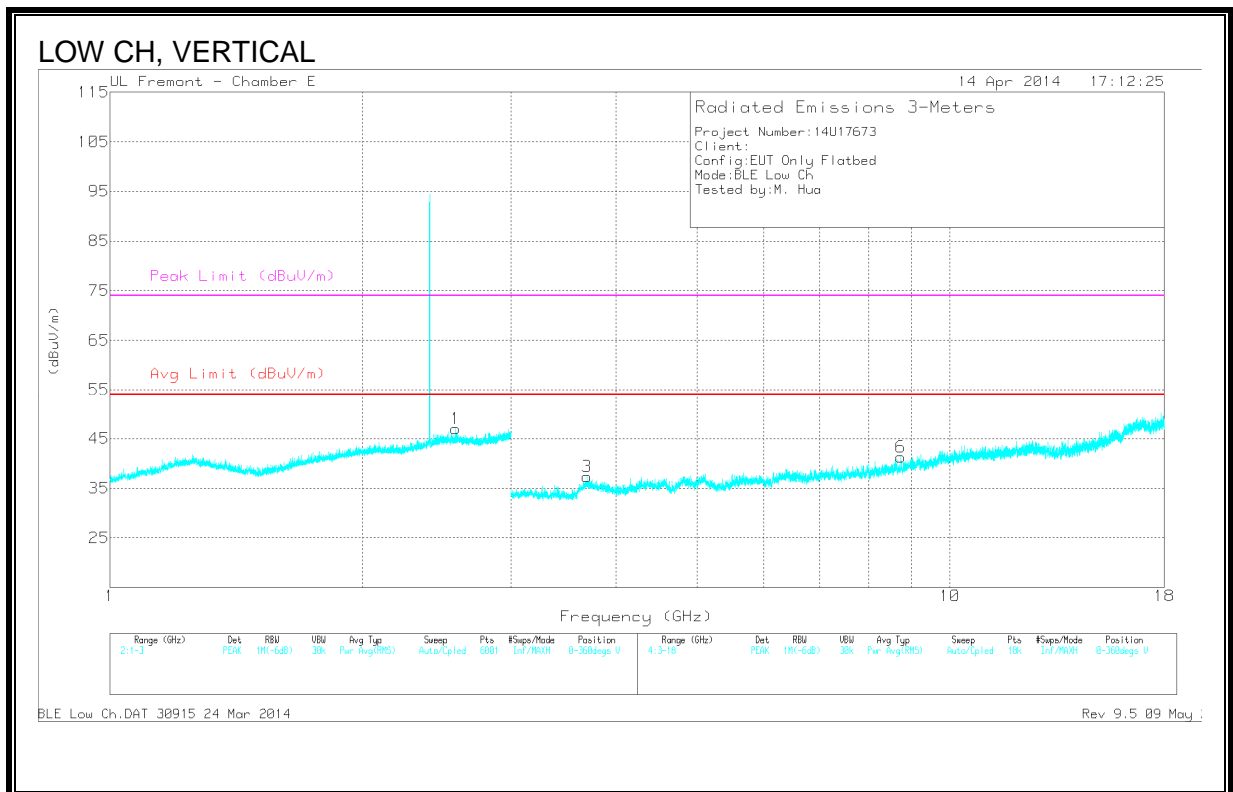
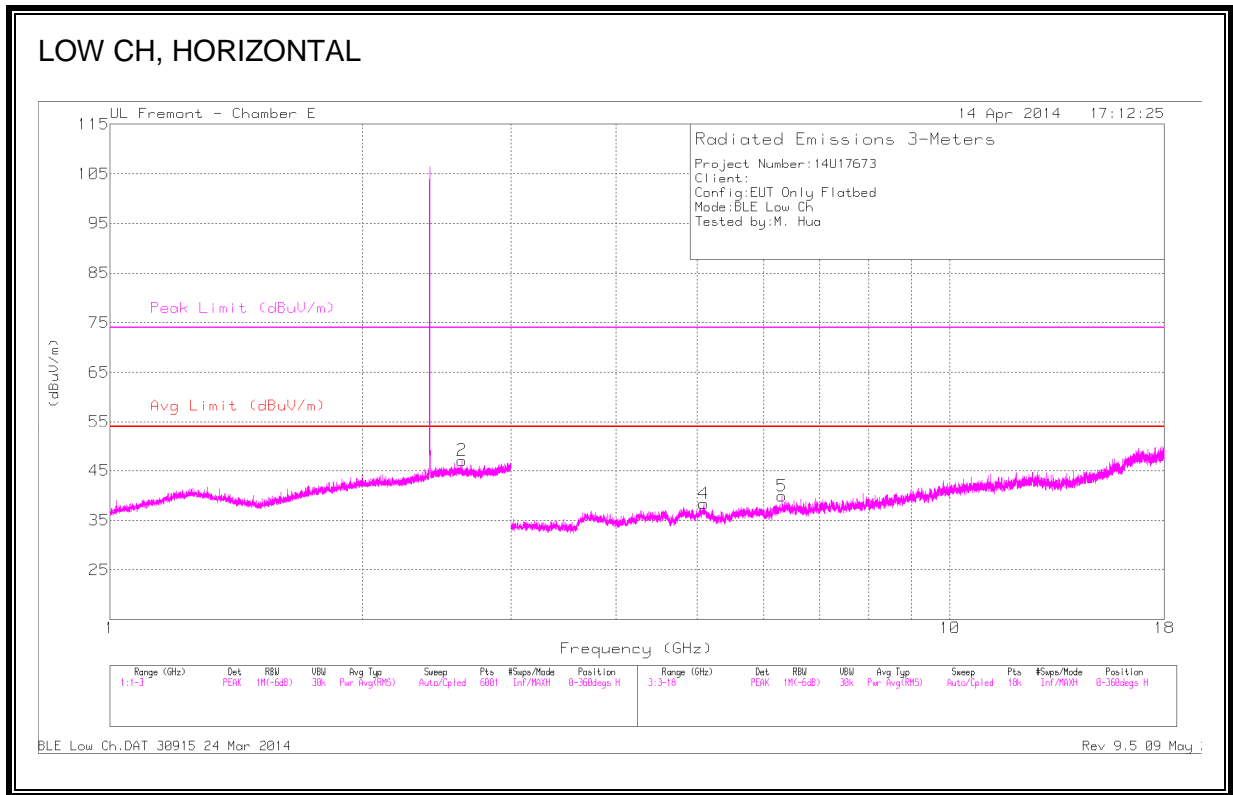

DATA

Trace Markers

Marker	Frequency (GHz)	Meter Reading (dBuV)	Det	AF T712 (dB/m)	Amp/Cb/ Ftr/Pad (dB)	Corrected Reading (dBuV/m)	Avg Limit (dBuV/m)	Margin (dB)	Peak Limit (dBuV/m)	PK Margin (dB)	Azimuth (Degs)	Height (cm)	Polarity
1	2.579	43.28	PK2	32	-20.4	54.88	-	-	-	-	360	116	V
	2.579	32.16	MAv1	32	-20.4	43.76	-	-	-	-	360	116	V
2	2.624	43.54	PK2	31.9	-20.4	55.04	-	-	-	-	360	135	H
	2.625	32.15	MAv1	31.9	-20.4	43.65	-	-	-	-	360	135	H
3	* 3.697	41.63	PK2	32.6	-27.9	46.33	-	-	74	-27.67	360	116	V
	* 3.697	30.7	MAv1	32.6	-27.9	35.4	54	-18.6	-	-	360	116	V
4	* 5.092	36.18	PK2	33.6	-25.9	43.88	-	-	74	-30.12	299	389	H
	* 5.092	26.47	MAv1	33.6	-25.9	34.17	54	-19.83	-	-	299	389	H
5	6.306	41.18	PK2	34.9	-26.1	49.98	-	-	-	-	360	116	H
	6.306	29.03	MAv1	34.9	-26.1	37.83	-	-	-	-	360	116	H
6	8.736	37.75	PK2	35.6	-23.3	50.05	-	-	-	-	360	116	V
	8.736	26.55	MAv1	35.6	-23.2	38.95	-	-	-	-	360	116	V

* indicates frequency in CFR15.205/IC7.2.2 Restricted Band
 PK2 - KDB558074 Method: Maximum Peak
 MAv1 - KDB558074 Option 1 Maximum RMS Average

MID CHANNEL HARMONICS AND SPURIOUS EMISSIONS

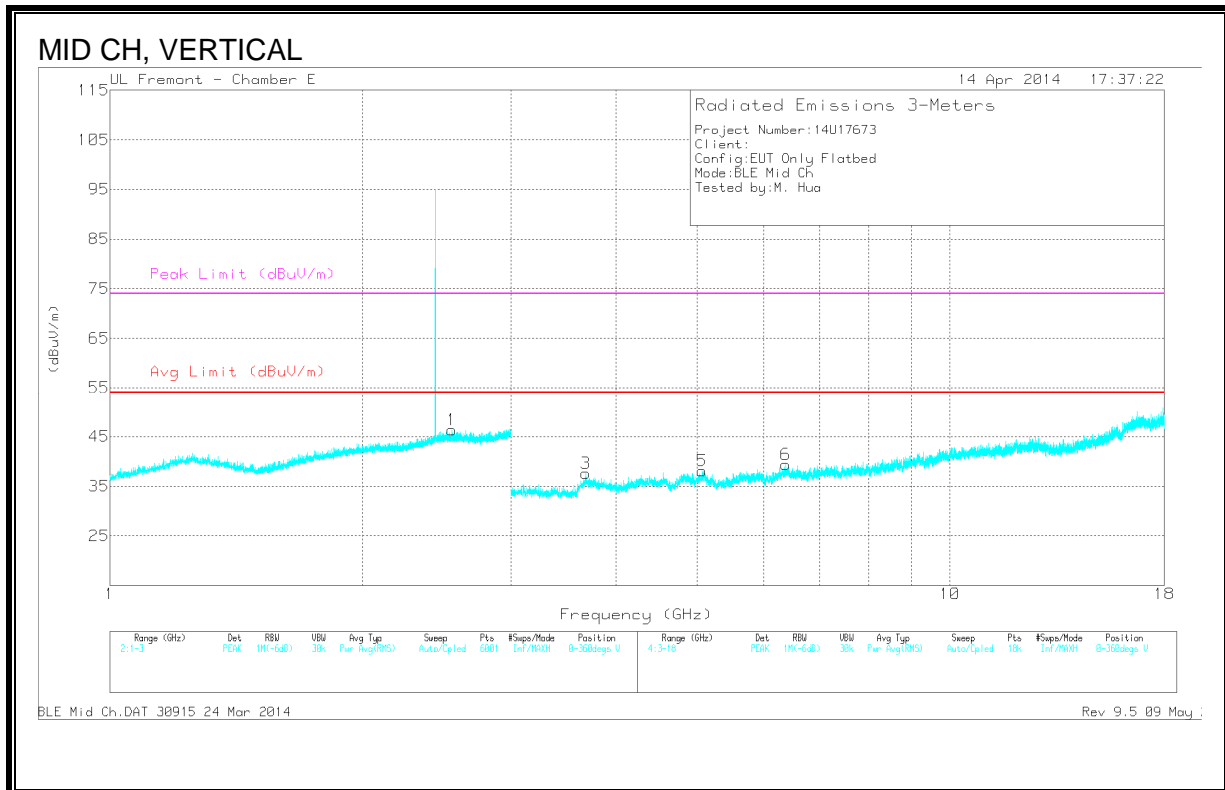
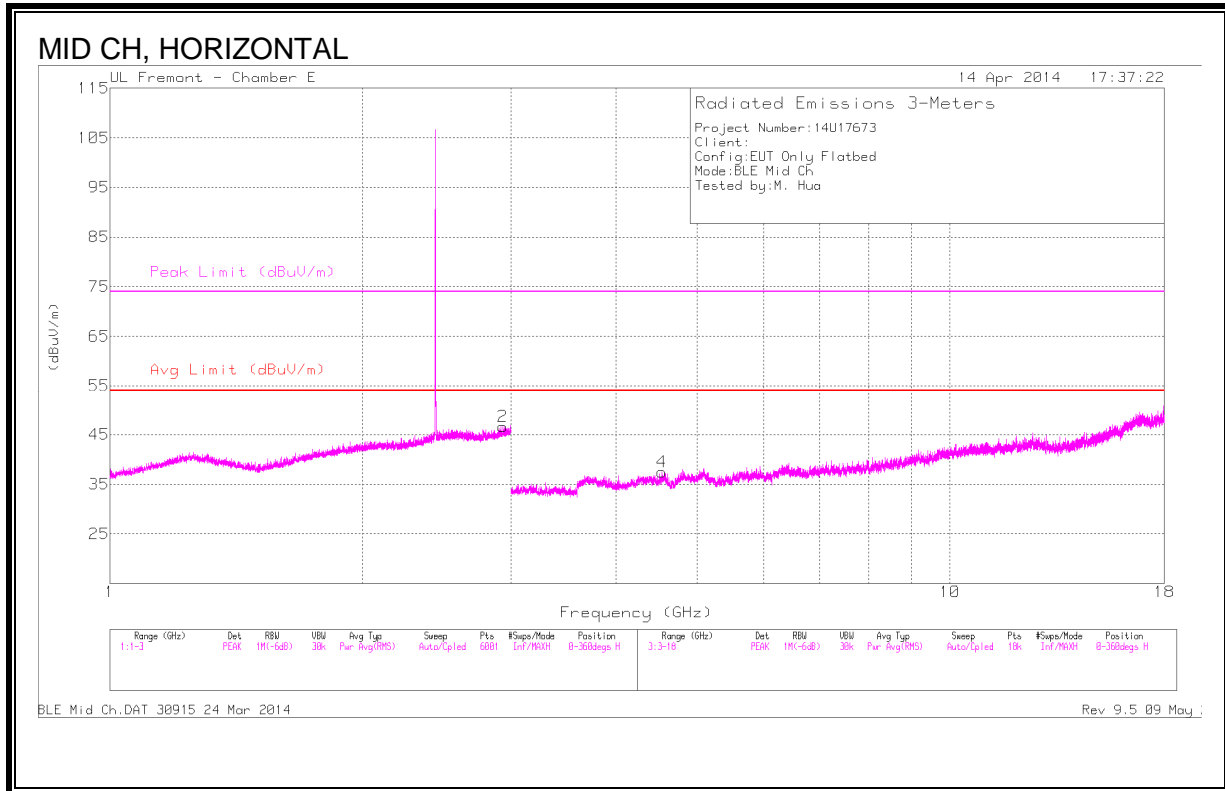

DATA

Trace Markers

Marker	Frequency (GHz)	Meter Reading (dBuV)	Det	AF T712 (dB/m)	Amp/Cb/F ltr/Pad (dB)	Corrected Reading (dBuV/m)	Avg Limit (dBuV/m)	Margin (dB)	Peak Limit (dBuV/m)	PK Margin (dB)	Azimuth (Degs)	Height (cm)	Polarity
1	2.553	43.57	PK2	32	-20.3	55.27	-	-	-	-	360	120	V
	2.553	32.09	MAv1	32.1	-20.3	43.89	-	-	-	-	360	120	V
2	2.938	43.75	PK2	32.3	-20.1	55.95	-	-	-	-	360	120	H
	2.937	32.14	MAv1	32.2	-20.1	44.24	-	-	-	-	360	120	H
3	* 3.683	38.91	PK2	32.6	-28	43.51	-	-	74	-30.49	59	287	V
	* 3.686	27.29	MAv1	32.6	-28	31.89	54	-22.11	-	-	59	287	V
4	* 4.54	42.07	PK2	33.5	-26.5	49.07	-	-	74	-24.93	360	120	H
	* 4.54	30.81	MAv1	33.5	-26.5	37.81	54	-16.19	-	-	360	120	H
5	* 5.068	37.14	PK2	33.6	-26.4	44.34	-	-	74	-29.66	46	149	V
	* 5.068	26.4	MAv1	33.6	-26.3	33.7	54	-20.3	-	-	46	149	V
6	6.374	40.03	PK2	34.9	-26.3	48.63	-	-	-	-	360	120	V
	6.374	28.5	MAv1	34.9	-26.3	37.1	-	-	-	-	360	120	V

* indicates frequency in CFR15.205/IC7.2.2 Restricted Band
 PK2 - KDB558074 Method: Maximum Peak
 MAv1 - KDB558074 Option 1 Maximum RMS Average

HIGH CHANNEL HARMONICS AND SPURIOUS EMISSIONS

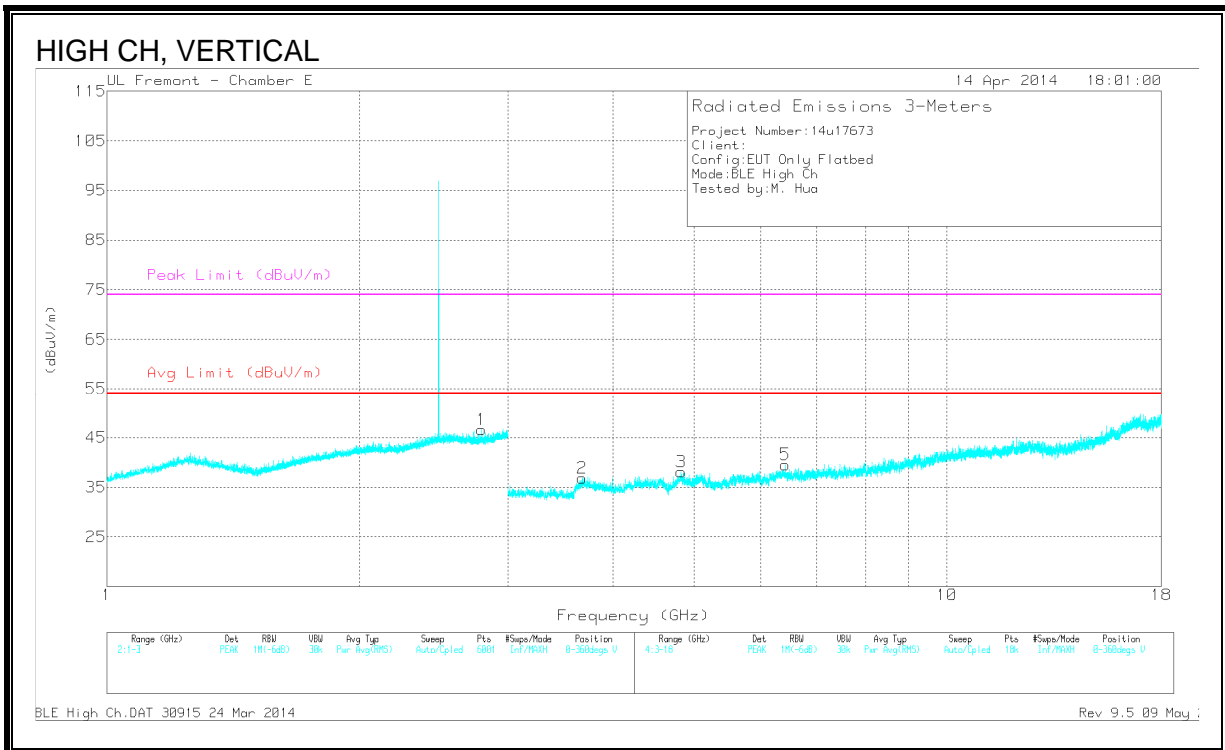
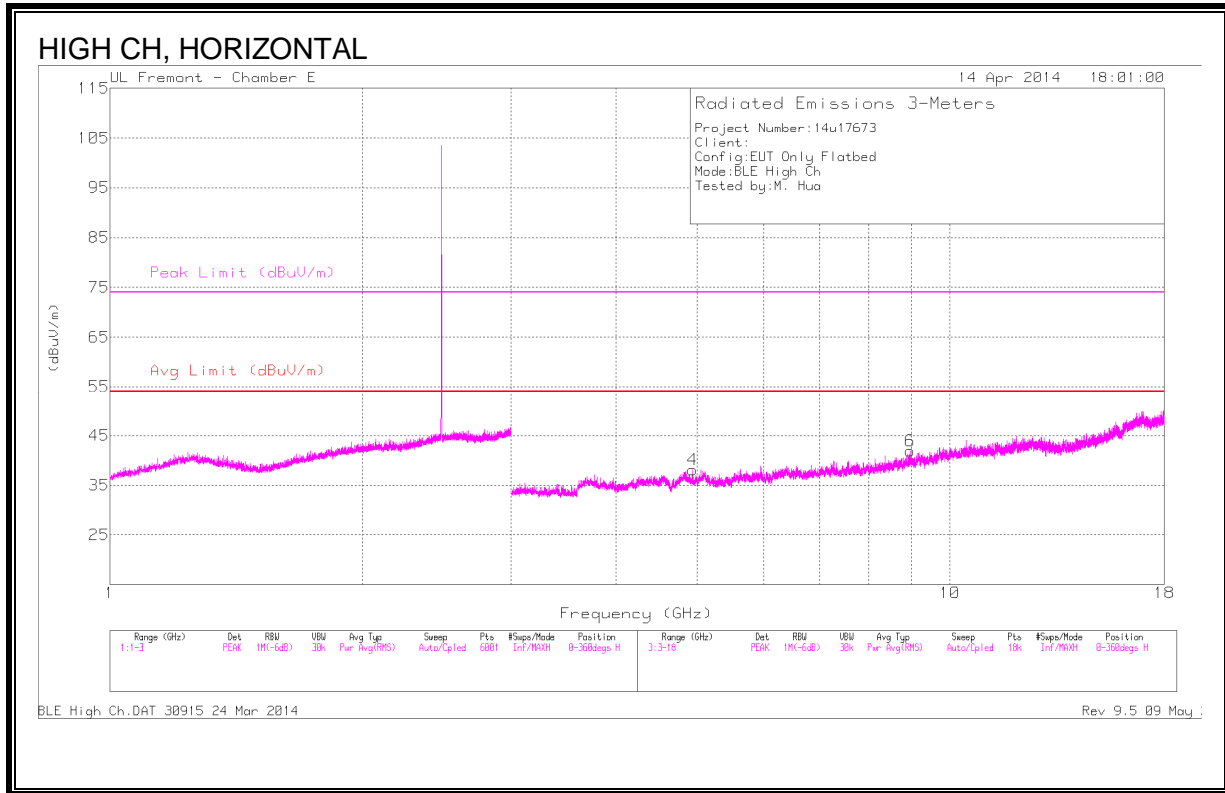

DATA

Trace Markers

Marker	Frequency (GHz)	Meter Reading (dBuV)	Det	AF T712 (dB/m)	Amp/Cbl/FI tr/Pad (dB)	Corrected Reading (dBuV/m)	Avg Limit (dBuV/m)	Margin (dB)	Peak Limit (dBuV/m)	PK Margin (dB)	Azimuth (Degs)	Height (cm)	Polarity
1	* 2.793	40.64	PK2	31.7	-19.9	52.44	-	-	74	-21.56	165	376	V
	* 2.793	29.93	MAv1	31.7	-19.9	41.73	54	-12.27	-	-	165	376	V
4	* 4.94	37.37	PK2	33.5	-28.1	42.77	-	-	74	-31.23	360	199	H
	* 4.94	27.11	MAv1	33.5	-28.1	32.51	54	-21.49	-	-	360	199	H
2	* 3.680	38.91	PK2	32.6	-28	43.51	-	-	74	-30.49	59	287	V
	* 3.678	27.29	MAv1	32.6	-28	31.89	54	-22.11	-	-	59	287	V
3	* 4.822	42.45	PK2	34.1	-30.8	45.75	-	-	74	-28.25	73	220	V
	* 4.824	30.54	MAv1	34.1	-30.8	34.94	54	-19.06	-	-	73	220	V
5	6.421	28.77	MAv1	35	-26.1	37.67	-	-	-	-	360	120	V
	6.422	40.51	PK2	35	-26.1	49.41	-	-	-	-	360	120	V
6	8.594	30.09	PK2	35.5	-22.6	42.99	-	-	-	-	360	120	H
	8.595	26.65	MAv1	35.5	-22.6	39.55	-	-	-	-	360	120	H

* - indicates frequency in CFR15.205/IC7.2.2 Restricted Band
 PK2 - KDB558074 Method: Maximum Peak
 MAv1 - KDB558074 Option 1 Maximum RMS Average

10.3. WORST-CASE ABOVE 18 GHz

SPURIOUS EMISSIONS 18 TO 26 GHz (WORST-CASE CONFIGURATION, HORIZONTAL & VERTICAL)

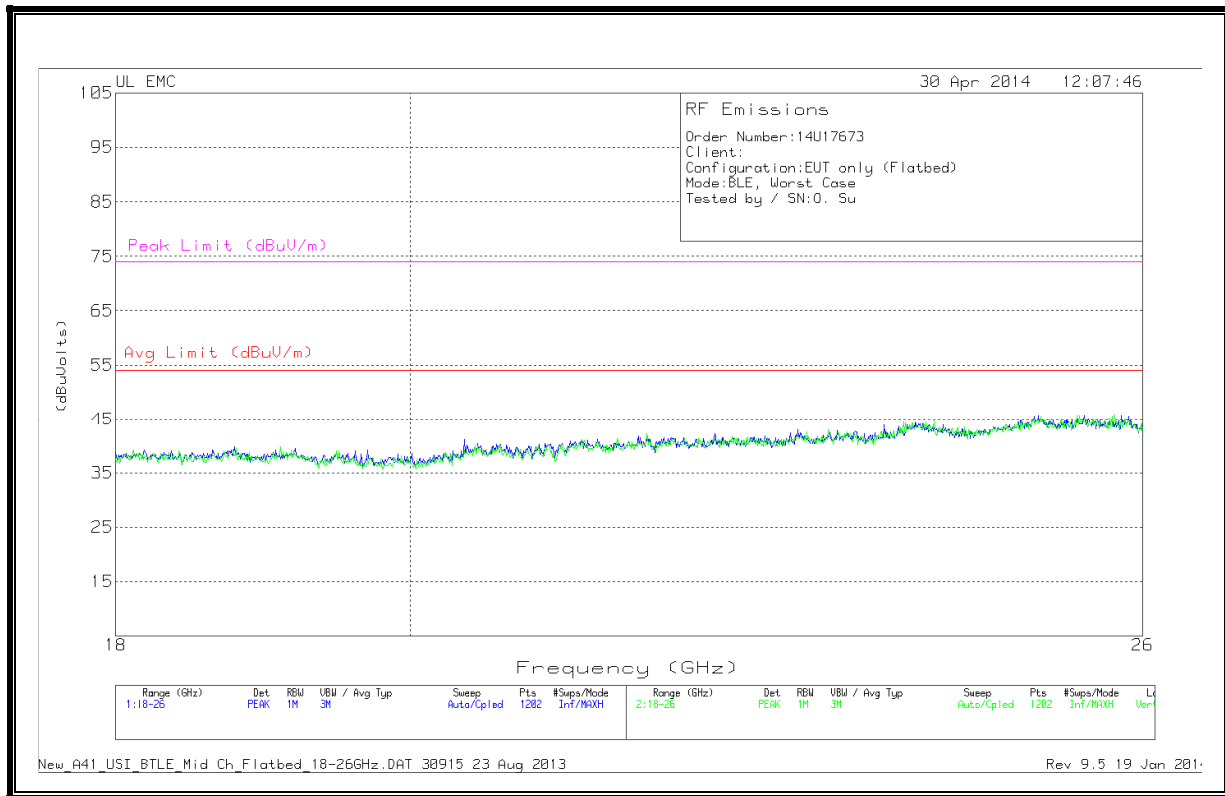

10.4. WORST-CASE BELOW 1 GHz

SPURIOUS EMISSIONS 30 TO 1000 MHz (WORST-CASE CONFIGURATION, HORIZONTAL)

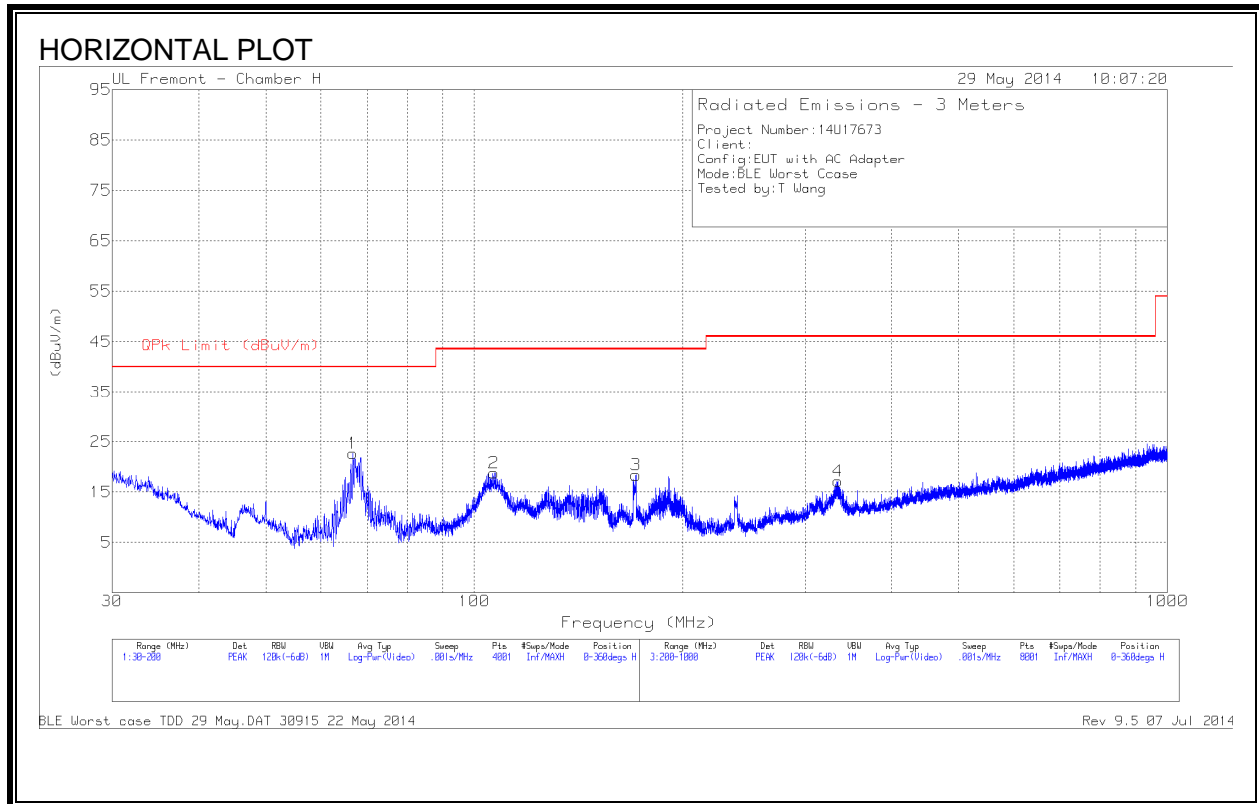

SPURIOUS EMISSIONS 30 TO 1000 MHz (WORST-CASE CONFIGURATION, VERTICAL)

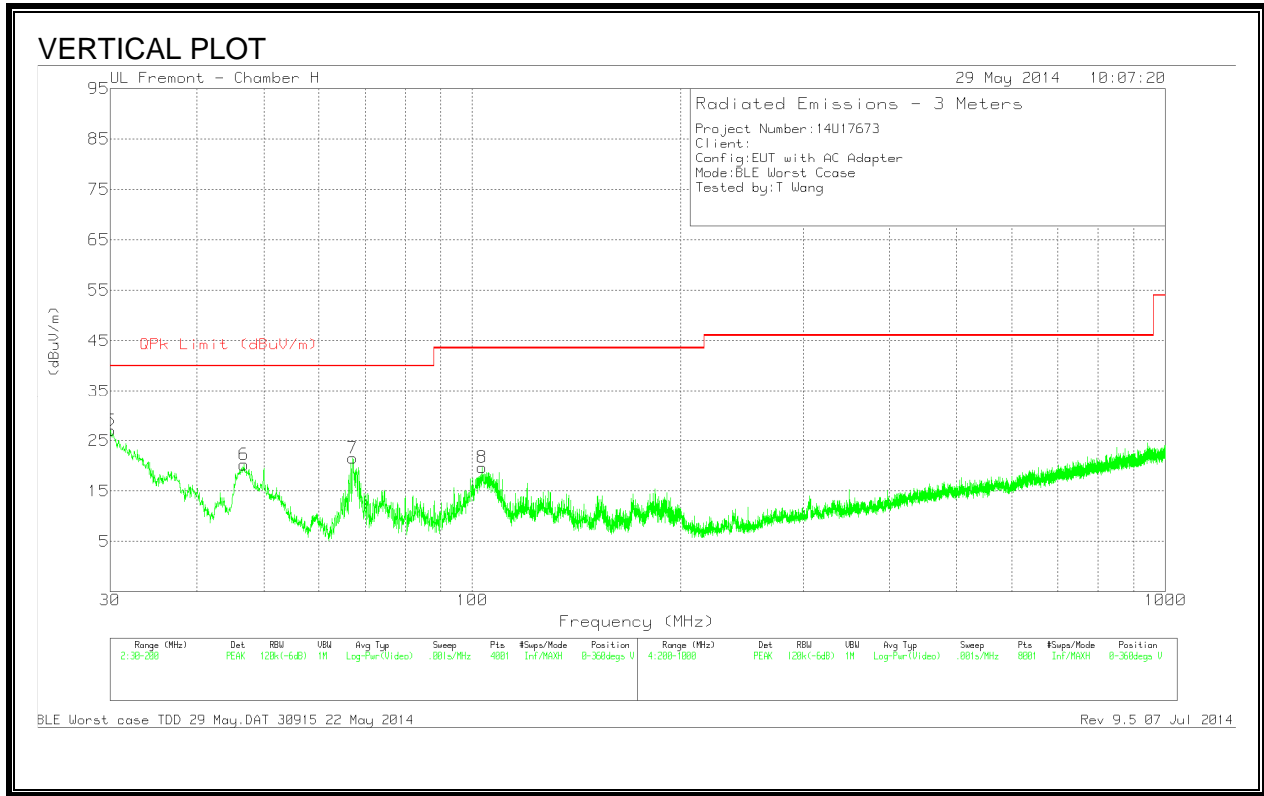

DATA

Trace Markers

Marker	Frequency (MHz)	Meter Reading (dBuV)	Det	Hybrid	Amp/Cbl (dB)	Corrected Reading (dBuV/m)	QPk Limit (dBuV/m)	Margin (dB)	Azimuth (Degs)	Height (cm)	Polarity
6	* 332.6	32.83	PK	14	-30.1	16.73	46.02	-29.29	0-360	100	H
7	* 331.7	30.6	PK	14	-30.2	14.4	46.02	-31.62	0-360	100	V
3	30.1275	36.97	PK	21.4	-31.8	26.57	40	-13.43	0-360	100	V
4	46.83	42.13	PK	9.4	-31.7	19.83	40	-20.17	0-360	100	V
1	50.0175	37.54	PK	7.9	-31.6	13.84	40	-26.16	0-360	200	H
5	67.23	44.54	PK	8.1	-31.6	21.04	40	-18.96	0-360	100	V
2	68.4625	45.78	PK	8.1	-31.5	22.38	40	-17.62	0-360	200	H

* - indicates frequency in CFR15.205/IC7.2.2 Restricted Band

PK - Peak detector

11. AC POWER LINE CONDUCTED EMISSIONS

LIMITS

FCC §15.207 (a)

RSS-Gen 7.2.2

Frequency of Emission (MHz)	Conducted Limit (dBuV)	
	Quasi-peak	Average
0.15-0.5	66 to 56*	56 to 46*
0.5-5	56	46
5-30	60	50

*Decreases with the logarithm of the frequency.

TEST PROCEDURE

The EUT is placed on a non-conducting table 40 cm from the vertical ground plane and 80 cm above the horizontal ground plane. The EUT is configured in accordance with ANSI C63.4.

The receiver is set to a resolution bandwidth of 9 kHz. Peak detection is used unless otherwise noted as quasi-peak or average.

Line conducted data is recorded for both NEUTRAL and HOT lines.

RESULTS

6 WORST EMISSIONS

Line-L1 .15 - 30MHz

Trace Markers

Marker	Frequency (MHz)	Meter Reading (dBuV)	Det	T24 IL L1 (dB)	LC Cables 1&3 (dB)	Corrected Reading dBuV	CISPR 22 Class B QP	Margin to Limit (dB)	CISPR 22 Class B Avg	Margin to Limit (dB)
1	.168	46.88	PK	1.2	0	48.08	65.1	-17.02	-	-
2	.168	27.4	Av	1.2	0	28.6	-	-	55.1	-26.5
3	.7845	43.65	PK	.3	0	43.95	56	-12.05	-	-
4	.7845	31.31	Av	.3	0	31.61	-	-	46	-14.39
5	18.051	29.72	PK	.3	.2	30.22	60	-29.78	-	-
6	18.051	16.56	Av	.3	.2	17.06	-	-	50	-32.94

Line-L2 .15 - 30MHz

Trace Markers

Marker	Frequency (MHz)	Meter Reading (dBuV)	Det	T24 IL L2 (dB)	LC Cables 2&3 (dB)	Corrected Reading dBuV	CISPR 22 Class B QP	Margin to Limit (dB)	CISPR 22 Class B Avg	Margin to Limit (dB)
7	.168	46.23	PK	1.3	0	47.53	65.1	-17.57	-	-
8	.168	25.22	Av	1.3	0	26.52	-	-	55.1	-28.58
9	.7935	42.97	PK	.3	0	43.27	56	-12.73	-	-
10	.7935	26.04	Av	.3	0	26.34	-	-	46	-19.66
11	22.641	40.06	PK	.3	.2	40.56	60	-19.44	-	-
12	22.641	6.62	Av	.3	.2	7.12	-	-	50	-42.88
13	23.892	35.93	PK	.3	.2	36.43	60	-23.57	-	-
14	23.892	5.43	Av	.3	.2	5.93	-	-	50	-44.07

PK - Peak detector

Av - average detection

LINE 1 RESULTS

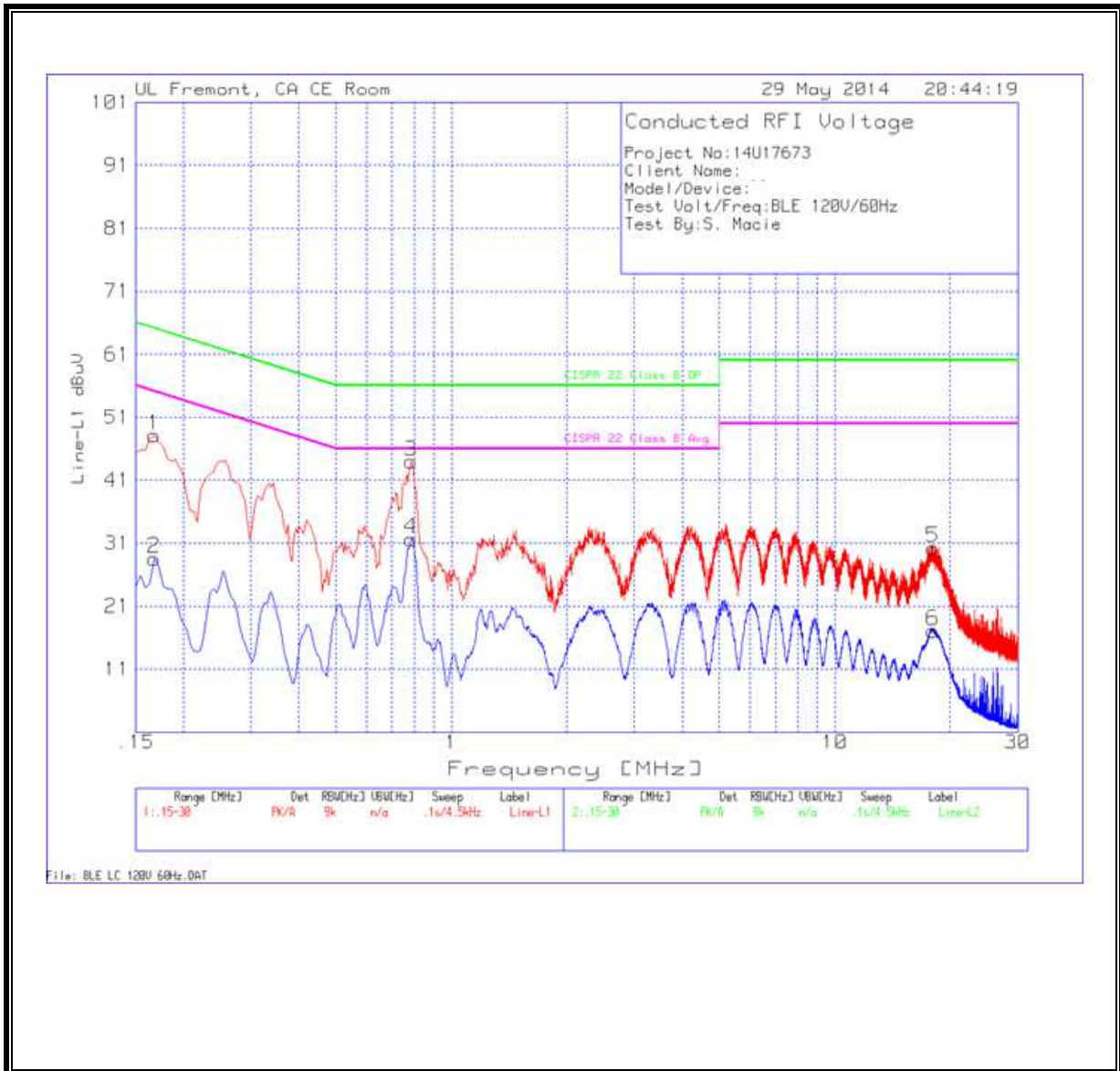

LINE 2 RESULTS

