



**FCC 47 CFR PART 15 SUBPART E
INDUSTRY CANADA RSS-210 ISSUE 8**

CERTIFICATION TEST REPORT

FOR

CELLULAR PHONE WITH BLUETOOTH AND WLAN RADIOS

MODEL NUMBER: A1549

FCC ID: BCG-E2816A

REPORT NUMBER: 14U17673-E10, REVISION C

ISSUE DATE: AUGUST 02, 2014

Prepared for
APPLE, INC.
1 INFINITE LOOP
CUPERTINO, CA 95014, U.S.A.

Prepared by
UL VERIFICATION SERVICES INC.
47173 BENICIA STREET
FREMONT, CA 94538, U.S.A.
TEL: (510) 771-1000
FAX: (510) 661-0888



NVLAP LAB CODE 200065-0

Revision History

Rev.	Issue Date	Revisions	Revised By
--	7/21/14	Initial Issue	F. deAnda
A	7/23/14	Update Product Description	M. Hua
B	7/29/14	Update product description, section 5.2, 5.5, 5.6, and 10	D. Garcia
C	08/02/14	Address TCB Questions	T. Lee

TABLE OF CONTENTS

1. ATTESTATION OF TEST RESULTS	5
2. TEST METHODOLOGY	6
3. FACILITIES AND ACCREDITATION	6
4. CALIBRATION AND UNCERTAINTY	6
4.1. <i>MEASURING INSTRUMENT CALIBRATION</i>	<i>6</i>
4.2. <i>SAMPLE CALCULATION</i>	<i>6</i>
4.3. <i>MEASUREMENT UNCERTAINTY.....</i>	<i>7</i>
5. EQUIPMENT UNDER TEST	8
5.1. <i>DESCRIPTION OF EUT</i>	<i>8</i>
5.2. <i>MAXIMUM OUTPUT POWER.....</i>	<i>8</i>
5.3. <i>DESCRIPTION OF AVAILABLE ANTENNAS</i>	<i>8</i>
5.4. <i>SOFTWARE AND FIRMWARE.....</i>	<i>8</i>
5.5. <i>WORST-CASE CONFIGURATION AND MODE.....</i>	<i>9</i>
5.6. <i>DESCRIPTION OF TEST SETUP.....</i>	<i>10</i>
6. TEST AND MEASUREMENT EQUIPMENT	14
7. MEASUREMENT METHODS	15
8. ON TIME, DUTY CYCLE AND MEASUREMENT METHODS	16
8.1. <i>ON TIME AND DUTY CYCLE RESULTS.....</i>	<i>16</i>
9. ANTENNA PORT TEST RESULTS	16
10. RADIATED TEST RESULTS	17
10.1. <i>LIMITS AND PROCEDURE.....</i>	<i>17</i>
10.2. <i>TRANSMITTER ABOVE 1 GHz.....</i>	<i>18</i>
10.2.1. <i>TX ABOVE 1 GHz 802.11a MODE IN THE 5.2 GHz BAND.....</i>	<i>18</i>
10.2.2. <i>TX ABOVE 1 GHz 802.11n HT20 MODE IN THE 5.2 GHz BAND</i>	<i>26</i>
10.2.3. <i>TX ABOVE 1 GHz 802.11n HT40 MODE IN THE 5.2 GHz BAND</i>	<i>34</i>
10.2.4. <i>TX ABOVE 1G 802.11ac 80MHz MODE IN THE 5.2 GHz BAND</i>	<i>40</i>
10.2.5. <i>TX ABOVE 1 GHz 802.11a MODE IN THE 5.3 GHz BAND.....</i>	<i>44</i>
10.2.6. <i>TX ABOVE 1 GHz 802.11n HT20 MODE IN THE 5.3 GHz BAND</i>	<i>52</i>
10.2.7. <i>TX ABOVE 1 GHz 802.11n HT40 MODE IN THE 5.3 GHz BAND</i>	<i>60</i>
10.2.8. <i>TX ABOVE 1G 802.11ac 80MHz MODE IN THE 5.3 GHz BAND</i>	<i>66</i>
10.2.9. <i>TX ABOVE 1 GHz 802.11a MODE IN THE 5.6 GHz BAND.....</i>	<i>70</i>
10.2.10. <i>TX ABOVE 1 GHz 802.11n HT20 MODE IN THE 5.6 GHz BAND</i>	<i>79</i>
10.2.11. <i>TX ABOVE 1 GHz 802.11n HT20 MODE, CHANNEL 144, 5.6 GHz BAND</i>	<i>88</i>
10.2.12. <i>TX ABOVE 1 GHz 802.11n HT40 MODE IN THE 5.6 GHz BAND</i>	<i>91</i>
10.2.13. <i>TX ABOVE 1 GHz 802.11n HT40 MODE, CHANNEL 142, 5.6 GHz BAND</i>	<i>100</i>
10.2.14. <i>TX ABOVE 1G 802.11ac 80MHz MODE IN THE 5.6 GHz BAND</i>	<i>103</i>

10.2.15.	TX ABOVE 1 GHz 802.11n ac80 MODE, CHANNEL 138, 5.6 GHz BAND.....	107
10.2.16.	TX ABOVE 1 GHz 802.11a MODE IN THE 5.8 GHz BAND.....	110
10.2.17.	TX ABOVE 1 GHz 802.11n HT20 MODE IN THE 5.8 GHz BAND	118
10.2.18.	TX ABOVE 1 GHz 802.11n HT40 MODE IN THE 5.8 GHz BAND	126
10.2.19.	TX ABOVE 1G 802.11ac 80MHz MODE IN THE 5.8 GHz BAND	132
10.3.	<i>WORST-CASE BELOW 1 GHz</i>	136
10.4.	<i>WORST-CASE 18 to 26 GHz</i>	138
10.5.	<i>WORST-CASE 26 to 40 GHz</i>	142
11.	AC POWER LINE CONDUCTED EMISSIONS	146
12.	DYNAMIC FREQUENCY SELECTION	150
13.	SETUP PHOTOS	151

1. ATTESTATION OF TEST RESULTS

COMPANY NAME: APPLE, INC.
1 INFINITE LOOP
CUPERTINO, CA 95014, U.S.A.

EUT DESCRIPTION: CELLULAR PHONE WITH BLUETOOTH AND WLAN RADIOS

MODEL: A1549

SERIAL NUMBER: C39MF01KFY6W - Conducted, C39MD06FFY70 – Radiated

DATE TESTED: MAY 1, 2014 – JUNE 12, 2014

APPLICABLE STANDARDS	
STANDARD	TEST RESULTS
CFR 47 Part 15 Subpart E	Pass
INDUSTRY CANADA RSS-210 Issue 8 Annex 9	Pass
INDUSTRY CANADA RSS-GEN Issue 3	Pass

UL Verification Services Inc. tested the above equipment in accordance with the requirements set forth in the above standards. All indications of Pass/Fail in this report are opinions expressed by UL Verification Services Inc. based on interpretations and/or observations of test results. Measurement Uncertainties were not taken into account and are published for informational purposes only. The test results show that the equipment tested is capable of demonstrating compliance with the requirements as documented in this report.

Note: The results documented in this report apply only to the tested sample, under the conditions and modes of operation as described herein. This document may not be altered or revised in any way unless done so by UL Verification Services Inc. and all revisions are duly noted in the revisions section. Any alteration of this document not carried out by UL Verification Services Inc. will constitute fraud and shall nullify the document. This report must not be used by the client to claim product certification, approval, or endorsement by NVLAP, NIST, any agency of the Federal Government, or any agency of any government.

Approved & Released For
UL Verification Services Inc. By:

Tested By:



FRANCISCO DE ANDA
PROJECT LEAD
UL VERIFICATION SERVICES INC.



MONA HUA
EMC ENGINEER
UL VERIFICATION SERVICES INC.

2. TEST METHODOLOGY

The tests documented in this report were performed in accordance with FCC CFR 47 Part 2, FCC CFR 47 Part 15, FCC 06-96, FCC KDB 789033 and ANSI C63.10-2009.

Per FCC guidance, radiated tests are performed for A1549 to ensure that there is no deviation in EM fields between Model A1549 and Model A1586.

3. FACILITIES AND ACCREDITATION

The test sites and measurement facilities used to collect data are located at 47173 and 47266 Benicia Street, Fremont, California, USA. Line conducted emissions are measured only at the 47173 address. The following table identifies which facilities were utilized for radiated emission measurements documented in this report. Specific facilities are also identified in the test results sections.

47173 Benicia Street	47266 Benicia Street
<input type="checkbox"/> Chamber A	<input checked="" type="checkbox"/> Chamber D
<input type="checkbox"/> Chamber B	<input checked="" type="checkbox"/> Chamber E
<input type="checkbox"/> Chamber C	<input checked="" type="checkbox"/> Chamber F
	<input checked="" type="checkbox"/> Chamber G
	<input checked="" type="checkbox"/> Chamber H

UL Verification Services Inc. is accredited by NVLAP, Laboratory Code 200065-0. The full scope of accreditation can be viewed at <http://ts.nist.gov/standards/scopes/2000650.htm>.

4. CALIBRATION AND UNCERTAINTY

4.1. MEASURING INSTRUMENT CALIBRATION

The measuring equipment utilized to perform the tests documented in this report has been calibrated in accordance with the manufacturer's recommendations, and is traceable to recognized national standards.

4.2. SAMPLE CALCULATION

Where relevant, the following sample calculation is provided:

$$\begin{aligned} \text{Field Strength (dBuV/m)} &= \text{Measured Voltage (dBuV)} + \text{Antenna Factor (dB/m)} + \\ &\text{Cable Loss (dB)} - \text{Preamp Gain (dB)} \\ 36.5 \text{ dBuV} + 18.7 \text{ dB/m} + 0.6 \text{ dB} - 26.9 \text{ dB} &= 28.9 \text{ dBuV/m} \end{aligned}$$

4.3. MEASUREMENT UNCERTAINTY

Where relevant, the following measurement uncertainty levels have been estimated for tests performed on the apparatus:

PARAMETER	UNCERTAINTY
Conducted Disturbance, 0.15 to 30 MHz	±3.52 dB
Radiated Disturbance, 30 to 1000 MHz	±4.94 dB

Uncertainty figures are valid to a confidence level of 95%.

5. EQUIPMENT UNDER TEST

5.1. DESCRIPTION OF EUT

Model A1549 is a mobile phone with multimedia functions (music, application support, and video), Cellular GSM/GPRS/EGPRS/CDMA2000/EVDO Rev.A/ EVDO Rev.B /WCDMA/HSPA+/DC-HSDPA/LTE FDD & Carrier Aggregation radio, IEEE 802.11a/b/g/n/ac radio, Bluetooth radio and NFC. The rechargeable battery is not user accessible.

5.2. MAXIMUM OUTPUT POWER

For Maximum power data, refer to Model A1586 FCC UNII WLAN report.

5.3. DESCRIPTION OF AVAILABLE ANTENNAS

The radio utilizes a PiFA antenna, with a maximum gain as below table:

FREQUENCY (MHZ)	ANTENNA GAIN (dBi)
5150 -- 5250	-3.96
5250 -- 5350	-3.49
5500 -- 5700	-1.36
5725 -- 5850	-1.4

5.4. SOFTWARE AND FIRMWARE

The firmware installed in the EUT during testing was 7.16.121

The test utility software used during testing was wl 7.16 RC121.0.

5.5. WORST-CASE CONFIGURATION AND MODE

Radiated emission and power line conducted emission were performed with the EUT set to transmit at the channel with highest output power as worst-case scenario.

The fundamental of the EUT was investigated in three orthogonal orientations X (Flatbed), Y (Landscape), Z (Portrait), it was determined that Y orientation was worst-case orientation; therefore, all final radiated testing was performed with the EUT in Y (Landscape) orientation.

Worst-case data rates as provided by the client were:

802.11a mode: 6 Mbps

802.11n HT20mode: MCS0

802.11n HT40mode: MCS0

802.11n AC80mode: MCS0

Radiated emissions for EUT with antenna was performed and passed; therefore, antenna port spurious was not performed.

Radiated spurious emissions were performed with the EUT set to transmit at the channel with the highest output power as worst case scenario.

There are three vendors of the WiFi/Bluetooth radio modules: variant 1, variant 2 and variant 3 and they have the same mechanical outline, same on board antenna, matching circuit, antenna structure and same specification. Baseline testing was performed on all three variants to determine the worst case on all conducted power and radiated emissions.

5.6. DESCRIPTION OF TEST SETUP

SUPPORT EQUIPMENT

Support Equipment List				
Description	Manufacturer	Model	Serial Number	FCC ID
AC/DC adapter	Apple	A1401	60812	NA
Earphone	Apple	NA	NA	NA
Laptop	Apple	A1278	C02HJ0A7DTY4	NA

I/O CABLES (CONDUCTED TEST)

I/O Cable List						
Cable No	Port	# of identical ports	Connector Type	Cable Type	Cable Length (m)	Remarks
1	Antenna	1	SMA	Un-Shielded	0.1	to spectrum Analyzer
2	USB	1	USB	Shielded	1m	To EUT

I/O CABLES (RADIATED ABOVE 1 GHZ)

I/O Cable List						
Cable No	Port	# of identical ports	Connector Type	Cable Type	Cable Length (m)	Remarks
None used						

I/O CABLES (BELOW 1GHZ & AC LINE CONDUCTED TESTS)

I/O Cable List						
Cable No	Port	# of identical ports	Connector Type	Cable Type	Cable Length (m)	Remarks
1	AC	1	US115	Un-Shielded	80cm	NA
2	DC	1	USB	Un-Shielded	1m	NA
3	Audio	1	Jack	Un-Shielded	0.5m	NA

TEST SETUP- CONDUCTED PORT

The EUT was tested connected to a host Laptop via USB cable adapter and spectrum analyzer to antenna port. Test software exercised the EUT.

SETUP DIAGRAM

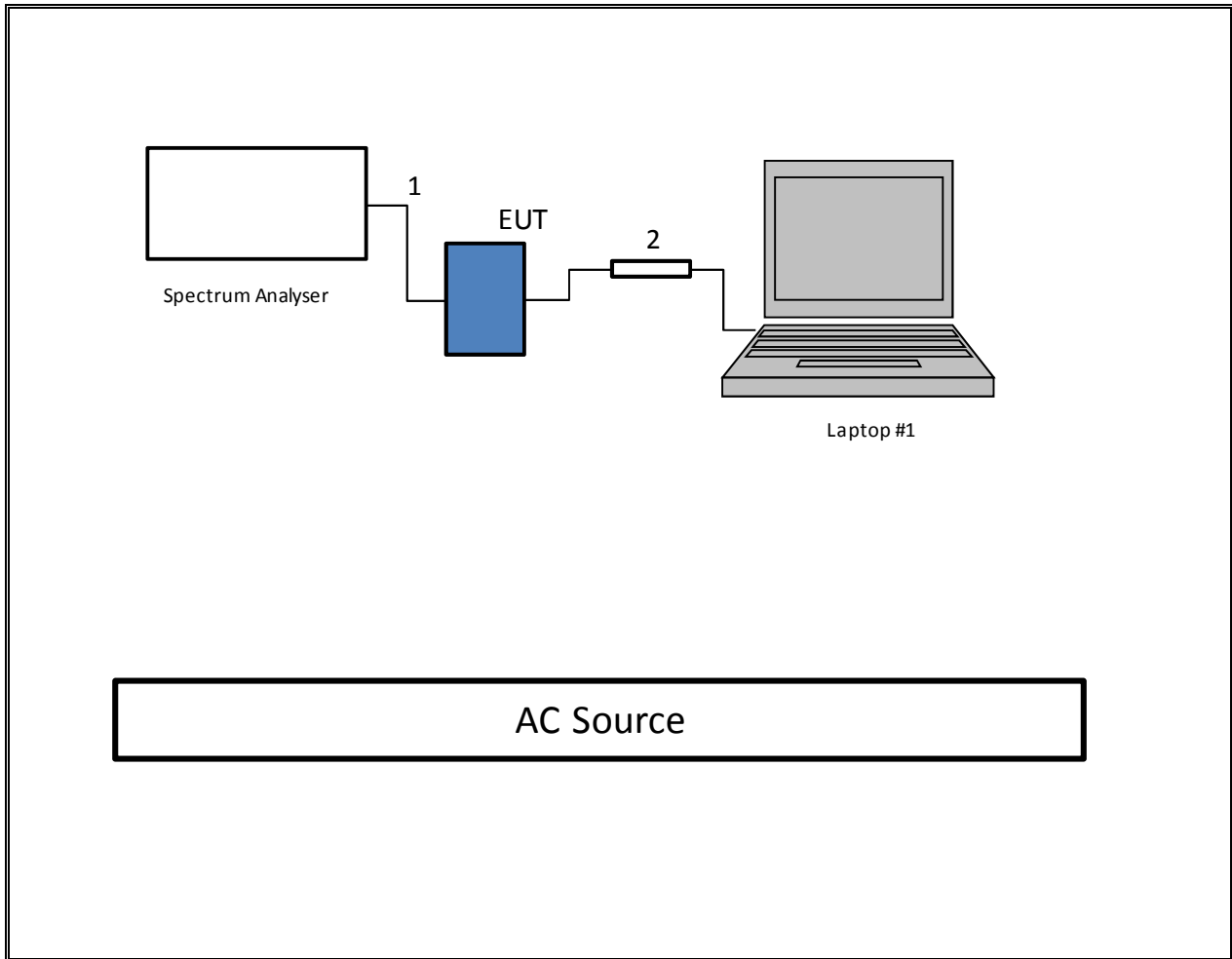

TEST SETUP- RADIATED-ABOVE 1 GHZ

The EUT was tested battery powered. Test software exercised the EUT.

SETUP DIAGRAM

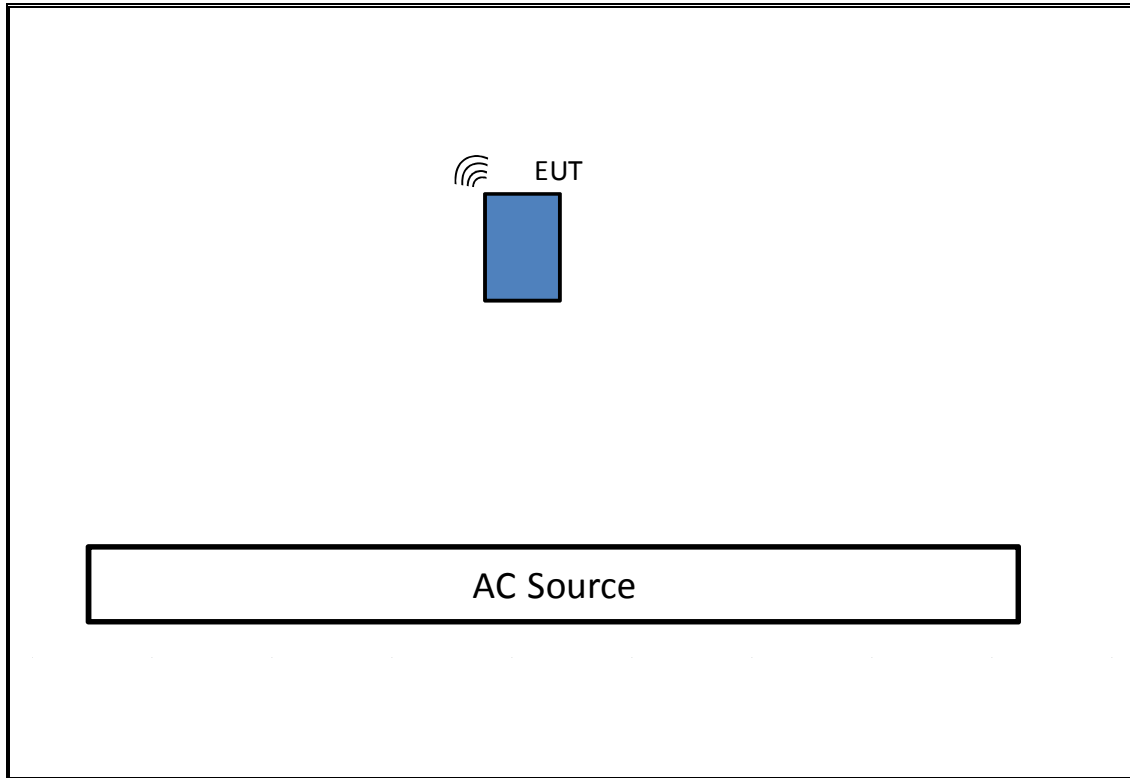

TEST SETUP- BELOW 1GHZ & AC LINE CONDUCTED TESTS

The EUT was tested with earphones connected and powered by AC adapter. Test software exercised the EUT.

SETUP DIAGRAM

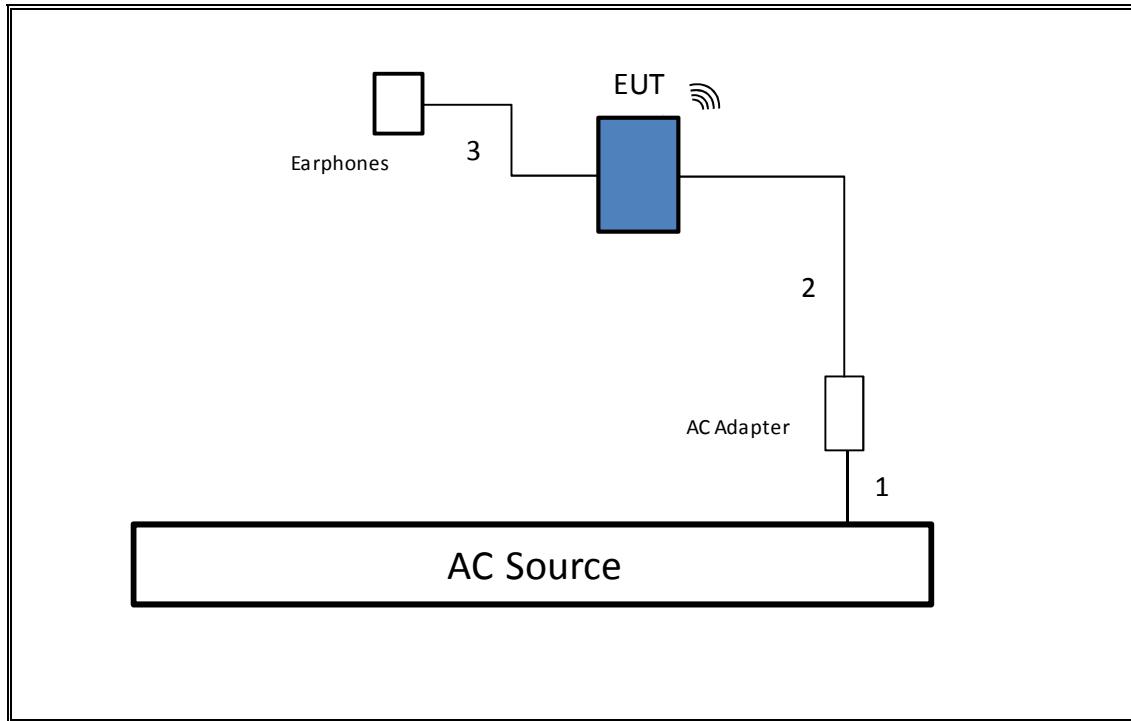

6. TEST AND MEASUREMENT EQUIPMENT

The following test and measurement equipment was utilized for the tests documented in this report:

TEST EQUIPMENT LIST				
Description	Manufacturer	Model	Asset	Cal Due
Antenna, Horn, 18 GHz	ETS Lindgren	3117	F00131	02/18/15
Antenna, Horn, 26.5 GHz	ARA	MWH-1826	C00589	11/26/14
Antenna, Horn, 40 GHz	ARA	MWH-2640	C00981	06/28/14
Peak / Average Power Sensor	Agilent / HP	N1911A	F00153	03/06/15
Peak Power Meter	Agilent / HP	E9323A	F00025	04/30/15
Spectrum Analyzer, 44 GHz	Agilent / HP	N9030A	F00129	02/22/15
Antenna, Bilog, 2 GHz	Sunol Sciences	JB1	F00168	03/28/15
Preamplifier, 1300 MHz	Sonoma	310	F00008	05/27/15
Preamplifier, 26.5 GHz	Agilent / HP	8449B	F00165	03/25/15
Preamplifier, 40 GHz	Miteq	NSP4000-SP2	C00990	08/20/14
EMI Test Receiver, 9 kHz-7 GHz	R & S	ESCI 7	F00092	09/05/14
LISN, 30 MHz	FCC	LISN-50/250-25-2	C00626	01/14/15

7. MEASUREMENT METHODS

26 dB Emission BW: KDB 789033 D02 v01, Section C.

99% Occupied BW: KDB 789033 D02 v01, Section D.

Power and PSD: KDB 789033 D02 v01, Method SA-1 and SA-1 Alternative.

Power Spectral Density: KDB 789033 D02 v01, Section F.

Unwanted emissions in restricted bands: KDB 789033 D02 v01, Sections G.3, G.4, G.5, and G.6.

Unwanted emissions in non-restricted bands: KDB 789033 D02 v01, Sections G.3, G.4, and G.5.

8. ON TIME, DUTY CYCLE AND MEASUREMENT METHODS

LIMITS

None; for reporting purposes only.

PROCEDURE

KDB 789033 Zero-Span Spectrum Analyzer Method.

8.1. ON TIME AND DUTY CYCLE RESULTS

For on time and duty cycle data, refer to Model A1586 FCC UNII WLAN report.

9. ANTENNA PORT TEST RESULTS

For conducted port data, refer to Model A1586 FCC UNII WLAN report.

10. RADIATED TEST RESULTS

10.1. LIMITS AND PROCEDURE

LIMITS

FCC §15.205 and §15.209

Frequency Range (MHz)	Field Strength Limit (uV/m) at 3 m	Field Strength Limit (dBuV/m) at 3 m
30 - 88	100	40
88 - 216	150	43.5
216 - 960	200	46
Above 960	500	54

TEST PROCEDURE

The EUT is placed on a non-conducting table 80 cm above the ground plane. The antenna to EUT distance is 3 meters.

For measurements below 1 GHz the resolution bandwidth is set to 100 kHz for peak detection measurements or 120 kHz for quasi-peak detection measurements. Peak detection is used unless otherwise noted as quasi-peak.

For measurements above 1 GHz the resolution bandwidth is set to 1 MHz; the video bandwidth is set to 1 MHz for peak measurements and as applicable for average measurements.

The spectrum from 30 MHz to 40 GHz is investigated with the transmitter set to the lowest, middle, and highest channels in each applicable band.

The frequency range of interest is monitored at a fixed antenna height and EUT azimuth. The EUT is rotated through 360 degrees to maximize emissions received. The antenna is scanned from 1 to 4 meters above the ground plane to further maximize the emission. Measurements are made with the antenna polarized in both the vertical and the horizontal positions.

Per FCC guidance, radiated tests are performed to ensure there is no deviation in EM fields between Model A1549 and Model A1586.

10.2. TRANSMITTER ABOVE 1 GHz

10.2.1. TX ABOVE 1 GHz 802.11a MODE IN THE 5.2 GHz BAND

RESTRICTED BANDEDGE (LOW CHANNEL)

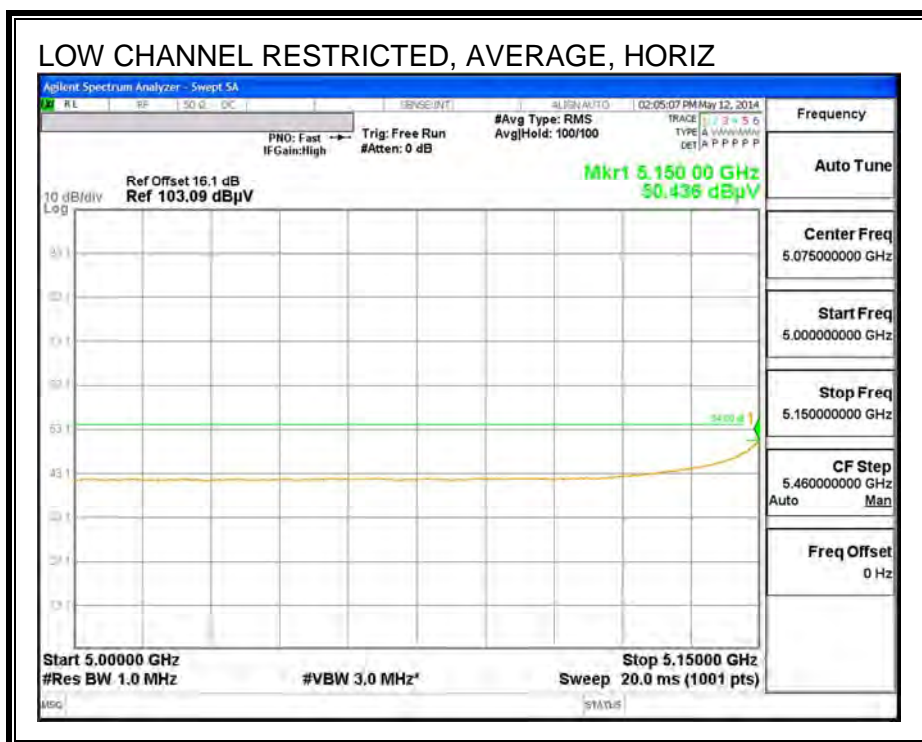
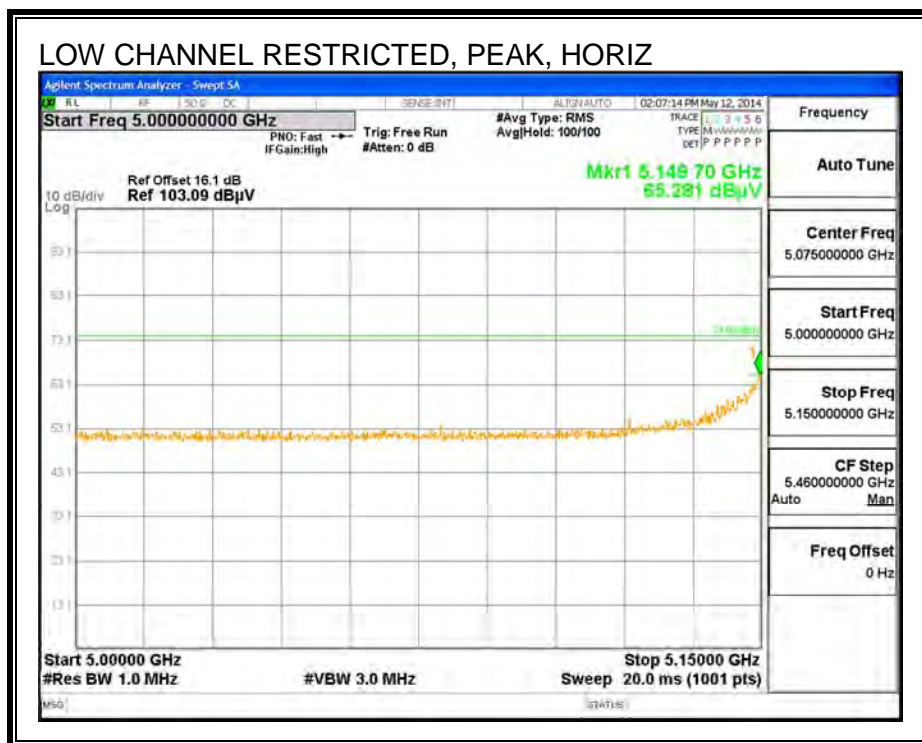

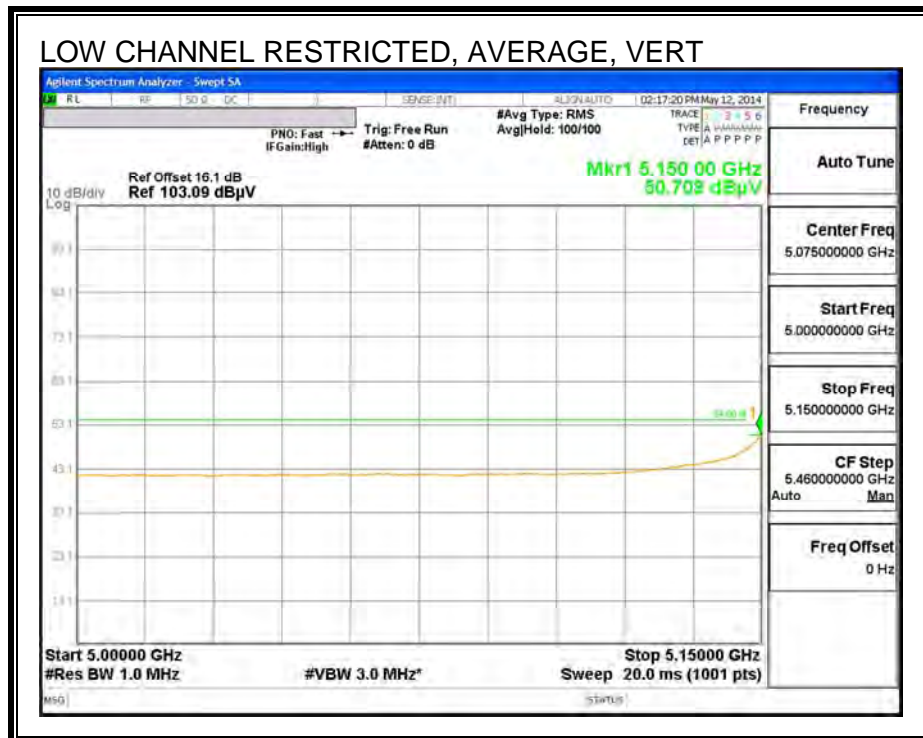
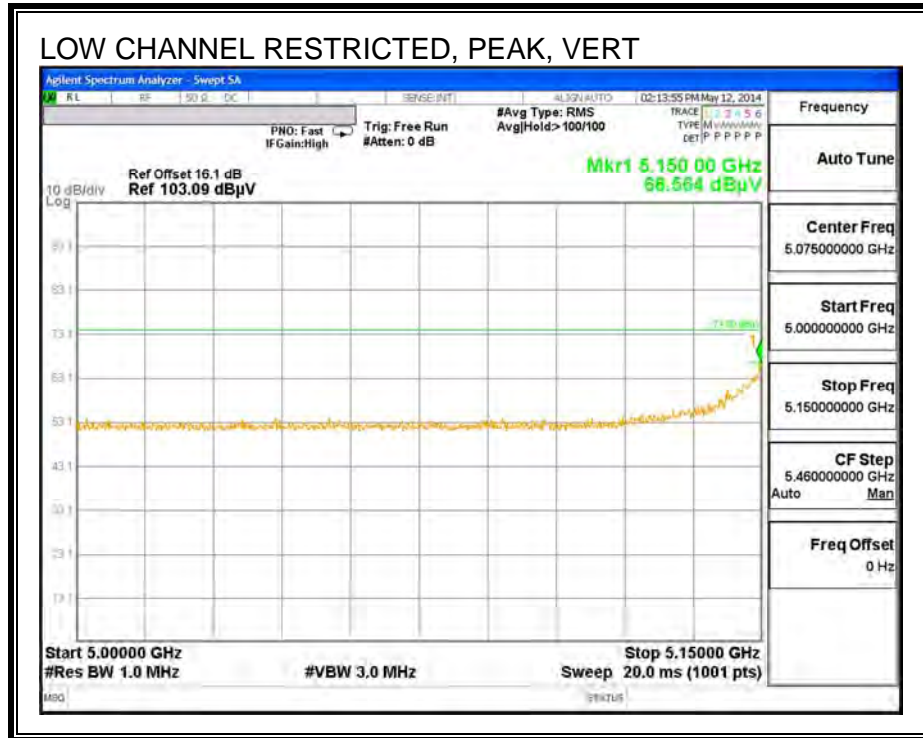

HARMONICS AND SPURIOUS EMISSIONS

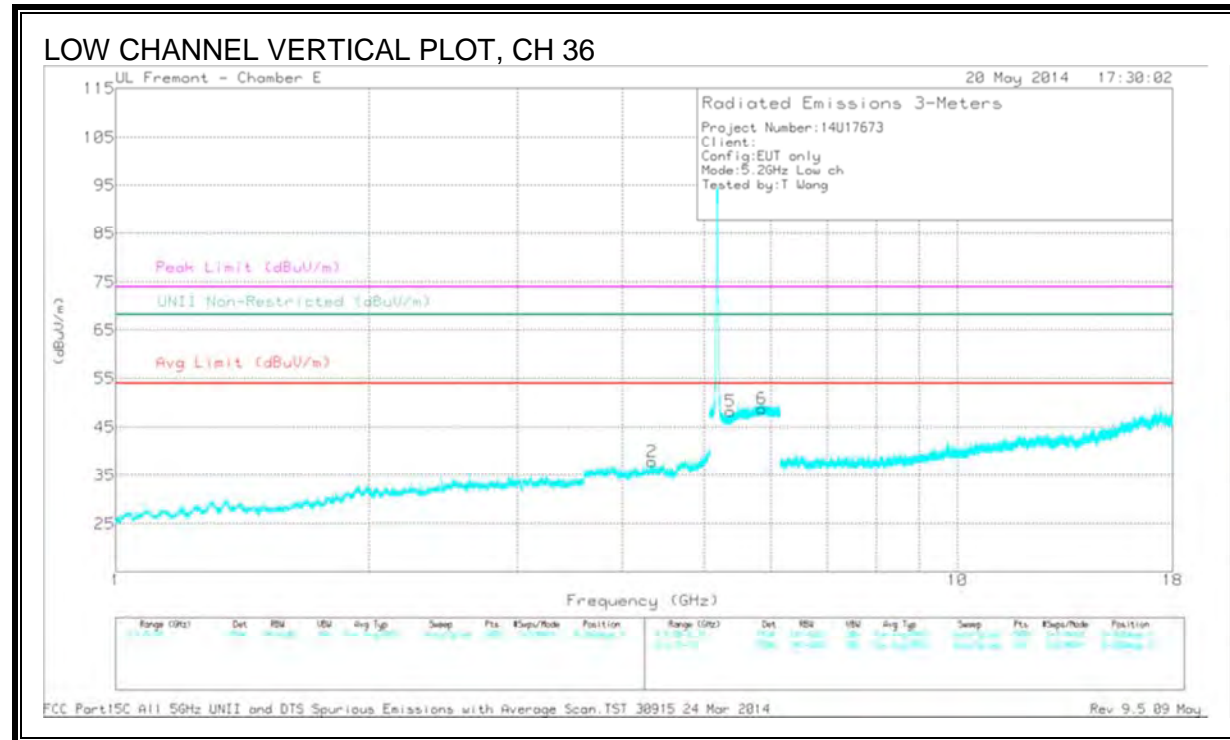
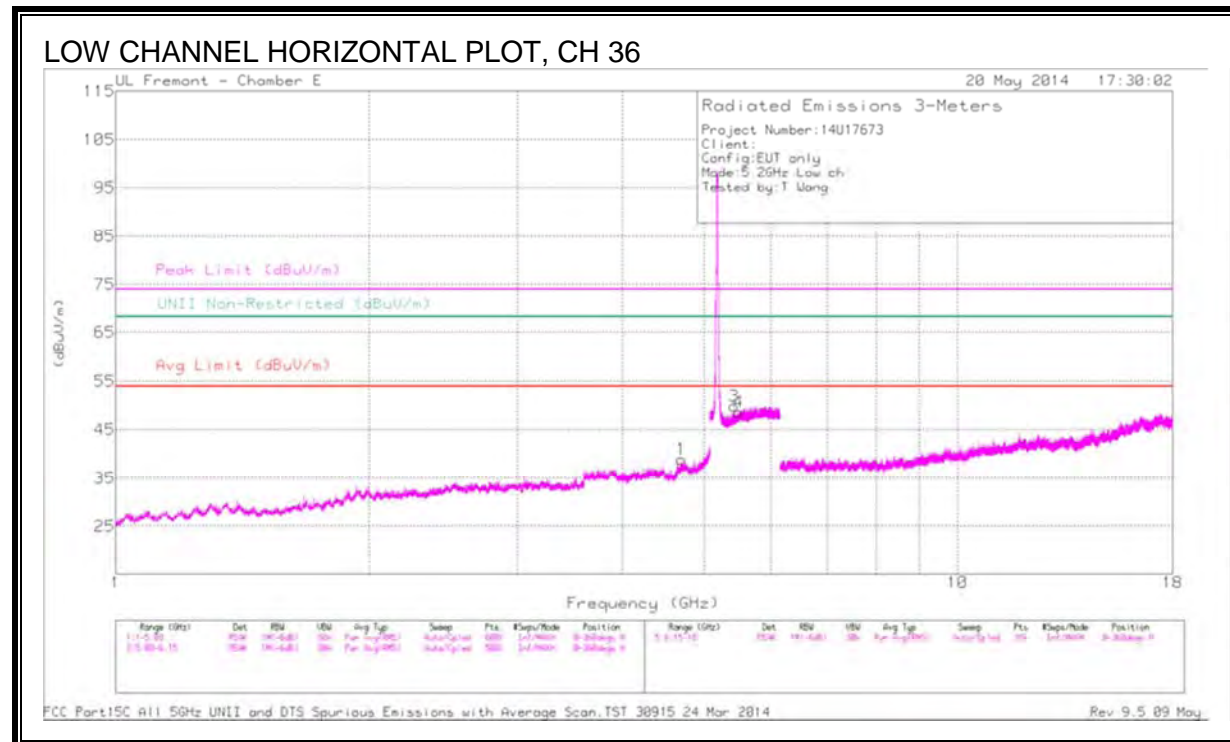

DATA

Frequency (GHz)	Meter Reading (dBuV)	Det	AF T346 (dB/m)	Amp/Cbl/Filtr /Pad (dB)	Corrected Reading (dBuV/m)	Avg Limit (dBuV/m)	Margin (dB)	Peak Limit (dBuV/m)	PK Margin (dB)	UNII Non-Restricted (dBuV/m)	PK Margin (dB)	Azimuth (Degs)	Height (cm)	Polarity
* 4.693	41.91	PK1	34.2	-29.8	46.31	-	-	74	-27.69	-	-	3	174	H
* 4.703	30.68	AD1	34.2	-30	34.88	54	-19.12	-	-	-	-	3	174	H
* 4.335	41.64	PK1	33.6	-30.9	44.34	-	-	74	-29.66	-	-	82	354	V
* 4.33	30.18	AD1	33.6	-30.6	33.18	54	-20.82	-	-	-	-	82	354	V
* 5.424	42.08	PK1	34.6	-21.1	55.58	-	-	74	-18.42	-	-	86	369	H
* 5.418	30.95	AD1	34.6	-21.1	44.45	54	-9.55	-	-	-	-	86	369	H
* 5.372	42.69	PK1	34.5	-21.3	55.89	-	-	74	-18.11	-	-	331	261	V
* 5.38	31.1	AD1	34.5	-21.3	44.3	54	-9.7	-	-	-	-	331	261	V
5.486	31.24	AD1	34.6	-20.7	45.14	-	-	-	-	-	-	253	379	H
5.491	42.4	PK1	34.6	-20.7	56.3	-	-	-	-	68.2	-11.9	253	379	H
5.851	31.23	AD1	35	-20.3	45.93	-	-	-	-	-	-	12	227	V
5.853	43.22	PK1	35	-20.3	57.92	-	-	-	-	68.2	-10.28	12	227	V

* - indicates frequency in CFR15.205/IC7.2.2 Restricted Band

PK1 - KDB789033 Method: Peak

AD1 - KDB789033 Method: AD Primary Power Average

MID CHANNEL HORIZONTAL PLOT, CH 40

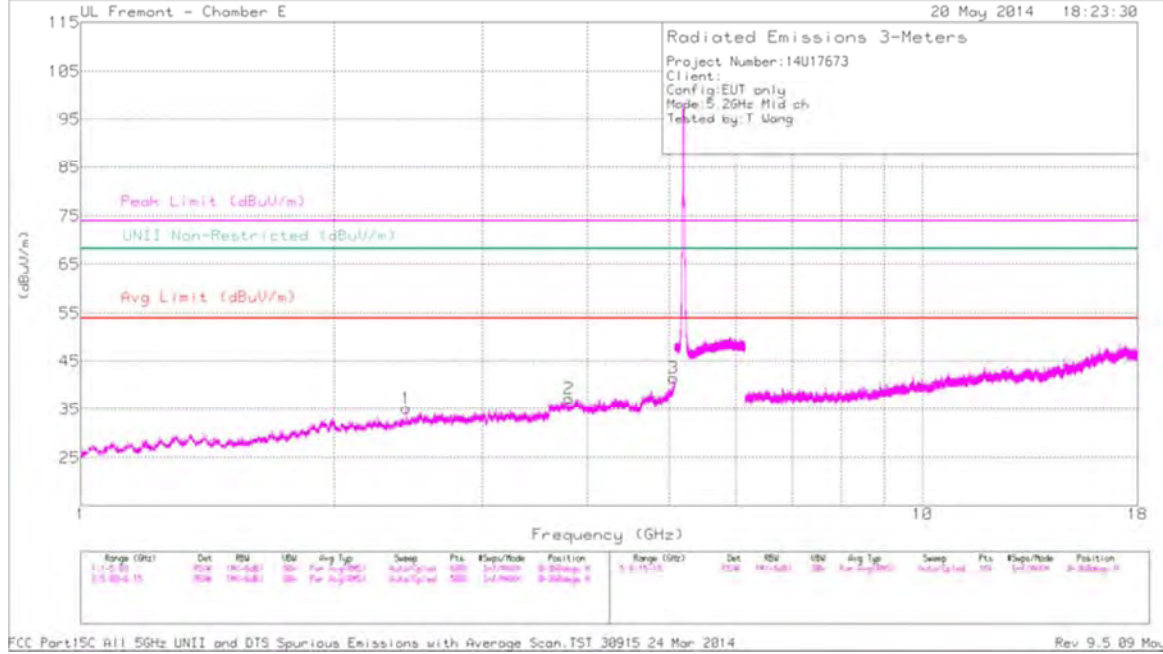

MID CHANNEL VERTICAL PLOT, CH 40

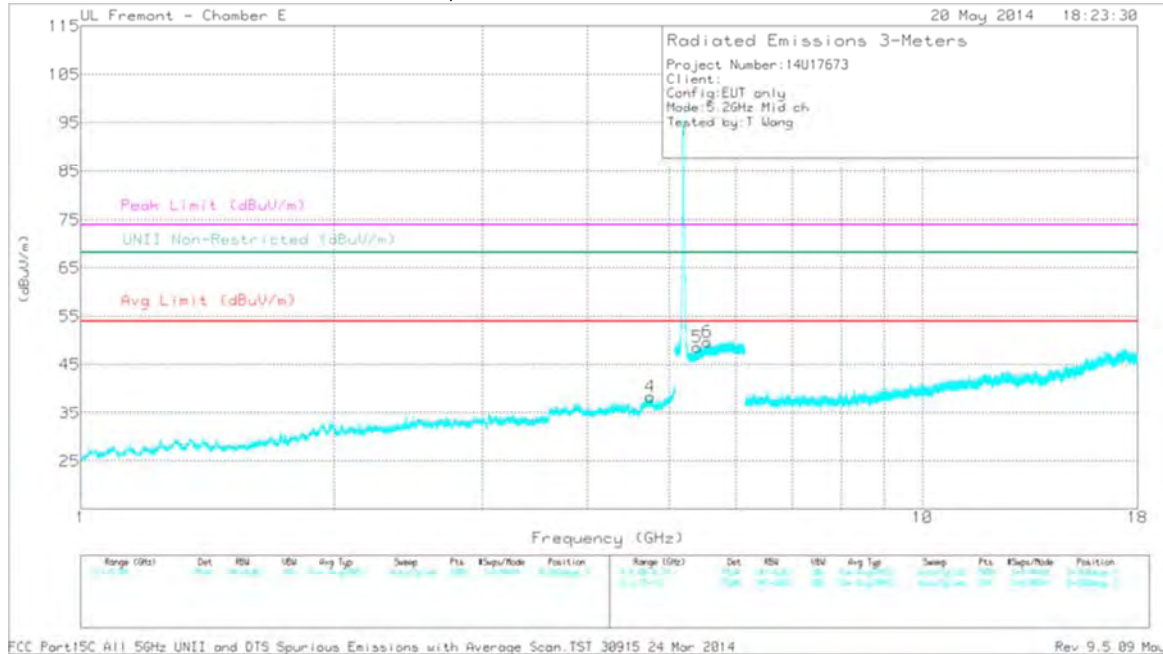

DATA

Frequency (GHz)	Meter Reading (dBuV)	Det	AF T346 (dB/m)	Amp/Cbl/Filtr /Pad (dB)	Corrected Reading (dBuV/m)	Avg Limit (dBuV/m)	Margin (dB)	Peak Limit (dBuV/m)	PK Margin (dB)	UNII Non-Restricted (dBuV/m)	PK Margin (dB)	Azimuth (Degs)	Height (cm)	Polarity
* 3.802	42.23	PK1	33.4	-31.9	43.73	-	-	74	-30.27	-	-	168	172	H
* 3.807	30.8	AD1	33.4	-31.9	32.3	54	-21.7	-	-	-	-	168	172	H
* 5.061	43	PK1	34.1	-28.2	48.9	-	-	74	-25.1	-	-	204	144	H
* 5.067	31.91	AD1	34.1	-28.1	37.91	54	-16.09	-	-	-	-	204	144	H
* 4.756	42.8	PK1	34.1	-30.6	46.3	-	-	74	-27.7	-	-	111	112	V
* 4.752	31.27	AD1	34.1	-30.6	34.77	54	-19.23	-	-	-	-	111	112	V
* 5.402	42.5	PK1	34.6	-21.1	56	-	-	74	-18	-	-	338	209	V
* 5.407	31.07	AD1	34.6	-21.1	44.57	54	-9.43	-	-	-	-	338	209	V
2.436	30.69	AD1	32.1	-33.1	29.69	-	-	-	-	-	-	143	392	H
2.439	43.43	PK1	32.2	-33.1	42.53	-	-	-	-	68.2	-25.67	143	392	H
5.557	42.62	PK1	34.5	-20.8	56.32	-	-	-	-	68.2	-11.88	54	142	V
5.56	31.37	AD1	34.5	-20.8	45.07	-	-	-	-	-	-	54	142	V

* - indicates frequency in CFR15.205/IC7.2.2 Restricted Band

PK1 - KDB789033 Method: Peak

AD1 - KDB789033 Method: AD Primary Power Average

HIGH CHANNEL HORIZONTAL PLOT, CH 48

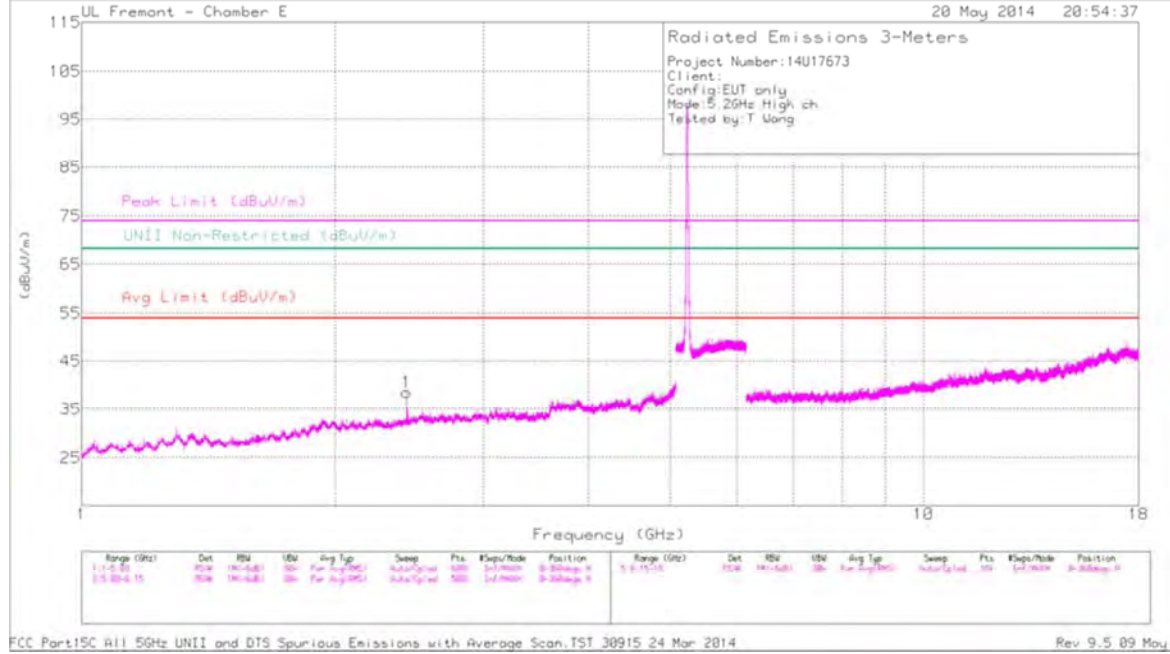

HIGH CHANNEL VERTICAL PLOT, CH 48

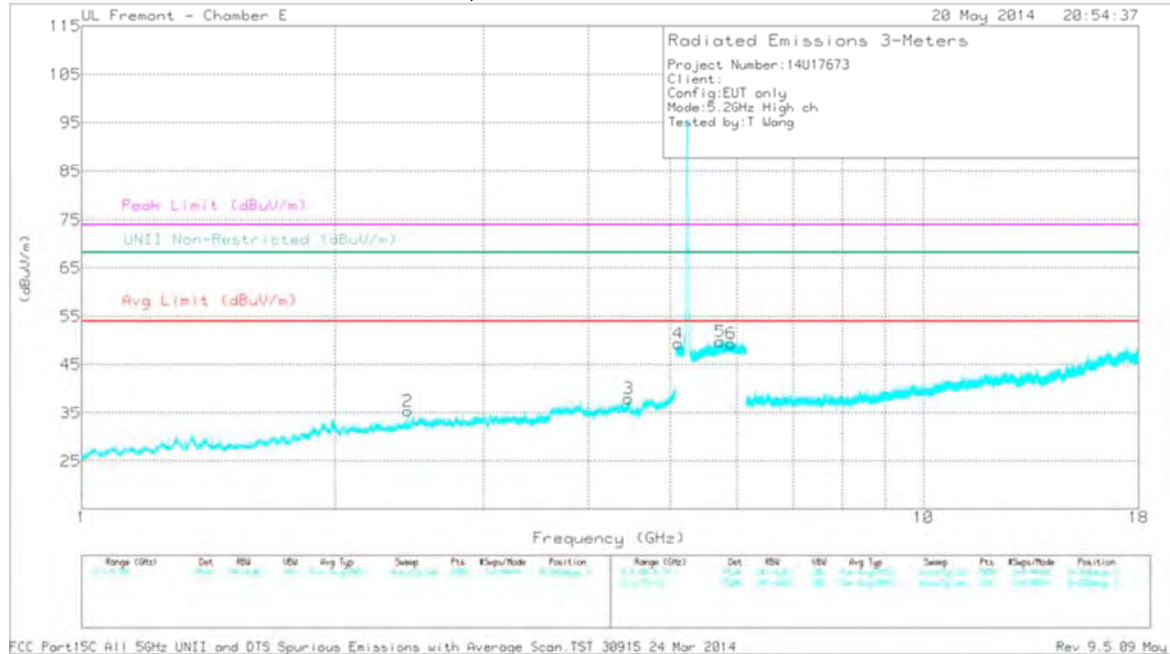

DATA

Frequency (GHz)	Meter Reading (dBuV)	Det	AF T346 (dB/m)	Amp/Cb/Filtr/ Pad (dB)	Corrected Reading (dBuV/m)	Avg Limit (dBuV/m)	Margin (dB)	Peak Limit (dBuV/m)	PK Margin (dB)	UNII Non-Restricted (dBuV/m)	PK Margin (dB)	Azimuth (Degs)	Height (cm)	Polarity
* 5.107	44.41	PK1	34.2	-21.6	57.01	-	-	74	-16.99	-	-	4	297	V
* 5.104	32.94	AD1	34.2	-21.6	45.54	54	-8.46	-	-	-	-	4	297	V
2.435	42.93	PK1	32.1	-33.1	41.93	-	-	-	-	68.2	-26.27	0	210	H
2.437	30.78	AD1	32.1	-33.1	29.78	-	-	-	-	-	-	0	210	H
2.44	42.3	PK1	32.2	-33	41.5	-	-	-	-	68.2	-26.7	21	202	V
2.441	30.57	AD1	32.2	-33	29.77	-	-	-	-	-	-	21	202	V
4.461	41.67	PK1	33.8	-30.4	45.07	-	-	-	-	68.2	-23.13	215	298	V
4.462	30.24	AD1	33.8	-30.4	33.64	-	-	-	-	-	-	215	298	V
5.73	42.83	PK1	34.8	-20.7	56.93	-	-	-	-	68.2	-11.27	197	116	V
5.737	31.68	AD1	34.9	-20.8	45.78	-	-	-	-	-	-	197	116	V
5.903	42.74	PK1	35.1	-20.3	57.54	-	-	-	-	68.2	-10.66	323	186	V
5.913	31.4	AD1	35.1	-20.4	46.1	-	-	-	-	-	-	323	186	V

* - indicates frequency in CFR15.205/IC7.2.2 Restricted Band

PK1 - KDB789033 Method: Peak

AD1 - KDB789033 Method: AD Primary Power Average

10.2.2. TX ABOVE 1 GHz 802.11n HT20 MODE IN THE 5.2 GHz BAND

RESTRICTED BANDEDGE (LOW CHANNEL)

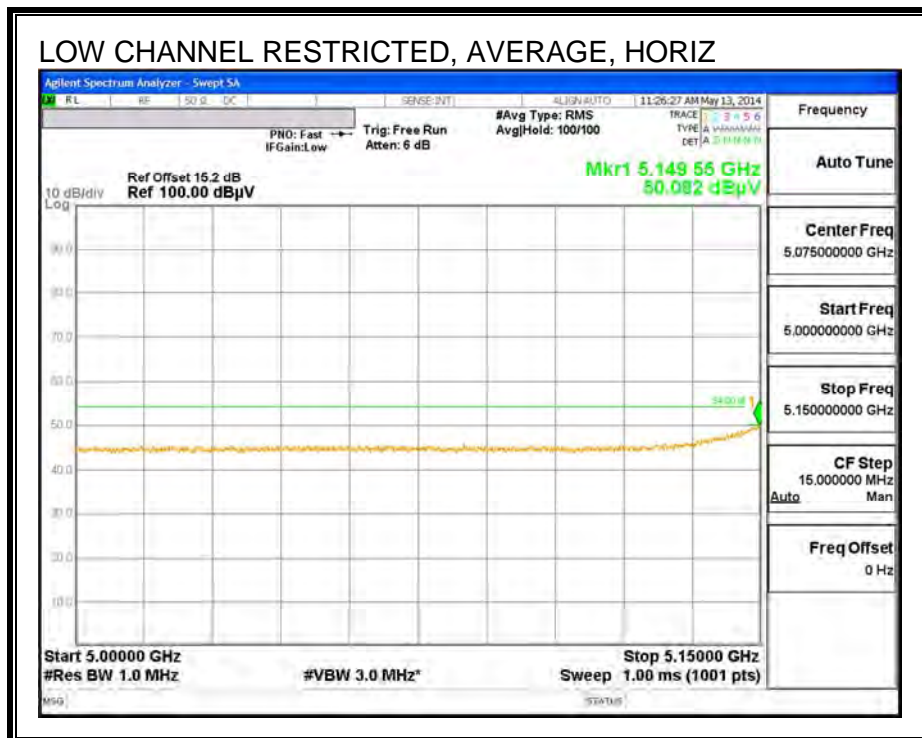
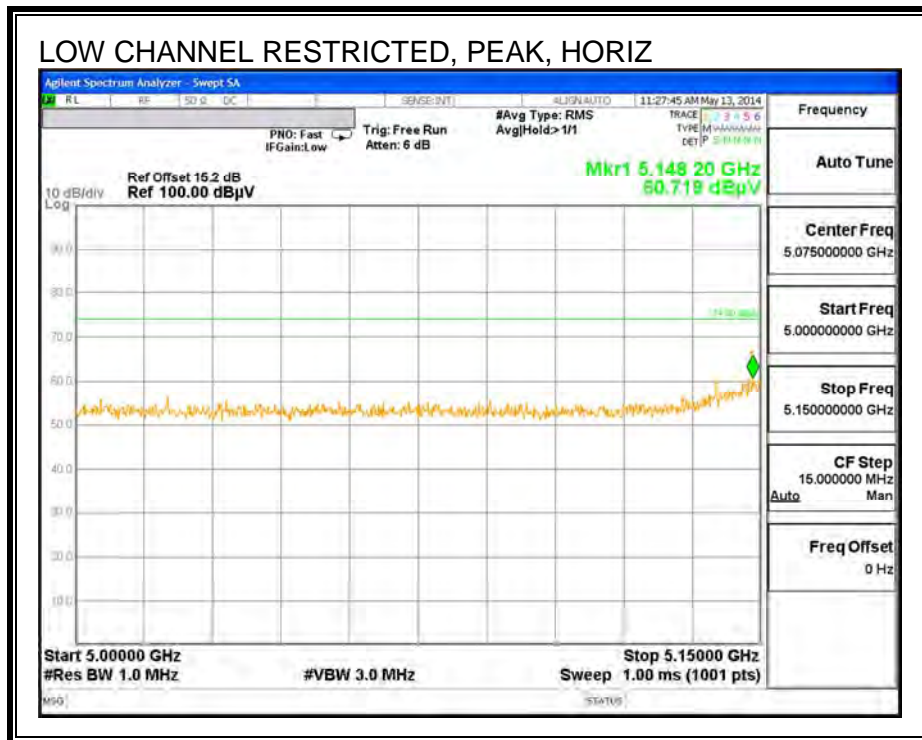

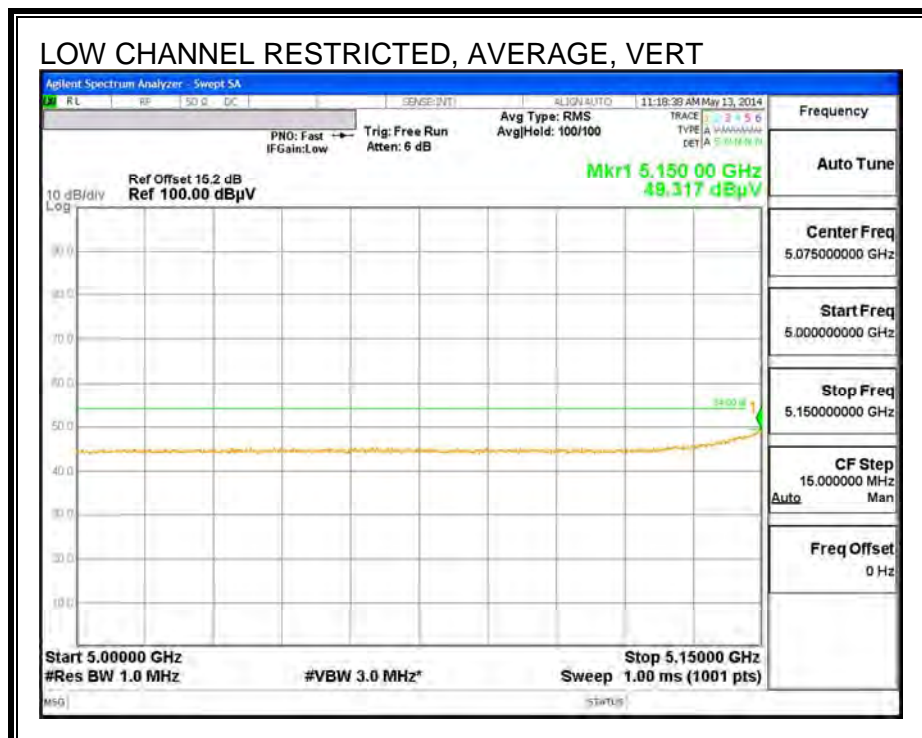
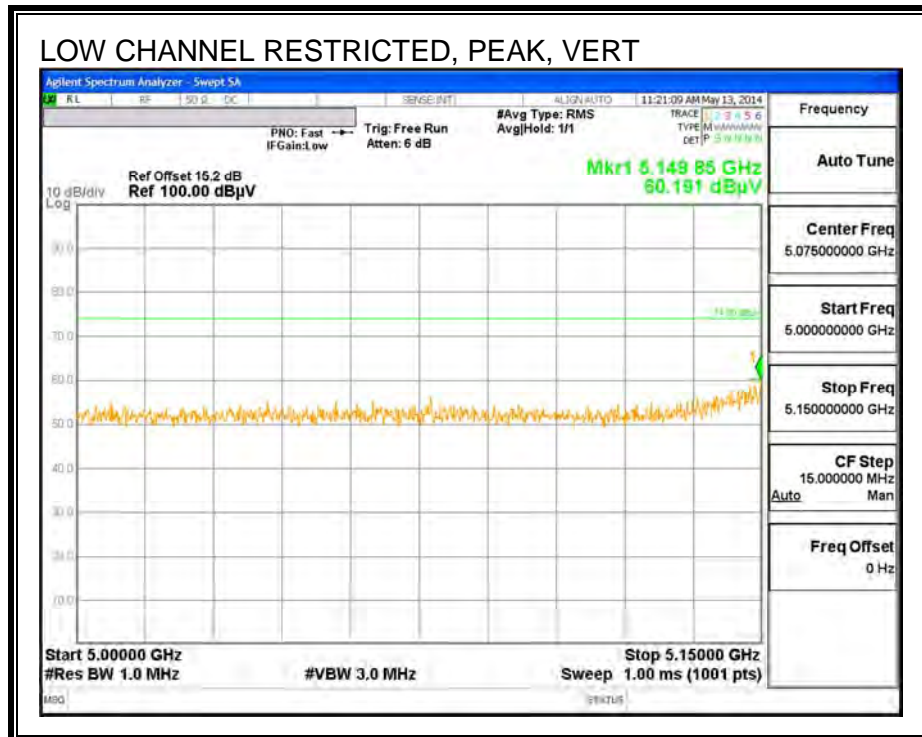

HARMONICS AND SPURIOUS EMISSIONS

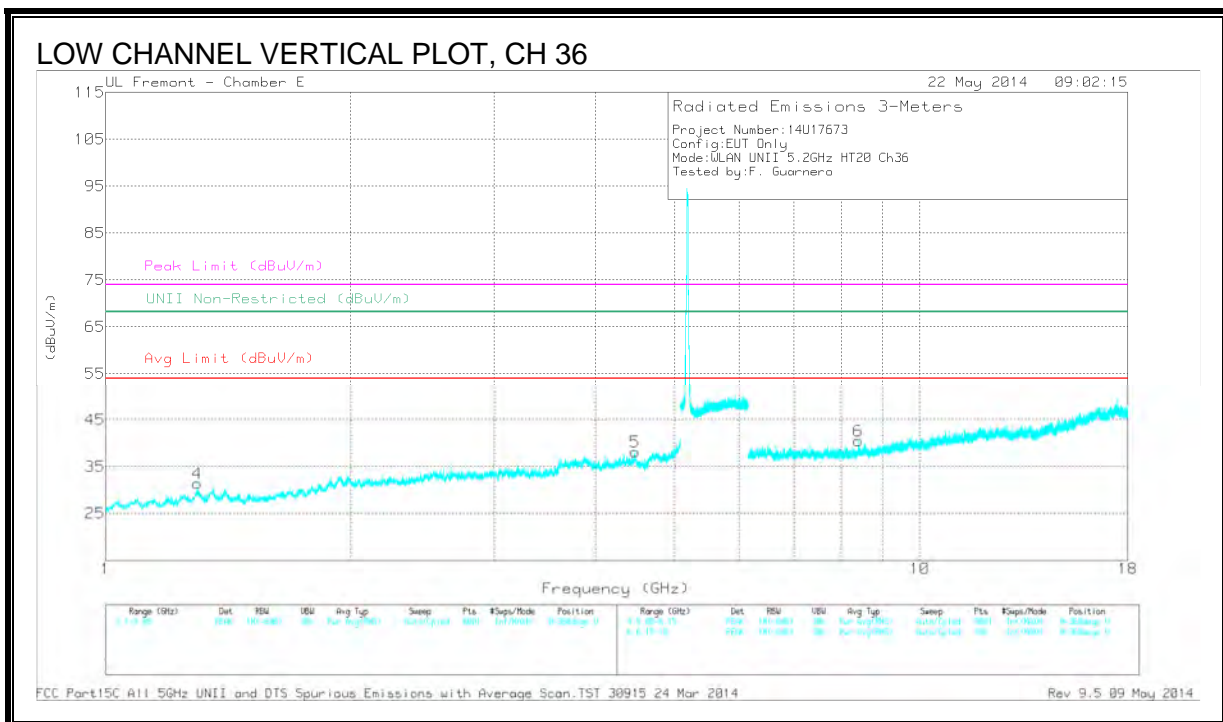
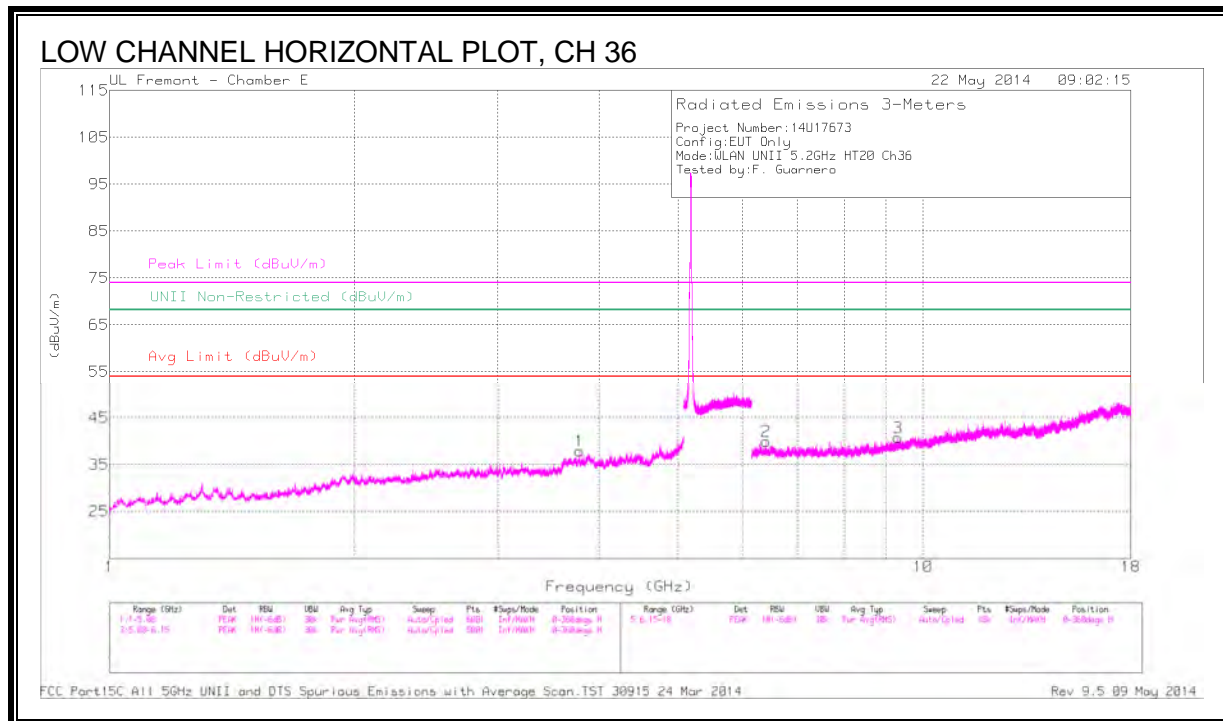

DATA

Frequency (GHz)	Meter Reading (dBuV)	Det	AF T346 (dB/m)	Amp/Cb/Filtr /Pad (dB)	Corrected Reading (dBuV/m)	Avg Limit (dBuV/m)	Margin (dB)	Peak Limit (dBuV/m)	PK Margin (dB)	UNII Non-Restricted (dBuV/m)	PK Margin (dB)	Azimuth (Degs)	Height (cm)	Polarity
* 3.781	43.13	PK1	33.4	-32	44.53	-	-	74	-29.47	-	-	2	101	H
* 3.781	31.28	AD1	33.4	-32	32.68	54	-21.32	-	-	-	-	2	101	H
* 1.295	44.56	PK1	28.9	-34.2	39.26	-	-	74	-34.74	-	-	2	101	V
* 1.295	32.52	AD1	28.9	-34.2	27.22	54	-26.78	-	-	-	-	2	101	V
* 9.316	37.64	PK1	36.7	-25.5	48.84	-	-	74	-25.16	-	-	2	101	V
* 9.316	25.7	AD1	36.7	-25.5	36.9	54	-17.1	-	-	-	-	2	101	V
* 8.406	38.44	PK1	35.9	-26.9	47.44	-	-	74	-26.56	-	-	2	101	V
* 8.406	27.43	AD1	35.9	-26.9	36.43	54	-17.57	-	-	-	-	2	101	V
4.468	42.42	PK1	33.9	-30.3	46.02	-	-	-	-	68.2	-22.18	2	101	V
6.414	41.5	PK1	35.6	-29.1	48	-	-	-	-	68.2	-20.2	2	101	H

* - indicates frequency in CFR15.205/IC7.2.2 Restricted Band

PK1 - KDB789033 Method: Peak

AD1 - KDB789033 Method: AD Primary Power Average

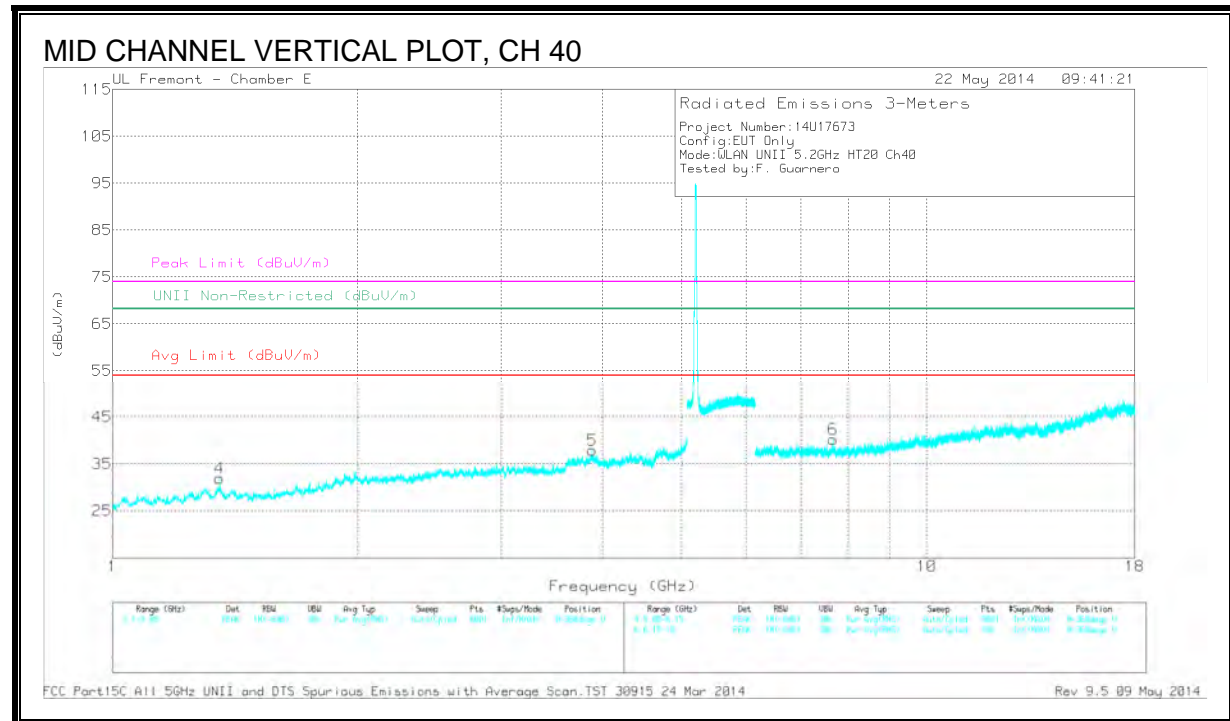
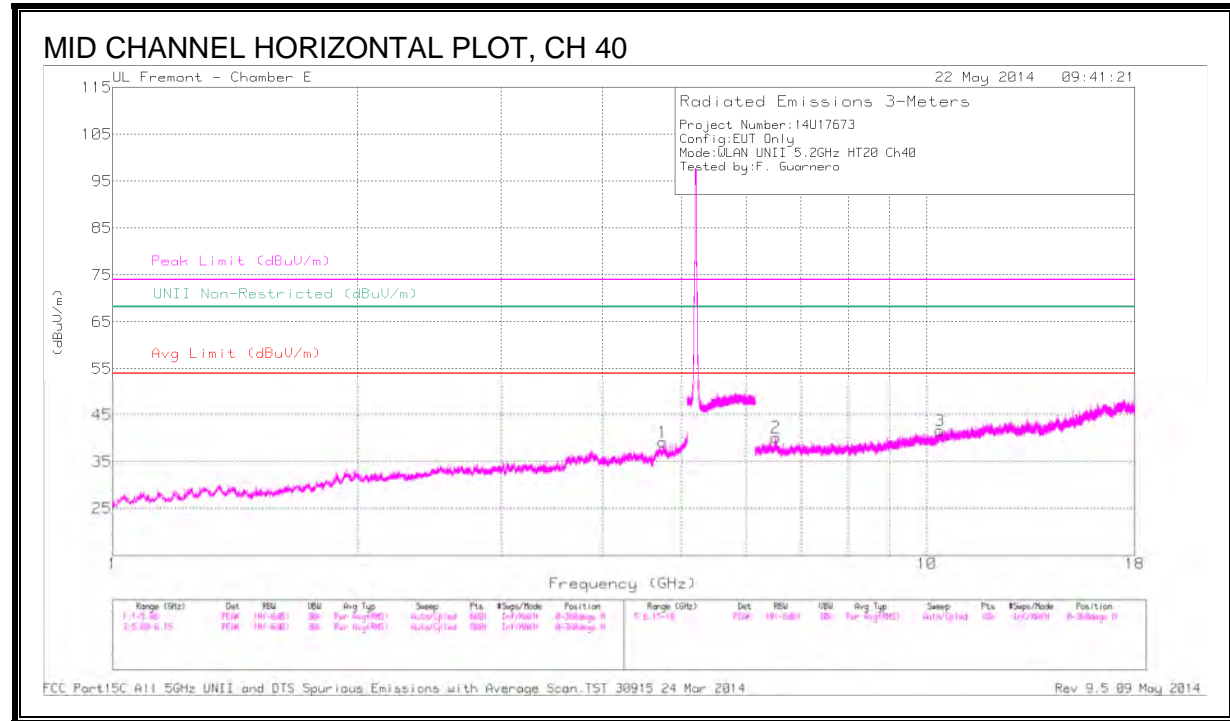

DATA

Frequency (GHz)	Meter Reading (dBuV)	Det	AF T346 (dB/m)	Amp/Cbl/Fitr /Pad (dB)	Corrected Reading (dBuV/m)	Avg Limit (dBuV/m)	Margin (dB)	Peak Limit (dBuV/m)	PK Margin (dB)	UNII Non-Restricted (dBuV/m)	PK Margin (dB)	Azimuth (Degs)	Height (cm)	Polarity
* 4.737	42.06	PK1	34.1	-30.6	45.56	-	-	74	-28.44	-	-	0	101	H
* 4.737	30.53	AD1	34.1	-30.6	34.03	54	-19.97	-	-	-	-	0	101	H
* 1.353	43.95	PK1	28.9	-33.9	38.95	-	-	74	-35.05	-	-	0	101	V
* 1.353	32.5	AD1	28.9	-33.9	27.5	54	-26.5	-	-	-	-	0	101	V
* 3.885	42.03	PK1	33.5	-30.4	45.13	-	-	74	-28.87	-	-	0	101	V
* 3.885	30.48	AD1	33.5	-30.4	33.58	54	-20.42	-	-	-	-	0	101	V
* 7.672	39.15	PK1	35.8	-27.3	47.65	-	-	74	-26.35	-	-	0	101	V
* 7.672	27.54	AD1	35.8	-27.3	36.04	54	-17.96	-	-	-	-	0	101	V
6.53	39.87	PK1	35.7	-27.7	47.87	-	-	-	-	68.2	-20.33	0	101	H
10.372	36.3	PK1	37.4	-23.7	50	-	-	-	-	68.2	-18.2	0	101	H

* - indicates frequency in CFR15.205/IC7.2.2 Restricted Band

PK1 - KDB789033 Method: Peak

AD1 - KDB789033 Method: AD Primary Power Average

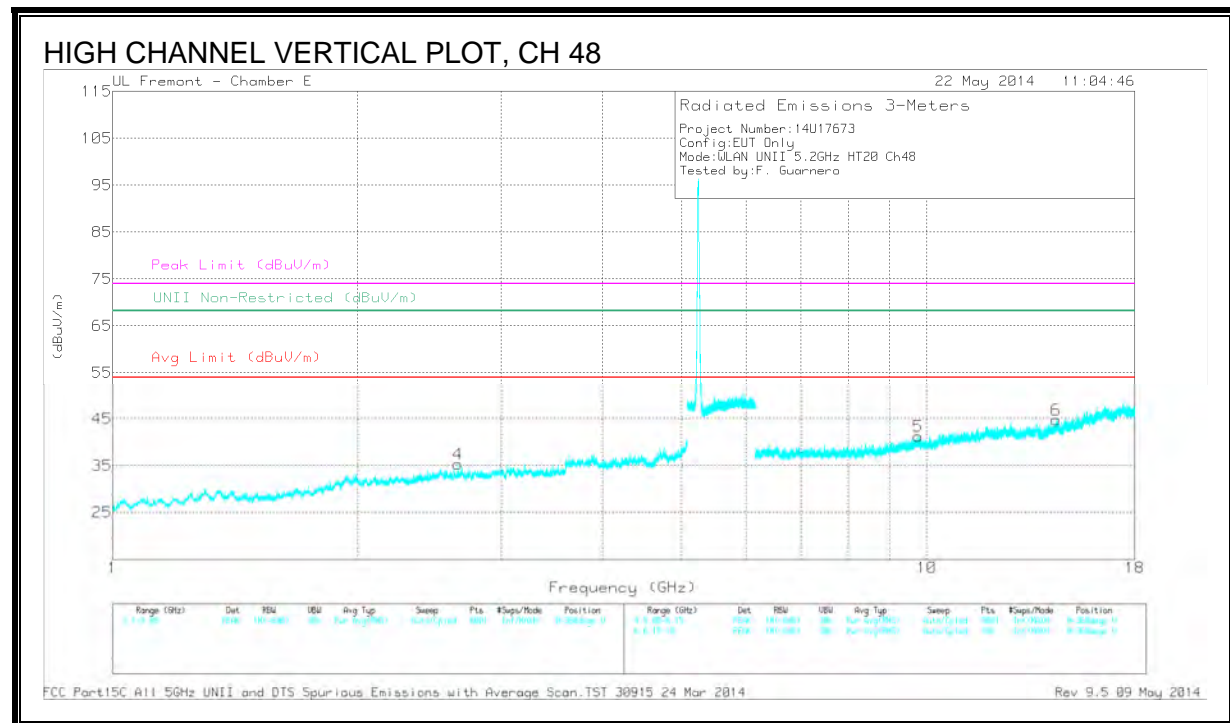
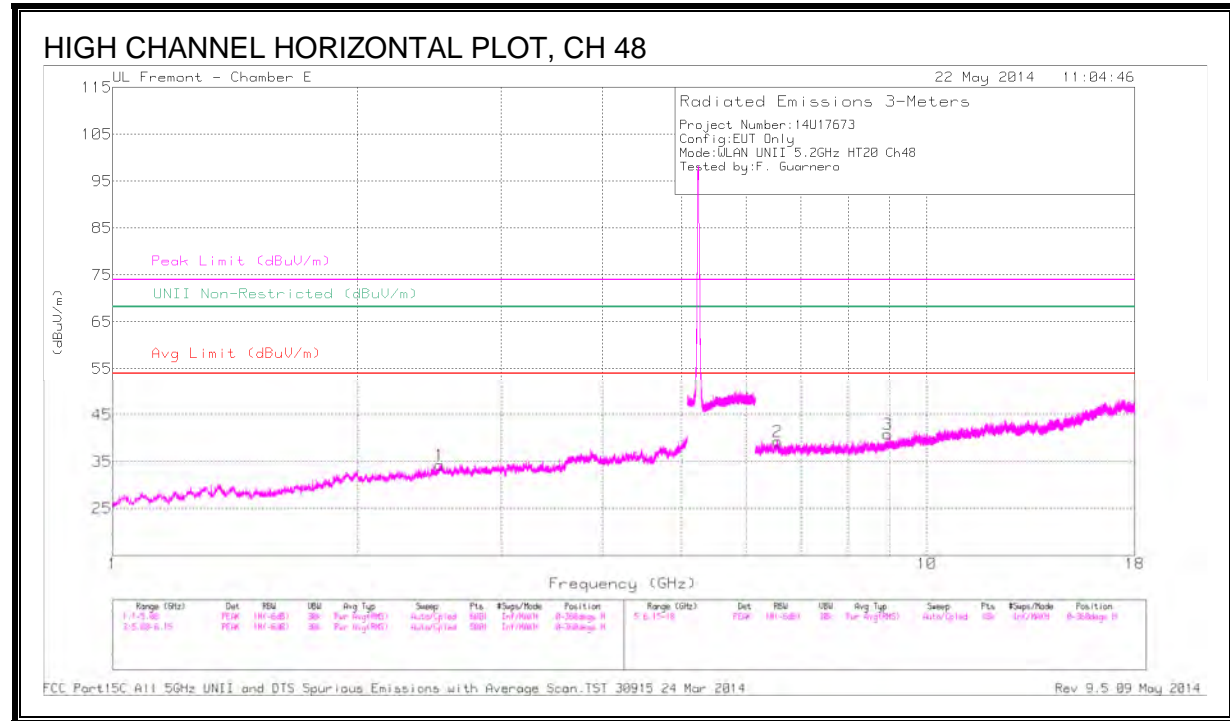

DATA

Frequency (GHz)	Meter Reading (dBuV)	Det	AF T346 (dB/m)	Amp/Cbl/Filtr/ Pad (dB)	Corrected Reading (dBuV/m)	Avg Limit (dBuV/m)	Margin (dB)	Peak Limit (dBuV/m)	PK Margin (dB)	UNII Non-Restricted (dBuV/m)	PK Margin (dB)	Azimuth (Degs)	Height (cm)	Polarity
2.519	42.48	PK1	32.4	-32	42.88	-	-	-	-	68.2	-25.32	360	100	H
2.653	42.45	PK1	32.5	-32.8	42.15	-	-	-	-	68.2	-26.05	360	100	V
6.557	39.43	PK1	35.7	-27.9	47.23	-	-	-	-	68.2	-20.97	360	100	H
8.948	38.19	PK1	36.3	-26	48.49	-	-	-	-	68.2	-19.71	360	100	H
9.764	38.11	PK1	37.1	-24.9	50.31	-	-	-	-	68.2	-17.89	360	100	V
14.412	38.29	PK1	39.2	-24.9	52.59	-	-	-	-	68.2	-15.61	360	100	V

PK1 - KDB789033 Method: Peak

10.2.3. TX ABOVE 1 GHz 802.11n HT40 MODE IN THE 5.2 GHz BAND

RESTRICTED BANDEDGE (LOW CHANNEL)

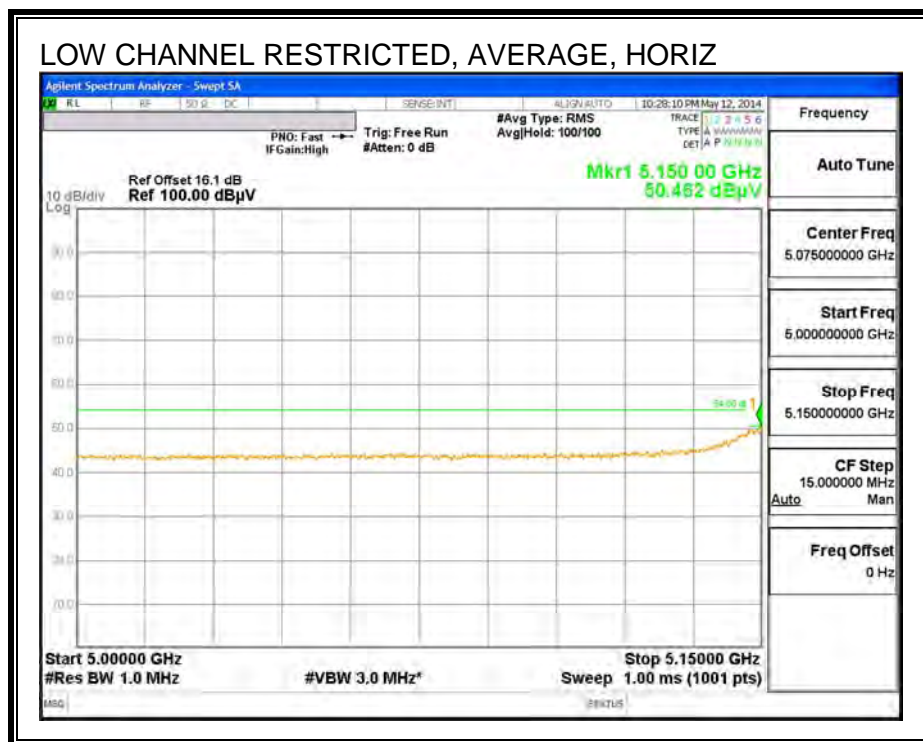
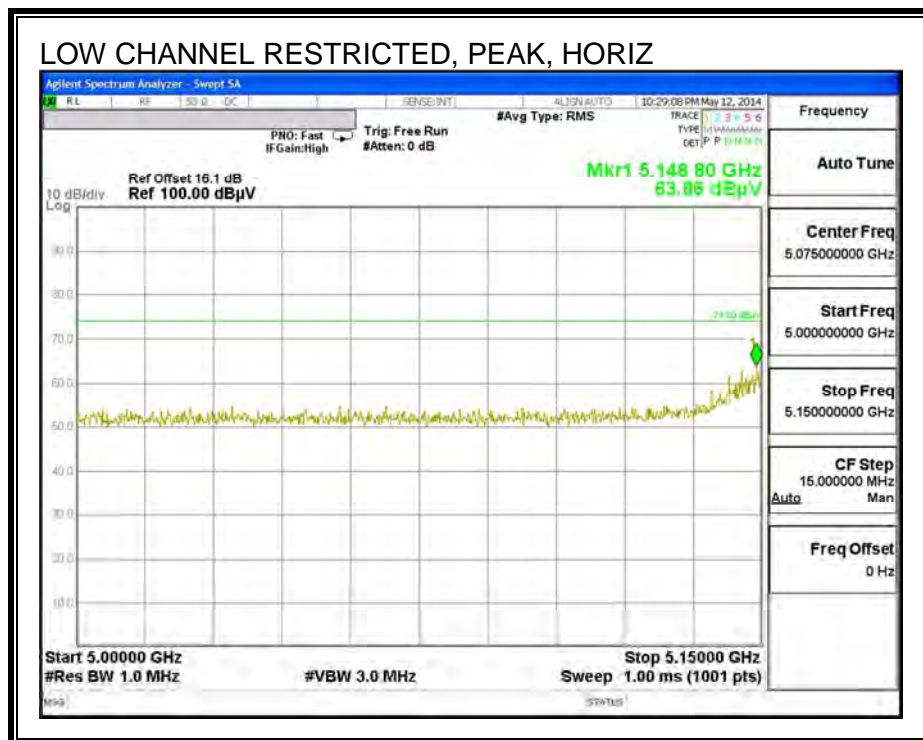

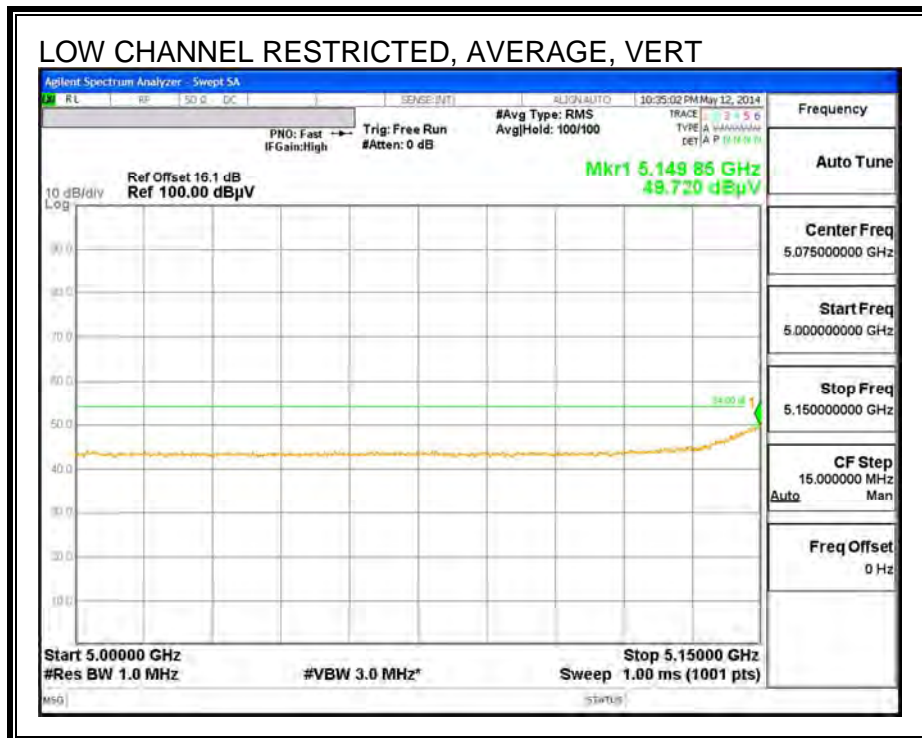
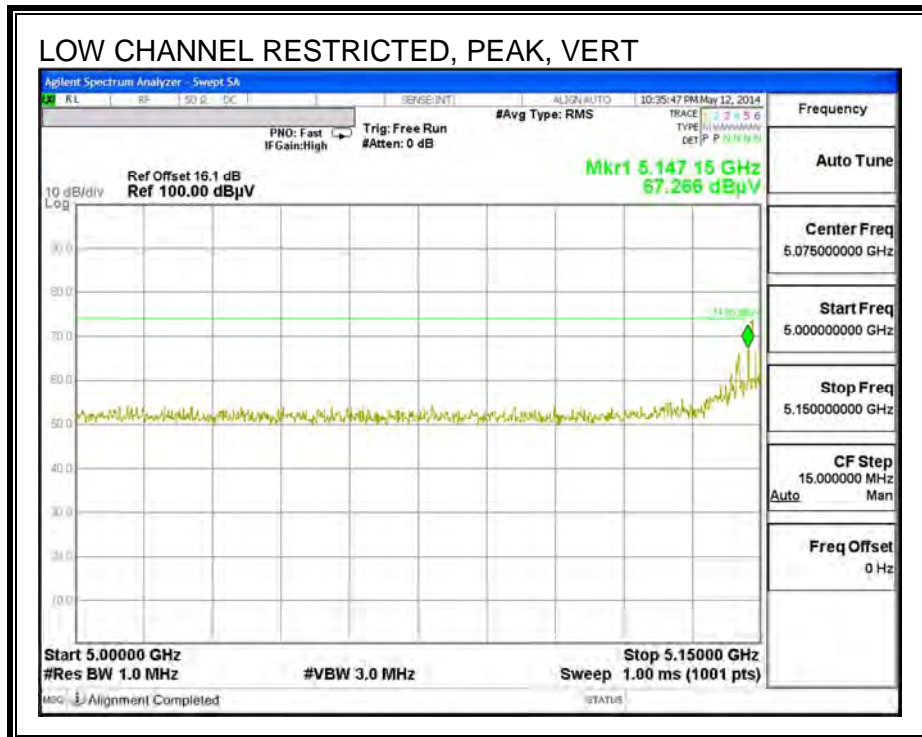

HARMONICS AND SPURIOUS EMISSIONS

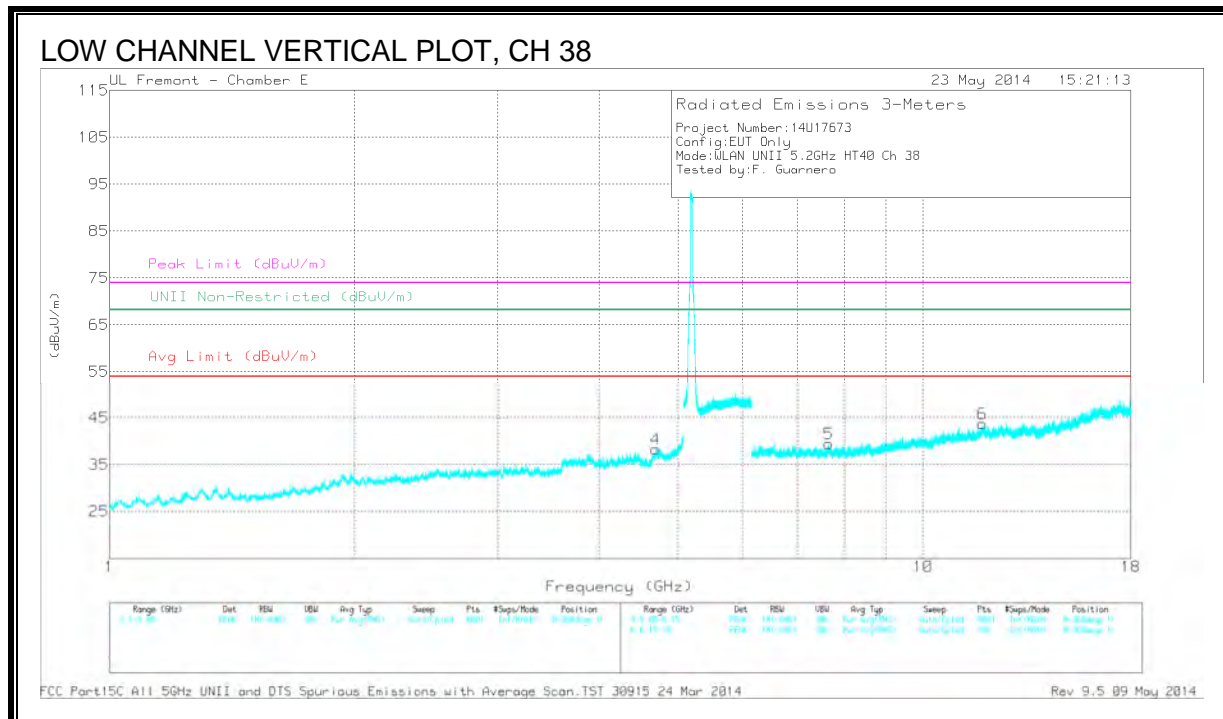
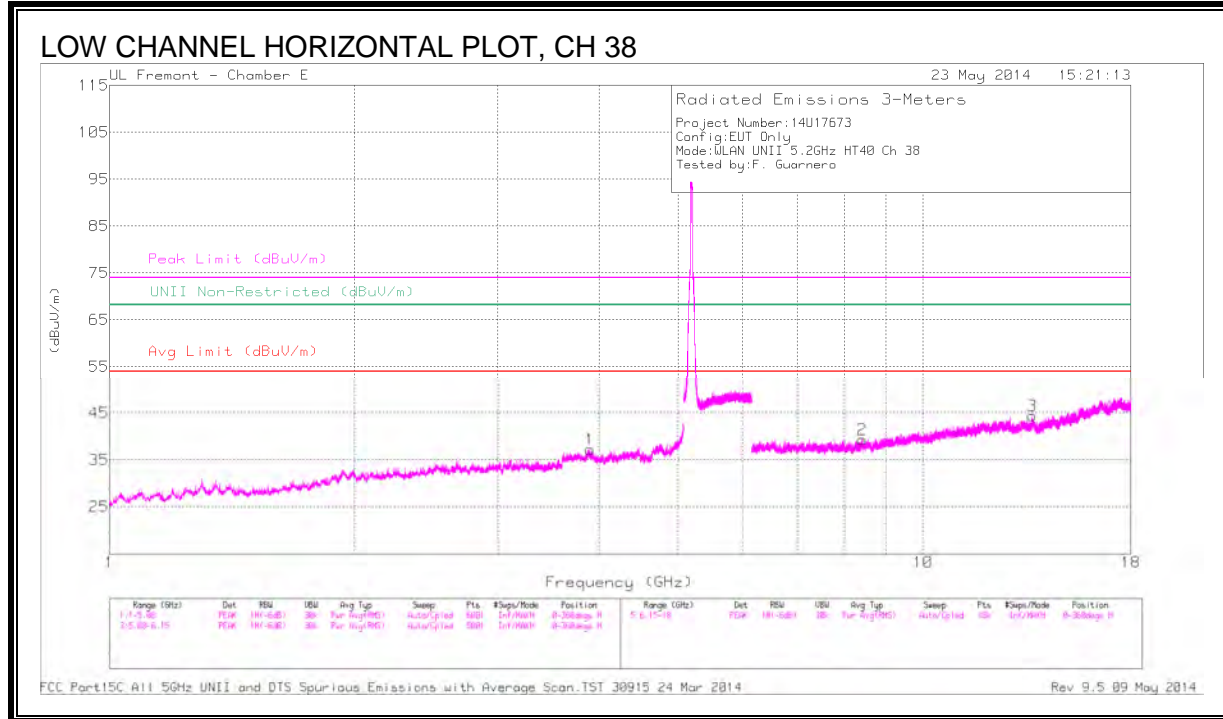

DATA

Frequency (GHz)	Meter Reading (dBuV)	Det	AF T346 (dB/m)	Amp/Cb/Filtr /Pad (dB)	Corrected Reading (dBuV/m)	Avg Limit (dBuV/m)	Margin (dB)	Peak Limit (dBuV/m)	PK Margin (dB)	UNII Non-Restricted (dBuV/m)	PK Margin (dB)	Azimuth (Degs)	Height (cm)	Polarity
* 3.894	41.81	PK1	33.5	-30.4	44.91	-	-	74	-29.09	-	-	0	101	H
* 3.894	30.47	AD1	33.5	-30.4	33.57	54	-20.43	-	-	-	-	0	101	H
* 8.41	39.02	PK1	35.9	-26.9	48.02	-	-	74	-25.98	-	-	0	101	H
* 8.41	27.49	AD1	35.9	-26.9	36.49	54	-17.51	-	-	-	-	0	101	H
* 7.655	39.44	PK1	35.8	-27.3	47.94	-	-	74	-26.06	-	-	0	101	V
* 7.655	27.62	AD1	35.8	-27.3	36.12	54	-17.88	-	-	-	-	0	101	V
* 11.825	35.94	PK1	38.5	-23.2	51.24	-	-	74	-22.76	-	-	0	101	V
* 11.825	25.06	AD1	38.5	-23.2	40.36	54	-13.64	-	-	-	-	0	101	V
4.468	41.65	PK1	33.9	-30.3	45.25	-	-	-	-	68.2	-22.95	0	101	V
4.468	30.38	AD1	33.9	-30.3	33.98	-	-	-	-	-	-	0	101	V
13.617	38.54	PK1	38.9	-24.6	52.84	-	-	-	-	68.2	-15.36	0	101	H

* - indicates frequency in CFR15.205/IC7.2.2 Restricted Band

PK1 - KDB789033 Method: Peak

AD1 - KDB789033 Method: AD Primary Power Average

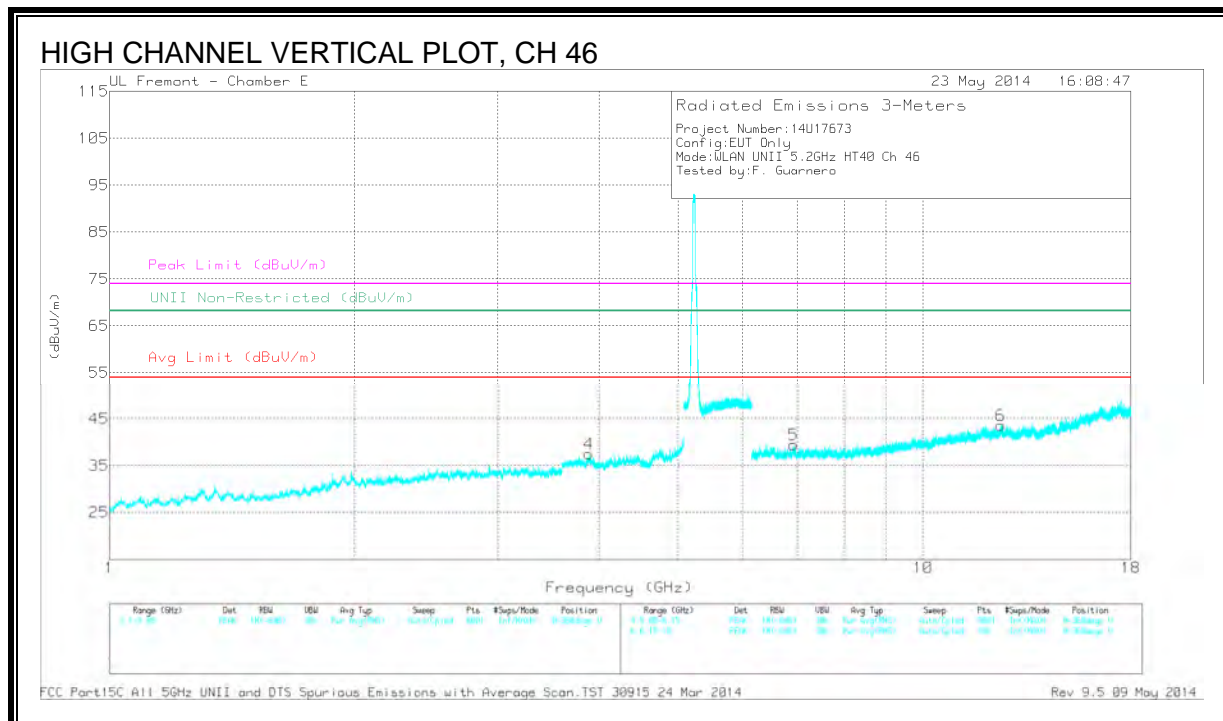
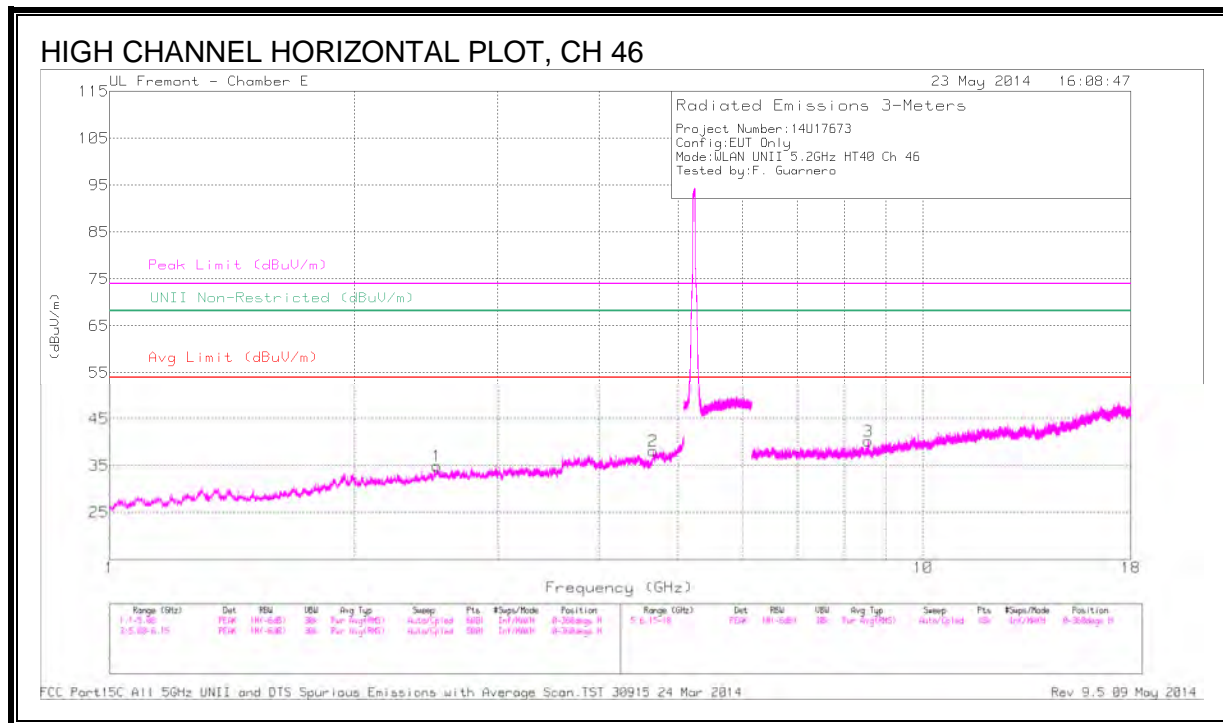

DATA

Frequency (GHz)	Meter Reading (dBuV)	Det	AF T346 (dB/m)	Amp/Cb/Fitr /Pad (dB)	Corrected Reading (dBuV/m)	Avg Limit (dBuV/m)	Margin (dB)	Peak Limit (dBuV/m)	PK Margin (dB)	UNII Non-Restricted (dBuV/m)	PK Margin (dB)	Azimuth (Degs)	Height (cm)	Polarity
* 4.655	42.02	PK1	34.1	-29.7	46.42	-	-	74	-27.58	-	-	0	101	H
* 4.655	30.51	AD1	34.1	-29.7	34.91	54	-19.09	-	-	-	-	0	101	H
* 3.882	41.89	PK1	33.5	-30.5	44.89	-	-	74	-29.11	-	-	0	101	V
* 3.882	30.6	AD1	33.5	-30.5	33.6	54	-20.4	-	-	-	-	0	101	V
* 12.452	37.14	PK1	38.9	-23.6	52.44	-	-	74	-21.56	-	-	0	101	V
* 12.452	25.26	AD1	38.9	-23.6	40.56	54	-13.44	-	-	-	-	0	101	V
2.526	42.13	PK1	32.4	-32	42.53	-	-	-	-	68.2	-25.67	0	101	H
6.924	40	PK1	35.9	-28.4	47.5	-	-	-	-	68.2	-20.7	0	101	V
8.563	38.15	PK1	35.9	-26.3	47.75	-	-	-	-	68.2	-20.45	0	101	H

* - indicates frequency in CFR15.205/IC7.2.2 Restricted Band

PK1 - KDB789033 Method: Peak

AD1 - KDB789033 Method: AD Primary Power Average

10.2.4. TX ABOVE 1G 802.11ac 80MHz MODE IN THE 5.2 GHz BAND

RESTRICTED BANDEDGE (LOW CHANNEL, CH 42)

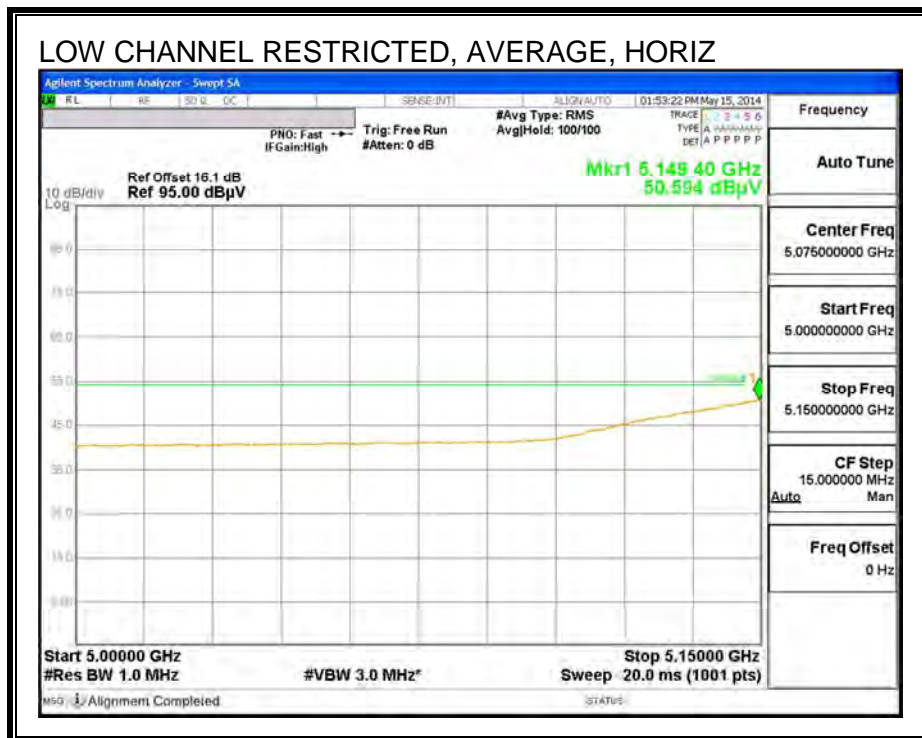
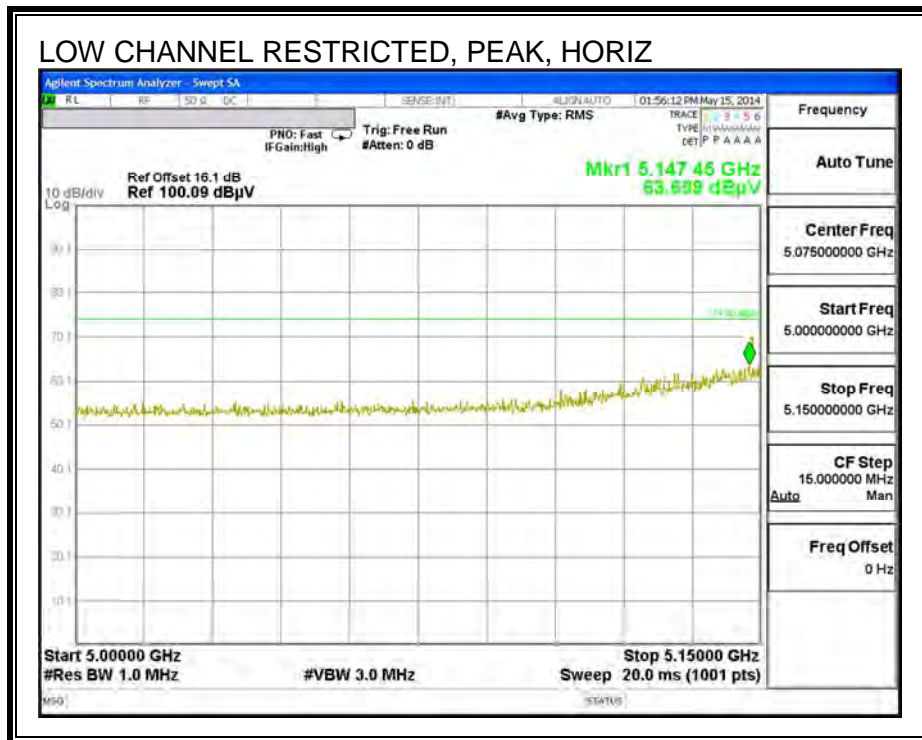

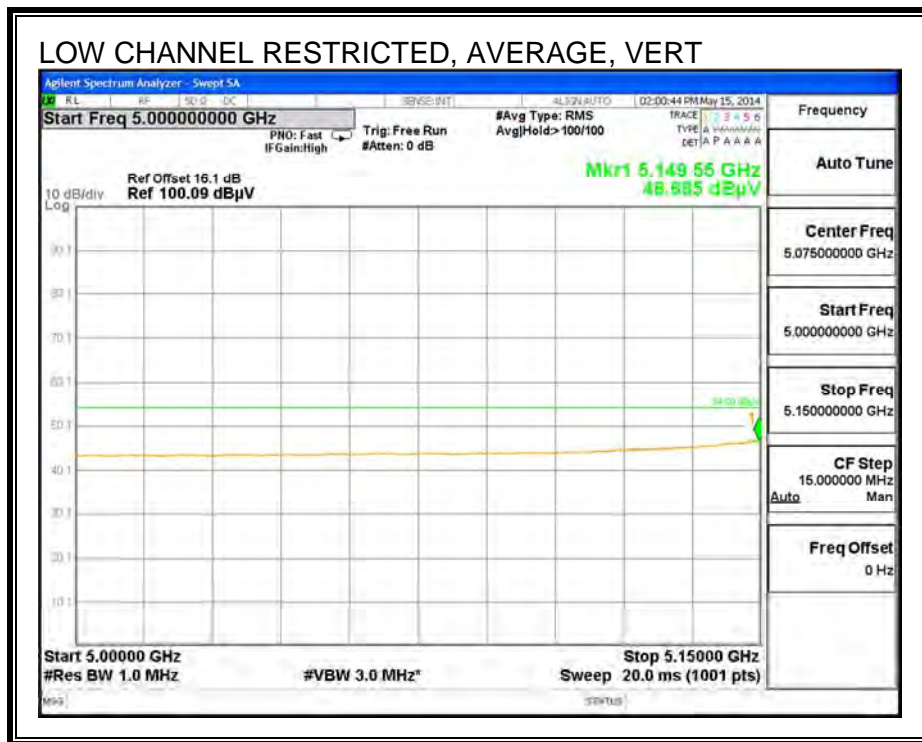
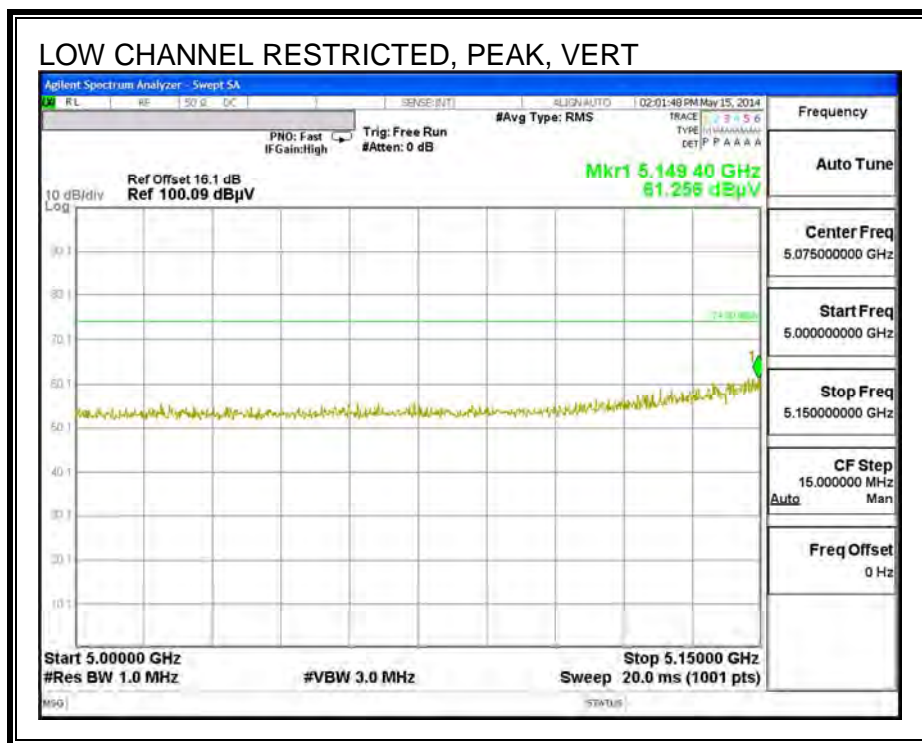

HARMONICS AND SPURIOUS EMISSIONS

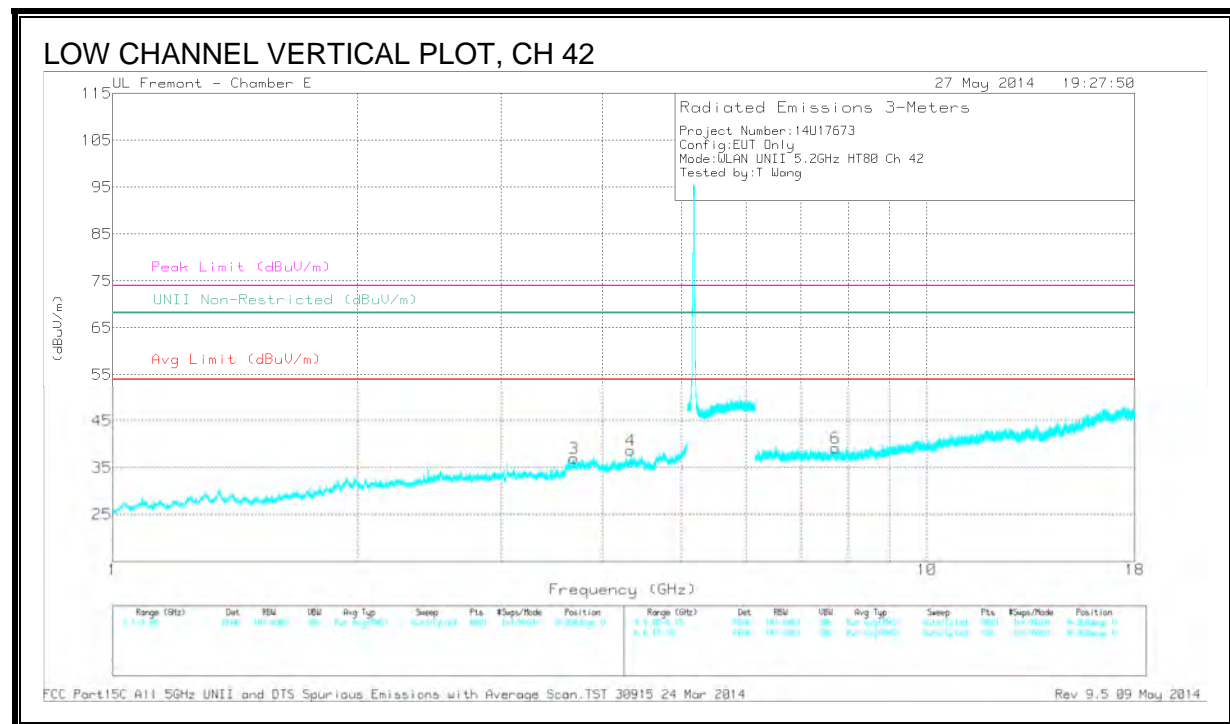
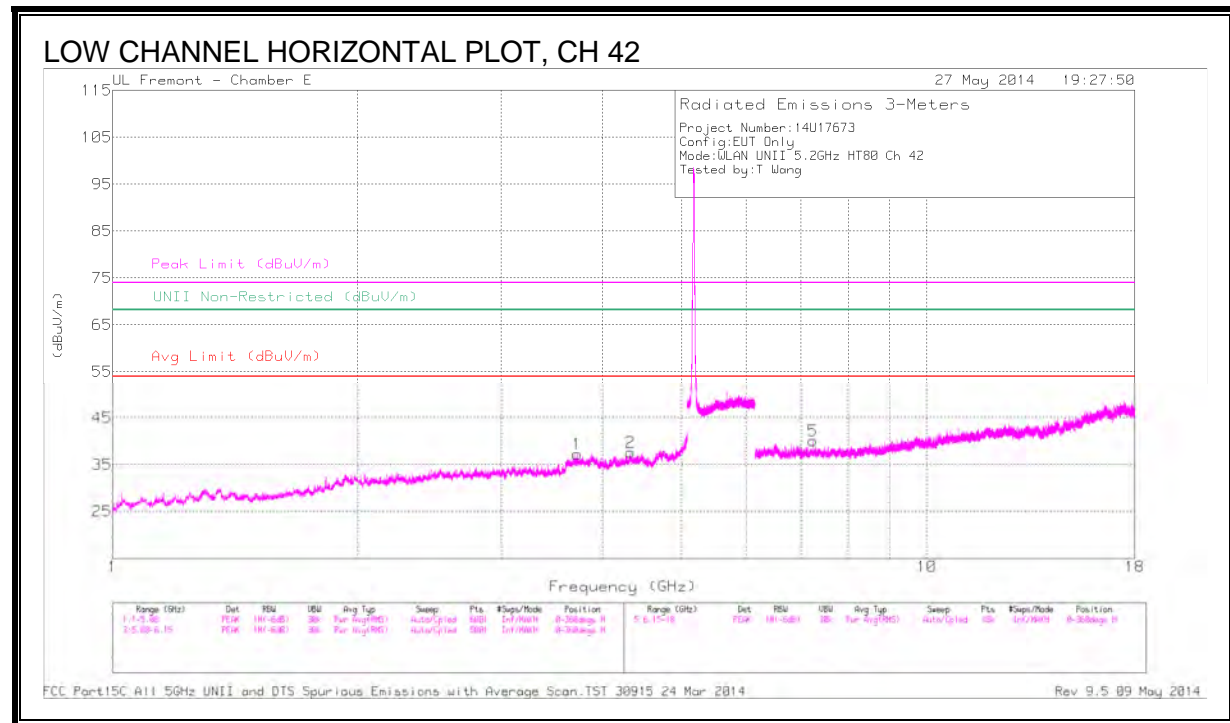

DATA

Marker	Frequency (GHz)	Meter Reading (dBuV)	Det	AF T346 (dB/m)	Amp/Cbl/Filtr/Pad (dB)	DC Corr (dB)	Corrected Reading (dBuV/m)	Avg Limit (dBuV/m)	Margin (dB)	Peak Limit (dBuV/m)	PK Margin (dB)	UNII Non-Restricted (dBuV/m)	PK Margin (dB)	Azimuth (Degs)	Height (cm)	Polariz
1	* 3.73	42.84	PK1	33.4	-31.8	0	44.44	-	-	74	-29.56	-	-	248	139	H
	* 3.727	31.24	AD1	33.4	-31.8	.2	33.04	54	-20.96	-	-	-	-	248	139	H
2	* 4.332	41.91	PK1	33.6	-30.7	0	44.81	-	-	74	-29.19	-	-	38	160	H
	* 4.331	30.45	AD1	33.6	-30.7	.2	33.55	54	-20.45	-	-	-	-	38	160	H
3	* 3.679	41.66	PK1	33.3	-31.2	0	43.76	-	-	74	-30.24	-	-	221	269	V
	* 3.686	30.71	AD1	33.3	-31.3	.2	32.91	54	-21.09	-	-	-	-	221	269	V
4	* 4.328	41.71	PK1	33.6	-30.5	0	44.81	-	-	74	-29.19	-	-	278	285	V
	* 4.33	30.49	AD1	33.6	-30.6	.2	33.69	54	-20.31	-	-	-	-	278	285	V
6	* 7.722	38.66	PK1	35.9	-27.8	0	46.76	-	-	74	-27.24	-	-	351	133	V
	* 7.717	27.19	AD1	35.9	-27.7	.2	35.59	54	-18.41	-	-	-	-	351	133	V
5	7.24	27.95	AD1	35.7	-28.4	.2	35.45	-	-	-	-	-	-	320	371	H
	7.241	39.41	PK1	35.7	-28.4	0	46.71	-	-	-	-	68.2	-21.49	320	371	H

* - indicates frequency in CFR15.205/IC7.2.2 Restricted Band

PK1 - KDB789033 Method: Peak

AD1 - KDB789033 Method: AD Primary Power Average

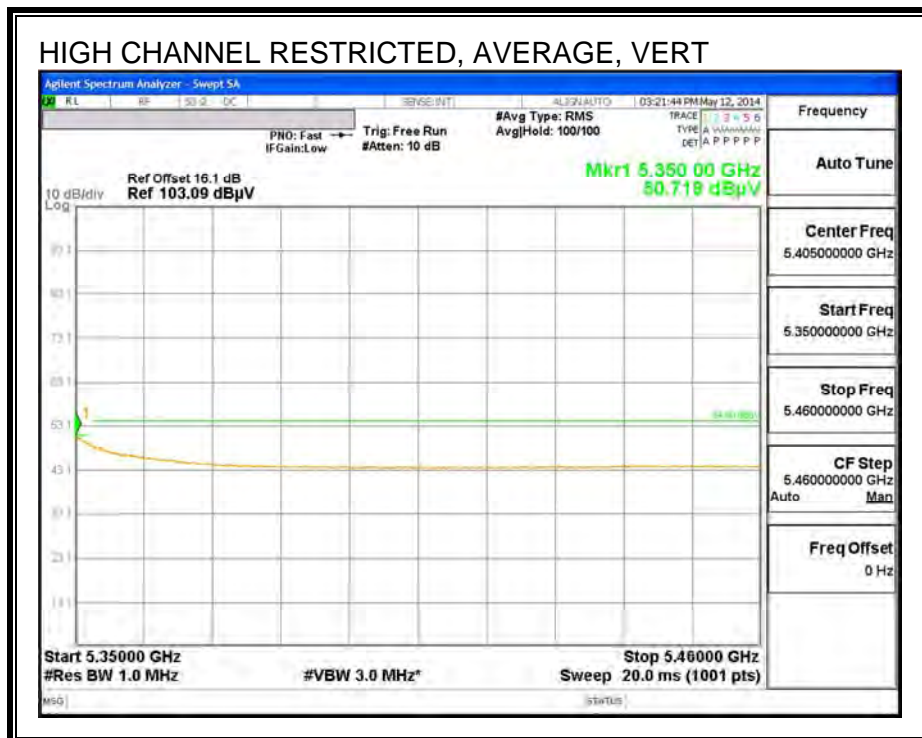
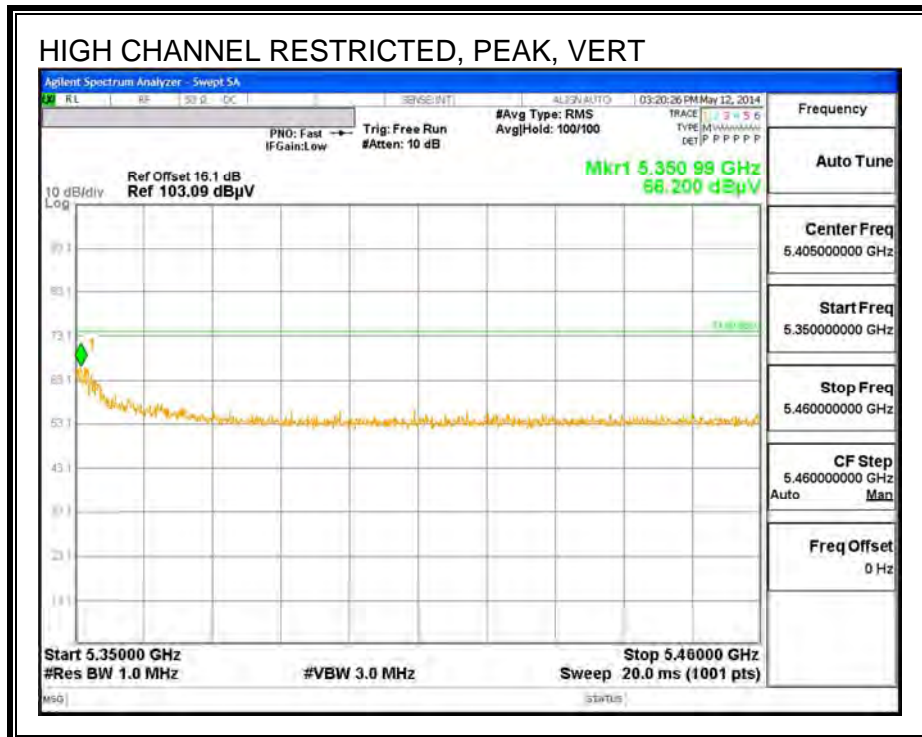

HARMONICS AND SPURIOUS EMISSIONS

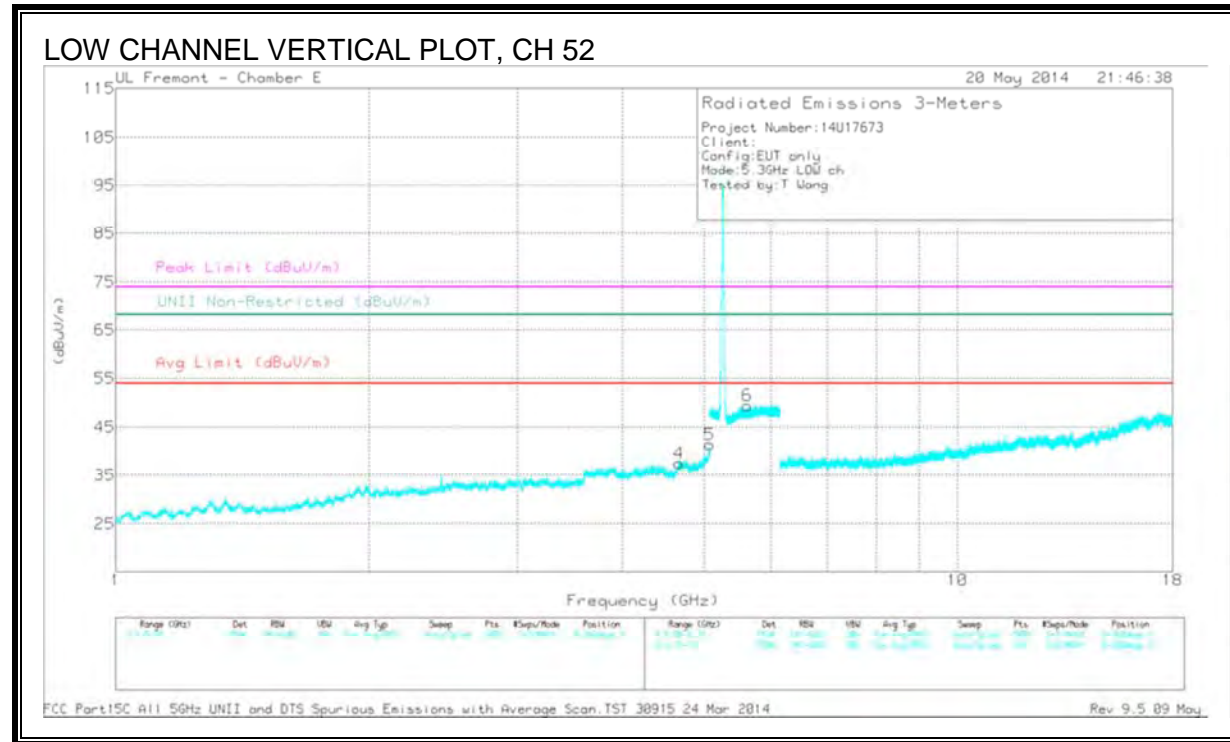
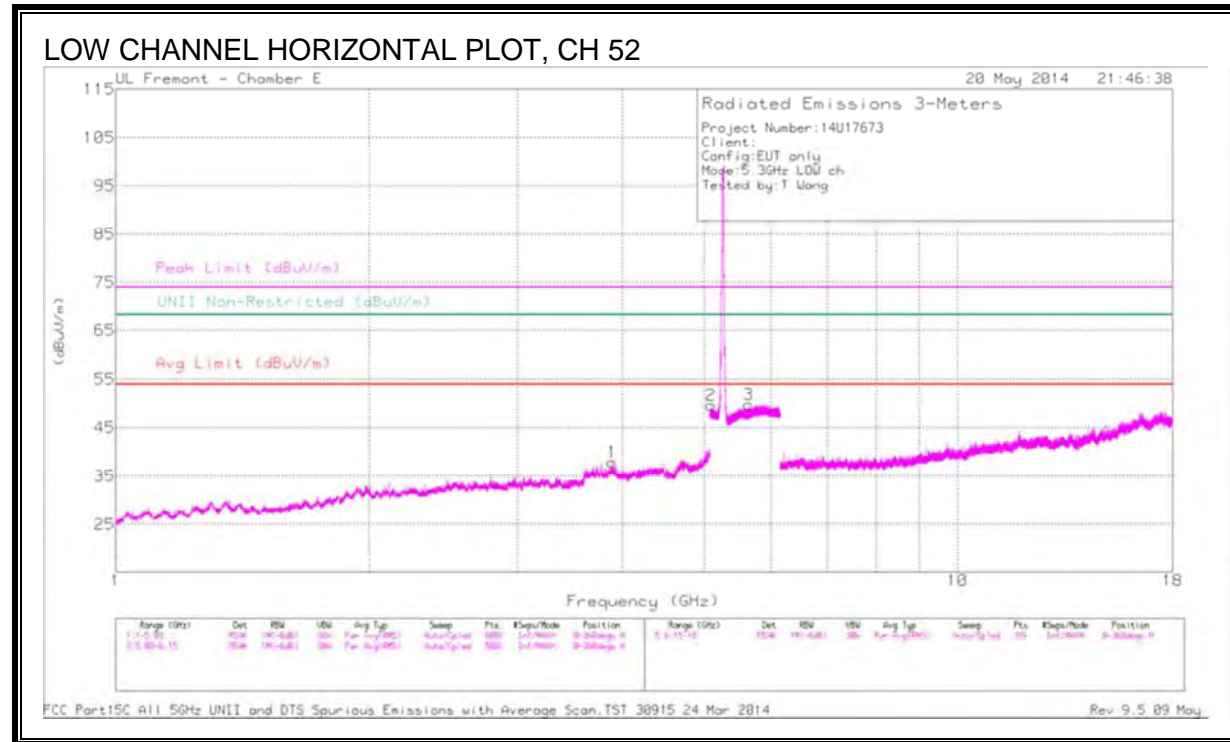

DATA

Frequency (GHz)	Meter Reading (dBuV)	Det	AF T346 (dB/m)	Amp/Cbl/F ltr/Pad (dB)	Corrected Reading (dBuV/m)	Avg Limit (dBuV/m)	Margin (dB)	Peak Limit (dBuV/m)	PK Margin (dB)	UNII Non-Restricted (dBuV/m)	PK Margin (dB)	Azimuth (Degs)	Height (cm)	Polarity
* 3.886	41.36	PK1	33.5	-30.4	44.46	-	-	74	-29.54	-	-	283	123	H
* 3.884	30.39	AD1	33.5	-30.4	33.49	54	-20.51	-	-	-	-	283	123	H
* 4.658	41.31	PK1	34.1	-29.7	45.71	-	-	74	-28.29	-	-	177	298	V
* 4.66	30.19	AD1	34.1	-29.7	34.59	54	-19.41	-	-	-	-	177	298	V
* 5.072	41.92	PK1	34.1	-27.8	48.22	-	-	74	-25.78	-	-	349	335	V
* 5.073	31.02	AD1	34.1	-27.7	37.42	54	-16.58	-	-	-	-	349	335	V
* 5.088	44.63	PK1	34.1	-21.6	57.13	-	-	74	-16.87	-	-	82	209	H
* 5.101	32.85	AD1	34.2	-21.6	45.45	54	-8.55	-	-	-	-	82	209	H
5.633	42.93	PK1	34.6	-21	56.53	-	-	-	-	68.2	-11.67	79	171	V
5.636	31.89	AD1	34.6	-21	45.49	-	-	-	-	-	-	79	171	V
5.642	43.33	PK1	34.6	-20.9	57.03	-	-	-	-	68.2	-11.17	200	167	H
5.652	31.81	AD1	34.7	-21	45.51	-	-	-	-	-	-	200	167	H

* - indicates frequency in CFR15.205/IC7.2.2 Restricted Band

PK1 - KDB789033 Method: Peak

AD1 - KDB789033 Method: AD Primary Power Average

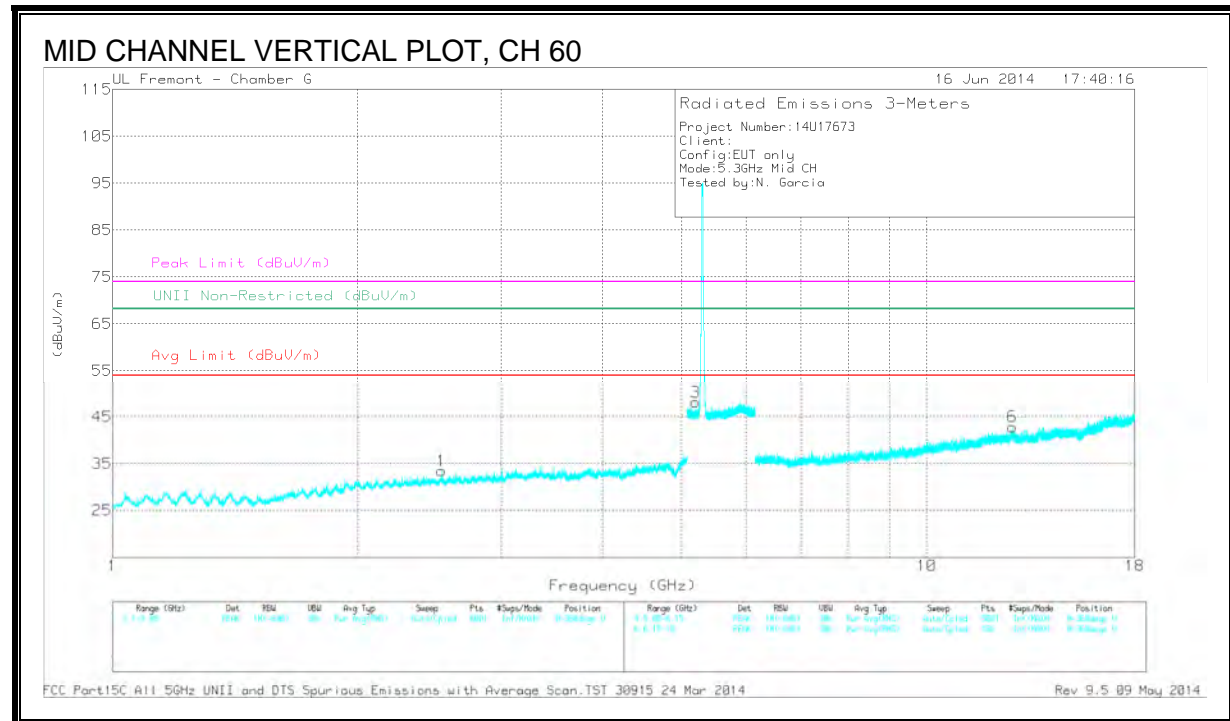
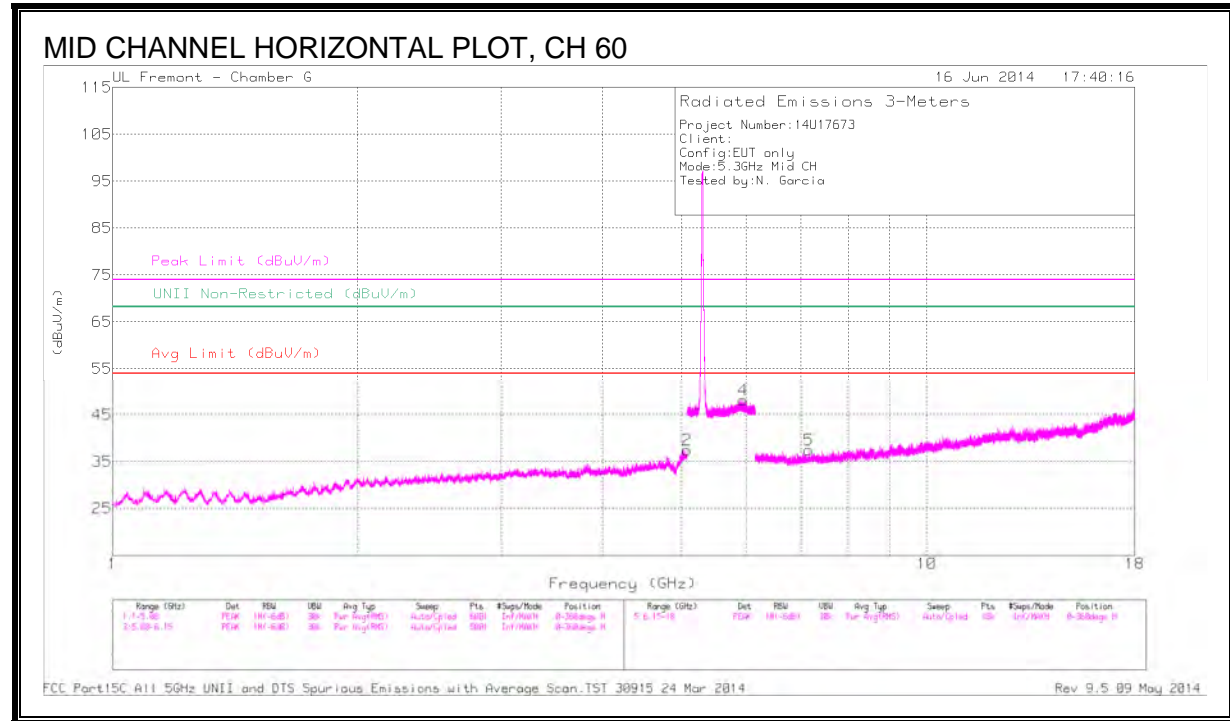

DATA

Frequency (GHz)	Meter Reading (dBuV)	Det	AF T862 (dB/m)	Amp/Cbl/FI tr/Pad (dB)	Corrected Reading (dBuV/m)	Avg Limit (dBuV/m)	Margin (dB)	Peak Limit (dBuV/m)	PK Margin (dB)	UNII Non-Restricted (dBuV/m)	PK Margin (dB)	Azimuth (Degs)	Height (cm)	Polarity
* 5.073	41.95	PK1	34.2	-30.4	45.75	-	-	74	-28.25	-	-	56	120	H
* 5.073	30.38	AD1	34.2	-30.5	34.08	54	-19.92	-	-	-	-	56	120	H
2.535	43.54	PK1	32	-34.4	41.14	-	-	-	-	68.2	-27.06	114	302	V
5.195	44.7	PK1	34.4	-23.6	55.5	-	-	-	-	68.2	-12.7	229	300	V
5.941	44.1	PK1	35.1	-23.6	55.6	-	-	-	-	68.2	-12.6	199	125	H
7.163	41.36	PK1	35.6	-31.7	45.26	-	-	-	-	68.2	-22.94	327	115	H
12.742	36.56	PK1	39.1	-25.4	50.26	-	-	-	-	68.2	-17.94	56	179	V

* - indicates frequency in CFR15.205/IC7.2.2 Restricted Band

PK1 - KDB789033 Method: Peak

AD1 - KDB789033 Method: AD Primary Power Average

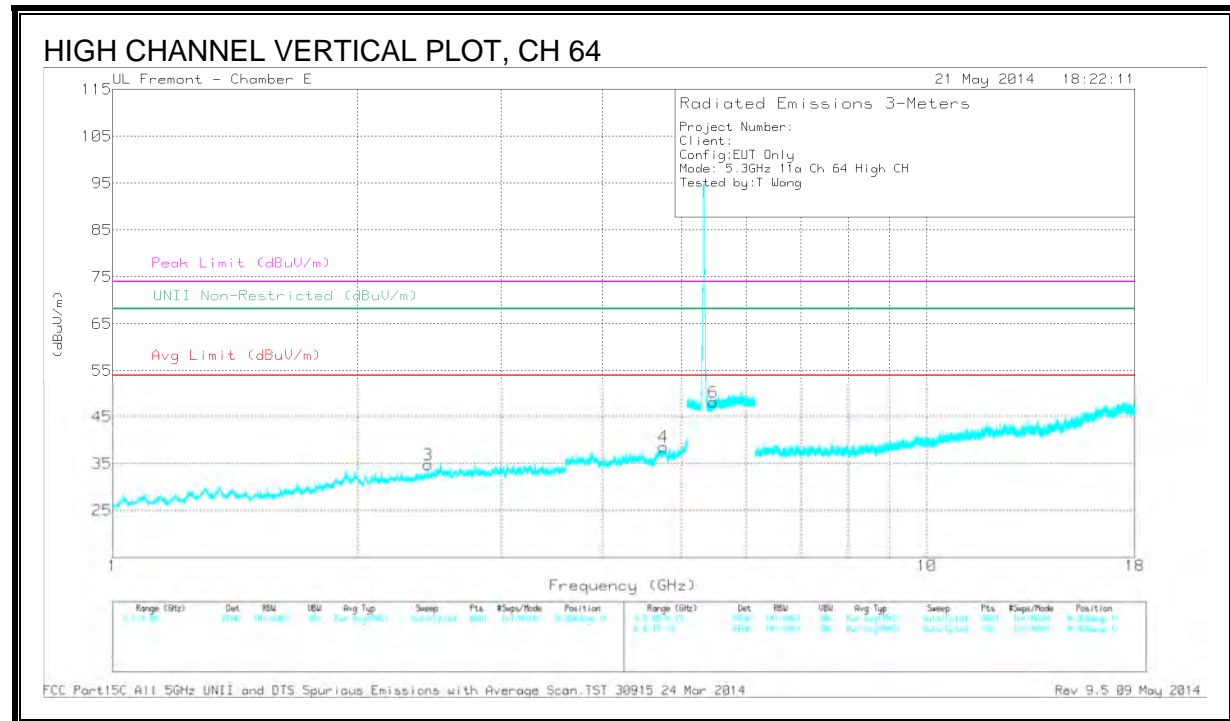
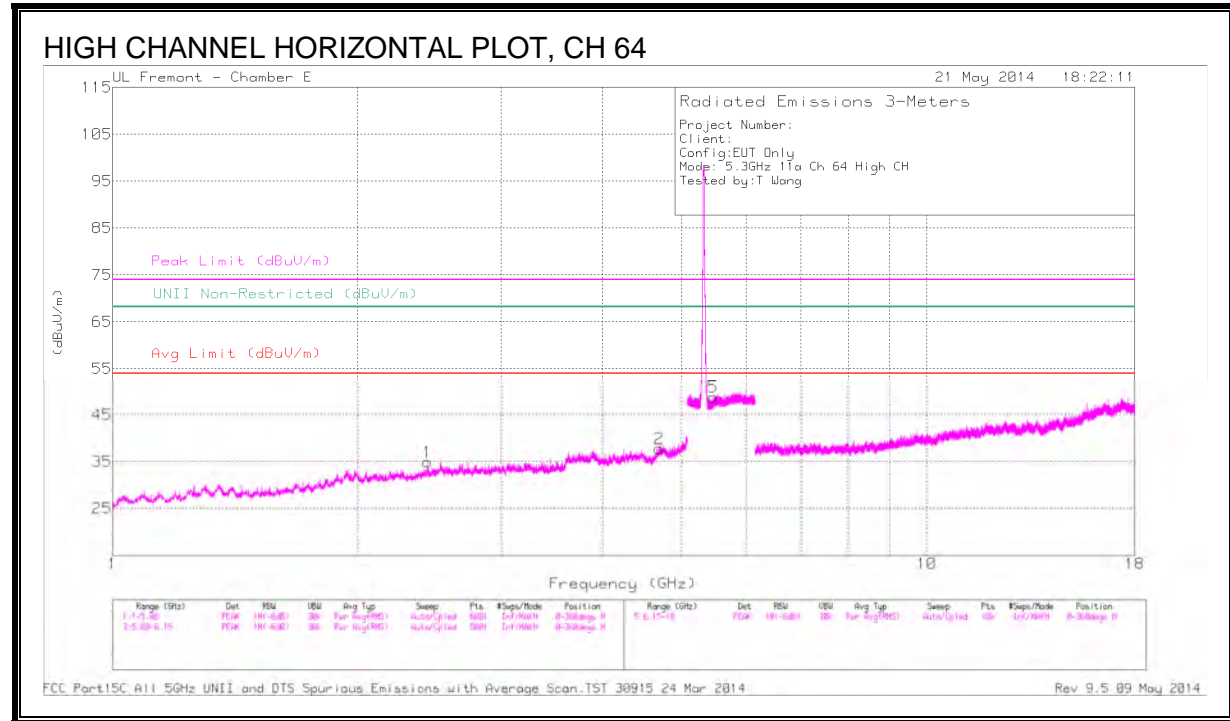

DATA

Frequency (GHz)	Meter Reading (dBuV)	Det	AF T346 (dB/m)	Amp/Cbl/F ltr/Pad (dB)	Corrected Reading (dBuV/m)	Avg Limit (dBuV/m)	Margin (dB)	Peak Limit (dBuV/m)	PK Margin (dB)	UNII Non-Restricted (dBuV/m)	PK Margin (dB)	Azimuth (Degs)	Height (cm)	Polarity
* 4.757	43.8	PK1	34.1	-30.6	47.3	-	-	74	-26.7	-	-	112	251	H
* 4.753	31.45	AD1	34.1	-30.6	34.95	54	-19.05	-	-	-	-	112	251	H
* 4.751	42.93	PK1	34.1	-30.6	46.43	-	-	74	-27.57	-	-	331	316	V
* 4.752	31.48	AD1	34.1	-30.6	34.98	54	-19.02	-	-	-	-	331	316	V
2.433	30.73	AD1	32.1	-33.1	29.73	-	-	-	-	-	-	152	395	H
2.435	42.52	PK1	32.1	-33.1	41.52	-	-	-	-	68.2	-26.68	179	371	V
2.435	30.74	AD1	32.1	-33.1	29.74	-	-	-	-	-	-	179	371	V
2.437	43.14	PK1	32.2	-33.1	42.24	-	-	-	-	68.2	-25.96	152	395	H
5.463	29.58	AD1	34.6	-20.8	43.38	-	-	-	-	-	-	64	141	H
5.463	29.18	AD1	34.6	-20.8	42.98	-	-	-	-	-	-	59	157	V
5.464	40.37	PK1	34.6	-20.8	54.17	-	-	-	-	68.2	-14.03	64	141	H
5.464	40.58	PK1	34.6	-20.8	54.38	-	-	-	-	68.2	-13.82	59	157	V

* - indicates frequency in CFR15.205/IC7.2.2 Restricted Band

PK1 - KDB789033 Method: Peak

AD1 - KDB789033 Method: AD Primary Power Average

10.2.6. TX ABOVE 1 GHz 802.11n HT20 MODE IN THE 5.3 GHz BAND

RESTRICTED BANDEDGE (HIGH CHANNEL)

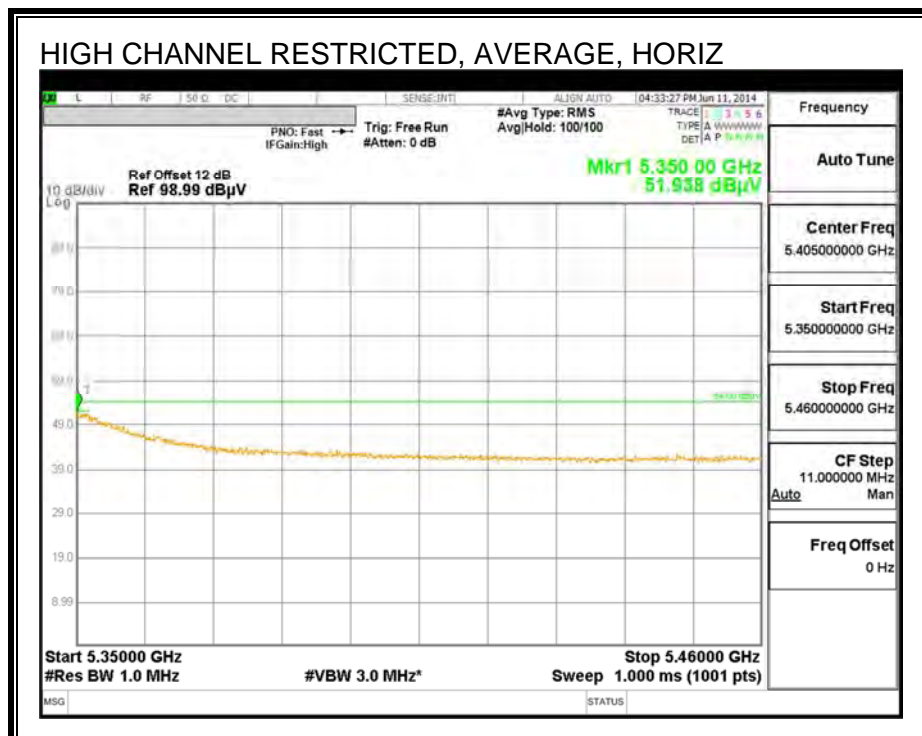
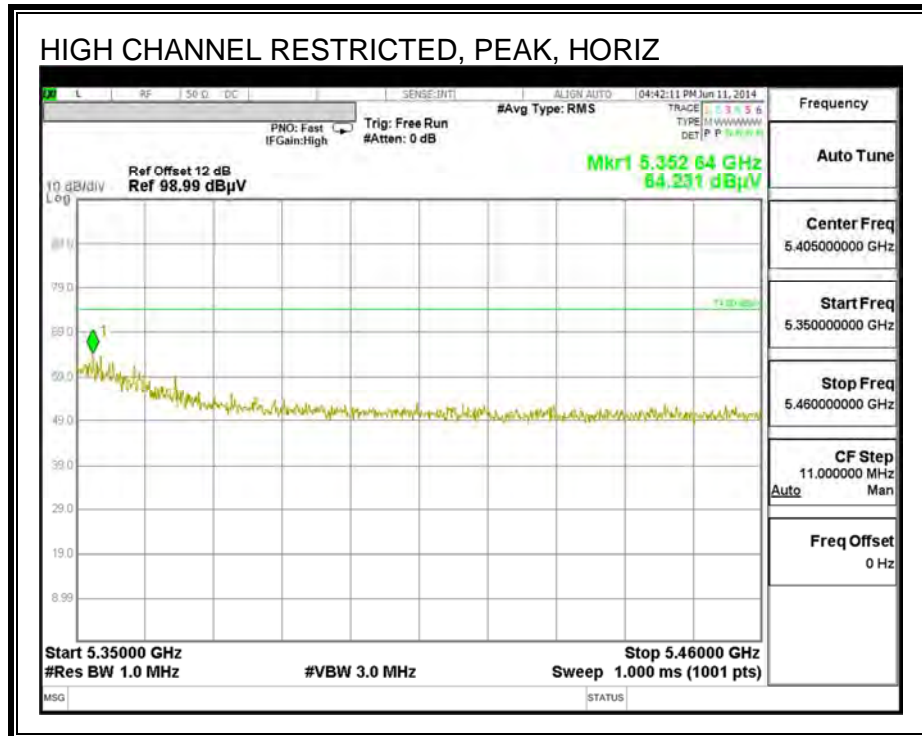

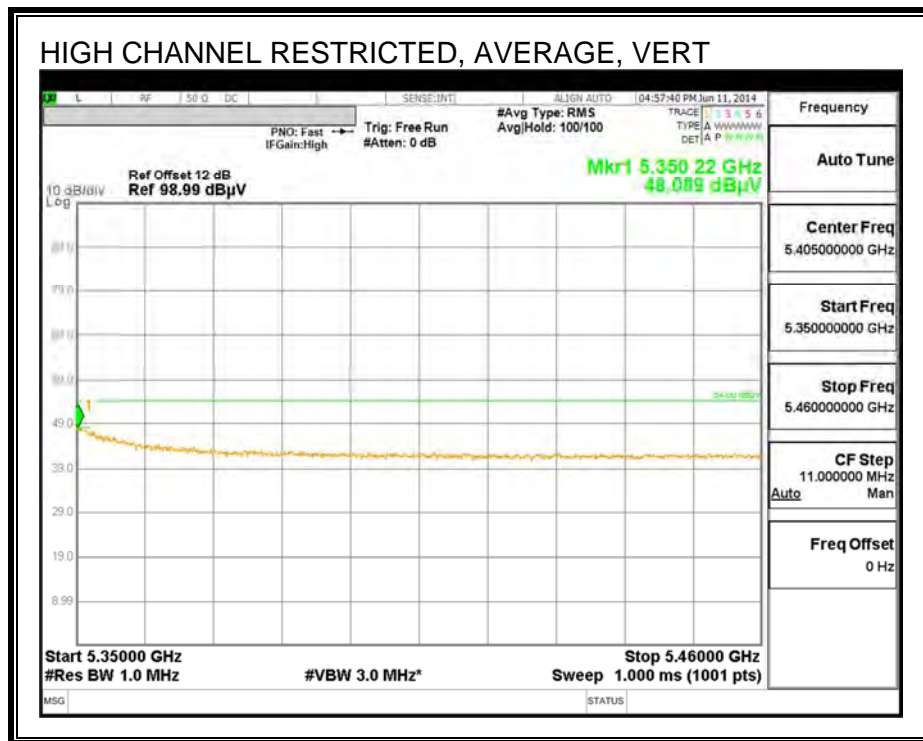
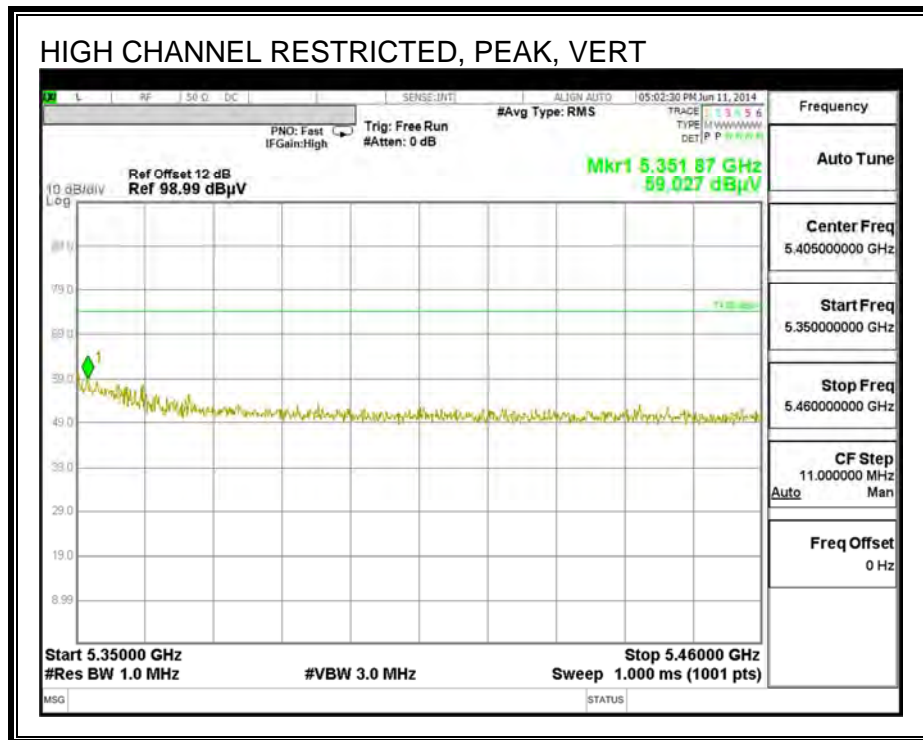

HARMONICS AND SPURIOUS EMISSIONS

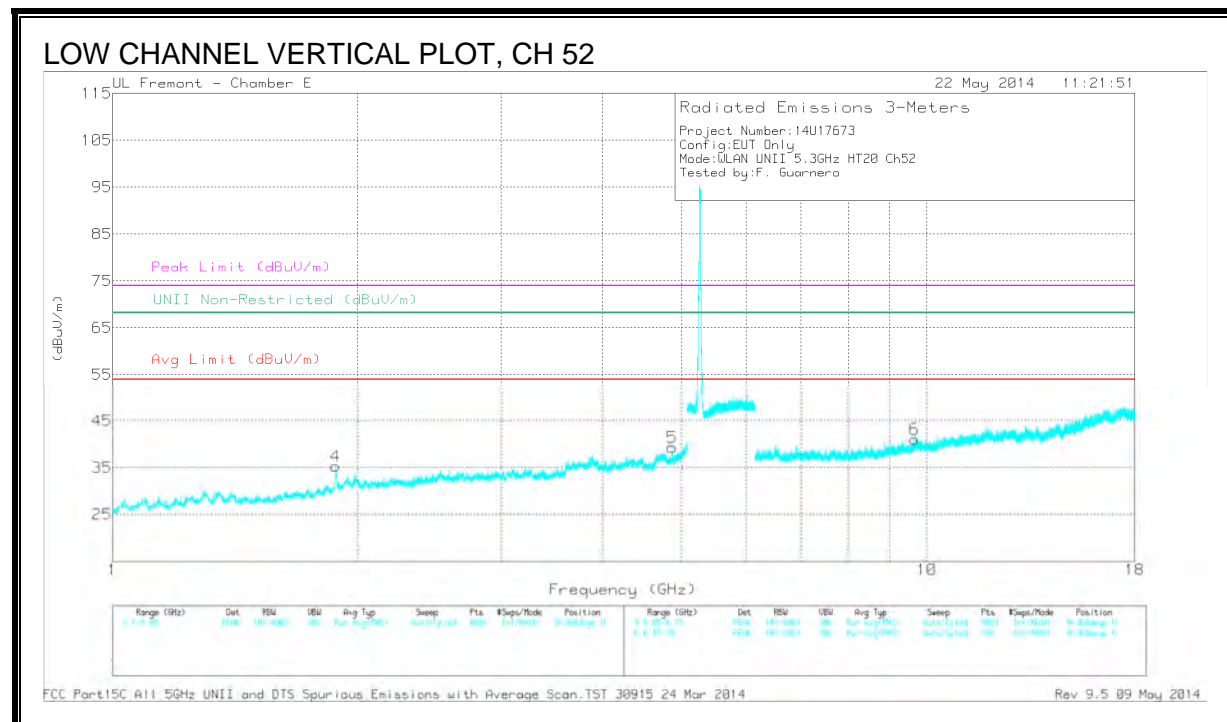
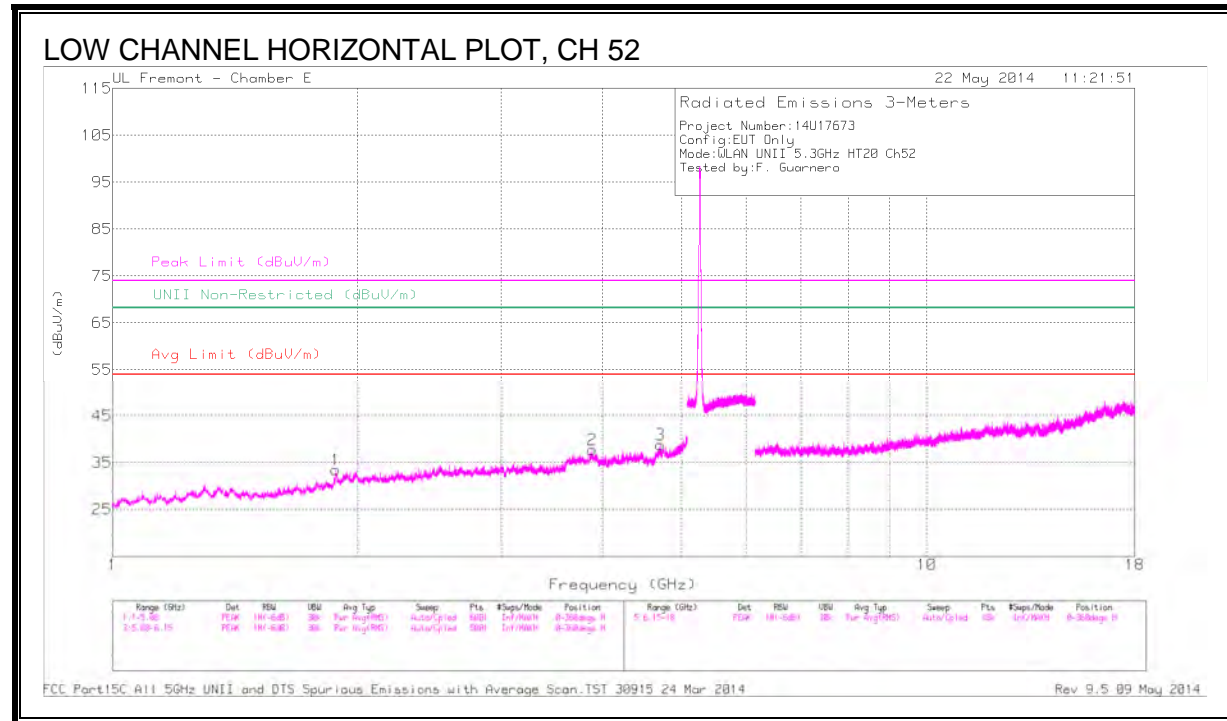

DATA

Frequency (GHz)	Meter Reading (dBuV)	Det	AF T346 (dB/m)	Amp/Cb/Filtr /Pad (dB)	Corrected Reading (dBuV/m)	Avg Limit (dBuV/m)	Margin (dB)	Peak Limit (dBuV/m)	PK Margin (dB)	UNII Non-Restricted (dBuV/m)	PK Margin (dB)	Azimuth (Degs)	Height (cm)	Polarity
* 3.881	41.74	PK1	33.5	-30.5	44.74	-	-	74	-29.26	-	-	8	199	H
* 3.882	30.41	AD1	33.5	-30.5	33.41	54	-20.59	-	-	-	-	8	199	H
* 4.709	41.24	PK1	34.2	-30.2	45.24	-	-	74	-28.76	-	-	108	199	H
* 4.71	30.05	AD1	34.2	-30.2	34.05	54	-19.95	-	-	-	-	108	199	H
* 4.867	41.38	PK1	34.1	-30.1	45.38	-	-	74	-28.62	-	-	108	199	V
* 4.867	29.69	AD1	34.1	-30.1	33.69	54	-20.31	-	-	-	-	108	199	V
1.878	43.41	PK1	30.9	-33.5	40.81	-	-	-	-	68.2	-27.39	108	199	V
1.879	43.07	PK1	30.9	-33.5	40.47	-	-	-	-	68.2	-27.73	360	101	H
9.664	37.38	PK1	37.1	-25.2	49.28	-	-	-	-	68.2	-18.92	108	199	V

* - indicates frequency in CFR15.205/IC7.2.2 Restricted Band

PK1 - KDB789033 Method: Peak

AD1 - KDB789033 Method: AD Primary Power Average

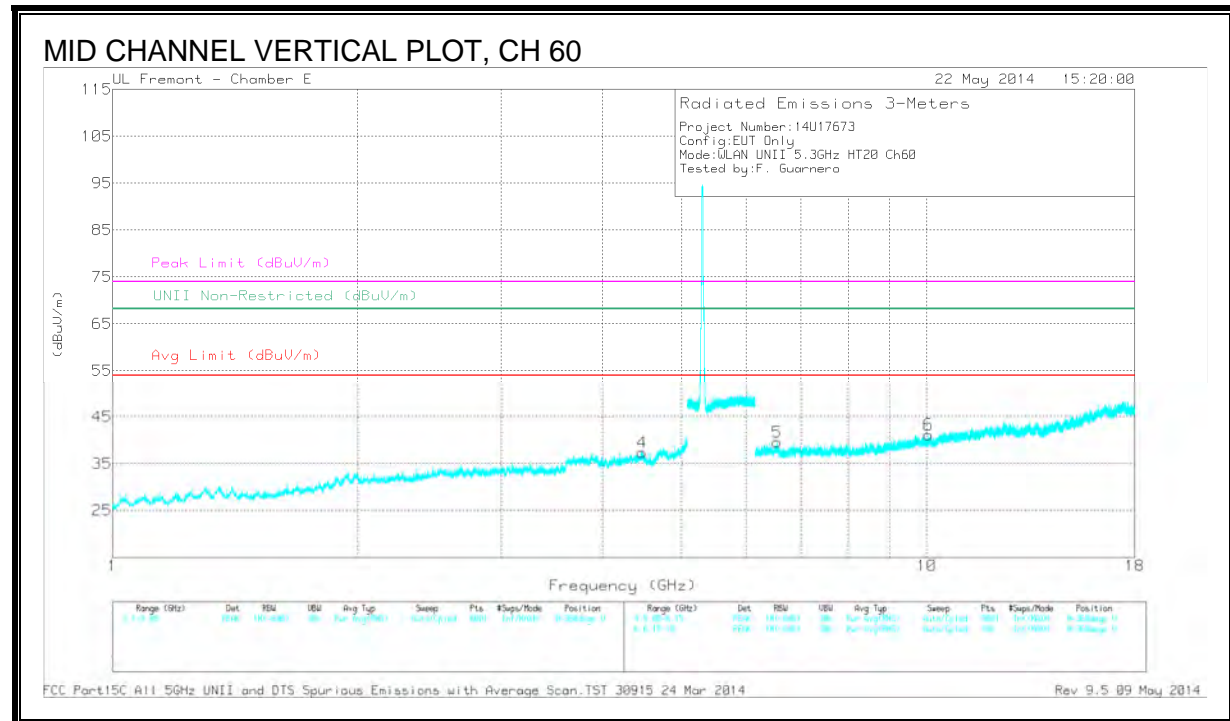
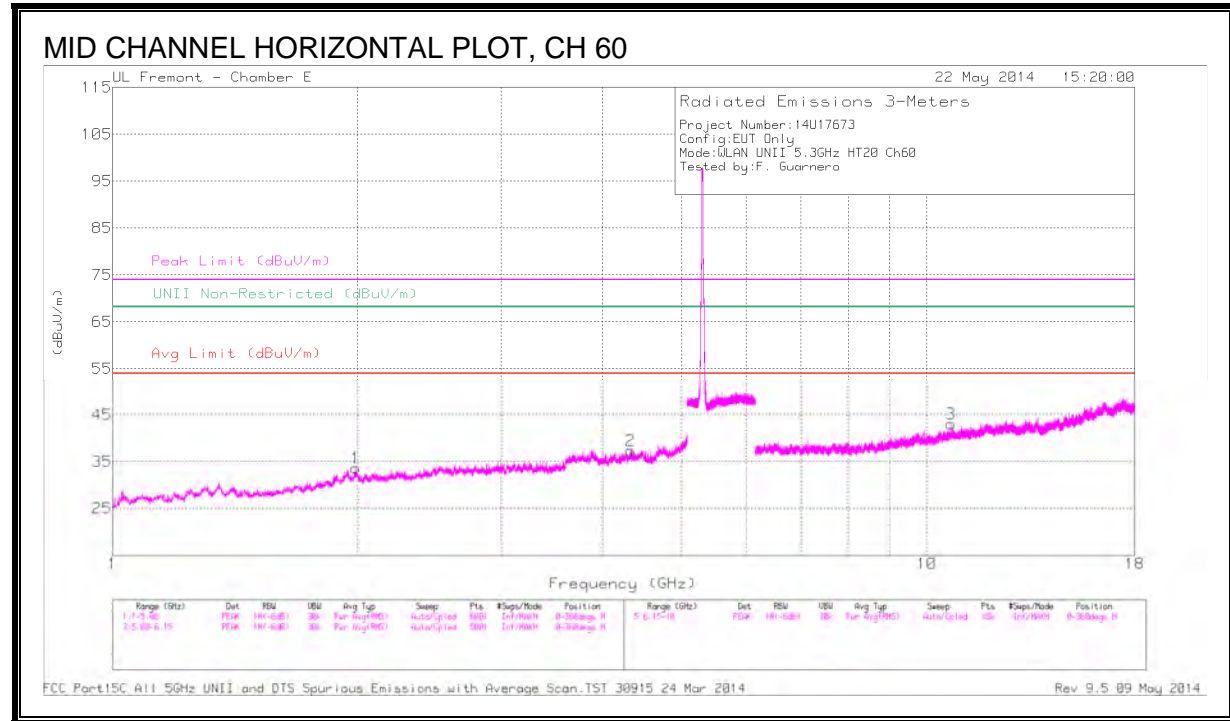

DATA

Frequency (GHz)	Meter Reading (dBuV)	Det	AF T346 (dB/m)	Amp/Cb/Filtr /Pad (dB)	Corrected Reading (dBuV/m)	Avg Limit (dBuV/m)	Margin (dB)	Peak Limit (dBuV/m)	PK Margin (dB)	UNII Non-Restricted (dBuV/m)	PK Margin (dB)	Azimuth (Degs)	Height (cm)	Polarity
* 4.327	41.8	PK1	33.6	-30.5	44.9	-	-	74	-29.1	-	-	360	101	H
* 4.327	30.26	AD1	33.6	-30.5	33.36	54	-20.64	-	-	-	-	360	101	H
* 10.698	36.38	PK1	37.9	-23.7	50.58	-	-	74	-23.42	-	-	360	101	H
* 10.698	24.95	AD1	37.9	-23.7	39.15	54	-14.85	-	-	-	-	360	101	H
1.99	43.13	PK1	31.3	-32.7	41.73	-	-	-	-	68.2	-26.47	360	101	H
4.467	41.8	PK1	33.9	-30.3	45.4	-	-	-	-	68.2	-22.8	360	101	V
6.543	39.99	PK1	35.7	-27.6	48.09	-	-	-	-	68.2	-20.11	360	101	V
10.046	36.65	PK1	37.1	-24.2	49.55	-	-	-	-	68.2	-18.65	360	101	V

* - indicates frequency in CFR15.205/IC7.2.2 Restricted Band

PK1 - KDB789033 Method: Peak

AD1 - KDB789033 Method: AD Primary Power Average

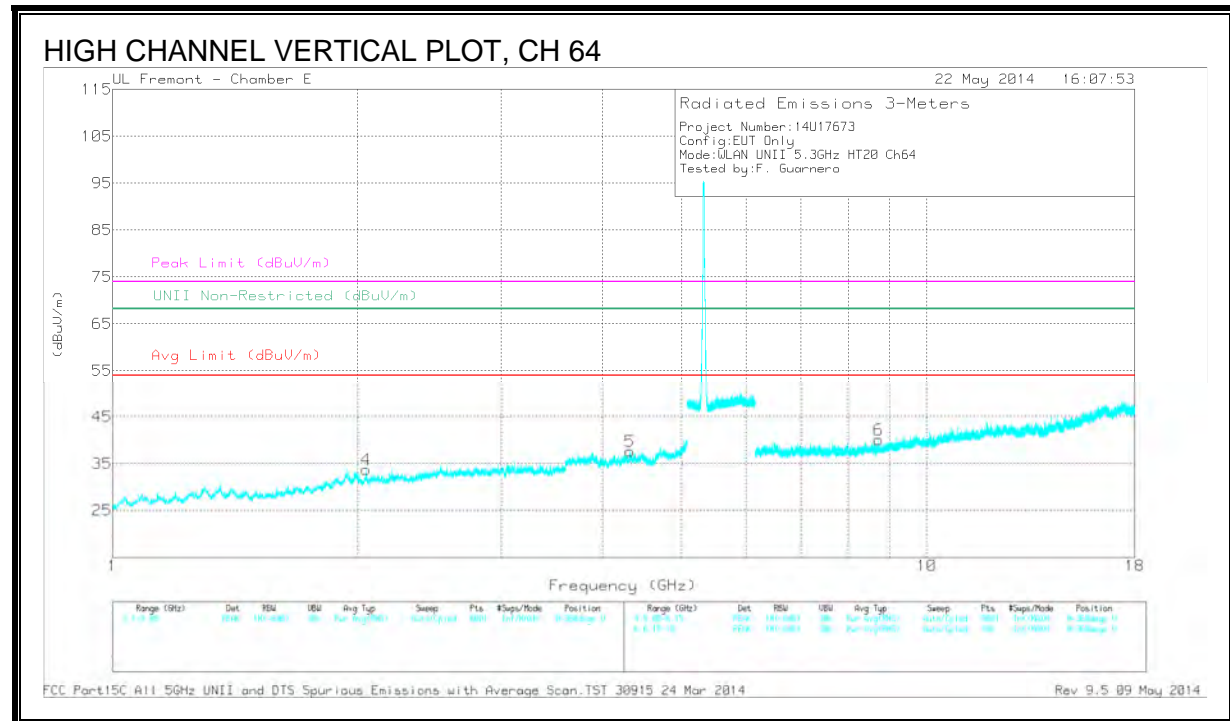
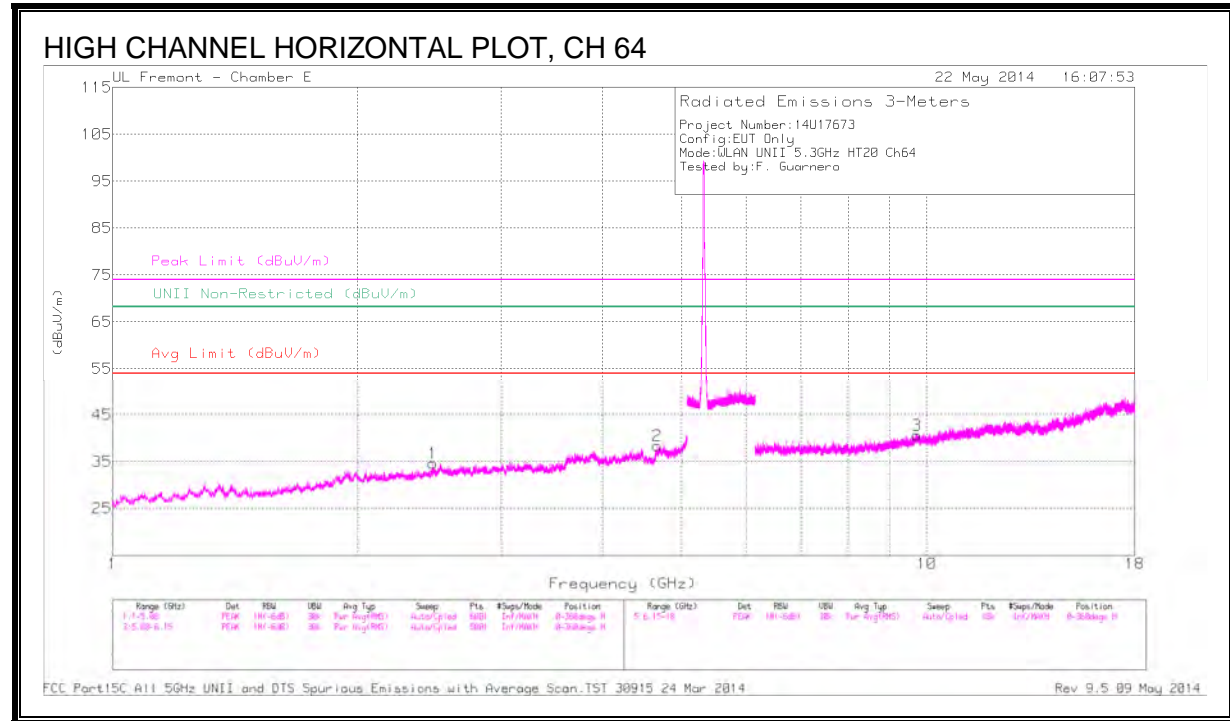

DATA

Frequency (GHz)	Meter Reading (dBuV)	Det	AF T346 (dB/m)	Amp/Cb/Fitr /Pad (dB)	Corrected Reading (dBuV/m)	Avg Limit (dBuV/m)	Margin (dB)	Peak Limit (dBuV/m)	PK Margin (dB)	UNII Non-Restricted (dBuV/m)	PK Margin (dB)	Azimuth (Degs)	Height (cm)	Polarity
* 4.664	41.61	PK1	34.1	-29.7	46.01	-	-	74	-27.99	-	-	360	200	H
* 4.664	30.36	AD1	34.1	-29.7	34.76	54	-19.24	-	-	-	-	360	200	H
* 4.318	41.68	PK1	33.6	-30.5	44.78	-	-	74	-29.22	-	-	360	200	V
* 4.318	30.07	AD1	33.6	-30.5	33.17	54	-20.83	-	-	-	-	360	200	V
2.049	42.86	PK1	31.5	-33.4	40.96	-	-	-	-	68.2	-27.24	360	200	V
2.472	42.54	PK1	32.3	-32.6	42.24	-	-	-	-	68.2	-25.96	360	200	H
8.729	38.52	PK1	36	-26.5	48.02	-	-	-	-	68.2	-20.18	360	200	V
9.722	36.79	PK1	37.1	-24.9	48.99	-	-	-	-	68.2	-19.21	360	200	H

* - indicates frequency in CFR15.205/IC7.2.2 Restricted Band

PK1 - KDB789033 Method: Peak

AD1 - KDB789033 Method: AD Primary Power Average

10.2.7. TX ABOVE 1 GHz 802.11n HT40 MODE IN THE 5.3 GHz BAND

RESTRICTED BANEDGE (HIGH CHANNEL)

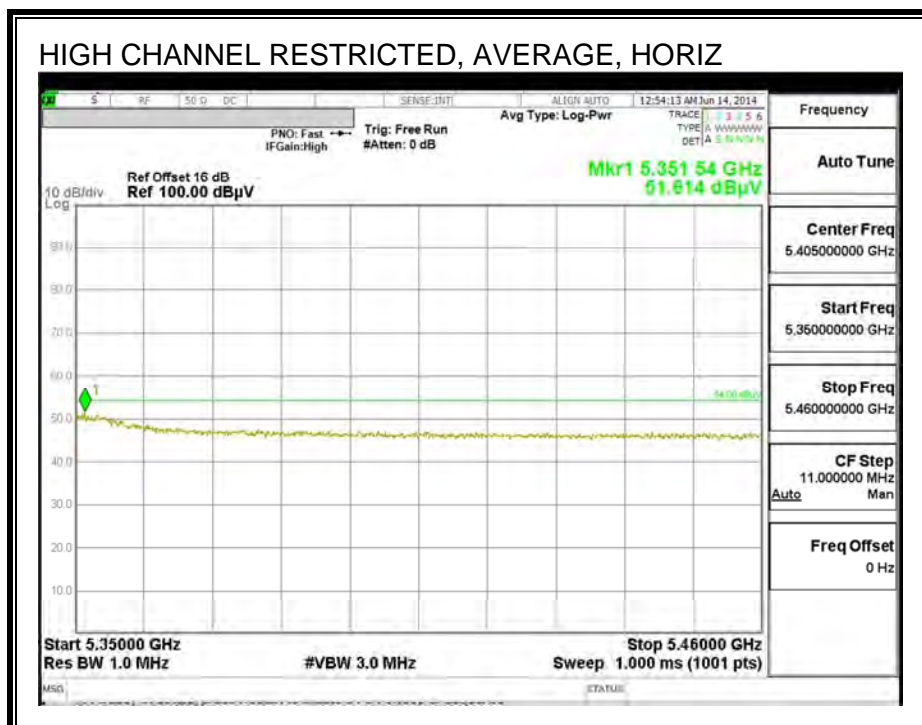
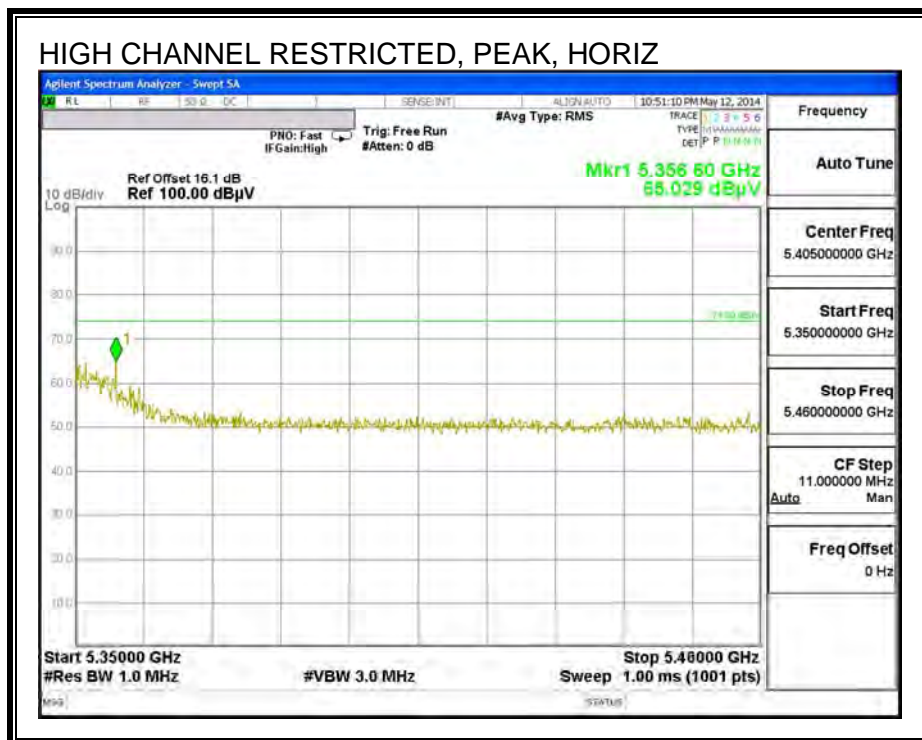

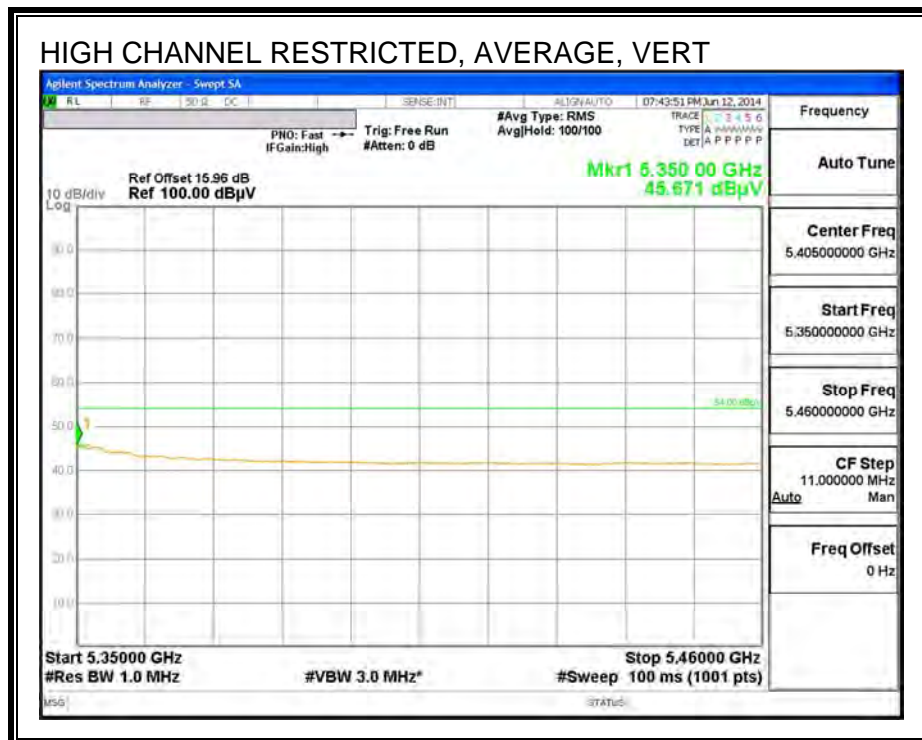
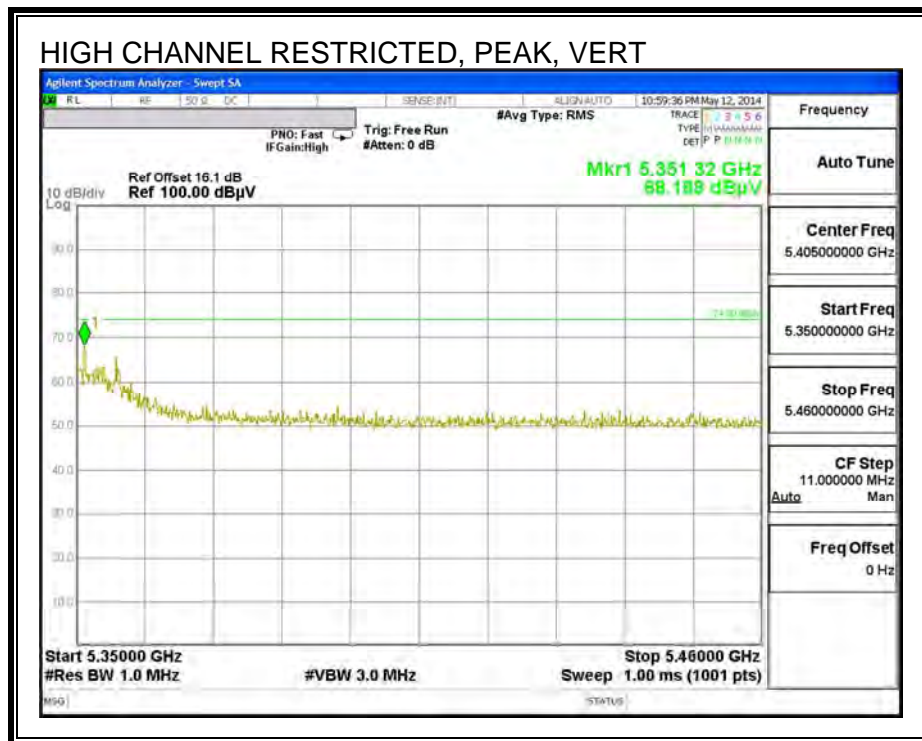

HARMONICS AND SPURIOUS EMISSIONS

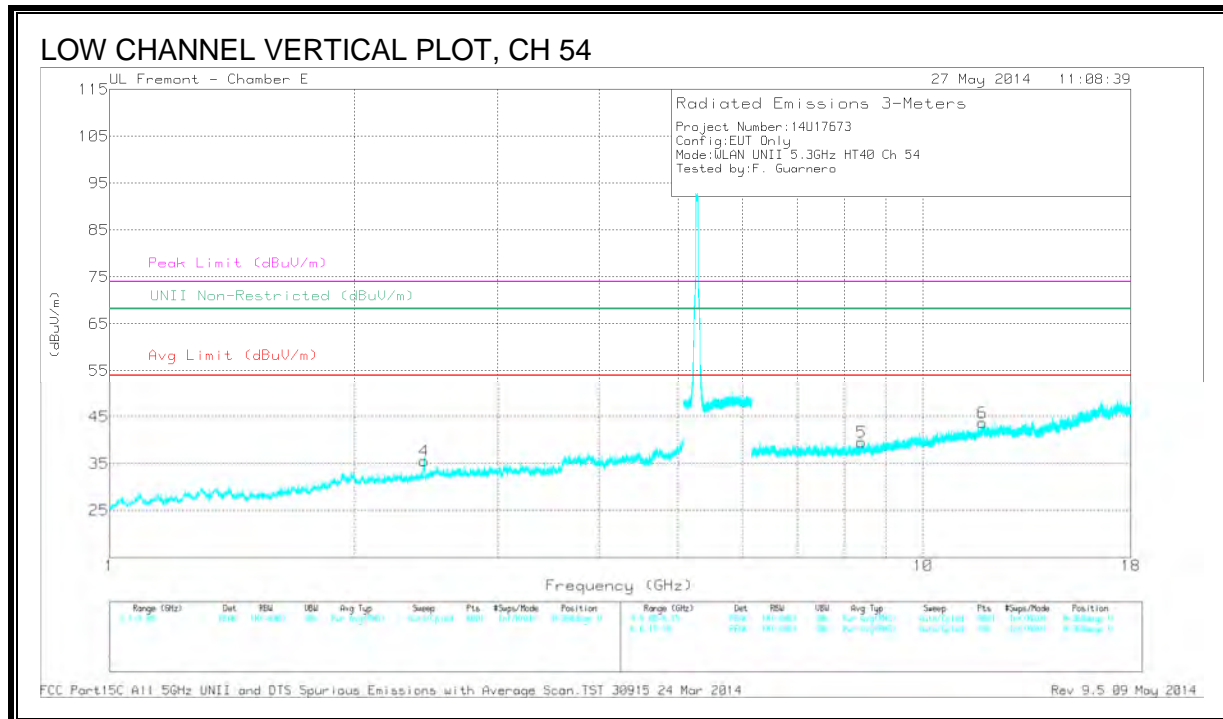
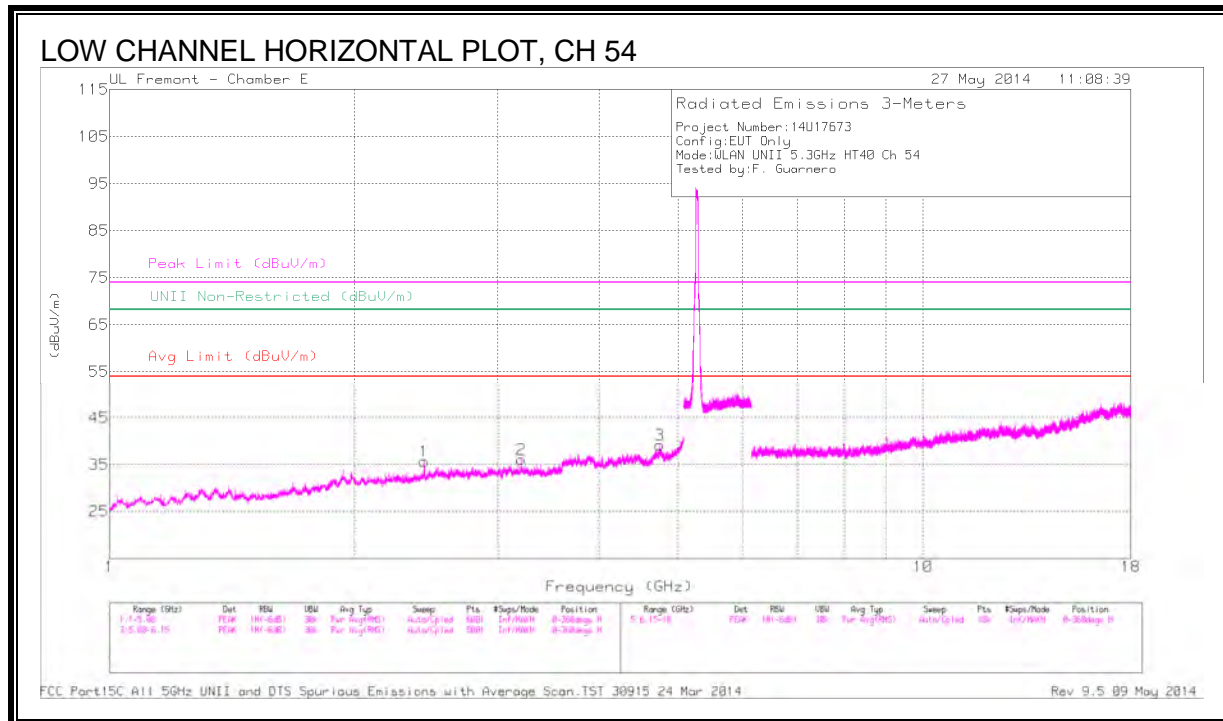

DATA

Frequency (GHz)	Meter Reading (dBuV)	Det	AF T346 (dB/m)	Amp/Cb/Fitr /Pad (dB)	Corrected Reading (dBuV/m)	Avg Limit (dBuV/m)	Margin (dB)	Peak Limit (dBuV/m)	PK Margin (dB)	UNII Non-Restricted (dBuV/m)	PK Margin (dB)	Azimuth (Degs)	Height (cm)	Polarity
* 4.744	42.74	PK1	34.1	-30.6	46.24	-	-	74	-27.76	-	-	68	200	H
* 4.744	30.62	AD1	34.1	-30.6	34.12	54	-19.88	-	-	-	-	68	200	H
* 8.399	38.92	PK1	35.9	-26.9	47.92	-	-	74	-26.08	-	-	68	200	V
* 8.399	27.1	AD1	35.9	-26.9	36.1	54	-17.9	-	-	-	-	68	200	V
* 11.827	36.33	PK1	38.5	-23.2	51.63	-	-	74	-22.37	-	-	68	200	V
* 11.827	24.6	AD1	38.5	-23.2	39.9	54	-14.1	-	-	-	-	68	200	V
2.435	42.98	PK1	32.1	-33.1	41.98	-	-	-	-	68.2	-26.22	68	200	V
2.438	42.46	PK1	32.2	-33.1	41.56	-	-	-	-	68.2	-26.64	68	200	H
3.208	41.89	PK1	32.8	-31.9	42.79	-	-	-	-	68.2	-25.41	68	200	H

* - indicates frequency in CFR15.205/IC7.2.2 Restricted Band

PK1 - KDB789033 Method: Peak

AD1 - KDB789033 Method: AD Primary Power Average

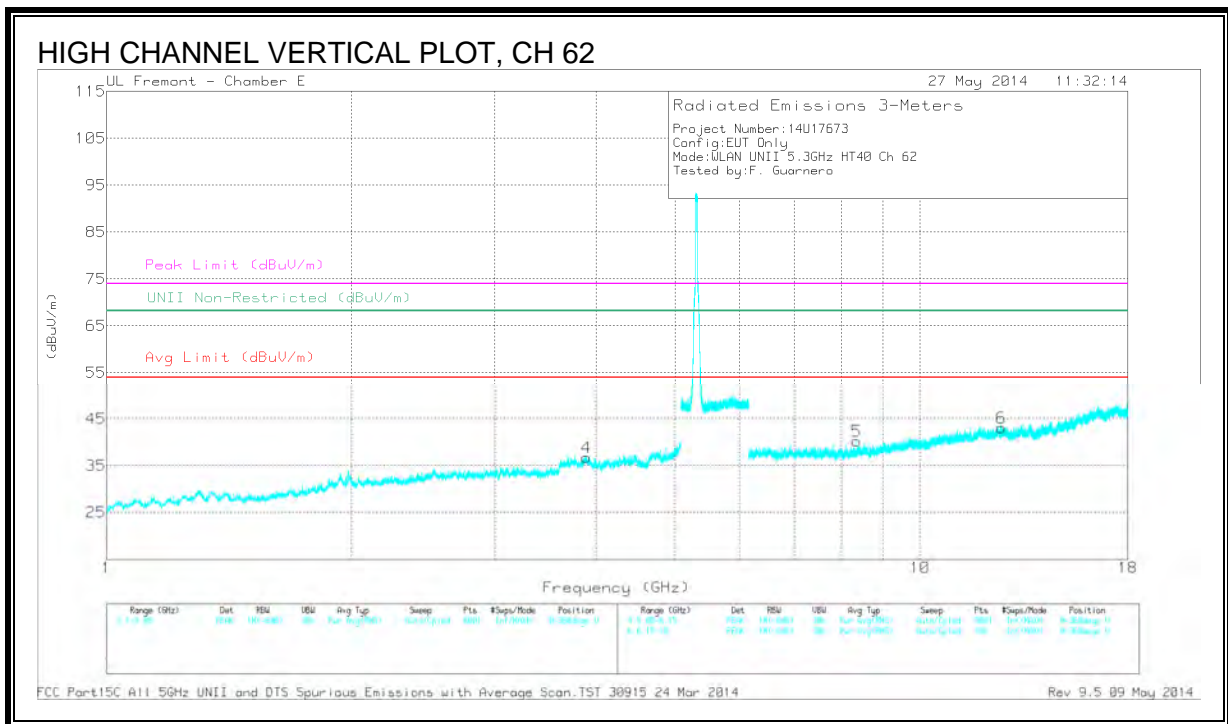
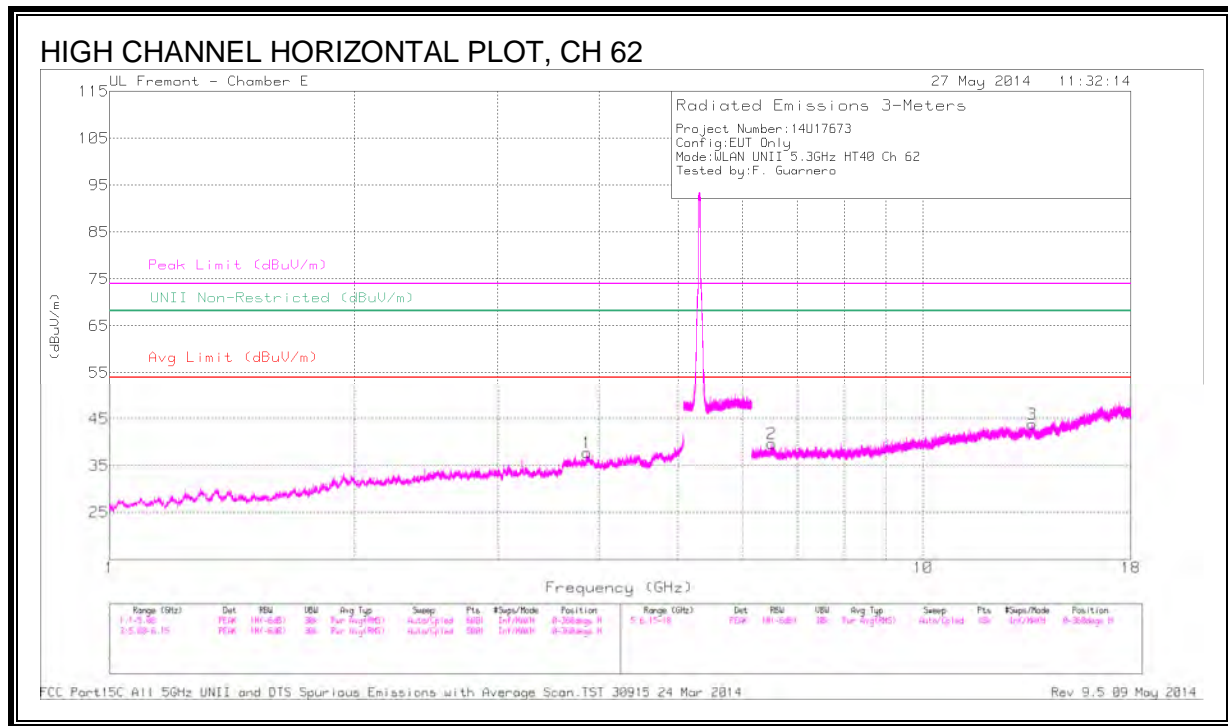

DATA

Frequency (GHz)	Meter Reading (dBuV)	Det	AF T346 (dB/m)	Amp/Cb/Filtr /Pad (dB)	Corrected Reading (dBuV/m)	Avg Limit (dBuV/m)	Margin (dB)	Peak Limit (dBuV/m)	PK Margin (dB)	UNII Non-Restricted (dBuV/m)	PK Margin (dB)	Azimuth (Degs)	Height (cm)	Polarity
* 3.862	41.73	PK1	33.5	-30.8	44.43	-	-	74	-29.57	-	-	0	101	H
* 3.862	30.62	AD1	33.5	-30.8	33.32	54	-20.68	-	-	-	-	0	101	H
* 3.887	42.02	PK1	33.5	-30.4	45.12	-	-	74	-28.88	-	-	0	101	V
* 3.887	30.62	AD1	33.5	-30.4	33.72	54	-20.28	-	-	-	-	0	101	V
* 8.353	38.89	PK1	35.9	-27.3	47.49	-	-	74	-26.51	-	-	0	101	V
* 8.353	27.43	AD1	35.9	-27.3	36.03	54	-17.97	-	-	-	-	0	101	V
* 12.584	36.78	PK1	39	-24.9	50.88	-	-	74	-23.12	-	-	0	101	V
* 12.584	25.87	AD1	39	-24.9	39.97	54	-14.03	-	-	-	-	0	101	V
6.512	40.18	PK1	35.6	-27.7	48.08	-	-	-	-	68.2	-20.12	0	101	H
13.616	38.13	PK1	38.9	-24.6	52.43	-	-	-	-	68.2	-15.77	0	101	H

* - indicates frequency in CFR15.205/IC7.2.2 Restricted Band

PK1 - KDB789033 Method: Peak

AD1 - KDB789033 Method: AD Primary Power Average

10.2.8. TX ABOVE 1G 802.11ac 80MHz MODE IN THE 5.3 GHz BAND

RESTRICTED BANDEDGE (HIGH CHANNEL, CH 58)

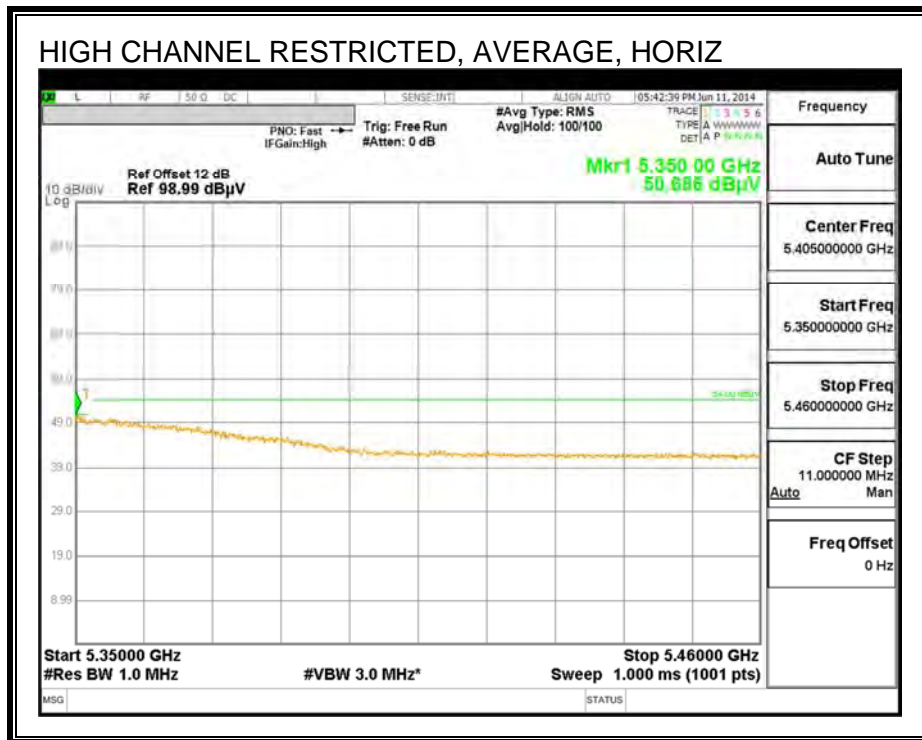
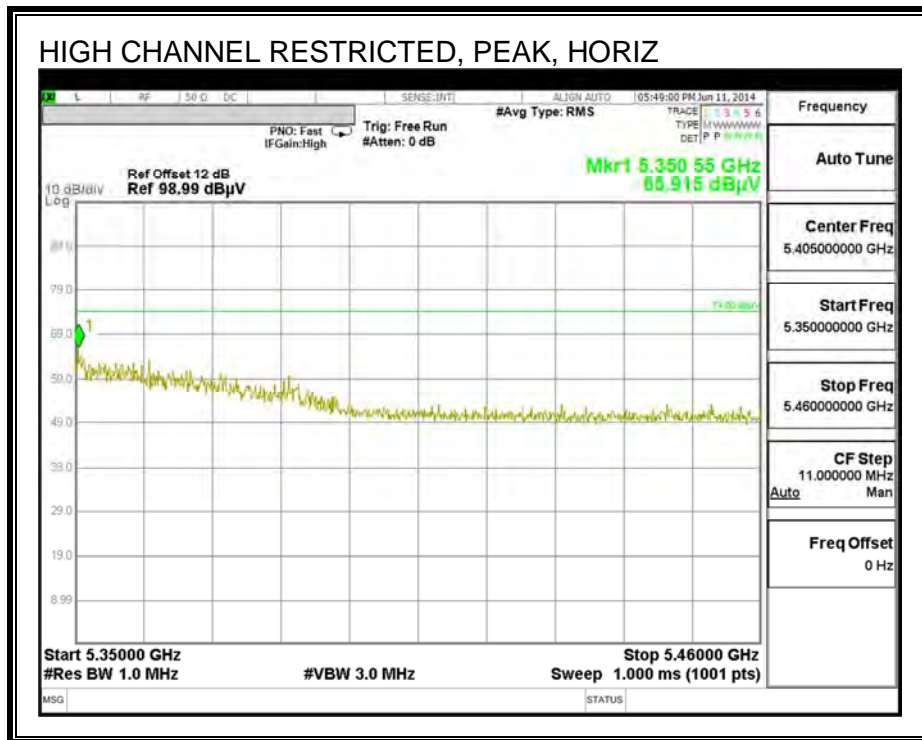

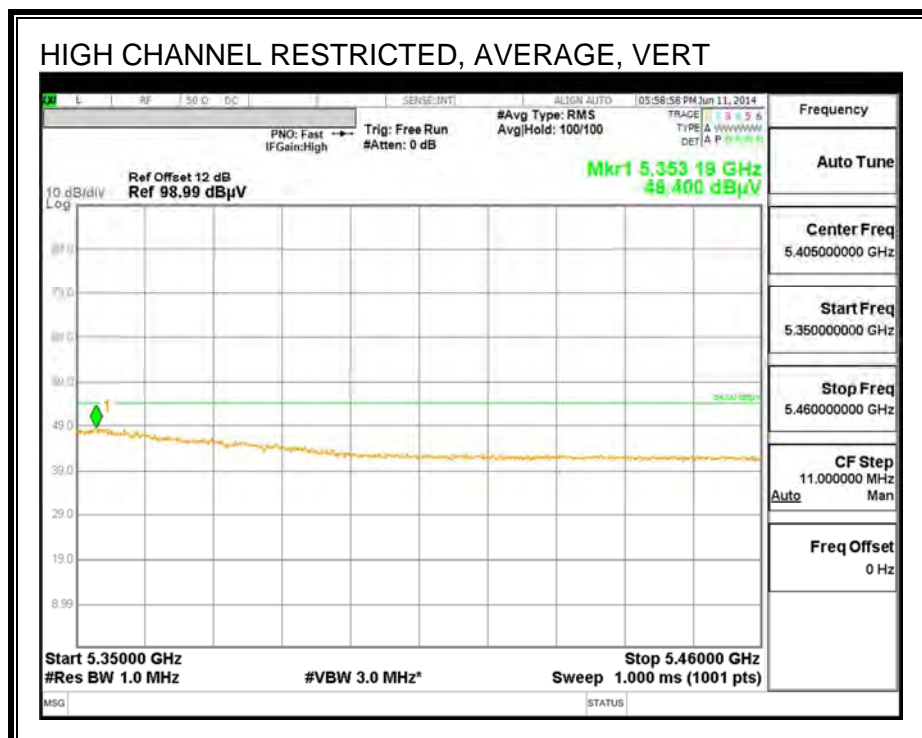
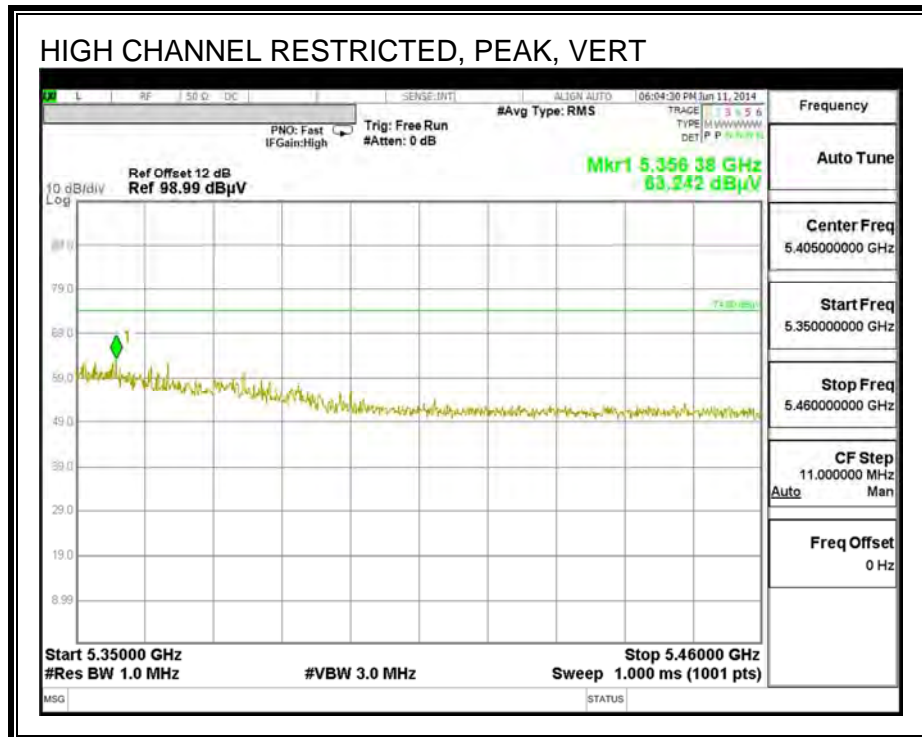

HARMONICS AND SPURIOUS EMISSIONS

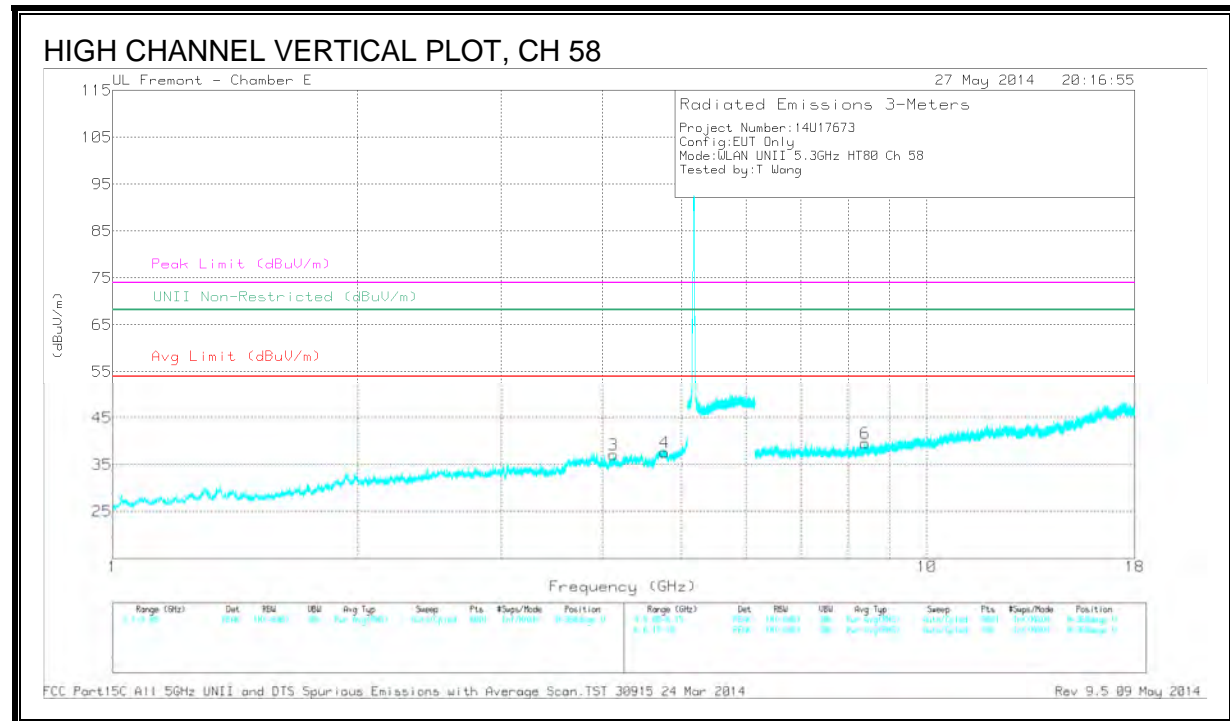
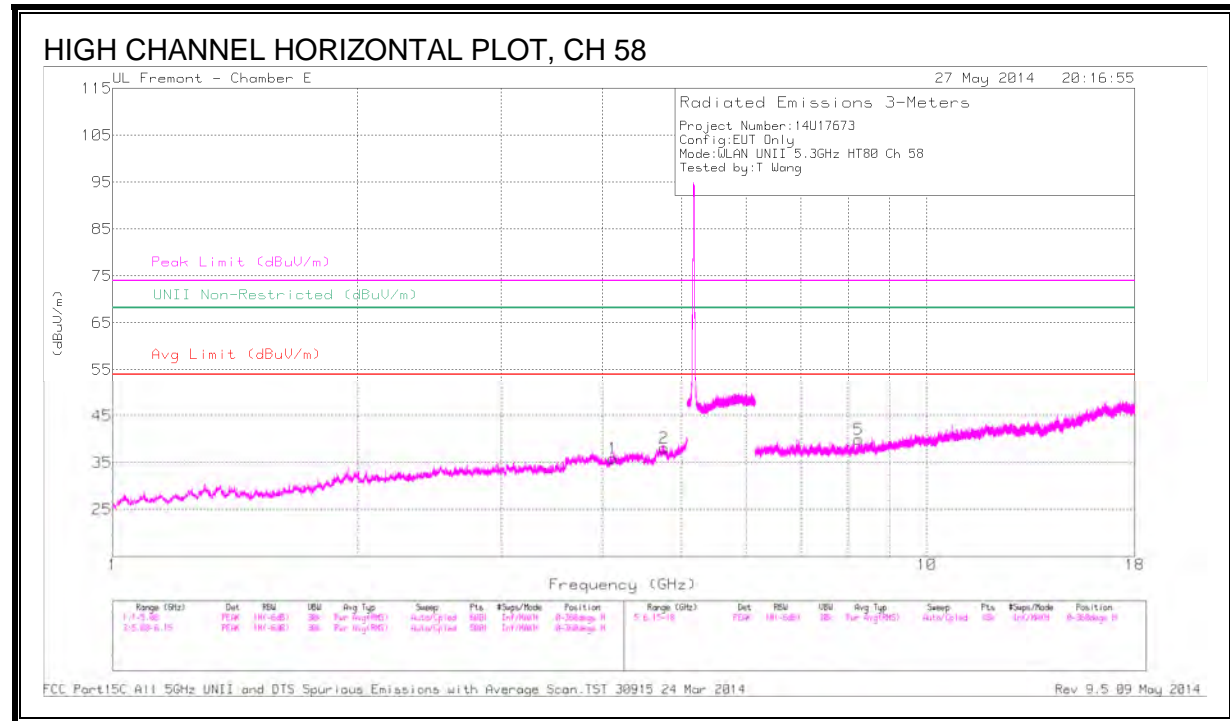

DATA

Marker	Frequency (GHz)	Meter Reading (dBuV)	Det	AF T346 (dB/m)	Amp/Cbl/Filtr/Pad (dB)	DC Corr (dB)	Corrected Reading (dBuV/m)	Avg Limit (dBuV/m)	Margin (dB)	Peak Limit (dBuV/m)	PK Margin (dB)	UNII Non-Restricted (dBuV/m)	PK Margin (dB)	Azimuth (Degs)	Height (cm)	Polarity
1	* 4.115	41.63	PK1	33.5	-31	0	44.13	-	-	74	-29.87	-	-	335	115	H
	* 4.127	30.63	AD1	33.5	-31	.2	33.33	54	-20.67	-	-	-	-	335	115	H
2	* 4.749	43.51	PK1	34.1	-30.6	0	47.01	-	-	74	-26.99	-	-	139	272	H
	* 4.753	31.44	AD1	34.1	-30.6	.2	35.14	54	-18.86	-	-	-	-	139	272	H
3	* 4.116	42.57	PK1	33.5	-31	0	45.07	-	-	74	-28.93	-	-	223	174	V
	* 4.129	30.6	AD1	33.5	-31	.2	33.3	54	-20.7	-	-	-	-	223	174	V
4	* 4.752	42.67	PK1	34.1	-30.6	0	46.17	-	-	74	-27.83	-	-	242	319	V
	* 4.753	31.49	AD1	34.1	-30.6	.2	35.19	54	-18.81	-	-	-	-	242	319	V
5	* 8.243	38.45	PK1	35.9	-27.4	0	46.95	-	-	74	-27.05	-	-	242	188	H
	* 8.239	27.02	AD1	35.9	-27.5	.2	35.62	54	-18.38	-	-	-	-	242	188	H
6	* 8.404	38.25	PK1	35.9	-26.9	0	47.25	-	-	74	-26.75	-	-	260	175	V
	* 8.404	26.69	AD1	35.9	-26.9	.2	35.89	54	-18.11	-	-	-	-	260	175	V

* - indicates frequency in CFR15.205/IC7.2.2 Restricted Band

PK1 - KDB789033 Method: Peak

AD1 - KDB789033 Method: AD Primary Power Average

10.2.9. TX ABOVE 1 GHz 802.11a MODE IN THE 5.6 GHz BAND

RESTRICTED & AUTHORIZED BANDEGE (LOW CHANNEL)

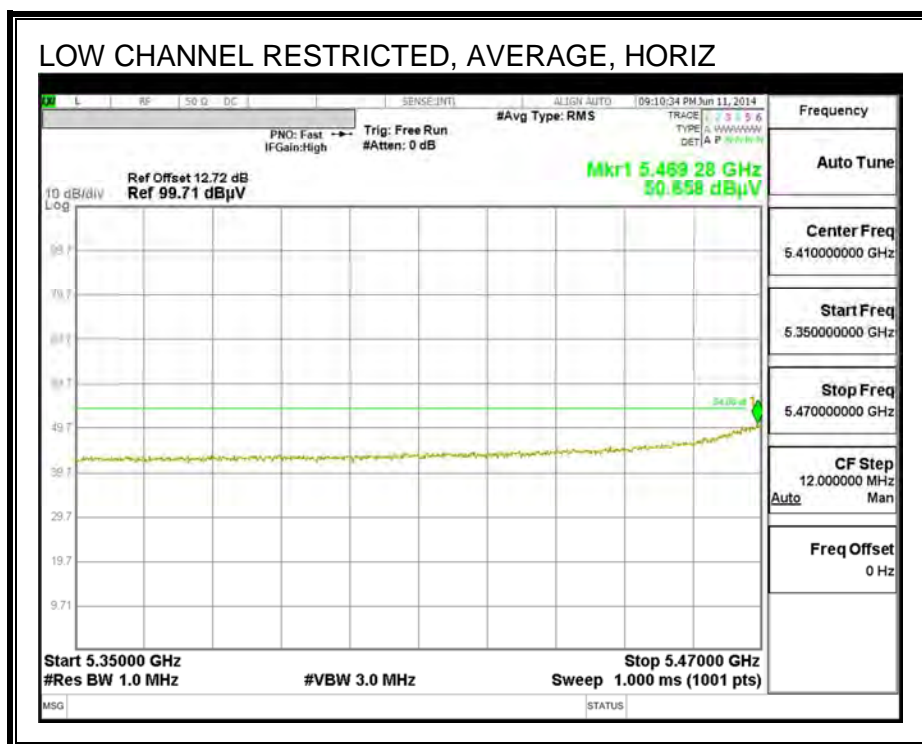
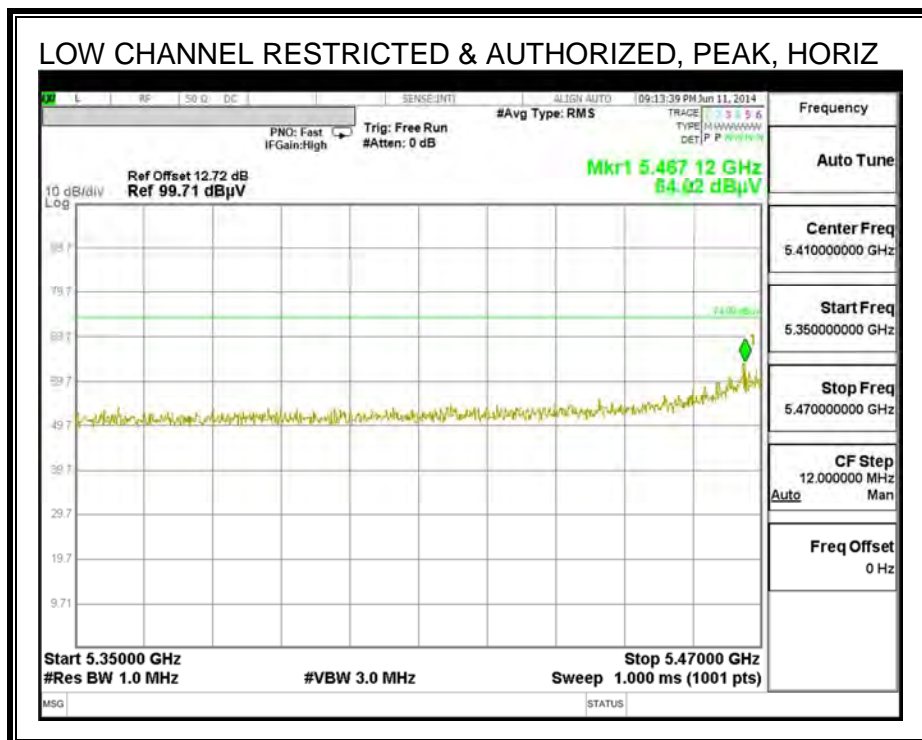

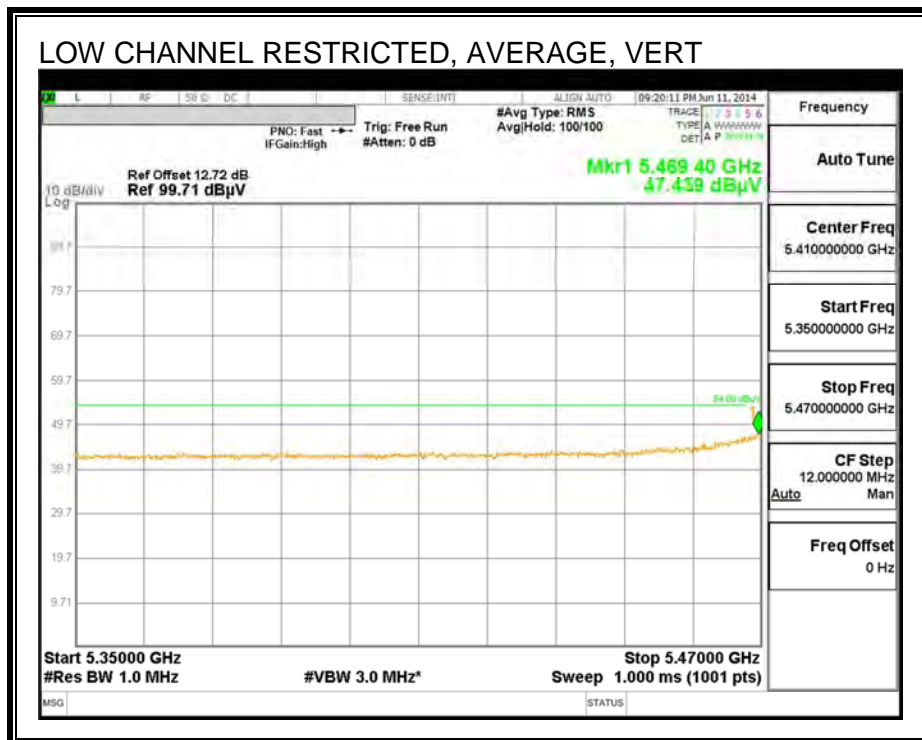
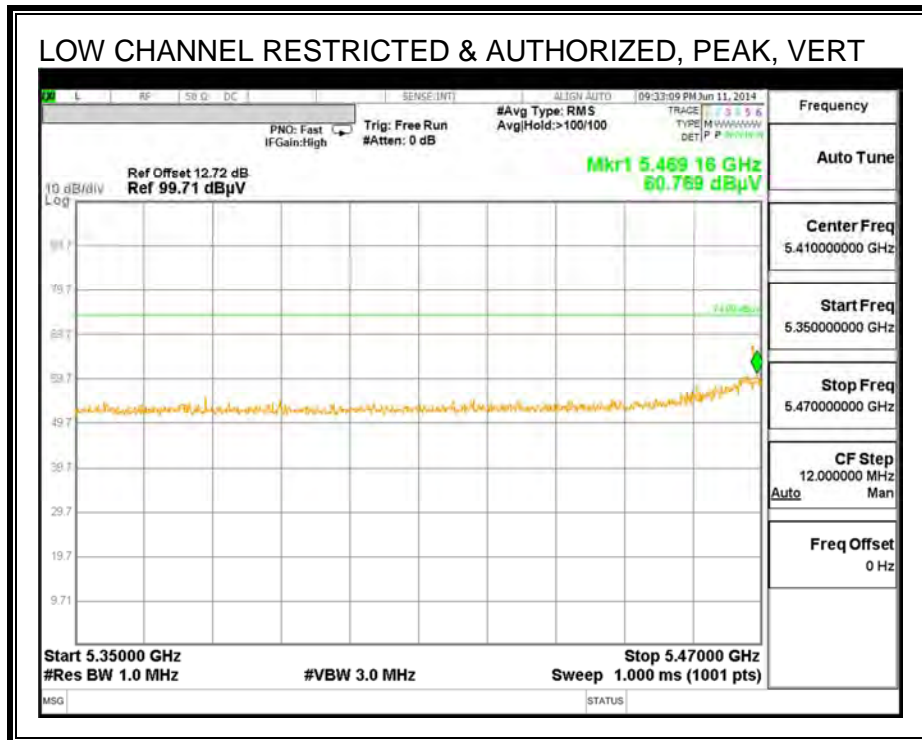

AUTHORIZED BANDEDGE (HIGH CHANNEL)

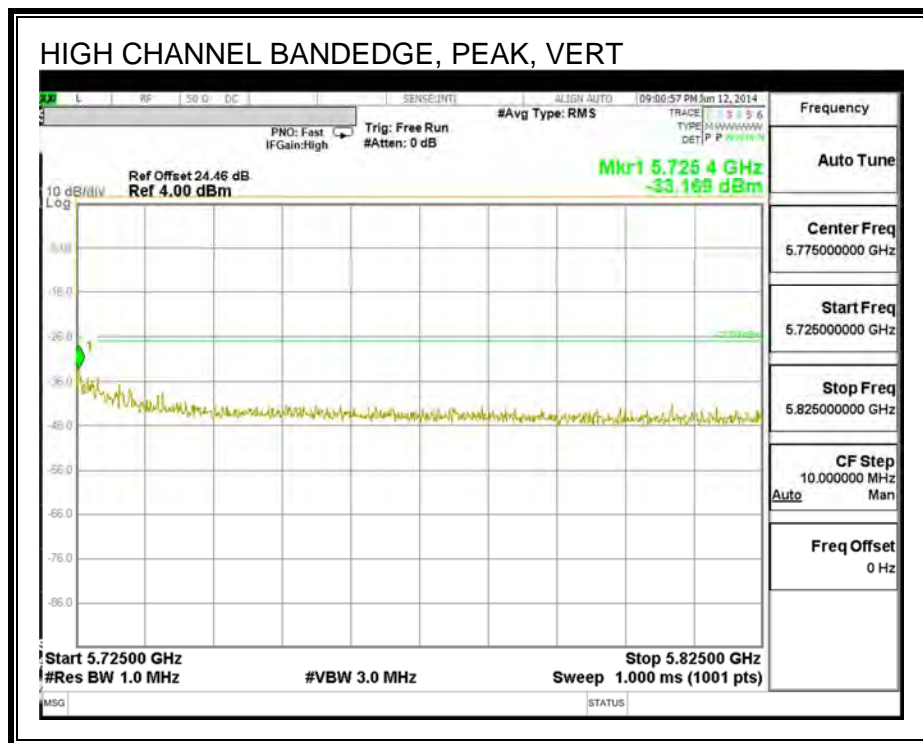
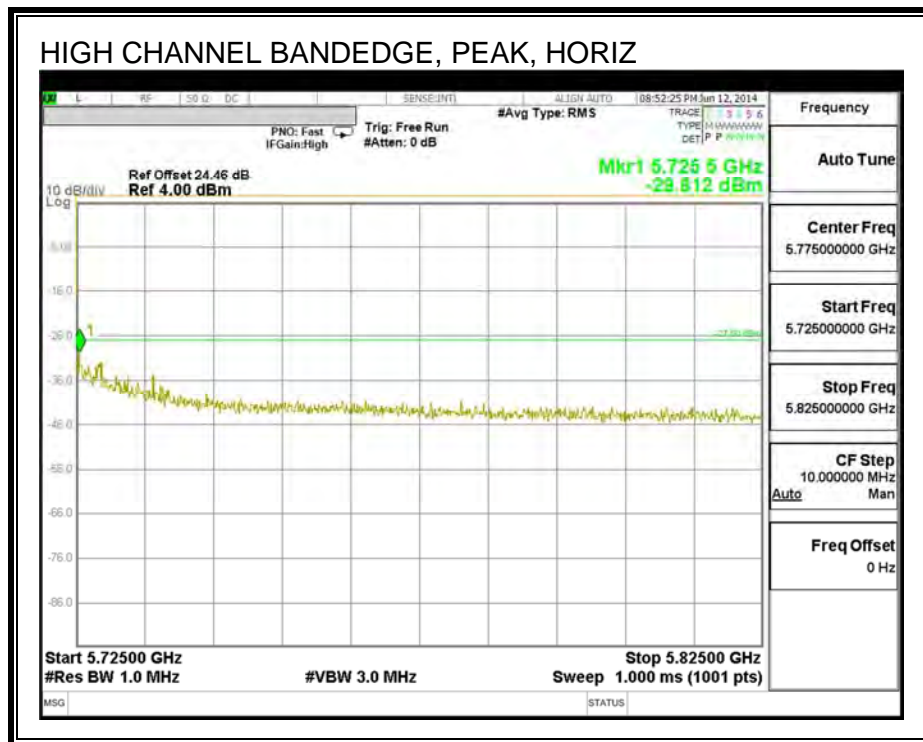

HARMONICS AND SPURIOUS EMISSIONS

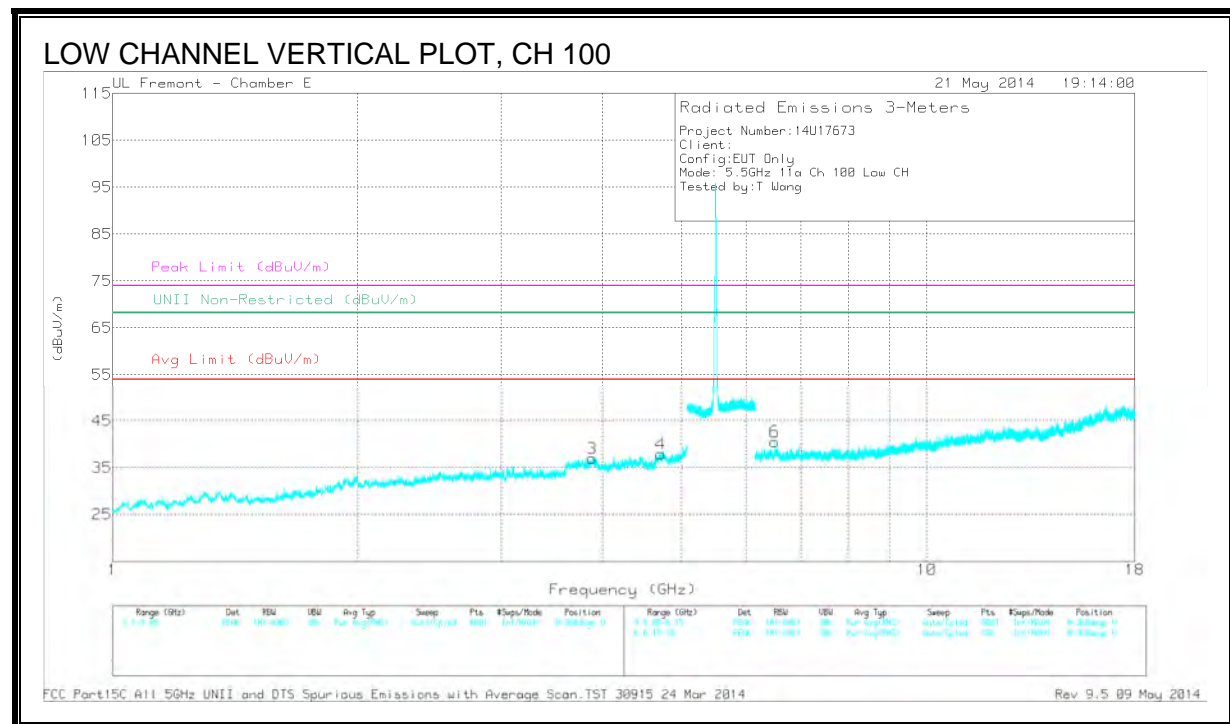
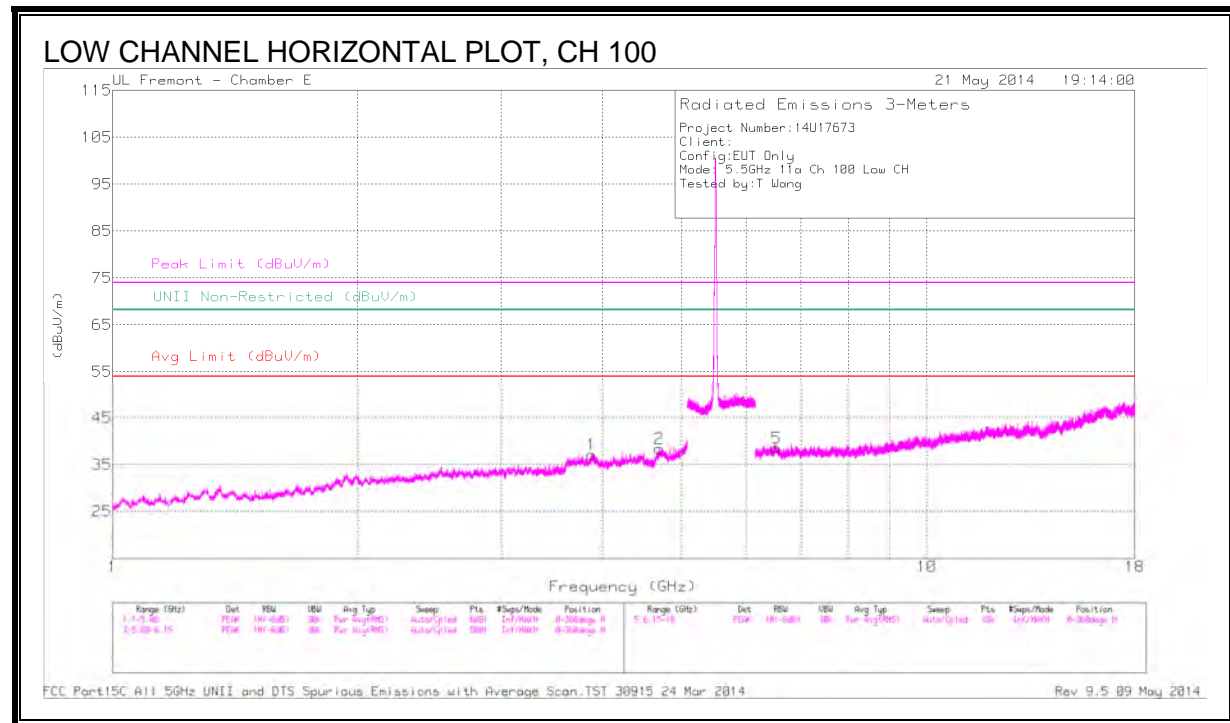

DATA

Frequency (GHz)	Meter Reading (dBuV)	Det	AF T346 (dB/m)	Amp/Cb/Filtr /Pad (dB)	Corrected Reading (dBuV/m)	Avg Limit (dBuV/m)	Margin (dB)	Peak Limit (dBuV/m)	PK Margin (dB)	UNII Non-Restricted (dBuV/m)	PK Margin (dB)	Azimuth (Degs)	Height (cm)	Polarity
* 3.867	42.58	PK1	33.5	-30.7	45.38	-	-	74	-28.62	-	-	277	337	H
* 3.867	30.78	AD1	33.5	-30.7	33.58	54	-20.42	-	-	-	-	277	337	H
* 4.696	41.95	PK1	34.2	-29.8	46.35	-	-	74	-27.65	-	-	247	337	H
* 4.699	30.81	AD1	34.2	-29.9	35.11	54	-18.89	-	-	-	-	247	337	H
* 4.699	42.06	PK1	34.2	-29.9	46.36	-	-	74	-27.64	-	-	31	207	V
* 4.7	30.52	AD1	34.2	-29.9	34.82	54	-19.18	-	-	-	-	31	207	V
* 3.878	41.98	PK1	33.5	-30.5	44.98	-	-	74	-29.02	-	-	18	256	V
* 3.87	30.72	AD1	33.5	-30.6	33.62	54	-20.38	-	-	-	-	18	256	V
6.495	27.95	AD1	35.6	-28.5	35.05	-	-	-	-	-	-	330	256	V
6.511	39.08	PK1	35.6	-27.8	46.88	-	-	-	-	68.2	-21.32	330	256	V
6.544	27.42	AD1	35.7	-27.7	35.42	-	-	-	-	-	-	190	170	H
6.548	38.7	PK1	35.7	-27.7	46.7	-	-	-	-	68.2	-21.5	190	170	H

* - indicates frequency in CFR15.205/IC7.2.2 Restricted Band

PK1 - KDB789033 Method: Peak

AD1 - KDB789033 Method: AD Primary Power Average

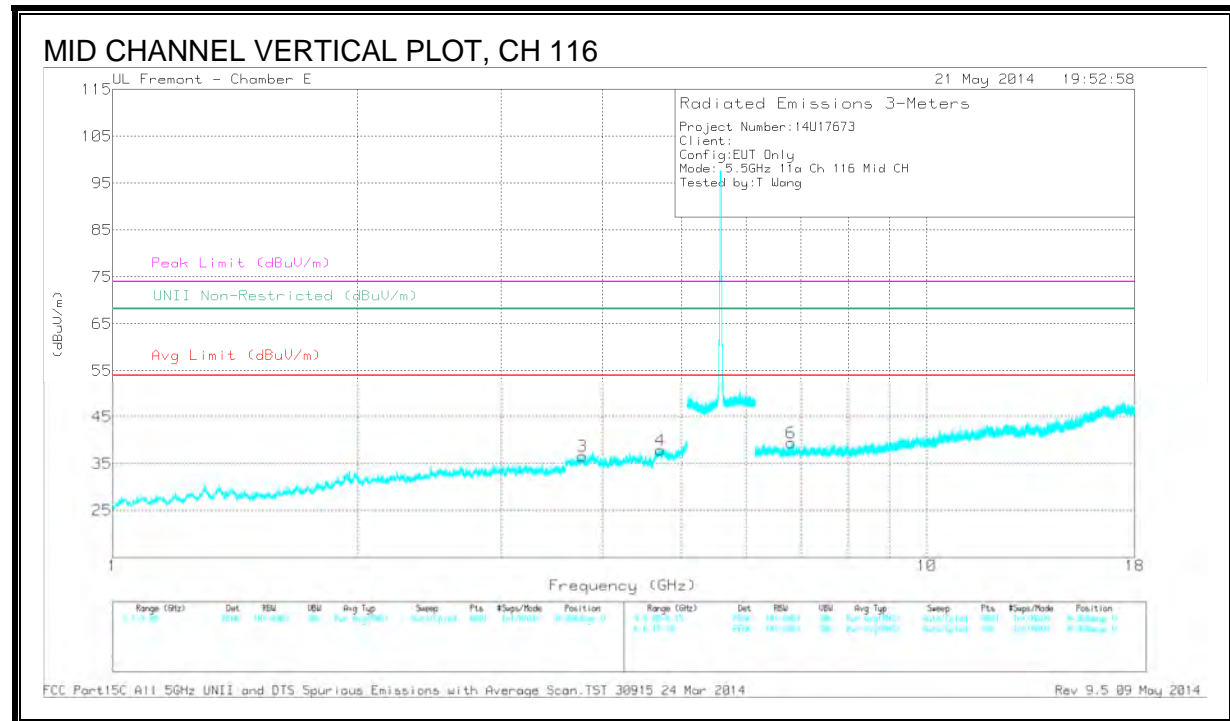
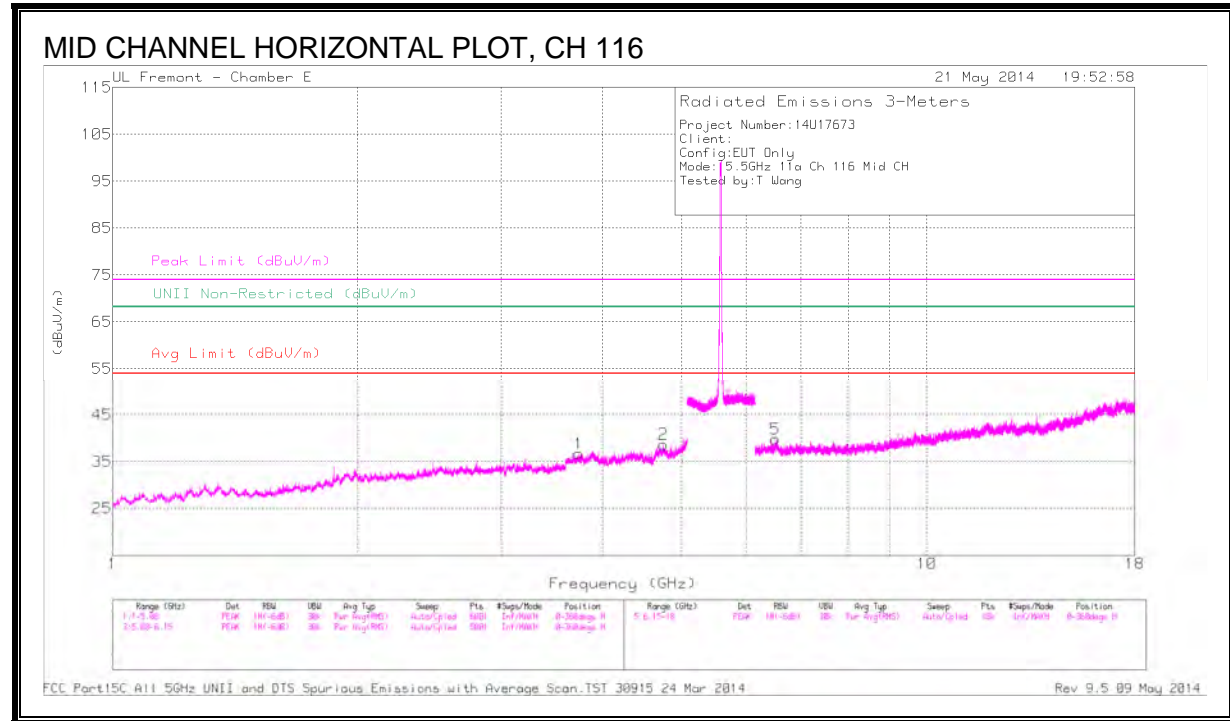

DATA

Frequency (GHz)	Meter Reading (dBuV)	Det	AF T346 (dB/m)	Amp/Cb/Filtr /Pad (dB)	Corrected Reading (dBuV/m)	Avg Limit (dBuV/m)	Margin (dB)	Peak Limit (dBuV/m)	PK Margin (dB)	UNII Non-Restricted (dBuV/m)	PK Margin (dB)	Azimuth (Degs)	Height (cm)	Polarity
* 3.742	43.07	PK1	33.4	-31.9	44.57	-	-	74	-29.43	-	-	291	179	H
* 3.727	31.59	AD1	33.4	-31.8	33.19	54	-20.81	-	-	-	-	291	179	H
* 4.698	42.5	PK1	34.2	-29.9	46.8	-	-	74	-27.2	-	-	269	183	H
* 4.699	30.96	AD1	34.2	-29.9	35.26	54	-18.74	-	-	-	-	269	183	H
* 4.708	42.25	PK1	34.2	-30.2	46.25	-	-	74	-27.75	-	-	33	134	V
* 4.711	30.78	AD1	34.2	-30.3	34.68	54	-19.32	-	-	-	-	33	134	V
* 3.78	42.87	PK1	33.4	-31.9	44.37	-	-	74	-29.63	-	-	45	134	V
* 3.769	32	AD1	33.4	-31.9	33.5	54	-20.5	-	-	-	-	45	134	V
6.502	39.39	PK1	35.6	-28.1	46.89	-	-	-	-	68.2	-21.31	122	242	H
6.502	28.19	AD1	35.6	-28.1	35.69	-	-	-	-	-	-	122	242	H
6.818	39.69	PK1	35.9	-28.5	47.09	-	-	-	-	68.2	-21.11	81	359	V
6.821	28.08	AD1	35.9	-28.6	35.38	-	-	-	-	-	-	81	359	V

* - indicates frequency in CFR15.205/IC7.2.2 Restricted Band

PK1 - KDB789033 Method: Peak

AD1 - KDB789033 Method: AD Primary Power Average

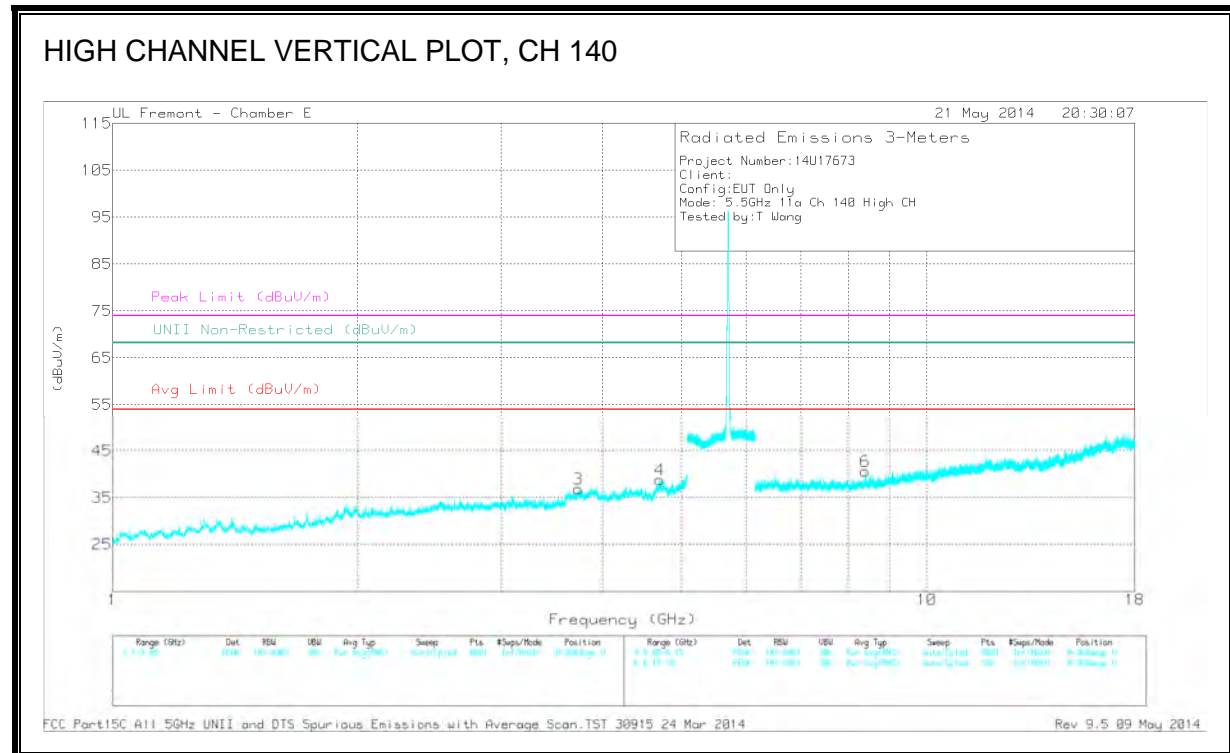
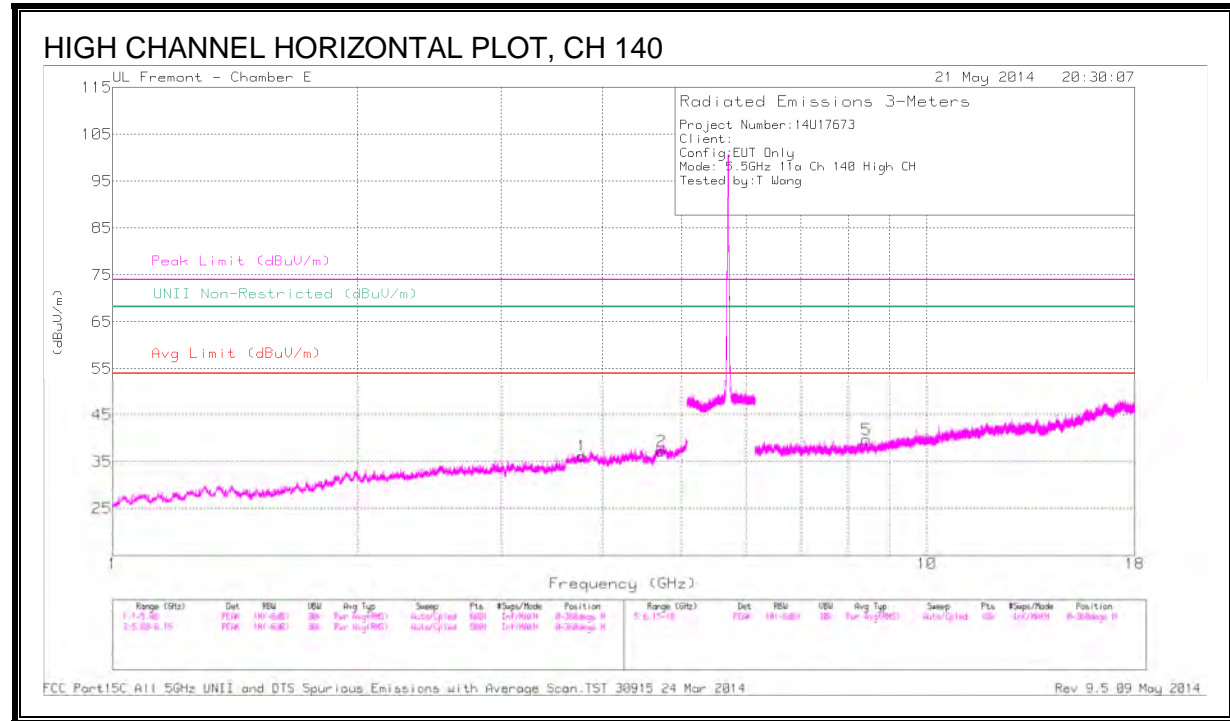

DATA

Frequency (GHz)	Meter Reading (dBuV)	Det	AF T346 (dB/m)	Amp/Cb/Filtr /Pad (dB)	Corrected Reading (dBuV/m)	Avg Limit (dBuV/m)	Margin (dB)	Peak Limit (dBuV/m)	PK Margin (dB)	UNII Non-Restricted (dBuV/m)	PK Margin (dB)	Azimuth (Degs)	Height (cm)	Polarity
* 3.772	43.09	PK1	33.4	-31.9	44.59	-	-	74	-29.41	-	-	291	179	H
* 3.771	32.59	AD1	33.4	-31.8	34.19	54	-19.81	-	-	-	-	291	179	H
* 4.718	42.52	PK1	34.2	-29.9	46.82	-	-	74	-27.0	-	-	269	183	H
* 4.720	31.96	AD1	34.2	-29.9	36.26	54	-17.74	-	-	-	-	269	183	H
* 4.698	42.27	PK1	34.2	-30.2	46.27	-	-	74	-27.73	-	-	33	134	V
* 4.701	30.79	AD1	34.2	-30.3	34.69	54	-19.33	-	-	-	-	33	134	V
* 3.775	42.85	PK1	33.4	-31.9	44.35	-	-	74	-29.65	-	-	45	134	V
* 3.772	32.2	AD1	33.4	-31.9	33.7	54	-20.7	-	-	-	-	45	134	V
* 8.427	38.55	PK1	35.9	-27	47.45	-	-	74	-26.55	-	-	171	342	H
* 8.429	26.89	AD1	35.9	-27	35.79	54	-18.21	-	-	-	-	171	342	H
* 8.402	38.41	PK1	35.9	-26.9	47.41	-	-	74	-26.59	-	-	256	140	V
* 8.404	27.11	AD1	35.9	-26.9	36.11	54	-17.89	-	-	-	-	256	140	V

* - indicates frequency in CFR15.205/IC7.2.2 Restricted Band

PK1 - KDB789033 Method: Peak

AD1 - KDB789033 Method: AD Primary Power Average

10.2.10. TX ABOVE 1 GHz 802.11n HT20 MODE IN THE 5.6 GHz BAND

RESTRICTED & AUTHORIZED BANDEDGE (LOW CHANNEL)

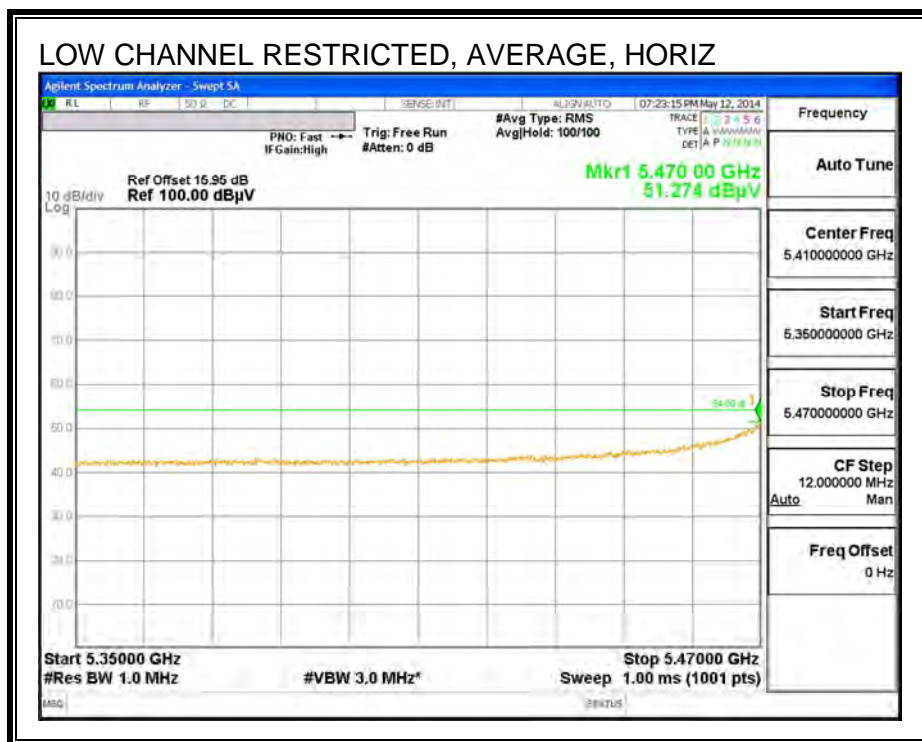
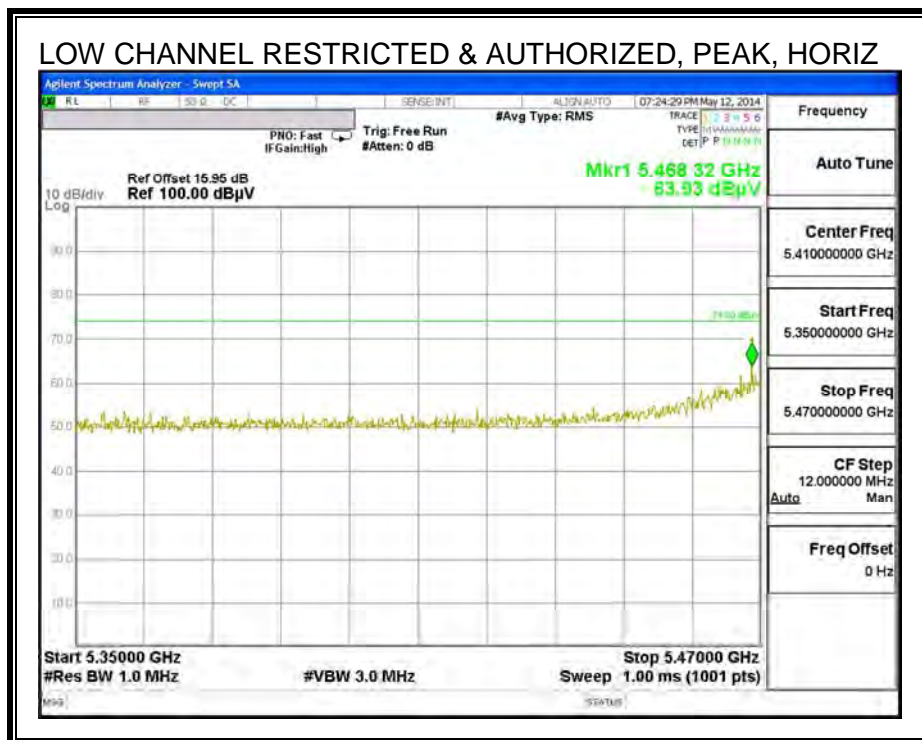

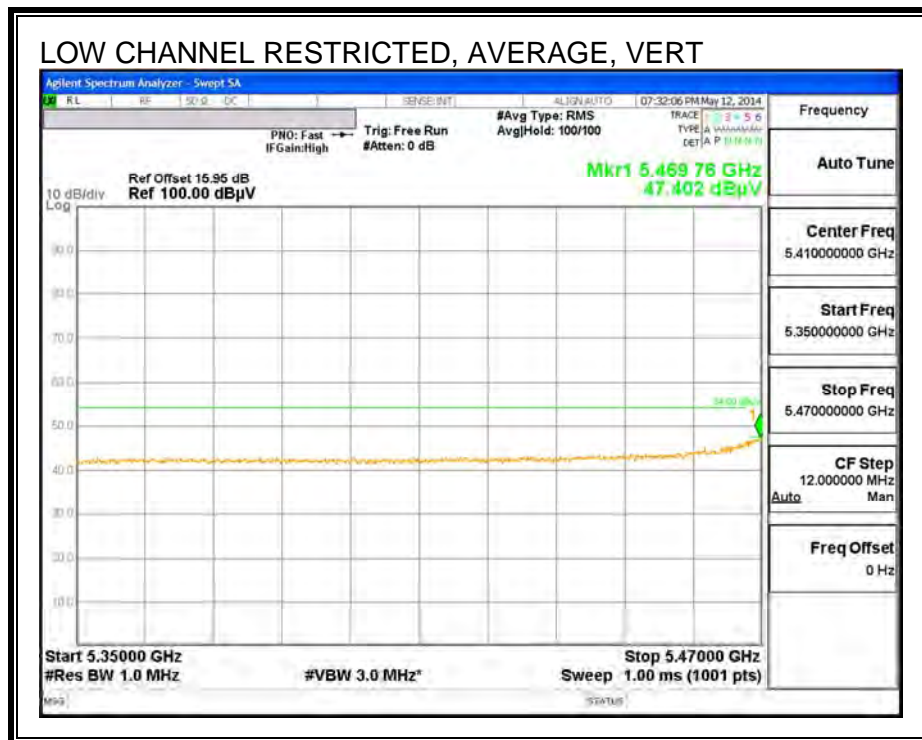
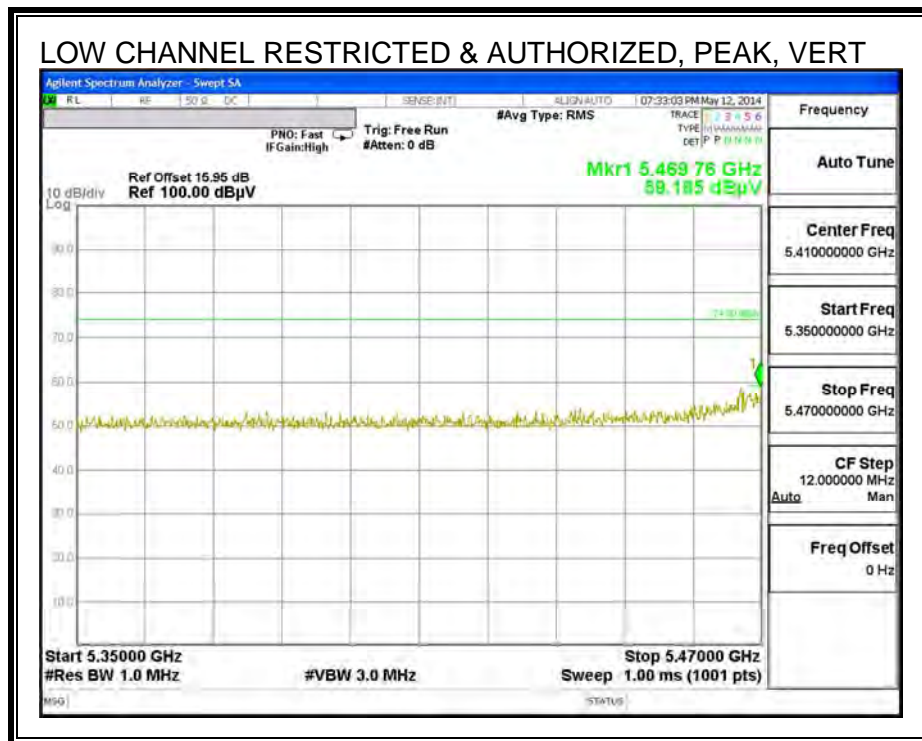

AUTHORIZED BANDEDGE (HIGH CHANNEL)

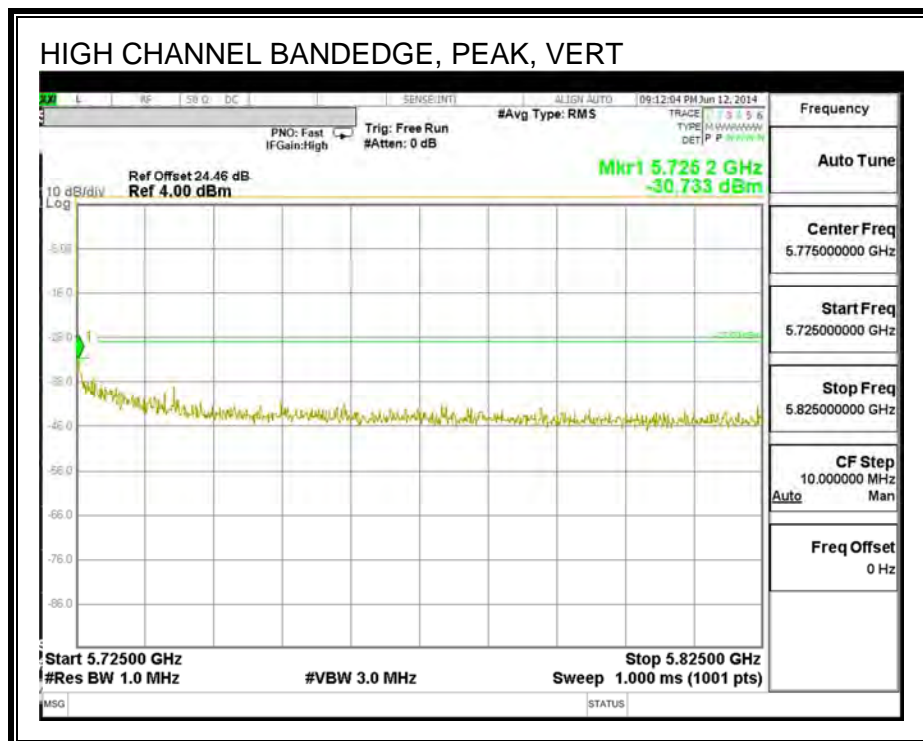
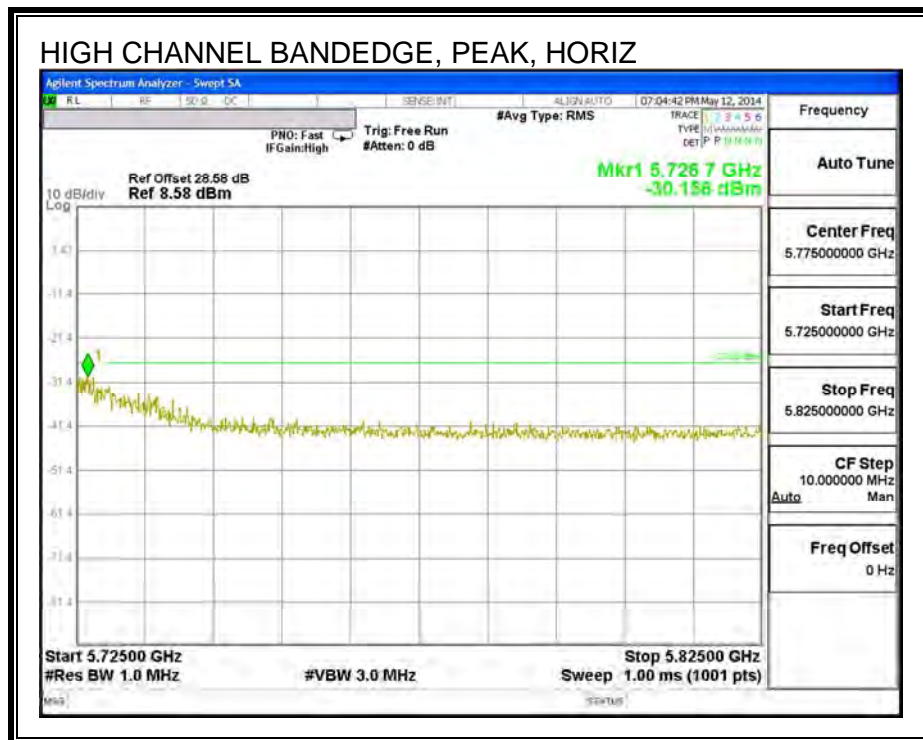

HARMONICS AND SPURIOUS EMISSIONS

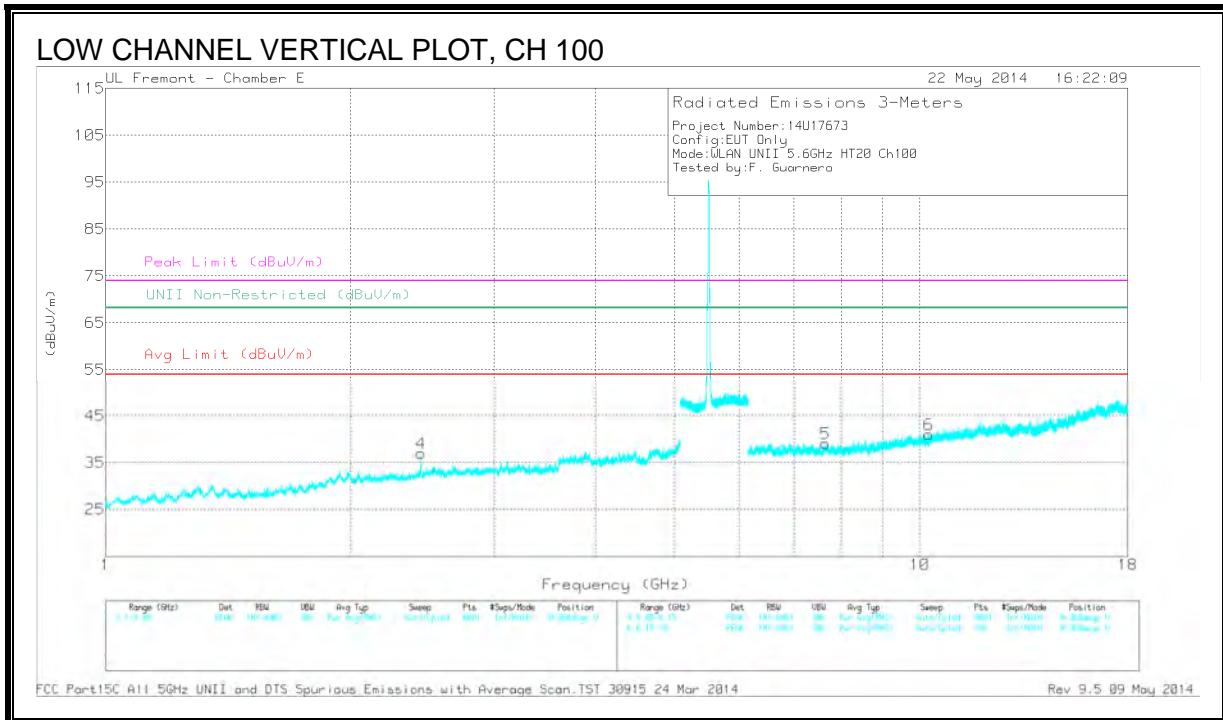
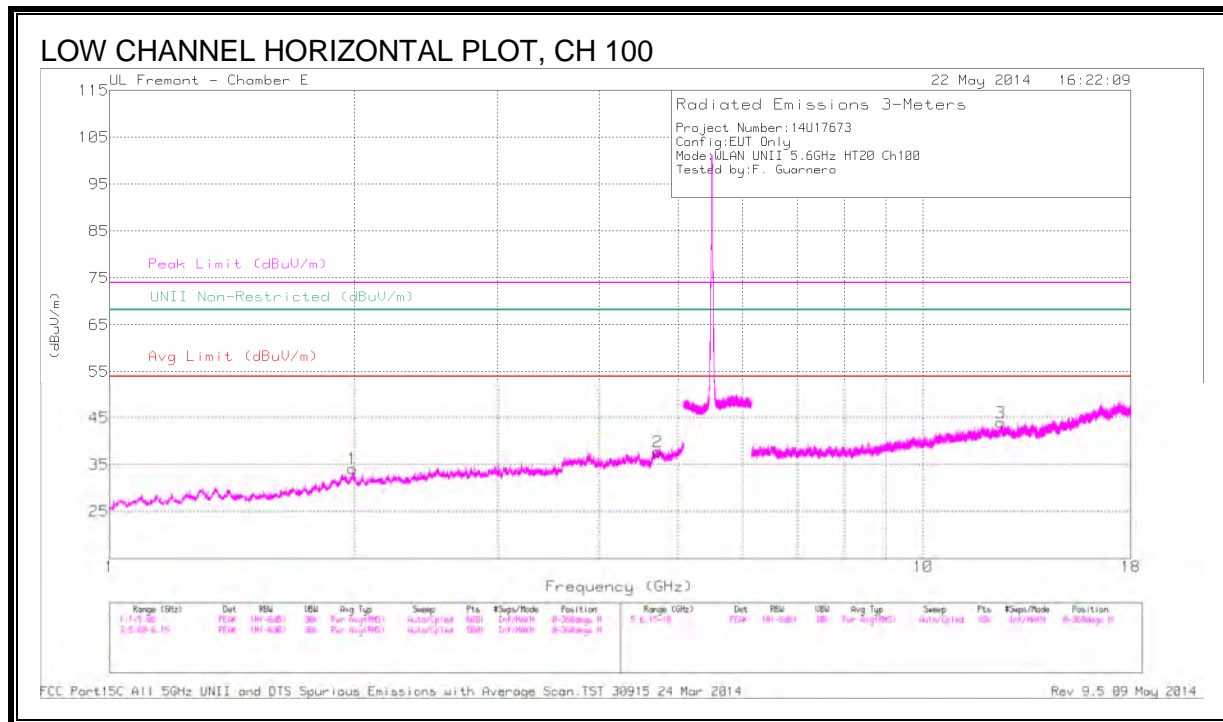

DATA

Frequency (GHz)	Meter Reading (dBuV)	Det	AF T346 (dB/m)	Amp/Cb1/Fitr /Pad (dB)	Corrected Reading (dBuV/m)	Avg Limit (dBuV/m)	Margin (dB)	Peak Limit (dBuV/m)	PK Margin (dB)	UNII Non-Restricted (dBuV/m)	PK Margin (dB)	Azimuth (Degs)	Height (cm)	Polarity
* 4.718	41.3	PK1	34.2	-30.5	45	-	-	74	-29	-	-	360	101	H
* 4.718	30.06	AD1	34.2	-30.5	33.76	54	-20.24	-	-	-	-	360	101	H
* 12.457	36.78	PK1	38.9	-23.6	52.08	-	-	74	-21.92	-	-	360	101	H
* 12.457	25.26	AD1	38.9	-23.6	40.56	54	-13.44	-	-	-	-	360	101	H
* 7.653	38.77	PK1	35.8	-27.3	47.27	-	-	74	-26.73	-	-	360	101	V
* 7.653	27.75	AD1	35.8	-27.3	36.25	54	-17.75	-	-	-	-	360	101	V
1.989	44.38	PK1	31.3	-32.6	43.08	-	-	-	-	68.2	-25.12	360	101	H
2.44	42.47	PK1	32.2	-33.1	41.57	-	-	-	-	68.2	-26.63	360	101	V
10.253	37.05	PK1	37.2	-25.2	49.05	-	-	-	-	68.2	-19.15	360	101	V

* - indicates frequency in CFR15.205/IC7.2.2 Restricted Band

PK1 - KDB789033 Method: Peak

AD1 - KDB789033 Method: AD Primary Power Average

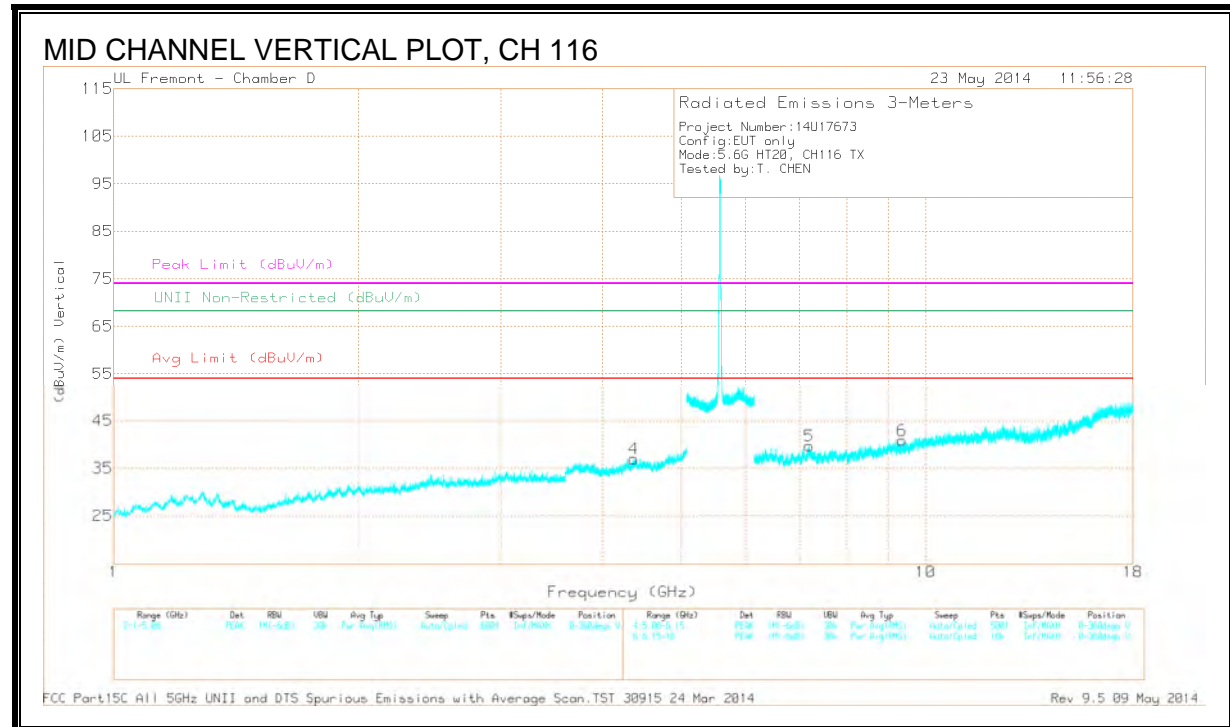
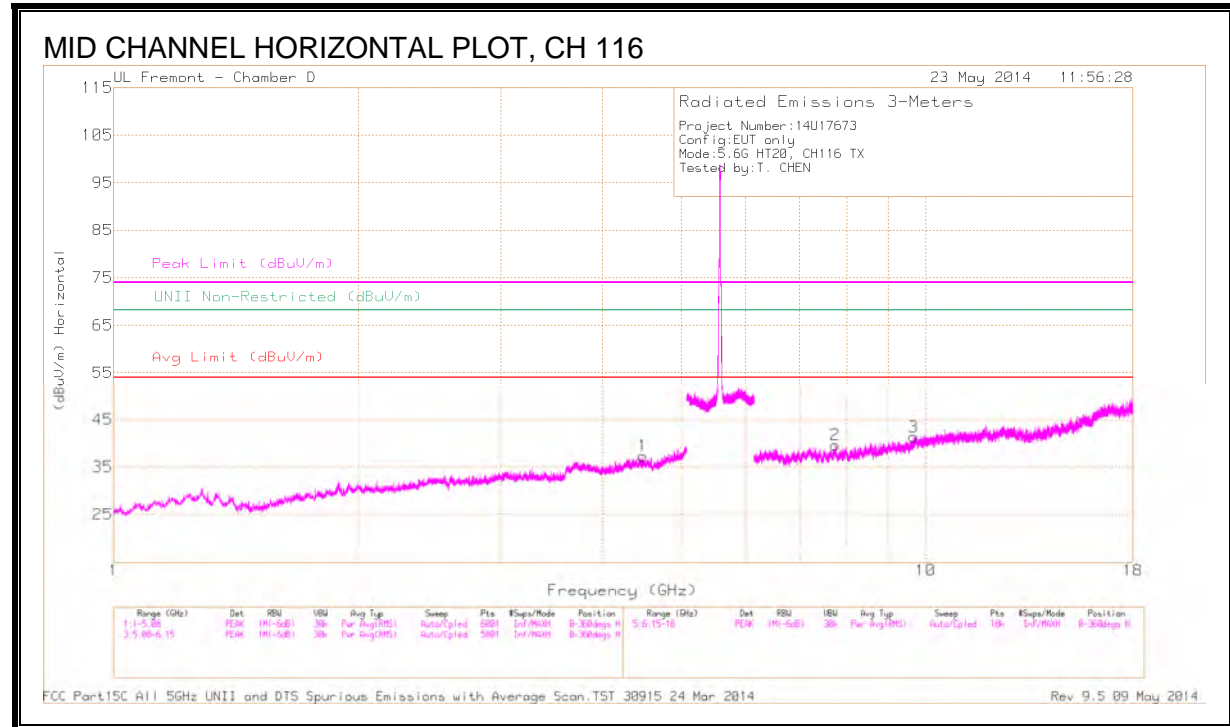

DATA

Marker	Frequency (GHz)	Meter Reading (dBuV)	Det	AF T712 (dB/m)	Amp/Cbl/Fltr/ Pad (dB)	Corrected Reading (dBuV/m)	Avg Limit (dBuV/m)	Margin (dB)	Peak Limit (dBuV/m)	PK Margin (dB)	UNII Non-Restricted (dBuV/m)	PK Margin (dB)	Azimuth (Degs)	Height (cm)	Polarity
4	* 4.368	37.73	PK1	33.2	-28.1	42.83	-	-	74	-31.17	-	-	202	100	V
	* 4.378	26.74	AD1	33.2	-27.9	32.04	54	-21.96	-	-	-	-	202	100	V
2	* 7.749	36.55	PK1	35.1	-24	47.65	-	-	74	-26.35	-	-	360	202	H
	* 7.745	24.45	AD1	35.1	-24.1	35.45	54	-18.55	-	-	-	-	360	202	H
6	* 9.362	34.88	PK1	36	-23.1	47.78	-	-	74	-26.22	-	-	148	100	V
	* 9.361	23.39	AD1	36	-23	36.39	54	-17.61	-	-	-	-	148	100	V
1	4.488	38.11	PK1	33.5	-27.1	44.51	-	-	-	-	68.2	-23.69	266	202	H
	4.483	26.66	AD1	33.5	-27.2	32.96	-	-	-	-	-	-	266	202	H
5	7.186	35.74	PK1	35.1	-24	46.84	-	-	-	-	68.2	-21.36	210	202	V
	7.194	24.72	AD1	35.1	-23.8	36.02	-	-	-	-	-	-	210	202	V
3	9.661	34.9	PK1	36.3	-22.2	49	-	-	-	-	68.2	-19.2	71	202	H
	9.668	22.7	AD1	36.3	-22	37	-	-	-	-	-	-	71	202	H

* - indicates frequency in CFR15.205/IC7.2.2 Restricted Band

PK1 - KDB789033 Method: Peak

AD1 - KDB789033 Method: AD Primary Power Average

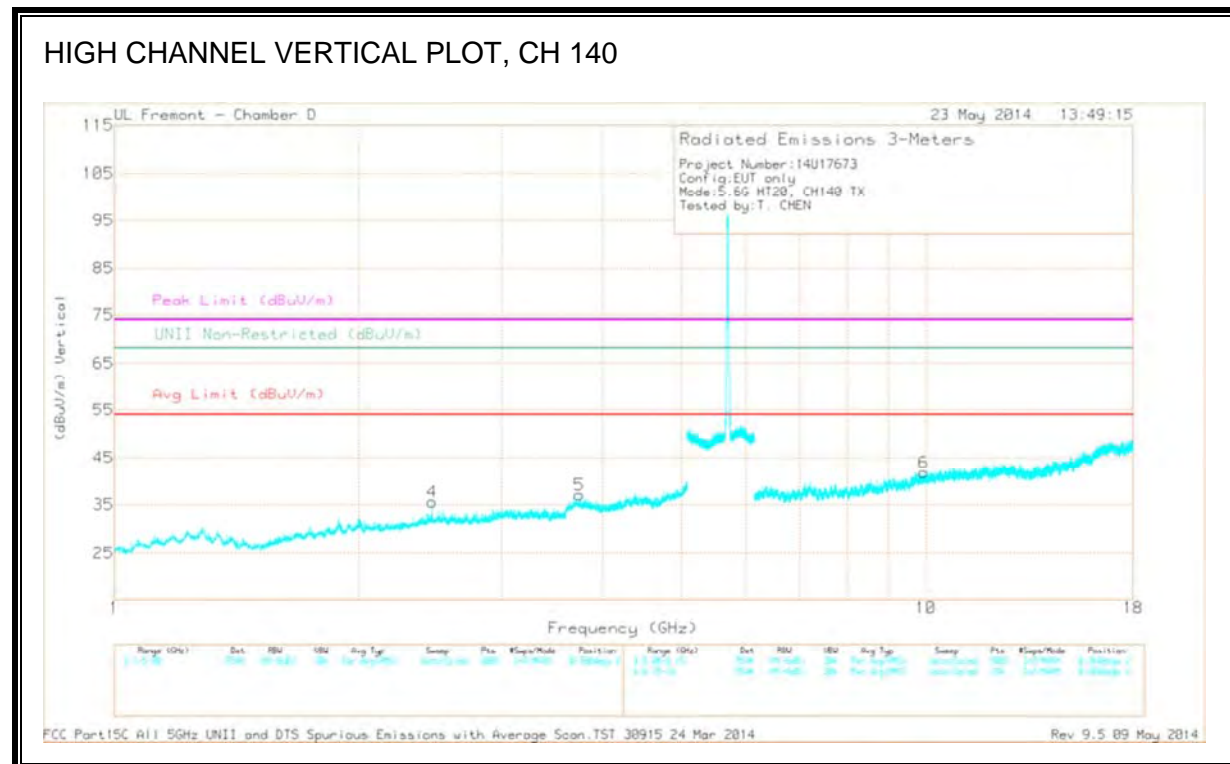
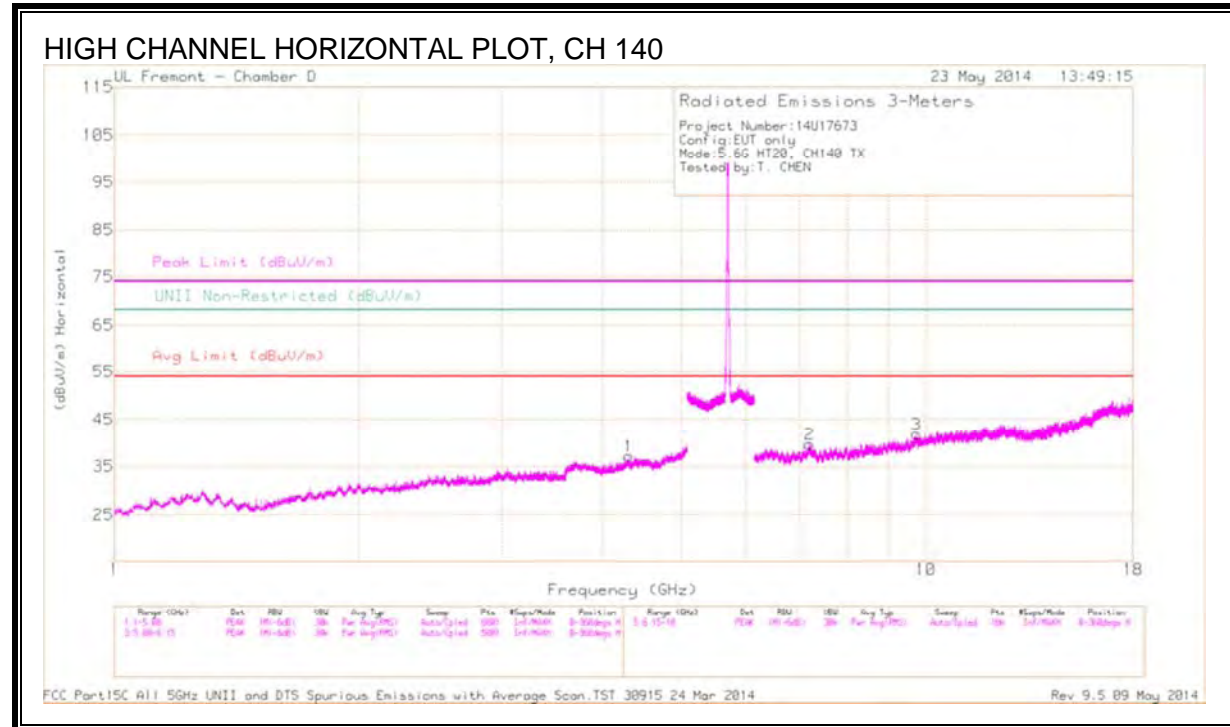

DATA

Frequency (GHz)	Meter Reading (dBuV)	Det	AF T712 (dB/m)	Amp/Cb/Filtr /Pad (dB)	Corrected Reading (dBuV/m)	Avg Limit (dBuV/m)	Margin (dB)	Peak Limit (dBuV/m)	PK Margin (dB)	UNII Non-Restricted (dBuV/m)	PK Margin (dB)	Azimuth (Degs)	Height (cm)	Polarity
* 4.304	39.02	PK1	33	-27.8	44.22	-	-	74	-29.78	-	-	287	202	H
* 4.304	26.65	AD1	33	-27.8	31.85	54	-22.15	-	-	-	-	287	202	H
* 3.739	38.85	PK1	32.7	-28.8	42.75	-	-	74	-31.25	-	-	239	202	V
* 3.74	27.2	AD1	32.7	-28.8	31.1	54	-22.9	-	-	-	-	239	202	V
2.462	39.54	PK1	32	-29.8	41.74	-	-	-	-	68.2	-26.46	183	211	V
2.461	27.27	AD1	31.9	-29.8	29.37	-	-	-	-	-	-	183	211	V
7.191	24.87	AD1	35.1	-23.8	36.17	-	-	-	-	-	-	58	201	H
7.192	36.45	PK1	35.1	-23.8	47.75	-	-	-	-	68.2	-20.45	58	201	H
9.737	23.05	AD1	36.4	-21.4	38.05	-	-	-	-	-	-	355	201	H
9.741	35.17	PK1	36.4	-21.5	50.07	-	-	-	-	68.2	-18.13	355	201	H
9.944	34.18	PK1	36.7	-21.8	49.08	-	-	-	-	68.2	-19.12	92	100	V
9.945	22.84	AD1	36.7	-21.8	37.74	-	-	-	-	-	-	92	100	V

* - indicates frequency in CFR15.205/IC7.2.2 Restricted Band

PK1 - KDB789033 Method: Peak

AD1 - KDB789033 Method: AD Primary Power Average

10.2.11. TX ABOVE 1 GHz 802.11n HT20 MODE, CHANNEL 144, 5.6 GHz BAND

HARMONICS AND SPURIOUS EMISSIONS

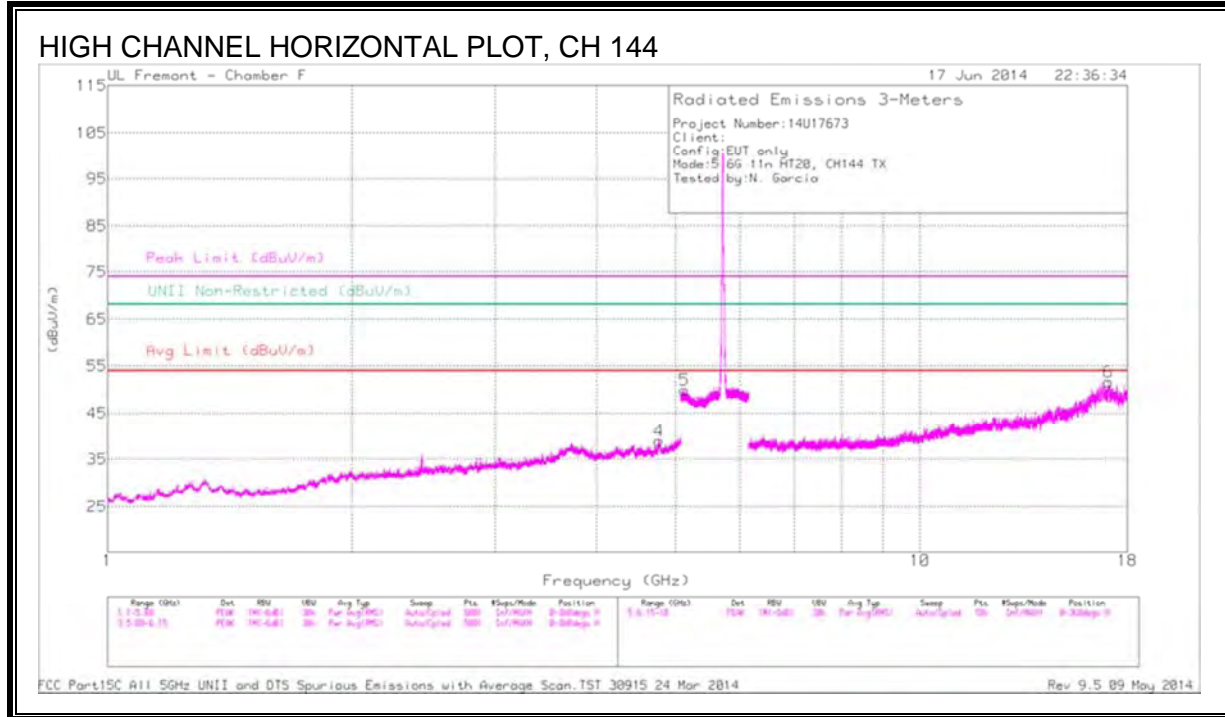

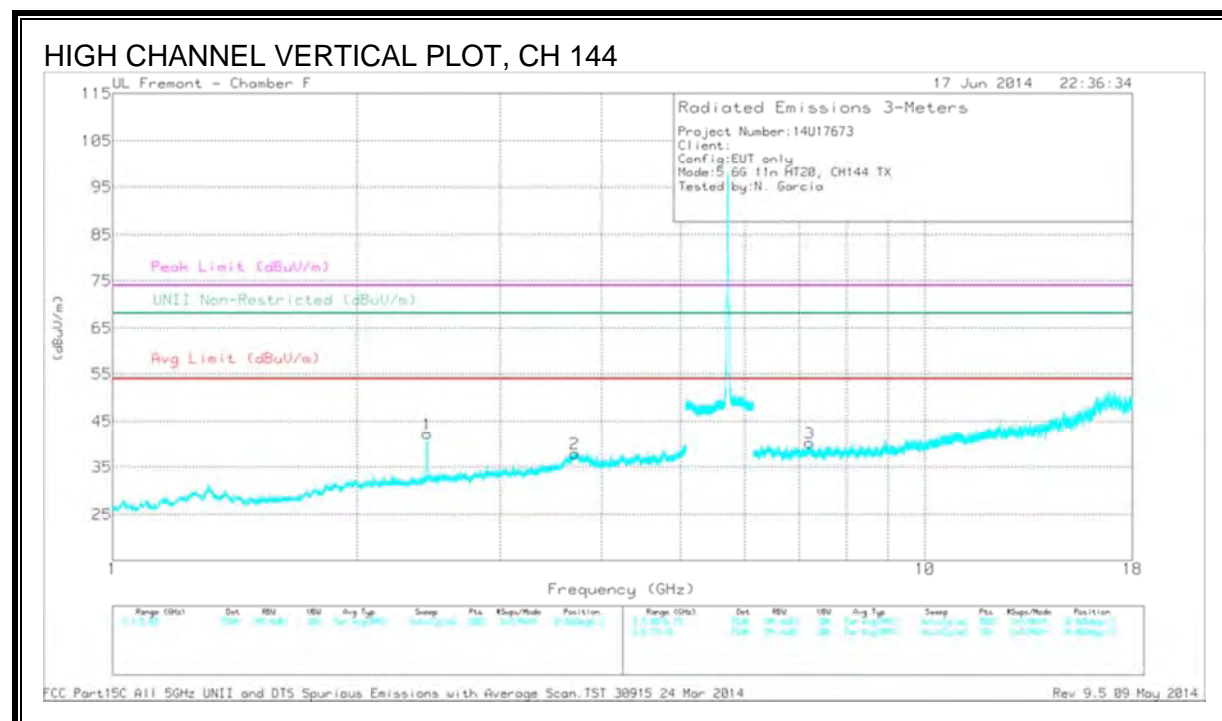

DATA

Frequency (GHz)	Meter Reading (dBuV)	Det	AF T120 (dB/m)	Amp/Cb/Filter/Pad (dB)	Corrected Reading (dBuV/m)	Avg Limit (dBuV/m)	Margin (dB)	Peak Limit (dBuV/m)	PK Margin (dB)	UNII Non-Restricted (dBuV/m)	PK Margin (dB)	Azimuth (Degs)	Height (cm)	Polarity
* 4.77	38.62	PK1	34.1	-27.3	45.42	-	-	74	-28.58	-	-	34	337	H
* 4.767	27.55	AD1	34.1	-27.3	34.35	54	-19.65	-	-	-	-	34	337	H
2.435	44.68	PK1	32.4	-30.9	46.18	-	-	-	-	68.2	-22.02	104	368	V
* 3.706	38.78	PK1	34.8	-29.1	44.48	-	-	74	-29.52	-	-	220	381	V
* 3.714	27.66	AD1	34.8	-29.1	33.36	54	-20.64	-	-	-	-	220	381	V
* 5.126	42.23	PK1	34.4	-19.3	57.33	-	-	74	-16.67	-	-	15	366	H
* 5.128	30.71	AD1	34.4	-19.3	45.81	54	-8.19	-	-	-	-	15	366	H
17.057	35.72	PK1	41.2	-16.5	60.42	-	-	-	-	68.2	-7.78	291	145	H
7.21	37.7	PK1	35.5	-25.2	48	-	-	-	-	68.2	-20.2	268	242	V

* - indicates frequency in CFR15.205/IC7.2.2 Restricted Band

PK1 - KDB789033 Method: Peak

AD1 - KDB789033 Method: AD Primary Power Average

10.2.12. TX ABOVE 1 GHz 802.11n HT40 MODE IN THE 5.6 GHz BAND

RESTRICTED & AUTHORIZED BANDEDGE (LOW CHANNEL)

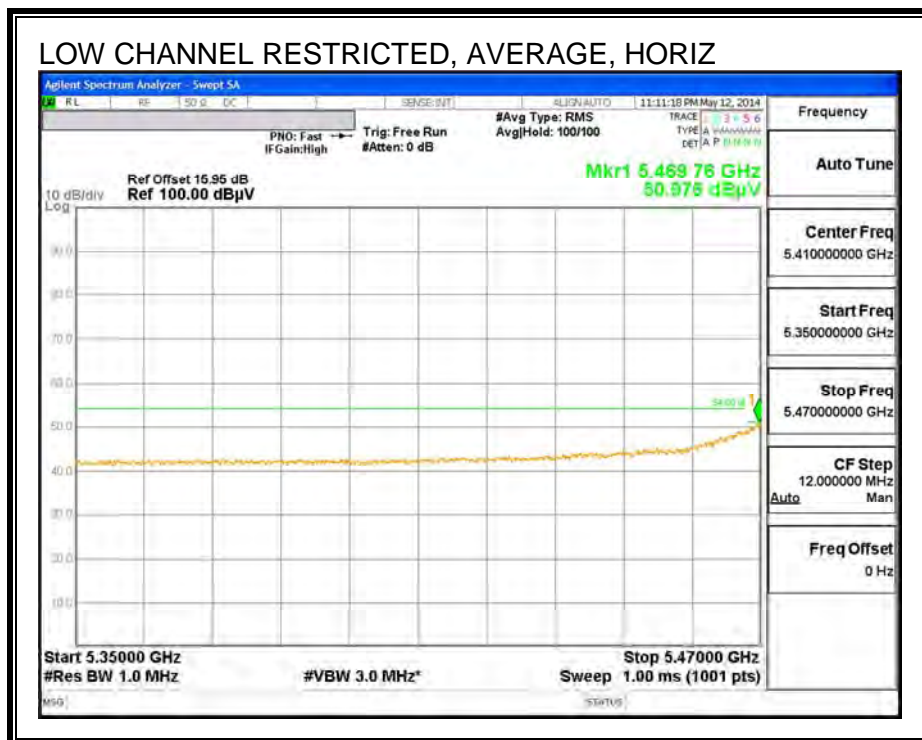
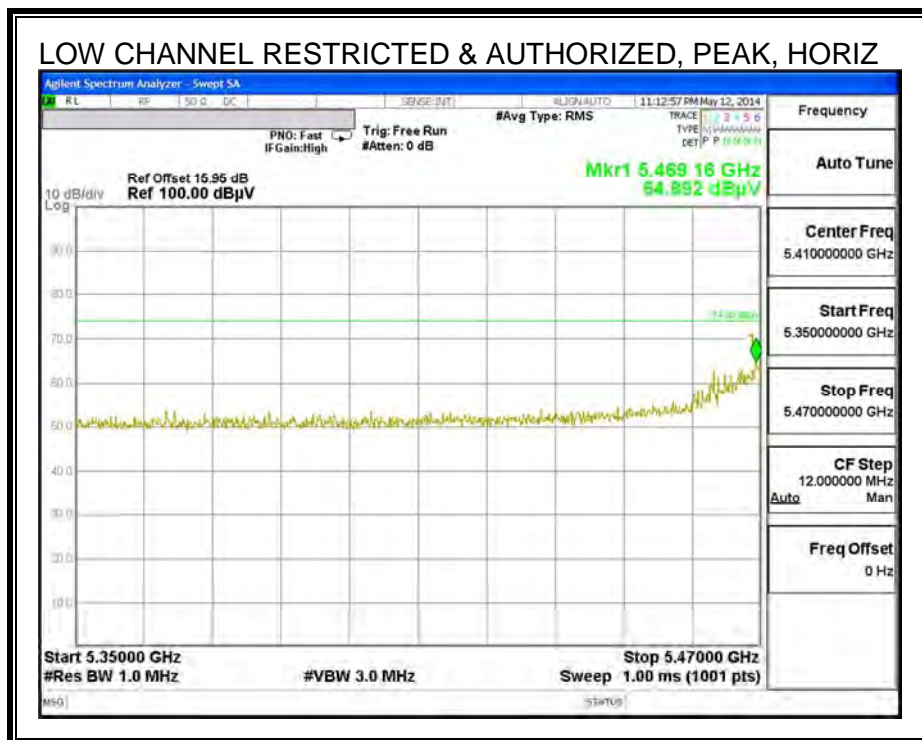

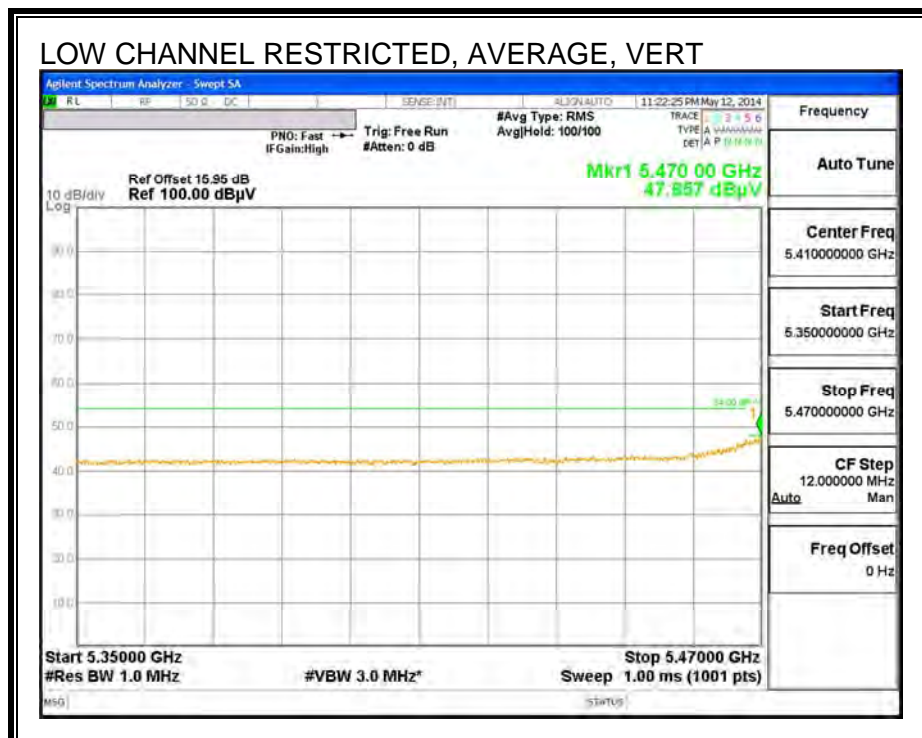
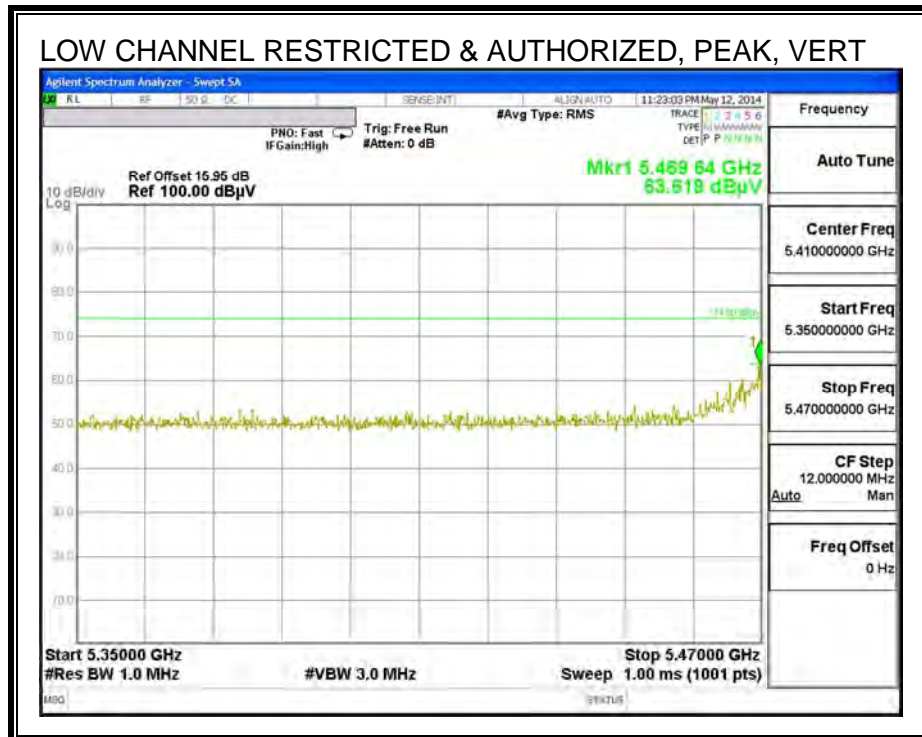

AUTHORIZED BANDEDGE (HIGH CHANNEL)

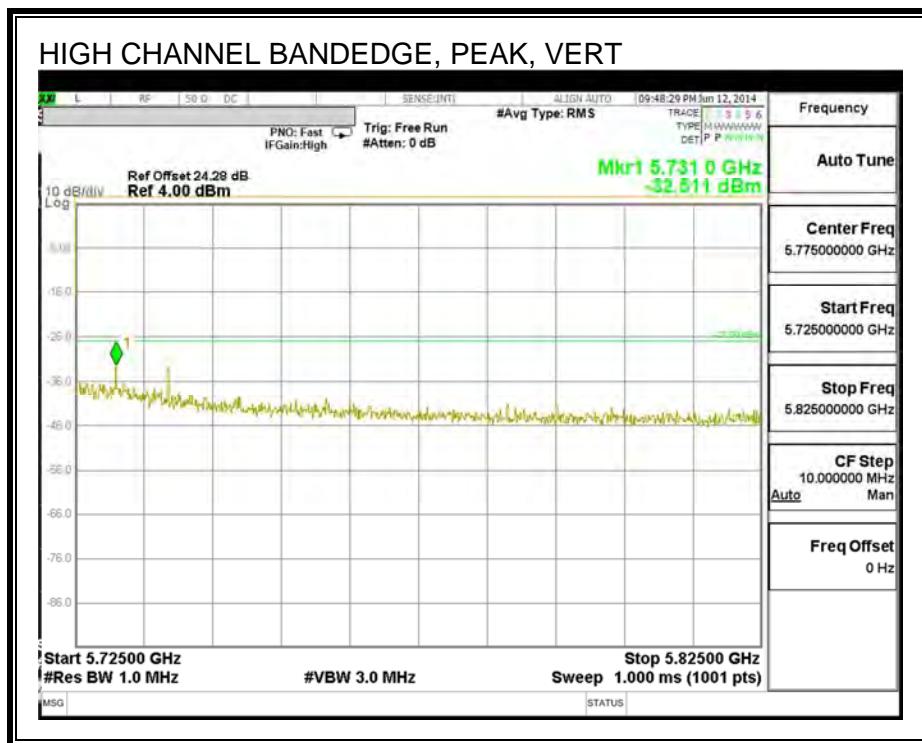
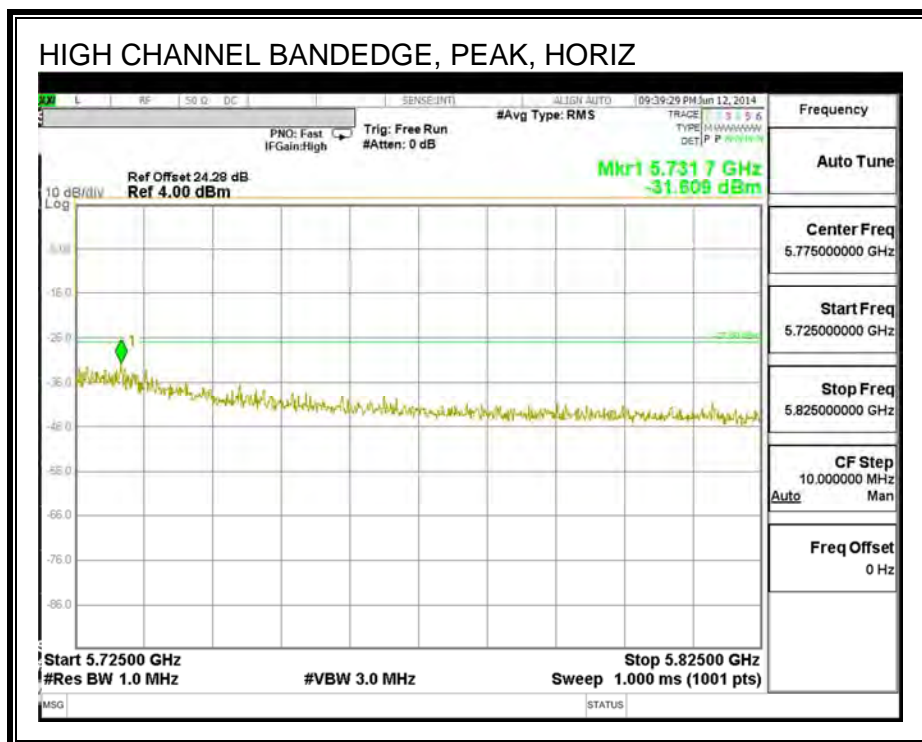

HARMONICS AND SPURIOUS EMISSIONS

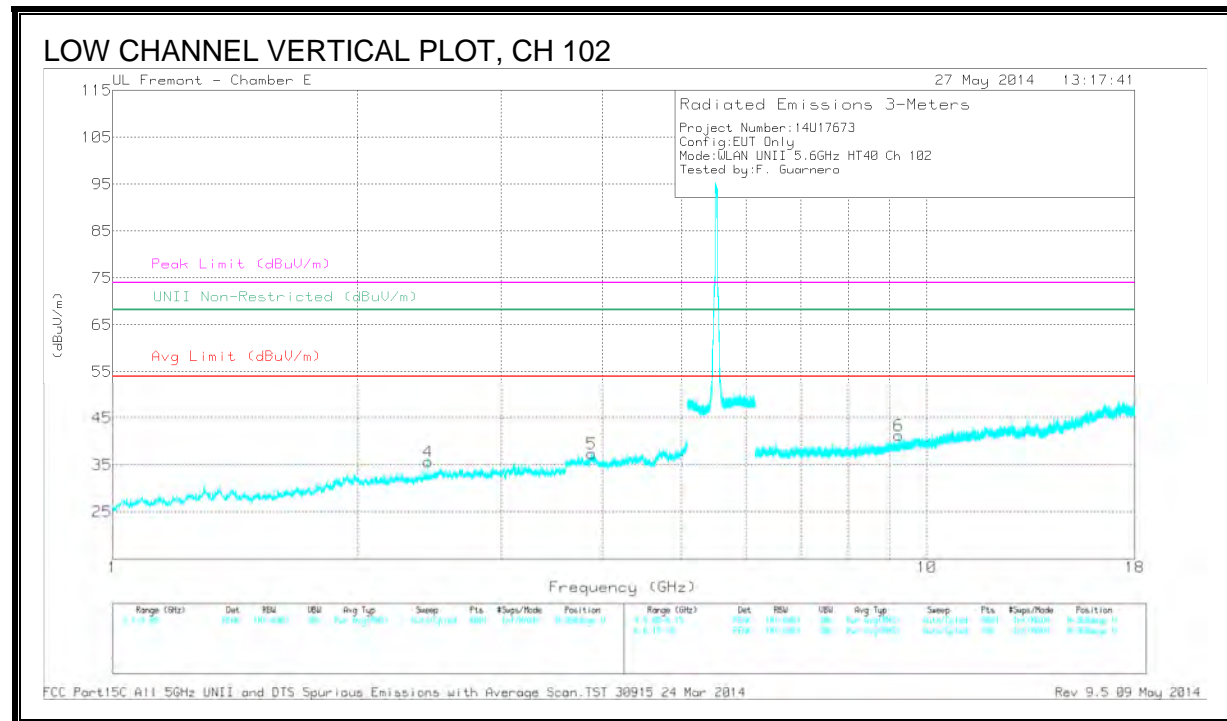
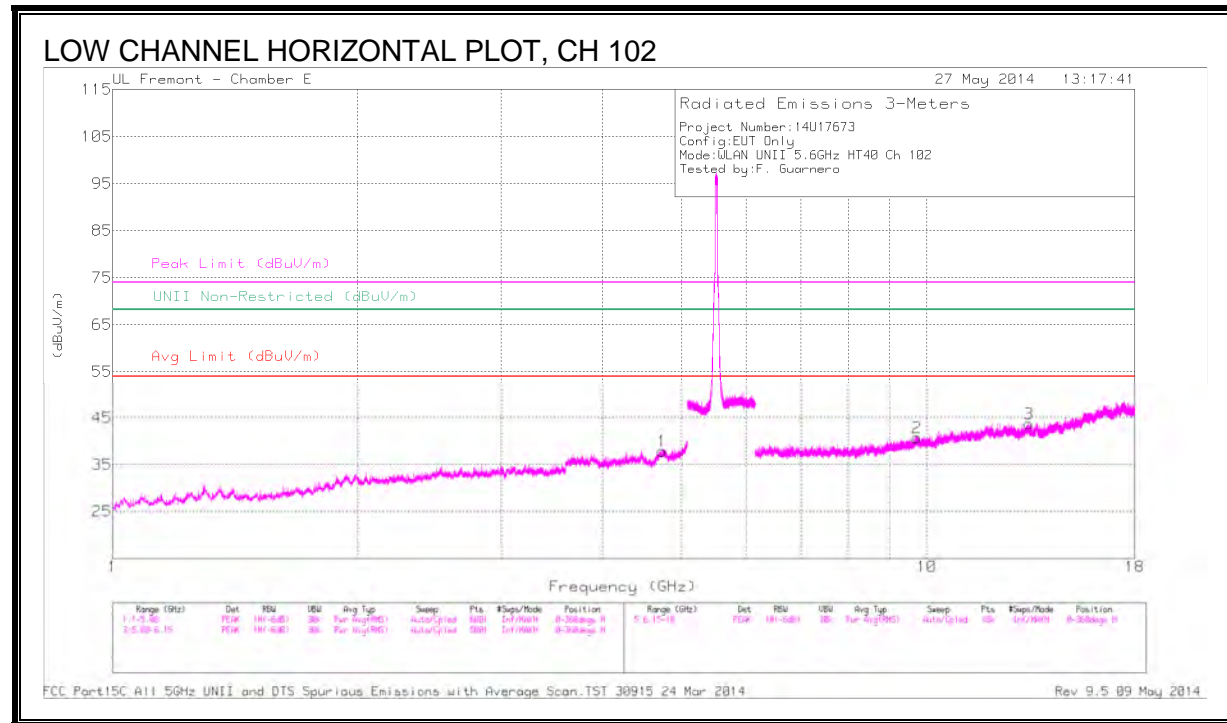

DATA

Frequency (GHz)	Meter Reading (dBuV)	Det	AF T346 (dB/m)	Amp/Cb/Filtr/ Pad (dB)	Corrected Reading (dBuV/m)	Avg Limit (dBuV/m)	Margin (dB)	Peak Limit (dBuV/m)	PK Margin (dB)	UNII Non-Restricted (dBuV/m)	PK Margin (dB)	Azimuth (Degs)	Height (cm)	Polarity
* 4.732	42.03	PK1	34.1	-30.6	45.53	-	-	74	-28.47	-	-	1	101	H
* 4.732	30.35	AD1	34.1	-30.6	33.85	54	-20.15	-	-	-	-	1	101	H
* 3.877	42.56	PK1	33.5	-30.5	45.56	-	-	74	-28.44	-	-	1	101	V
* 3.877	30.55	AD1	33.5	-30.5	33.55	54	-20.45	-	-	-	-	1	101	V
* 13.353	37.54	PK1	39.2	-24.5	52.24	-	-	74	-21.76	-	-	1	101	H
* 13.353	25.72	AD1	39.2	-24.5	40.42	54	-13.58	-	-	-	-	1	101	H
2.44	43	PK1	32.2	-33.1	42.1	-	-	-	-	68.2	-26.1	1	101	V
9.236	36.92	PK1	36.6	-25.5	48.02	-	-	-	-	68.2	-20.18	1	101	V
9.716	37.49	PK1	37.1	-24.7	49.89	-	-	-	-	68.2	-18.31	1	101	H

* - indicates frequency in CFR15.205/IC7.2.2 Restricted Band

PK1 - KDB789033 Method: Peak

AD1 - KDB789033 Method: AD Primary Power Average

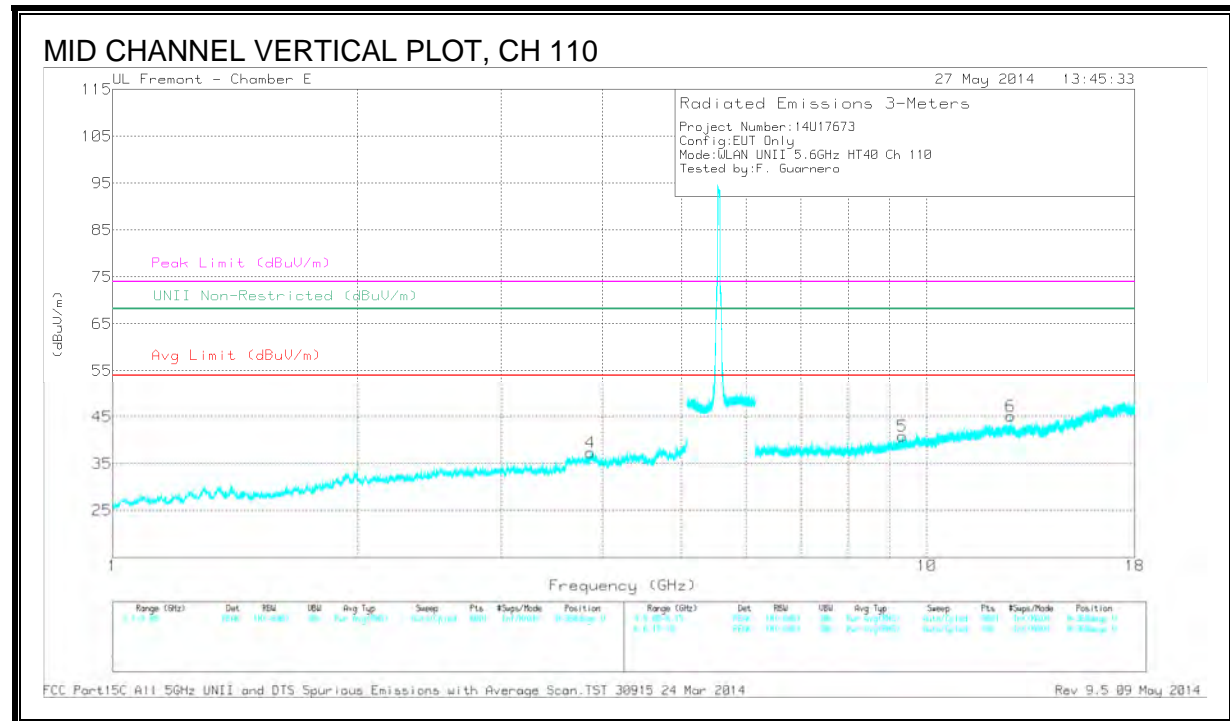
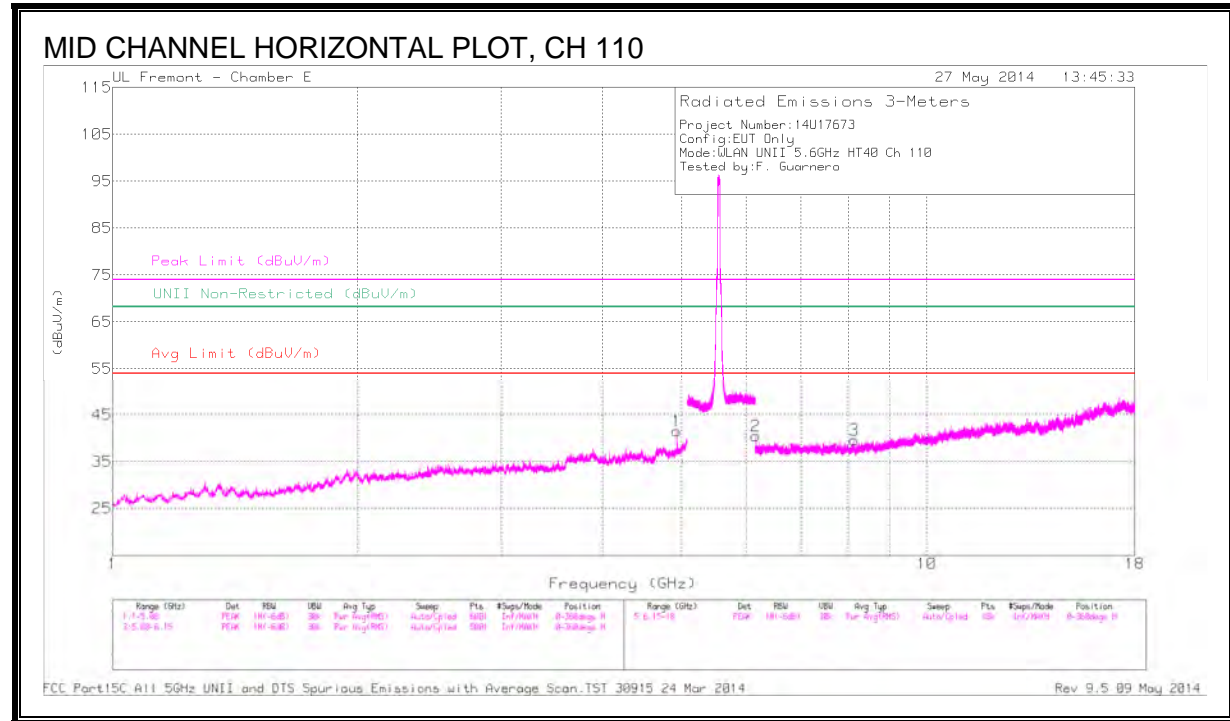

DATA

Frequency (GHz)	Meter Reading (dBuV)	Det	AF T346 (dB/m)	Amp/Cbl/Filtr /Pad (dB)	Corrected Reading (dBuV/m)	Avg Limit (dBuV/m)	Margin (dB)	Peak Limit (dBuV/m)	PK Margin (dB)	UNII Non-Restricted (dBuV/m)	PK Margin (dB)	Azimuth (Degs)	Height (cm)	Polarity
* 4.934	42.75	PK1	34.1	-29.7	47.15	-	-	74	-26.85	-	-	75	177	H
* 4.933	33.83	AD1	34.1	-29.7	38.23	54	-15.77	-	-	-	-	75	177	H
* 3.859	42.09	PK1	33.5	-30.9	44.69	-	-	74	-29.31	-	-	75	177	V
* 3.86	30.24	AD1	33.5	-30.9	32.84	54	-21.16	-	-	-	-	75	177	V
* 8.14	38.86	PK1	35.9	-27.5	47.26	-	-	74	-26.74	-	-	3	117	H
* 8.14	27.36	AD1	35.9	-27.5	35.76	54	-18.24	-	-	-	-	3	117	H
* 9.33	37.41	PK1	36.7	-25.3	48.81	-	-	74	-25.19	-	-	3	117	V
* 9.33	25.33	AD1	36.7	-25.3	36.73	54	-17.27	-	-	-	-	3	117	V
* 12.672	36.93	PK1	39.1	-24.4	51.63	-	-	74	-22.37	-	-	126	200	V
* 12.67	24.97	AD1	39.1	-24.5	39.57	54	-14.43	-	-	-	-	126	200	V
6.166	41.75	PK1	35.4	-29.4	47.75	-	-	-	-	68.2	-20.45	3	117	H

* - indicates frequency in CFR15.205/IC7.2.2 Restricted Band

PK1 - KDB789033 Method: Peak

AD1 - KDB789033 Method: AD Primary Power Average

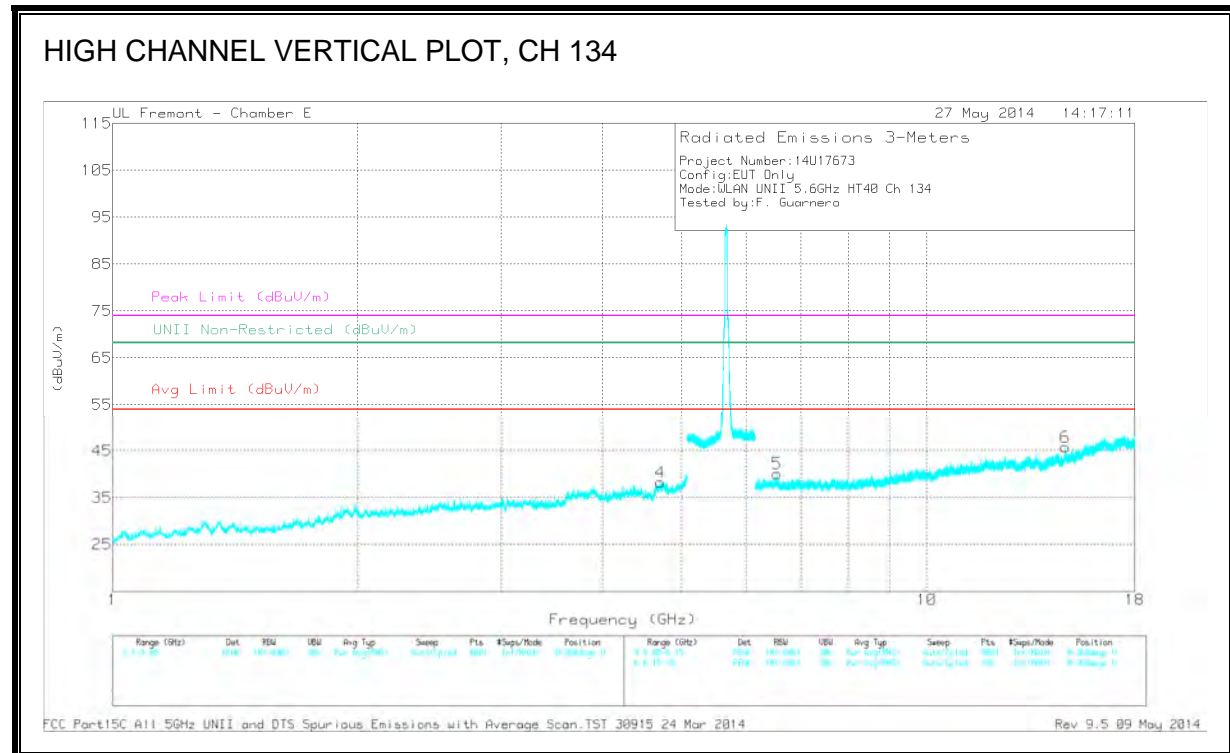
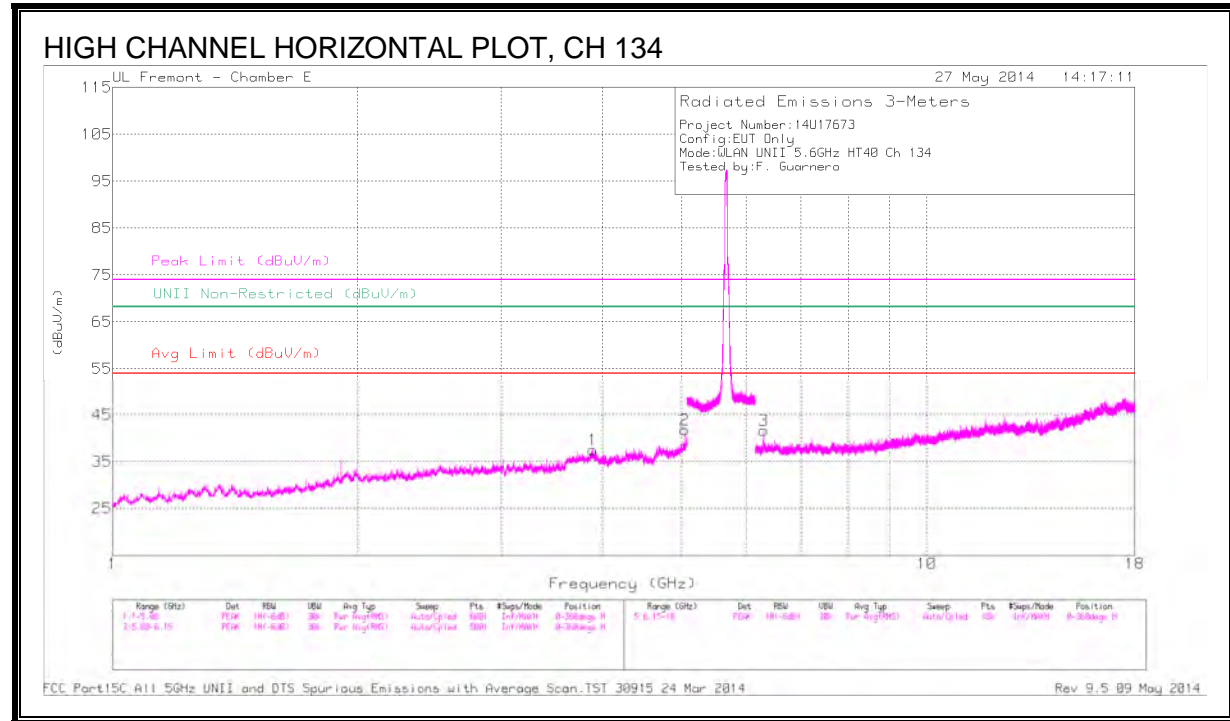

DATA

Frequency (GHz)	Meter Reading (dBuV)	Det	AF T346 (dB/m)	Amp/Cbl/Filtr /Pad (dB)	Corrected Reading (dBuV/m)	Avg Limit (dBuV/m)	Margin (dB)	Peak Limit (dBuV/m)	PK Margin (dB)	UNII Non-Restricted (dBuV/m)	PK Margin (dB)	Azimuth (Degs)	Height (cm)	Polarity
* 3.888	42.07	PK1	33.5	-30.4	45.17	-	-	74	-28.83	-	-	31	199	H
* 3.888	30.1	AD1	33.5	-30.4	33.2	54	-20.8	-	-	-	-	31	199	H
* 5.04	43.43	PK1	34.1	-28.9	48.63	-	-	74	-25.37	-	-	208	168	H
* 5.04	34.64	AD1	34.1	-28.9	39.84	54	-14.16	-	-	-	-	208	168	H
* 4.706	42.19	PK1	34.2	-30.1	46.29	-	-	74	-27.71	-	-	208	168	V
* 4.706	29.88	AD1	34.2	-30.1	33.98	54	-20.02	-	-	-	-	208	168	V
6.298	40.52	PK1	35.5	-29	47.02	-	-	-	-	68.2	-21.18	205	111	H
6.548	39.48	PK1	35.7	-27.7	47.48	-	-	-	-	68.2	-20.72	205	111	V
14.792	38.58	PK1	39.5	-24.5	53.58	-	-	-	-	68.2	-14.62	205	111	V

* - indicates frequency in CFR15.205/IC7.2.2 Restricted Band

PK1 - KDB789033 Method: Peak

AD1 - KDB789033 Method: AD Primary Power Average

10.2.13. TX ABOVE 1 GHz 802.11n HT40 MODE, CHANNEL 142, 5.6 GHz BAND

HARMONICS AND SPURIOUS EMISSIONS

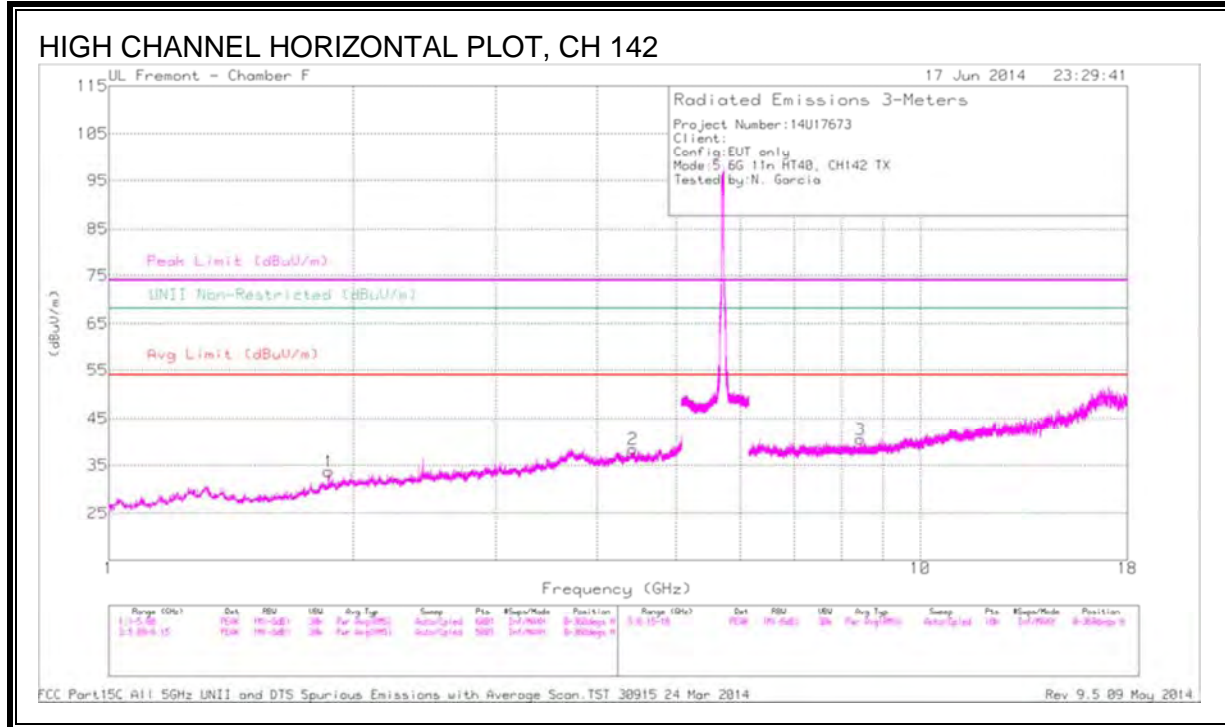

HIGH CHANNEL VERTICAL PLOT, CH 142

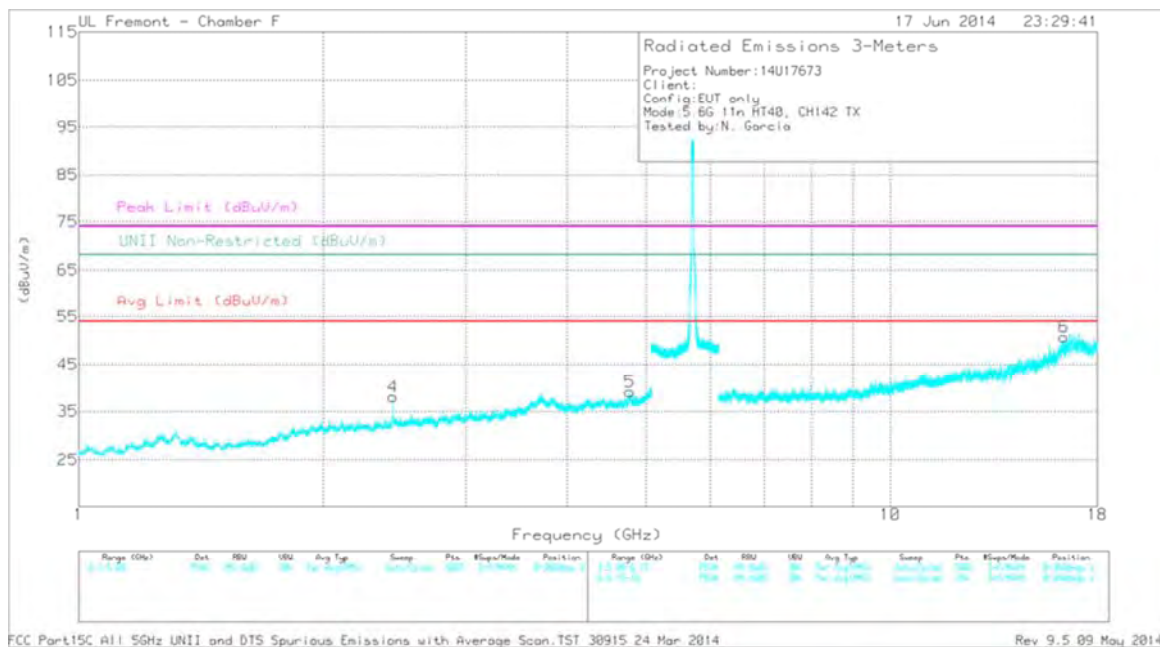

DATA

Frequency (GHz)	Meter Reading (dBuV)	Det	AF T120 (dB/m)	Amp/Cbl/Fit r/Pad (dB)	Corrected Reading (dBuV/m)	Avg Limit (dBuV/m)	Margin (dB)	Peak Limit (dBuV/m)	PK Margin (dB)	UNII Non-Restricted (dBuV/m)	PK Margin (dB)	Azimuth (Degs)	Height (cm)	Polarity
1.869	40.86	PK1	31.1	-31.6	40.36	-	-	-	-	68.2	-27.84	322	314	H
4.431	39.12	PK1	33.9	-27.2	45.82	-	-	-	-	68.2	-22.38	217	204	H
2.439	44.7	PK1	32.4	-30.9	46.2	-	-	-	-	68.2	-22	137	206	V
* 4.782	39.34	PK1	34.1	-27.4	46.04	-	-	74	-27.96	-	-	140	368	V
* 4.778	27.74	AD1	34.1	-27.4	34.44	54	-19.56	-	-	-	-	140	368	V
* 8.43	35.81	PK1	35.8	-25	46.61	-	-	74	-27.39	-	-	201	167	H
* 8.432	24.55	AD1	35.8	-25	35.35	54	-18.65	-	-	-	-	201	167	H
16.374	36.21	PK1	40.8	-18.4	58.61	-	-	-	-	68.2	-9.59	90	397	V

* - indicates frequency in CFR15.205/IC7.2.2 Restricted Band

PK1 - KDB789033 Method: Peak

AD1 - KDB789033 Method: AD Primary Power Average

10.2.14. TX ABOVE 1G 802.11ac 80MHz MODE IN THE 5.6 GHz BAND

RESTRICTED & AUTHORIZED BANDEDGE (LOW CHANNEL, 106)

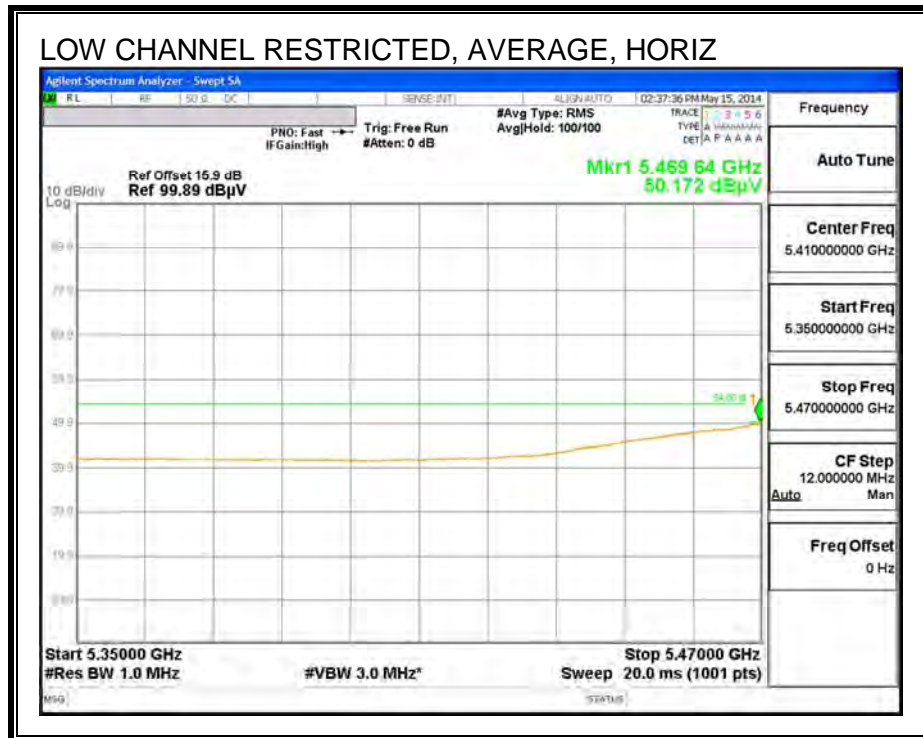
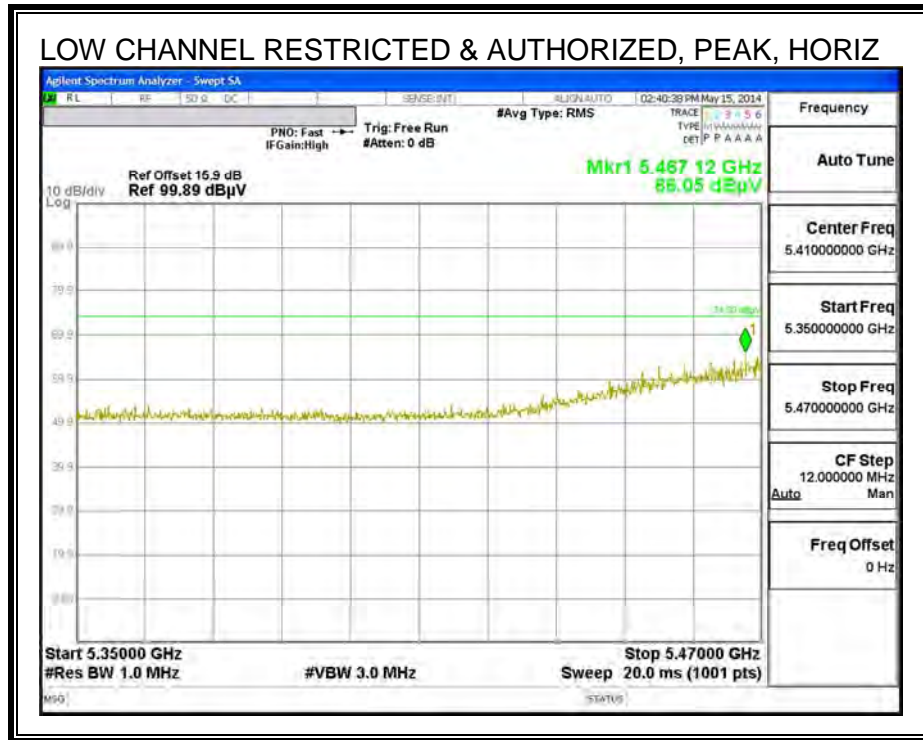

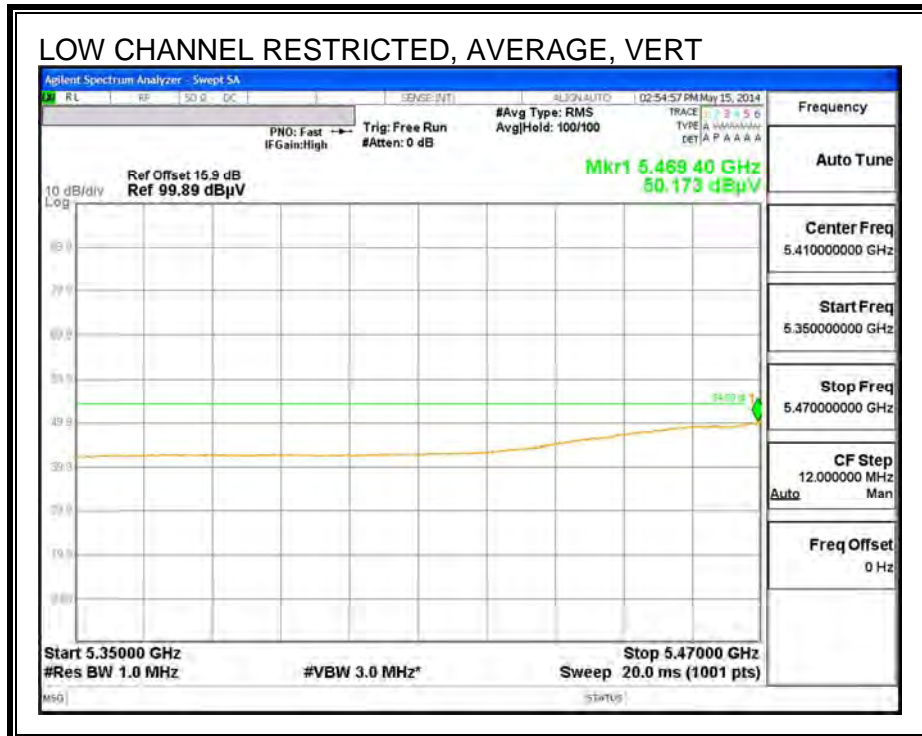
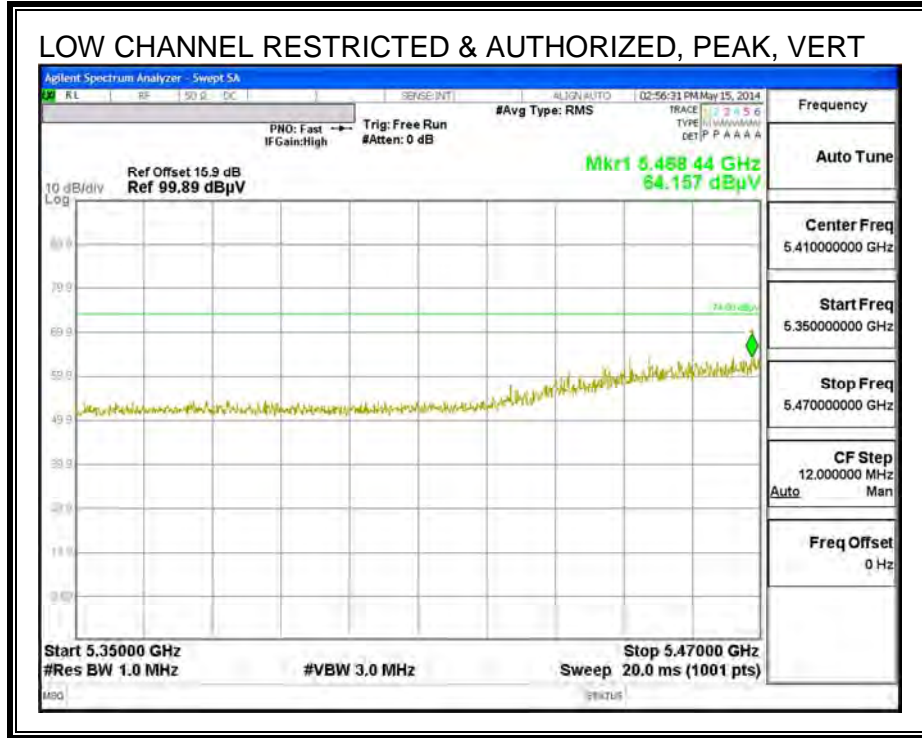

HARMONICS AND SPURIOUS EMISSIONS

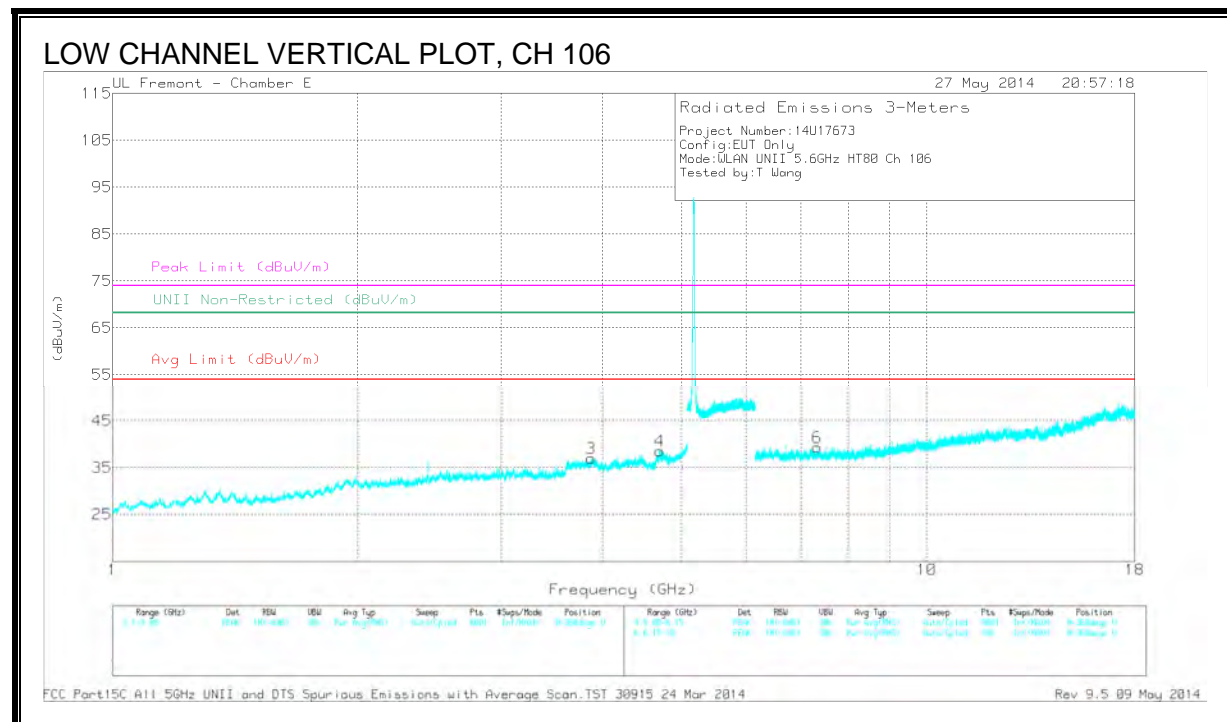
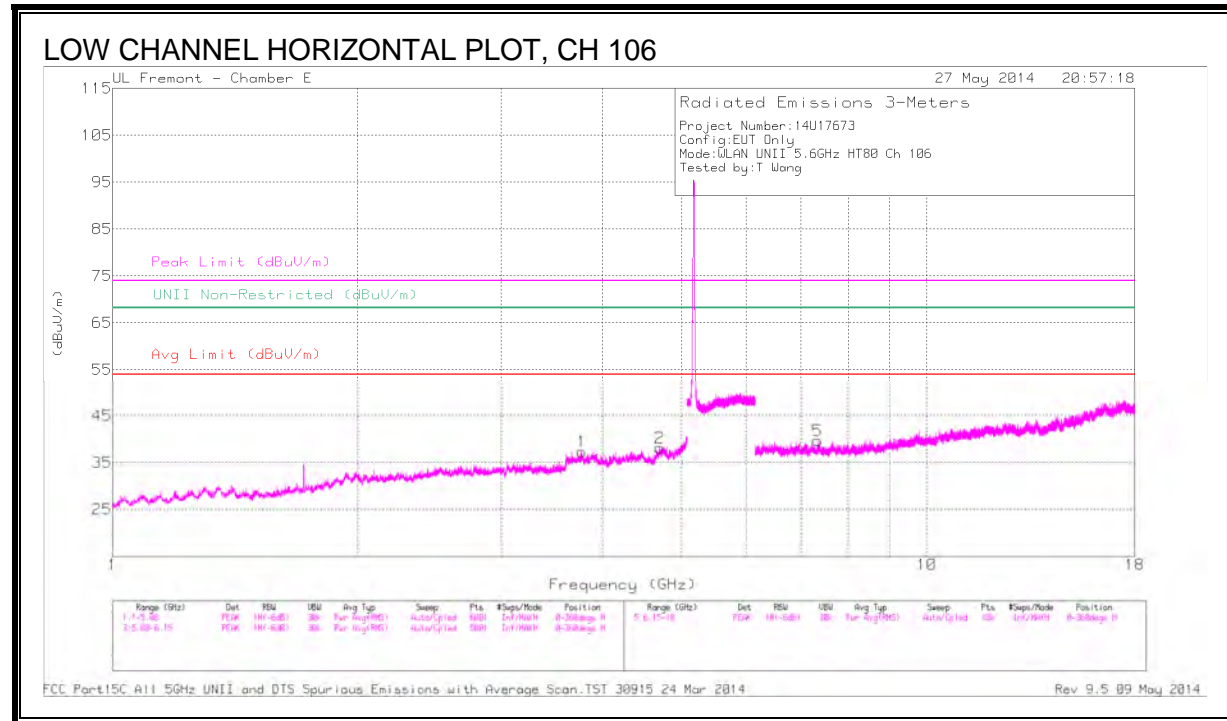

DATA

Marker	Frequency (GHz)	Meter Reading (dBuV)	Det	AF T346 (dB/m)	Amp/Cbl/ Fitr/Pad (dB)	DC Corr (dB)	Corrected Reading (dBuV/m)	Avg Limit (dBuV/m)	Margin (dB)	Peak Limit (dBuV/m)	PK Margin (dB)	UNII Non-Restricted (dBuV/m)	PK Margin (dB)	Azimuth (Degs)	Height (cm)	Polarity
1	* 3.77	42.7	PK1	33.4	-31.8	0	44.3	-	-	74	-29.7	-	-	303	334	H
	* 3.76	31.57	AD1	33.4	-32.1	.2	33.07	54	20.93	-	-	-	-	303	334	H
2	* 4.698	42.29	PK1	34.2	-29.9	0	46.59	-	-	74	-27.41	-	-	40	253	H
	* 4.71	30.71	AD1	34.2	-30.2	.2	34.91	54	19.09	-	-	-	-	40	253	H
3	* 3.878	42.32	PK1	33.5	-30.5	0	45.32	-	-	74	-28.68	-	-	274	158	V
	* 3.861	30.72	AD1	33.5	-30.9	.2	33.52	54	20.48	-	-	-	-	274	158	V
4	* 4.703	42.48	PK1	34.2	-30	0	46.68	-	-	74	-27.32	-	-	263	271	V
	* 4.709	30.72	AD1	34.2	-30.2	.2	34.92	54	19.08	-	-	-	-	263	271	V
5	* 7.338	38.32	PK1	35.7	-27.6	0	46.42	-	-	74	-27.58	-	-	324	258	H
	* 7.33	27.02	AD1	35.7	-27.6	.2	35.32	54	18.68	-	-	-	-	324	258	H
6	* 7.343	38.8	PK1	35.7	-27.5	0	47	-	-	74	-27	-	-	169	139	V
	* 7.341	27.1	AD1	35.7	-27.6	.2	35.4	54	-18.6	-	-	-	-	169	139	V

* - indicates frequency in CFR15.205/IC7.2.2 Restricted Band

PK1 - KDB789033 Method: Peak

AD1 - KDB789033 Method: AD Primary Power Average

10.2.15. TX ABOVE 1 GHz 802.11n ac80 MODE, CHANNEL 138, 5.6 GHz BAND

HARMONICS AND SPURIOUS EMISSIONS

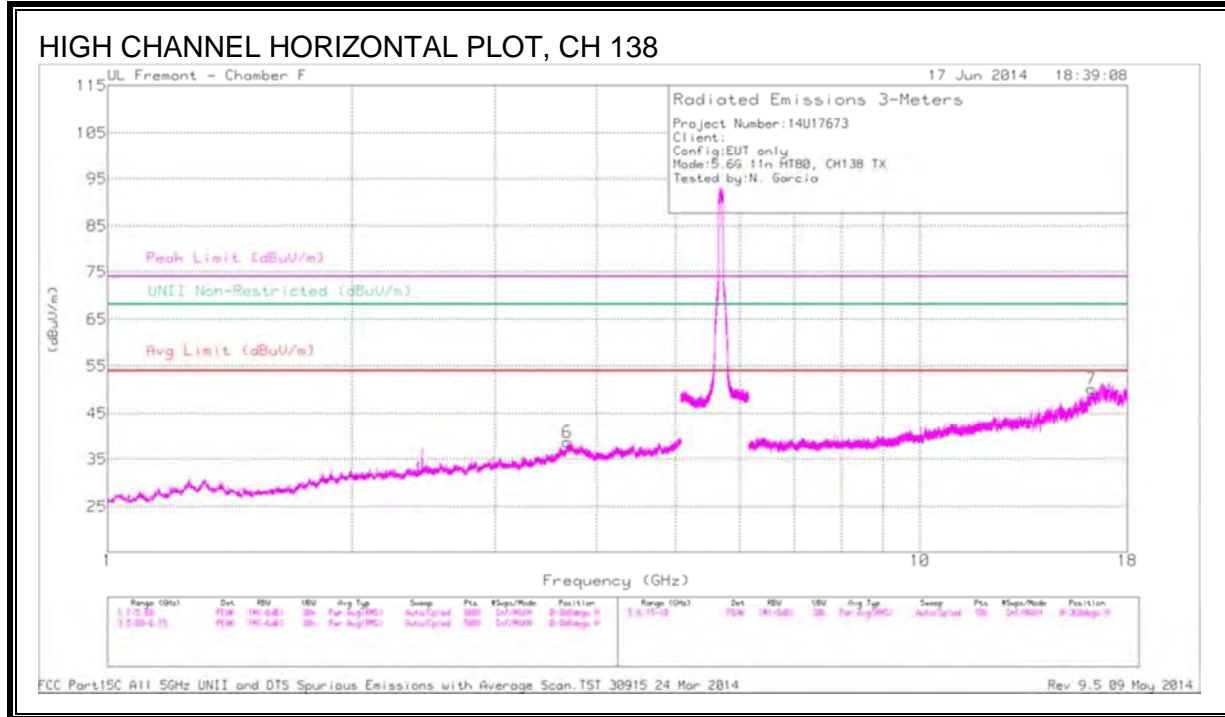

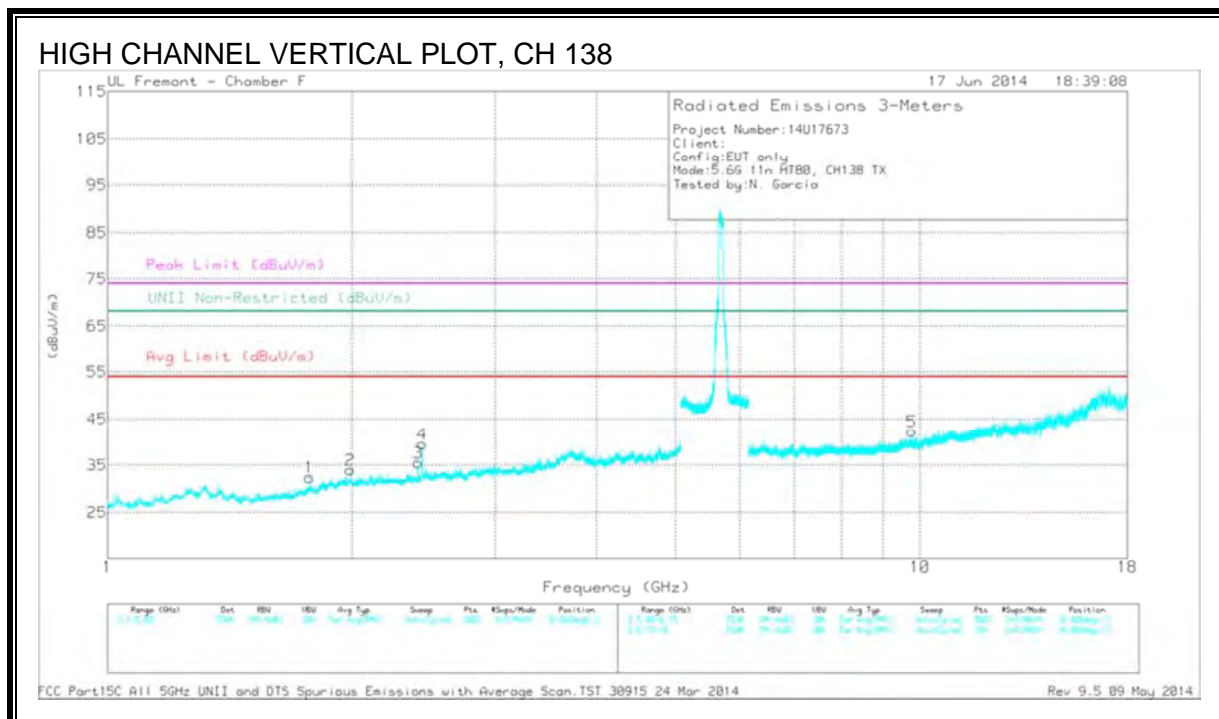

DATA

Frequency (GHz)	Meter Reading (dBuV)	Det	AF T120 (dB/m)	Amp/Cb/Filtr/Pad (dB)	Corrected Reading (dBuV/m)	Avg Limit (dBuV/m)	Margin (dB)	Peak Limit (dBuV/m)	PK Margin (dB)	UNII Non-Restricted (dBuV/m)	PK Margin (dB)	Azimuth (Degs)	Height (cm)	Polarity
* 3.674	40.19	PK1	34.9	-29.4	45.69	-	-	74	-28.31	-	-	325	305	H
* 3.671	28.95	AD1	34.9	-29.5	34.35	54	-19.65	-	-	-	-	325	305	H
1.766	41.25	PK1	29.9	-31.5	39.65	-	-	-	-	68.2	-28.55	251	299	V
1.99	40.69	PK1	31.7	-31.3	41.09	-	-	-	-	68.2	-27.11	9	389	V
2.409	40.8	PK1	32.2	-30.8	42.2	-	-	-	-	68.2	-26	36	201	V
2.438	44.89	PK1	32.4	-30.9	46.39	-	-	-	-	68.2	-21.81	149	106	V
16.256	35.65	PK1	40.5	-18	58.15	-	-	-	-	68.2	-10.05	234	320	H
9.77	35.19	PK1	37.1	-22.9	49.39	-	-	-	-	68.2	-18.81	328	310	V

* - indicates frequency in CFR15.205/IC7.2.2 Restricted Band

PK1 - KDB789033 Method: Peak

AD1 - KDB789033 Method: AD Primary Power Average

10.2.16. TX ABOVE 1 GHz 802.11a MODE IN THE 5.8 GHz BAND

RESTRICTED & AUTHORIZED BANDEDGE (LOW CHANNEL)

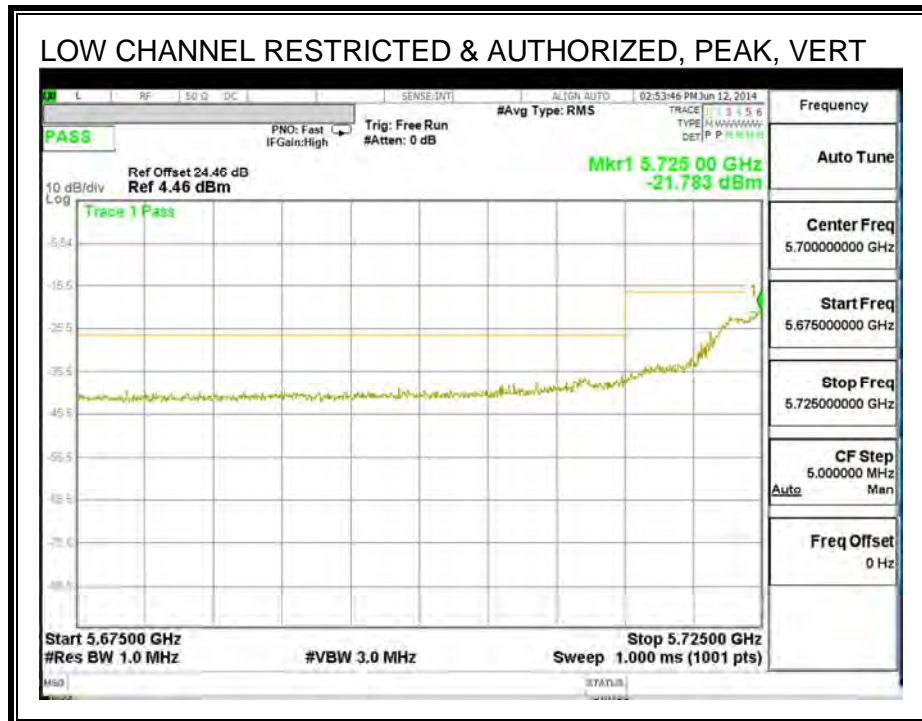
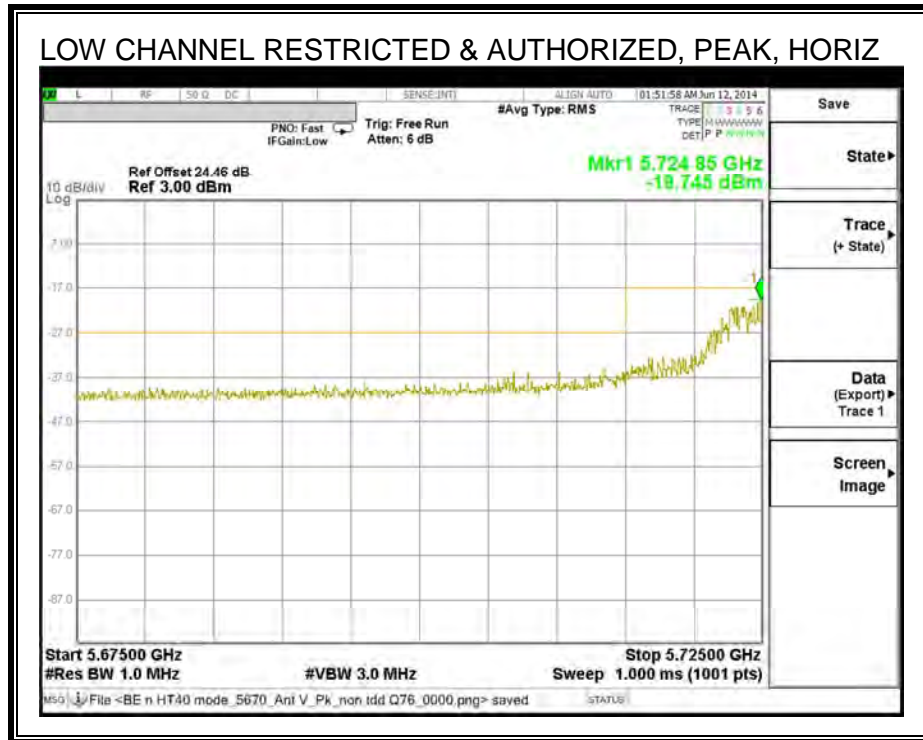

AUTHORIZED BANDEDGE (HIGH CHANNEL)

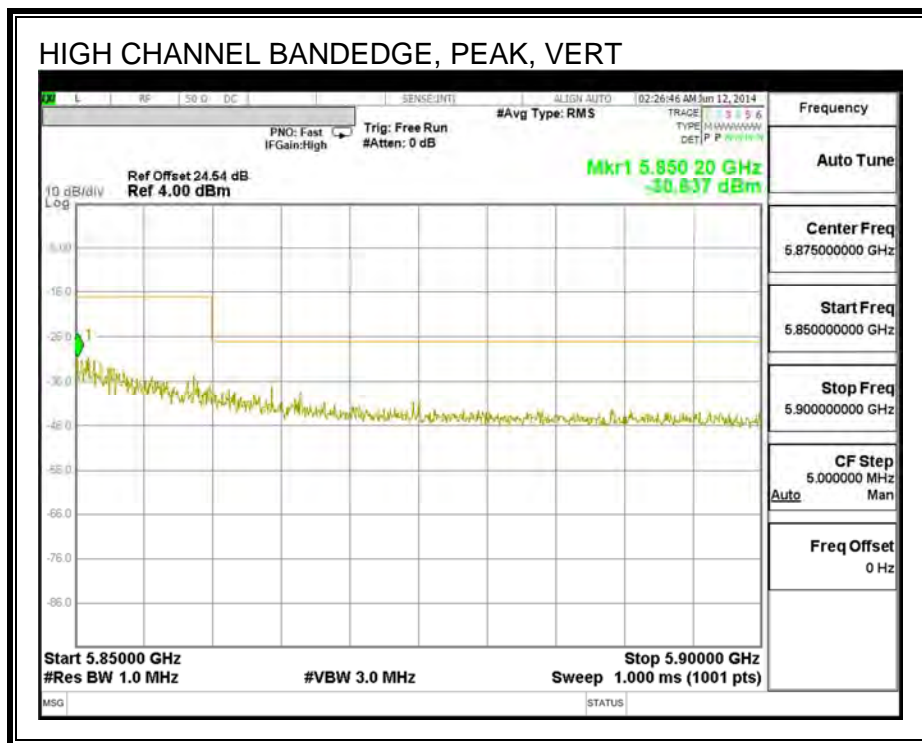
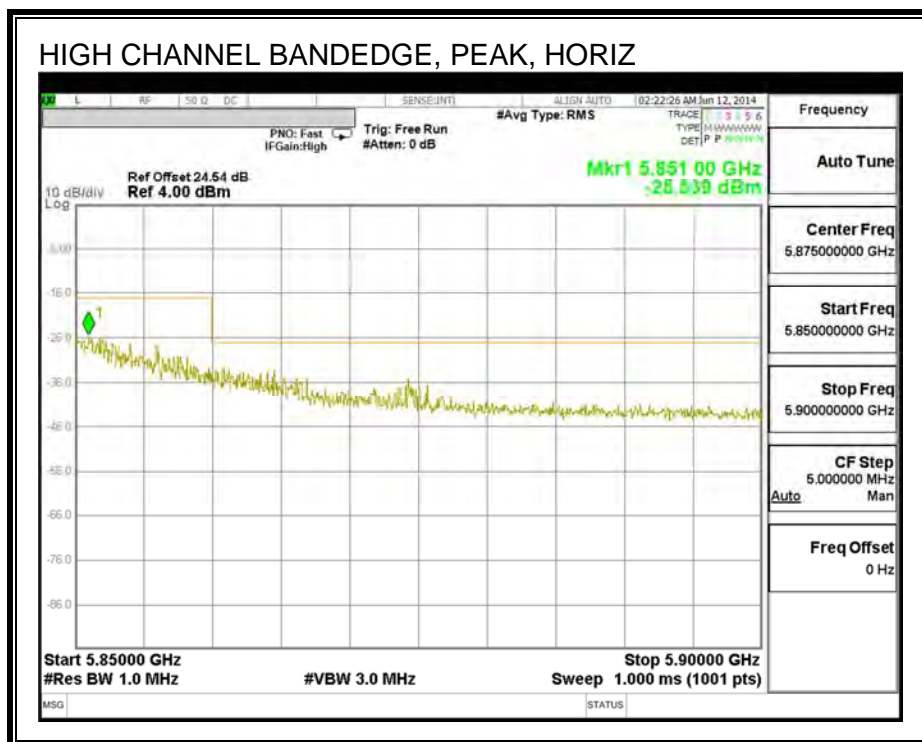

HARMONICS AND SPURIOUS EMISSIONS

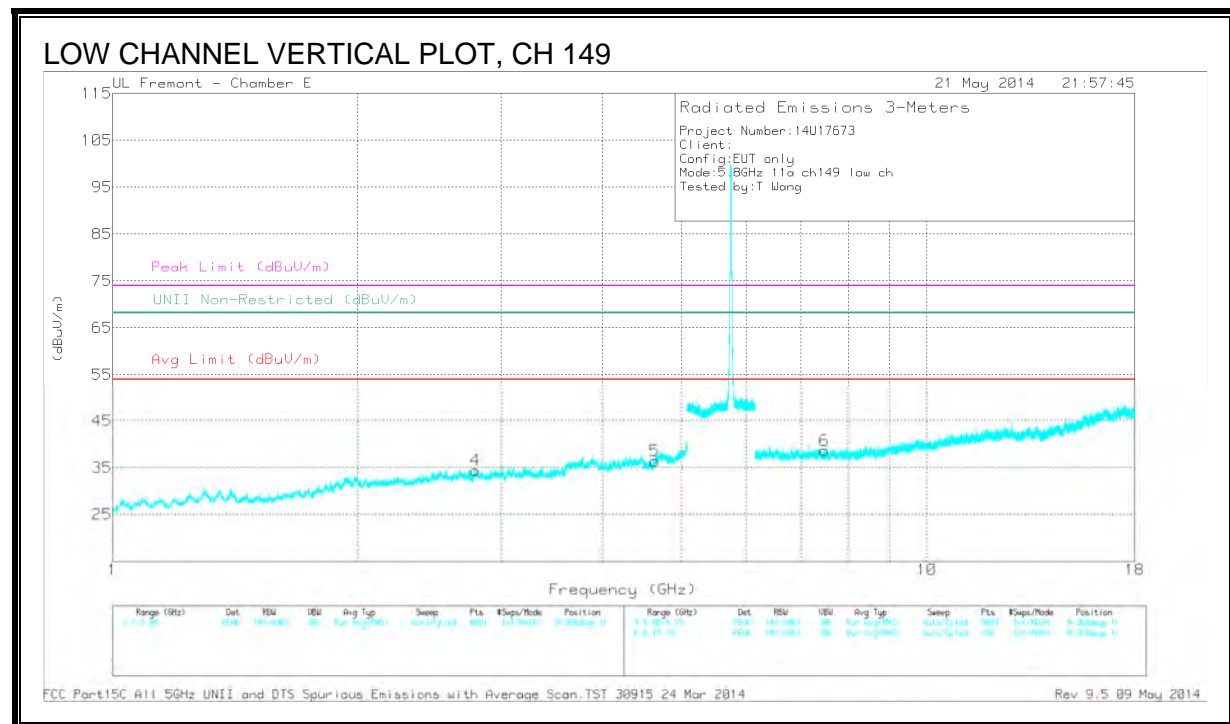
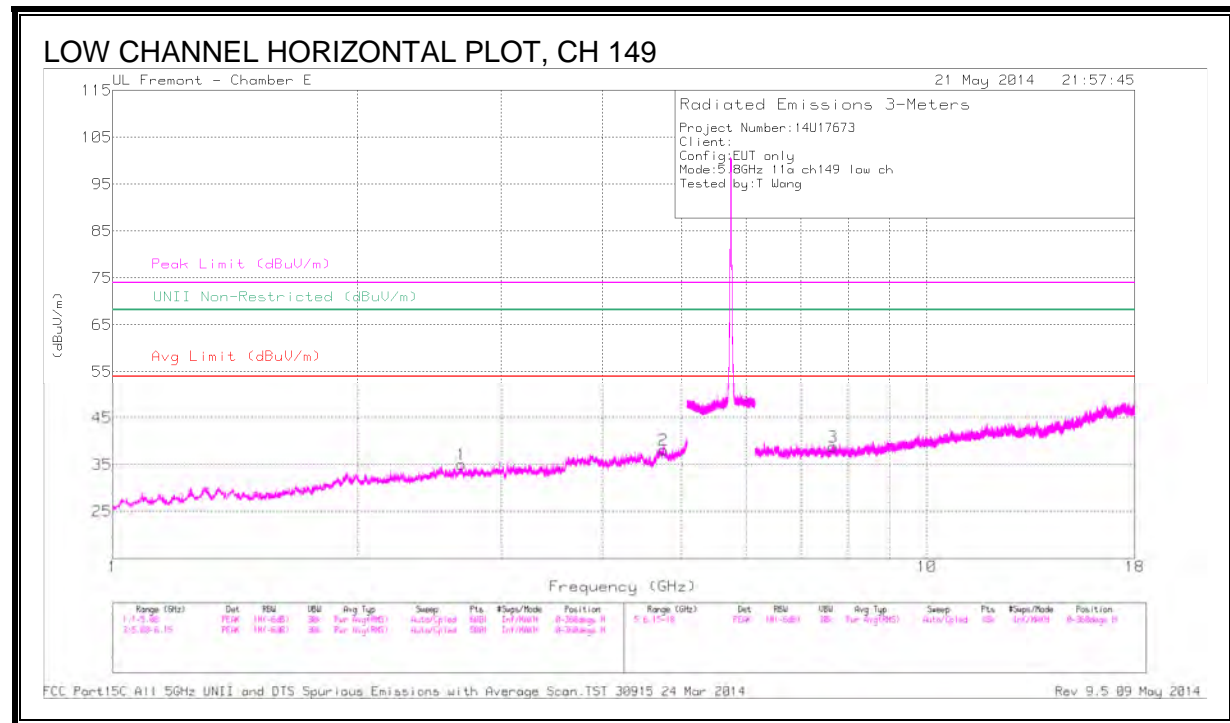

DATA

Frequency (GHz)	Meter Reading (dBuV)	Det	AF T346 (dB/m)	Amp/Cb/Fitr /Pad (dB)	Corrected Reading (dBuV/m)	Avg Limit (dBuV/m)	Margin (dB)	Peak Limit (dBuV/m)	PK Margin (dB)	UNII Non-Restricted (dBuV/m)	PK Margin (dB)	Azimuth (Degs)	Height (cm)	Polarity
* 2.672	42.8	PK1	32.5	-32.4	42.9	-	-	74	-31.1	-	-	229	378	H
* 2.683	30.82	AD1	32.5	-32.4	30.92	54	-23.08	-	-	-	-	229	378	H
* 4.738	42.56	PK1	34.1	-30.6	46.06	-	-	74	-27.94	-	-	135	286	H
* 4.753	31.44	AD1	34.1	-30.6	34.94	54	-19.06	-	-	-	-	135	286	H
* 2.784	42.14	PK1	32.4	-32	42.54	-	-	74	-31.46	-	-	96	209	V
* 2.795	30.47	AD1	32.4	-32	30.87	54	-23.13	-	-	-	-	96	209	V
* 4.64	41.73	PK1	34.1	-29.9	45.93	-	-	74	-28.07	-	-	330	115	V
* 4.645	29.79	AD1	34.1	-29.8	34.09	54	-19.91	-	-	-	-	330	115	V
* 7.654	39.4	PK1	35.8	-27.3	47.9	-	-	74	-26.1	-	-	251	397	H
* 7.655	27.07	AD1	35.8	-27.3	35.57	54	-18.43	-	-	-	-	251	397	H
* 7.393	39.78	PK1	35.7	-27.2	48.28	-	-	74	-25.72	-	-	8	364	V
* 7.391	27.07	AD1	35.7	-27.2	35.57	54	-18.43	-	-	-	-	8	364	V

* - indicates frequency in CFR15.205/IC7.2.2 Restricted Band

PK1 - KDB789033 Method: Peak

AD1 - KDB789033 Method: AD Primary Power Average

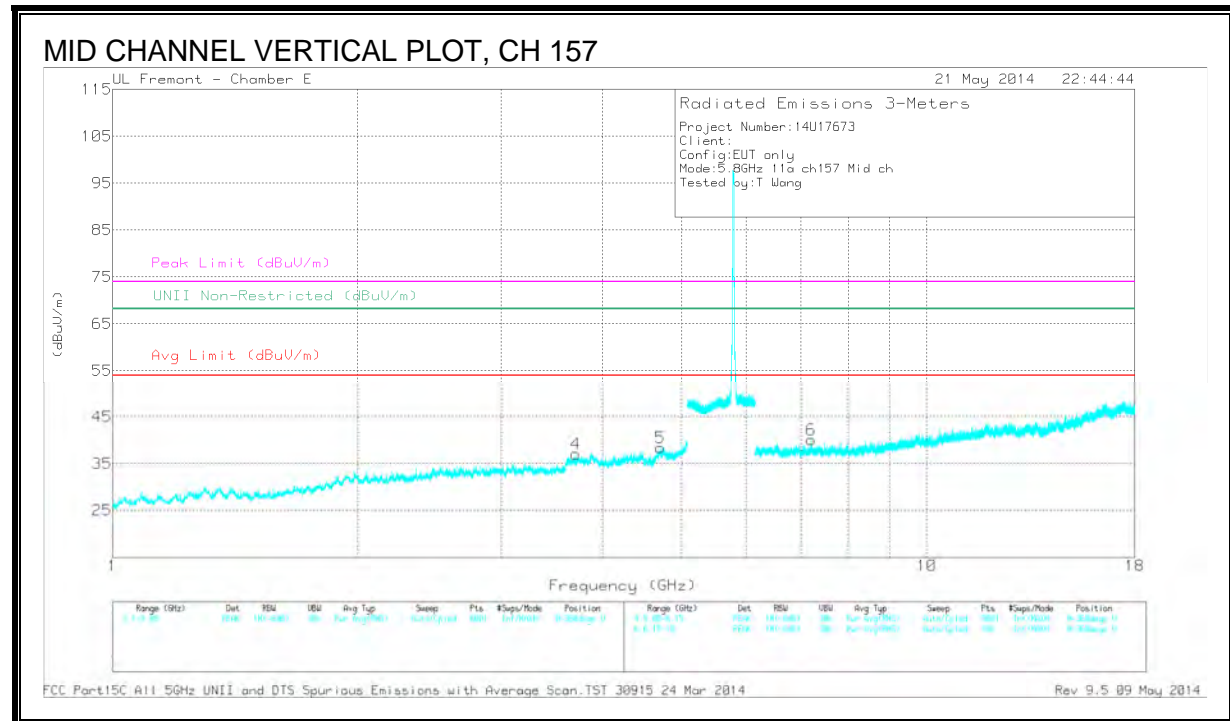
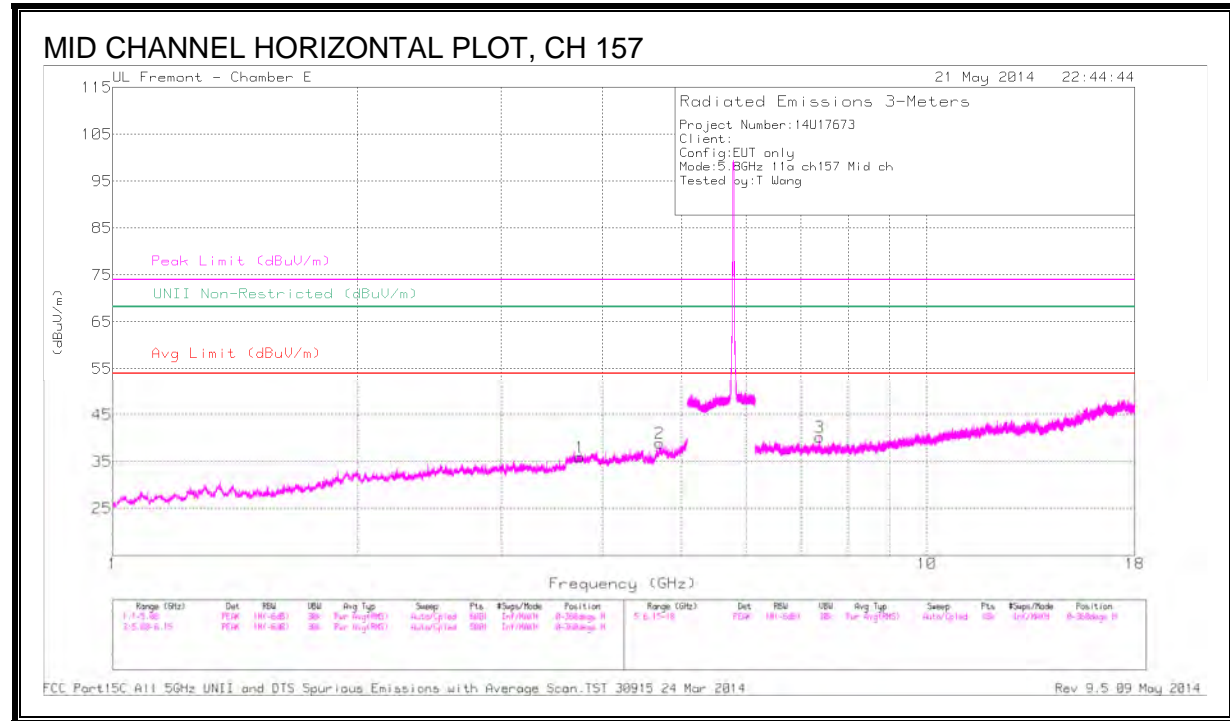

DATA

Frequency (GHz)	Meter Reading (dBuV)	Det	AF T346 (dB/m)	Amp/Cb/Filtr /Pad (dB)	Corrected Reading (dBuV/m)	Avg Limit (dBuV/m)	Margin (dB)	Peak Limit (dBuV/m)	PK Margin (dB)	UNII Non-Restricted (dBuV/m)	PK Margin (dB)	Azimuth (Degs)	Height (cm)	Polarity
* 3.748	42.8	PK1	32.5	-32.4	42.9	-	-	74	-31.1	-	-	227	378	H
* 3.744	30.82	AD1	32.5	-32.4	30.92	54	-23.08	-	-	-	-	227	378	H
* 4.703	42.56	PK1	34.1	-30.6	46.06	-	-	74	-27.94	-	-	130	289	H
* 4.701	31.44	AD1	34.1	-30.6	34.94	54	-19.06	-	-	-	-	130	289	H
* 3.701	42.14	PK1	32.4	-32	42.54	-	-	74	-31.46	-	-	102	201	V
* 3.698	30.47	AD1	32.4	-32	30.87	54	-23.13	-	-	-	-	102	201	V
* 4.64	41.73	PK1	34.1	-29.9	45.93	-	-	74	-28.07	-	-	334	125	V
* 4.645	29.79	AD1	34.1	-29.8	34.09	54	-19.91	-	-	-	-	334	125	V
* 7.402	39.4	PK1	35.8	-27.3	47.9	-	-	74	-26.1	-	-	241	377	H
* 7.399	27.07	AD1	35.8	-27.3	35.57	54	-18.43	-	-	-	-	241	377	H
7.209	39.78	PK1	35.7	-27.2	48.28	-	-	-	-	68.2	-19.92	48	344	V
7.213	27.07	AD1	35.7	-27.2	35.57	-	-	-	-	-	-	48	344	V

* - indicates frequency in CFR15.205/IC7.2.2 Restricted Band

PK1 - KDB789033 Method: Peak

AD1 - KDB789033 Method: AD Primary Power Average

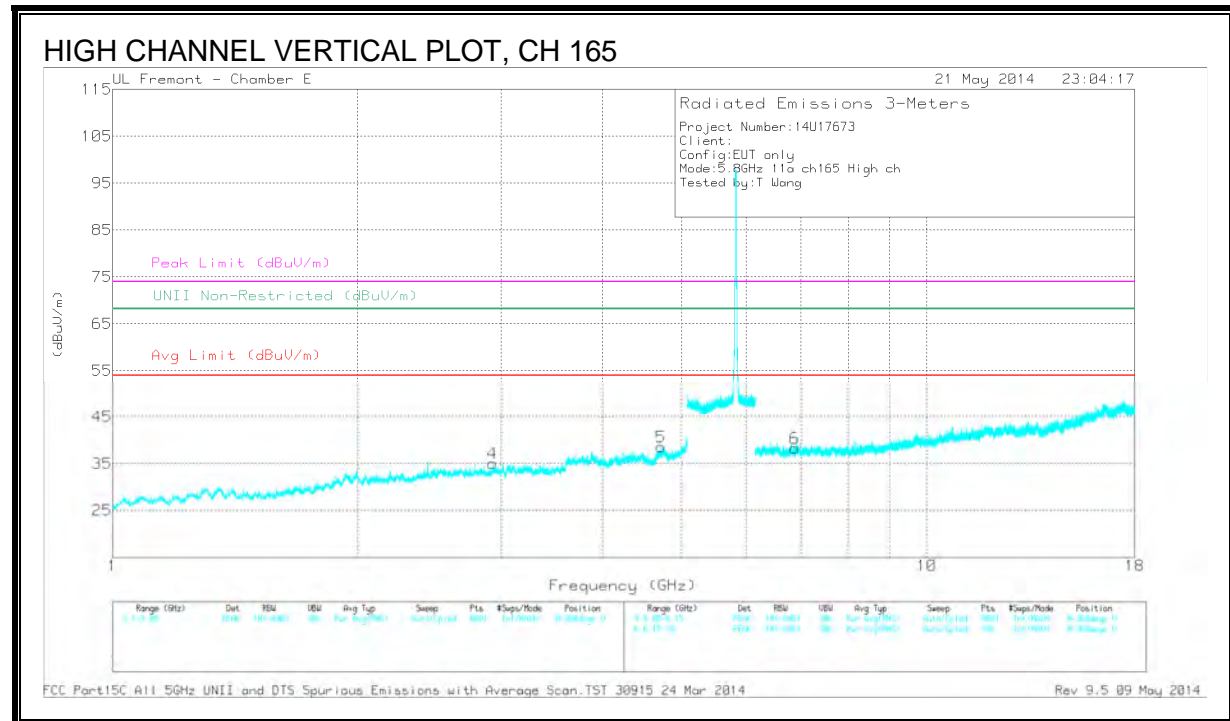
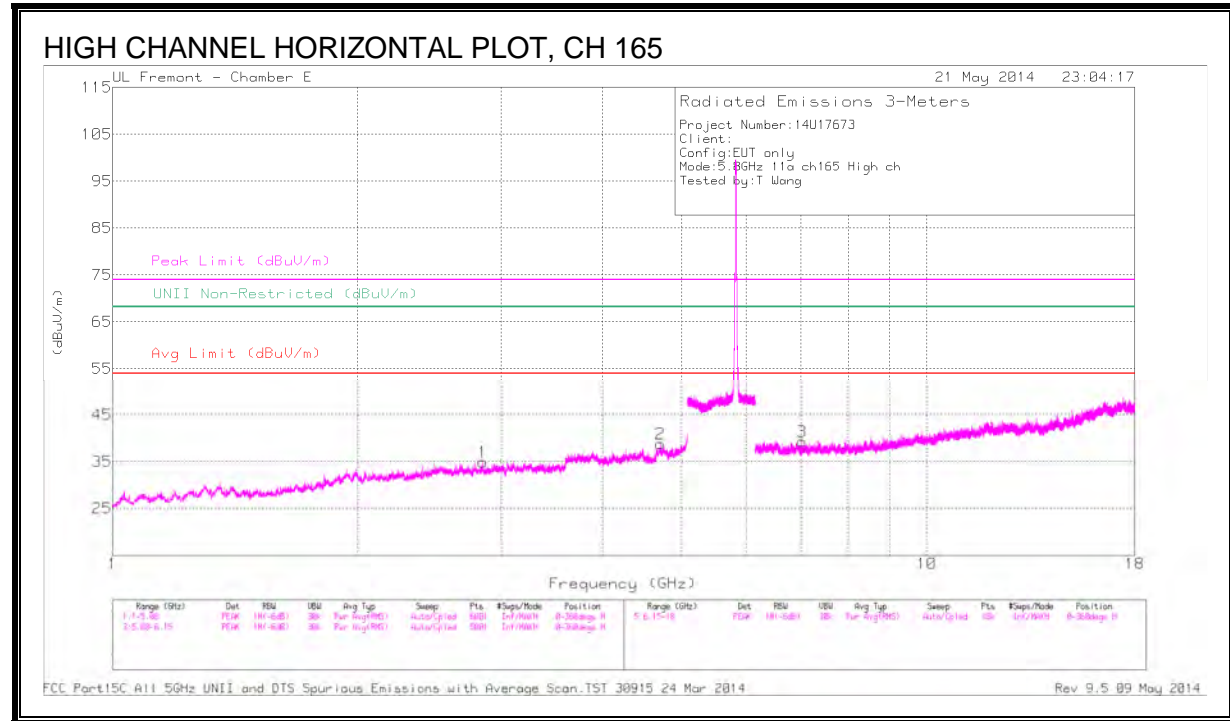

DATA

Frequency (GHz)	Meter Reading (dBuV)	Det	AF T346 (dB/m)	Amp/Cb/Filtr /Pad (dB)	Corrected Reading (dBuV/m)	Avg Limit (dBuV/m)	Margin (dB)	Peak Limit (dBuV/m)	PK Margin (dB)	UNII Non-Restricted (dBuV/m)	PK Margin (dB)	Azimuth (Degs)	Height (cm)	Polarity
* 2.850	40.07	PK1	33.4	-31.9	41.57	-	-	74	-32.43	-	-	283	181	H
* 2.848	30.59	AD1	33.4	-31.8	32.19	54	-21.81	-	-	-	-	283	181	H
* 4.703	40.5	PK1	34.2	-29.9	44.8	-	-	74	-29.2	-	-	233	202	H
* 4.705	28.96	AD1	34.2	-29.9	33.26	54	-20.74	-	-	-	-	233	202	H
* 4.712	40.25	PK1	34.2	-30.2	44.25	-	-	74	-29.75	-	-	46	154	V
* 4.711	28.78	AD1	34.2	-30.3	32.68	54	-21.32	-	-	-	-	46	154	V
2.929	42.87	PK1	33.4	-31.9	44.37	-	-	-	-	68.2	-23.83	87	134	V
2.930	32	AD1	33.4	-31.9	33.5	-	-	-	-	-	-	87	134	V
7.022	39.39	PK1	35.6	-28.1	46.89	-	-	-	-	68.2	-21.31	122	242	H
7.025	28.19	AD1	35.6	-28.1	35.69	-	-	-	-	-	-	122	242	H
6.881	39.69	PK1	35.9	-28.5	47.09	-	-	-	-	68.2	-21.11	81	359	V
6.884	28.08	AD1	35.9	-28.6	35.38	-	-	-	-	-	-	81	359	V

* - indicates frequency in CFR15.205/IC7.2.2 Restricted Band

PK1 - KDB789033 Method: Peak

AD1 - KDB789033 Method: AD Primary Power Average

10.2.17. TX ABOVE 1 GHz 802.11n HT20 MODE IN THE 5.8 GHz BAND

RESTRICTED & AUTHORIZED BANDEDGE (LOW CHANNEL)

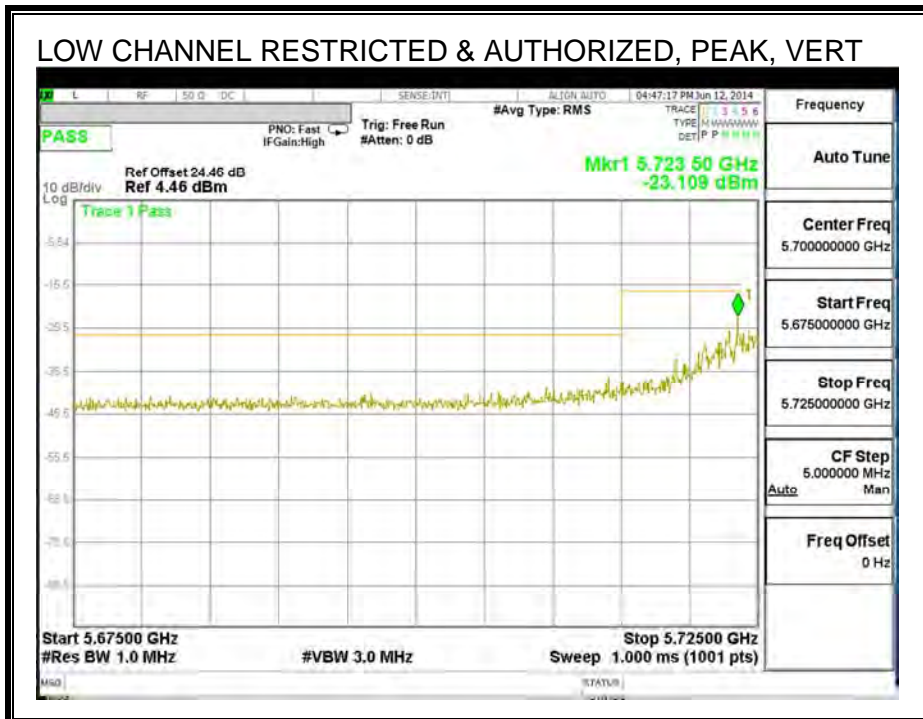
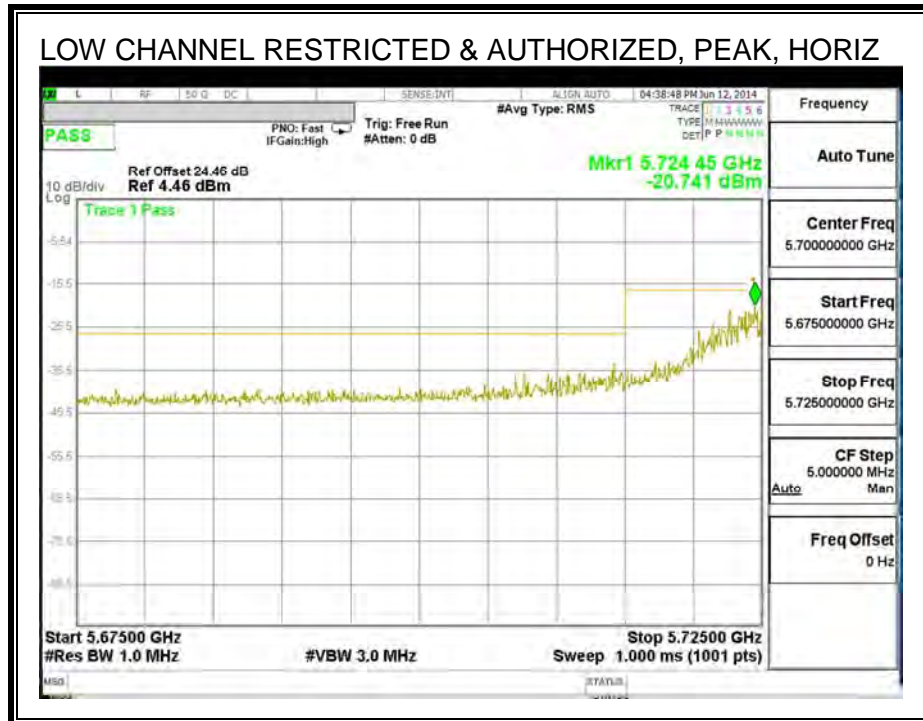

AUTHORIZED BANDEDGE (HIGH CHANNEL)

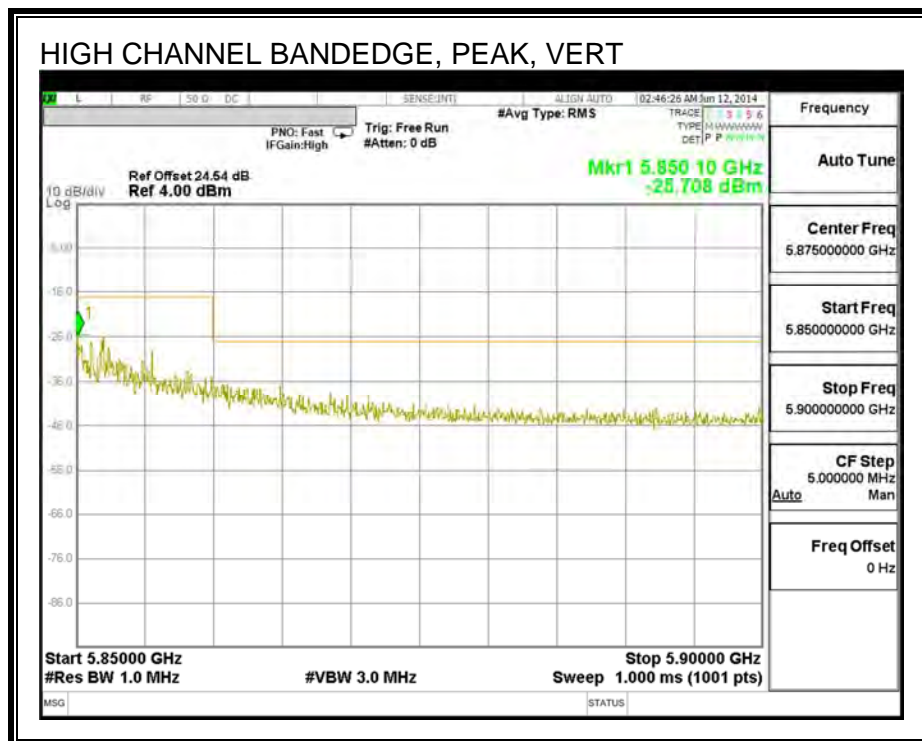
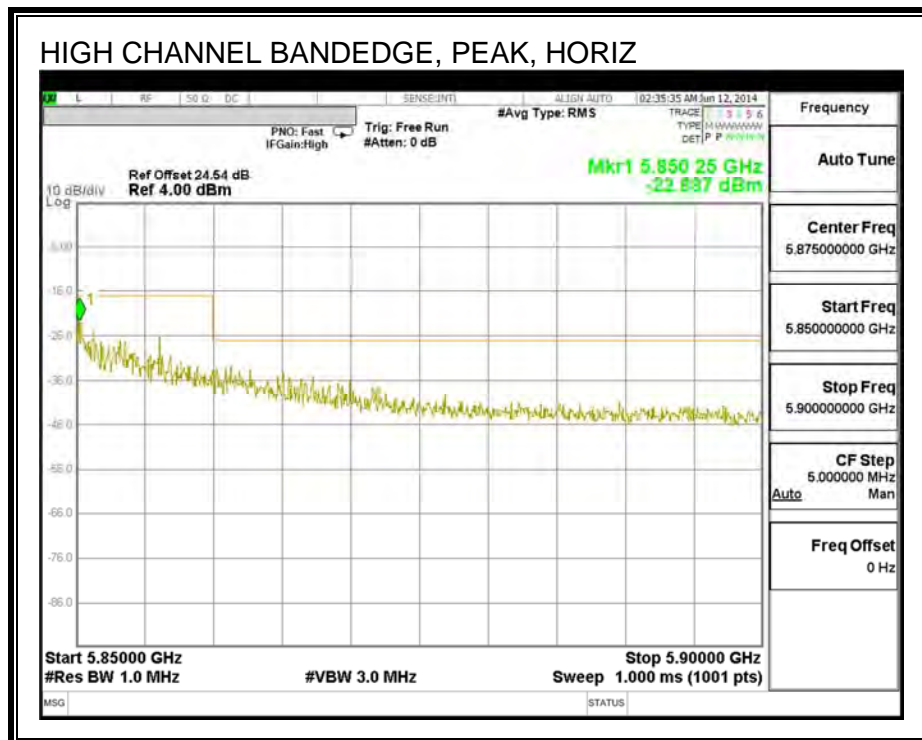

HARMONICS AND SPURIOUS EMISSIONS

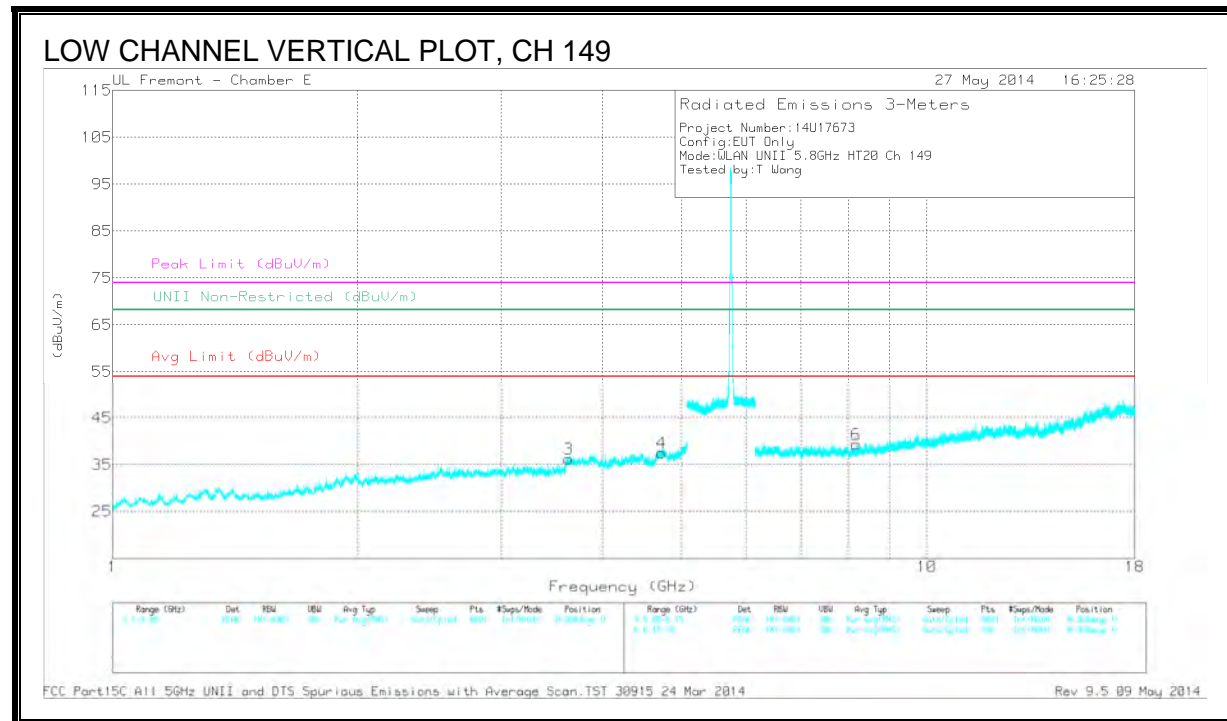
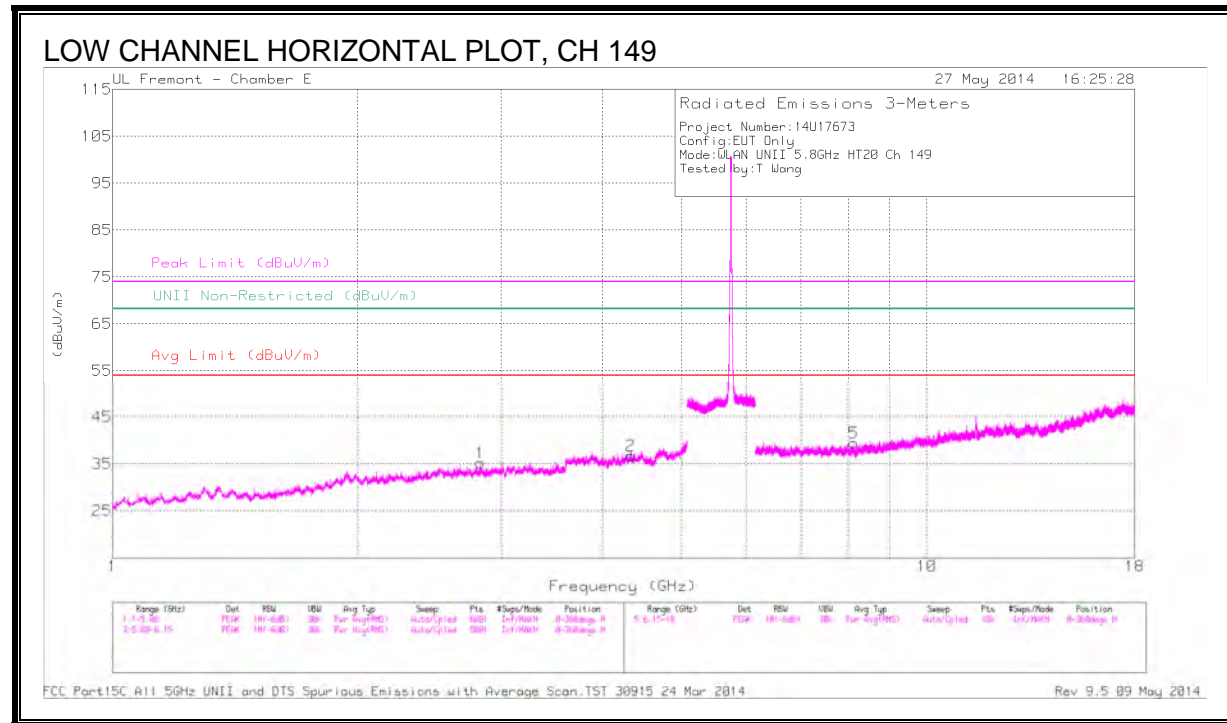

DATA

Frequency (GHz)	Meter Reading (dBuV)	Det	AF T346 (dB/m)	Amp/Cbl/Filtr /Pad (dB)	Corrected Reading (dBuV/m)	Avg Limit (dBuV/m)	Margin (dB)	Peak Limit (dBuV/m)	PK Margin (dB)	UNII Non-Restricted (dBuV/m)	PK Margin (dB)	Azimuth (Degs)	Height (cm)	Polarity
* 2.819	42.34	PK1	32.4	-32.2	42.54	-	-	74	-31.46	-	-	231	243	H
* 2.837	30.7	AD1	32.4	-32.5	30.6	54	-23.4	-	-	-	-	231	243	H
* 4.326	41.56	PK1	33.6	-30.5	44.66	-	-	74	-29.34	-	-	291	218	H
* 4.333	30.52	AD1	33.6	-30.8	33.32	54	-20.68	-	-	-	-	291	218	H
* 3.63	41.85	PK1	33.2	-30.9	44.15	-	-	74	-29.85	-	-	264	280	V
* 3.621	30.74	AD1	33.2	-31	32.94	54	-21.06	-	-	-	-	264	280	V
* 4.716	42.22	PK1	34.2	-30.4	46.02	-	-	74	-27.98	-	-	191	110	V
* 4.732	30.76	AD1	34.1	-30.6	34.26	54	-19.74	-	-	-	-	191	110	V
* 8.132	38.29	PK1	35.9	-27.4	46.79	-	-	74	-27.21	-	-	329	145	H
* 8.144	26.98	AD1	35.9	-27.5	35.38	54	-18.62	-	-	-	-	329	145	H
* 8.2	38.79	PK1	35.9	-28	46.69	-	-	74	-27.31	-	-	288	167	V
* 8.2	27.2	AD1	35.9	-28	35.1	54	-18.9	-	-	-	-	288	167	V

* - indicates frequency in CFR15.205/IC7.2.2 Restricted Band

PK1 - KDB789033 Method: Peak

AD1 - KDB789033 Method: AD Primary Power Average

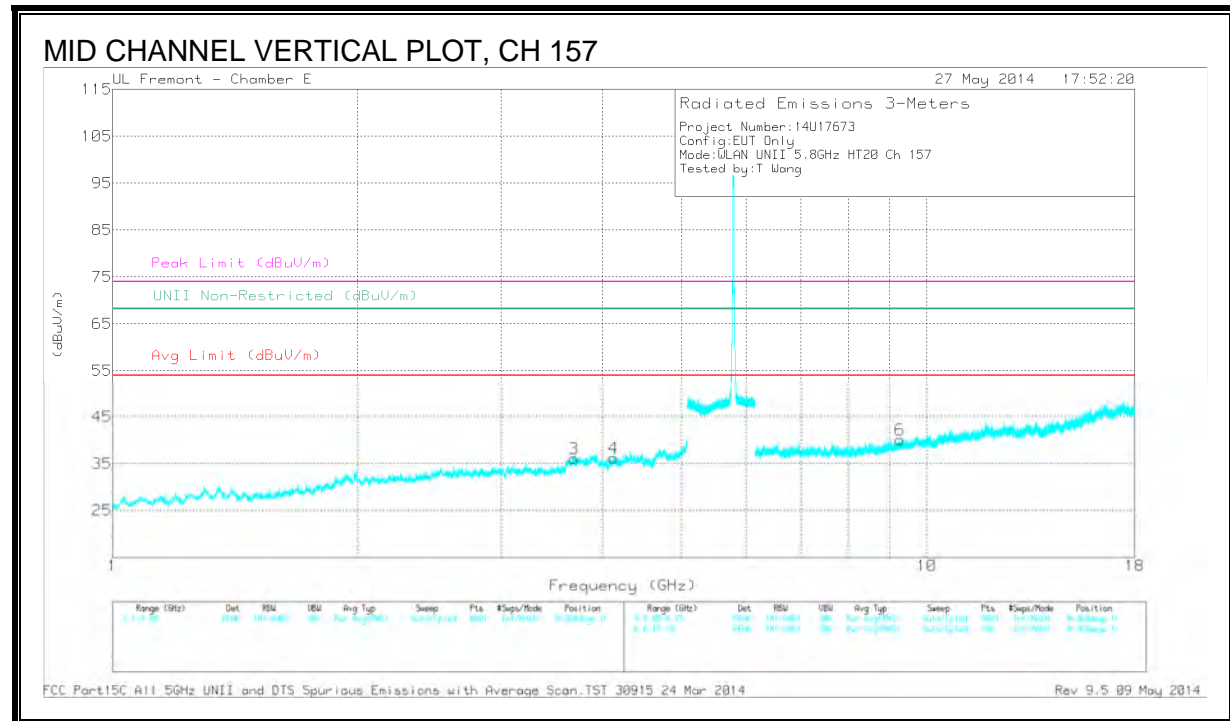
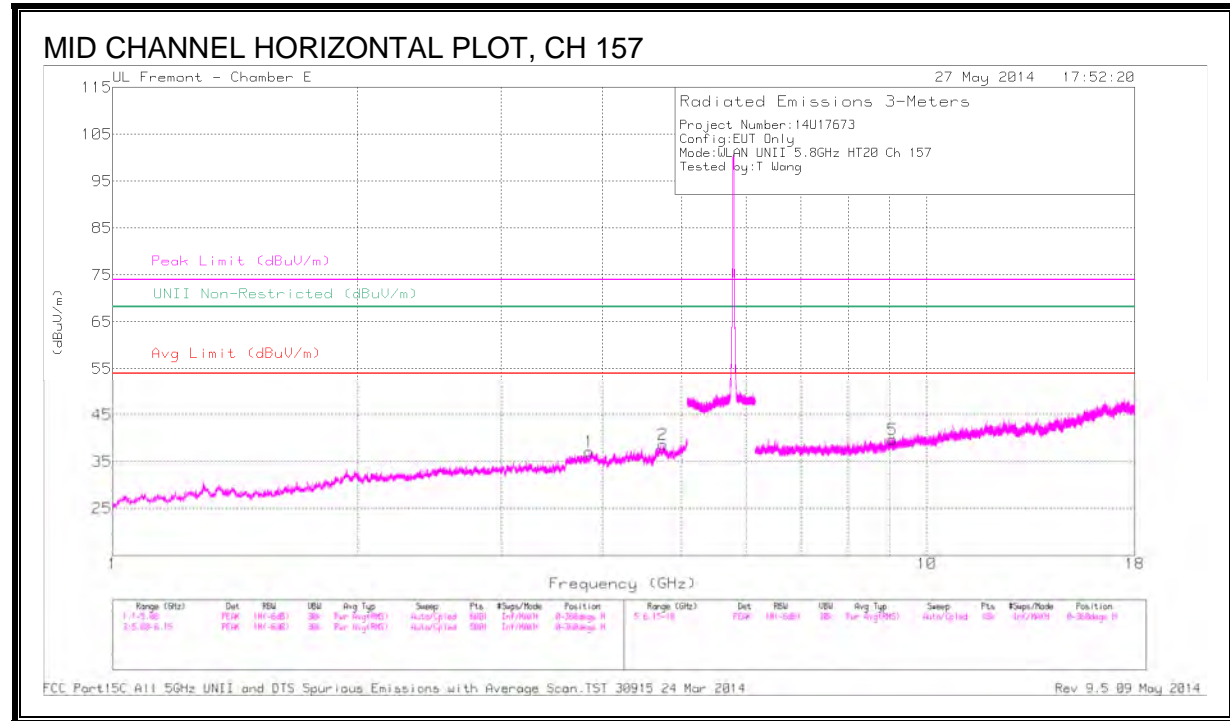

DATA

Frequency (GHz)	Meter Reading (dBuV)	Det	AF T346 (dB/m)	Amp/Cbl/Fitr /Pad (dB)	Corrected Reading (dBuV/m)	Avg Limit (dBuV/m)	Margin (dB)	Peak Limit (dBuV/m)	PK Margin (dB)	UNII Non-Restricted (dBuV/m)	PK Margin (dB)	Azimuth (Degs)	Height (cm)	Polarity
* 3.843	42.25	PK1	33.5	-31.3	44.45	-	-	74	-29.55	-	-	152	103	H
* 3.857	31.1	AD1	33.5	-31	33.6	54	-20.4	-	-	-	-	152	103	H
* 4.741	43.1	PK1	34.1	-30.6	46.6	-	-	74	-27.4	-	-	82	152	H
* 4.744	31.38	AD1	34.1	-30.6	34.88	54	-19.12	-	-	-	-	82	152	H
* 3.684	42.94	PK1	33.3	-31.3	44.94	-	-	74	-29.06	-	-	179	122	V
* 3.687	30.92	AD1	33.3	-31.3	32.92	54	-21.08	-	-	-	-	179	122	V
* 4.13	41.44	PK1	33.4	-31	43.84	-	-	74	-30.16	-	-	5	285	V
* 4.127	30.53	AD1	33.5	-31	33.03	54	-20.97	-	-	-	-	5	285	V
* 9.075	37.44	PK1	36.4	-26.3	47.54	-	-	74	-26.46	-	-	144	245	H
* 9.067	25.83	AD1	36.4	-26.2	36.03	54	-17.97	-	-	-	-	144	245	H
9.25	25.2	AD1	36.6	-25.5	36.3	-	-	-	-	-	-	18	191	V
9.27	37.11	PK1	36.6	-25.2	48.51	-	-	-	-	68.2	-19.69	18	191	V

* - indicates frequency in CFR15.205/IC7.2.2 Restricted Band

PK1 - KDB789033 Method: Peak

AD1 - KDB789033 Method: AD Primary Power Average

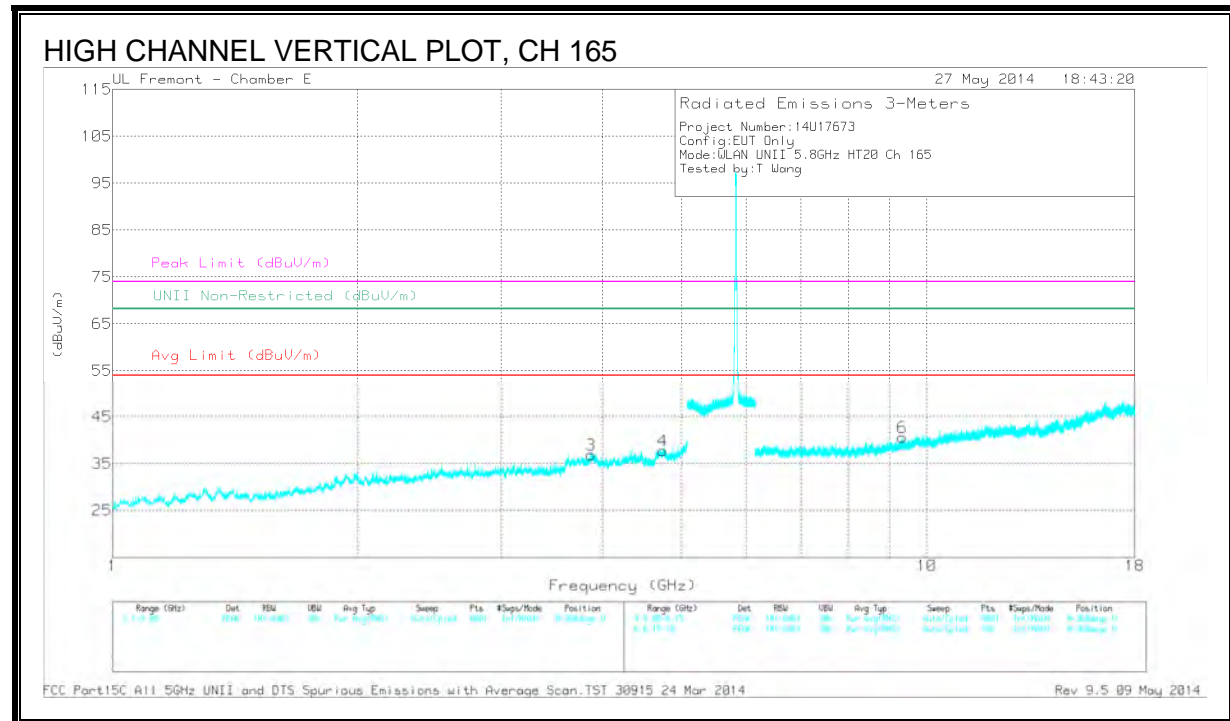
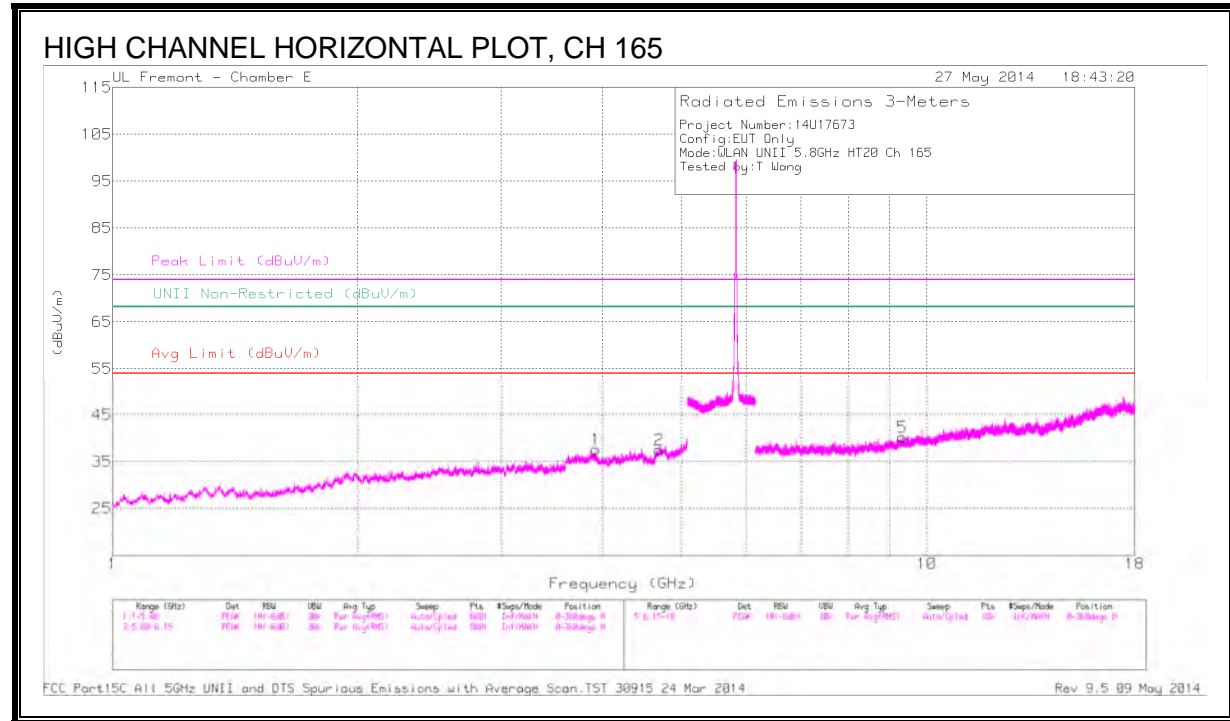

DATA

Frequency (GHz)	Meter Reading (dBuV)	Det	AF T346 (dB/m)	Amp/Cbl/Fitr /Pad (dB)	Corrected Reading (dBuV/m)	Avg Limit (dBuV/m)	Margin (dB)	Peak Limit (dBuV/m)	PK Margin (dB)	UNII Non-Restricted (dBuV/m)	PK Margin (dB)	Azimuth (Degs)	Height (cm)	Polarity
* 3.915	41.86	PK1	33.5	-30.5	44.86	-	-	74	-29.14	-	-	41	174	H
* 3.931	30.49	AD1	33.5	-30.8	33.19	54	-20.81	-	-	-	-	41	174	H
* 4.694	42.5	PK1	34.2	-29.8	46.9	-	-	74	-27.1	-	-	38	304	H
* 4.699	30.66	AD1	34.2	-29.9	34.96	54	-19.04	-	-	-	-	38	304	H
* 3.863	42.3	PK1	33.5	-30.8	45	-	-	74	-29	-	-	276	269	V
* 3.879	30.76	AD1	33.5	-30.5	33.76	54	-20.24	-	-	-	-	276	269	V
* 4.744	43.37	PK1	34.1	-30.6	46.87	-	-	74	-27.13	-	-	282	267	V
* 4.752	31.41	AD1	34.1	-30.6	34.91	54	-19.09	-	-	-	-	282	267	V
* 9.325	36.4	PK1	36.7	-25.3	47.8	-	-	74	-26.2	-	-	37	103	H
* 9.313	25.38	AD1	36.7	-25.6	36.48	54	-17.52	-	-	-	-	37	103	H
* 9.335	36.71	PK1	36.8	-25.3	48.21	-	-	74	-25.79	-	-	303	278	V
* 9.336	25.39	AD1	36.8	-25.4	36.79	54	-17.21	-	-	-	-	303	278	V

* - indicates frequency in CFR15.205/IC7.2.2 Restricted Band

PK1 - KDB789033 Method: Peak

AD1 - KDB789033 Method: AD Primary Power Average

10.2.18. TX ABOVE 1 GHz 802.11n HT40 MODE IN THE 5.8 GHz BAND

RESTRICTED & AUTHORIZED BANDEDGE (LOW CHANNEL)

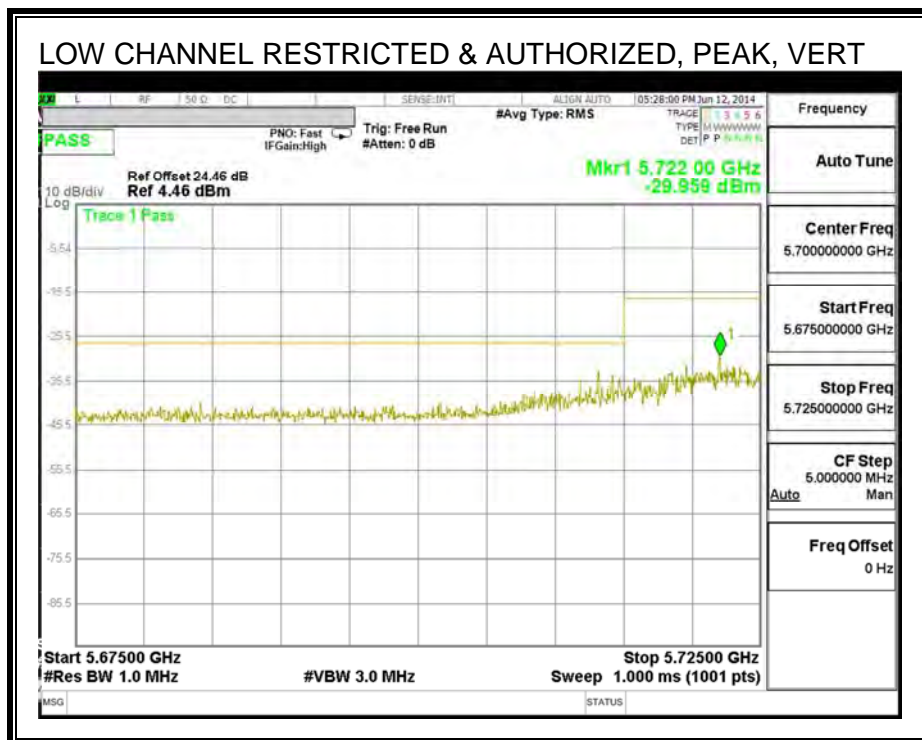
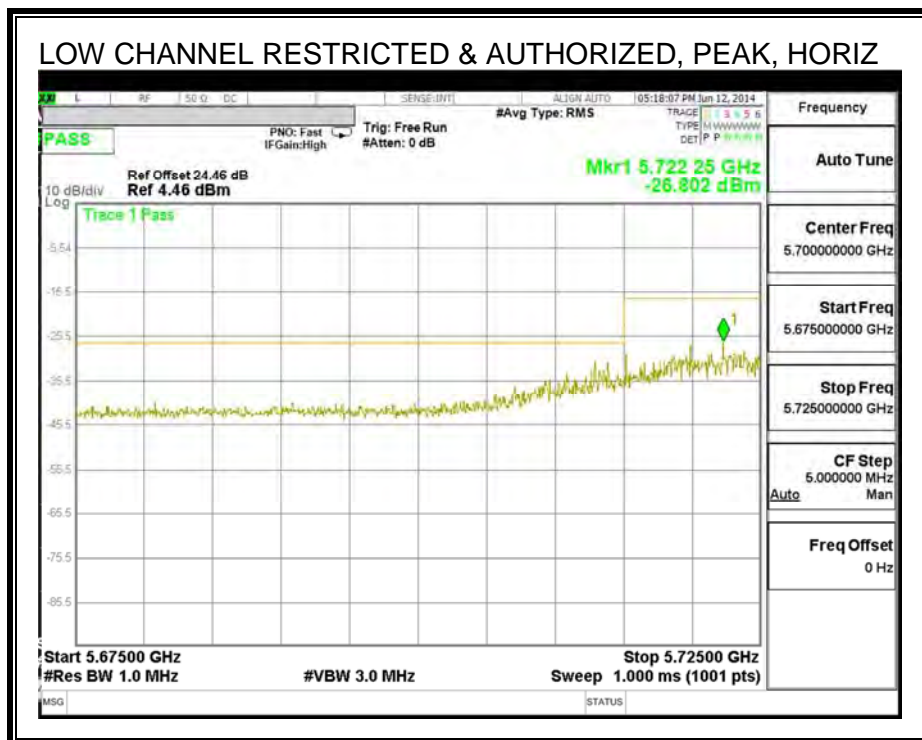

AUTHORIZED BANDEDGE (HIGH CHANNEL)

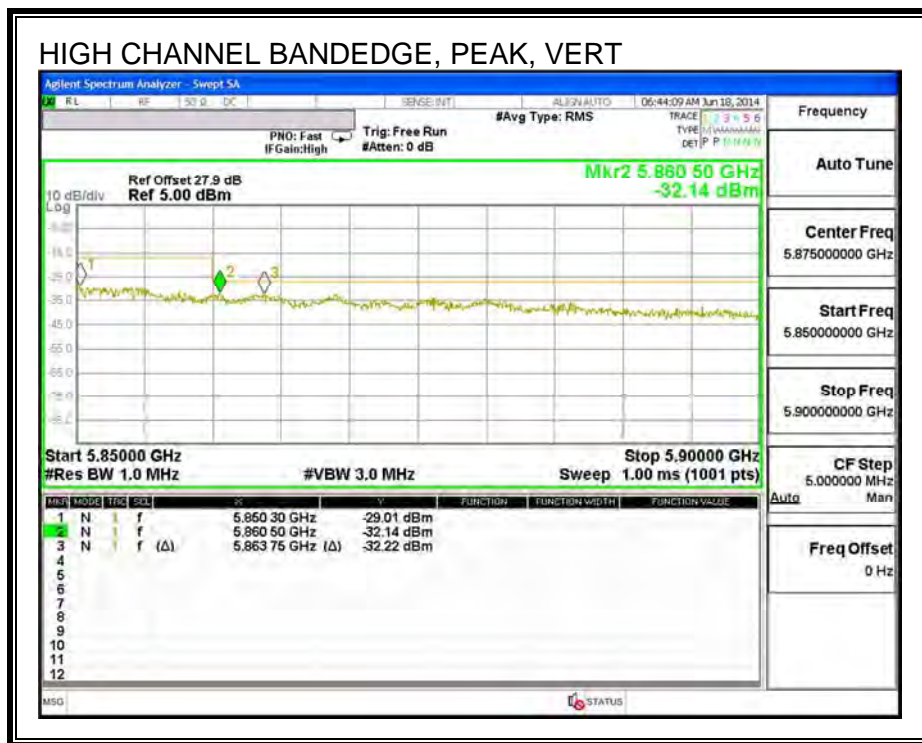
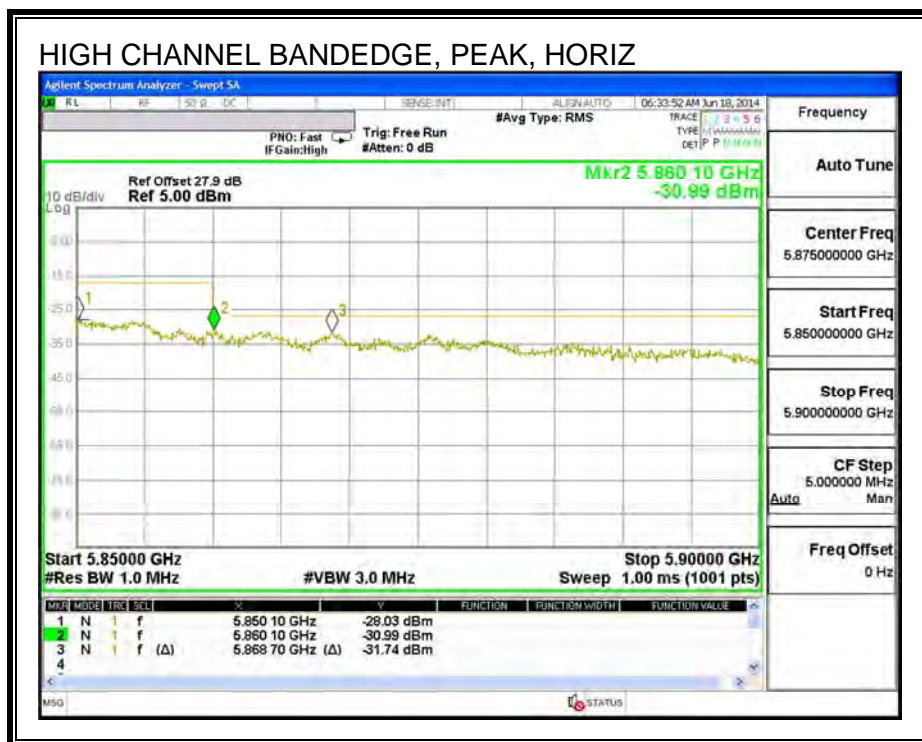

HARMONICS AND SPURIOUS EMISSIONS

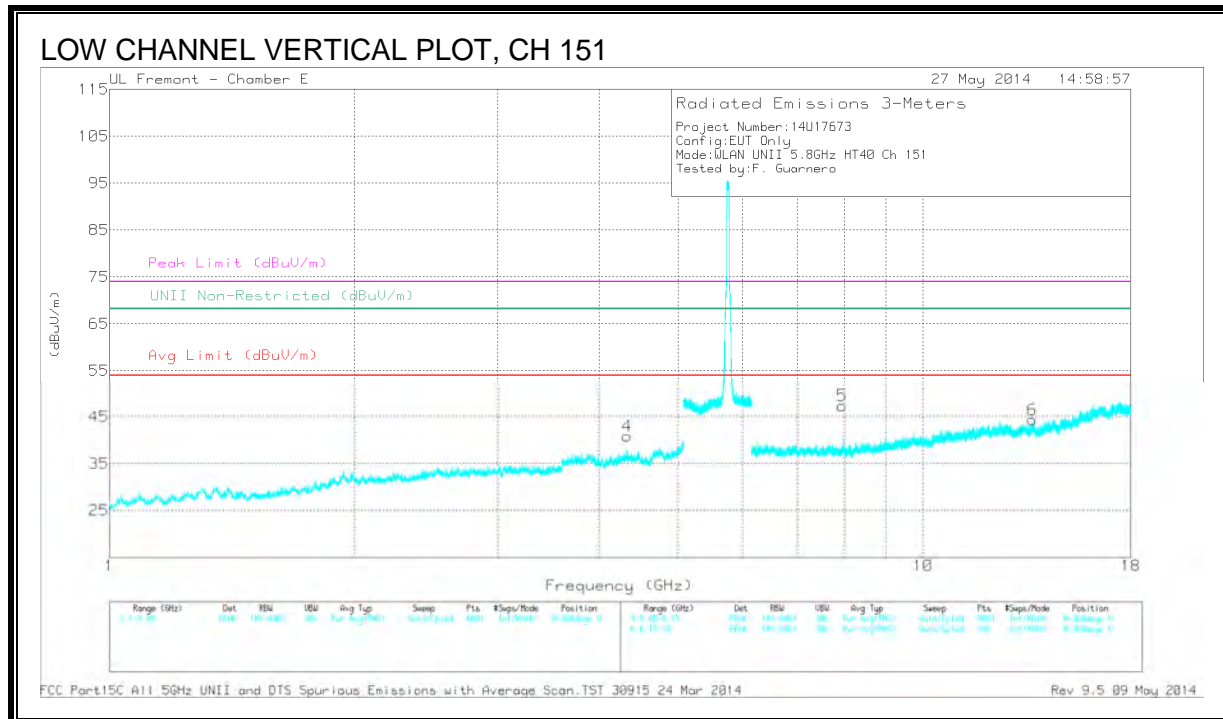
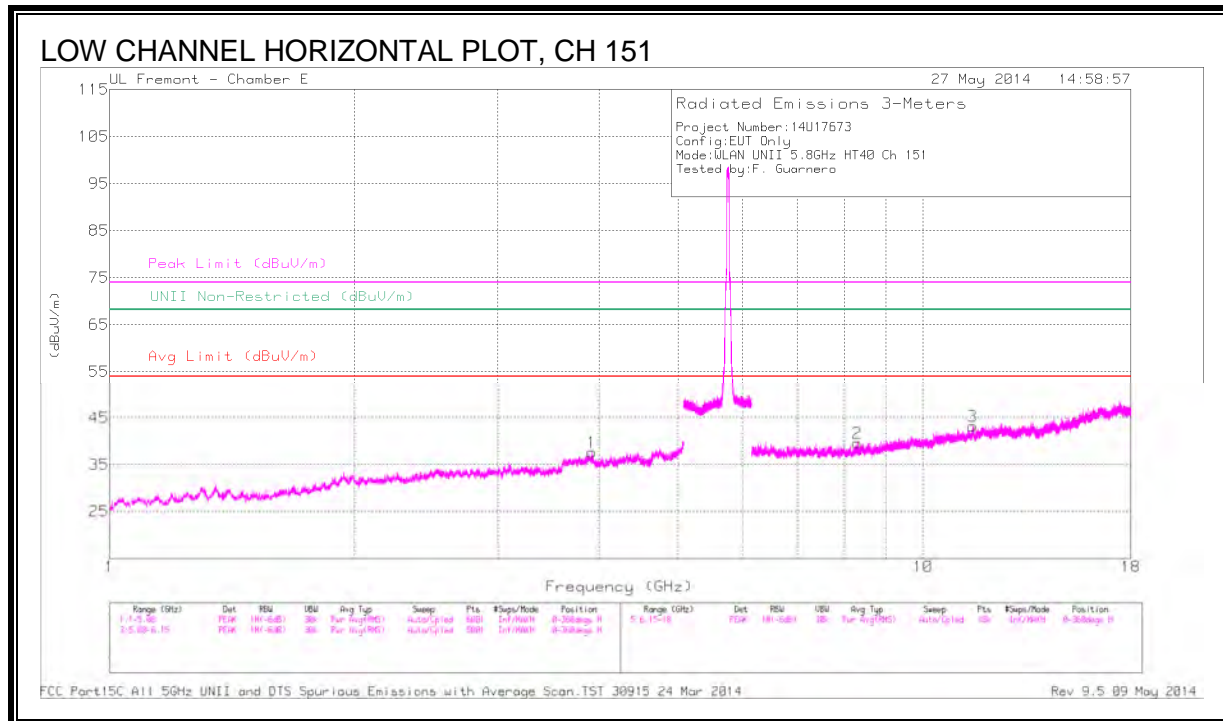

DATA

Frequency (GHz)	Meter Reading (dBuV)	Det	AF T346 (dB/m)	Amp/Cb/Filter /Pad (dB)	Corrected Reading (dBuV/m)	Avg Limit (dBuV/m)	Margin (dB)	Peak Limit (dBuV/m)	PK Margin (dB)	UNII Non-Restricted (dBuV/m)	PK Margin (dB)	Azimuth (Degs)	Height (cm)	Polarity
* 3.914	42.45	PK1	33.5	-30.5	45.45	-	-	74	-28.55	-	-	360	101	H
* 3.914	30.34	AD1	33.5	-30.5	33.34	54	-20.66	-	-	-	-	360	101	H
* 4.325	43	PK1	33.6	-30.4	46.2	-	-	74	-27.8	-	-	360	101	V
* 4.325	30.36	AD1	33.6	-30.4	33.56	54	-20.44	-	-	-	-	360	101	V
* 8.298	38.84	PK1	35.8	-26.9	47.74	-	-	74	-26.26	-	-	360	101	H
* 8.298	27.28	AD1	35.8	-26.9	36.18	54	-17.82	-	-	-	-	360	101	H
* 11.507	37.68	PK1	38.2	-24.4	51.48	-	-	74	-22.52	-	-	360	101	H
* 11.507	25.65	AD1	38.2	-24.4	39.45	54	-14.55	-	-	-	-	360	101	H
7.947	38.37	PK1	35.9	-27.1	47.17	-	-	-	-	68.2	-21.03	360	101	V
13.615	38.48	PK1	38.9	-24.6	52.78	-	-	-	-	68.2	-15.42	360	101	V

* - indicates frequency in CFR15.205/IC7.2.2 Restricted Band

PK1 - KDB789033 Method: Peak

AD1 - KDB789033 Method: AD Primary Power Average

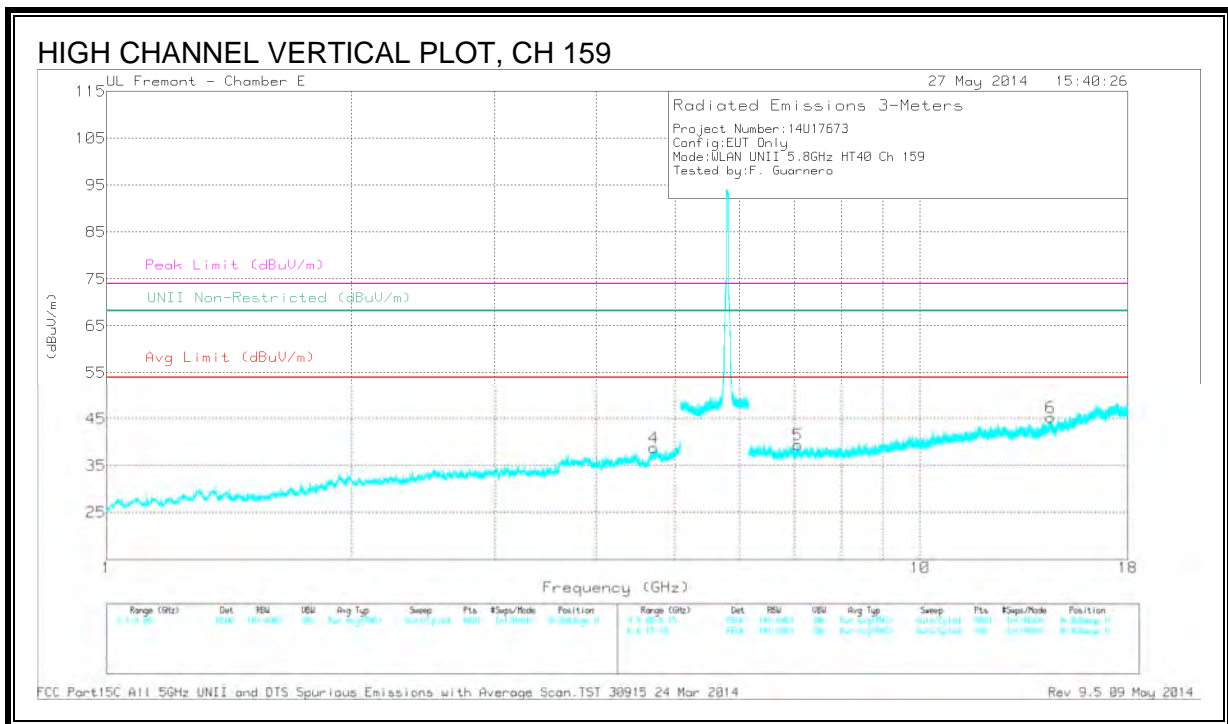
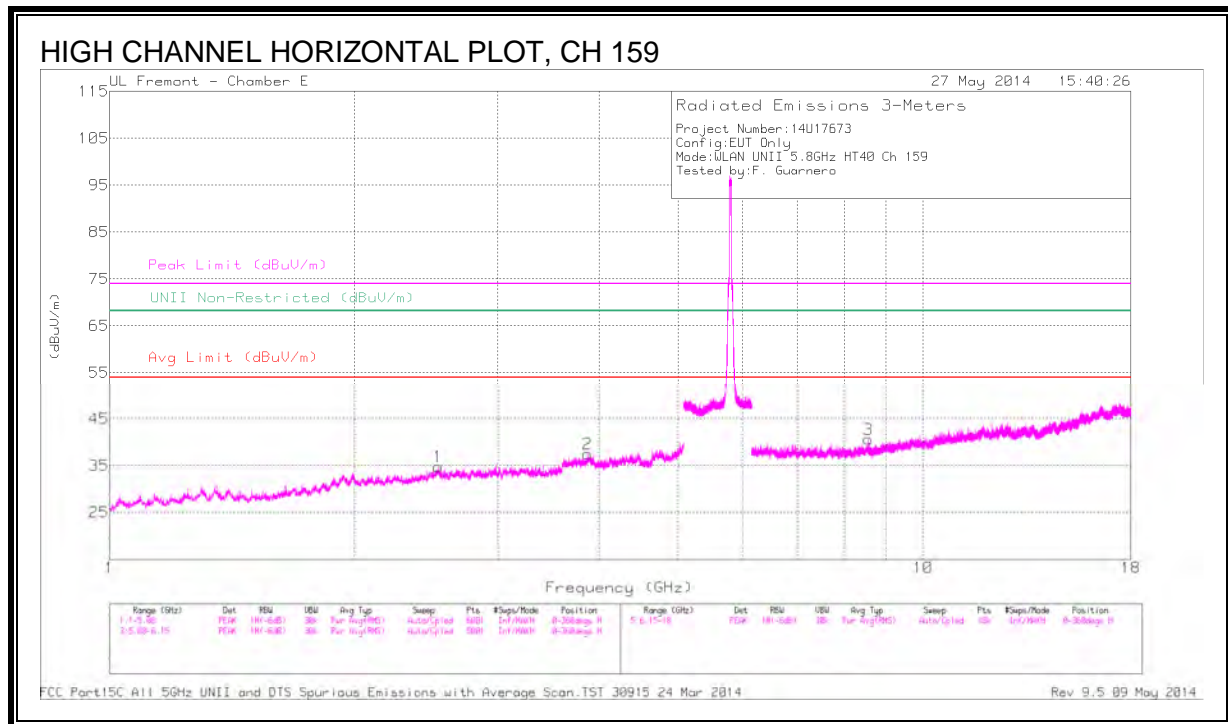

DATA

Frequency (GHz)	Meter Reading (dBuV)	Det	AF T346 (dB/m)	Amp/Cb/Filtr /Pad (dB)	Corrected Reading (dBuV/m)	Avg Limit (dBuV/m)	Margin (dB)	Peak Limit (dBuV/m)	PK Margin (dB)	UNII Non-Restricted (dBuV/m)	PK Margin (dB)	Azimuth (Degs)	Height (cm)	Polarity
* 3.871	42.22	PK1	33.5	-30.6	45.12	-	-	74	-28.88	-	-	360	200	H
* 3.871	30.74	AD1	33.5	-30.6	33.64	54	-20.36	-	-	-	-	360	200	H
* 4.71	42.09	PK1	34.2	-30.2	46.09	-	-	74	-27.91	-	-	360	200	V
* 4.71	30.49	AD1	34.2	-30.2	34.49	54	-19.51	-	-	-	-	360	200	V
2.534	42.41	PK1	32.4	-32.1	42.71	-	-	-	-	68.2	-25.49	360	200	H
7.071	40.09	PK1	35.8	-28.3	47.59	-	-	-	-	68.2	-20.61	360	200	V
8.556	38.34	PK1	35.9	-26.5	47.74	-	-	-	-	68.2	-20.46	360	200	H
14.464	38.68	PK1	39.3	-24.6	53.38	-	-	-	-	68.2	-14.82	360	200	V

* - indicates frequency in CFR15.205/IC7.2.2 Restricted Band

PK1 - KDB789033 Method: Peak

AD1 - KDB789033 Method: AD Primary Power Average

10.2.19. TX ABOVE 1G 802.11ac 80MHz MODE IN THE 5.8 GHz BAND

RESTRICTED & AUTHORIZED BANDEDGE (LOW CHANNEL, 155)

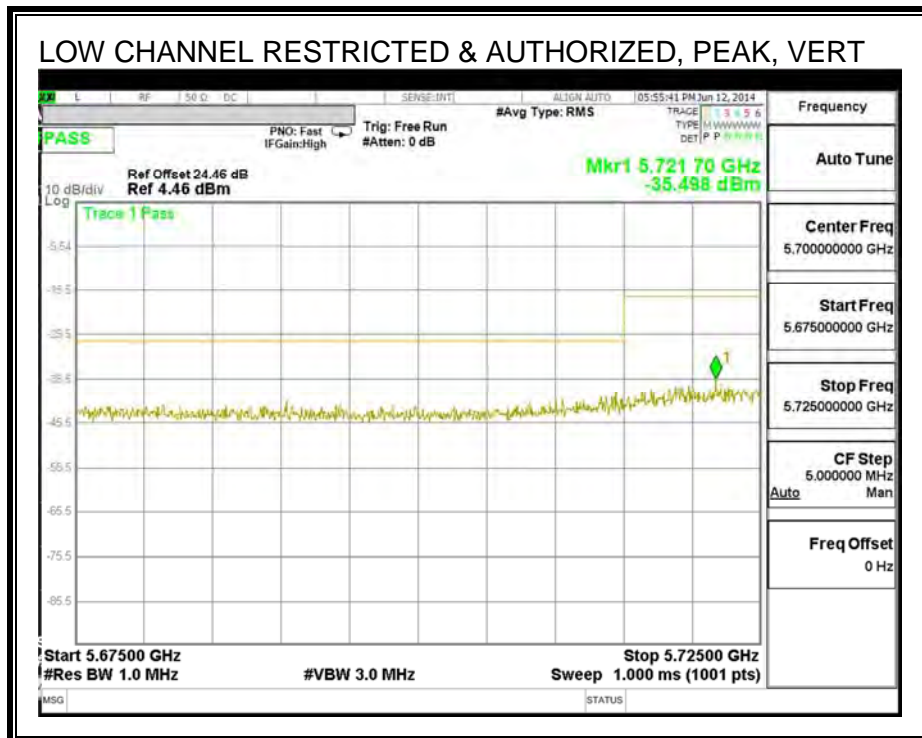
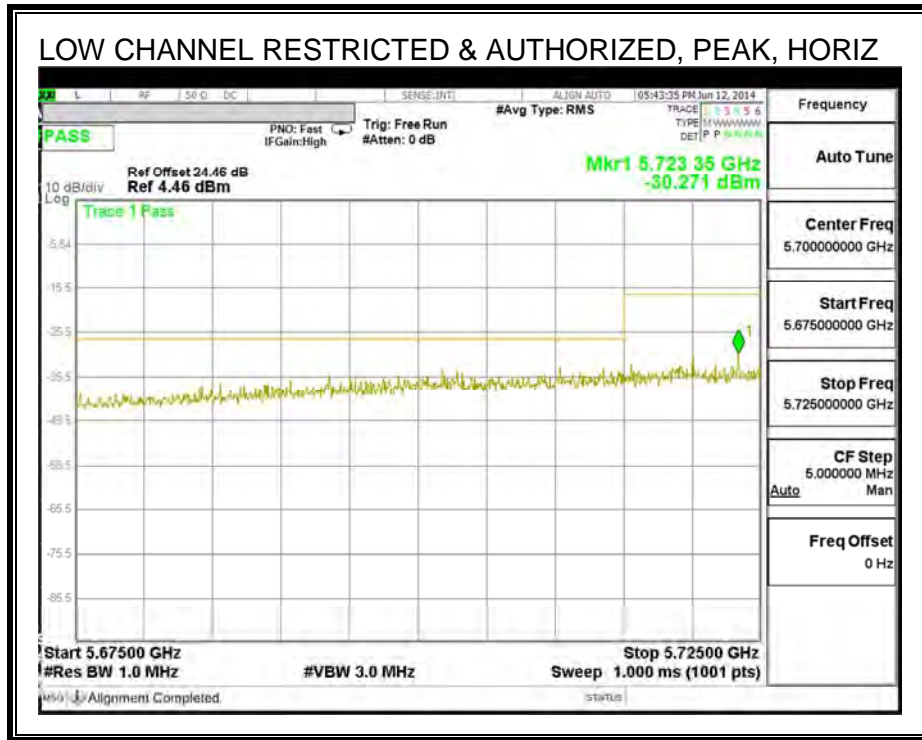

RESTRICTED & AUTHORIZED BANDEGE (CHANNEL, 155)

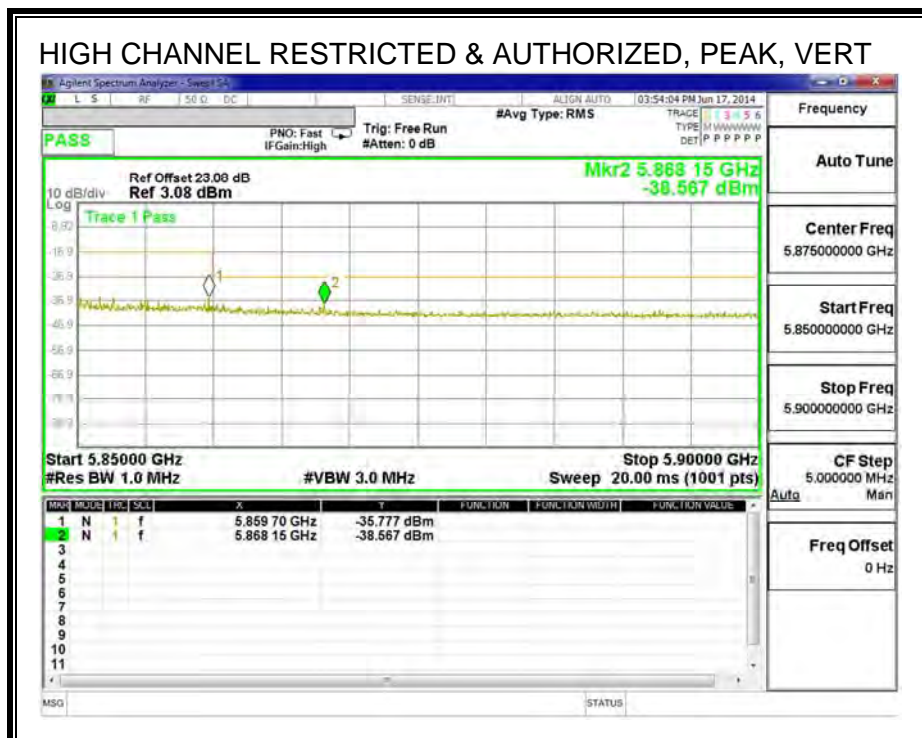
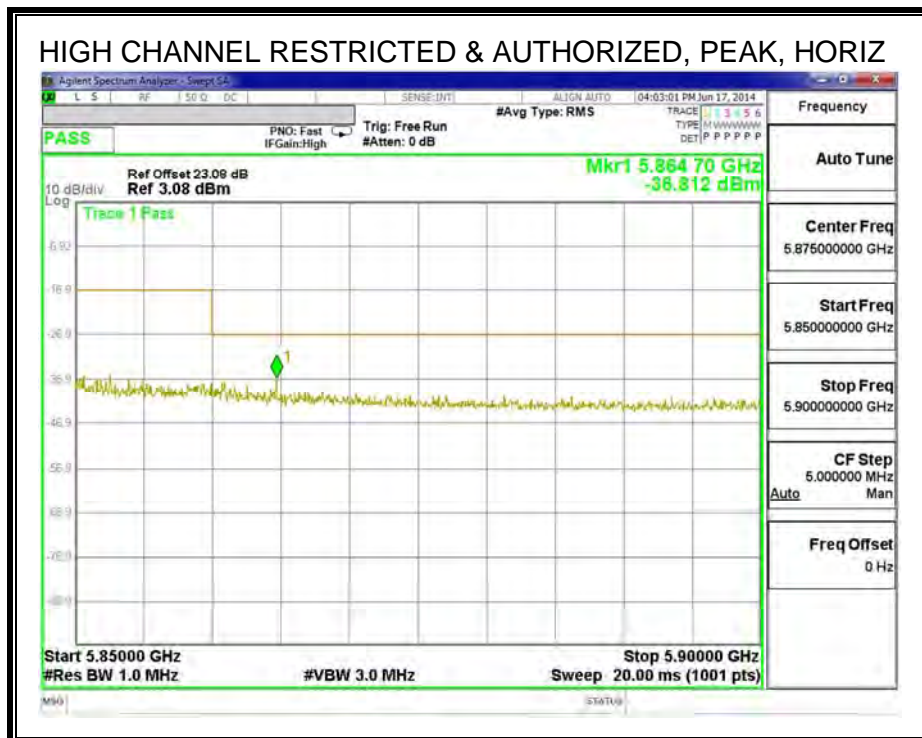

HARMONICS AND SPURIOUS EMISSIONS

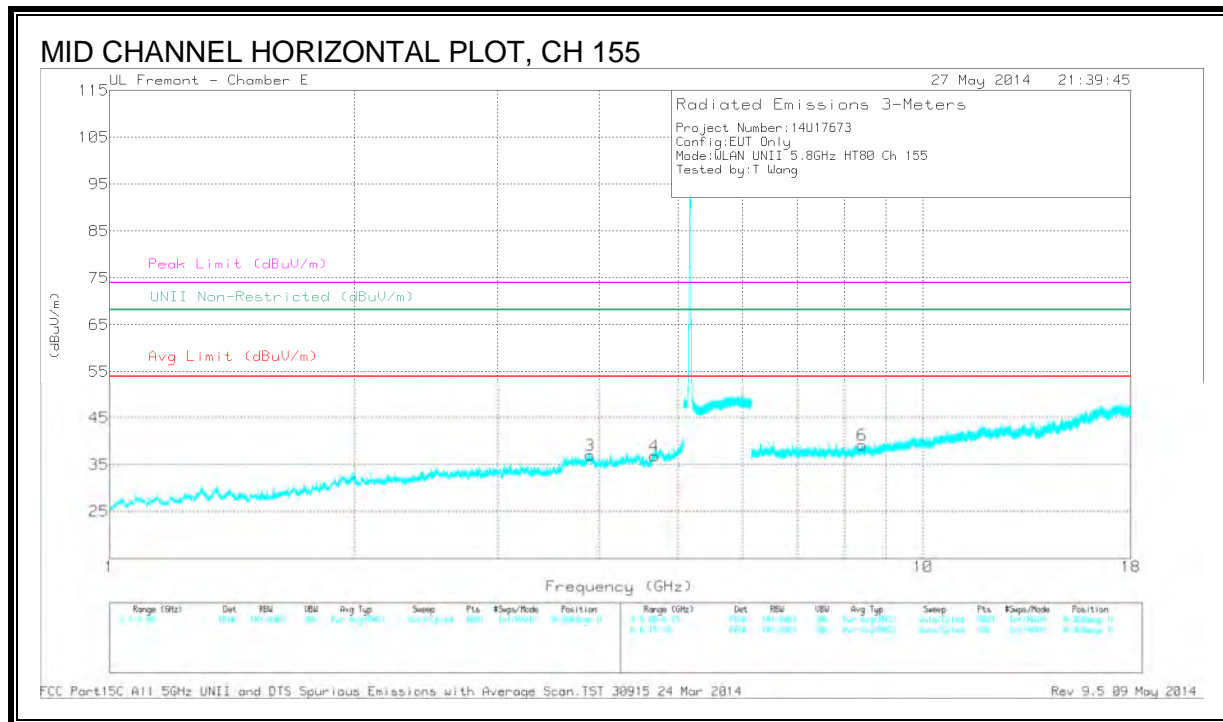
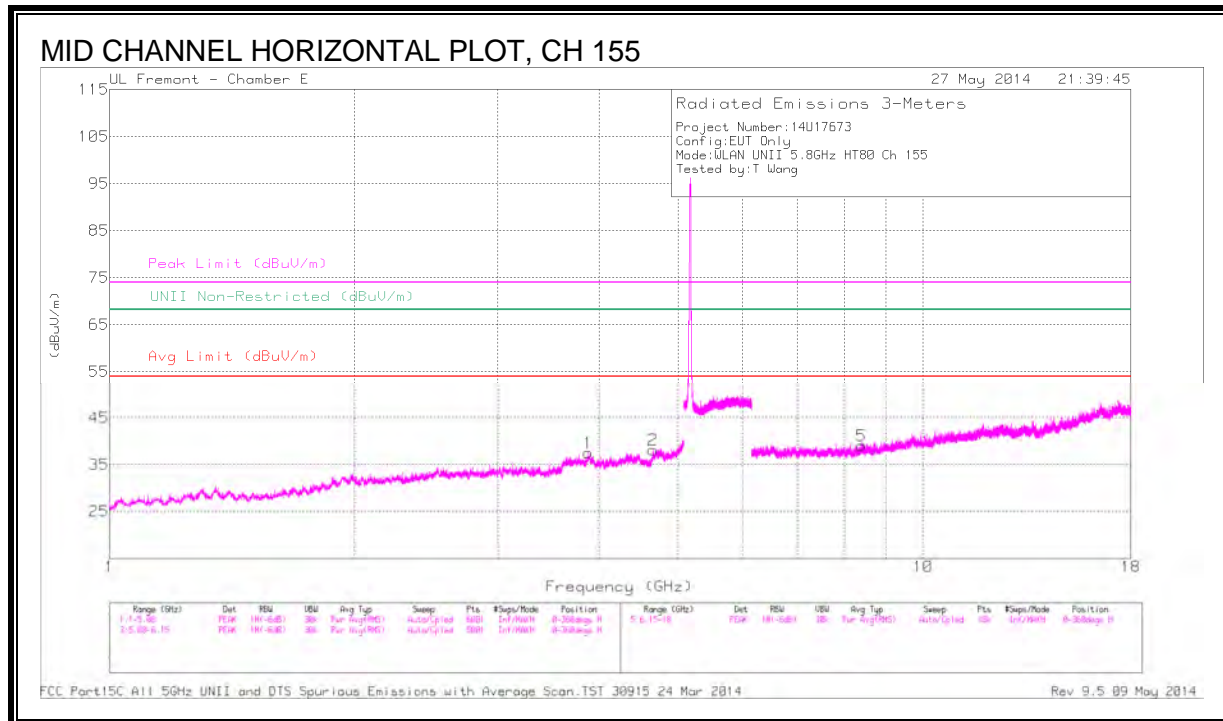

DATA

Frequency (GHz)	Meter Reading (dBuV)	Det	AF T346 (dB/m)	Amp/Cb/Filtr /Pad (dB)	DC Corr (dB)	Corrected Reading (dBuV/m)	Avg Limit (dBuV/m)	Margin (dB)	Peak Limit (dBuV/m)	PK Margin (dB)	UNII Non-Restricted (dBuV/m)	PK Margin (dB)	Azimuth (Degs)	Height (cm)	Polarity
* 3.879	42.01	PK1	33.5	-30.5	0	45.01	-	-	74	-28.99	-	-	94	215	H
* 3.867	30.74	AD1	33.5	-30.7	.2	33.74	54	-20.26	-	-	-	-	94	215	H
* 4.646	41.85	PK1	34.1	-29.8	0	46.15	-	-	74	-27.85	-	-	14	117	H
* 4.655	30.12	AD1	34.1	-29.7	.2	34.72	54	-19.28	-	-	-	-	14	117	H
* 3.884	42.56	PK1	33.5	-30.5	0	45.56	-	-	74	-28.44	-	-	209	340	V
* 3.882	30.72	AD1	33.5	-30.5	.2	33.92	54	-20.08	-	-	-	-	209	340	V
* 4.676	41.57	PK1	34.2	-29.8	0	45.97	-	-	74	-28.03	-	-	257	264	V
* 4.667	30.08	AD1	34.1	-29.7	.2	34.68	54	-19.32	-	-	-	-	257	264	V
* 8.401	37.91	PK1	35.9	-26.9	0	46.91	-	-	74	-27.09	-	-	170	113	H
* 8.388	26.74	AD1	35.9	-27.1	.2	35.74	54	-18.26	-	-	-	-	170	113	H
* 8.416	37.75	PK1	35.9	-26.9	0	46.75	-	-	74	-27.25	-	-	243	131	V
* 8.412	26.76	AD1	35.9	-26.9	.2	35.96	54	-18.04	-	-	-	-	243	131	V

* - indicates frequency in CFR15.205/IC7.2.2 Restricted Band

PK1 - KDB789033 Method: Peak

AD1 - KDB789033 Method: AD Primary Power Average

10.3. WORST-CASE BELOW 1 GHz

SPURIOUS EMISSIONS 30 TO 1000 MHz (WORST-CASE CONFIGURATION, HORIZONTAL)

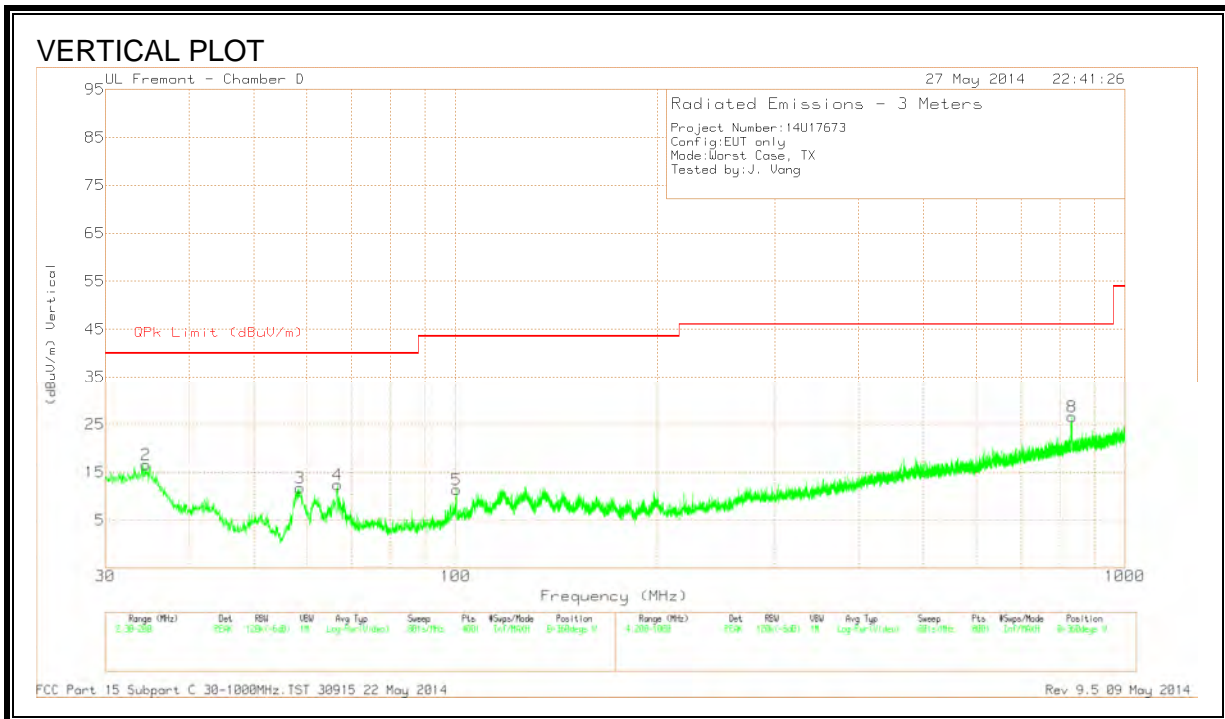
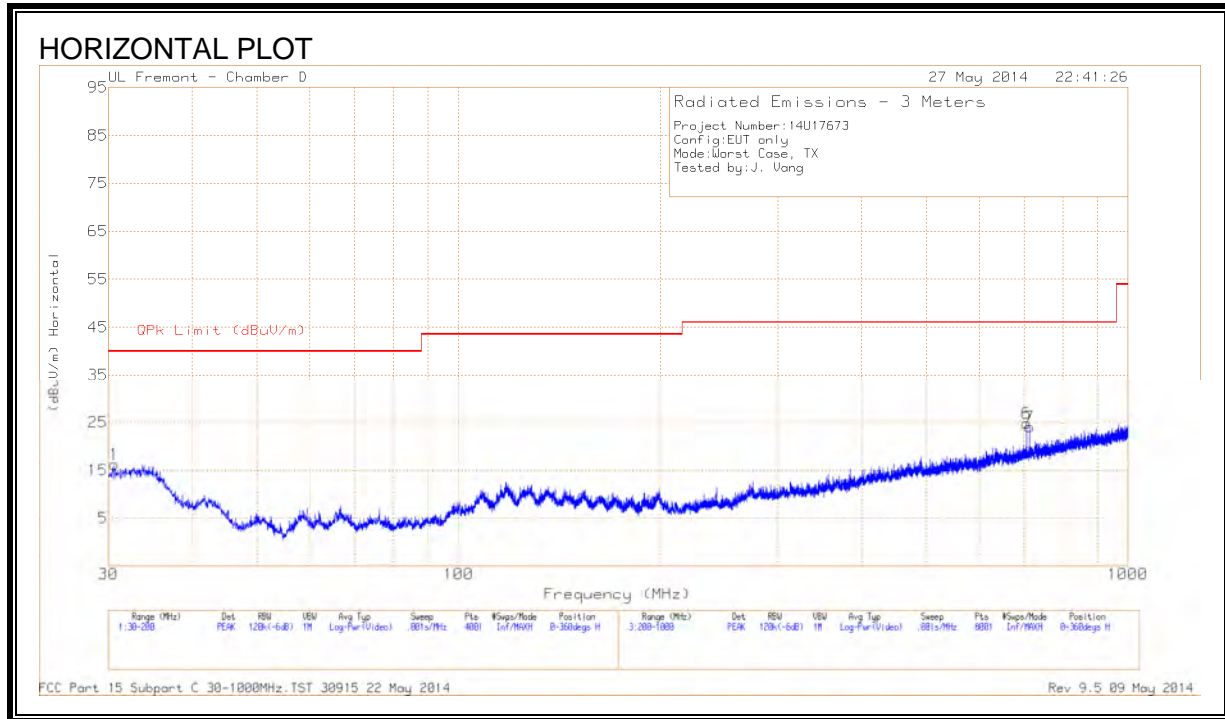

HORIZONTAL & VERTICAL DATA

Marker	Frequency (MHz)	Meter Reading (dBuV)	Det	Hybrid	Amp/Cbl (dB)	Corrected Reading (dBuV/m)	QPk Limit (dBuV/m)	Margin (dB)	Azimuth (Degs)	Height (cm)	Polarity
1	30.6375	26.97	PK	21	-31.7	16.27	40	-23.73	0-360	301	H
2	34.505	30.39	PK	18.1	-31.9	16.59	40	-23.41	0-360	100	V
3	58.56	35.74	PK	7.6	-31.6	11.74	40	-28.26	0-360	100	V
4	66.635	35.83	PK	8.2	-31.6	12.43	40	-27.57	0-360	100	V
5	100.3375	32.69	PK	10.4	-31.7	11.39	43.52	-32.13	0-360	100	V
6	705.7	34.03	PK	20.2	-29.4	24.83	46.02	-21.19	0-360	300	H
7	713.1	33.1	PK	20.4	-29.4	24.1	46.02	-21.92	0-360	300	H
8	833.4	33.73	PK	21.8	-28.9	26.63	46.02	-19.39	0-360	100	V

PK - Peak detector

10.4. WORST-CASE 18 to 26 GHz

SPURIOUS EMISSIONS 18000 TO 26000 MHz (WORST-CASE CONFIGURATION, HORIZONTAL & VERTICAL)

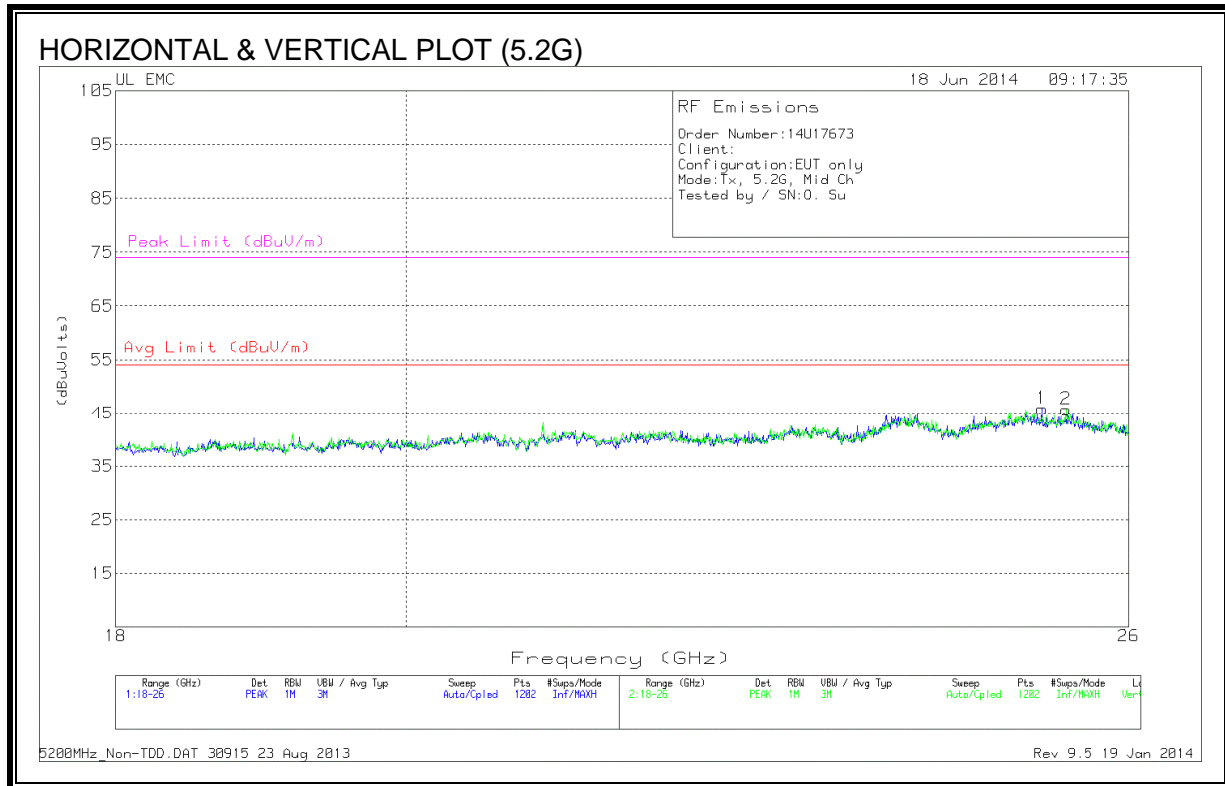

HORIZONTAL & VERTICAL DATA

Marker	Frequency (GHz)	Meter Reading (dBuV)	Det	AF T89 (dB/m)	Amp/Cbl (dB)	Dist Corr (dB)	Corrected Reading (dBuVolts)	Avg Limit (dBuV/m)	Margin (dB)	Peak Limit (dBuV/m)	PK Margin (dB)
1	25.194	44.23	PK	33.9	-22.8	-9.5	45.83	54	-8.17	74	-28.17
2	25.414	44.07	PK	34	-22.9	-9.5	45.67	54	-8.33	74	-28.33

PK - Peak detector

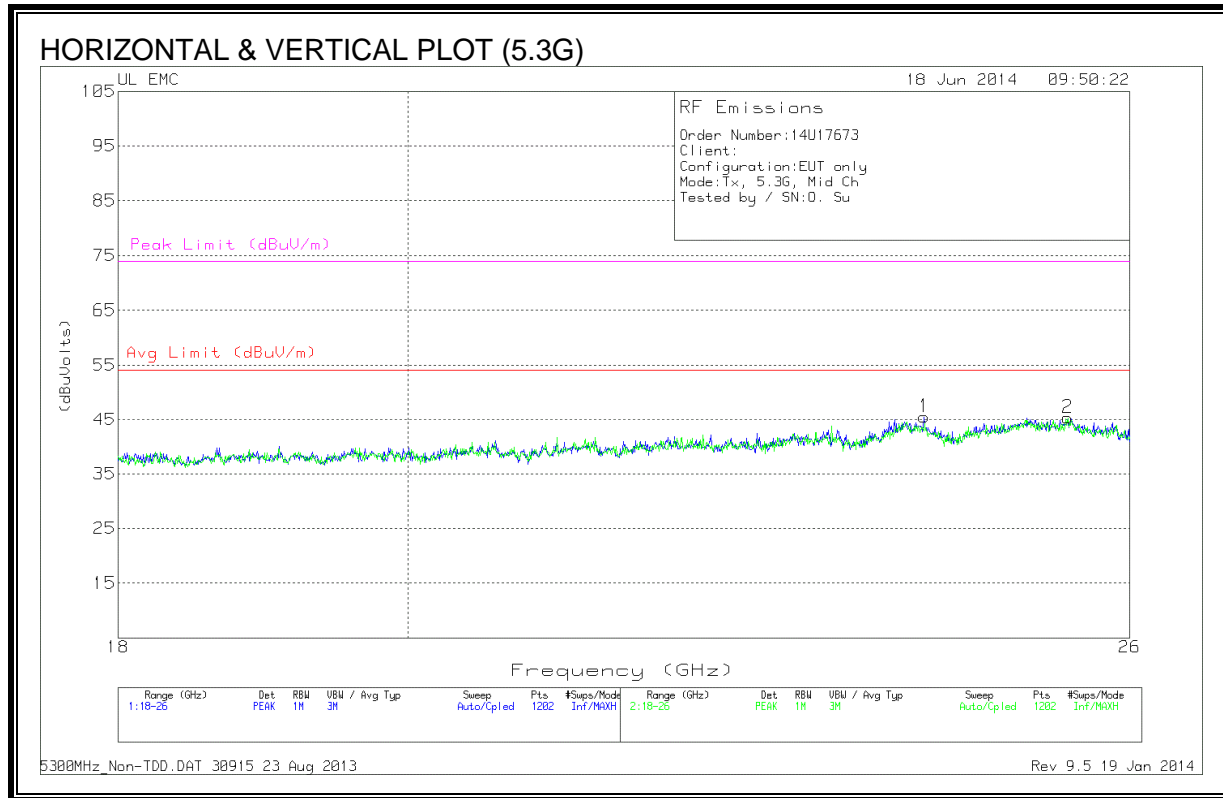

HORIZONTAL & VERTICAL DATA

Marker	Frequency (GHz)	Meter Reading (dBuV)	Det	AF T89 (dB/m)	Amp/Cbl (dB)	Dist Corr (dB)	Corrected Reading (dBuVolts)	Avg Limit (dBuV/m)	Margin (dB)	Peak Limit (dBuV/m)	PK Margin (dB)
1	24.128	44	PK	33.7	-22.7	-9.5	45.5	54	-8.5	74	-28.5
2	25.42	43.83	PK	34	-23	-9.5	45.33	54	-8.67	74	-28.67

PK - Peak detector

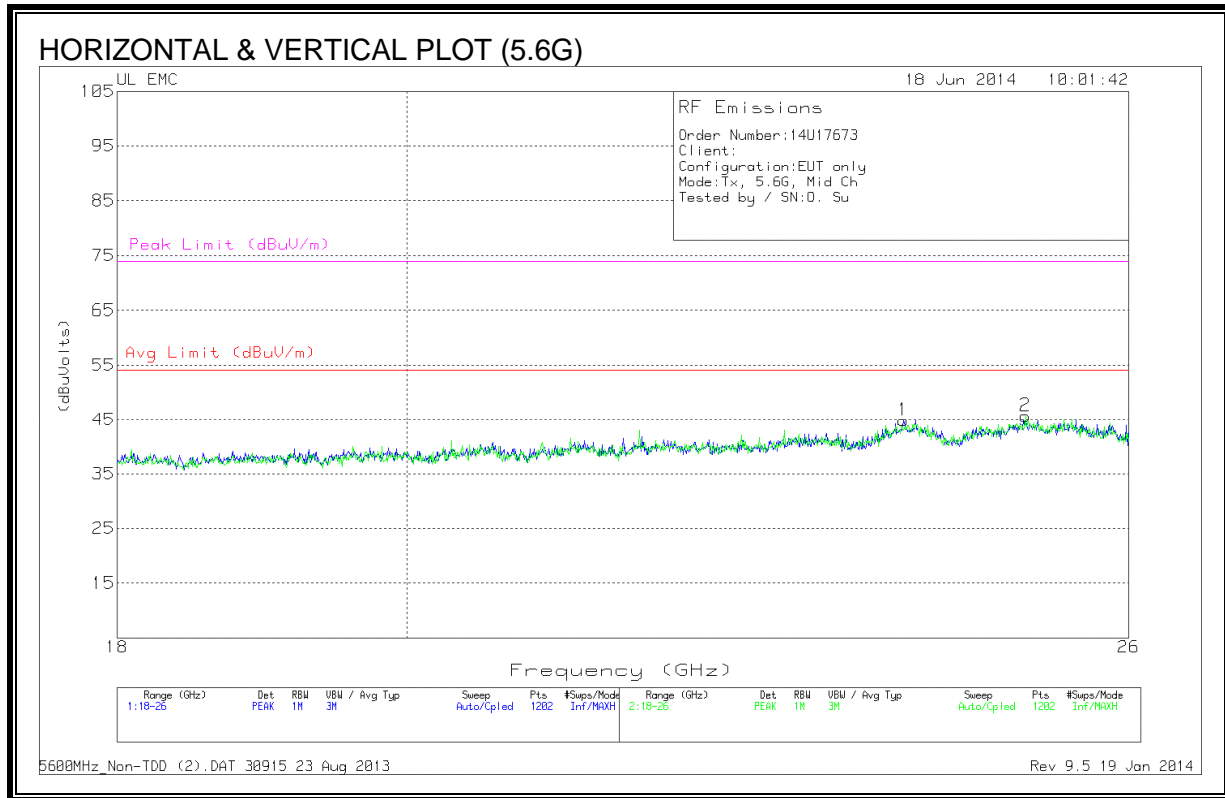

HORIZONTAL & VERTICAL DATA

Marker	Frequency (GHz)	Meter Reading (dBuV)	Det	AF T89 (dB/m)	Amp/Cbl (dB)	Dist Corr (dB)	Corrected Reading (dBuVolts)	Avg Limit (dBuV/m)	Margin (dB)	Peak Limit (dBuV/m)	PK Margin (dB)
1	23.955	43.43	PK	33.6	-22.7	-9.5	44.83	54	-9.17	74	-29.17
2	25.041	43.77	PK	34	-22.6	-9.5	45.67	54	-8.33	74	-28.33

PK - Peak detector

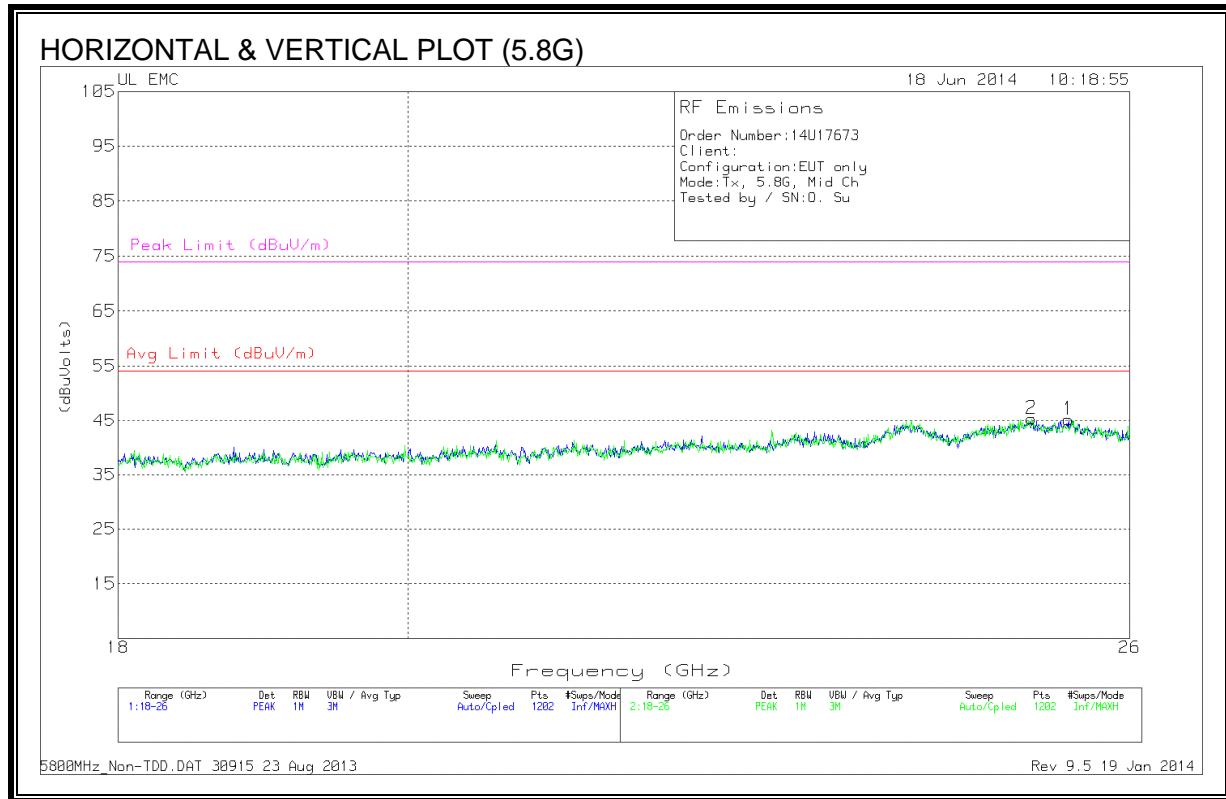

HORIZONTAL & VERTICAL DATA

Marker	Frequency (GHz)	Meter Reading (dBuV)	Det	AF T89 (dB/m)	Amp/Cbl (dB)	Dist Corr (dB)	Corrected Reading (dBuVolts)	Avg Limit (dBuV/m)	Margin (dB)	Peak Limit (dBuV/m)	PK Margin (dB)
1	25.427	43.77	PK	34	-23.1	-9.5	45.17	54	-8.83	74	-28.83
2	25.087	43.83	PK	33.9	-22.9	-9.5	45.33	54	-8.67	74	-28.67

PK - Peak detector

10.5. WORST-CASE 26 to 40 GHz

SPURIOUS EMISSIONS 26TO 40 GHz (WORST-CASE CONFIGURATION)

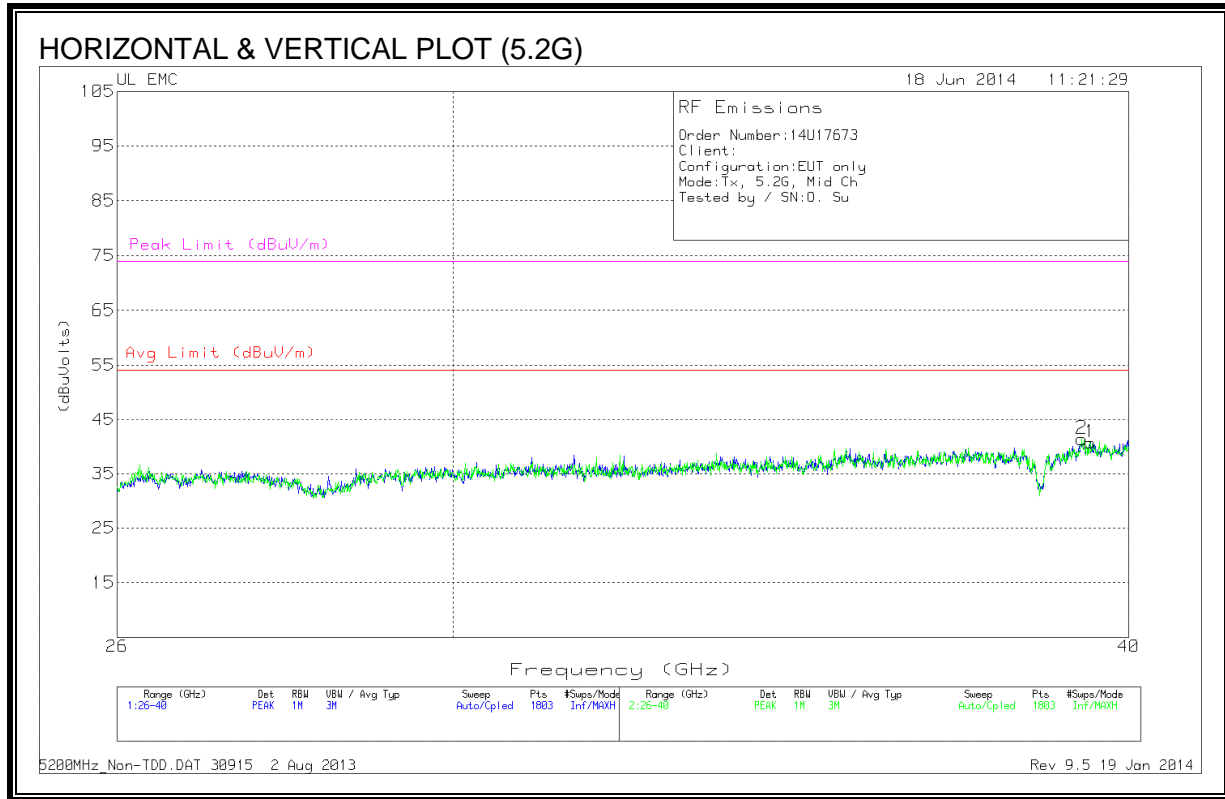

HORIZONTAL & VERTICAL DATA

Marker	Frequency (GHz)	Meter Reading (dBuV)	Det	T90 AF (dB/m)	Amp/Cbl (dB)	Dist Corr (dB)	Corrected Reading (dBuVolts)	Avg Limit (dBuV/m)	Margin (dB)	Peak Limit (dBuV/m)	PK Margin (dB)
1	39.347	48.17	PK	38.1	-36.1	-9.5	40.67	54	-13.33	74	-33.33
2	39.208	48.23	PK	38.4	-35.8	-9.5	41.33	54	-12.67	74	-32.67

PK - Peak detector

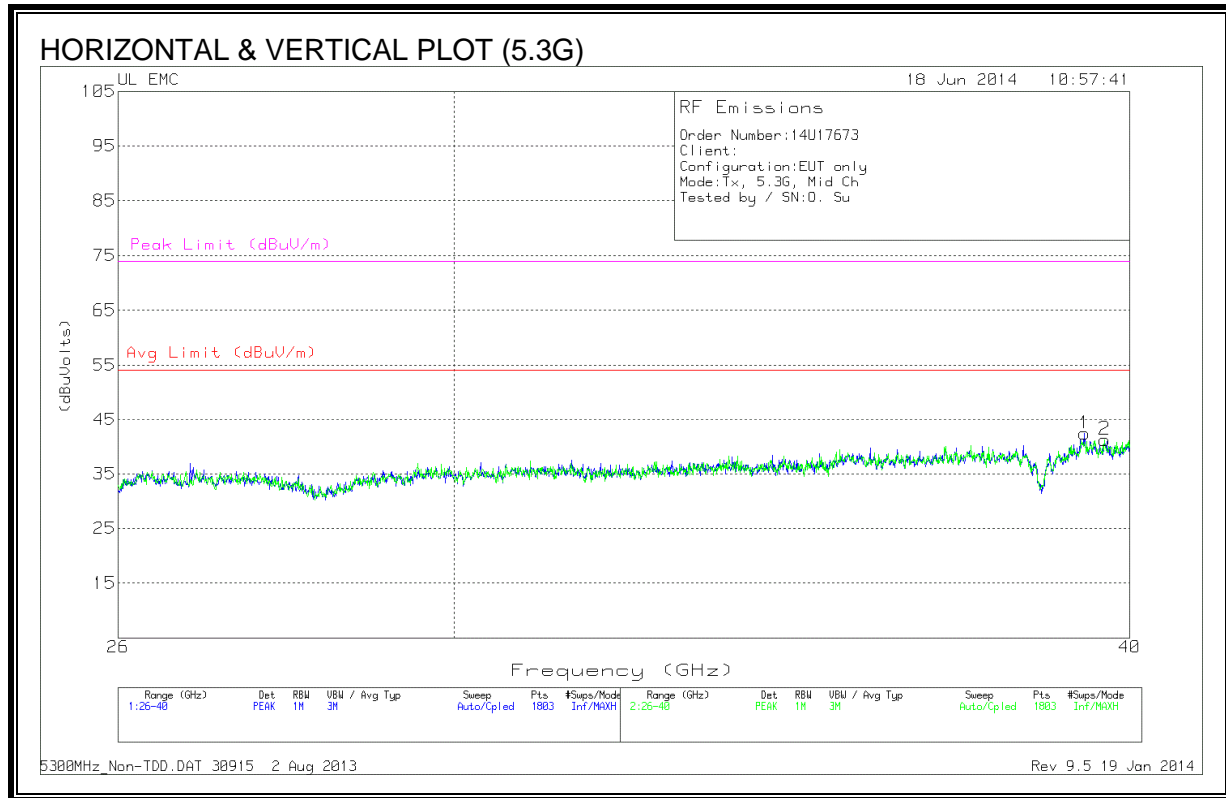

HORIZONTAL & VERTICAL DATA

Marker	Frequency (GHz)	Meter Reading (dBuV)	Det	T90 AF (dB/m)	Amp/Cbl (dB)	Dist Corr (dB)	Corrected Reading (dBuVolts)	Avg Limit (dBuV/m)	Margin (dB)	Peak Limit (dBuV/m)	PK Margin (dB)
1	39.239	49.53	PK	38.5	-36.2	-9.5	42.33	54	-11.67	74	-31.67
2	39.573	48.87	PK	37.3	-35.5	-9.5	41.17	54	-12.83	74	-32.83

PK - Peak detector

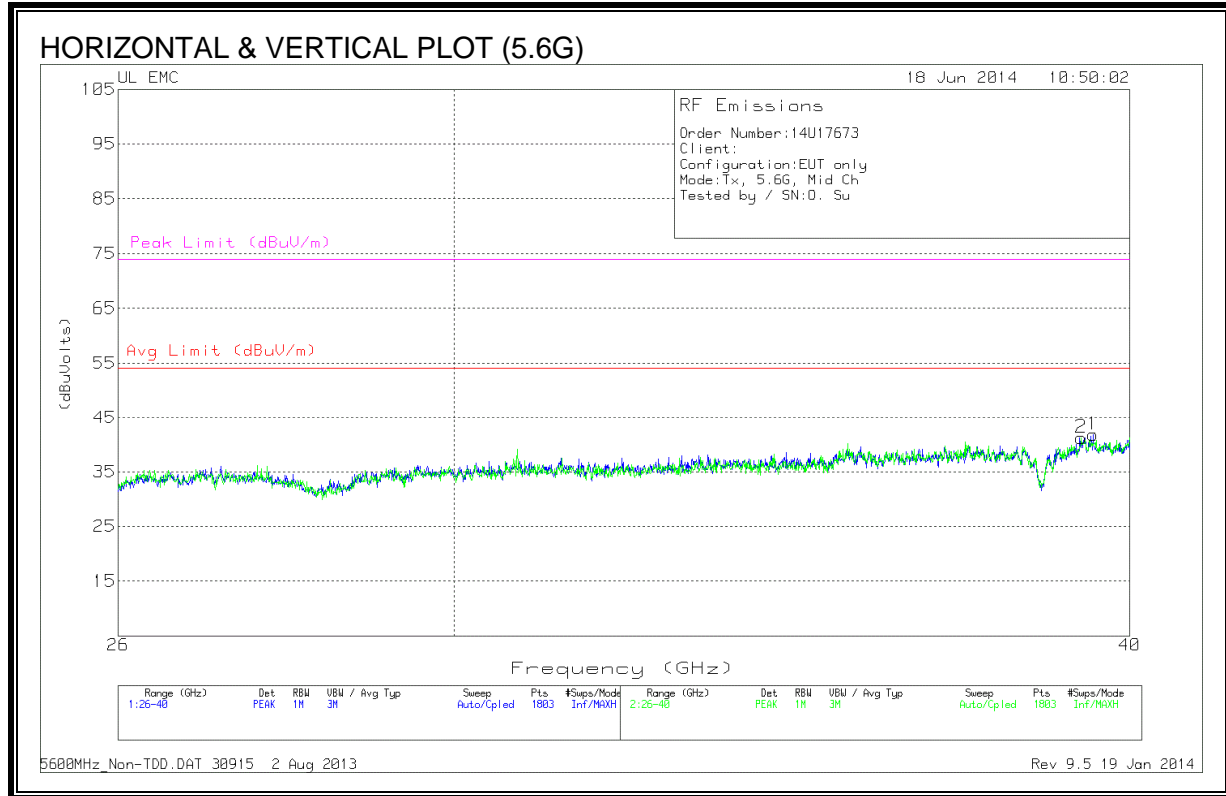

HORIZONTAL & VERTICAL DATA

Marker	Frequency (GHz)	Meter Reading (dBuV)	Det	T90 AF (dB/m)	Amp/Cbl (dB)	Dist Corr (dB)	Corrected Reading (dBuVolts)	Avg Limit (dBuV/m)	Margin (dB)	Peak Limit (dBuV/m)	PK Margin (dB)
1	39.378	49.33	PK	37.9	-35.9	-9.5	41.83	54	-12.17	74	-32.17
2	39.184	48.57	PK	38.2	-36.1	-9.5	41.17	54	-12.83	74	-32.83

PK - Peak detector

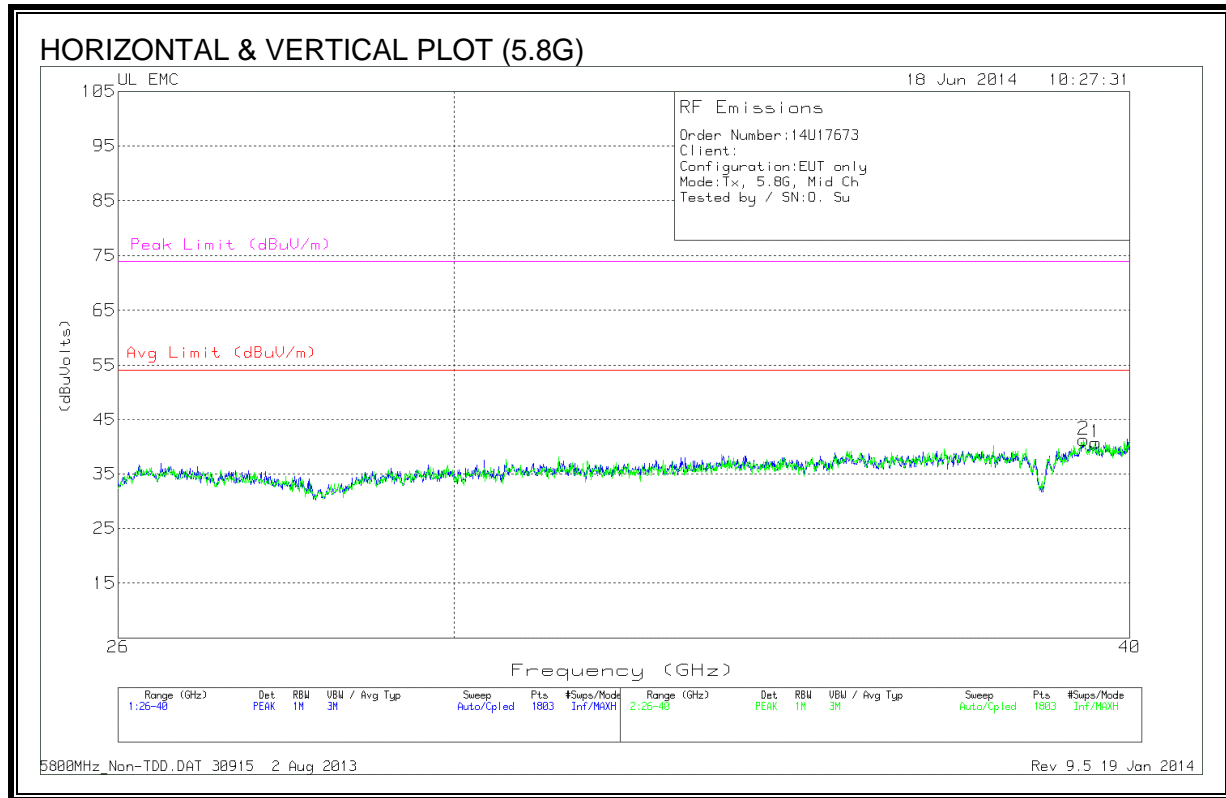

HORIZONTAL & VERTICAL DATA

Marker	Frequency (GHz)	Meter Reading (dBuV)	Det	T90 AF (dB/m)	Amp/Cbl (dB)	Dist Corr (dB)	Corrected Reading (dBuVolts)	Avg Limit (dBuV/m)	Margin (dB)	Peak Limit (dBuV/m)	PK Margin (dB)
1	39.425	47.97	PK	37.7	-35.5	-9.5	40.67	54	-13.33	74	-33.33
2	39.223	48.17	PK	38.5	-36	-9.5	41.17	54	-12.83	74	-32.83

PK - Peak detector

11. AC POWER LINE CONDUCTED EMISSIONS

LIMITS

FCC §15.207 (a)

Frequency of Emission (MHz)	Conducted Limit (dBuV)	
	Quasi-peak	Average
0.15-0.5	66 to 56	56 to 46
0.5-5	56	46
5-30	60	50

*Decreases with the logarithm of the frequency.

TEST PROCEDURE

The EUT is placed on a non-conducting table 40 cm from the vertical ground plane and 80 cm above the horizontal ground plane. The EUT is configured in accordance with ANSI C63.4.

The receiver is set to a resolution bandwidth of 9 kHz. Peak detection is used unless otherwise noted as quasi-peak or average.

Line conducted data is recorded for both NEUTRAL and HOT lines.

RESULTS

WORST EMISSIONS

Line-L1 .15 - 30MHz

Trace Markers

Marker	Frequency (MHz)	Meter Reading (dBuV)	Det	T24 IL L1 (dB)	LC Cables 1&3 (dB)	Corrected Reading dBuV	CISPR 22 Class B QP	Margin to Limit (dB)	CISPR 22 Class B Avg	Margin to Limit (dB)
1	.1635	41.37	PK	1.2	0	42.57	65.3	-22.73	-	-
2	.1635	18.65	Av	1.2	0	19.85	-	-	55.3	-35.45
3	.7665	42.72	PK	.3	0	43.02	56	-12.98	-	-
4	.7665	27.26	Av	.3	0	27.56	-	-	46	-18.44
5	6.4185	29.81	PK	.2	.1	30.11	60	-29.89	-	-
6	6.4185	18.09	Av	.2	.1	18.39	-	-	50	-31.61

Line-L2 .15 - 30MHz

Trace Markers

Marker	Frequency (MHz)	Meter Reading (dBuV)	Det	T24 IL L2 (dB)	LC Cables 2&3 (dB)	Corrected Reading dBuV	CISPR 22 Class B QP	Margin to Limit (dB)	CISPR 22 Class B Avg	Margin to Limit (dB)
7	.1635	39.91	PK	1.3	0	41.21	65.3	-24.09	-	-
8	.1635	18.55	Av	1.3	0	19.85	-	-	55.3	-35.45
9	.7665	41.32	PK	.3	0	41.62	56	-14.38	-	-
10	.7665	26.96	Av	.3	0	27.26	-	-	46	-18.74
11	6.0675	29.96	PK	.2	.1	30.26	60	-29.74	-	-
12	6.0675	19.02	Av	.2	.1	19.32	-	-	50	-30.68

LINE 1 RESULTS

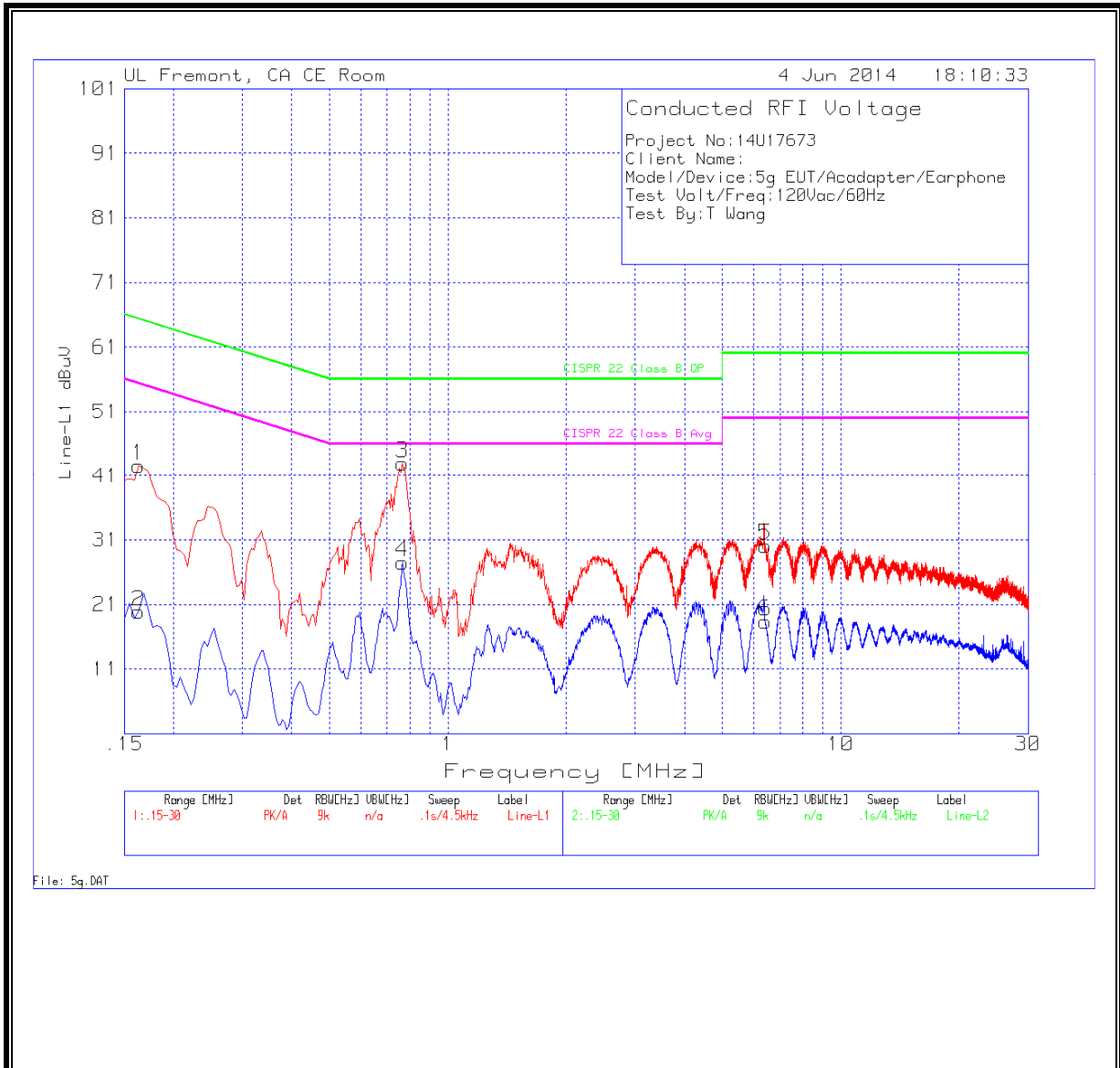

LINE 2 RESULTS

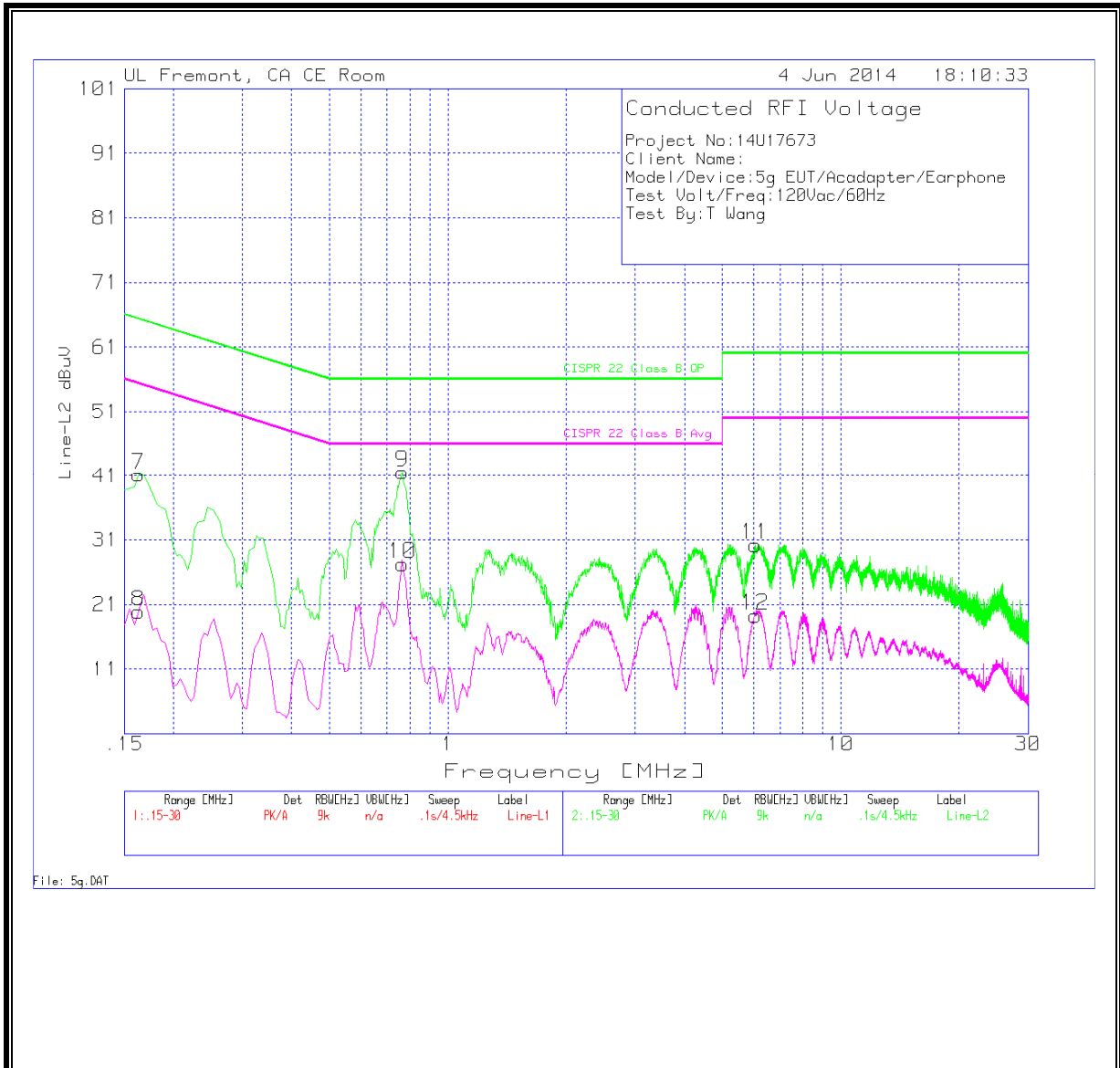

12. DYNAMIC FREQUENCY SELECTION

Refer to Model A1586 FCC UNII WLAN report, section 12.