



**FCC CFR47 PART 15 SUBPART E  
INDUSTRY CANADA RSS-210 ISSUE 8**

**CERTIFICATION TEST REPORT**

**FOR**

**QUAD-BAND RADIO WITH WLAN AND BT RADIO**

**MODEL NUMBER: A1507**

**FCC ID: BCG-E2694B  
IC: 579C-E2694B**

**REPORT NUMBER: 13U15637-10**

**ISSUE DATE: JULY 29, 2013**

*Prepared for*

**APPLE, INC.  
1 INFINITE LOOP  
CUPERTINO, CA 95014, U.S.A.**

*Prepared by*

**UL VERIFICATION SERVICES INC.  
47173 BENICIA STREET  
FREMONT, CA 94538, U.S.A.  
TEL: (510) 771-1000  
FAX: (510) 661-0888**



**NVLAP LAB CODE 200065-0**

Revision History

<u>Rev.</u>	<u>Issue Date</u>	<u>Revisions</u>	<u>Revised By</u>
--	07/29/13	Initial Issue	T. Chan

## TABLE OF CONTENTS

<b>1. ATTESTATION OF TEST RESULTS .....</b>	<b>6</b>
<b>2. TEST METHODOLOGY .....</b>	<b>7</b>
<b>3. FACILITIES AND ACCREDITATION .....</b>	<b>7</b>
<b>4. CALIBRATION AND UNCERTAINTY .....</b>	<b>7</b>
4.1. <i>MEASURING INSTRUMENT CALIBRATION .....</i>	<i>7</i>
4.2. <i>SAMPLE CALCULATION .....</i>	<i>7</i>
4.3. <i>MEASUREMENT UNCERTAINTY.....</i>	<i>7</i>
<b>5. EQUIPMENT UNDER TEST .....</b>	<b>8</b>
5.1. <i>DESCRIPTION OF EUT .....</i>	<i>8</i>
5.2. <i>MAXIMUM OUTPUT POWER.....</i>	<i>8</i>
5.3. <i>DESCRIPTION OF AVAILABLE ANTENNAS .....</i>	<i>8</i>
5.4. <i>SOFTWARE AND FIRMWARE.....</i>	<i>8</i>
5.5. <i>WORST-CASE CONFIGURATION AND MODE.....</i>	<i>9</i>
5.6. <i>DESCRIPTION OF TEST SETUP.....</i>	<i>9</i>
<b>6. TEST AND MEASUREMENT EQUIPMENT .....</b>	<b>13</b>
<b>7. ON TIME, DUTY CYCLE AND MEASUREMENT METHODS .....</b>	<b>14</b>
7.1.1. <i>ON TIME AND DUTY CYCLE RESULTS.....</i>	<i>14</i>
7.1.2. <i>MEASUREMENT METHOD FOR POWER AND PPSD .....</i>	<i>14</i>
7.1.3. <i>MEASUREMENT METHOD FOR AVERAGE SPURIOUS EMISSIONS ABOVE 1</i> <i>GHz 14</i>	
7.1.4. <i>DUTY CYCLE PLOTS .....</i>	<i>15</i>
<b>8. ANTENNA PORT TEST RESULTS .....</b>	<b>17</b>
8.1. <i>802.11a MODE IN THE 5.2 GHz BAND.....</i>	<i>17</i>
8.1.1. <i>26 dB BANDWIDTH.....</i>	<i>17</i>
8.1.2. <i>99% BANDWIDTH.....</i>	<i>19</i>
8.1.3. <i>AVERAGE POWER .....</i>	<i>21</i>
8.1.4. <i>OUTPUT POWER AND PSD .....</i>	<i>22</i>
8.1.5. <i>PEAK EXCURSION .....</i>	<i>26</i>
8.2. <i>802.11n HT20 MODE IN THE 5.2 GHz BAND .....</i>	<i>27</i>
8.2.1. <i>26 dB BANDWIDTH.....</i>	<i>27</i>
8.2.2. <i>99% BANDWIDTH.....</i>	<i>29</i>
8.2.3. <i>AVERAGE POWER .....</i>	<i>31</i>
8.2.4. <i>OUTPUT POWER AND PSD .....</i>	<i>32</i>
8.2.5. <i>PEAK EXCURSION .....</i>	<i>36</i>
8.3. <i>802.11n HT40 MODE IN THE 5.2 GHz BAND .....</i>	<i>37</i>
8.3.1. <i>26 dB BANDWIDTH.....</i>	<i>37</i>
8.3.2. <i>99% BANDWIDTH.....</i>	<i>39</i>

8.3.3. AVERAGE POWER .....41  
8.3.4. OUTPUT POWER AND PPSD .....42  
8.3.5. PEAK EXCURSION Fixed .....45  
8.4. 802.11a MODE IN THE 5.3 GHz BAND .....46  
8.4.1. 26 dB BANDWIDTH.....46  
8.4.2. 99% BANDWIDTH.....48  
8.4.3. AVERAGE POWER.....50  
8.4.4. OUTPUT POWER AND PPSD .....51  
8.4.5. PEAK EXCURSION.....55  
8.5. 802.11n HT20 MODE IN THE 5.3 GHz BAND .....56  
8.5.1. 26 dB BANDWIDTH.....56  
8.5.2. 99% BANDWIDTH.....58  
8.5.3. AVERAGE POWER.....60  
8.5.4. OUTPUT POWER AND PPSD .....61  
8.5.5. PEAK EXCURSION.....65  
8.6. 802.11n HT40 MODE IN THE 5.3 GHz BAND .....66  
8.6.1. 26 dB BANDWIDTH.....66  
8.6.2. 99% BANDWIDTH.....68  
8.6.3. AVERAGE POWER.....70  
8.6.4. OUTPUT POWER AND PPSD .....71  
8.6.5. PEAK EXCURSION.....74  
8.7. 802.11a MODE IN THE 5.6 GHz BAND .....75  
8.7.1. 26 dB BANDWIDTH.....75  
8.7.2. 99% BANDWIDTH.....77  
8.7.3. AVERAGE POWER.....79  
8.7.4. OUTPUT POWER AND PPSD .....80  
8.7.5. PEAK EXCURSION.....84  
8.8. 802.11n HT20 MODE IN THE 5.6 GHz BAND .....85  
8.8.1. 26 dB BANDWIDTH.....85  
8.8.2. 99% BANDWIDTH.....87  
8.8.3. AVERAGE POWER.....89  
8.8.4. OUTPUT POWER AND PPSD .....90  
8.8.5. PEAK EXCURSION.....94  
8.9. 802.11n HT40 MODE IN THE 5.6 GHz BAND .....95  
8.9.1. 26 dB BANDWIDTH.....95  
8.9.2. 99% BANDWIDTH.....97  
8.9.3. AVERAGE POWER.....99  
8.9.4. OUTPUT POWER AND PPSD .....100  
8.9.5. PEAK EXCURSION.....104  
**9. RADIATED TEST RESULTS.....105**  
9.1. LIMITS AND PROCEDURE ..... 105  
9.2. TRANSMITTER ABOVE 1 GHz ..... 106  
9.2.1. TX ABOVE 1 GHz 802.11a MODE IN THE 5.2 GHz BAND ..... 106  
9.2.2. TX ABOVE 1 GHz 802.11n HT20 MODE IN THE 5.2 GHz BAND..... 114  
9.2.3. TX ABOVE 1 GHz 802.11n HT40 MODE IN THE 5.2 GHz BAND..... 122  
9.2.4. TX ABOVE 1 GHz 802.11a MODE IN THE 5.3 GHz BAND ..... 128  
9.2.5. TX ABOVE 1 GHz 802.11n HT20 MODE IN THE 5.3 GHz BAND..... 136  
9.2.6. TX ABOVE 1 GHz 802.11n HT40 MODE IN THE 5.3 GHz BAND..... 144

9.2.7. TX ABOVE 1 GHz 802.11a MODE IN THE 5.6 GHz BAND ..... 150  
9.2.8. TX ABOVE 1 GHz 802.11n HT20 MODE IN THE 5.6 GHz BAND..... 159  
9.2.9. TX ABOVE 1 GHz 802.11n HT40 MODE IN THE 5.6 GHz BAND..... 168  
9.2.10. 2.4GHz and 5GHz Band Co-Location..... 177  
9.3. WORST-CASE BELOW 1 GHz..... 181  
9.4. RECEIVER ABOVE 1 GHz..... 183  
**10. AC POWER LINE CONDUCTED EMISSIONS ..... 184**  
**11. DYNAMIC FREQUENCY SELECTION ..... 188**  
11.1. OVERVIEW..... 188  
11.1.1. LIMITS ..... 188  
11.1.2. TEST AND MEASUREMENT SYSTEM ..... 191  
11.1.3. SETUP OF EUT (CLIENT MODE)..... 194  
11.1.4. SETUP OF EUT (CLIENT-TO-CLIENT COMMUNICATIONS MODE) ..... 195  
11.1.5. DESCRIPTION OF EUT..... 196  
11.2. CLIENT MODE RESULTS FOR 20 MHz BANDWIDTH..... 198  
11.2.1. TEST CHANNEL..... 198  
11.2.2. RADAR WAVEFORM AND TRAFFIC ..... 198  
11.2.3. OVERLAPPING CHANNEL TESTS ..... 200  
11.2.4. MOVE AND CLOSING TIME..... 200  
11.3. CLIENT MODE RESULTS FOR 40 MHz BANDWIDTH..... 205  
11.3.1. TEST CHANNEL..... 205  
11.3.2. RADAR WAVEFORM AND TRAFFIC ..... 205  
11.3.3. OVERLAPPING CHANNEL TESTS ..... 207  
11.3.4. MOVE AND CLOSING TIME..... 207  
11.3.5. NON-OCCUPANCY PERIOD..... 212  
11.4. CLIENT-TO-CLIENT COMMUNICATIONS MODE RESULTS FOR 20 MHz  
BANDWIDTH..... 213  
11.4.1. TEST CHANNEL..... 213  
11.4.2. RADAR WAVEFORM AND TRAFFIC ..... 213  
11.4.3. OVERLAPPING CHANNEL TESTS ..... 215  
11.4.4. MOVE AND CLOSING TIME..... 215  
11.5. CLIENT-TO-CLIENT COMMUNICATIONS MODE RESULTS FOR 40 MHz  
BANDWIDTH..... 220  
11.5.1. TEST CHANNEL..... 220  
11.5.2. RADAR WAVEFORM AND TRAFFIC ..... 220  
11.5.3. OVERLAPPING CHANNEL TESTS ..... 222  
11.5.4. MOVE AND CLOSING TIME..... 222  
**13. SETUP PHOTOS ..... 227**

# 1. ATTESTATION OF TEST RESULTS

**COMPANY NAME:** APPLE, INC.  
1 INFINITE LOOP  
CUPERTINO, CA 95014, U.S.A.

**EUT DESCRIPTION:** QUAD-BAND RADIO WITH WLAN AND BT RADIO

**MODEL:** A1507

**SERIAL NUMBER:** C7JKV03GFLW6 (DVT-9GW10C-2099) (RF) and  
C7JKT0UEFLW7 (DFS)

**DATE TESTED:** JUNE 17 to JUNE 25, 2013 (RF) and JULY 16, 2013 (DFS)

APPLICABLE STANDARDS	
STANDARD	TEST RESULTS
CFR 47 Part 15 Subpart E	Pass
INDUSTRY CANADA RSS-210 Issue 8 Annex 9	Pass
INDUSTRY CANADA RSS-GEN Issue 3	Pass

UL Verification Services Inc. tested the above equipment in accordance with the requirements set forth in the above standards. All indications of Pass/Fail in this report are opinions expressed by UL Verification Services Inc. based on interpretations and/or observations of test results. Measurement Uncertainties were not taken into account and are published for informational purposes only. The test results show that the equipment tested is capable of demonstrating compliance with the requirements as documented in this report.

**Note:** The results documented in this report apply only to the tested sample, under the conditions and modes of operation as described herein. This document may not be altered or revised in any way unless done so by UL Verification Services Inc. and all revisions are duly noted in the revisions section. Any alteration of this document not carried out by UL Verification Services Inc. will constitute fraud and shall nullify the document. This report must not be used by the client to claim product certification, approval, or endorsement by NVLAP, NIST, any agency of the Federal Government, or any agency of any government.

Approved & Released For  
UL Verification Services Inc. By:

Tested By:



Thu Chan  
WiSE Operations Manager  
UL Verification Services Inc.

Francisco Guarnero  
WiSE Lab Technician  
UL Verification Services Inc.

## 2. TEST METHODOLOGY

The tests documented in this report were performed in accordance with FCC CFR 47 Part 2, FCC CFR 47 Part 15, FCC 06-96, FCC KDB 789033, ANSI C63.10-2009, RSS-GEN Issue 3, and RSS-210 Issue 8.

## 3. FACILITIES AND ACCREDITATION

The test sites and measurement facilities used to collect data are located at 47173 Benicia Street, Fremont, California, USA.

UL Verification Services Inc. is accredited by NVLAP, Laboratory Code 200065-0. The full scope of accreditation can be viewed at <http://www.ccsemc.com>.

## 4. CALIBRATION AND UNCERTAINTY

### 4.1. MEASURING INSTRUMENT CALIBRATION

The measuring equipment utilized to perform the tests documented in this report has been calibrated in accordance with the manufacturer's recommendations, and is traceable to recognized national standards.

### 4.2. SAMPLE CALCULATION

Where relevant, the following sample calculation is provided:

$$\begin{aligned} \text{Field Strength (dBuV/m)} &= \text{Measured Voltage (dBuV)} + \text{Antenna Factor (dB/m)} + \\ &\text{Cable Loss (dB)} - \text{Preamp Gain (dB)} \\ 36.5 \text{ dBuV} + 18.7 \text{ dB/m} + 0.6 \text{ dB} - 26.9 \text{ dB} &= 28.9 \text{ dBuV/m} \end{aligned}$$

### 4.3. MEASUREMENT UNCERTAINTY

Where relevant, the following measurement uncertainty levels have been estimated for tests performed on the apparatus:

PARAMETER	UNCERTAINTY
Conducted Disturbance, 0.15 to 30 MHz	3.52 dB
Radiated Disturbance, 30 to 1000 MHz	4.94 dB

Uncertainty figures are valid to a confidence level of 95%.

## 5. EQUIPMENT UNDER TEST

### 5.1. DESCRIPTION OF EUT

Model A1507 is a mobile phone with multimedia functions (music, application support, and video), cellular GSM/GPRS/EGPRS/WCDMA/HSPA+/DC-HSDPA/LTE radio, IEEE 802.11a/b/g/n, Bluetooth and GPS radio. The rechargeable battery is not user accessible.

Testing of Model A1507 (FCC ID: BCG-E2694B) and (IC #: 579C-E2694B) is considered representative of Model A1529 (FCC ID: BCG-E2694A) and (IC #: 579C-E2694A). Model A1507 is identical to Model A1529 except for the WWAN functions. Both the WLAN and WWAN antenna locations for both models are identical.

### 5.2. MAXIMUM OUTPUT POWER

The transmitter has a maximum conducted output power as follows:

Frequency Range (MHz)	Mode	Output Power (dBm)	Output Power (mW)
5180 - 5240	802.11a	14.161	26.07
5180 - 5240	802.11n HT20	14.110	25.76
5190 - 5230	802.11n HT40	16.286	42.52
5260 - 5320	802.11a	15.973	39.56
5260 - 5320	802.11n HT20	16.183	41.52
5270 - 5310	802.11n HT40	16.120	40.93
5500 - 5700	802.11a	14.106	25.74
5500 - 5700	802.11n HT20	14.138	25.93
5510 - 5670	802.11n HT40	14.096	25.68

### 5.3. DESCRIPTION OF AVAILABLE ANTENNAS

The radio utilizes a PiFA antenna, with a maximum gain as below table.

FREQUENCY (MHZ)	ANTENNA GAIN ( dBi)
2400 - 2483.5	0.21
5150 - 5250	-0.73
5250 - 5350	-0.37
5500 - 5700	1.31
5725 - 5850	1.59

### 5.4. SOFTWARE AND FIRMWARE

The firmware installed in the EUT during testing was WL Tool FW 6.10.56.166



### 5.5. WORST-CASE CONFIGURATION AND MODE

The worst-case channel for RF radiated emissions below 1GHz tests is channel with highest RF output power.

Based on the investigation results, the highest peak power and enhanced data rate is the worst-case scenario for all measurements.

For the fundamental investigation, the EUT is investigated for vertical and horizontal antenna orientations and the worst case was determined to be at X-position.

Based on the manufacturer’s attestation that the nominal output power is reduced as the data rate increases, the data rates tested represent the highest power and worst-case with respect to EMC performance.

Worst-case data rates were used:

- 802.11b mode: 1 Mbps
- 802.11g mode: 6 Mbps
- 802.11a mode: 6 Mbps
- 802.11n HT20mode: MCS0
- 802.11n HT40mode: MCS0

### 5.6. DESCRIPTION OF TEST SETUP

#### SUPPORT EQUIPMENT

Support Equipment List			
Description	Manufacturer	Model	Serial Number
AC adapter	Apple	A1385	D292365D11QDHLHCA
Earphone	Apple	NA	NA

#### I/O CABLES (Conducted Setup)

I/O Cable List						
Cable No	Port	# of identical ports	Connector Type	Cable Type	Cable Length (m)	Remarks
1	Antenna	1	SMA	Shielded	0.1m	To Spectrum Analyzer

#### I/O CABLES

I/O Cable List						
Cable No	Port	# of identical ports	Connector Type	Cable Type	Cable Length (m)	Remarks
1	Jack	1	Earphone	Unshielded	0.5m	N/A

**TEST SETUP**

The EUT is a stand-alone device.

**SETUP DIAGRAM FOR TESTS**

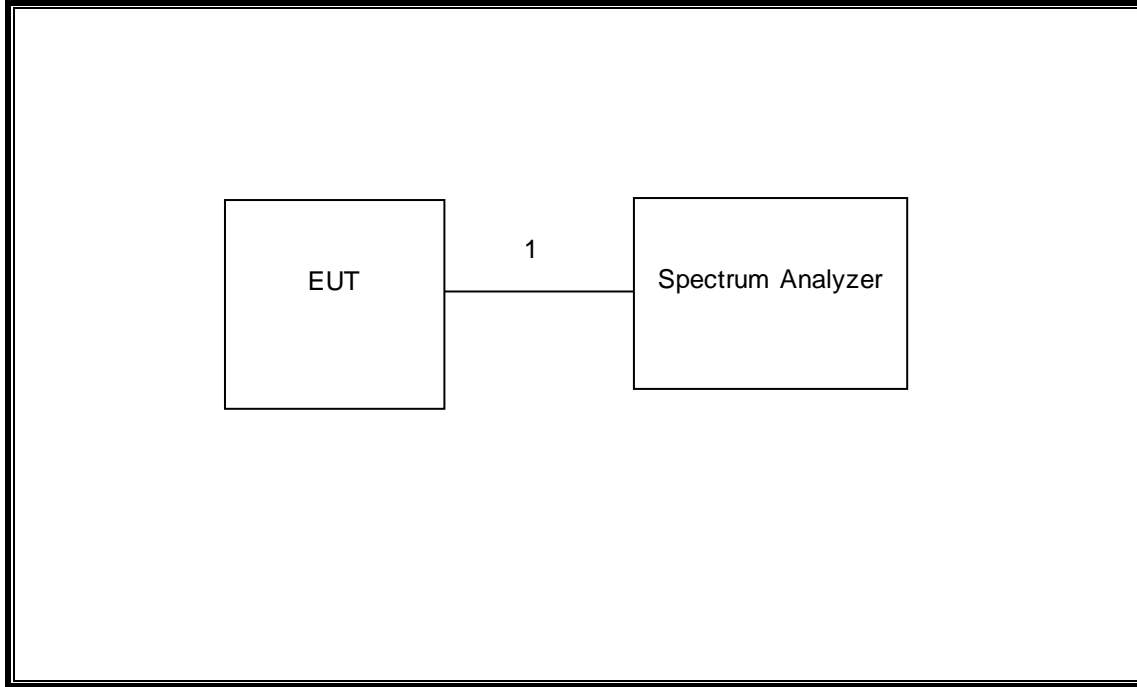

**SETUP DIAGRAM FOR RADIATED TESTS**

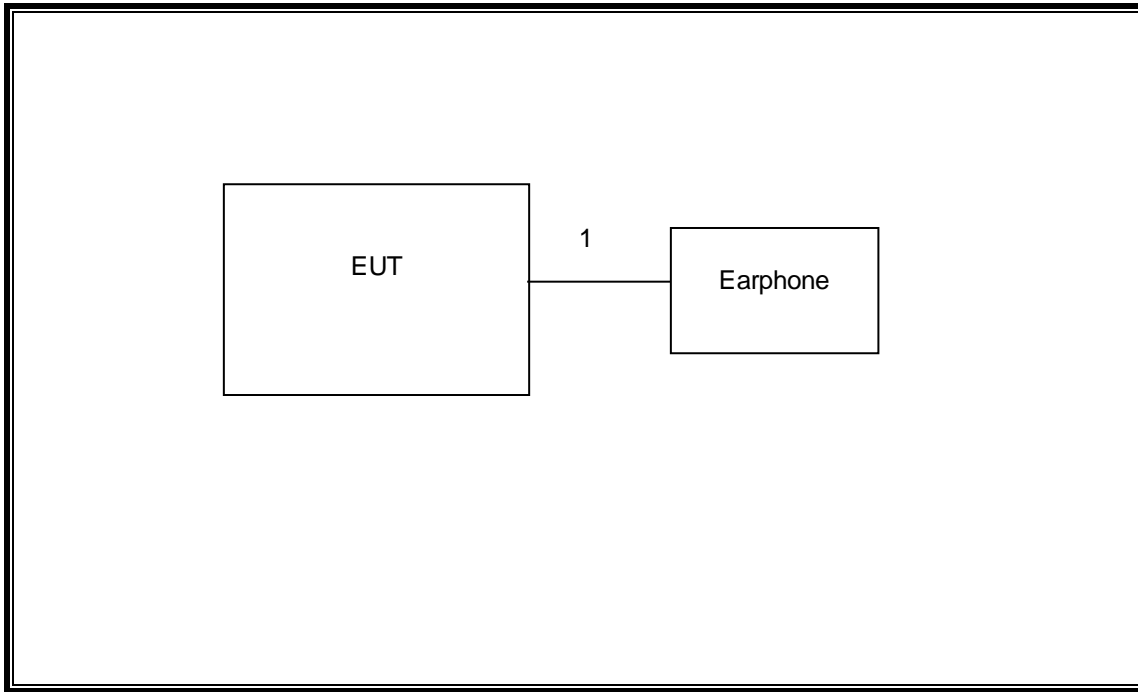

**SETUP DIAGRAM FOR AC POWER CONDUCTED TESTS**

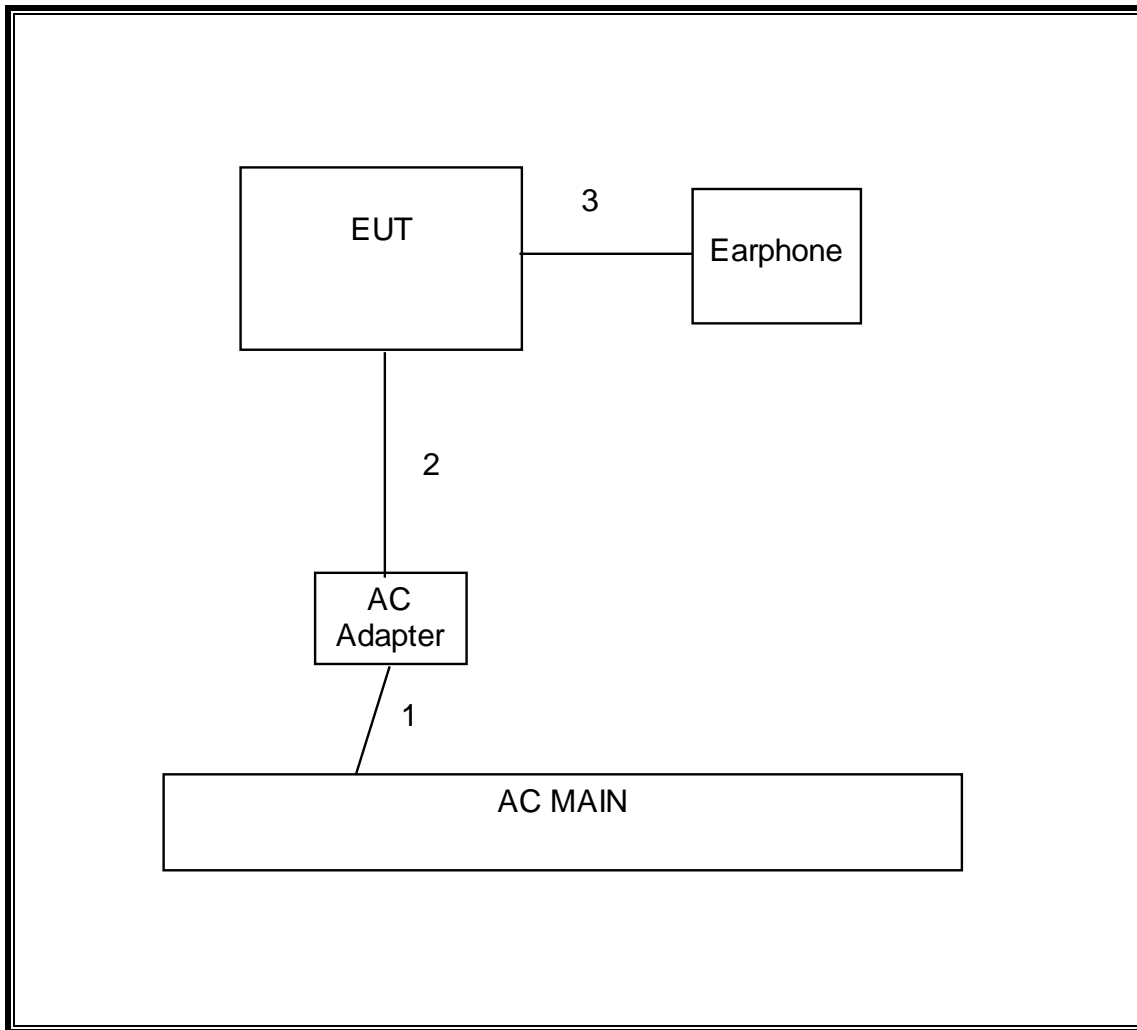

## 6. TEST AND MEASUREMENT EQUIPMENT

The following test and measurement equipment was utilized for the tests documented in this report:

Test Equipment List				
Description	Manufacturer	Model	Asset	Cal Due
Horn Antenna 1-18GHz	ETS Lindgren	3117	F00133	02/19/14
Preamplifier, 1300 MHz	Agilent / HP	8447D	C00580	01/28/14
Antenna, Horn, 26.5 GHz	ARA	SWH-28	C01015	05/06/14
Antenna, Biconolog, 30MHz-1 GHz	Sunol Sciences	JB3	F00215	03/07/14
Peak / Average Power Sensor	Agilent / HP	E9323A	F00026	07/27/13
P-Series single channel Power Meter	Agilent / HP	N1911A	F00153	07/26/13
Spectrum Analyzer, 3Hz-44GHz	Agilent	N9030A	F00127	02/22/14
PreApmplifier, 1-26.5GHz	Agilent	8449B	C01052	10/22/13
LISN, 30 MHz	FCC	LISN-50/250-25-2	N02625	04/17/14
Antenna, Horn, 40 GHz	ARA	MWH-2640/B	C00981	06/14/14
EMI Test Receiver, 30 MHz	R & S	ESHS 20	N02396	08/08/13
Preamplifier, 40 GHz	Miteq	NSP4000-SP2	C00990	08/02/13

## 7. ON TIME, DUTY CYCLE AND MEASUREMENT METHODS

### LIMITS

None; for reporting purposes only.

### PROCEDURE

KDB 789033 Zero-Span Spectrum Analyzer Method.

#### 7.1.1. ON TIME AND DUTY CYCLE RESULTS

Mode	ON Time B (msec)	Period (msec)	Duty Cycle x (linear)	Duty Cycle (%)	Duty Cycle Correction Factor (dB)	1/B Minimum VBW (kHz)
802.11a 20 MHz	2.03	2.07	0.980	98.0%	0.09	0.493
802.11n HT20	1.91	1.94	0.985	98.5%	0.07	0.524
802.11n HT40	0.94	0.97	0.963	96.3%	0.16	1.070

#### 7.1.2. MEASUREMENT METHOD FOR POWER AND PPSD

The Duty Cycle is greater than or equal to 98% therefore KDB 789033 Method SA-1 is used.

The Duty Cycle is less than 98% and consistent therefore KDB 789033 Method SA-2 is used.

#### 7.1.3. MEASUREMENT METHOD FOR AVERAGE SPURIOUS EMISSIONS ABOVE 1 GHz

The Duty Cycle is greater than or equal to 98%, KDB 789033 Method AD with Power RMS Averaging is used.

The Duty Cycle is less than 98% and consistent, KDB 789033 Method AD with Power RMS Averaging and duty cycle correction is used.

### 7.1.4. DUTY CYCLE PLOTS

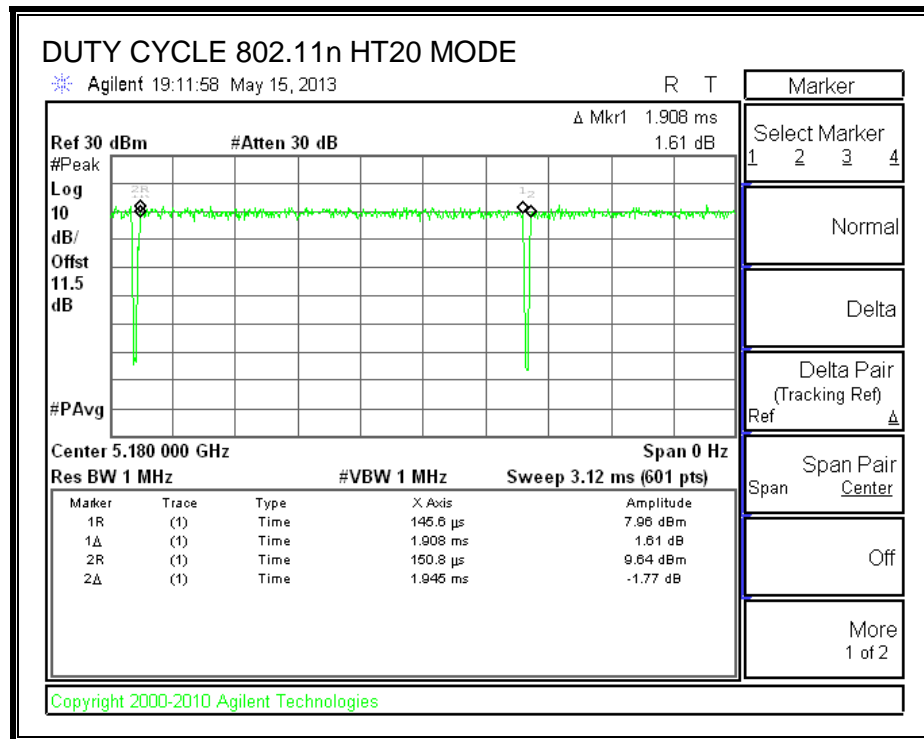
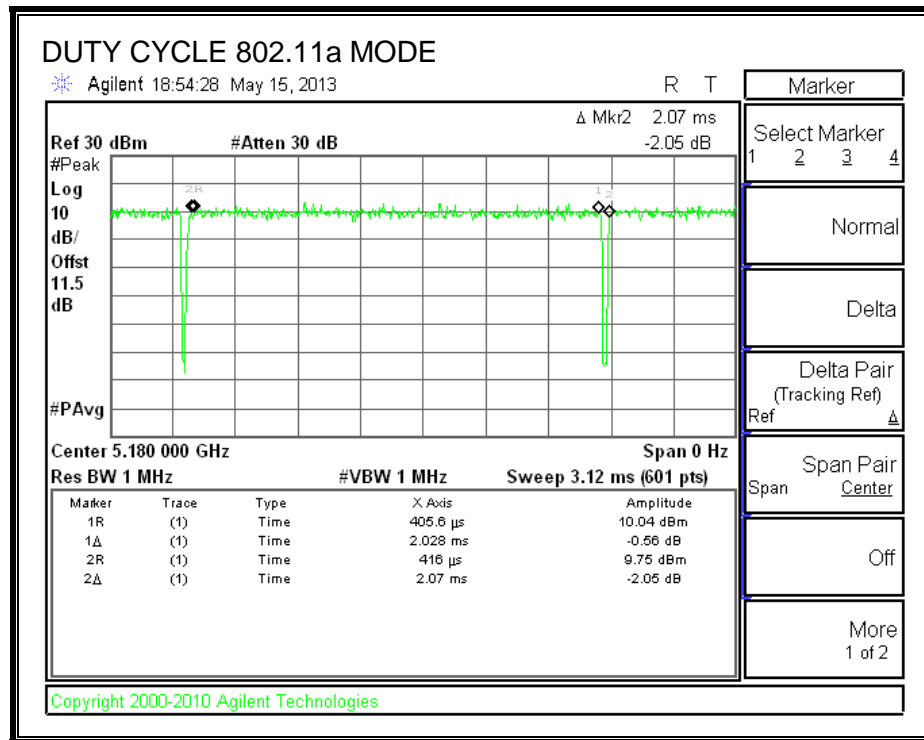

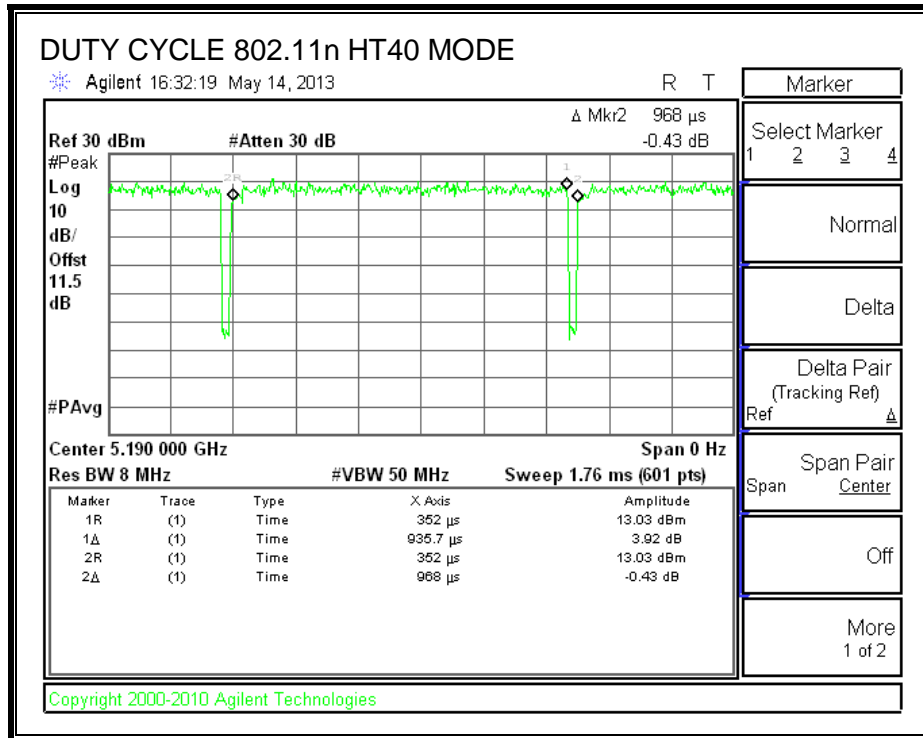



## 8. ANTENNA PORT TEST RESULTS

### 8.1. 802.11a MODE IN THE 5.2 GHz BAND

#### 8.1.1. 26 dB BANDWIDTH

##### LIMITS

None; for reporting purposes only.

##### RESULTS

Channel	Frequency (MHz)	26 dB Bandwidth (MHz)
Low	5180	19.20
Mid	5200	19.20
High	5240	19.07

##### 26 dB BANDWIDTH

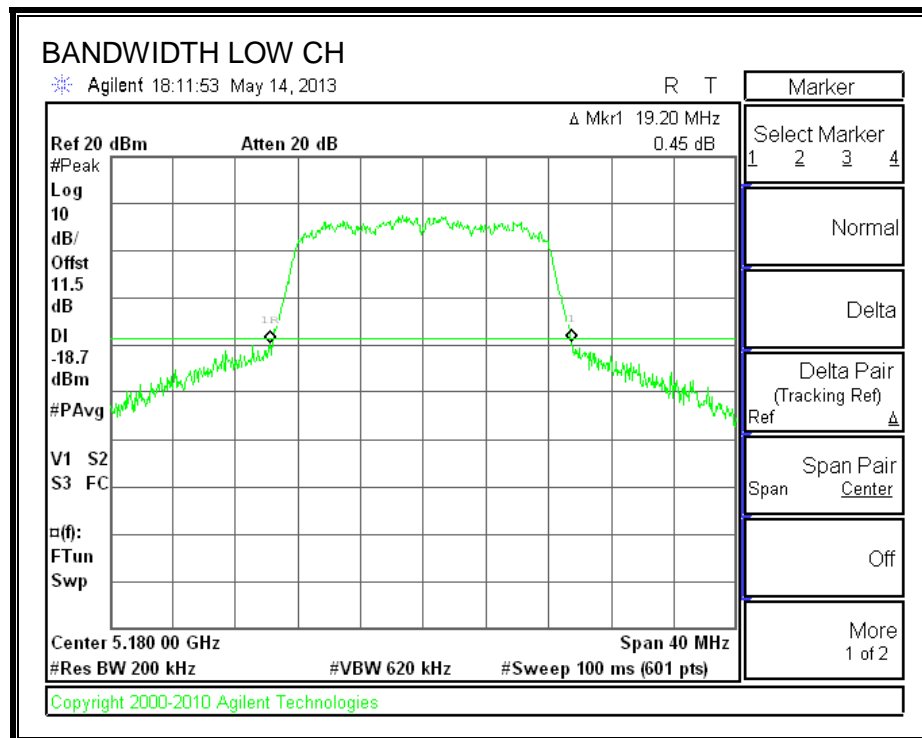

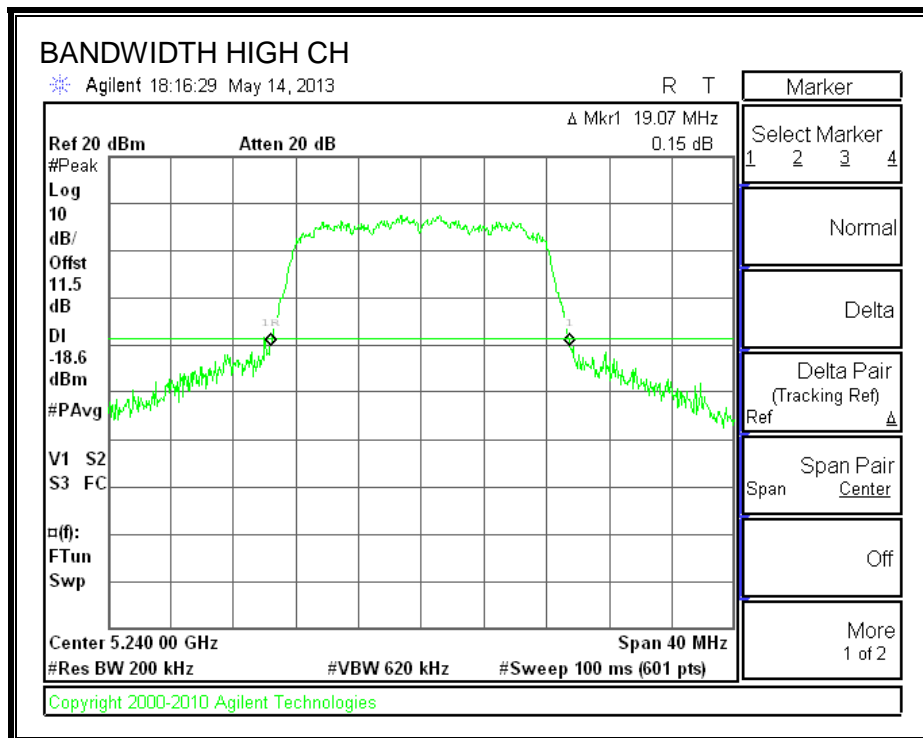
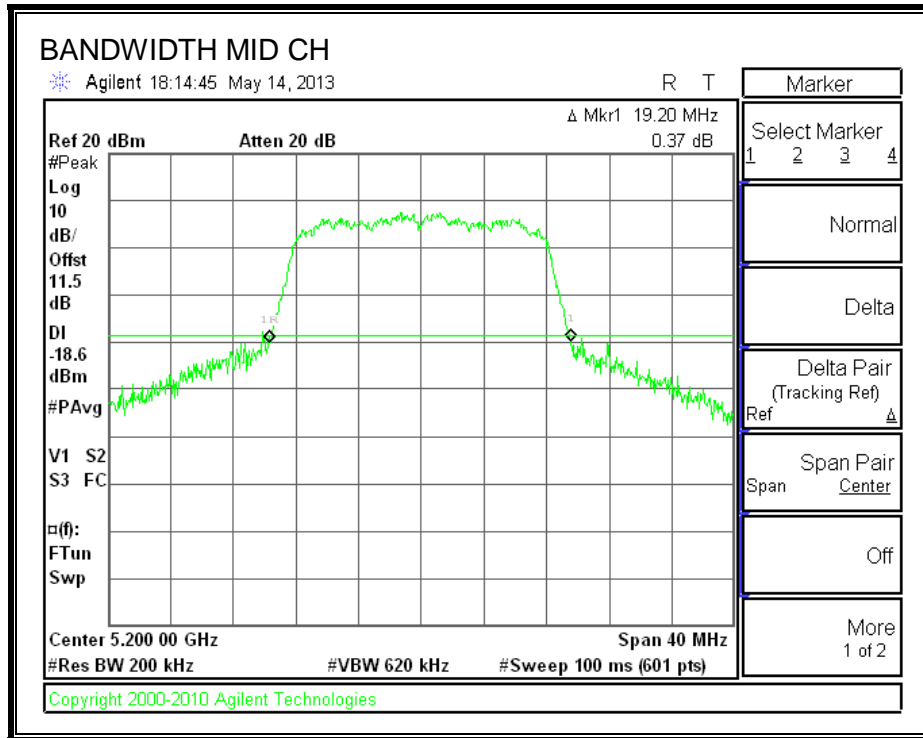

### 8.1.2. 99% BANDWIDTH

#### LIMITS

None; for reporting purposes only.

#### RESULTS

Channel	Frequency (MHz)	99% Bandwidth (MHz)
Low	5180	16.3351
Mid	5200	16.3323
High	5240	16.3216

#### 99% BANDWIDTH

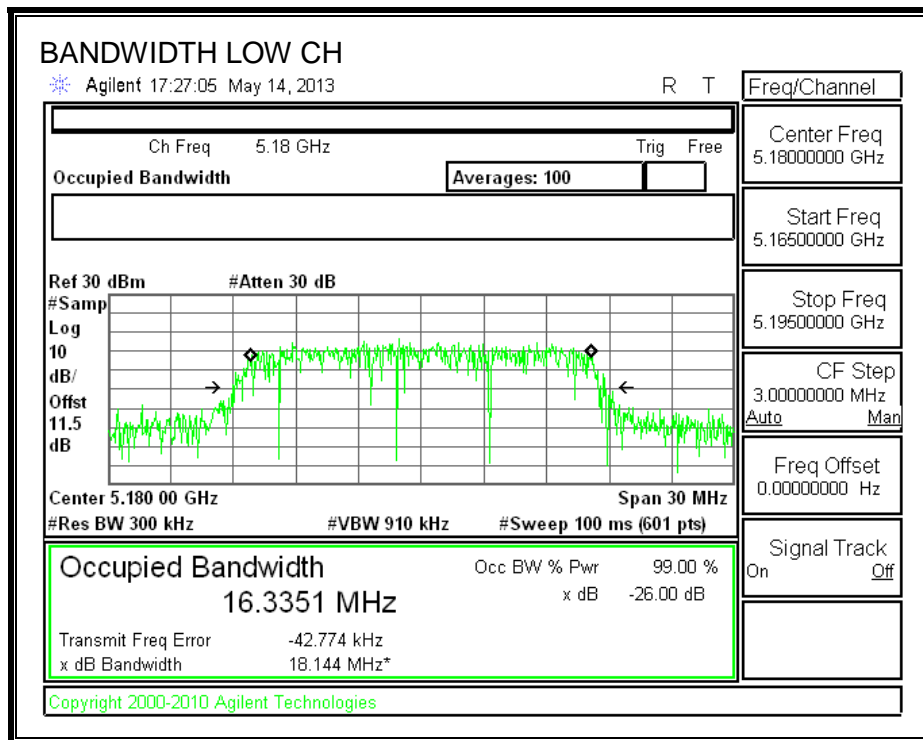

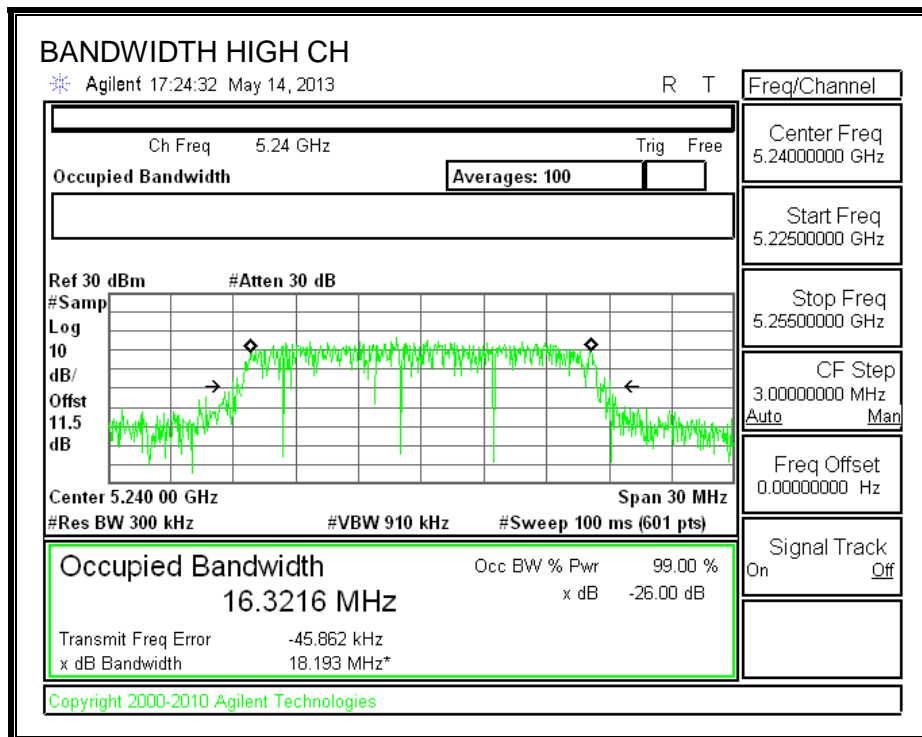
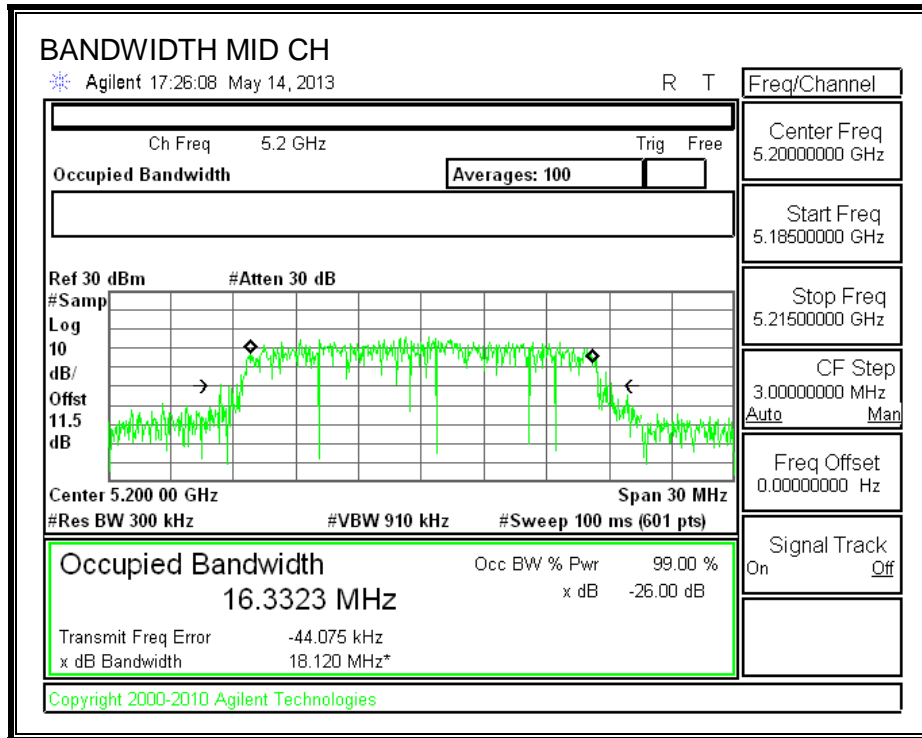

### 8.1.3. AVERAGE POWER

#### LIMITS

None; for reporting purposes only.

#### TEST PROCEDURE

The transmitter output is connected to a power meter.

The cable assembly insertion loss of 11.5 dB (including 10 dB pad and 1.5 dB cable) was entered as an offset in the power meter to allow for direct reading of power.

#### RESULTS

Channel	Frequency (MHz)	Power (dBm)
Low	5180	13.98
Mid	5200	13.81
High	5240	14.03

## 8.1.4. OUTPUT POWER AND PSD

### LIMITS

FCC §15.407 (a) (1)

For the band 5.15–5.25 GHz, the maximum conducted output power over the frequency band of operation shall not exceed the lesser of 50 mW or  $4 \text{ dBm} + 10 \log B$ , where B is the 26–dB emission bandwidth in MHz. In addition, the peak power spectral density shall not exceed 4 dBm in any 1–MHz band. If transmitting antennas of directional gain greater than 6 dBi are used, both the maximum conducted output power and the peak power spectral density shall be reduced by the amount in dB that the directional gain of the antenna exceeds 6 dBi.

IC RSS-210 A9.2 (1)

The maximum e.i.r.p. shall not exceed 200 mW or  $10 + 10 \log_{10} B$ , dBm, whichever power is less. B is the 99% emission bandwidth in MHz. The e.i.r.p. spectral density shall not exceed 10 dBm in any 1.0 MHz band.

### DIRECTIONAL ANTENNA GAIN

There is only one transmitter output therefore the directional gain is equal to the antenna gain.

**RESULTS**

**Bandwidth and Antenna Gain**

Channel	Frequency (MHz)	Min 26 dB BW (MHz)	Min 99% BW (MHz)	Directional Gain (dBi)
Low	5180.00	19.20	16.3351	-6.00
Mid	5200.00	19.20	16.3323	-6.00
High	5240.00	19.07	16.3216	-6.00

**Limits**

Channel	Frequency (MHz)	FCC Power Limit (dBm)	IC EIRP Limit (dBm)	Max IC Power (dBm)	Power Limit (dBm)	FCC PPSD Limit (dBm)	IC eirp PSD Limit (dBm)	PPSD Limit (dBm)
Low	5180	16.83	22.13	28.13	16.83	4.00	10.00	4.00
Mid	5200	16.83	22.13	28.13	16.83	4.00	10.00	4.00
High	5240	16.80	22.13	28.13	16.80	4.00	10.00	4.00

<b>Duty Cycle CF (dB)</b>	0.09	<b>Included in Calculations of Corr'd Power &amp; PPSD</b>
---------------------------	------	--

**Output Power Results**

Channel	Frequency (MHz)	Meas Power (dBm)	Total Corr'd Power (dBm)	Power Limit (dBm)	Power Margin (dB)
Low	5180	14.161	14.25	16.83	-2.58
Mid	5200	14.025	14.12	16.83	-2.72
High	5240	14.060	14.15	16.80	-2.65

**PPSD Results**

Channel	Frequency (MHz)	Meas PPSD (dBm)	Total Corr'd PPSD (dBm)	PPSD Limit (dBm)	PPSD Margin (dB)
Low	5180	3.830	3.92	4.00	-0.08
Mid	5200	3.705	3.80	4.00	-0.20
High	5240	3.728	3.82	4.00	-0.18

**OUTPUT POWER AND PSD**

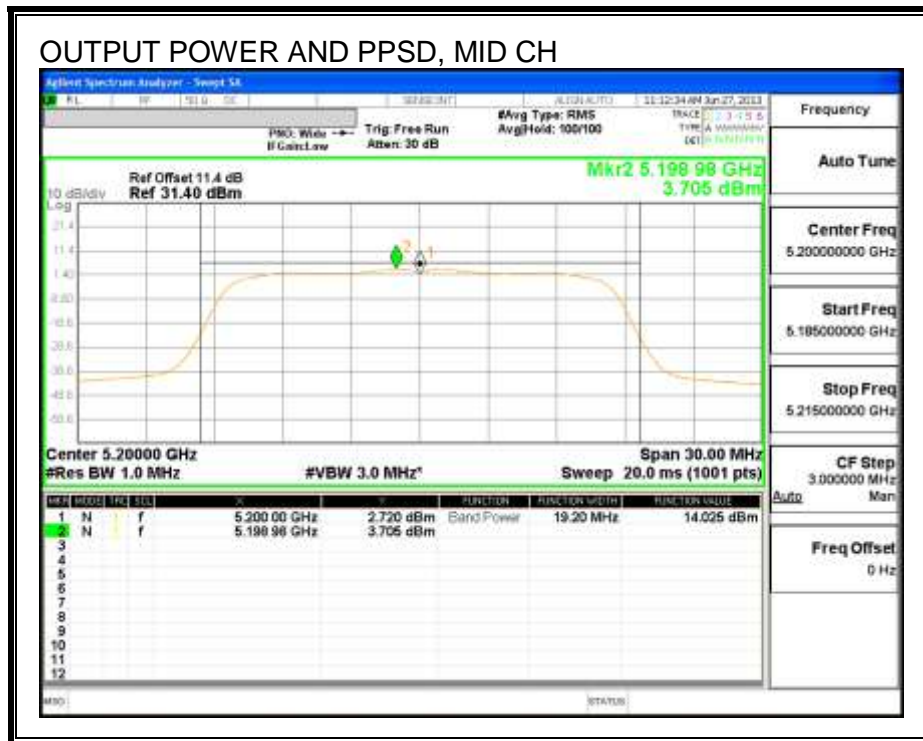
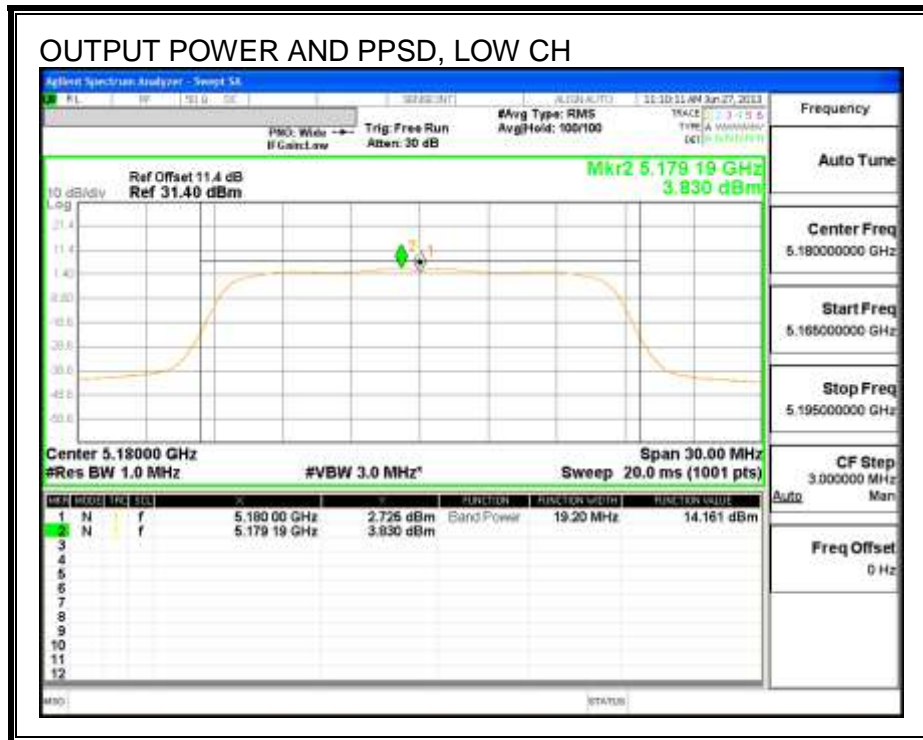



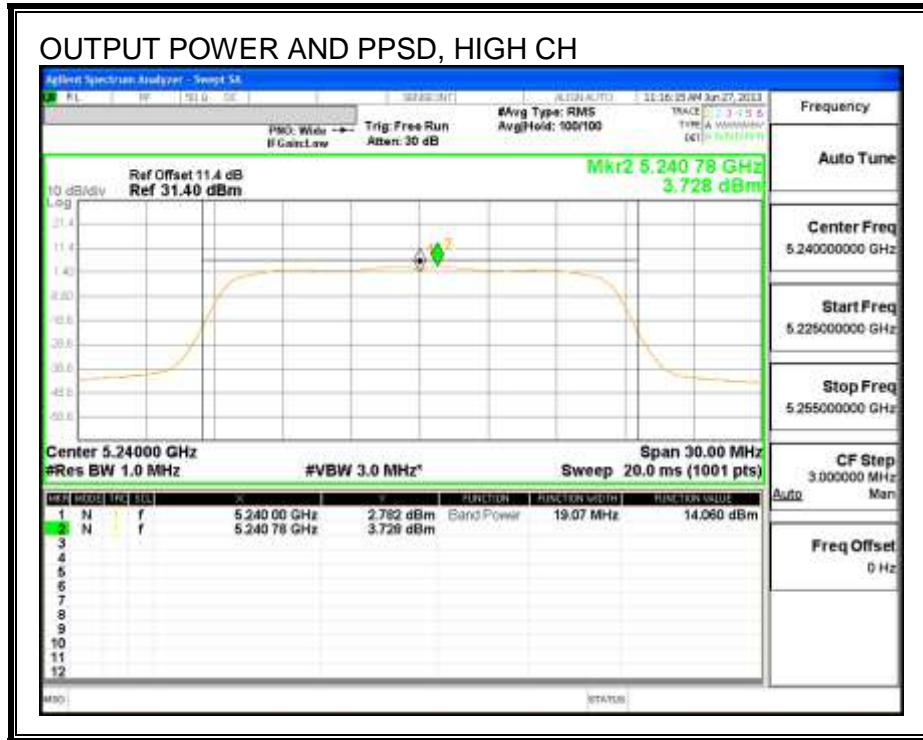

### 8.1.5. PEAK EXCURSION

#### LIMITS

FCC §15.407 (a) (6)

The ratio of the peak excursion of the modulation envelope (measured using a peak hold function) to the peak transmit power (measured as specified above) shall not exceed 13 dB across any 1 MHz bandwidth or the emission bandwidth whichever is less.

#### RESULTS

Channel	Frequency (MHz)	PK Level (dBm)	PSD (dBm)	DCCF (dB)	Peak Excursion (dB)	Limit (dB)	Margin (dB)
Mid	5200	14.83	3.705	0.09	11.04	13	-1.97

#### PEAK EXCURSION

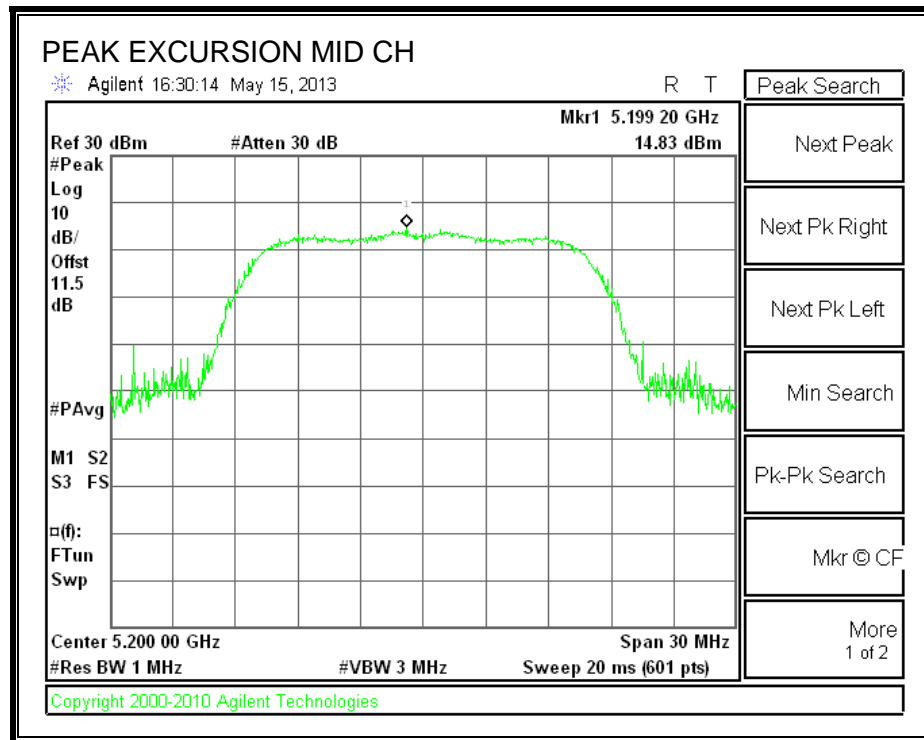

## 8.2. 802.11n HT20 MODE IN THE 5.2 GHz BAND

### 8.2.1. 26 dB BANDWIDTH

#### LIMITS

None; for reporting purposes only.

#### RESULTS

Channel	Frequency (MHz)	26 dB Bandwidth (MHz)
Low	5180	19.40
Mid	5200	19.40
High	5240	19.47

#### 26 dB BANDWIDTH

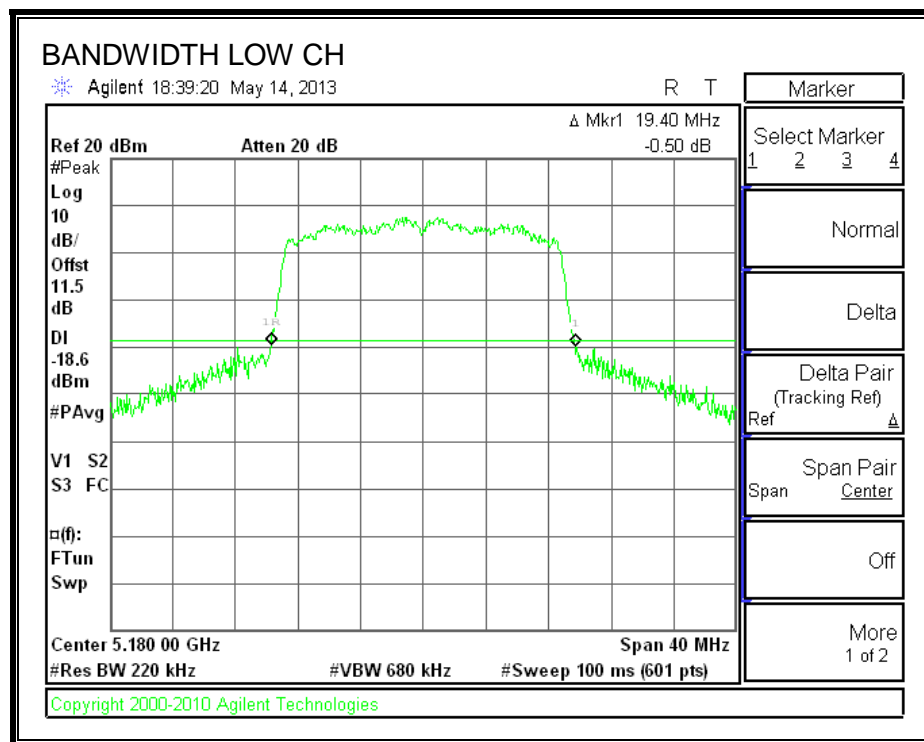

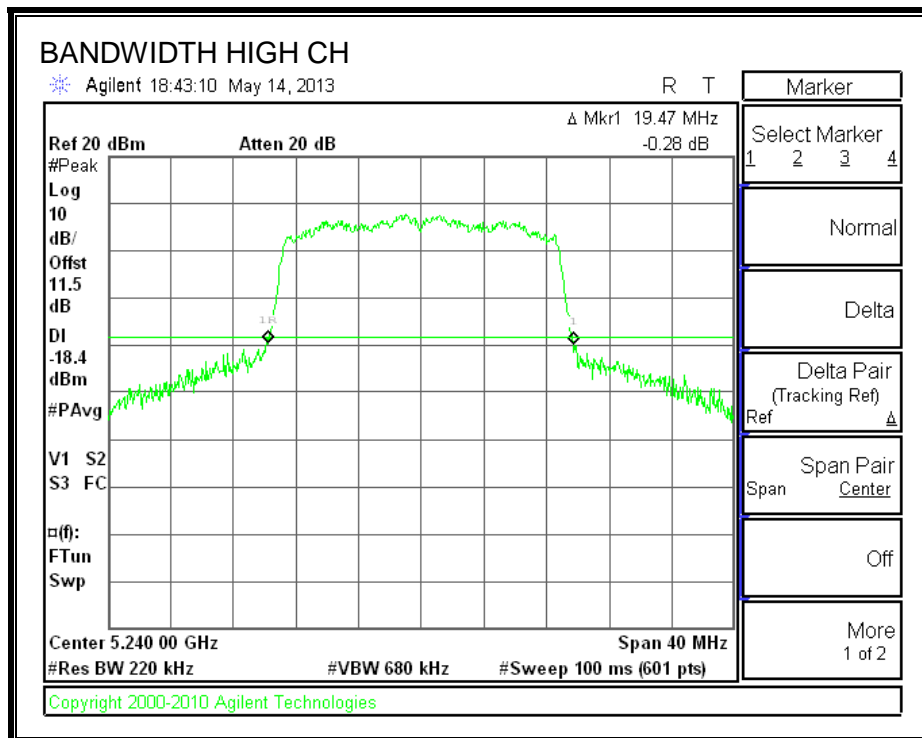
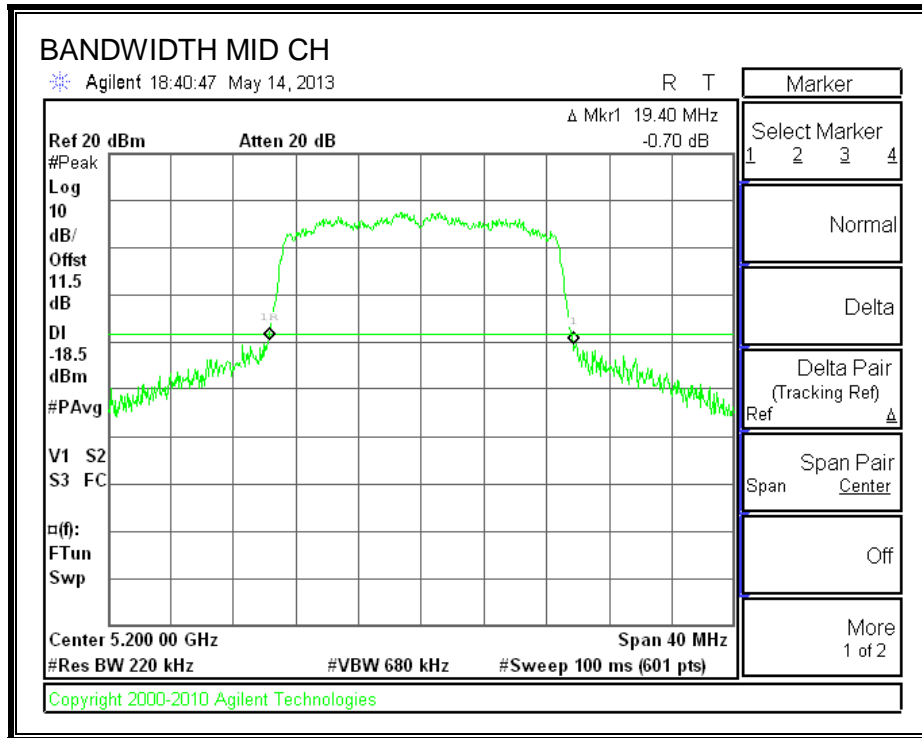

### 8.2.2. 99% BANDWIDTH

#### LIMITS

None; for reporting purposes only.

#### RESULTS

Channel	Frequency (MHz)	99% Bandwidth (MHz)
Low	5180	17.5140
Mid	5200	17.5162
High	5240	17.5368

#### 99% BANDWIDTH

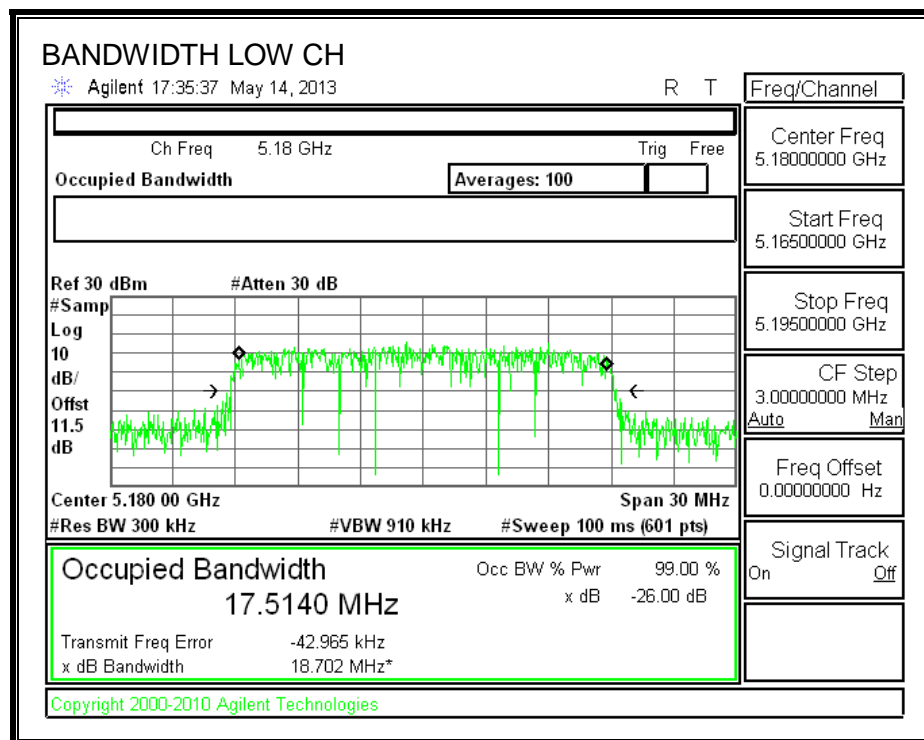

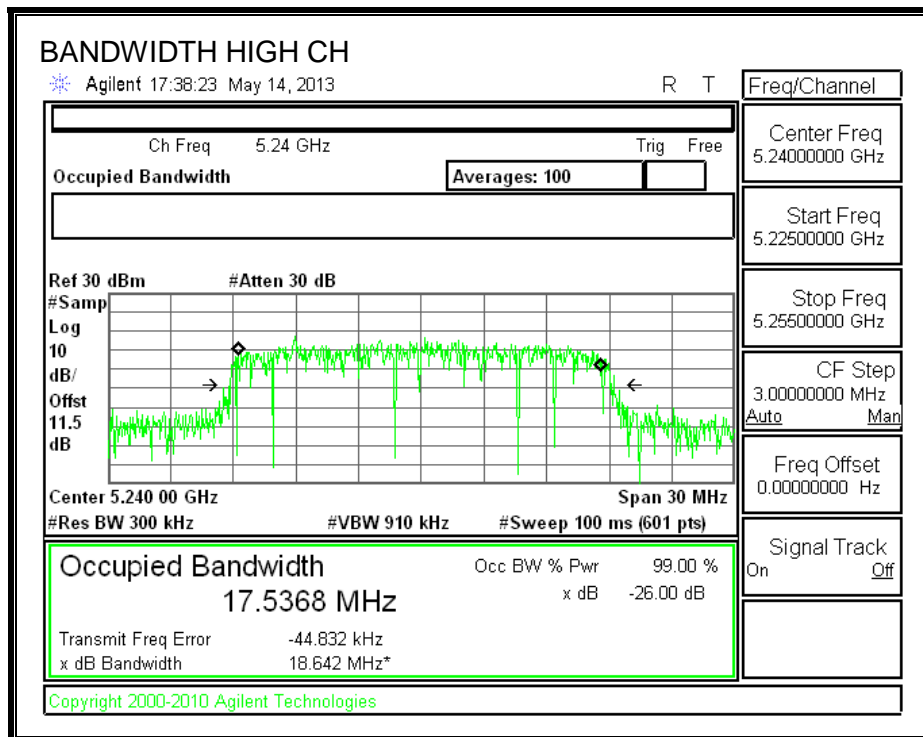
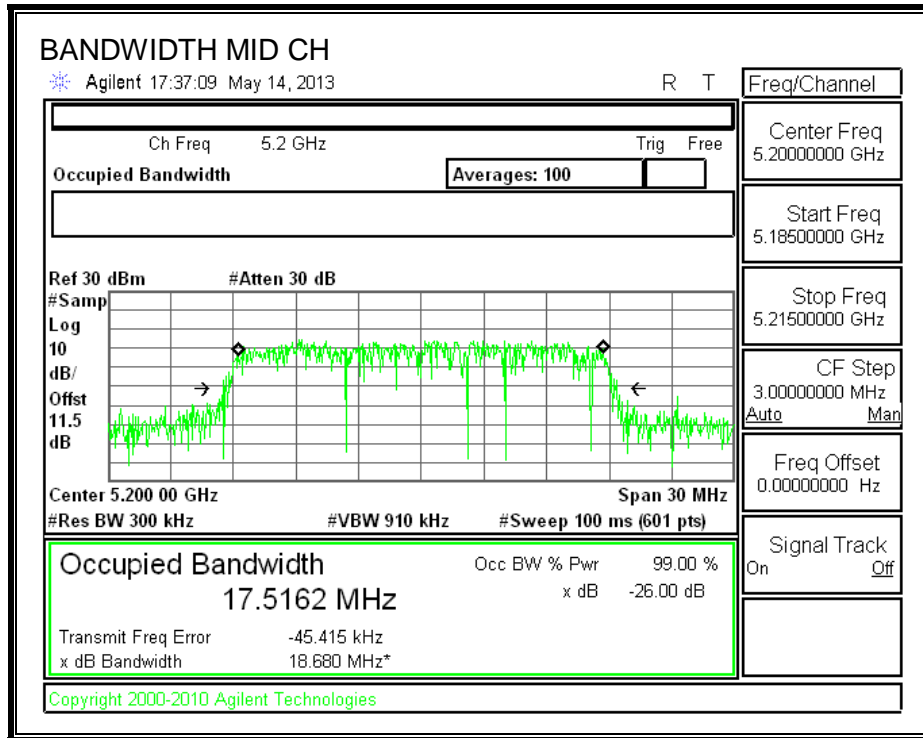

### 8.2.3. AVERAGE POWER

#### LIMITS

None; for reporting purposes only.

#### TEST PROCEDURE

The transmitter output is connected to a power meter.

The cable assembly insertion loss of 11.5 dB (including 10 dB pad and 1.5 dB cable) was entered as an offset in the power meter to allow for direct reading of power.

#### RESULTS

Channel	Frequency (MHz)	Power (dBm)
Low	5180	14.05
Mid	5200	14.01
High	5240	14.04

## 8.2.4. OUTPUT POWER AND PSD

### LIMITS

FCC §15.407 (a) (1)

For the band 5.15–5.25 GHz, the maximum conducted output power over the frequency band of operation shall not exceed the lesser of 50 mW or  $4 \text{ dBm} + 10 \log B$ , where B is the 26–dB emission bandwidth in MHz. In addition, the peak power spectral density shall not exceed 4 dBm in any 1–MHz band. If transmitting antennas of directional gain greater than 6 dBi are used, both the maximum conducted output power and the peak power spectral density shall be reduced by the amount in dB that the directional gain of the antenna exceeds 6 dBi.

IC RSS-210 A9.2 (1)

The maximum e.i.r.p. shall not exceed 200 mW or  $10 + 10 \log_{10} B$ , dBm, whichever power is less. B is the 99% emission bandwidth in MHz. The e.i.r.p. spectral density shall not exceed 10 dBm in any 1.0 MHz band.

### DIRECTIONAL ANTENNA GAIN

There is only one transmitter output therefore the directional gain is equal to the antenna gain.



**RESULTS**

**Bandwidth and Antenna Gain**

Channel	Frequency (MHz)	Min 26 dB BW (MHz)	Min 99% BW (MHz)	Directional Gain (dBi)
Low	5180.00	19.40	17.5140	-6.00
Mid	5200.00	19.40	17.5162	-6.00
High	5240.00	19.47	17.5368	-6.00

**Limits**

Channel	Frequency (MHz)	FCC Power Limit (dBm)	IC EIRP Limit (dBm)	Max IC Power (dBm)	Power Limit (dBm)	FCC PPSD Limit (dBm)	IC eirp PSD Limit (dBm)	PPSD Limit (dBm)
Low	5180	16.88	22.43	28.43	16.88	4.00	10.00	4.00
Mid	5200	16.88	22.43	28.43	16.88	4.00	10.00	4.00
High	5240	16.89	22.44	28.44	16.89	4.00	10.00	4.00

<b>Duty Cycle CF (dB)</b>	0.07	<b>Included in Calculations of Corr'd Power &amp; PPSD</b>
---------------------------	------	--

**Output Power Results**

Channel	Frequency (MHz)	Meas Power (dBm)	Total Corr'd Power (dBm)	Power Limit (dBm)	Power Margin (dB)
Low	5180	13.992	14.06	16.88	-2.82
Mid	5200	14.110	14.18	16.88	-2.70
High	5240	14.011	14.08	16.89	-2.81

**PPSD Results**

Channel	Frequency (MHz)	Meas PPSD (dBm)	Total Corr'd PPSD (dBm)	PPSD Limit (dBm)	PPSD Margin (dB)
Low	5180	3.488	3.56	4.00	-0.44
Mid	5200	3.611	3.68	4.00	-0.32
High	5240	3.497	3.57	4.00	-0.43

**OUTPUT POWER AND PSD**

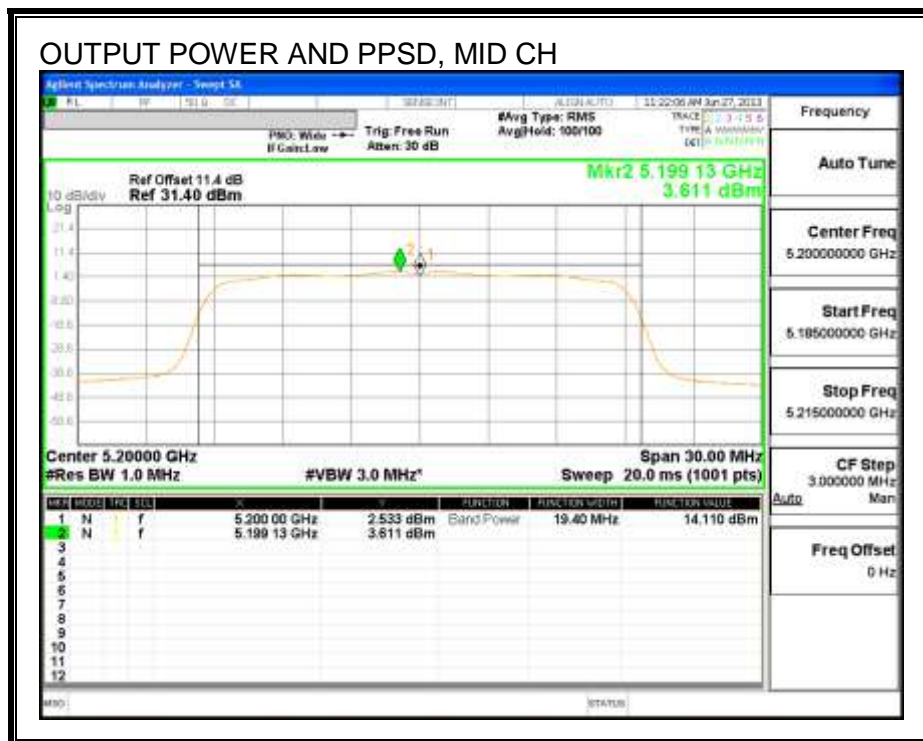
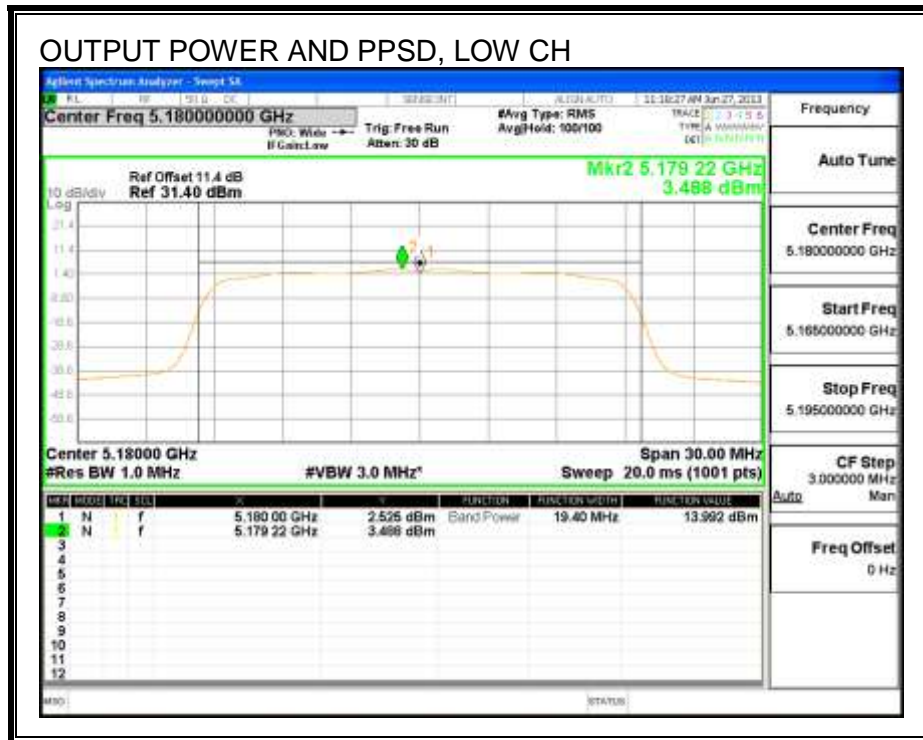

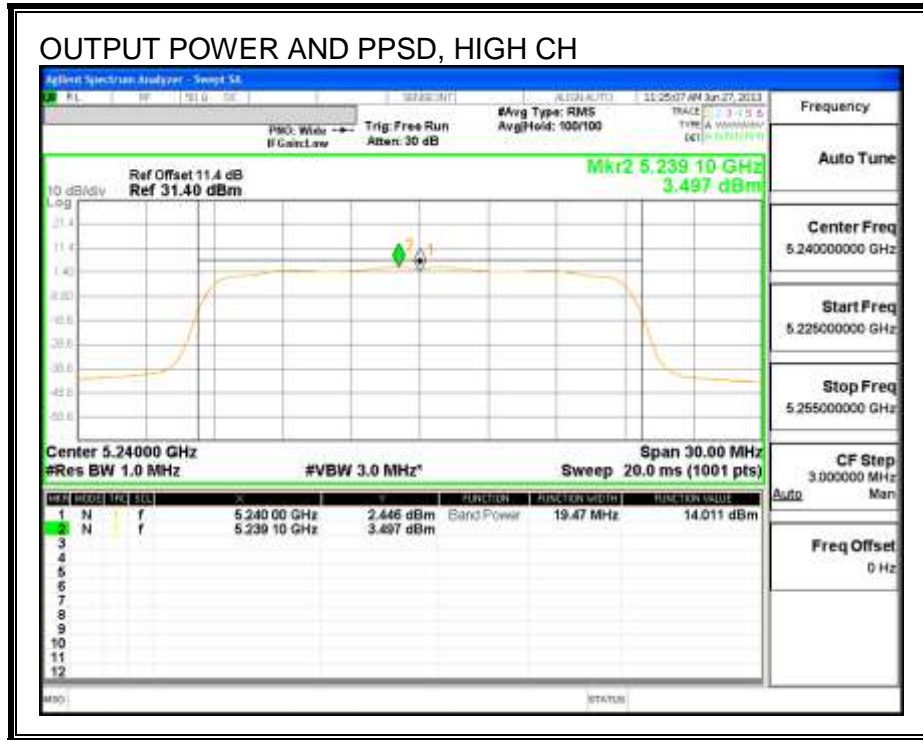

### 8.2.5. PEAK EXCURSION

#### LIMITS

FCC §15.407 (a) (6)

The ratio of the peak excursion of the modulation envelope (measured using a peak hold function) to the peak transmit power (measured as specified above) shall not exceed 13 dB across any 1 MHz bandwidth or the emission bandwidth whichever is less.

#### RESULTS

Channel	Frequency (MHz)	PK Level (dBm)	PSD (dBm)	DCCF (dB)	Peak Excursion (dB)	Limit (dB)	Margin (dB)
Mid	5200	14.96	3.488	0.07	11.40	13	-1.60

#### PEAK EXCURSION

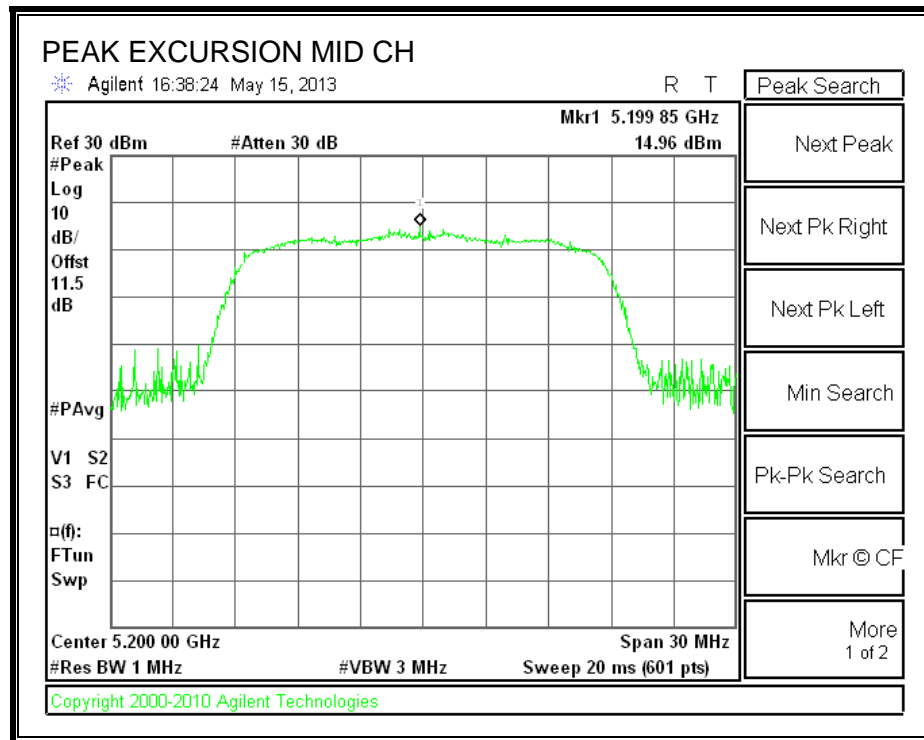

### 8.3. 802.11n HT40 MODE IN THE 5.2 GHz BAND

#### 8.3.1. 26 dB BANDWIDTH

##### LIMITS

None; for reporting purposes only.

##### RESULTS

Channel	Frequency (MHz)	26 dB Bandwidth (MHz)
Low	5190	44.40
5230	5230	43.87

##### 26 dB BANDWIDTH

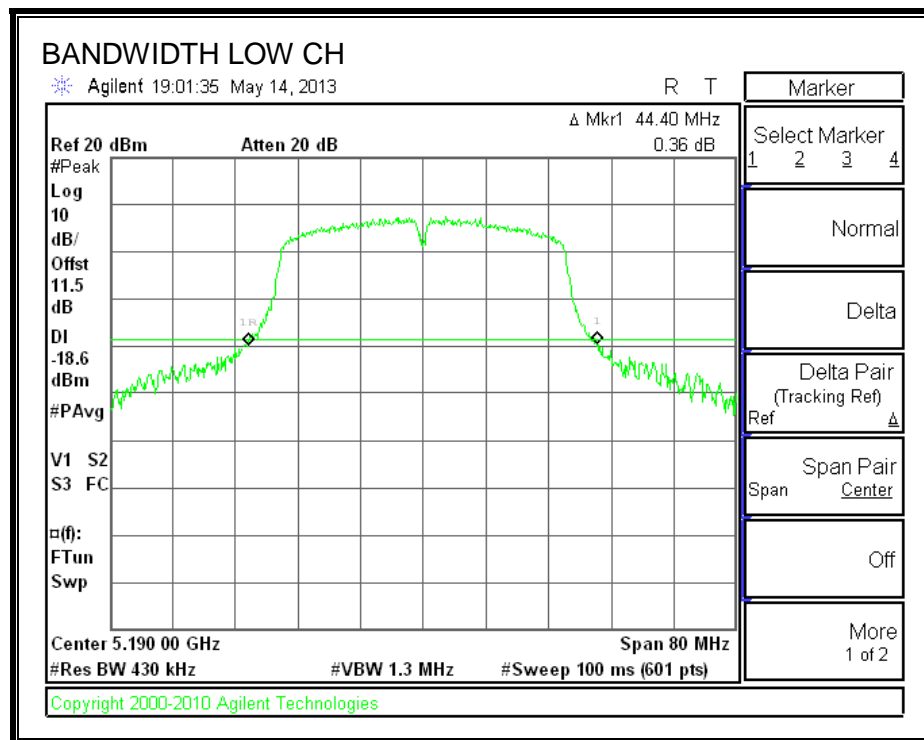

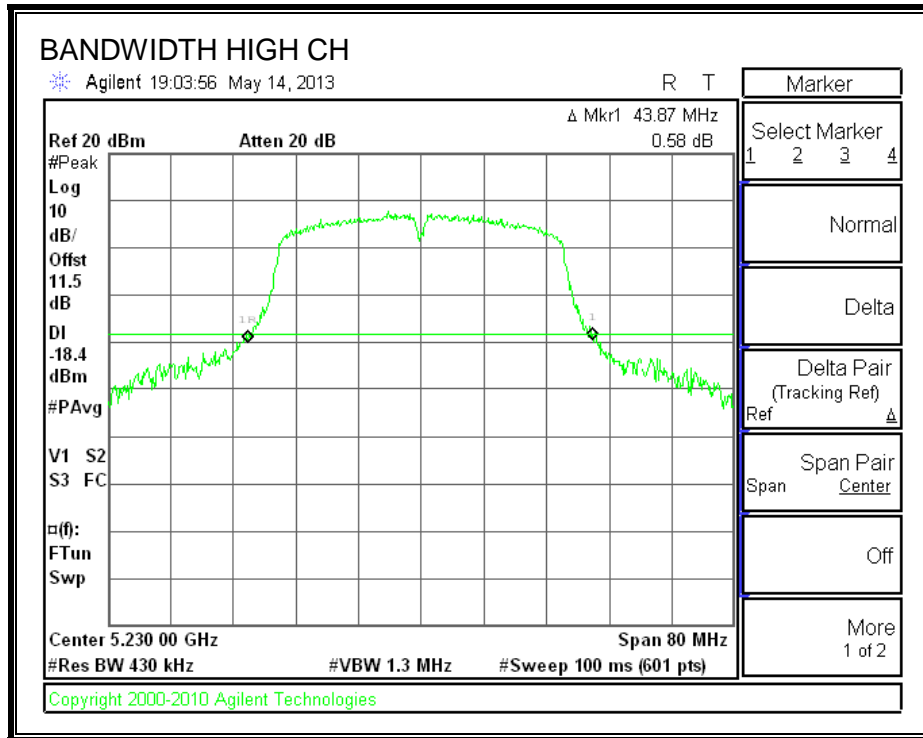

### 8.3.2. 99% BANDWIDTH

#### LIMITS

None; for reporting purposes only.

#### RESULTS

Channel	Frequency (MHz)	99% Bandwidth (MHz)
Low	5190	35.7778
High	5230	35.7688

#### 99% BANDWIDTH

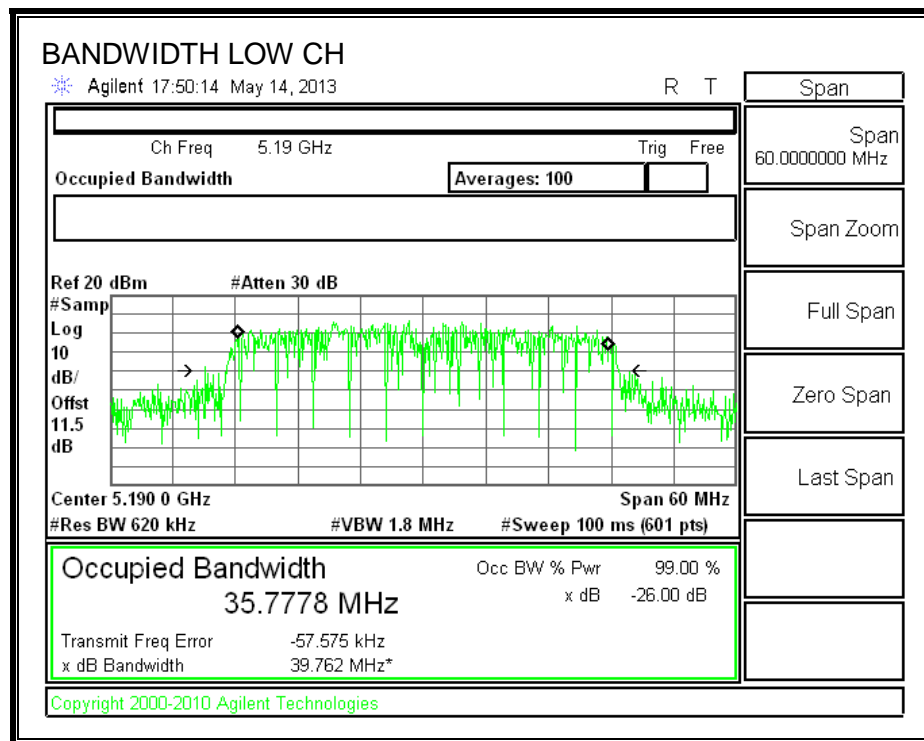

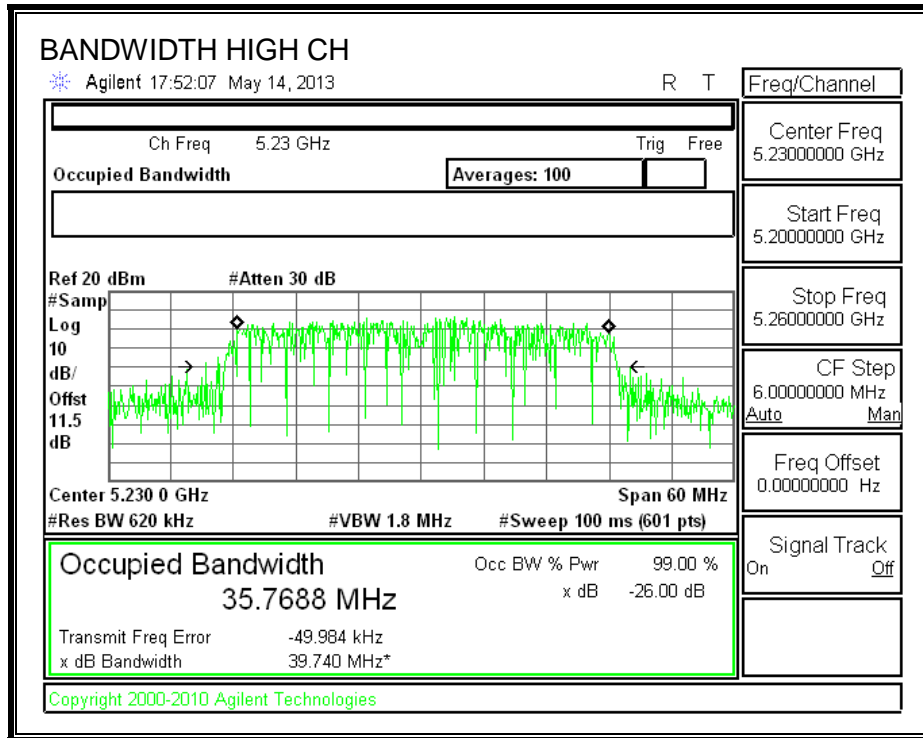



### 8.3.3. AVERAGE POWER

#### LIMITS

None; for reporting purposes only.

#### TEST PROCEDURE

The transmitter output is connected to a power meter.

The cable assembly insertion loss of 11.4 dB (including 10 dB pad and 1.4 dB cable) was entered as an offset in the power meter to allow for direct reading of power.

#### RESULTS

Channel	Frequency (MHz)	Power (dBm)
Mid	5190	16.20
High	5230	16.00

### **8.3.4. OUTPUT POWER AND PPSD**

#### **LIMITS**

FCC §15.407 (a) (1)

For the band 5.15–5.25 GHz, the maximum conducted output power over the frequency band of operation shall not exceed the lesser of 50 mW or  $4 \text{ dBm} + 10 \log B$ , where B is the 26–dB emission bandwidth in MHz. In addition, the peak power spectral density shall not exceed 4 dBm in any 1–MHz band. If transmitting antennas of directional gain greater than 6 dBi are used, both the maximum conducted output power and the peak power spectral density shall be reduced by the amount in dB that the directional gain of the antenna exceeds 6 dBi.

IC RSS-210 A9.2 (1)

The maximum e.i.r.p. shall not exceed 200 mW or  $10 + 10 \log_{10} B$ , dBm, whichever power is less. B is the 99% emission bandwidth in MHz. The e.i.r.p. spectral density shall not exceed 10 dBm in any 1.0 MHz band.

#### **DIRECTIONAL ANTENNA GAIN**

There is only one transmitter output therefore the directional gain is equal to the antenna gain.

**RESULTS**

**Bandwidth and Antenna Gain**

Channel	Frequency (MHz)	Min 26 dB BW (MHz)	Min 99% BW (MHz)	Directional Gain (dBi)
Low	5190	44.40	35.7778	-6.00
High	5230	43.87	35.7688	-6.00

**Limits**

Channel	Frequency (MHz)	FCC Power Limit (dBm)	IC EIRP Limit (dBm)	Max IC Power (dBm)	Power Limit (dBm)	FCC PPSD Limit (dBm)	IC eirp PSD Limit (dBm)	PPSD Limit (dBm)
Low	5190	17.00	23.00	29.00	17.00	4.00	10.00	4.00
High	5230	17.00	23.00	29.00	17.00	4.00	10.00	4.00

<b>Duty Cycle CF (dB)</b>	0.16	<b>Included in Calculations of Corr'd Power &amp; PPSD</b>
---------------------------	------	--

**Output Power Results**

Channel	Frequency (MHz)	Meas Power (dBm)	Total Corr'd Power (dBm)	Power Limit (dBm)	Power Margin (dB)
Low	5190	16.286	16.45	17.00	-0.55
High	5230	16.043	16.20	17.00	-0.80

**PPSD Results**

Channel	Frequency (MHz)	Meas PPSD (dBm)	Total Corr'd PPSD (dBm)	PPSD Limit (dBm)	PPSD Margin (dB)
Low	5190	2.724	2.88	4.00	-1.12
High	5230	2.222	2.38	4.00	-1.62

**OUTPUT POWER AND PPSD**

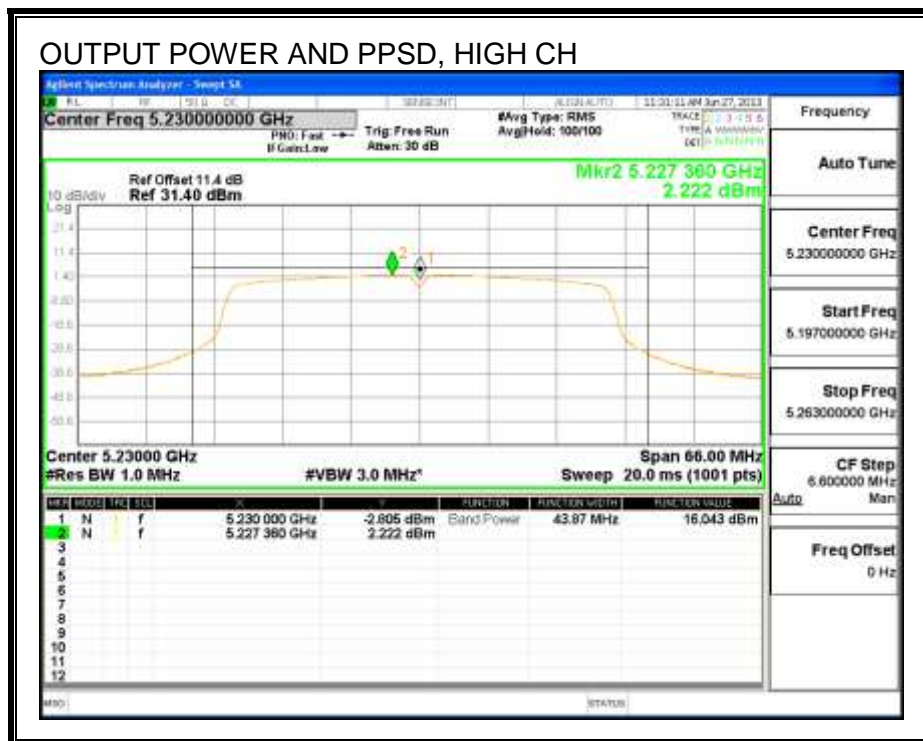
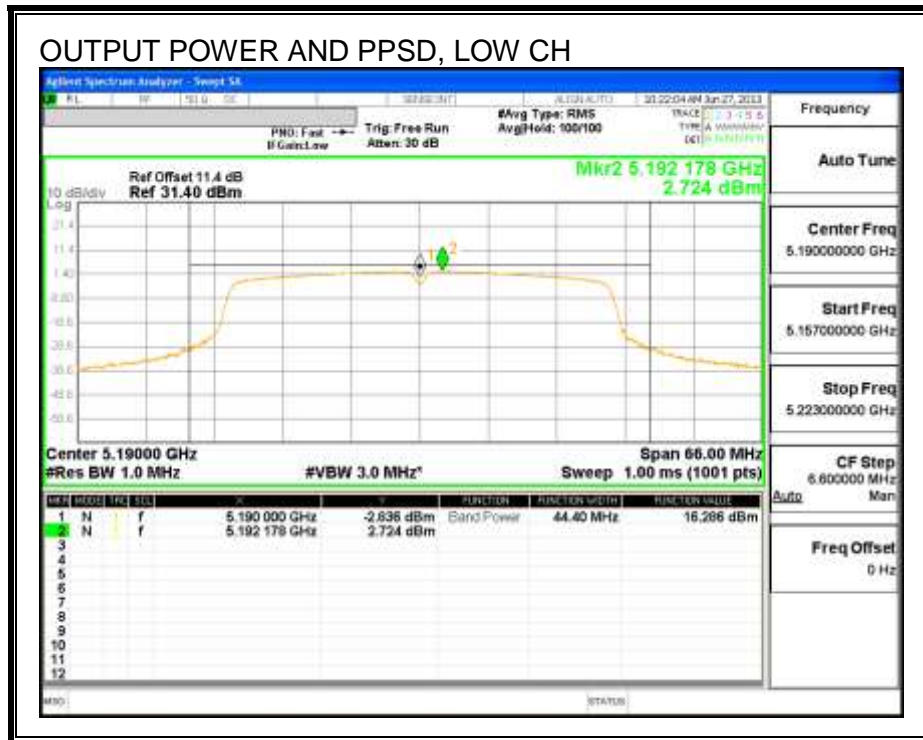

### 8.3.5. PEAK EXCURSION Fixed

#### LIMITS

FCC §15.407 (a) (6)

The ratio of the peak excursion of the modulation envelope (measured using a peak hold function) to the peak transmit power (measured as specified above) shall not exceed 13 dB across any 1 MHz bandwidth or the emission bandwidth whichever is less.

#### RESULTS

Refer to the results of 802.11n HT20 mode in the 5.2 GHz band.

Channel	Frequency (MHz)	PK Level (dBm)	PSD (dBm)	DCCF (dB)	Peak Excursion (dB)	Limit (dB)	Margin (dB)
Mid	5190	10.55	2.222	0.16	8.17	13	-4.83

#### PEAK EXCURSION

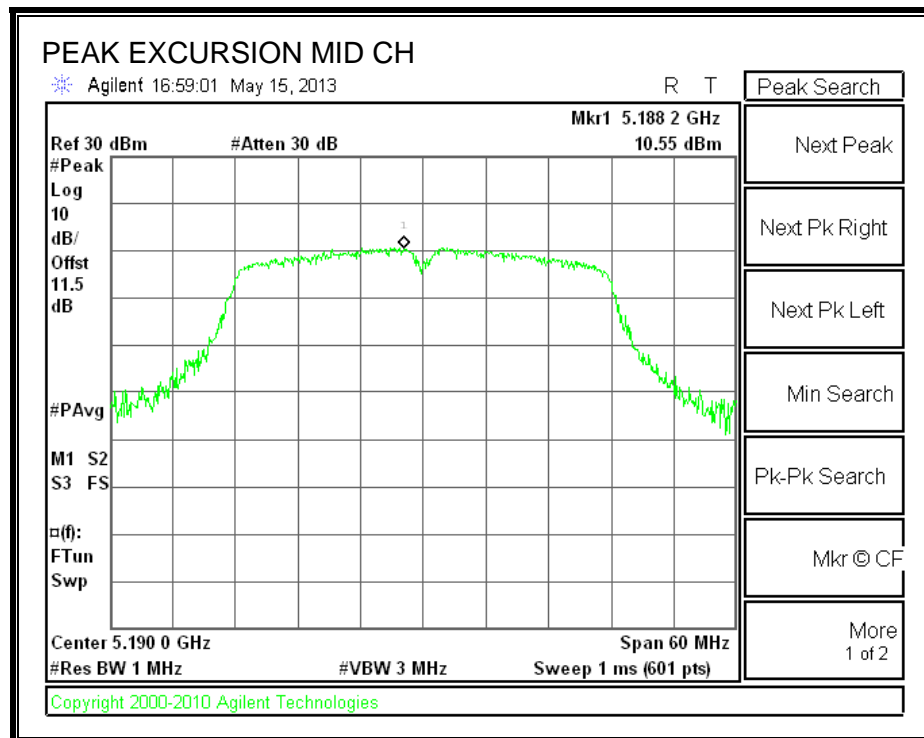

## 8.4. 802.11a MODE IN THE 5.3 GHz BAND

### 8.4.1. 26 dB BANDWIDTH

#### LIMITS

None; for reporting purposes only.

#### RESULTS

Channel	Frequency (MHz)	26 dB Bandwidth (MHz)
Low	5260	19.07
Mid	5300	19.13
High	5320	19.27

#### 26 dB BANDWIDTH

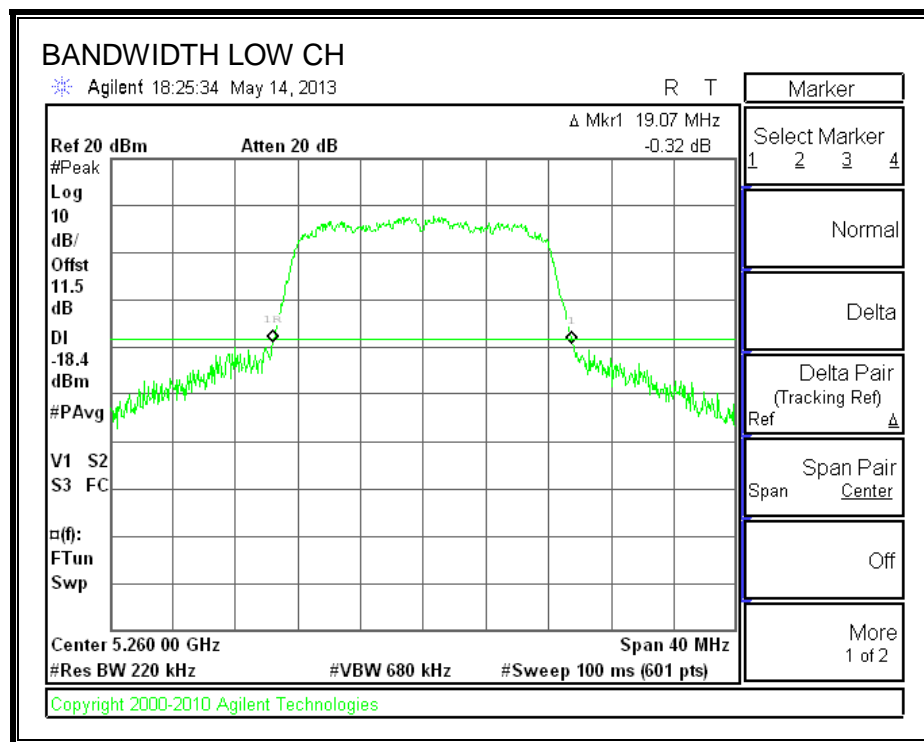

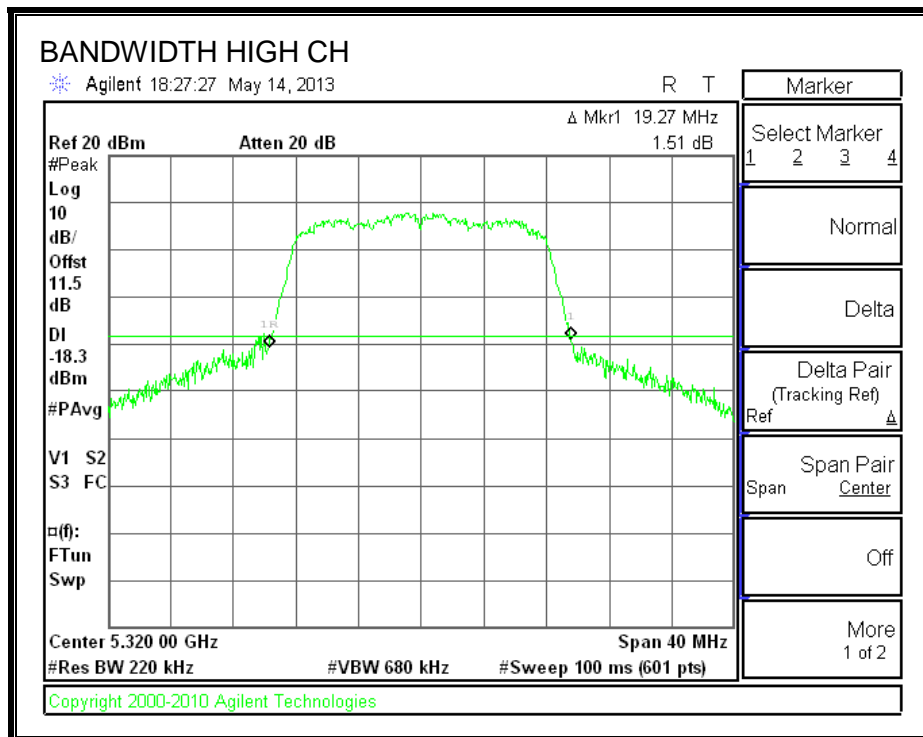
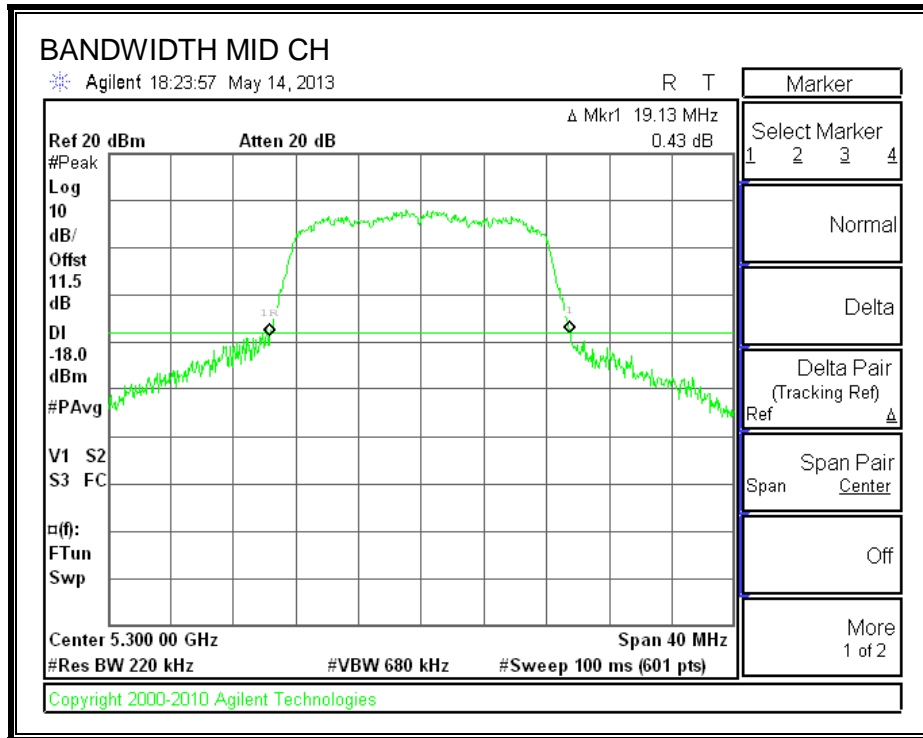

### 8.4.2. 99% BANDWIDTH

#### LIMITS

None; for reporting purposes only.

#### RESULTS

Channel	Frequency (MHz)	99% Bandwidth (MHz)
Low	5260	16.3332
Mid	5300	16.3261
High	5320	16.3385

#### 99% BANDWIDTH

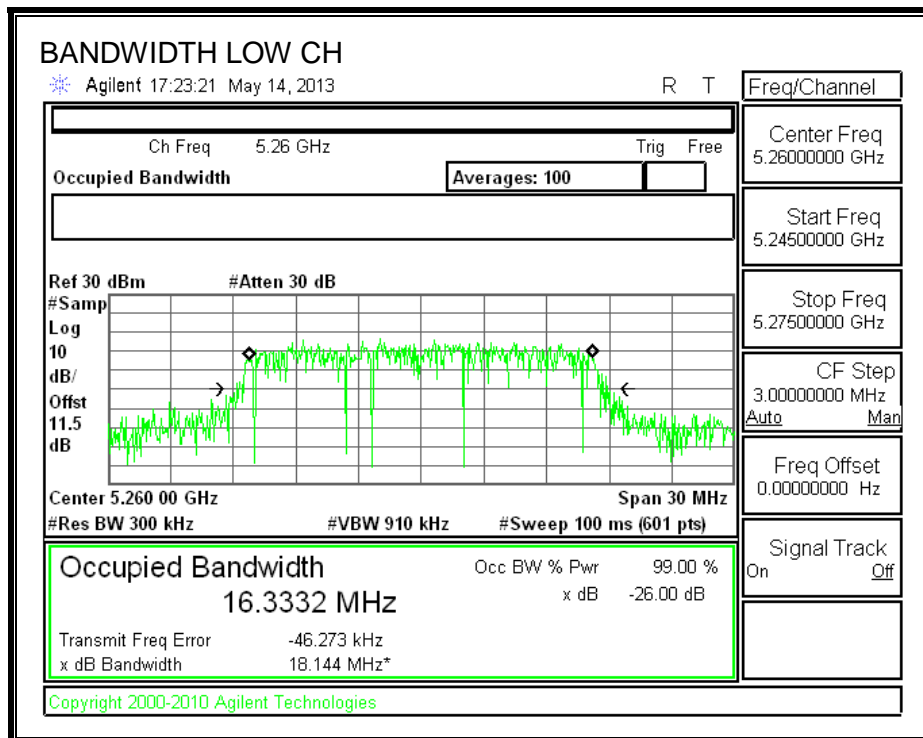



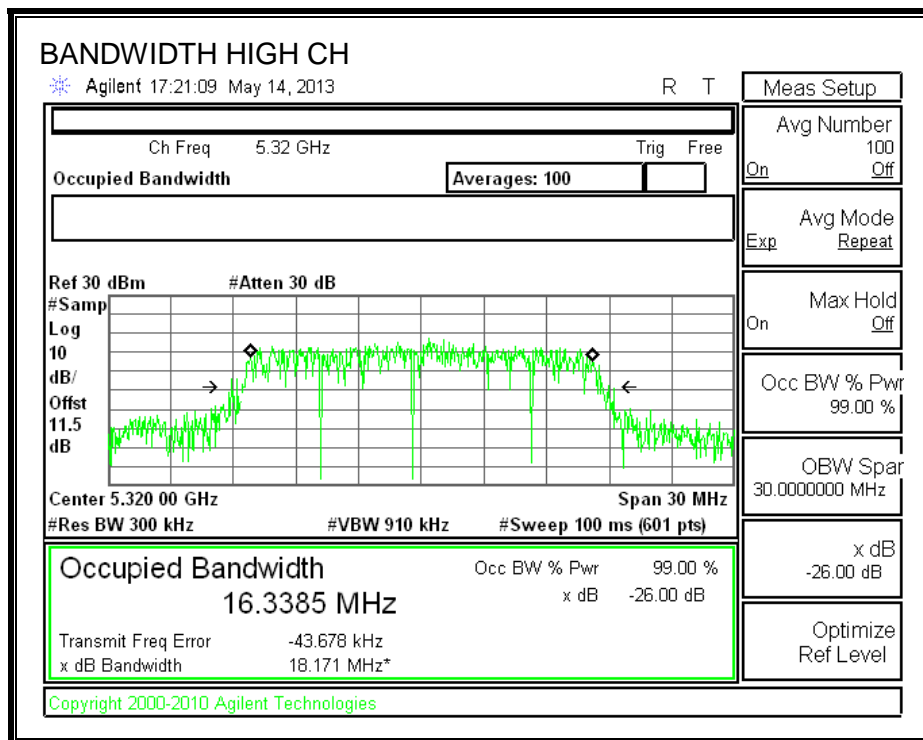
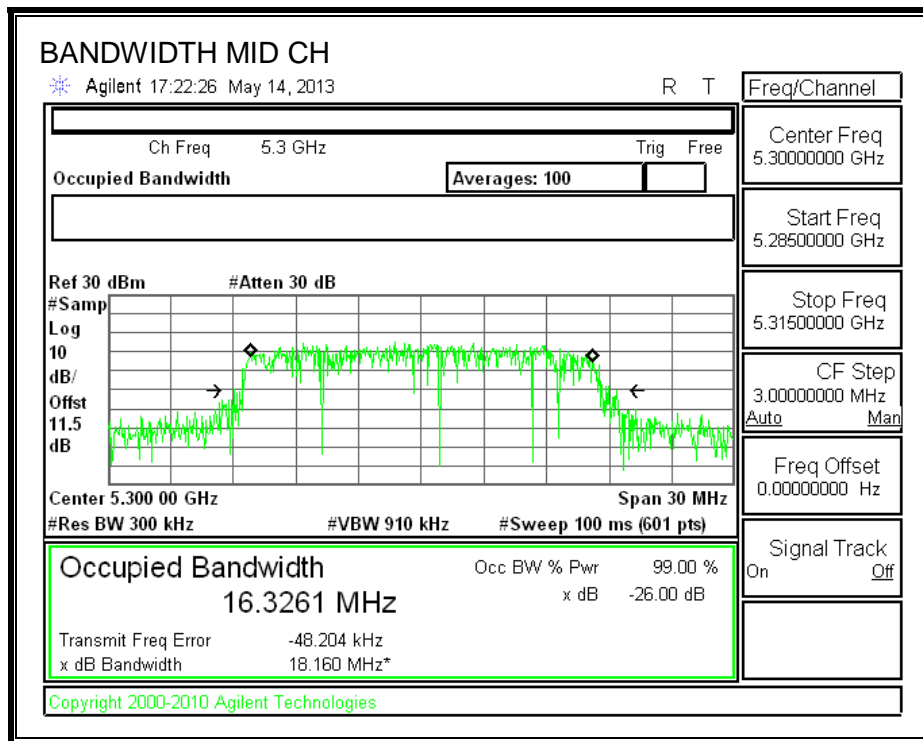

### 8.4.3. AVERAGE POWER

#### LIMITS

None; for reporting purposes only.

#### TEST PROCEDURE

The transmitter output is connected to a power meter.

The cable assembly insertion loss of 11.4 dB (including 10 dB pad and 1.4 dB cable) was entered as an offset in the power meter to allow for direct reading of power.

#### RESULTS

Channel	Frequency (MHz)	Power (dBm)
Low	5260	15.90
Mid	5300	15.91
High	5320	15.95

#### **8.4.4. OUTPUT POWER AND PPSD**

##### **LIMITS**

FCC §15.407 (a) (1)

For the band 5.25–5.35 GHz, the maximum conducted output power over the frequency band of operation shall not exceed the lesser of 250 mW or  $11 \text{ dBm} + 10 \log B$ , where B is the 26–dB emission bandwidth in MHz. In addition, the peak power spectral density shall not exceed 11 dBm in any 1–MHz band. If transmitting antennas of directional gain greater than 6 dBi are used, both the maximum conducted output power and the peak power spectral density shall be reduced by the amount in dB that the directional gain of the antenna exceeds 6 dBi.

IC RSS-210 A9.2 (1)

The maximum e.i.r.p. shall not exceed 200 mW or  $10 + 10 \log_{10} B$ , dBm, whichever power is less. B is the 99% emission bandwidth in MHz. The e.i.r.p. spectral density shall not exceed 10 dBm in any 1.0 MHz band.

##### **DIRECTIONAL ANTENNA GAIN**

There is only one transmitter output therefore the directional gain is equal to the antenna gain.

**RESULTS**

**Bandwidth and Antenna Gain**

Channel	Frequency (MHz)	Min 26 dB BW (MHz)	Min 99% BW (MHz)	Directional Gain (dBi)
Low	5260	19.07	16.3332	-6.00
Mid	5300	19.13	16.3261	-6.00
High	5320	19.27	16.3385	-6.00

**Limits**

Channel	Frequency (MHz)	FCC Power Limit (dBm)	IC Power Limit (dBm)	IC EIRP Limit (dBm)	Power Limit (dBm)	FCC PPSD Limit (dBm)	IC PSD Limit (dBm)	PPSD Limit (dBm)
Low	5260	23.80	23.13	29.13	23.13	11.00	11.00	11.00
Mid	5300	23.82	23.13	29.13	23.13	11.00	11.00	11.00
High	5320	23.85	23.13	29.13	23.13	11.00	11.00	11.00

<b>Duty Cycle CF (dB)</b>	0.07	<b>Included in Calculations of Corr'd Power &amp; PPSD</b>
---------------------------	------	--

**Output Power Results**

Channel	Frequency (MHz)	Meas Power (dBm)	Total Corr'd Power (dBm)	Power Limit (dBm)	Power Margin (dB)
Low	5260	15.939	16.01	23.13	-7.12
Mid	5300	15.947	16.02	23.13	-7.11
High	5320	15.973	16.04	23.13	-7.09

**PPSD Results**

Channel	Frequency (MHz)	Meas PPSD (dBm)	Total Corr'd PPSD (dBm)	PPSD Limit (dBm)	PPSD Margin (dB)
Low	5260	5.603	5.67	11.00	-5.33
Mid	5300	5.600	5.67	11.00	-5.33
High	5320	5.636	5.71	11.00	-5.29

**OUTPUT POWER AND PPSD**

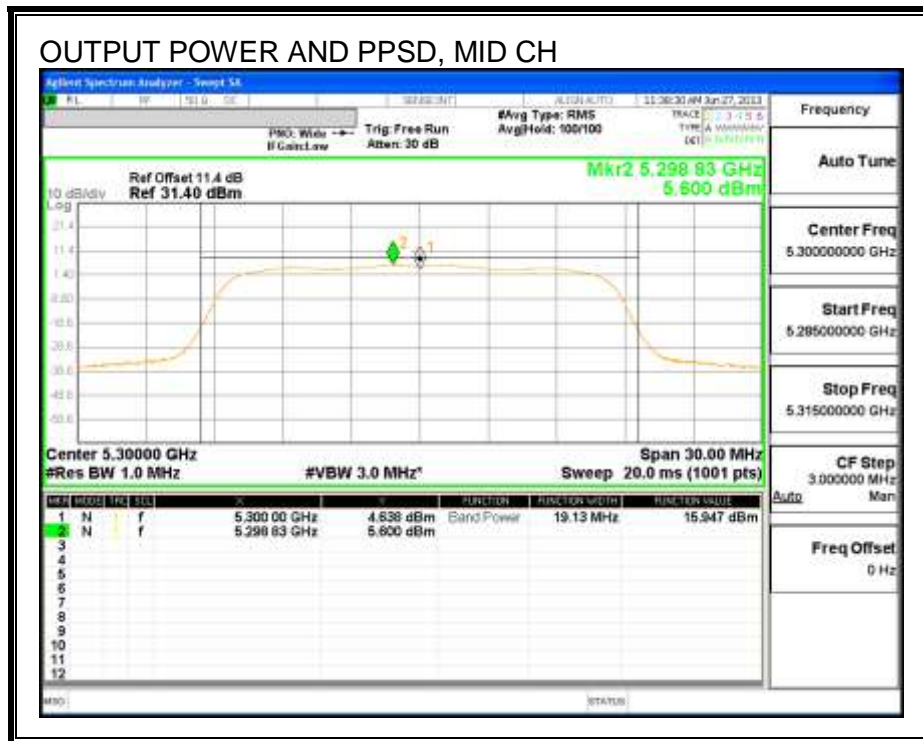
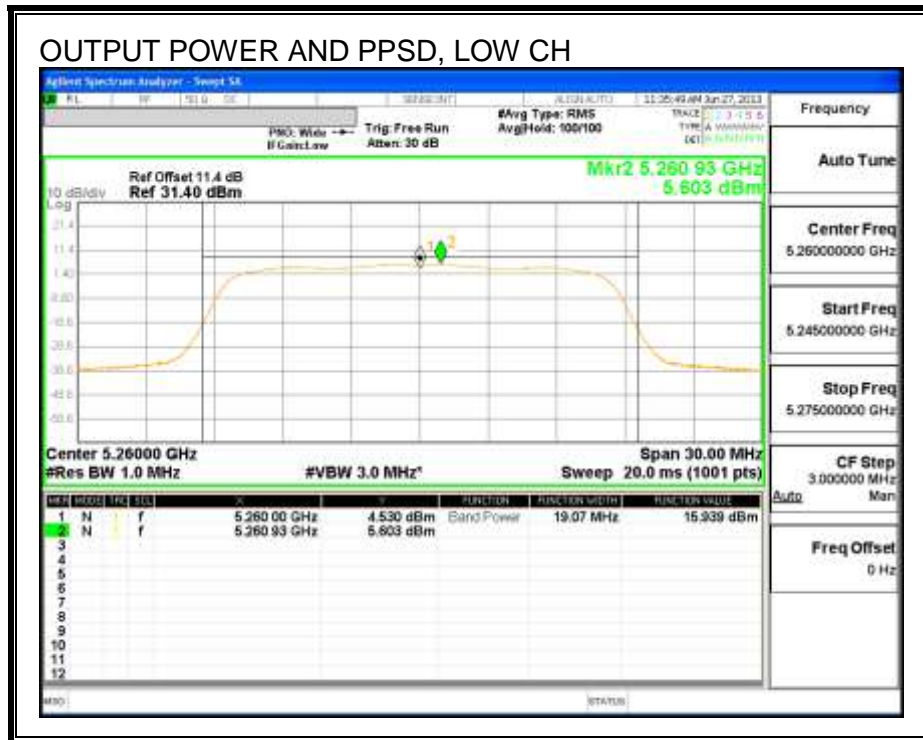

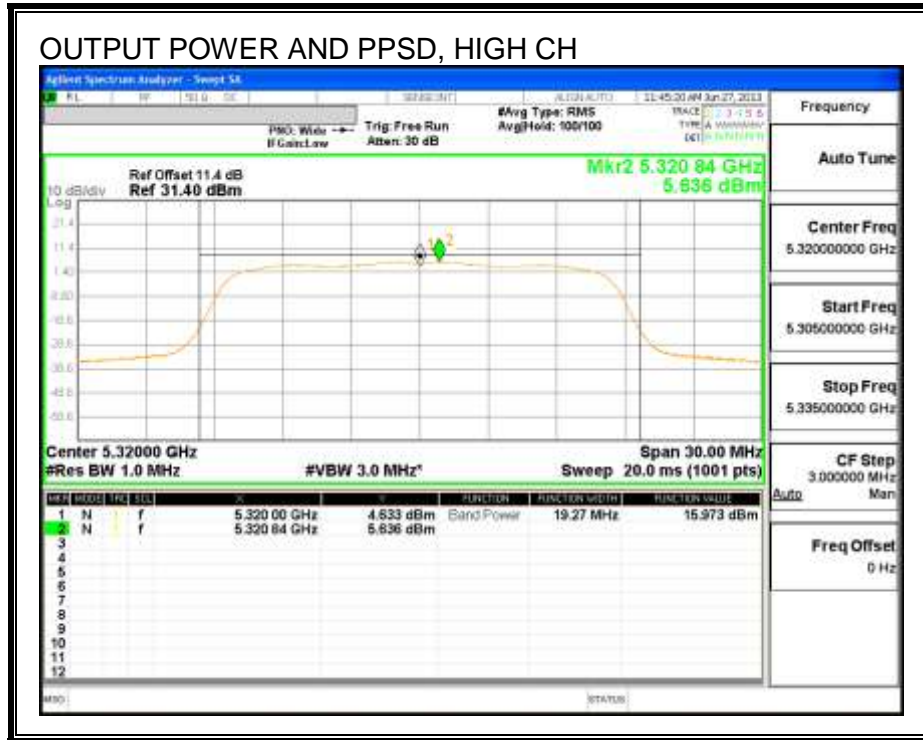

### 8.4.5. PEAK EXCURSION

#### LIMITS

FCC §15.407 (a) (6)

The ratio of the peak excursion of the modulation envelope (measured using a peak hold function) to the peak transmit power (measured as specified above) shall not exceed 13 dB across any 1 MHz bandwidth or the emission bandwidth whichever is less.

#### RESULTS

Refer to the results of 802.11n HT20 mode in the 5.2 GHz band.

Channel	Frequency (MHz)	PK Level (dBm)	PSD (dBm)	DCCF (dB)	Peak Excursion (dB)	Limit (dB)	Margin (dB)
Mid	5300	13.91	5.600	0.07	8.24	13	-4.76

#### PEAK EXCURSION

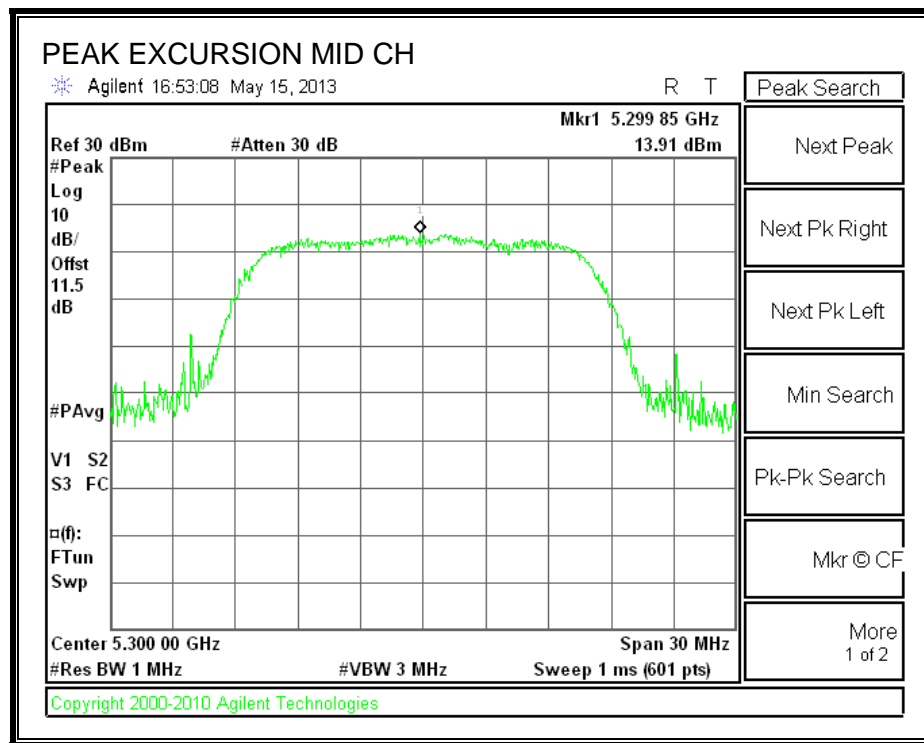

## 8.5. 802.11n HT20 MODE IN THE 5.3 GHz BAND

### 8.5.1. 26 dB BANDWIDTH

#### LIMITS

None; for reporting purposes only.

#### RESULTS

Channel	Frequency (MHz)	26 dB Bandwidth (MHz)
Low	5260	19.40
Mid	5300	19.33
High	5320	19.33

#### 26 dB BANDWIDTH

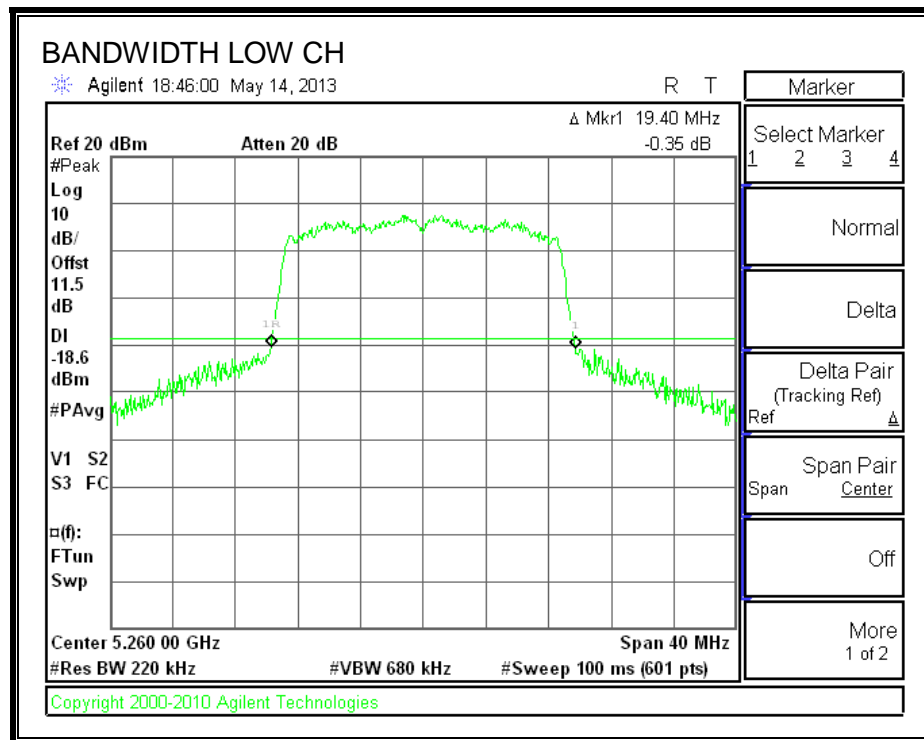



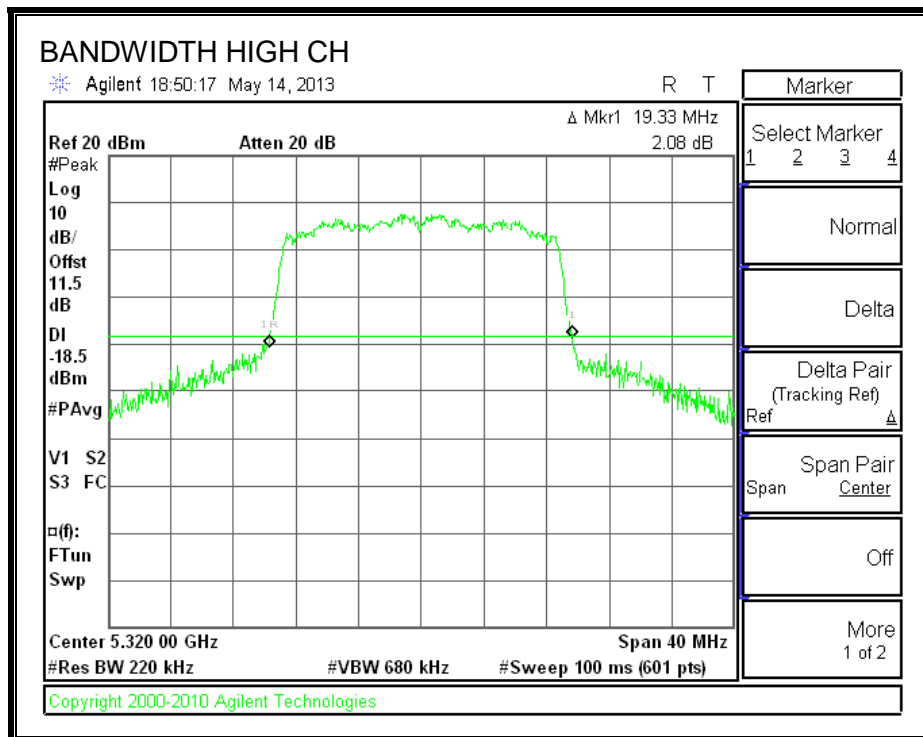
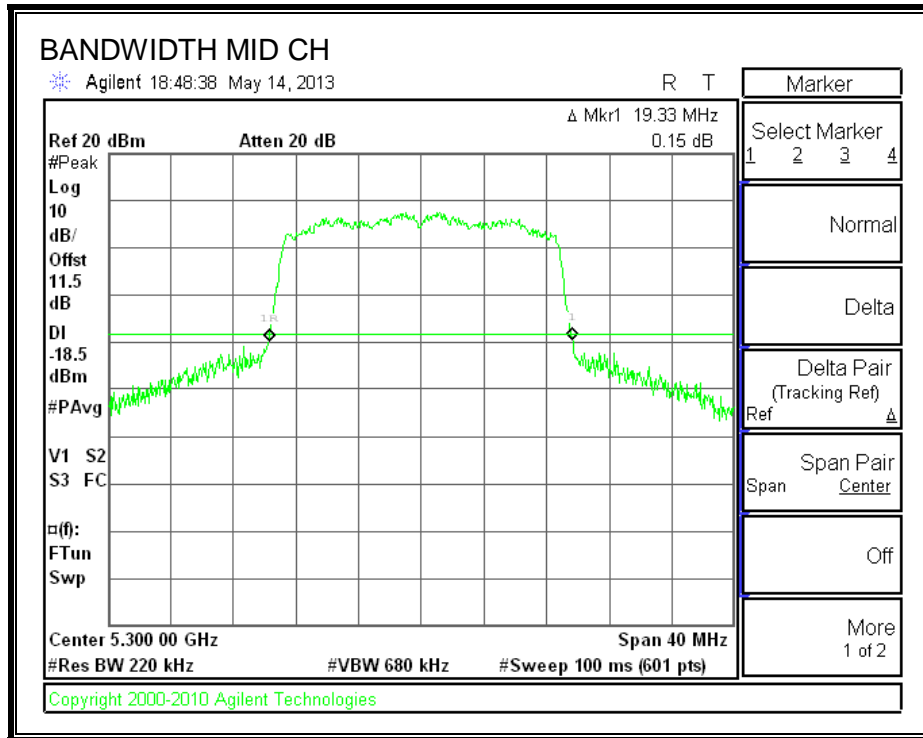

### 8.5.2. 99% BANDWIDTH

#### LIMITS

None; for reporting purposes only.

#### RESULTS

Channel	Frequency (MHz)	99% Bandwidth (MHz)
Low	5260	17.5130
Mid	5300	17.5206
High	5320	17.5094

#### 99% BANDWIDTH

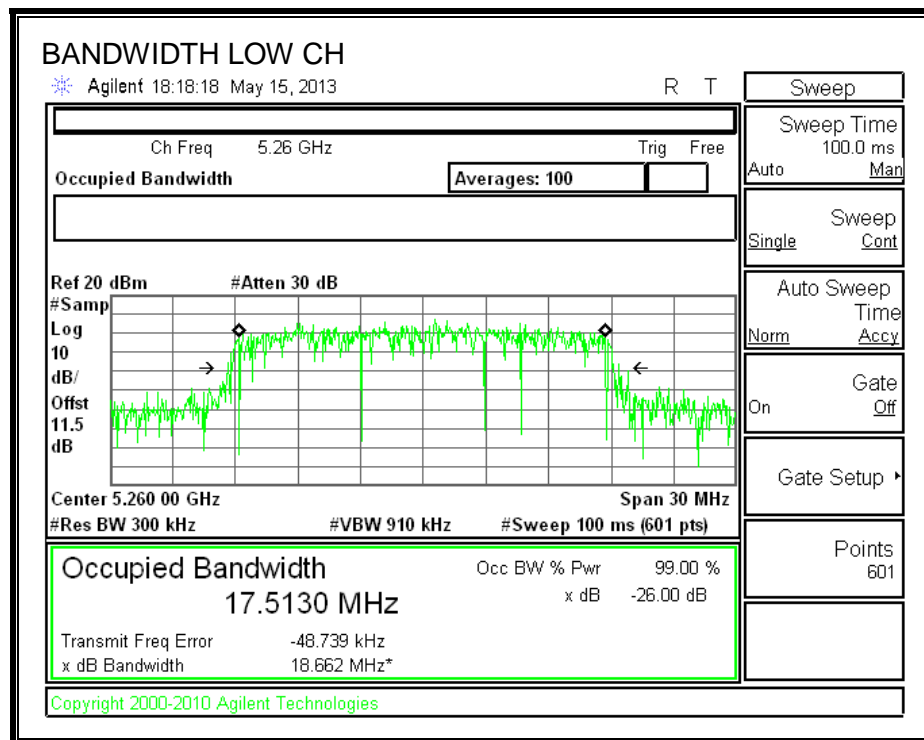

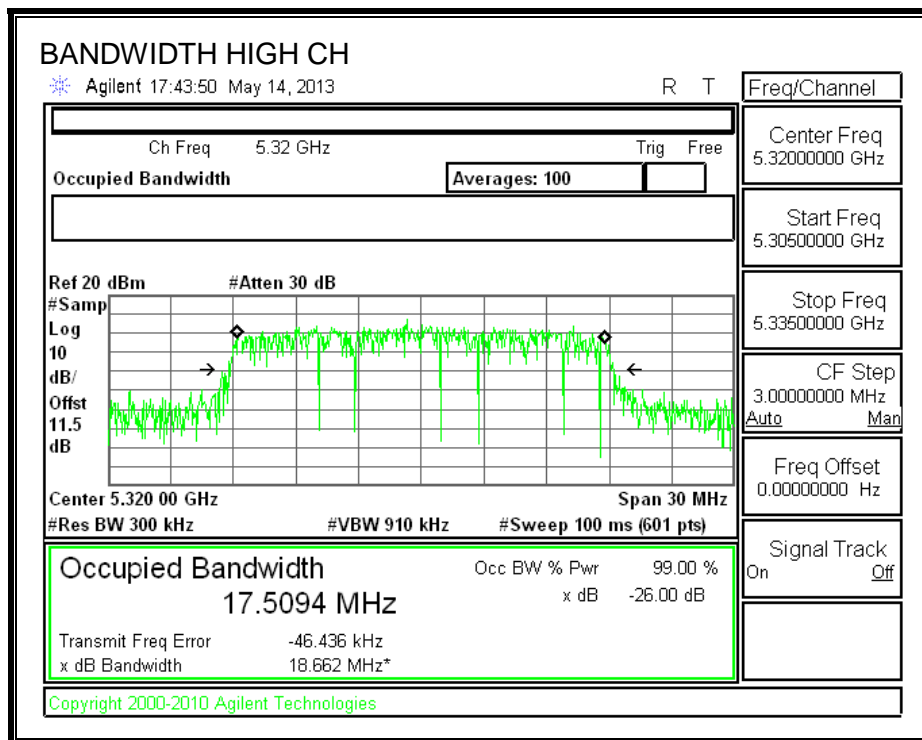
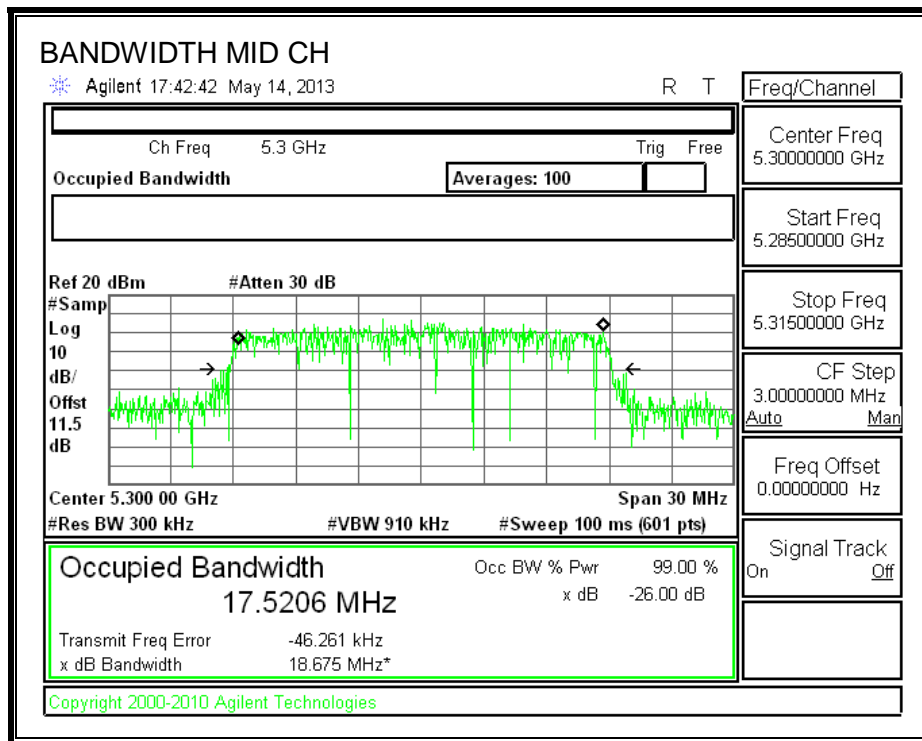

### 8.5.3. AVERAGE POWER

#### LIMITS

None; for reporting purposes only.

#### TEST PROCEDURE

The transmitter output is connected to a power meter.

The cable assembly insertion loss of 11.4 dB (including 10 dB pad and 1.4 dB cable) was entered as an offset in the power meter to allow for direct reading of power.

#### RESULTS

Channel	Frequency (MHz)	Power (dBm)
Low	5260	16.04
Mid	5300	16.00
High	5320	16.00

## **8.5.4. OUTPUT POWER AND PPSD**

### **LIMITS**

FCC §15.407 (a) (1)

For the band 5.25–5.35 GHz, the maximum conducted output power over the frequency band of operation shall not exceed the lesser of 250 mW or  $11 \text{ dBm} + 10 \log B$ , where B is the 26-dB emission bandwidth in MHz. In addition, the peak power spectral density shall not exceed 11 dBm in any 1-MHz band. If transmitting antennas of directional gain greater than 6 dBi are used, both the maximum conducted output power and the peak power spectral density shall be reduced by the amount in dB that the directional gain of the antenna exceeds 6 dBi.

IC RSS-210 A9.2 (1)

The maximum e.i.r.p. shall not exceed 200 mW or  $10 + 10 \log_{10} B$ , dBm, whichever power is less. B is the 99% emission bandwidth in MHz. The e.i.r.p. spectral density shall not exceed 10 dBm in any 1.0 MHz band.

### **DIRECTIONAL ANTENNA GAIN**

There is only one transmitter output therefore the directional gain is equal to the antenna gain.

**RESULTS**

**Bandwidth and Antenna Gain**

Channel	Frequency (MHz)	Min 26 dB BW (MHz)	Min 99% BW (MHz)	Directional Gain (dBi)
Low	5260	19.40	17.5130	-6.00
Mid	5300	19.33	17.5206	-6.00
High	5320	19.33	17.5094	-6.00

**Limits**

Channel	Frequency (MHz)	FCC Power Limit (dBm)	IC Power Limit (dBm)	IC EIRP Limit (dBm)	Power Limit (dBm)	FCC PPSD Limit (dBm)	IC PSD Limit (dBm)	PPSD Limit (dBm)
Low	5260	23.88	23.43	29.43	23.43	11.00	11.00	11.00
Mid	5300	23.86	23.44	29.44	23.44	11.00	11.00	11.00
High	5320	23.86	23.43	29.43	23.43	11.00	11.00	11.00

<b>Duty Cycle CF (dB)</b>	0.07	<b>Included in Calculations of Corr'd Power &amp; PPSD</b>
---------------------------	------	--

**Output Power Results**

Channel	Frequency (MHz)	Meas Power (dBm)	Total Corr'd Power (dBm)	Power Limit (dBm)	Power Margin (dB)
Low	5260	16.178	16.25	23.43	-7.19
Mid	5300	16.183	16.25	23.44	-7.18
High	5320	16.048	16.12	23.43	-7.31

**PPSD Results**

Channel	Frequency (MHz)	Meas PPSD (dBm)	Total Corr'd PPSD (dBm)	PPSD Limit (dBm)	PPSD Margin (dB)
Low	5260	5.637	5.71	11.00	-5.29
Mid	5300	5.658	5.73	11.00	-5.27
High	5320	5.547	5.62	11.00	-5.38

**OUTPUT POWER AND PPSD**

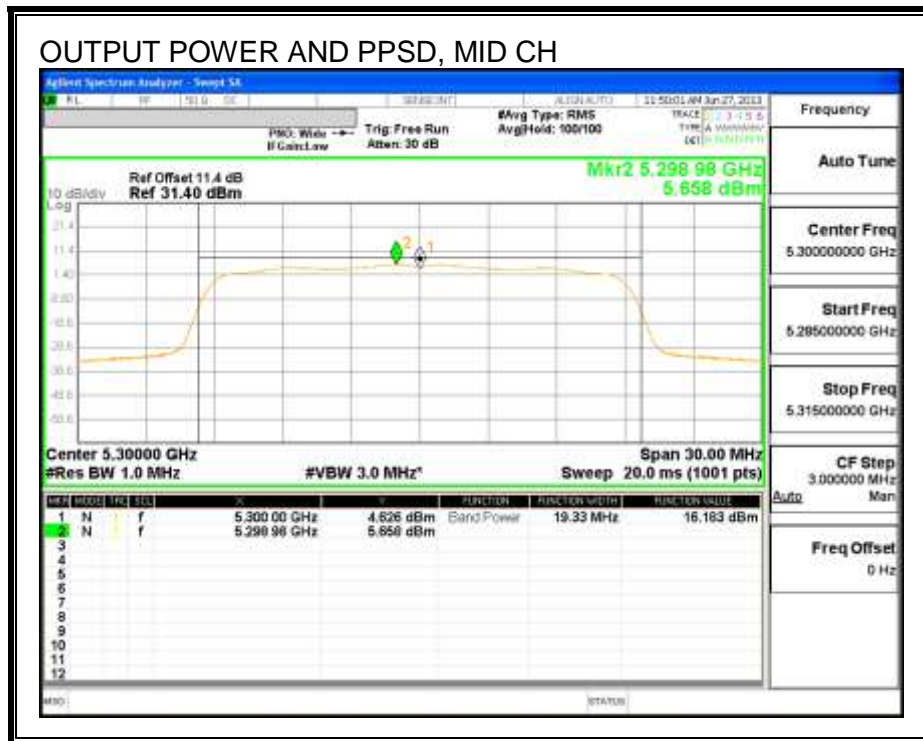
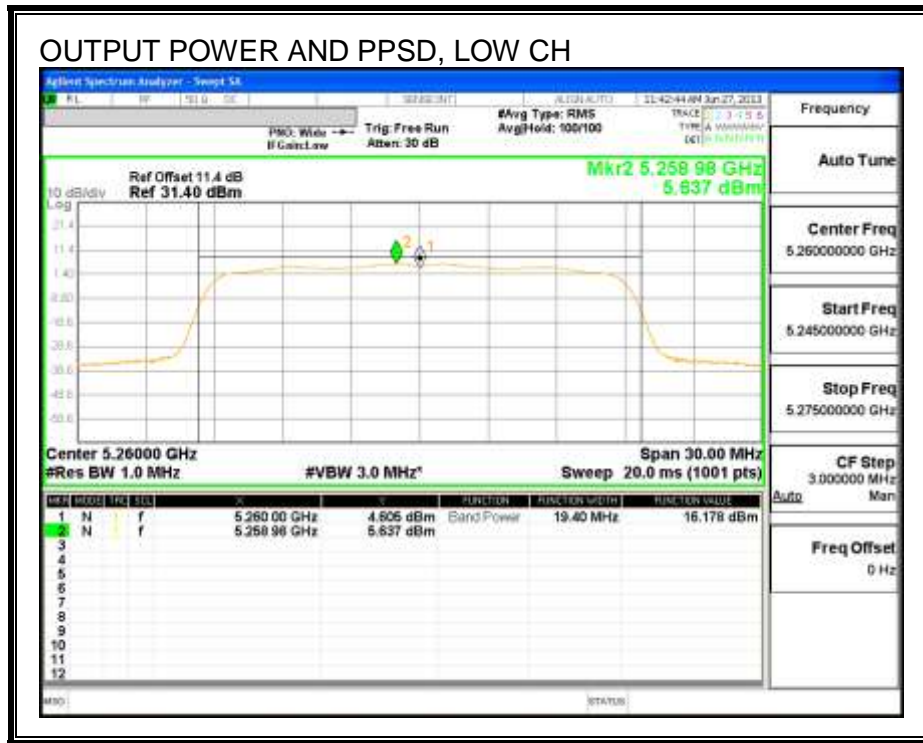

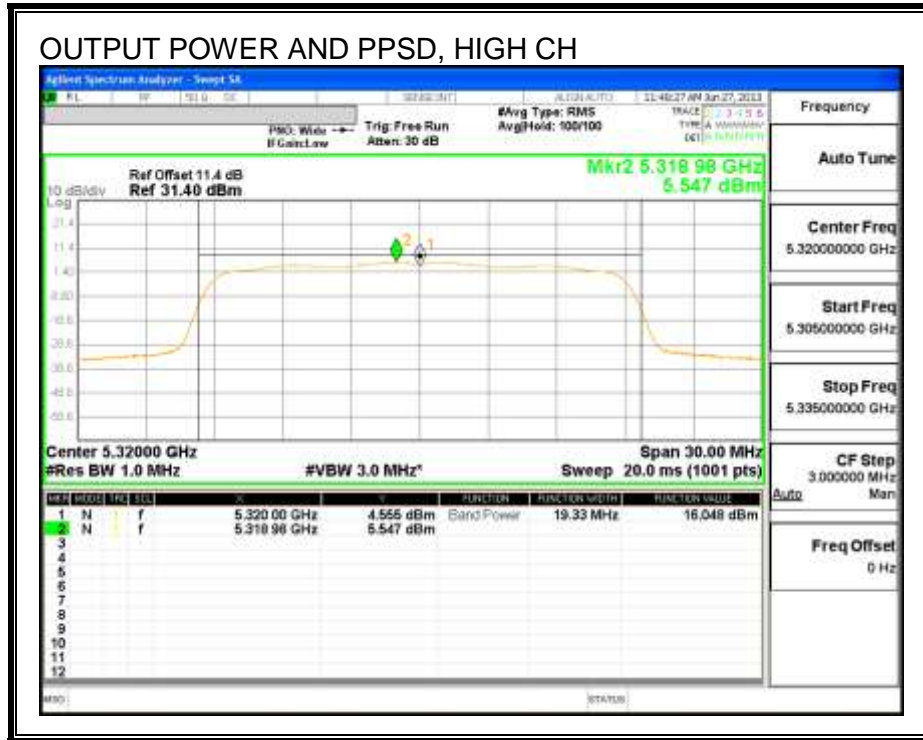



### 8.5.5. PEAK EXCURSION

#### LIMITS

FCC §15.407 (a) (6)

The ratio of the peak excursion of the modulation envelope (measured using a peak hold function) to the peak transmit power (measured as specified above) shall not exceed 13 dB across any 1 MHz bandwidth or the emission bandwidth whichever is less.

#### RESULTS

Refer to the results of 802.11n HT20 mode in the 5.2 GHz band.

Channel	Frequency (MHz)	PK Level (dBm)	PSD (dBm)	DCCF (dB)	Peak Excursion (dB)	Limit (dB)	Margin (dB)
Mid	5300	13.60	5.547	0.07	7.98	13	-5.02

#### PEAK EXCURSION

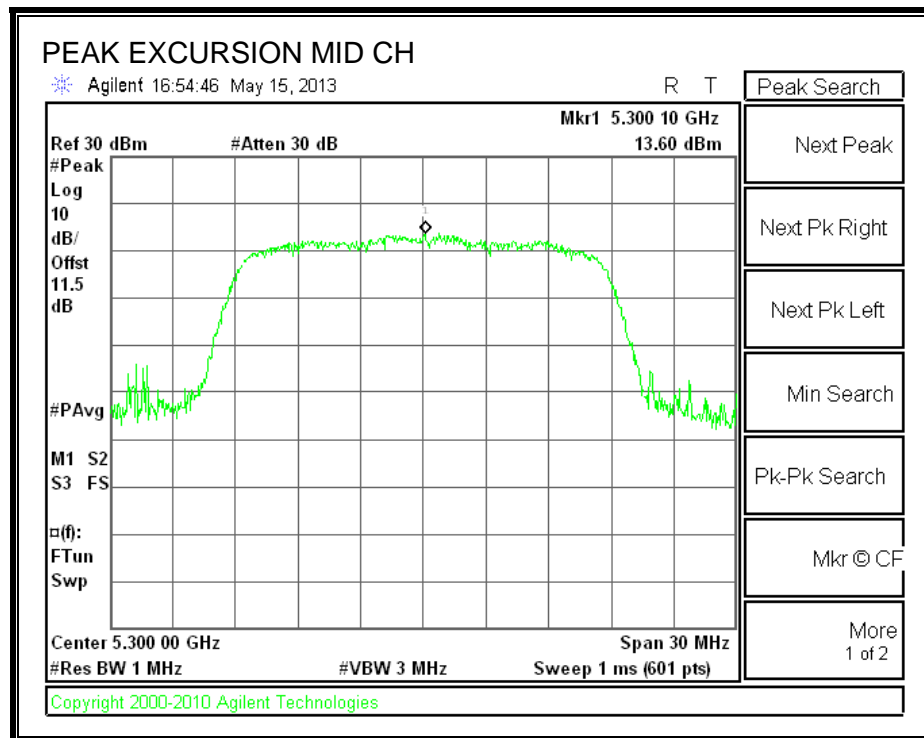

## 8.6. 802.11n HT40 MODE IN THE 5.3 GHz BAND

### 8.6.1. 26 dB BANDWIDTH

#### LIMITS

None; for reporting purposes only.

#### RESULTS

Channel	Frequency (MHz)	26 dB Bandwidth (MHz)
Low	5270	44.13
High	5310	44.00

#### 26 dB BANDWIDTH

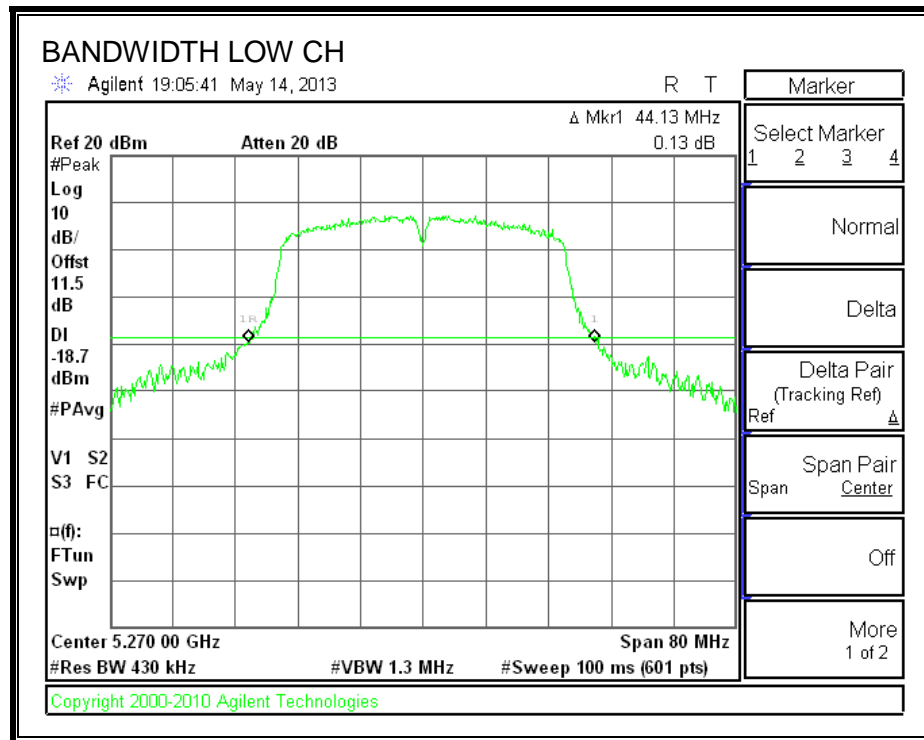

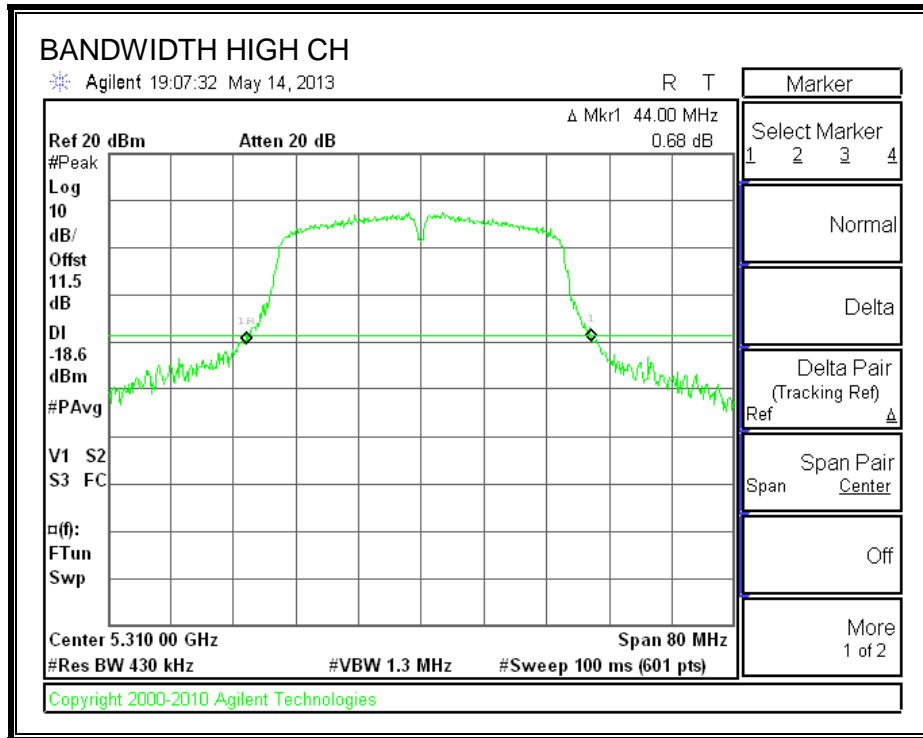

### 8.6.2. 99% BANDWIDTH

#### LIMITS

None; for reporting purposes only.

#### RESULTS

Channel	Frequency (MHz)	99% Bandwidth (MHz)
Low	5270	35.7858
High	5310	35.7715

**99% BANDWIDTH**

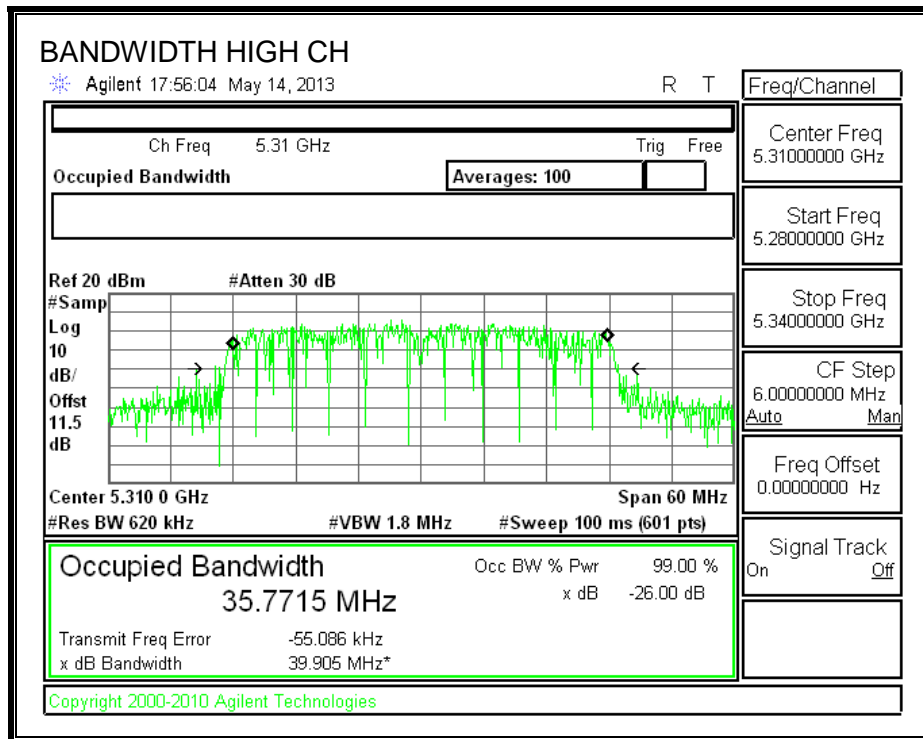
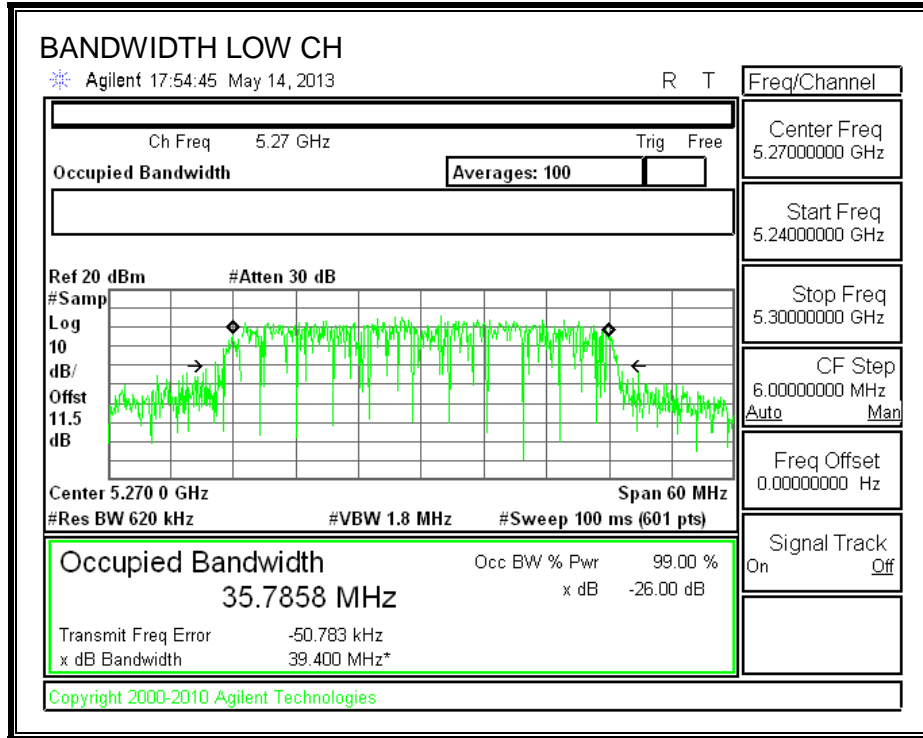

### 8.6.3. AVERAGE POWER

#### LIMITS

None; for reporting purposes only.

#### TEST PROCEDURE

The transmitter output is connected to a power meter.

The cable assembly insertion loss of 11.5 dB (including 10 dB pad and 1.5 dB cable) was entered as an offset in the power meter to allow for direct reading of power.

#### RESULTS

Channel	Frequency (MHz)	Power (dBm)
Low	5270	15.99
High	5310	15.94

## **8.6.4. OUTPUT POWER AND PPSD**

### **LIMITS**

FCC §15.407 (a) (1)

For the band 5.25–5.35 GHz, the maximum conducted output power over the frequency band of operation shall not exceed the lesser of 250 mW or  $11 \text{ dBm} + 10 \log B$ , where B is the 26–dB emission bandwidth in MHz. In addition, the peak power spectral density shall not exceed 11 dBm in any 1–MHz band. If transmitting antennas of directional gain greater than 6 dBi are used, both the maximum conducted output power and the peak power spectral density shall be reduced by the amount in dB that the directional gain of the antenna exceeds 6 dBi.

IC RSS-210 A9.2 (1)

The maximum e.i.r.p. shall not exceed 200 mW or  $10 + 10 \log_{10} B$ , dBm, whichever power is less. B is the 99% emission bandwidth in MHz. The e.i.r.p. spectral density shall not exceed 10 dBm in any 1.0 MHz band.

### **DIRECTIONAL ANTENNA GAIN**

There is only one transmitter output therefore the directional gain is equal to the antenna gain.

**RESULTS**

**Bandwidth and Antenna Gain**

Channel	Frequency (MHz)	Min 26 dB BW (MHz)	Min 99% BW (MHz)	Directional Gain (dBi)
Low	5270	44.13	35.7858	-6.00
High	5310	44.00	35.7715	-6.00

**Limits**

Channel	Frequency (MHz)	FCC Power Limit (dBm)	IC Power Limit (dBm)	IC EIRP Limit (dBm)	Power Limit (dBm)	FCC PPSD Limit (dBm)	IC PSD Limit (dBm)	PPSD Limit (dBm)
Low	5270	24.00	24.00	30.00	24.00	11.00	11.00	11.00
High	5310	24.00	24.00	30.00	24.00	11.00	11.00	11.00

<b>Duty Cycle CF (dB)</b>	0.16	<b>Included in Calculations of Corr'd Power &amp; PPSD</b>
---------------------------	------	--

**Output Power Results**

Channel	Frequency (MHz)	Meas Power (dBm)	Total Corr'd Power (dBm)	Power Limit (dBm)	Power Margin (dB)
Low	5270	16.120	16.28	24.00	-7.72
High	5310	15.900	16.06	24.00	-7.94

**PPSD Results**

Channel	Frequency (MHz)	Meas PPSD (dBm)	Total Corr'd PPSD (dBm)	PPSD Limit (dBm)	PPSD Margin (dB)
Low	5270	2.372	2.53	11.00	-8.47
High	5310	2.050	2.21	11.00	-8.79



**OUTPUT POWER AND PPSD,**

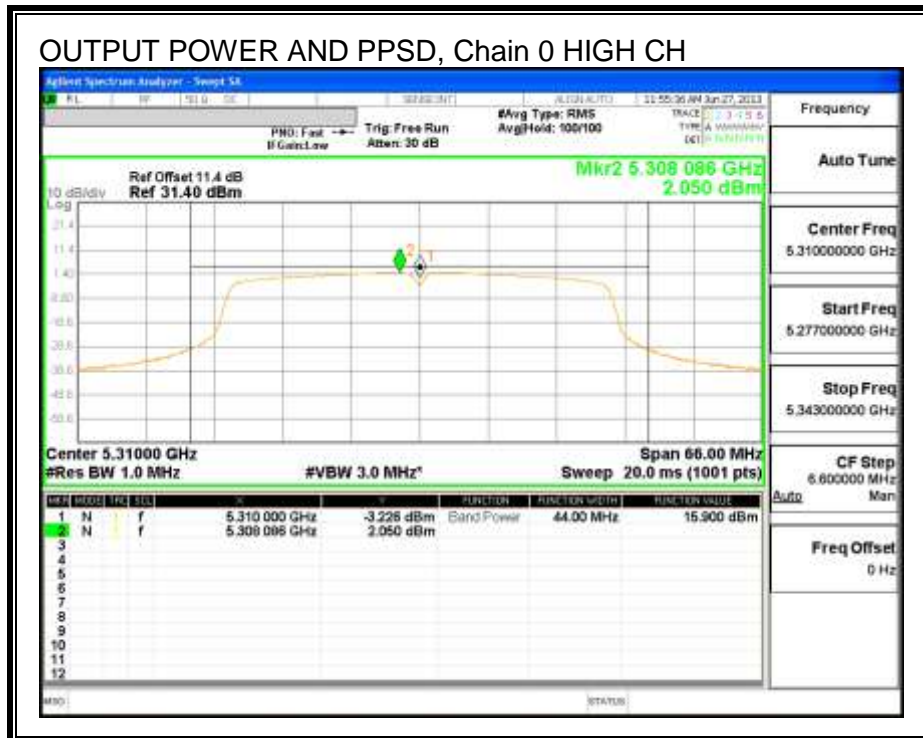
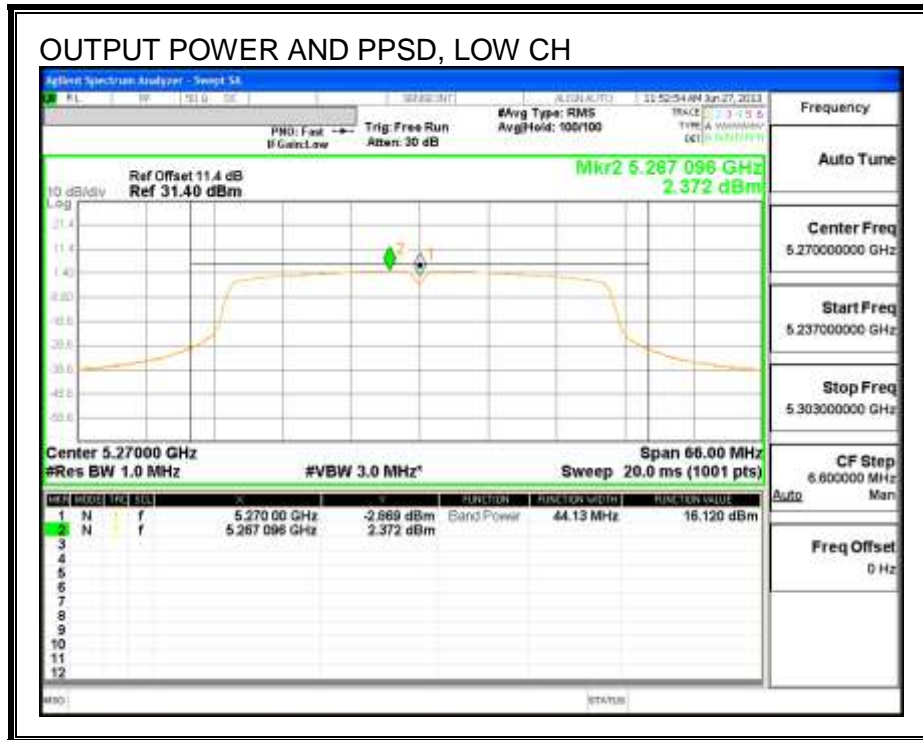

### 8.6.5. PEAK EXCURSION

#### LIMITS

FCC §15.407 (a) (6)

The ratio of the peak excursion of the modulation envelope (measured using a peak hold function) to the peak transmit power (measured as specified above) shall not exceed 13 dB across any 1 MHz bandwidth or the emission bandwidth whichever is less.

#### RESULTS

Refer to the results of 802.11n HT20 mode in the 5.2 GHz band.

Channel	Frequency (MHz)	PK Level (dBm)	PSD (dBm)	DCCF (dB)	Peak Excursion (dB)	Limit (dB)	Margin (dB)
Mid	5270	10.56	2.050	0.16	8.35	13	-4.65

#### PEAK EXCURSION

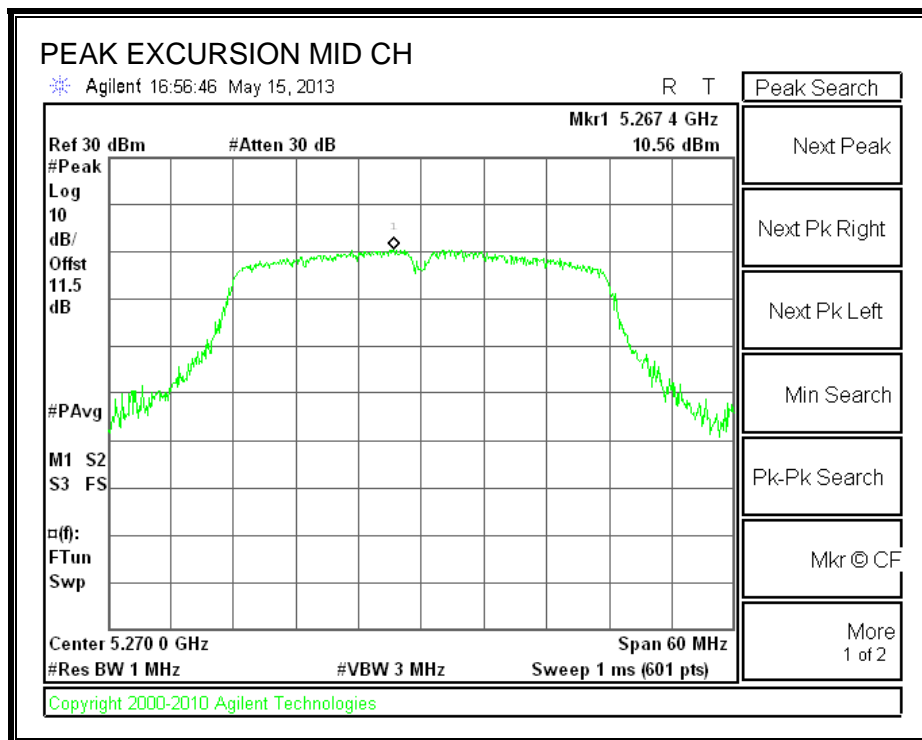

## 8.7. 802.11a MODE IN THE 5.6 GHz BAND

### 8.7.1. 26 dB BANDWIDTH

#### LIMITS

None; for reporting purposes only.

#### RESULTS

Channel	Frequency (MHz)	26 dB Bandwidth (MHz)
Low	5500	19.60
Mid	5580	19.67
High	5700	19.80

#### 26 dB BANDWIDTH

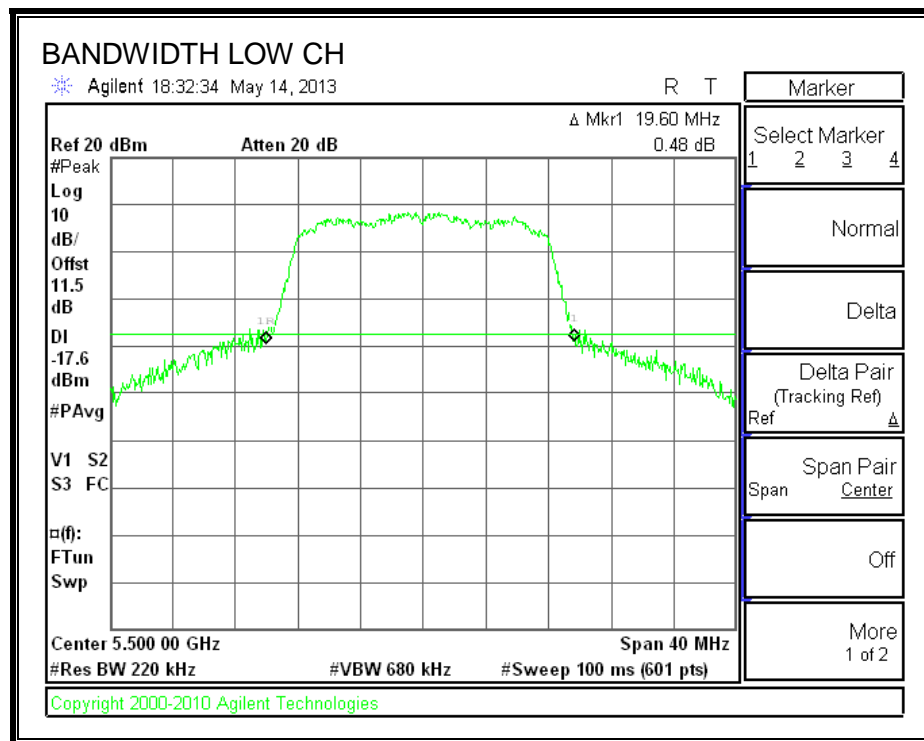

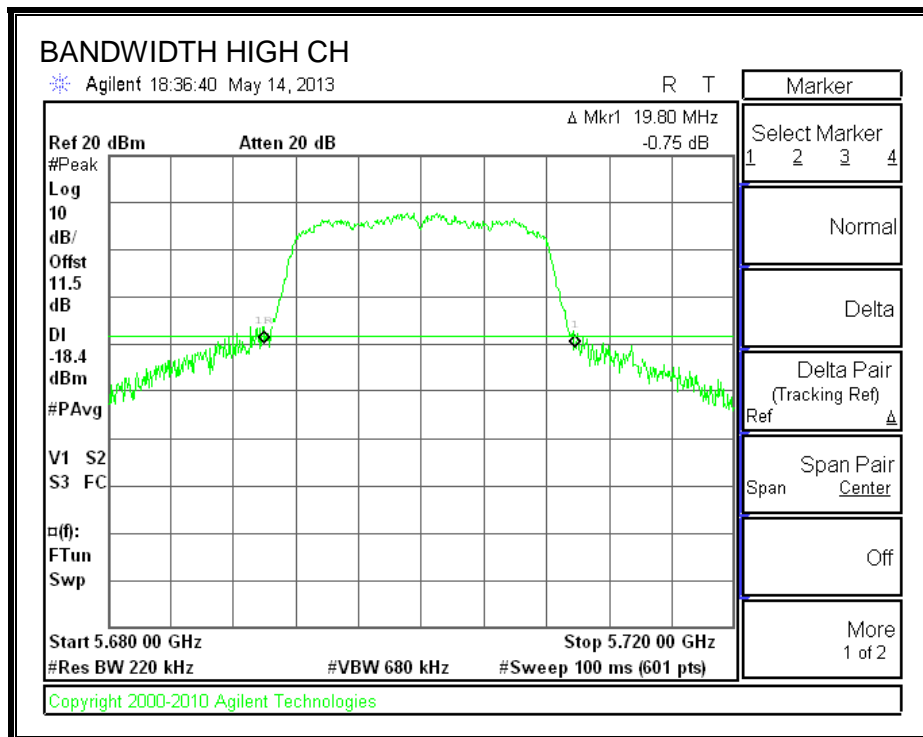
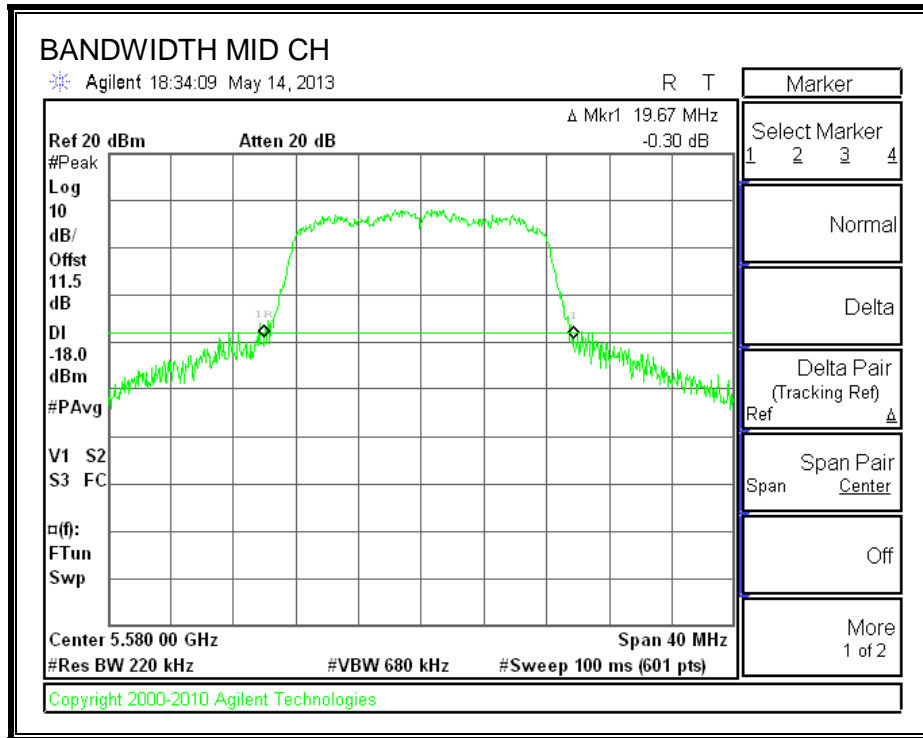

### 8.7.2. 99% BANDWIDTH

#### LIMITS

None; for reporting purposes only.

#### RESULTS

Channel	Frequency (MHz)	99% Bandwidth (MHz)
Low	5500	16.3272
Mid	5580	16.3301
High	5700	16.3314

#### 99% BANDWIDTH

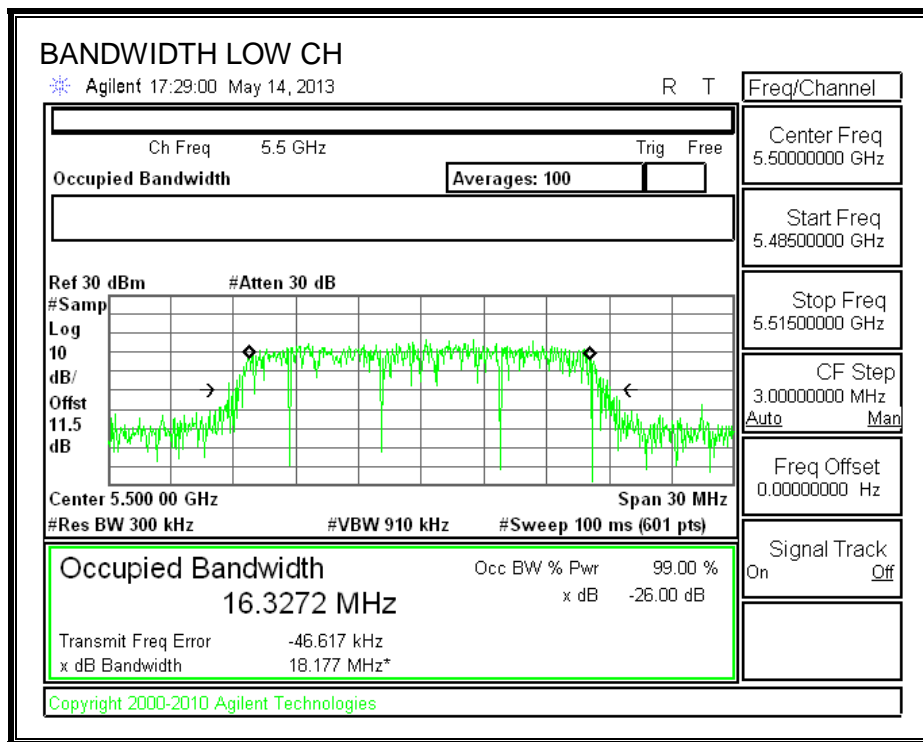

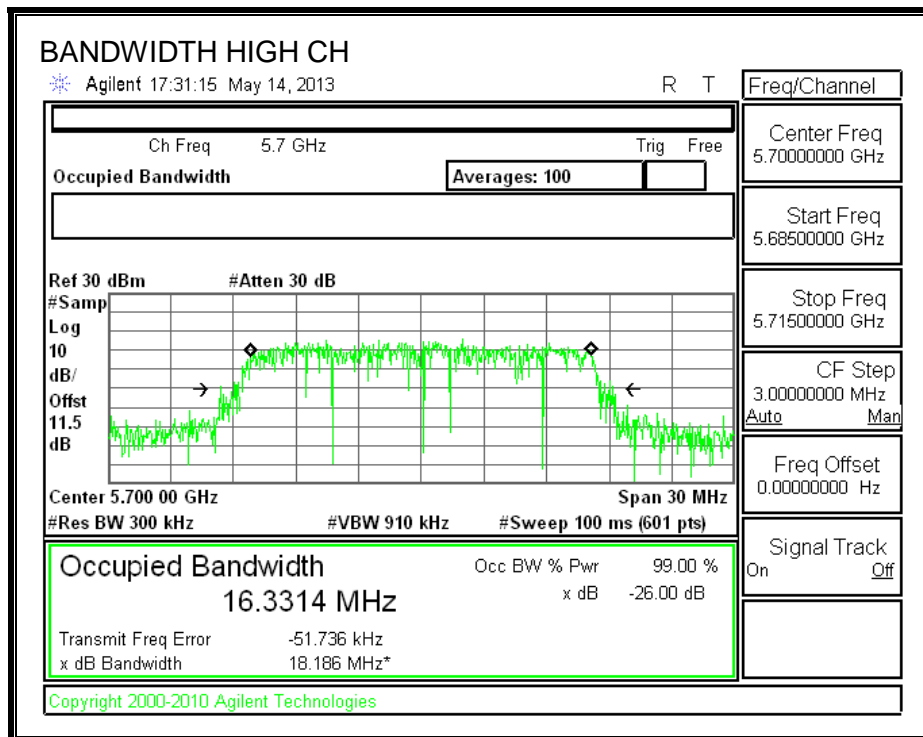
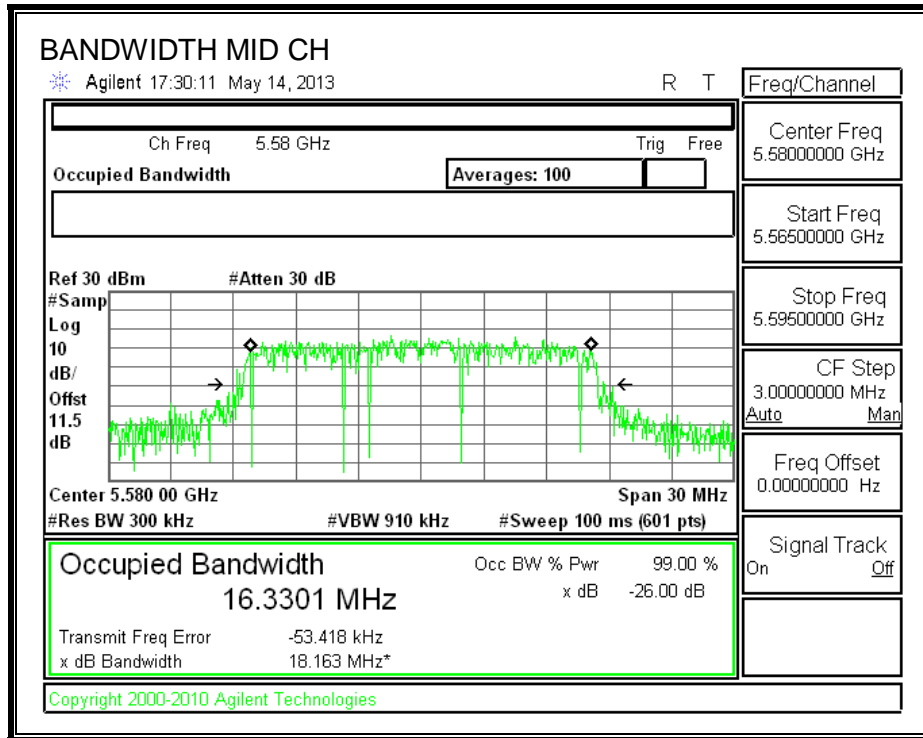

### 8.7.3. AVERAGE POWER

#### LIMITS

None; for reporting purposes only.

#### TEST PROCEDURE

The transmitter output is connected to a power meter.

The cable assembly insertion loss of 11.5 dB (including 10 dB pad and 1.5 dB cable) was entered as an offset in the power meter to allow for direct reading of power.

#### RESULTS

Channel	Frequency (MHz)	Power (dBm)
Low	5500	14.00
Mid	5580	13.95
High	5700	13.92

## **8.7.4. OUTPUT POWER AND PPSD**

### **LIMITS**

FCC §15.407 (a) (1)

For the band 5.5–5.7 GHz, the maximum conducted output power over the frequency band of operation shall not exceed the lesser of 250 mW or  $11 \text{ dBm} + 10 \log B$ , where B is the 26-dB emission bandwidth in MHz. In addition, the peak power spectral density shall not exceed 11 dBm in any 1-MHz band. If transmitting antennas of directional gain greater than 6 dBi are used, both the maximum conducted output power and the peak power spectral density shall be reduced by the amount in dB that the directional gain of the antenna exceeds 6 dBi.

IC RSS-210 A9.2 (1)

The maximum e.i.r.p. shall not exceed 200 mW or  $10 + 10 \log_{10} B$ , dBm, whichever power is less. B is the 99% emission bandwidth in MHz. The e.i.r.p. spectral density shall not exceed 10 dBm in any 1.0 MHz band.

### **DIRECTIONAL ANTENNA GAIN**

There is only one transmitter output therefore the directional gain is equal to the antenna gain.



**RESULTS**

**Bandwidth and Antenna Gain**

Channel	Frequency (MHz)	Min 26 dB BW (MHz)	Min 99% BW (MHz)	Directional Gain (dBi)
Low	5500	19.60	16.3272	-5.50
Mid	5580	19.67	16.3301	-5.50
High	5700	19.80	16.3314	-5.50

**Limits**

Channel	Frequency (MHz)	FCC Power Limit (dBm)	IC Power Limit (dBm)	IC EIRP Limit (dBm)	Power Limit (dBm)	FCC PPSD Limit (dBm)	IC PSD Limit (dBm)	PPSD Limit (dBm)
Low	5500	23.92	23.13	29.13	23.13	11.00	11.00	11.00
Mid	5580	23.94	23.13	29.13	23.13	11.00	11.00	11.00
High	5700	23.97	23.13	29.13	23.13	11.00	11.00	11.00

<b>Duty Cycle CF (dB)</b>	0.07	<b>Included in Calculations of Corr'd Power &amp; PPSD</b>
---------------------------	------	--

**Output Power Results**

Channel	Frequency (MHz)	Meas Power (dBm)	Total Corr'd Power (dBm)	Power Limit (dBm)	Power Margin (dB)
Low	5500	14.106	14.18	23.13	-8.95
Mid	5580	13.989	14.06	23.13	-9.07
High	5700	13.948	14.02	23.13	-9.11

**PPSD Results**

Channel	Frequency (MHz)	Meas PPSD (dBm)	Total Corr'd PPSD (dBm)	PPSD Limit (dBm)	PPSD Margin (dB)
Low	5500	3.752	3.82	11.00	-7.18
Mid	5580	3.669	3.74	11.00	-7.26
High	5700	3.626	3.70	11.00	-7.30

**OUTPUT POWER AND PPSD**

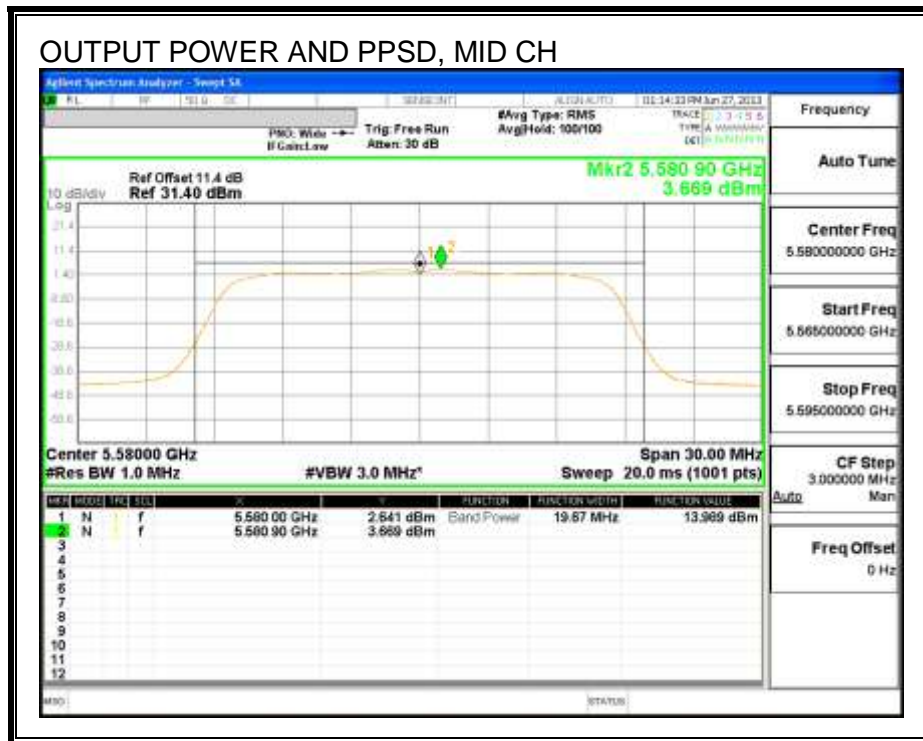
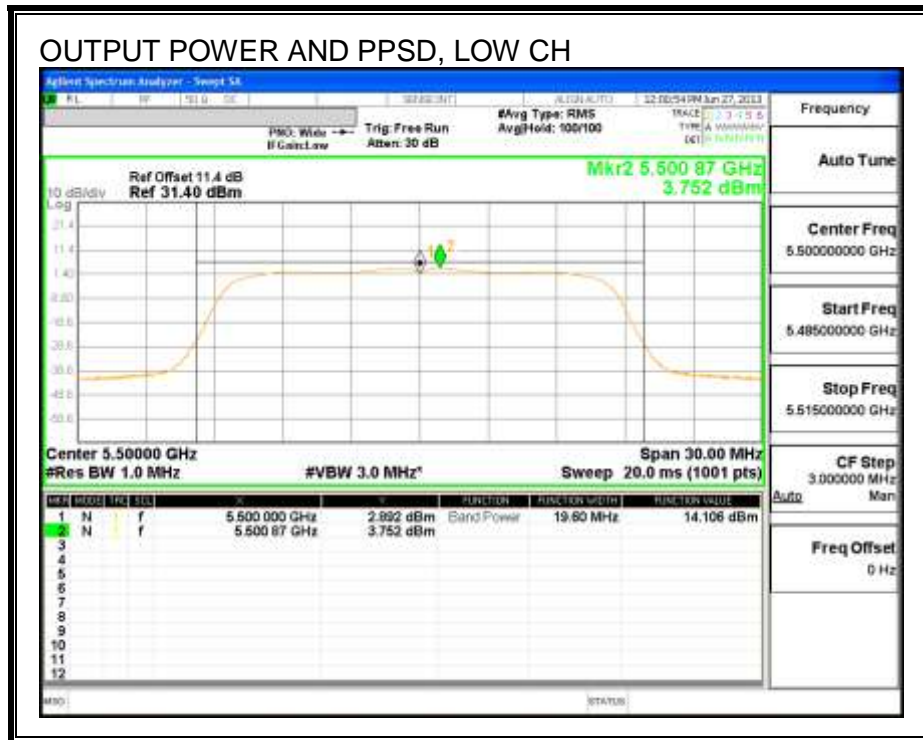

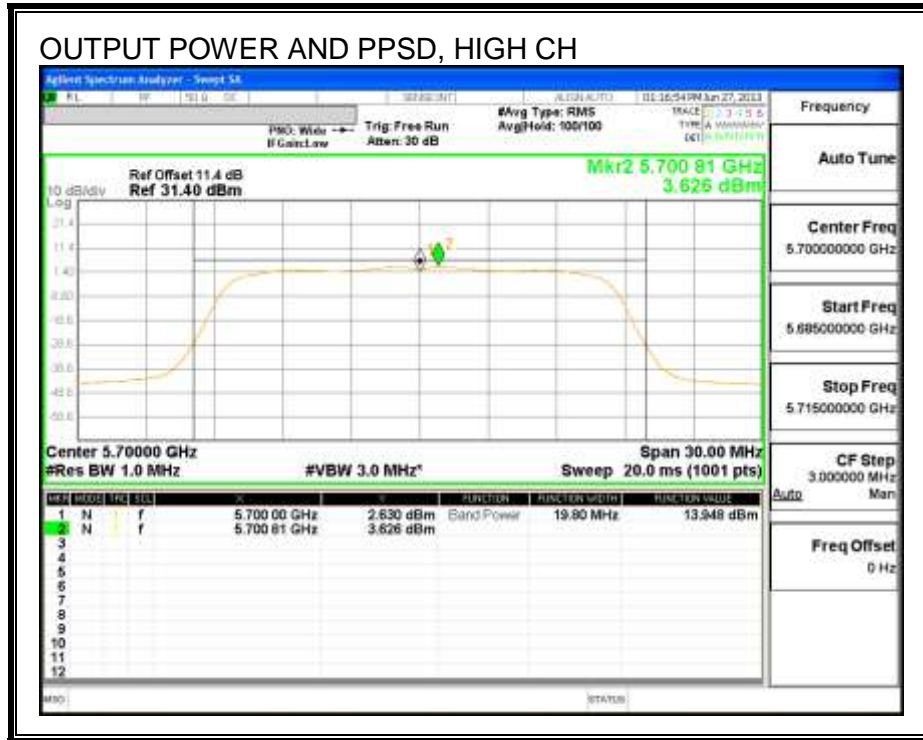

### 8.7.5. PEAK EXCURSION

#### LIMITS

FCC §15.407 (a) (6)

The ratio of the peak excursion of the modulation envelope (measured using a peak hold function) to the peak transmit power (measured as specified above) shall not exceed 13 dB across any 1 MHz bandwidth or the emission bandwidth whichever is less.

#### RESULTS

Refer to the results of 802.11n HT20 mode in the 5.2 GHz band.

Channel	Frequency (MHz)	PK Level (dBm)	PSD (dBm)	DCCF (dB)	Peak Excursion (dB)	Limit (dB)	Margin (dB)
Mid	5580	14.28	3.626	0.07	10.58	13	-2.42

#### PEAK EXCURSION

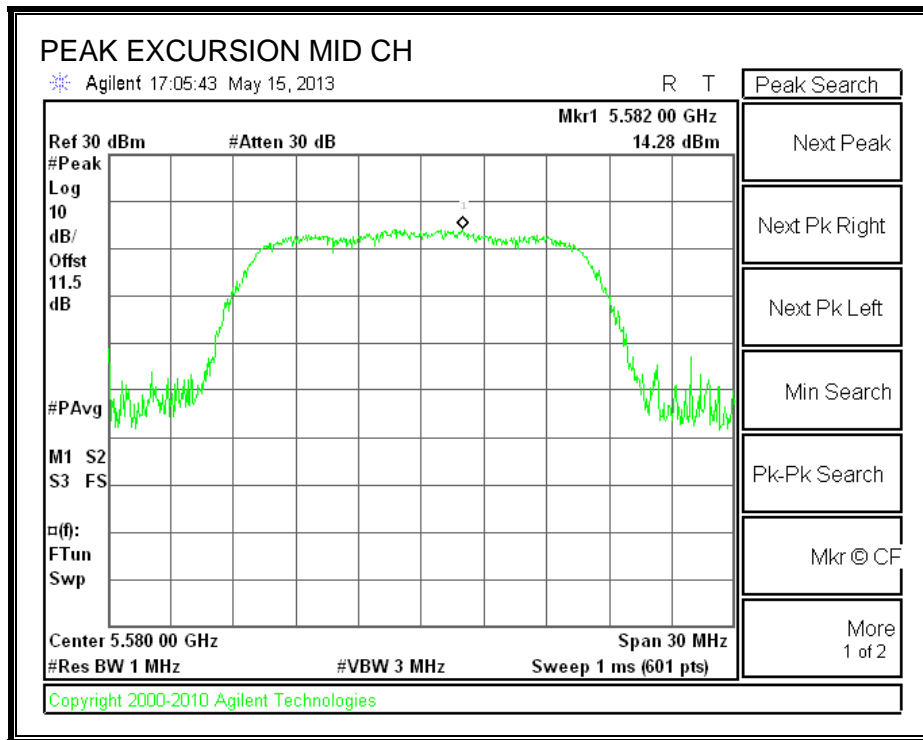

## 8.8. 802.11n HT20 MODE IN THE 5.6 GHz BAND

### 8.8.1. 26 dB BANDWIDTH

#### LIMITS

None; for reporting purposes only.

#### RESULTS

Channel	Frequency (MHz)	26 dB Bandwidth (MHz)
Low	5500	19.33
Mid	5580	19.47
High	5700	19.33

#### 26 dB BANDWIDTH

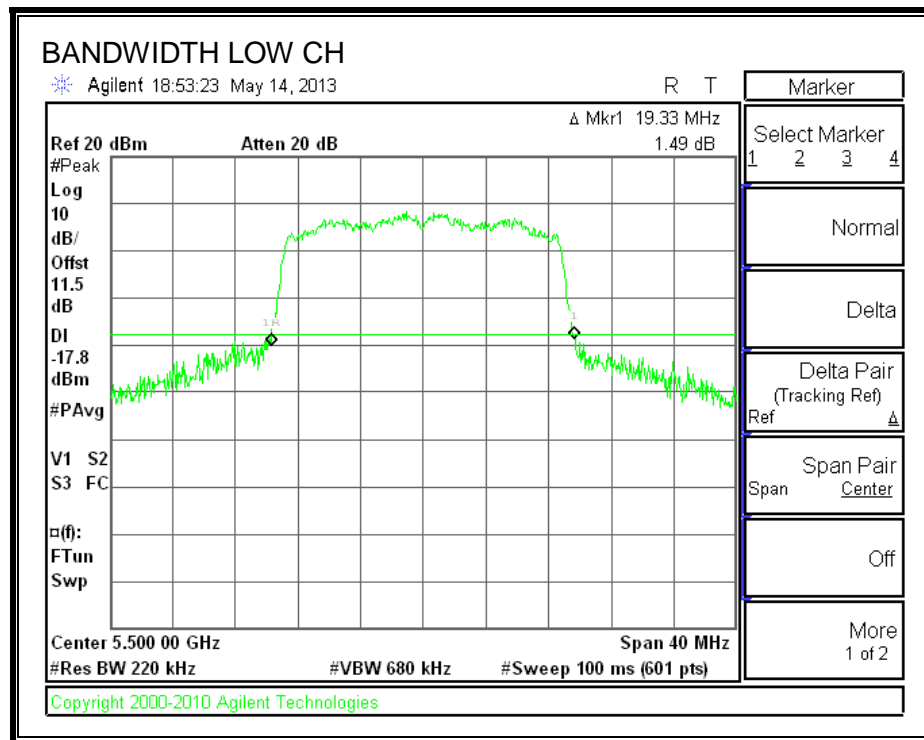

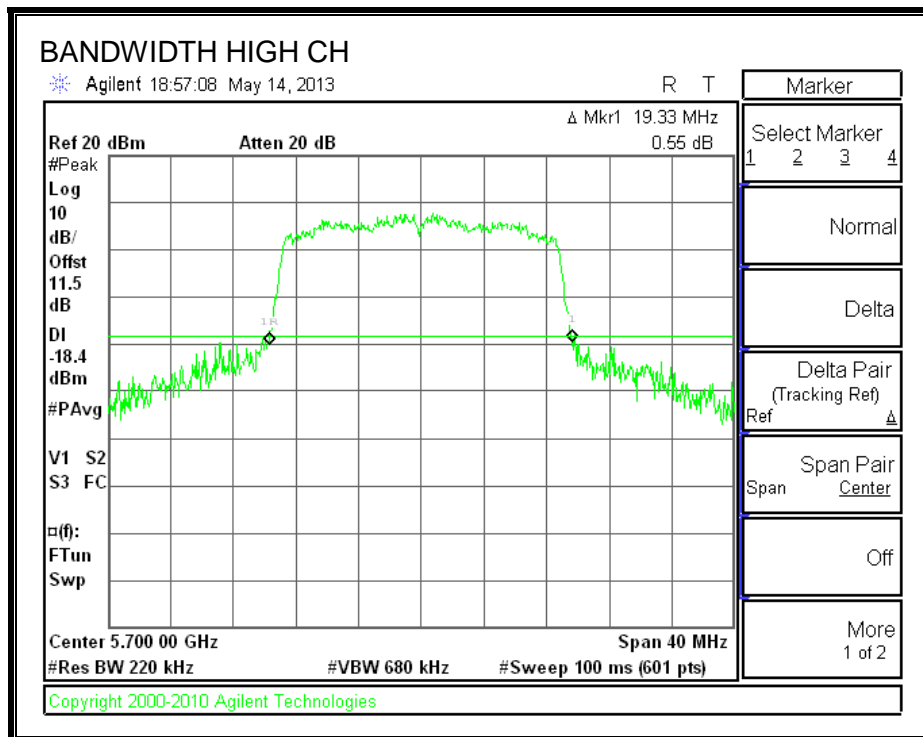
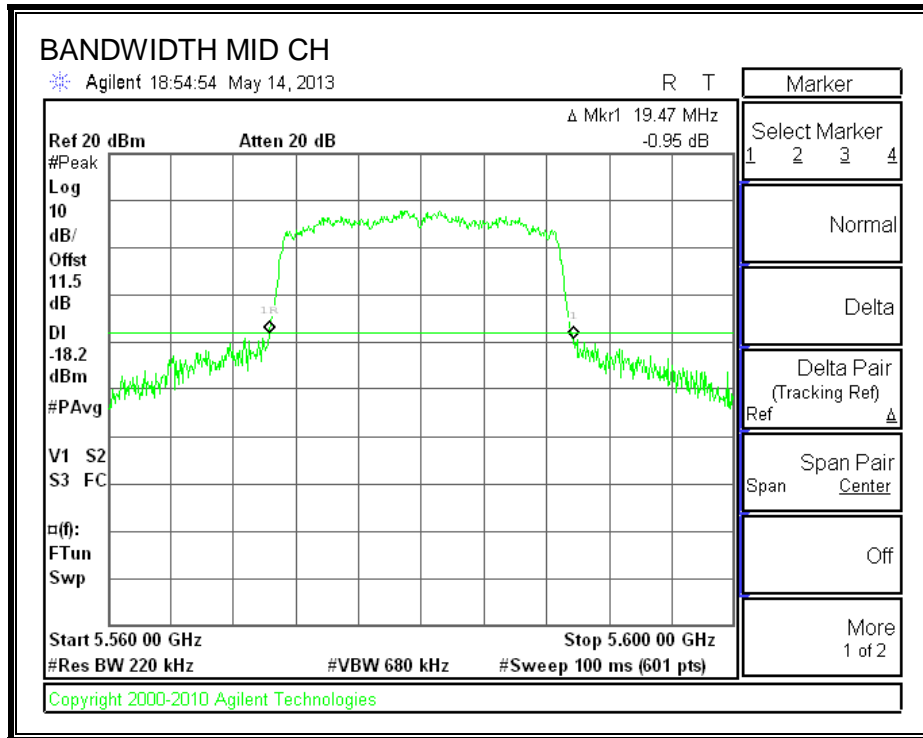

### 8.8.2. 99% BANDWIDTH

#### LIMITS

None; for reporting purposes only.

#### RESULTS

Channel	Frequency (MHz)	99% Bandwidth (MHz)
Low	5500	17.5224
Mid	5580	17.5123
High	5700	17.5155

#### 99% BANDWIDTH

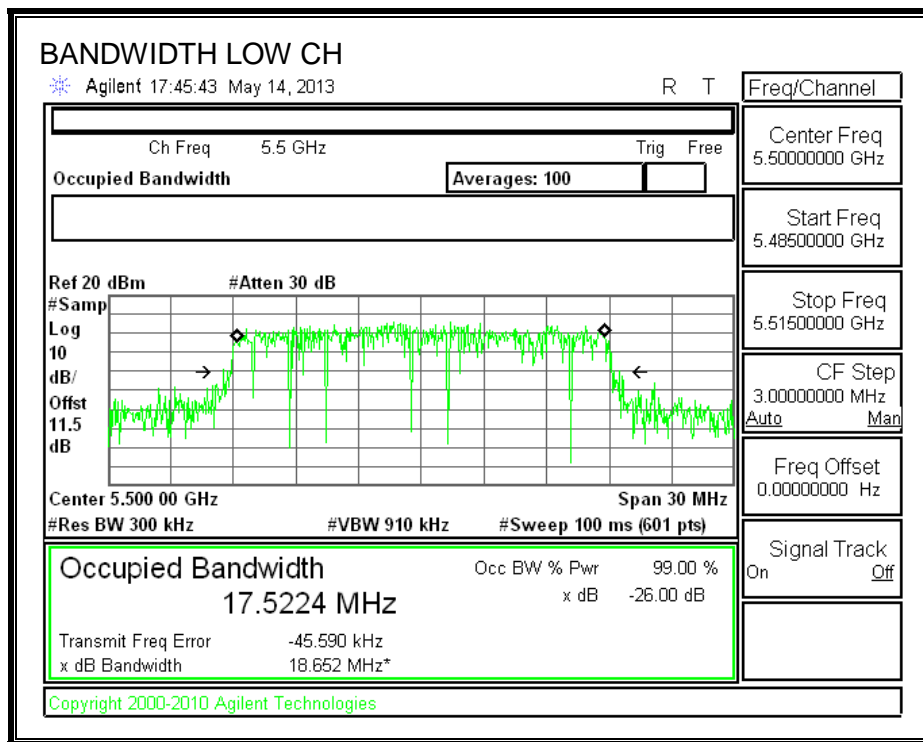

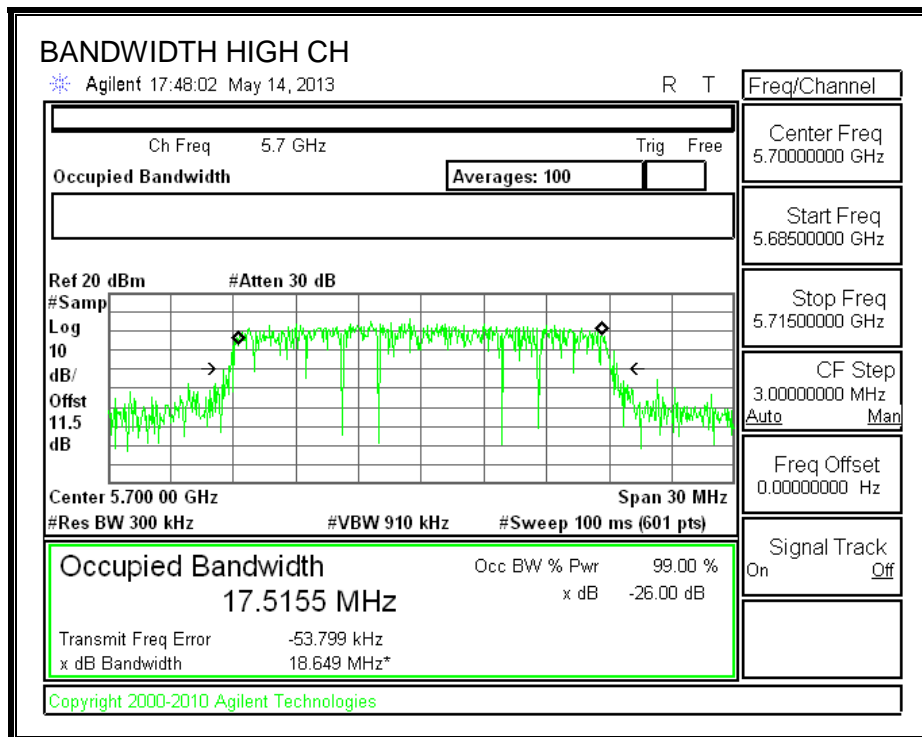
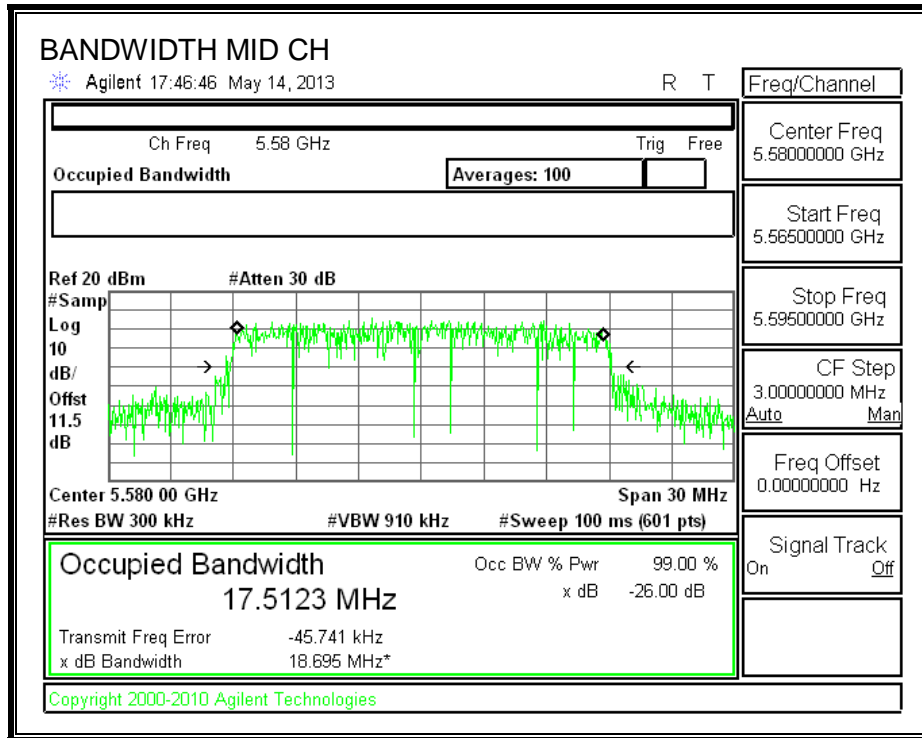



### 8.8.3. AVERAGE POWER

#### LIMITS

None; for reporting purposes only.

#### TEST PROCEDURE

The transmitter output is connected to a power meter.

The cable assembly insertion loss of 11.5 dB (including 10 dB pad and 1.5 dB cable) was entered as an offset in the power meter to allow for direct reading of power.

#### RESULTS

Channel	Frequency (MHz)	Power (dBm)
Low	5500	13.95
Mid	5580	14.00
High	5700	14.00

## **8.8.4. OUTPUT POWER AND PPSD**

### **LIMITS**

FCC §15.407 (a) (1)

For the band 5.5–5.7 GHz, the maximum conducted output power over the frequency band of operation shall not exceed the lesser of 250 mW or  $11 \text{ dBm} + 10 \log B$ , where B is the 26–dB emission bandwidth in MHz. In addition, the peak power spectral density shall not exceed 11 dBm in any 1–MHz band. If transmitting antennas of directional gain greater than 6 dBi are used, both the maximum conducted output power and the peak power spectral density shall be reduced by the amount in dB that the directional gain of the antenna exceeds 6 dBi.

IC RSS-210 A9.2 (1)

The maximum e.i.r.p. shall not exceed 200 mW or  $10 + 10 \log_{10} B$ , dBm, whichever power is less. B is the 99% emission bandwidth in MHz. The e.i.r.p. spectral density shall not exceed 10 dBm in any 1.0 MHz band.

### **DIRECTIONAL ANTENNA GAIN**

There is only one transmitter output therefore the directional gain is equal to the antenna gain.

**RESULTS**

**Bandwidth and Antenna Gain**

Channel	Frequency (MHz)	Min 26 dB BW (MHz)	Min 99% BW (MHz)	Directional Gain (dBi)
Low	5500	19.33	17.5224	-5.50
Mid	5580	19.47	17.5123	-5.50
High	5700	19.33	17.5155	-5.50

**Limits**

Channel	Frequency (MHz)	FCC Power Limit (dBm)	IC Power Limit (dBm)	IC EIRP Limit (dBm)	Power Limit (dBm)	FCC PPSD Limit (dBm)	IC PSD Limit (dBm)	PPSD Limit (dBm)
Low	5500	23.86	23.44	29.44	23.44	11.00	11.00	11.00
Mid	5580	23.89	23.43	29.43	23.43	11.00	11.00	11.00
High	5700	23.86	23.43	29.43	23.43	11.00	11.00	11.00

<b>Duty Cycle CF (dB)</b>	0.09	<b>Included in Calculations of Corr'd Power &amp; PPSD</b>
---------------------------	------	--

**Output Power Results**

Channel	Frequency (MHz)	Meas Power (dBm)	Total Corr'd Power (dBm)	Power Limit (dBm)	Power Margin (dB)
Low	5500	13.978	14.07	23.44	-9.37
Mid	5580	14.138	14.23	23.43	-9.21
High	5700	14.116	14.21	23.43	-9.23

**PPSD Results**

Channel	Frequency (MHz)	Meas PPSD (dBm)	Total Corr'd PPSD (dBm)	PPSD Limit (dBm)	PPSD Margin (dB)
Low	5500	3.457	3.55	11.00	-7.45
Mid	5580	3.604	3.69	11.00	-7.31
High	5700	3.593	3.68	11.00	-7.32

**OUTPUT POWER AND PPSD**

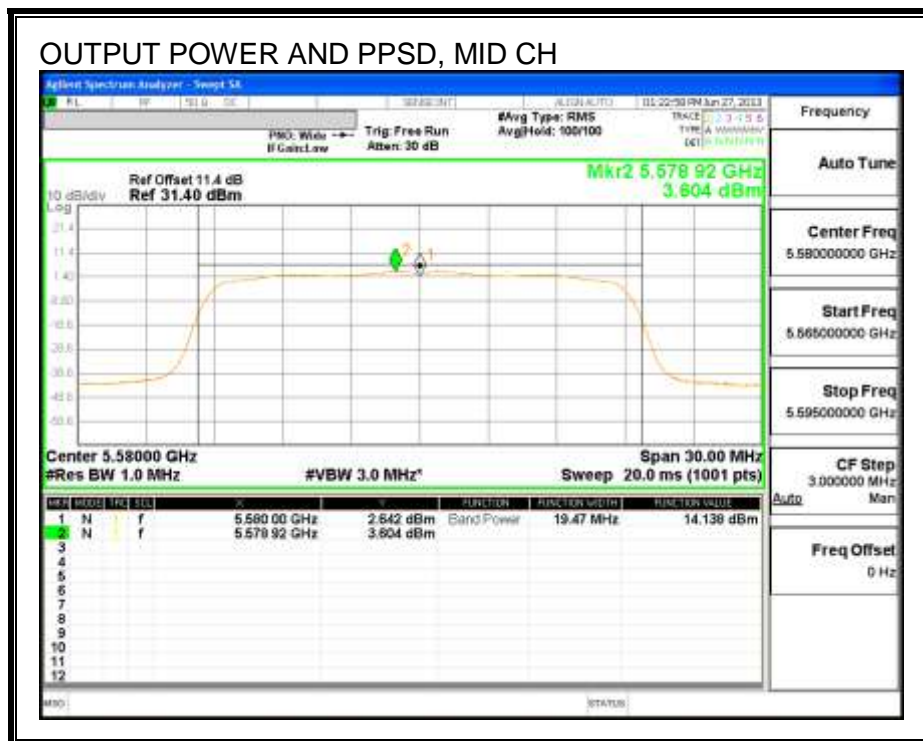
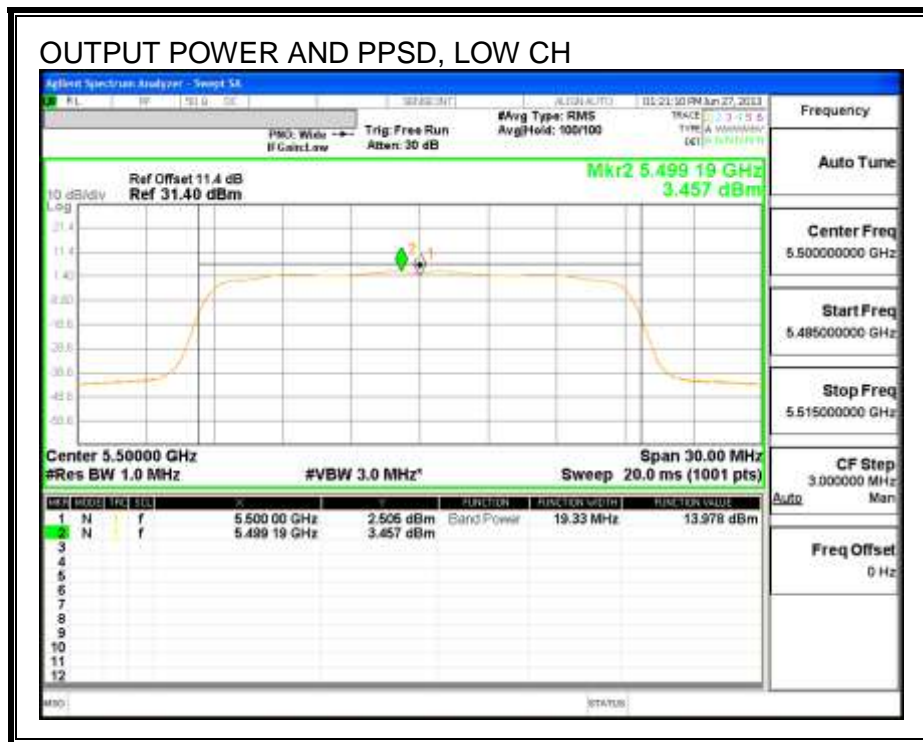

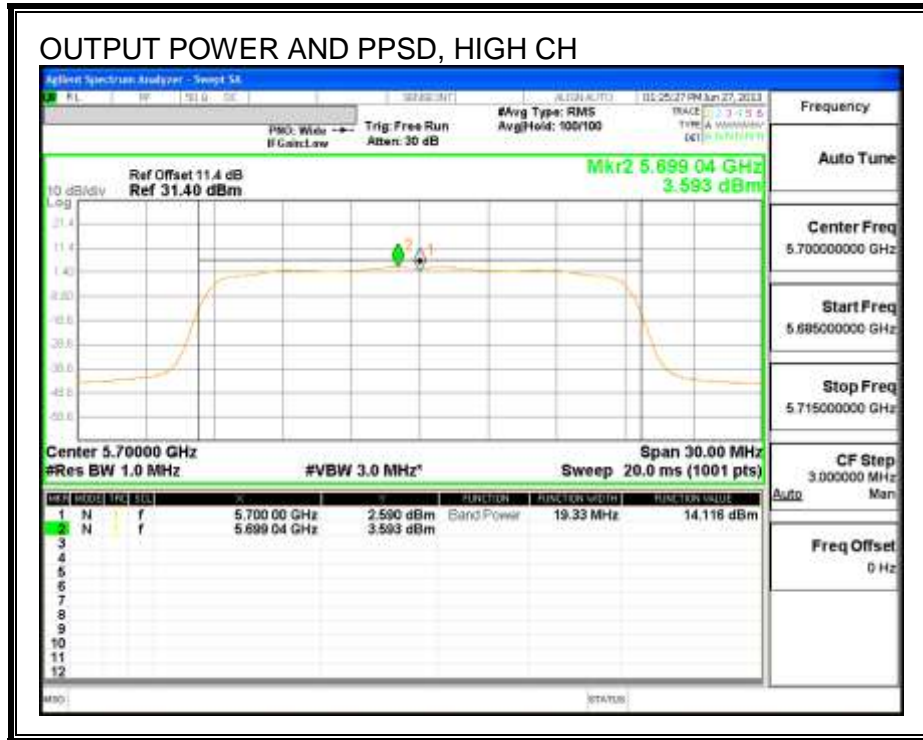

### 8.8.5. PEAK EXCURSION

#### LIMITS

FCC §15.407 (a) (6)

The ratio of the peak excursion of the modulation envelope (measured using a peak hold function) to the peak transmit power (measured as specified above) shall not exceed 13 dB across any 1 MHz bandwidth or the emission bandwidth whichever is less.

#### RESULTS

Refer to the results of 802.11n HT20 mode in the 5.2 GHz band.

Channel	Frequency (MHz)	PK Level (dBm)	PSD (dBm)	DCCF (dB)	Peak Excursion (dB)	Limit (dB)	Margin (dB)
Mid	5580	13.79	3.457	0.09	10.24	13	-2.76

#### PEAK EXCURSION

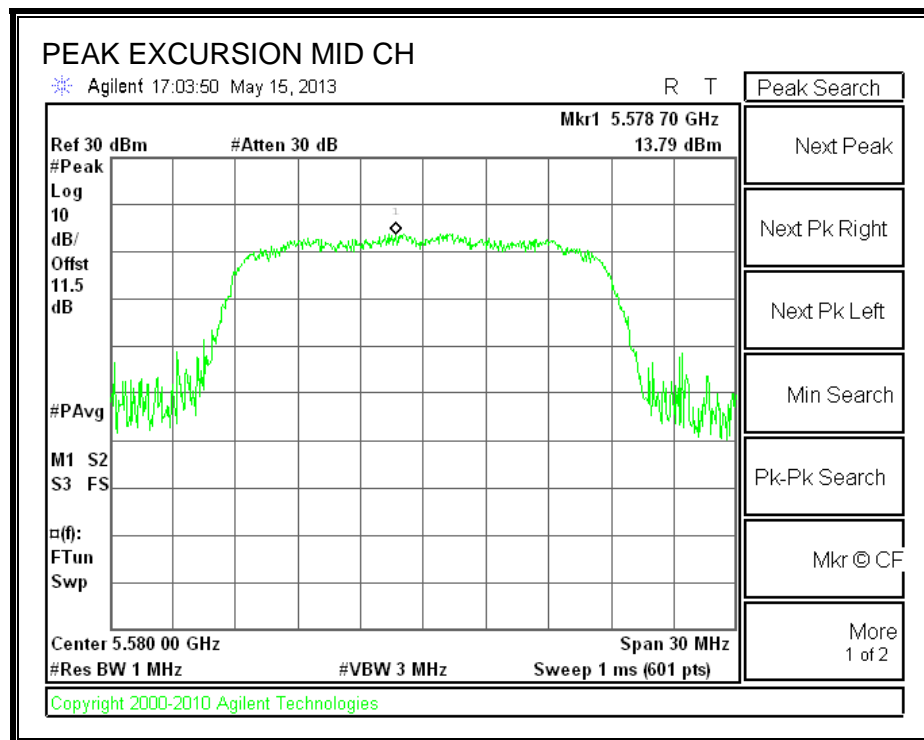

## 8.9. 802.11n HT40 MODE IN THE 5.6 GHz BAND

### 8.9.1. 26 dB BANDWIDTH

#### LIMITS

None; for reporting purposes only.

#### RESULTS

Channel	Frequency (MHz)	26 dB Bandwidth (MHz)
Low	5510	44.00
Mid	5550	44.67
High	5670	44.80

#### 26 dB BANDWIDTH

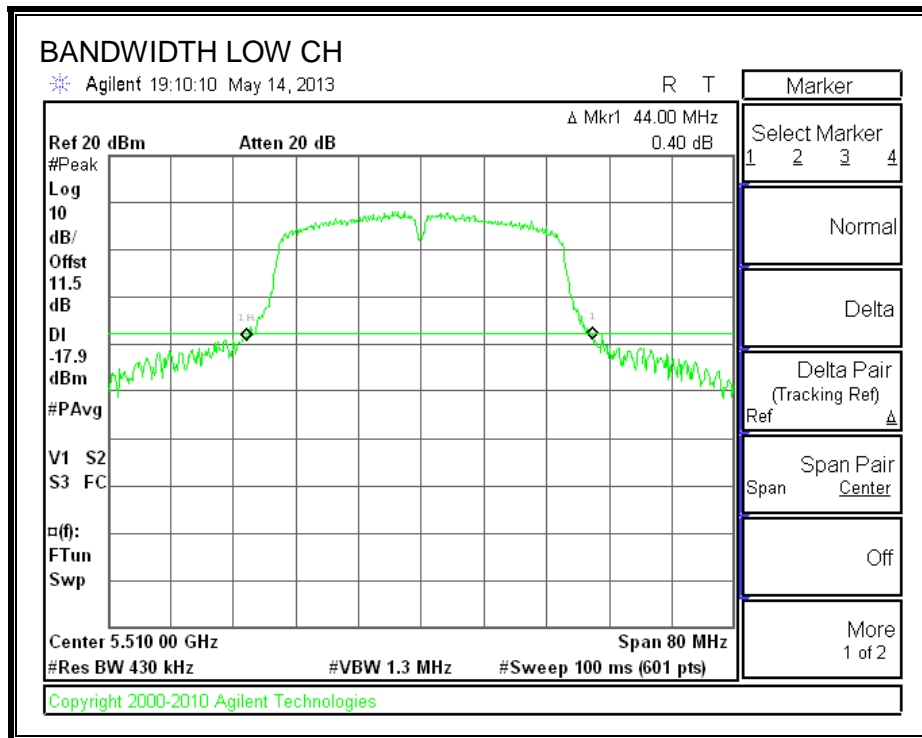

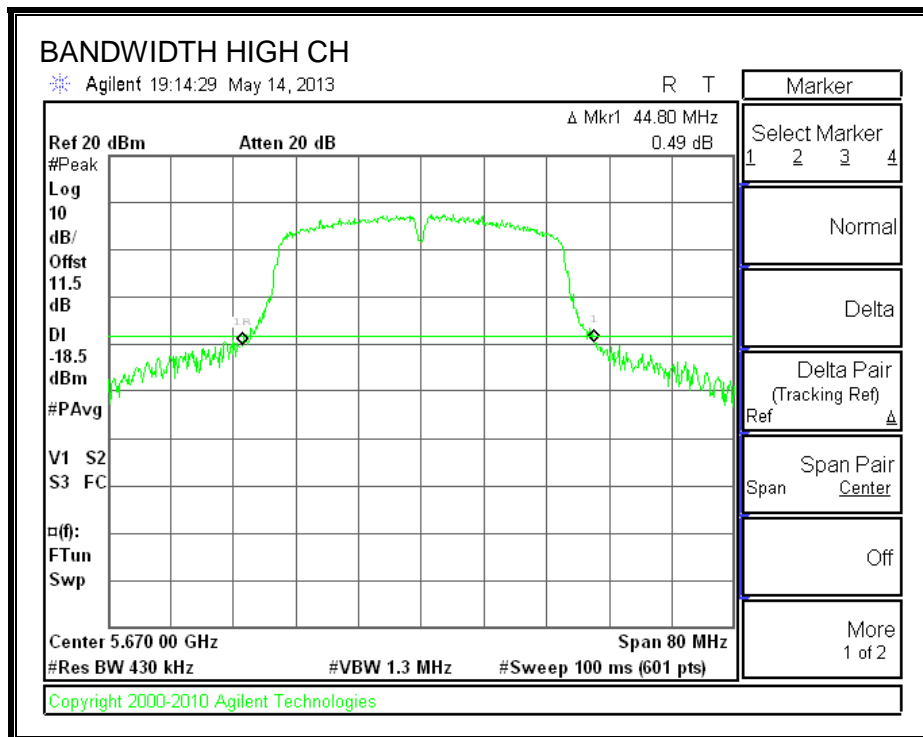
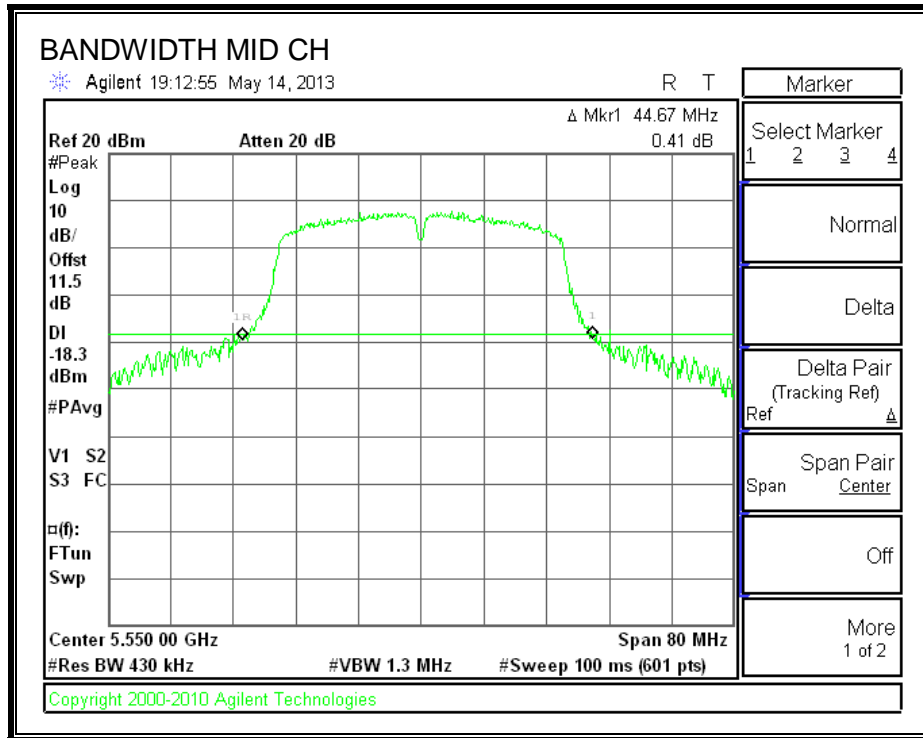



### 8.9.2. 99% BANDWIDTH

#### LIMITS

None; for reporting purposes only.

#### RESULTS

Channel	Frequency (MHz)	99% Bandwidth (MHz)
Low	5510	35.7980
Mid	5550	35.7564
High	5670	35.7595

#### 99% BANDWIDTH

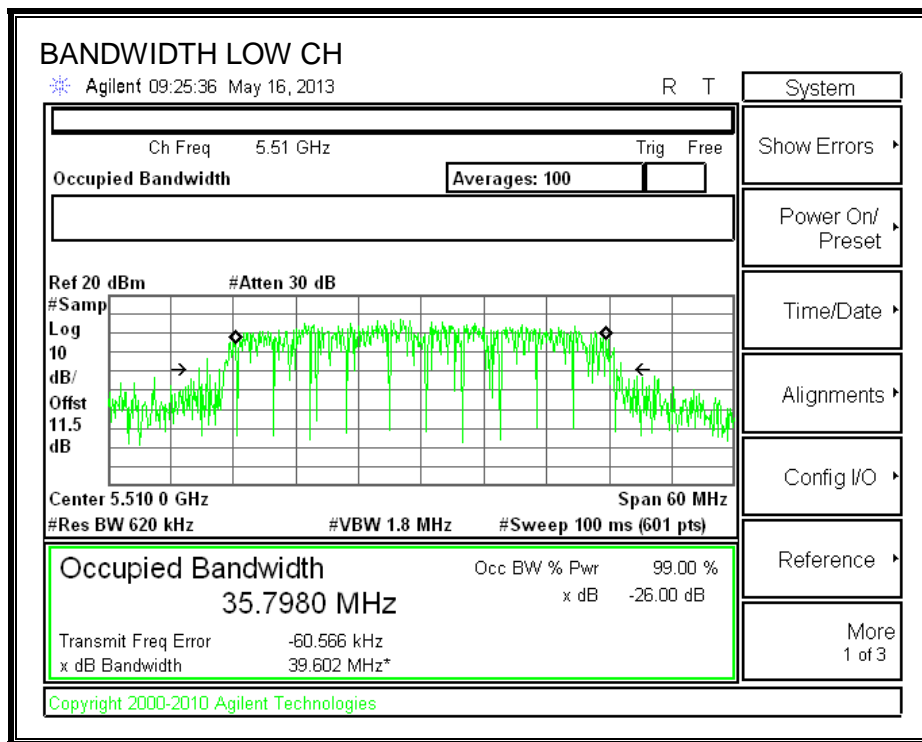

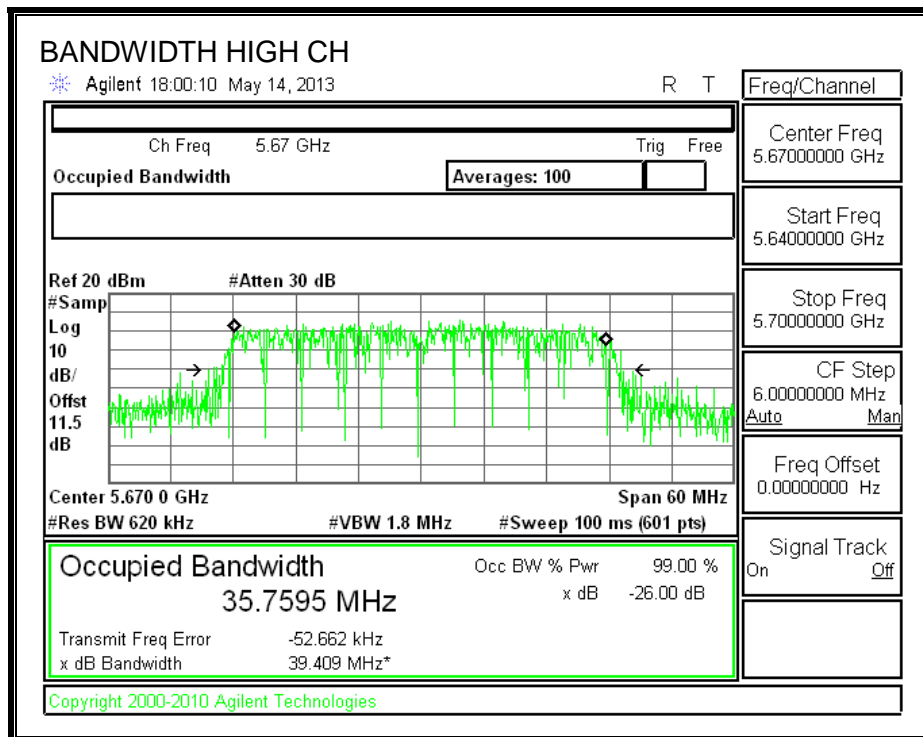
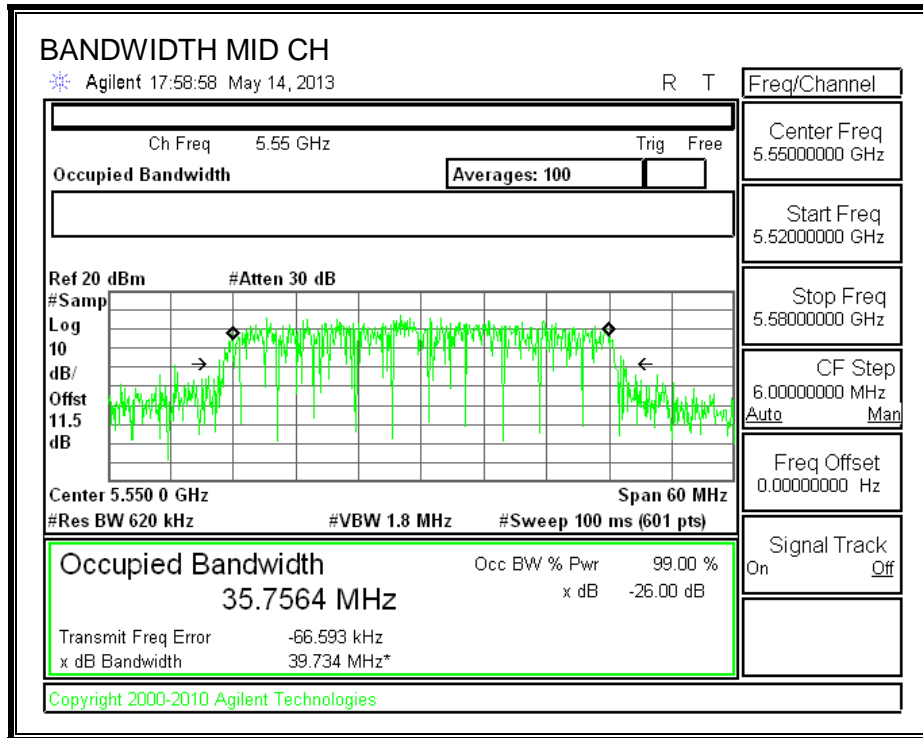

### 8.9.3. AVERAGE POWER

#### LIMITS

None; for reporting purposes only.

#### TEST PROCEDURE

The transmitter output is connected to a power meter.

The cable assembly insertion loss of 11.5 dB (including 10 dB pad and 11.5 dB cable) was entered as an offset in the power meter to allow for direct reading of power.

#### RESULTS

Channel	Frequency (MHz)	Power (dBm)
Low	5510	14.02
Mid	5550	13.95
High	5670	14.08

## **8.9.4. OUTPUT POWER AND PPSD**

### **LIMITS**

FCC §15.407 (a) (1)

For the band 5.5–5.7 GHz, the maximum conducted output power over the frequency band of operation shall not exceed the lesser of 250 mW or  $11 \text{ dBm} + 10 \log B$ , where B is the 26–dB emission bandwidth in MHz. In addition, the peak power spectral density shall not exceed 11 dBm in any 1–MHz band. If transmitting antennas of directional gain greater than 6 dBi are used, both the maximum conducted output power and the peak power spectral density shall be reduced by the amount in dB that the directional gain of the antenna exceeds 6 dBi.

IC RSS-210 A9.2 (1)

The maximum e.i.r.p. shall not exceed 200 mW or  $10 + 10 \log_{10} B$ , dBm, whichever power is less. B is the 99% emission bandwidth in MHz. The e.i.r.p. spectral density shall not exceed 10 dBm in any 1.0 MHz band.

### **DIRECTIONAL ANTENNA GAIN**

There is only one transmitter output therefore the directional gain is equal to the antenna gain.

**RESULTS**

**Bandwidth and Antenna Gain**

Channel	Frequency (MHz)	Min 26 dB BW (MHz)	Min 99% BW (MHz)	Directional Gain (dBi)
Low	5510	44.00	35.7980	-5.50
Mid	5550	44.67	35.7564	-5.50
High	5670	44.80	35.7595	-5.50

**Limits**

Channel	Frequency (MHz)	FCC Power Limit (dBm)	IC Power Limit (dBm)	IC EIRP Limit (dBm)	Power Limit (dBm)	FCC PPSD Limit (dBm)	IC PSD Limit (dBm)	PPSD Limit (dBm)
Low	5510	24.00	24.00	30.00	24.00	11.00	11.00	11.00
Mid	5550	24.00	24.00	30.00	24.00	11.00	11.00	11.00
High	5670	24.00	24.00	30.00	24.00	11.00	11.00	11.00

<b>Duty Cycle CF (dB)</b>	0.16	<b>Included in Calculations of Corr'd Power &amp; PPSD</b>
---------------------------	------	--

**Output Power Results**

Channel	Frequency (MHz)	Meas Power (dBm)	Total Corr'd Power (dBm)	Power Limit (dBm)	Power Margin (dB)
Low	5510	14.078	14.24	24.00	-9.76
Mid	5550	14.096	14.26	24.00	-9.74
High	5670	14.077	14.24	24.00	-9.76

**PPSD Results**

Channel	Frequency (MHz)	Meas PPSD (dBm)	Total Corr'd PPSD (dBm)	PPSD Limit (dBm)	PPSD Margin (dB)
Low	5510	0.206	0.37	11.00	-10.63
Mid	5550	0.299	0.46	11.00	-10.54
High	5670	0.264	0.42	11.00	-10.58

**OUTPUT POWER AND PPSD**

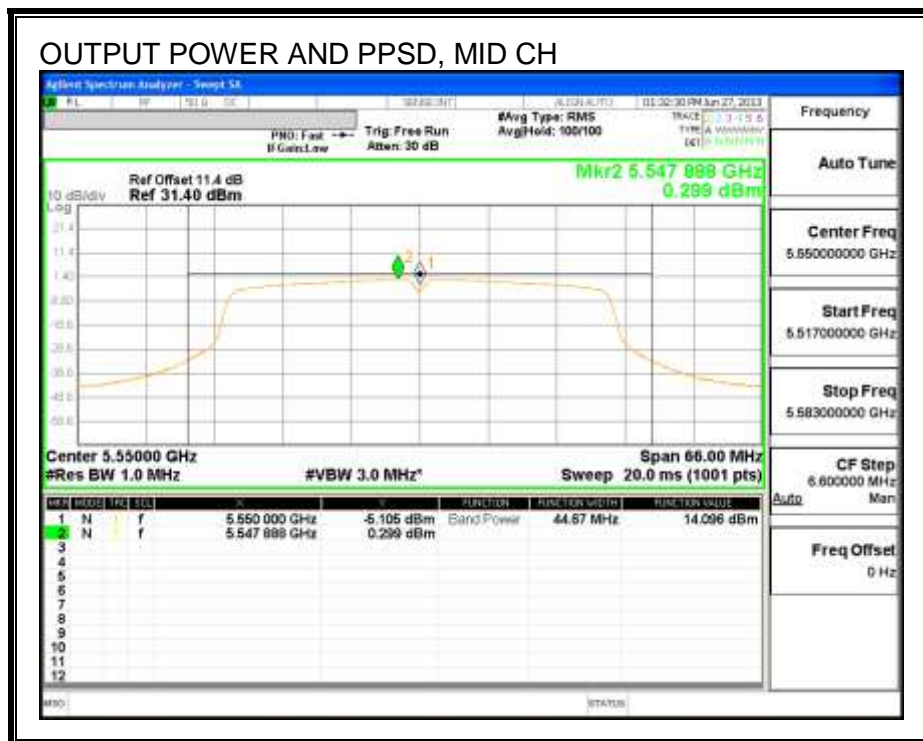
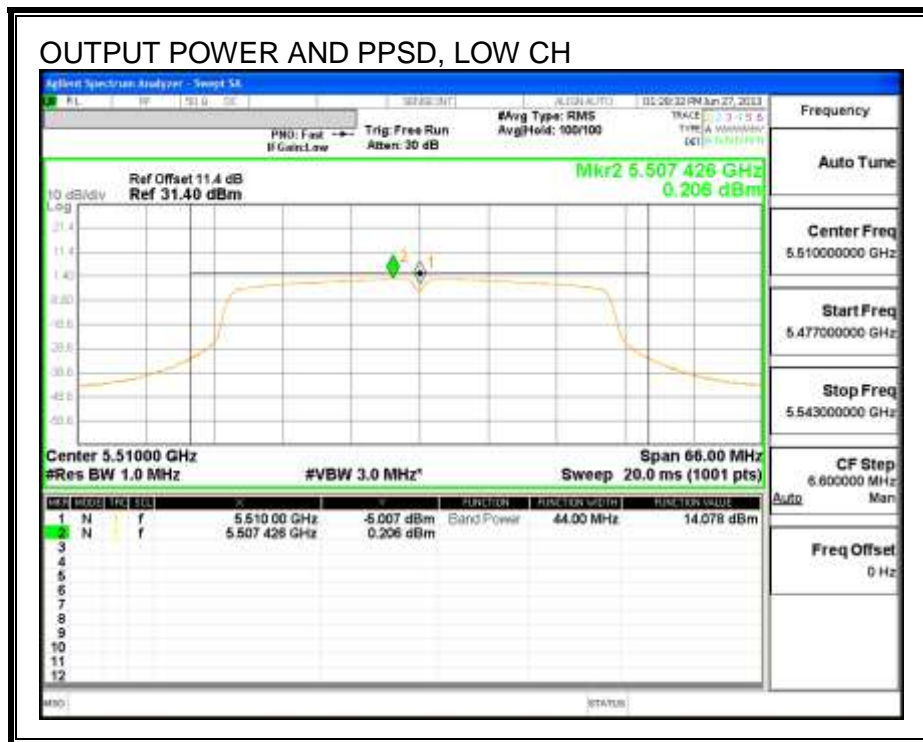

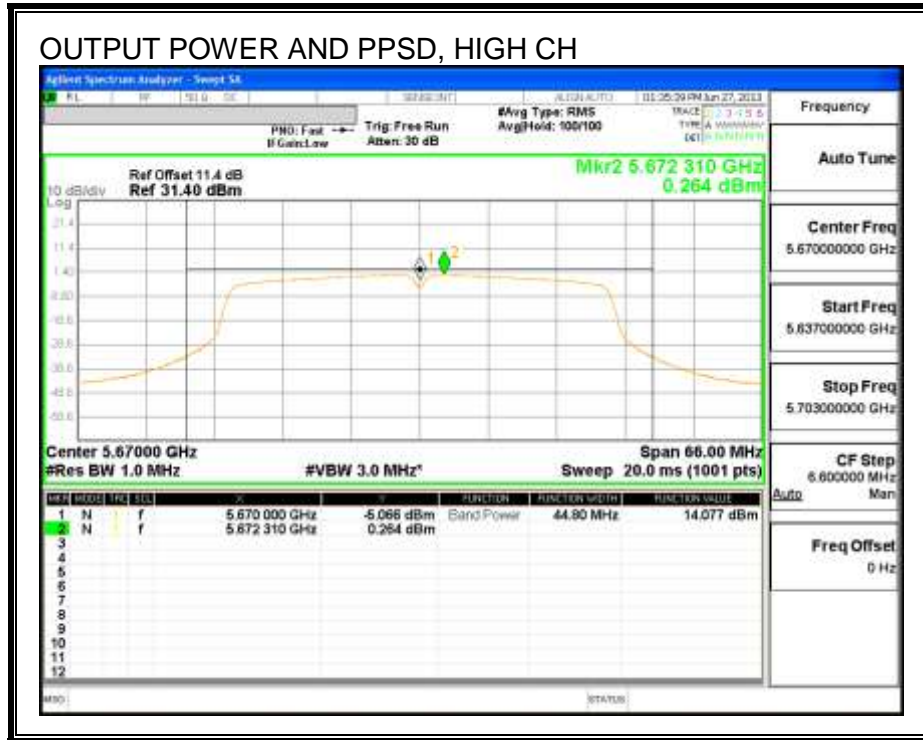

### 8.9.5. PEAK EXCURSION

#### LIMITS

FCC §15.407 (a) (6)

The ratio of the peak excursion of the modulation envelope (measured using a peak hold function) to the peak transmit power (measured as specified above) shall not exceed 13 dB across any 1 MHz bandwidth or the emission bandwidth whichever is less.

#### RESULTS

Refer to the results of 802.11n HT20 mode in the 5.2 GHz band.

Channel	Frequency (MHz)	PK Level (dBm)	PSD (dBm)	DCCF (dB)	Peak Excursion (dB)	Limit (dB)	Margin (dB)
Mid	5550	10.96	0.206	0.16	10.59	13	-2.41

#### PEAK EXCURSION

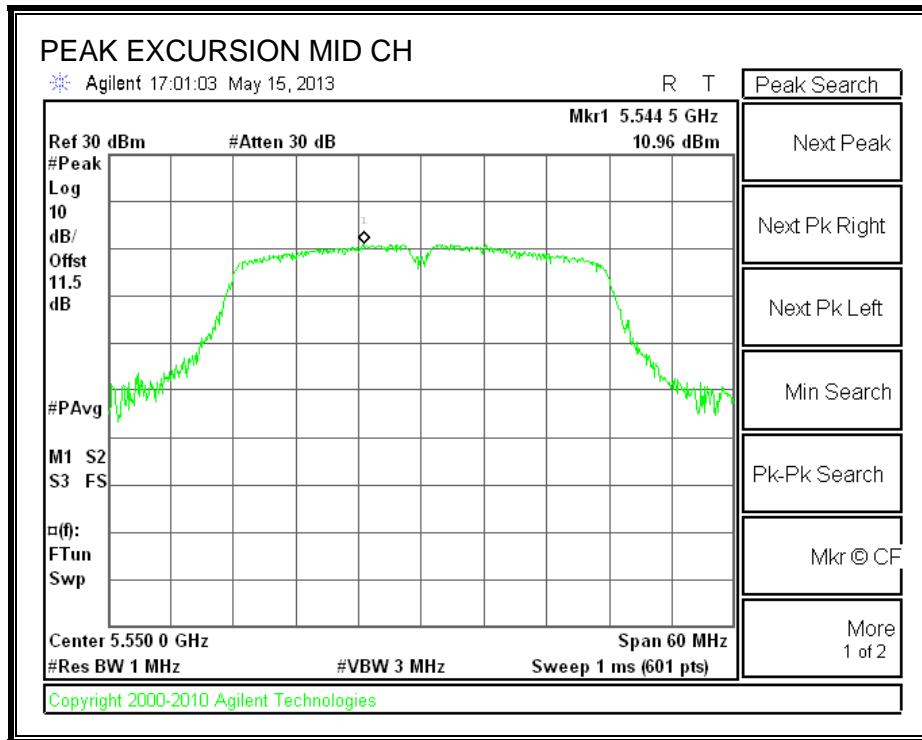



## 9. RADIATED TEST RESULTS

### 9.1. LIMITS AND PROCEDURE

#### LIMITS

FCC §15.205 and §15.209

IC RSS-210 Clause 2.6 (Transmitter)

IC RSS-GEN Clause 6 (Receiver)

Frequency Range (MHz)	Field Strength Limit (uV/m) at 3 m	Field Strength Limit (dBuV/m) at 3 m
30 - 88	100	40
88 - 216	150	43.5
216 - 960	200	46
Above 960	500	54

#### TEST PROCEDURE

The EUT is placed on a non-conducting table 80 cm above the ground plane. The antenna to EUT distance is 3 meters.

For measurements below 1 GHz the resolution bandwidth is set to 100 kHz for peak detection measurements or 120 kHz for quasi-peak detection measurements. Peak detection is used unless otherwise noted as quasi-peak.

For measurements above 1 GHz the resolution bandwidth is set to 1 MHz; the video bandwidth is set to 1 MHz for peak measurements and as applicable for average measurements.

The spectrum from 30 MHz to 40 GHz is investigated with the transmitter set to the lowest, middle, and highest channels in each applicable band.

The frequency range of interest is monitored at a fixed antenna height and EUT azimuth. The EUT is rotated through 360 degrees to maximize emissions received. The antenna is scanned from 1 to 4 meters above the ground plane to further maximize the emission. Measurements are made with the antenna polarized in both the vertical and the horizontal positions.

## 9.2. TRANSMITTER ABOVE 1 GHz

### 9.2.1. TX ABOVE 1 GHz 802.11a MODE IN THE 5.2 GHz BAND

#### RESTRICTED BANDEDGE (LOW CHANNEL)

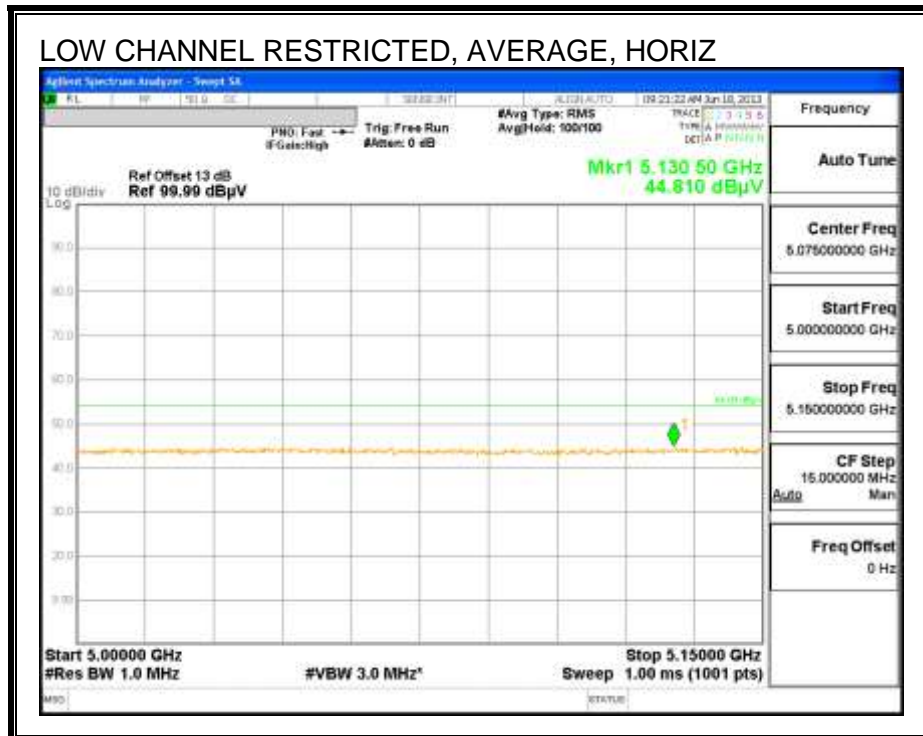
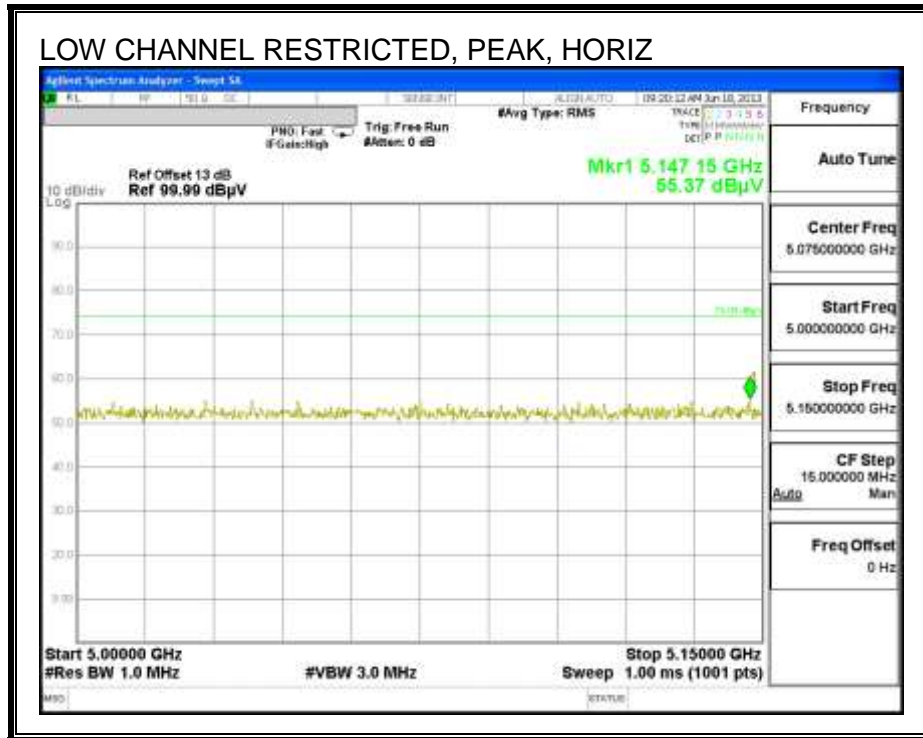

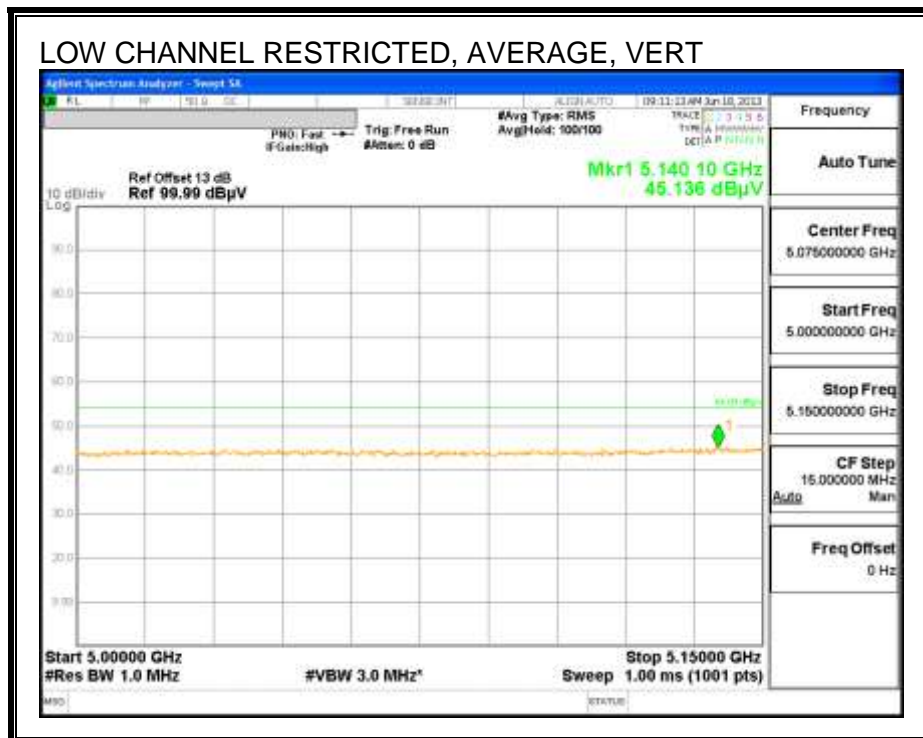
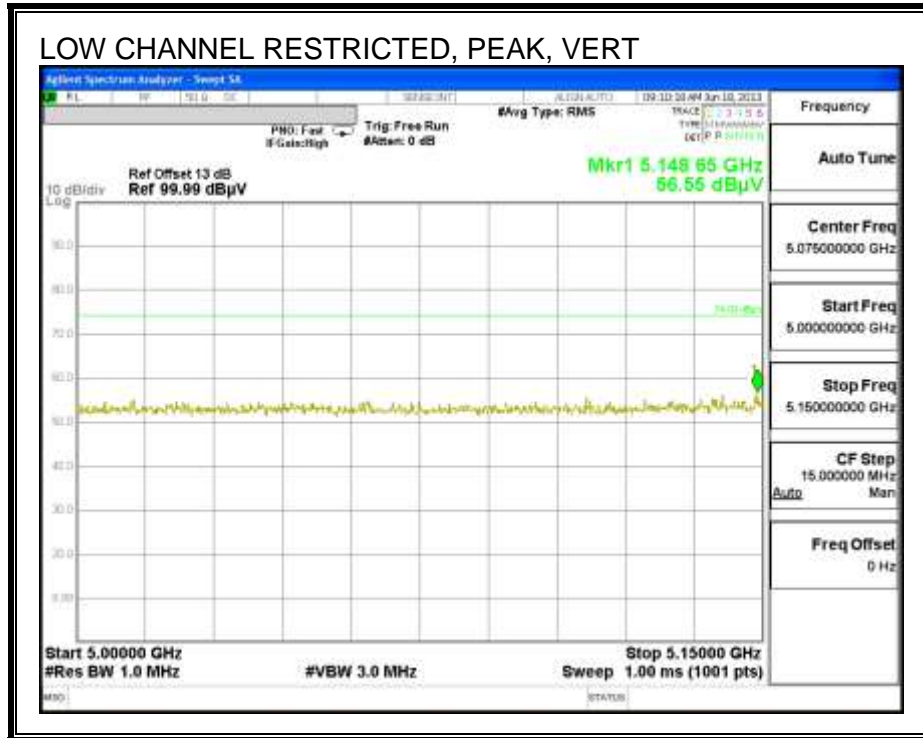

**HARMONICS AND SPURIOUS EMISSIONS**

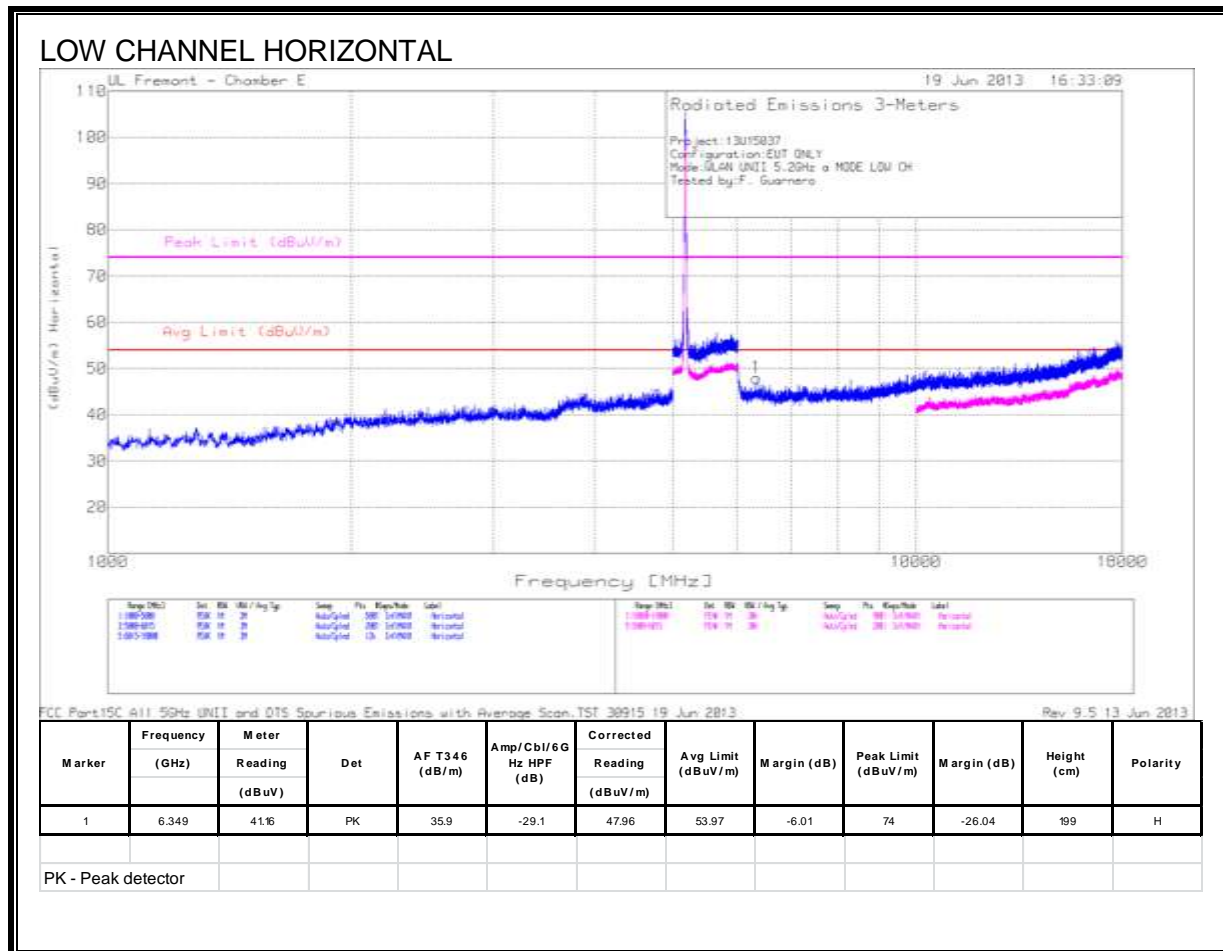

LOW CHANNEL VERTICAL

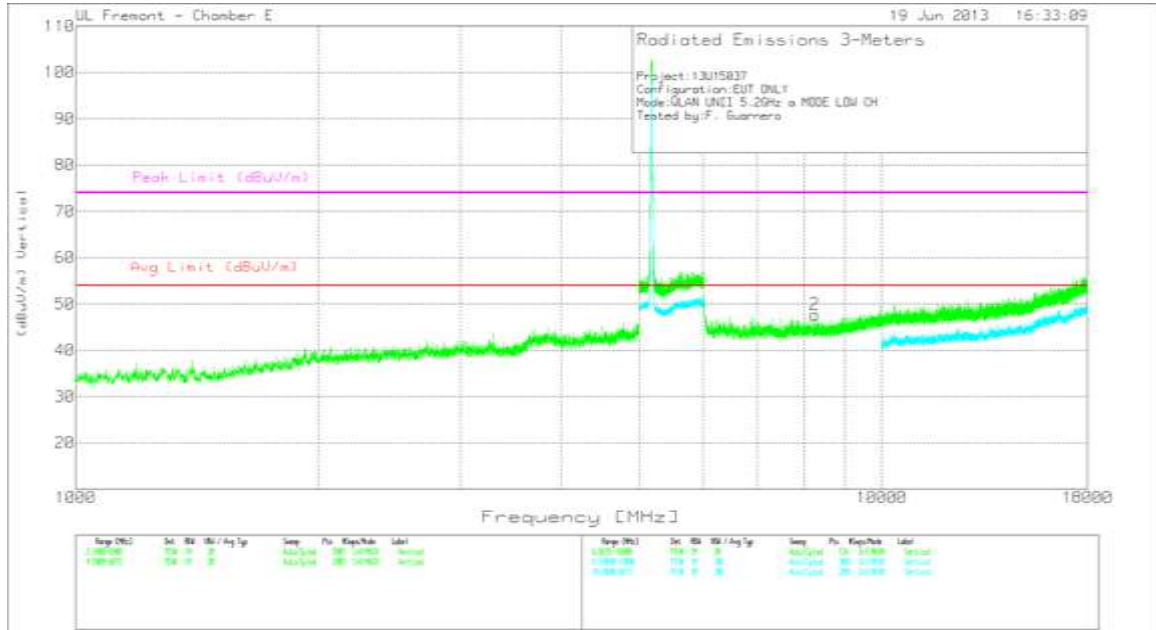

FCC Part15C All 50MHz UN11 and DTS Spurious Emissions with Average Span, TST 30915 19 Jun 2013 Rev 9.5 13 Jun 2013

Marker	Frequency (GHz)	Meter	Det	AF T346 (dB/m)	Amp/Cb1/6G Hz HPF (dB)	Corrected	Avg Limit (dBuV/m)	Margin (dB)	Peak Limit (dBuV/m)	Margin (dB)	Height (cm)	Polarity
		Reading (dBuV)				Reading (dBuV/m)						
2	8.26	39.39	PK	36.2	-27.9	47.69	53.97	-6.28	74	-26.31	199	V

PK - Peak detector

MID CHANNEL HORIZONTAL

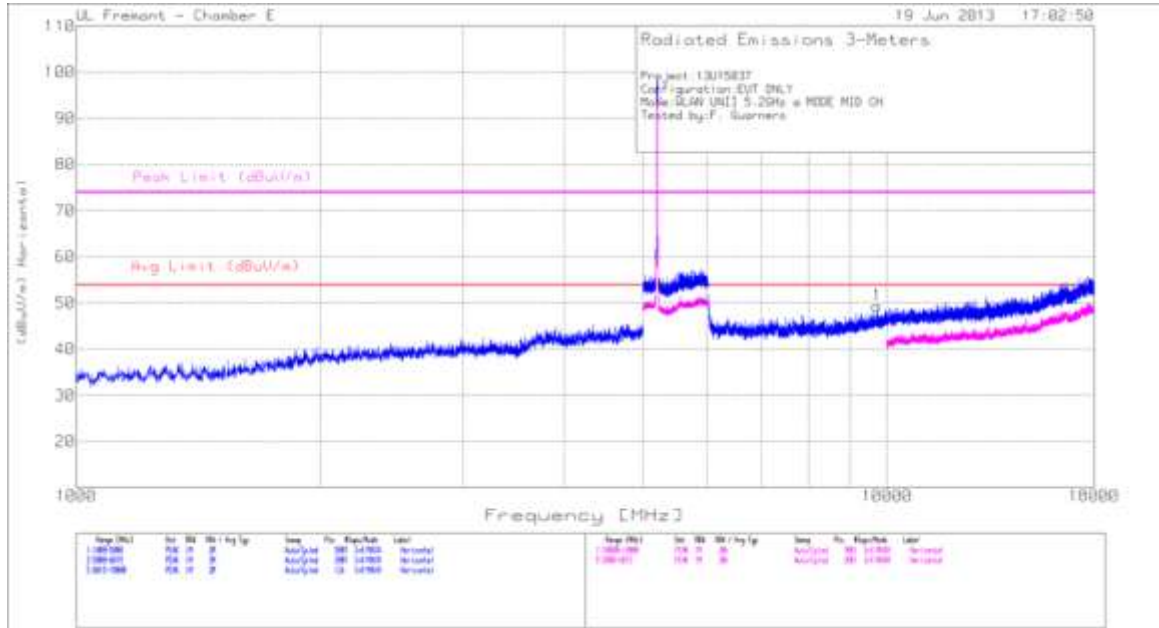

FCC Part 15C 411 50Hz UNI and DTS Spurious Emissions with Average Scan TST 30913 19 Jun 2013 Rev: 9.5 13 Jun 2013

Marker	Frequency (GHz)	Meter	Det	AF T346 (dB/m)	Amp/Cb1/6G Hz HPF (dB)	Corrected	Avg Limit (dBuV/m)	Margin (dB)	Peak Limit (dBuV/m)	Margin (dB)	Height (cm)	Polarity
		Reading (dBuV)				Reading (dBuV/m)						
1	9.719	37.5	PK	37.6	-25.7	49.4	53.97	-4.57	74	-24.6	89	H

PK - Peak detector

MID CHANNEL VERTICAL

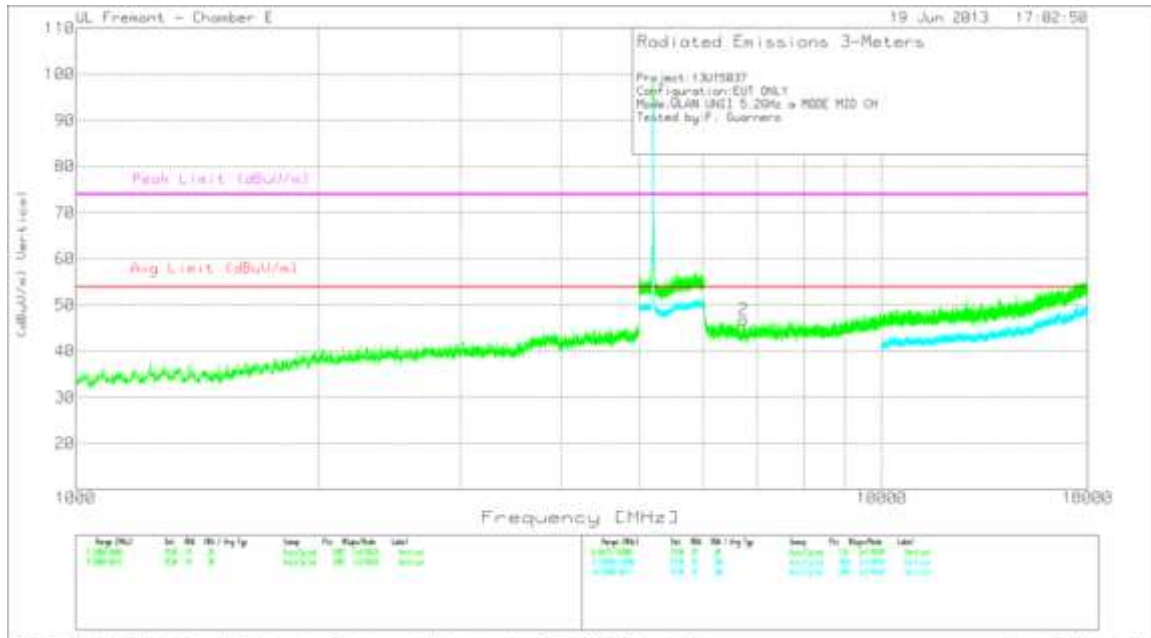

FCC Part15C All 500m WMI and DTS Spurious Emissions with Average Scan, TST 30915 19 Jun 2013 Rev 9.5 13 Jun 2013

Marker	Frequency (GHz)	Meter	Det	AF T346 (dB/m)	Amp/Cbl/6G Hz HPF (dB)	Corrected	Avg Limit (dBuV/m)	Margin (dB)	Peak Limit (dBuV/m)	Margin (dB)	Height (cm)	Polarity
		Reading (dBuV)				Reading (dBuV/m)						
2	6.741	40.94	PK	35.8	-29.9	46.84	53.97	-7.13	74	-27.16	99	V

PK - Peak detector

### HIGH CHANNEL HORIZONTAL

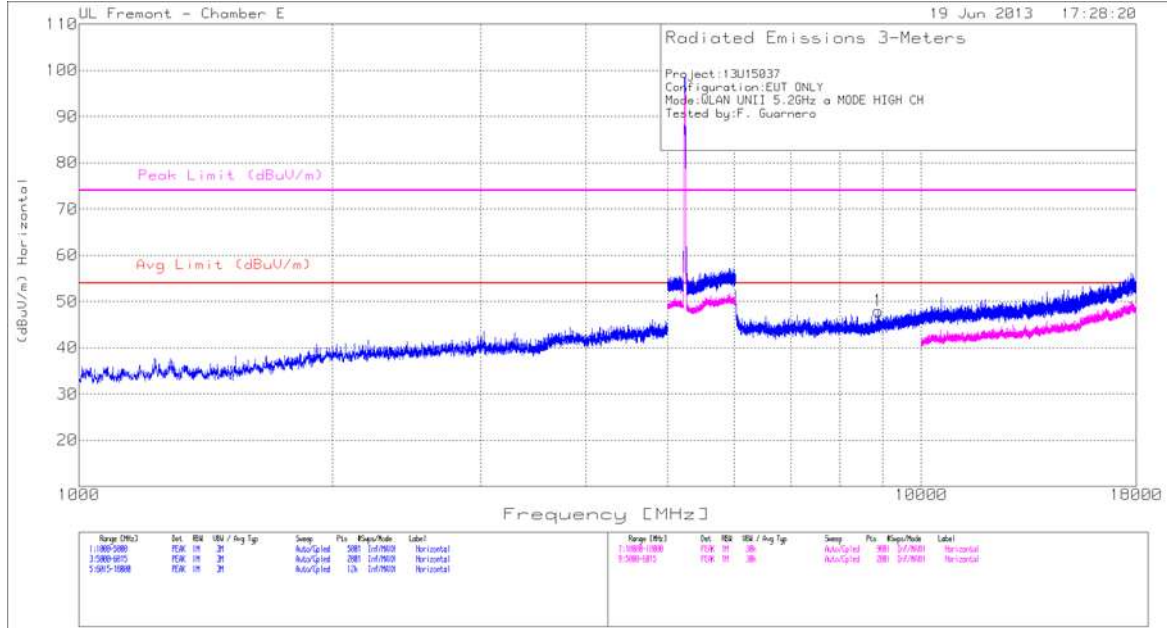

FCC Part15C All 5GHz UNII and DTS Spurious Emissions with Average Scan.TST 30915 19 Jun 2013

Rev 9.5 13 Jun

Marker	Frequency (GHz)	Meter	Det	AF T346 (dB/m)	Amp/Cb1/6G Hz HPF (dB)	Corrected	Avg Limit (dBuV/m)	Margin (dB)	Peak Limit (dBuV/m)	Margin (dB)	Height (cm)	Polarity
		Reading (dBuV)				Reading (dBuV/m)						
1	8.894	38.54	PK	36.7	-27.3	47.94	53.97	-6.03	74	-26.06	199	H

PK - Peak detector



### HIGH CHANNEL VERTICAL



FCC Part 15C, 15.101-15.109 UNITS and DTS Spurious Emissions with Average Scan TEST 30915 19 Jun 2013 Rev: 9.5.13 Jun 2013

Marker	Frequency (GHz)	Meter	Det	AF T346 (dB/m)	Amp/Cbl/6G Hz HPF (dB)	Corrected	Avg Limit (dBuV/m)	Margin (dB)	Peak Limit (dBuV/m)	Margin (dB)	Height (cm)	Polarity
		Reading (dBuV)				Reading (dBuV/m)						
2	9.434	38.11	PK	37.4	-26.9	48.61	53.97	-5.36	74	-25.39	89	V
PK - Peak detector												

### 9.2.2. TX ABOVE 1 GHz 802.11n HT20 MODE IN THE 5.2 GHz BAND

#### RESTRICTED BANDEDGE (LOW CHANNEL)

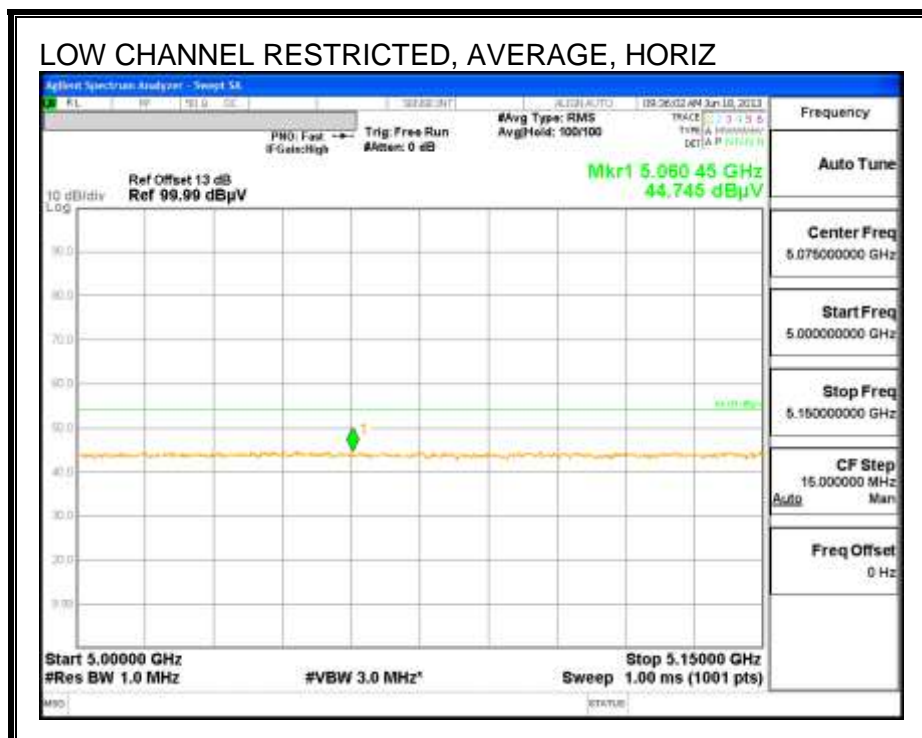
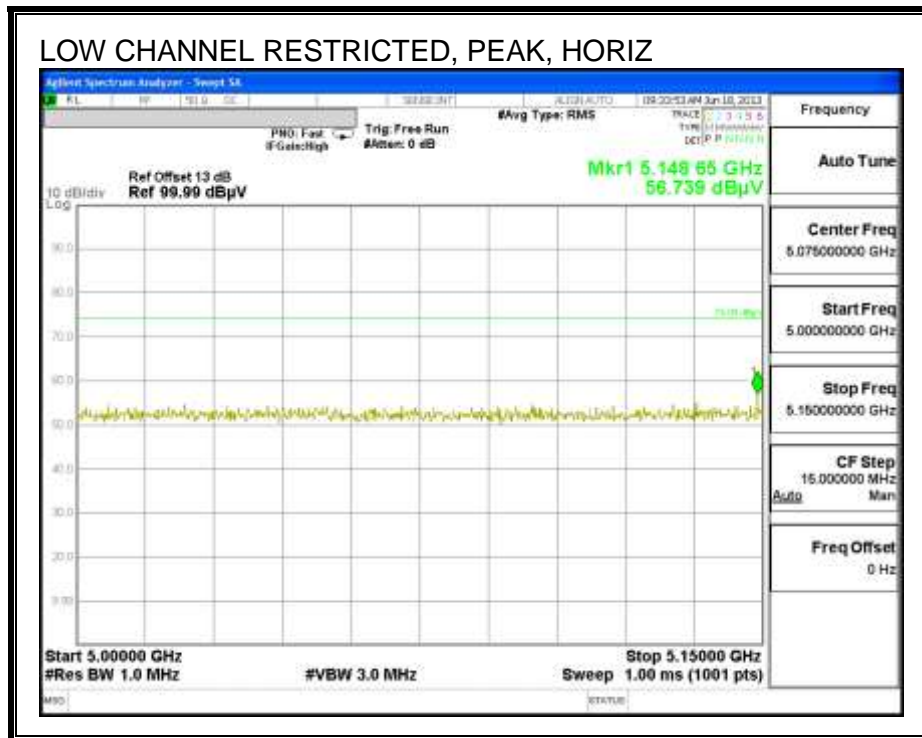

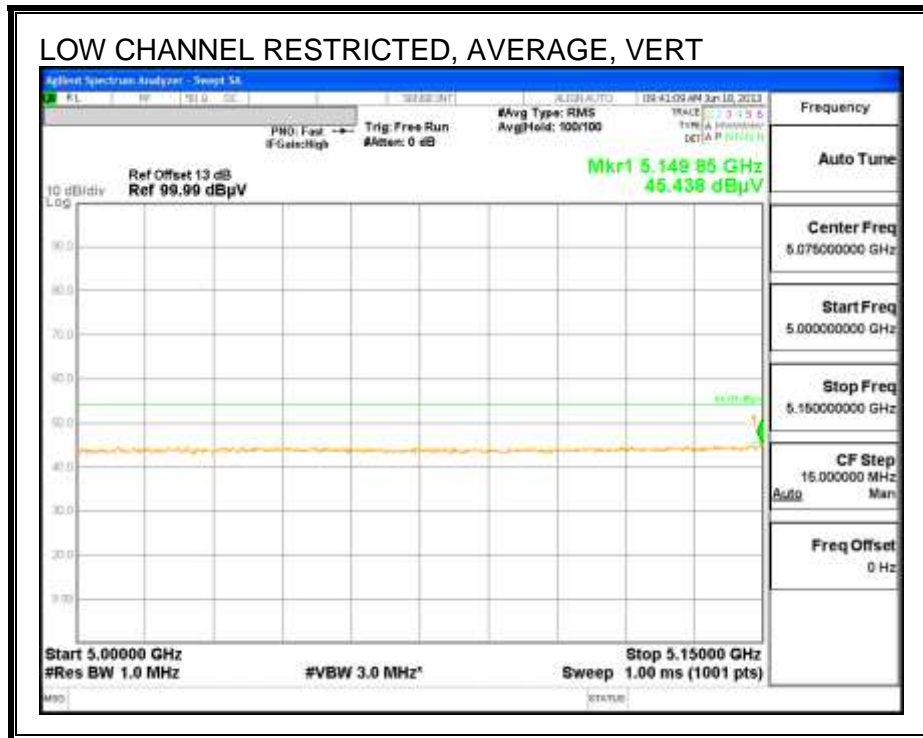
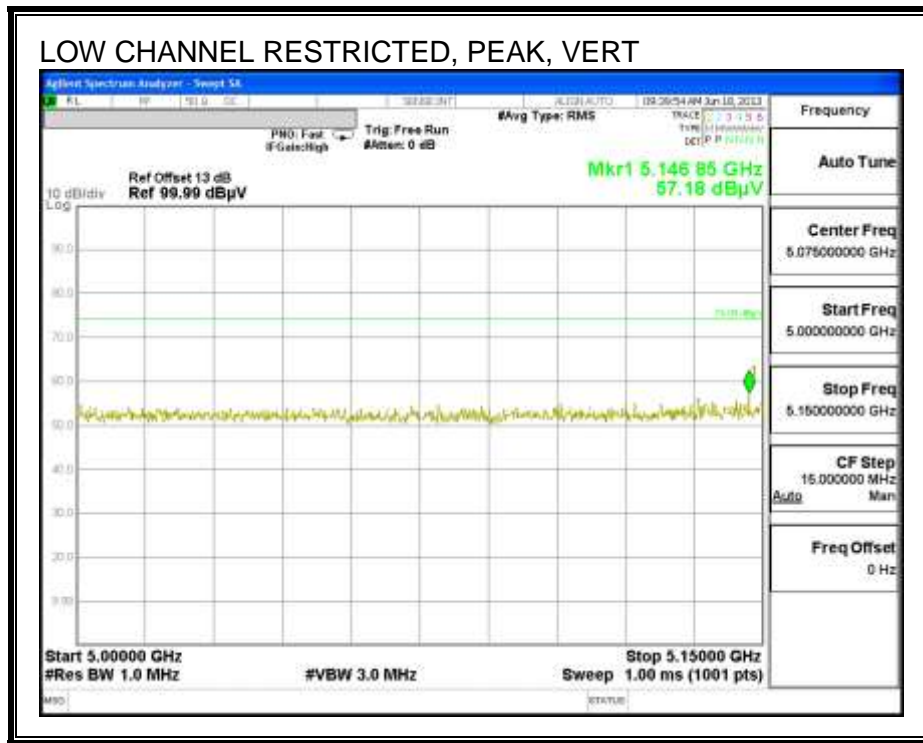

**HARMONICS AND SPURIOUS EMISSIONS**

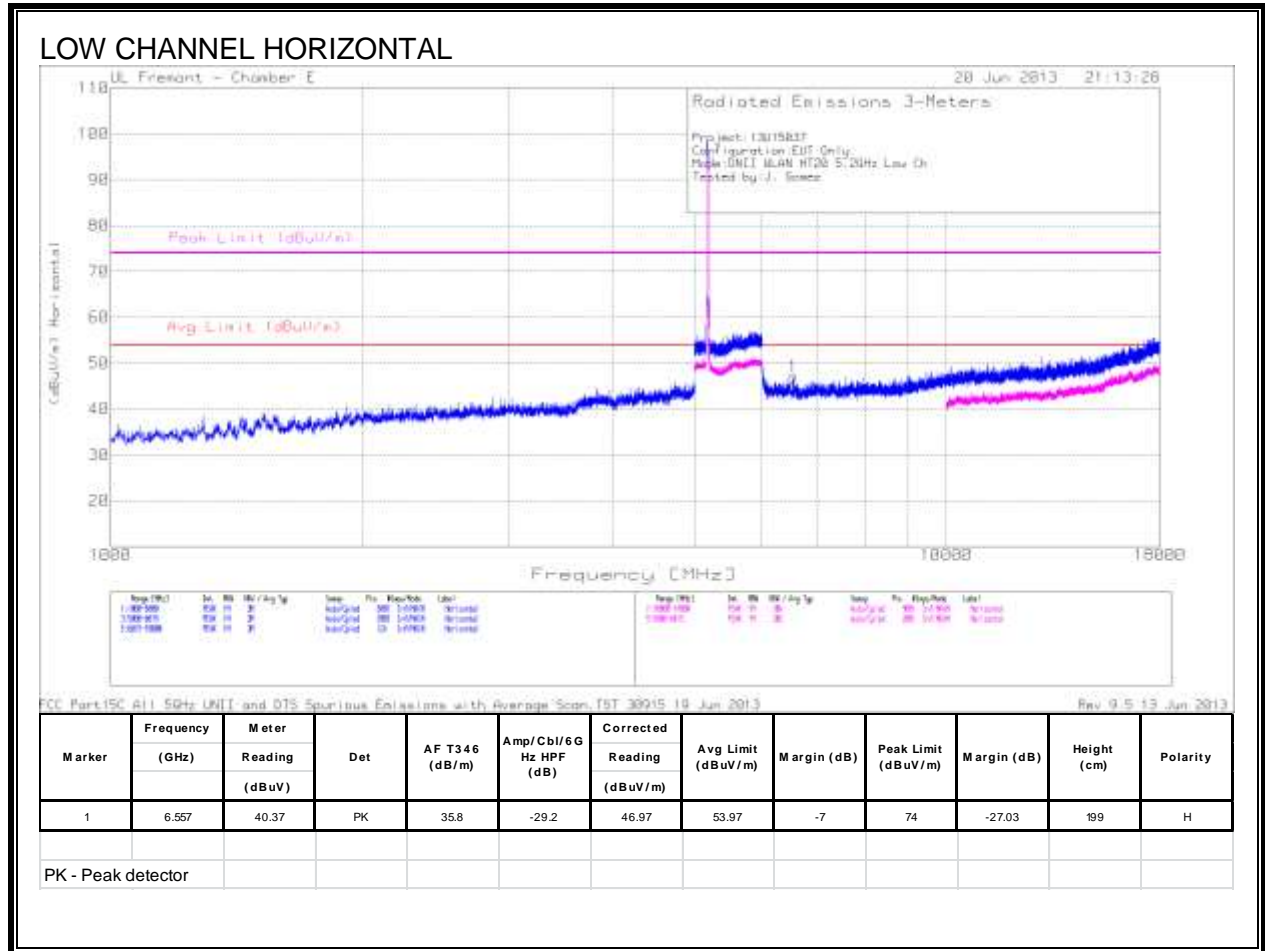

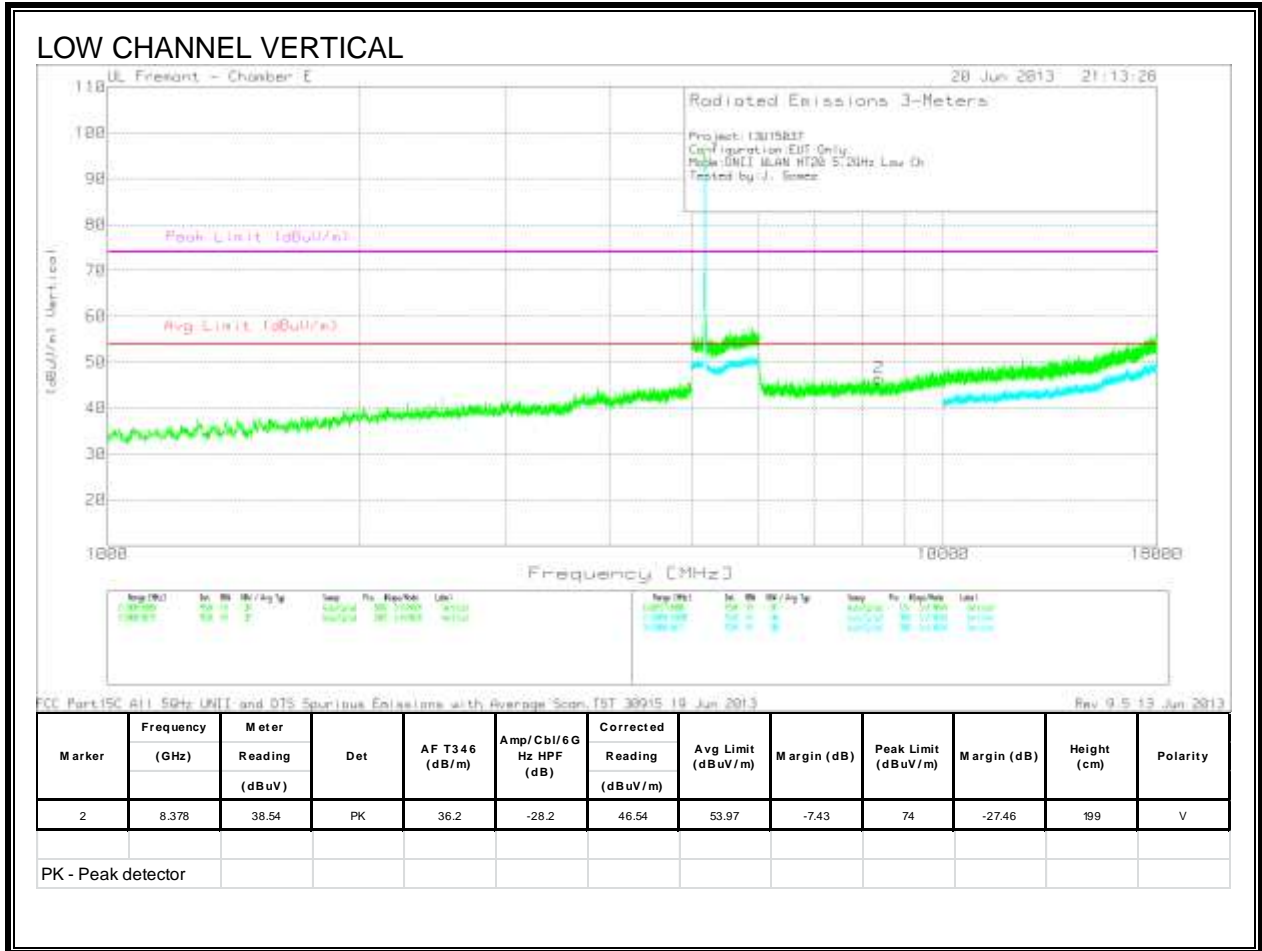

MID CHANNEL HORIZONTAL

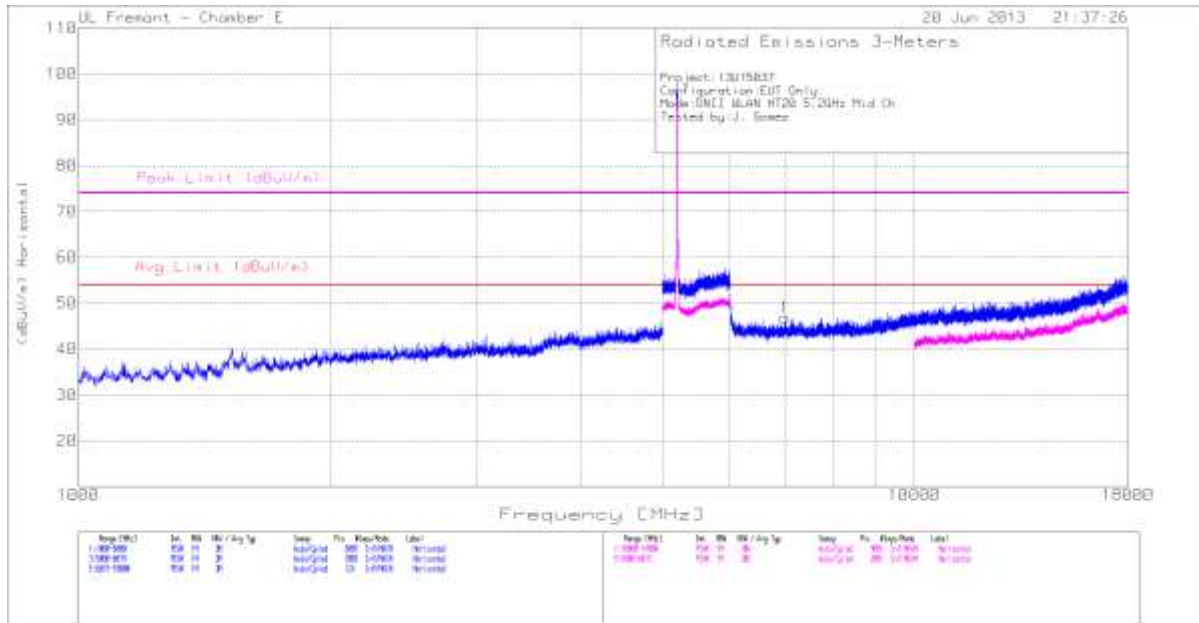

FCC Part 15C All 50Hz UNII and DTS Spurious Emissions with Average Scan (BT 30215 18 Jun 2013)

Rev: 0.5 13 Jun 2013

Marker	Frequency (GHz)	Meter	Det	AF T346 (dB/m)	Amp/Cb1/6G Hz HPF (dB)	Corrected	Avg Limit (dBuV/m)	Margin (dB)	Peak Limit (dBuV/m)	Margin (dB)	Height (cm)	Polarity
		Reading (dBuV)				Reading (dBuV/m)						
1	6.999	39.75	PK	36	-29	46.75	53.97	-7.22	74	-27.25	199	H
PK - Peak detector												

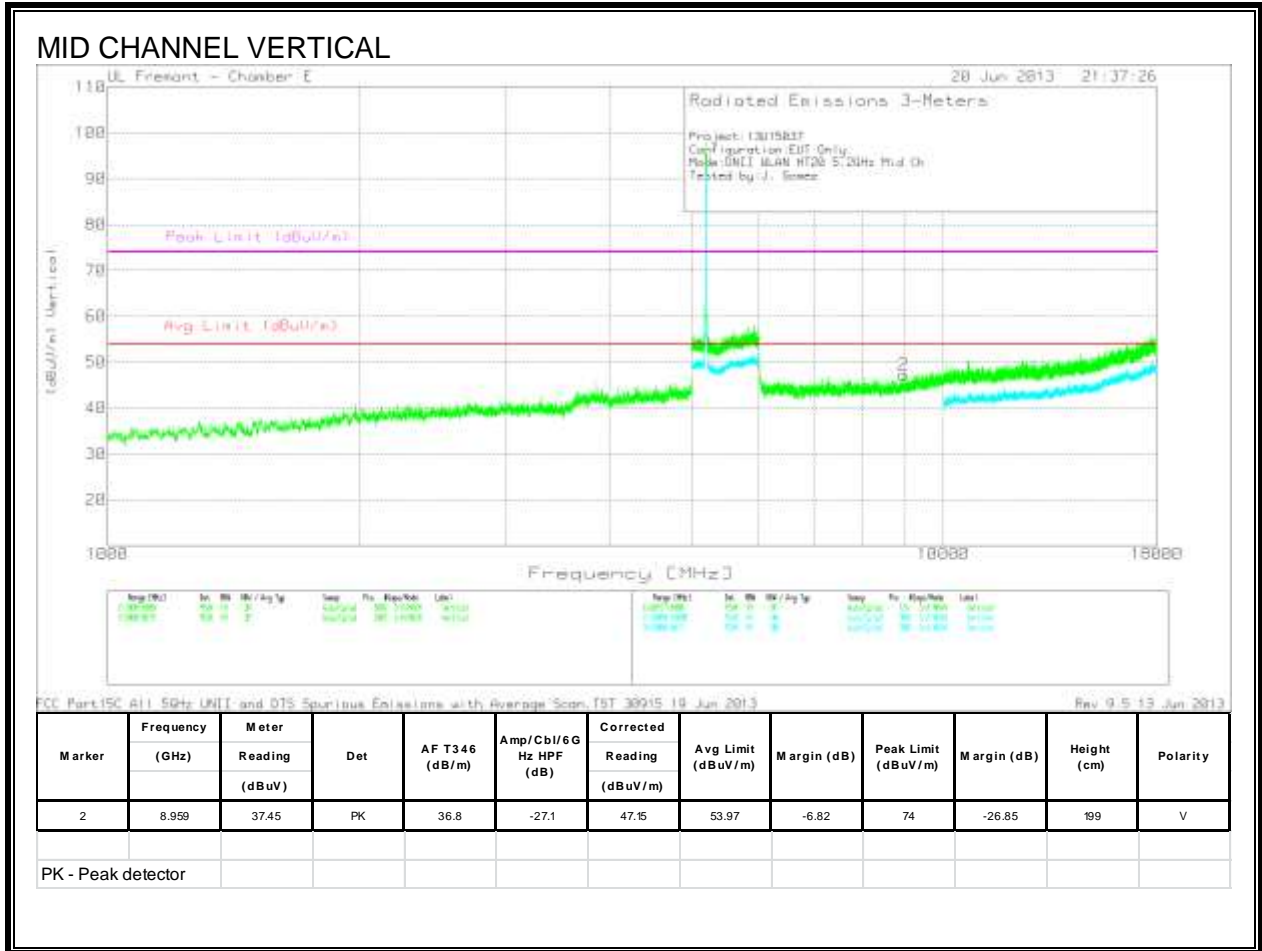

HIGH CHANNEL HORIZONTAL

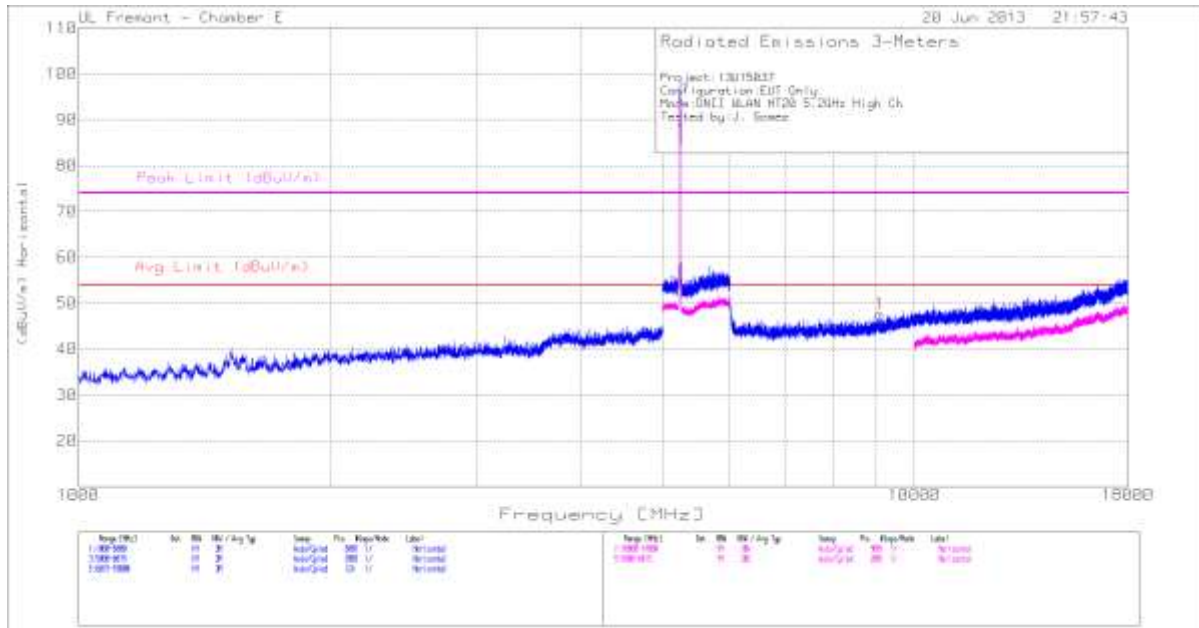

MIT WLAN HT20 HIGH 053 DAT 30915 10 Jun 2013 Rev: 9.5 13 Jun 2013

Marker	Frequency (GHz)	Meter	Det	AF T346 (dB/m)	Amp/Cb/6G Hz HPF (dB)	Corrected	Avg Limit (dBuV/m)	Margin (dB)	Peak Limit (dBuV/m)	Margin (dB)	Height (cm)	Polarity
		Reading (dBuV)				Reading (dBuV/m)						
1	9.09	37.55	PK	36.9	-26.9	47.55	53.97	-6.42	74	-26.45	199	H

PK - Peak detector



### HIGH CHANNEL VERTICAL

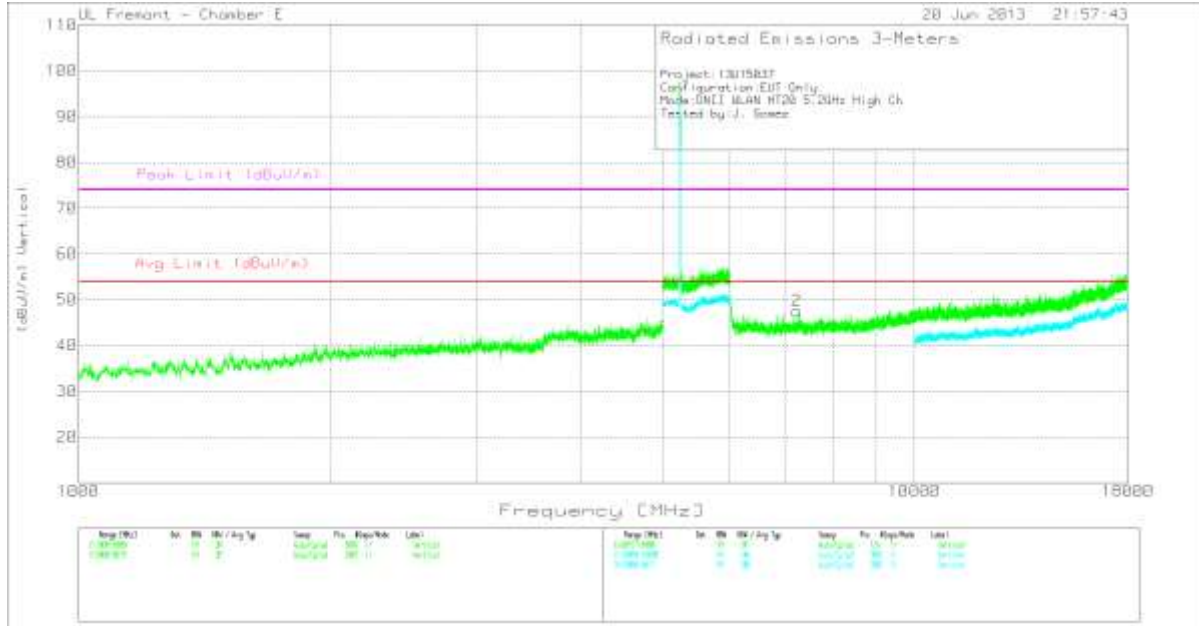

UNT MEAN HT20 HIGH Q63 DAT 30915 10 Jun 2013 Rev: 9.5 13 Jun 2013

Marker	Frequency (GHz)	Meter	Det	AF T346 (dB/m)	Amp/Cb/6G Hz HPF (dB)	Corrected	Avg Limit (dBuV/m)	Margin (dB)	Peak Limit (dBuV/m)	Margin (dB)	Height (cm)	Polarity
		Reading (dBuV)				Reading (dBuV/m)						
2	7.235	40.92	PK	36	-29.4	47.52	53.97	-6.45	74	-26.48	199	V

PK - Peak detector

### 9.2.3. TX ABOVE 1 GHz 802.11n HT40 MODE IN THE 5.2 GHz BAND

#### RESTRICTED BANEDGE (LOW CHANNEL)

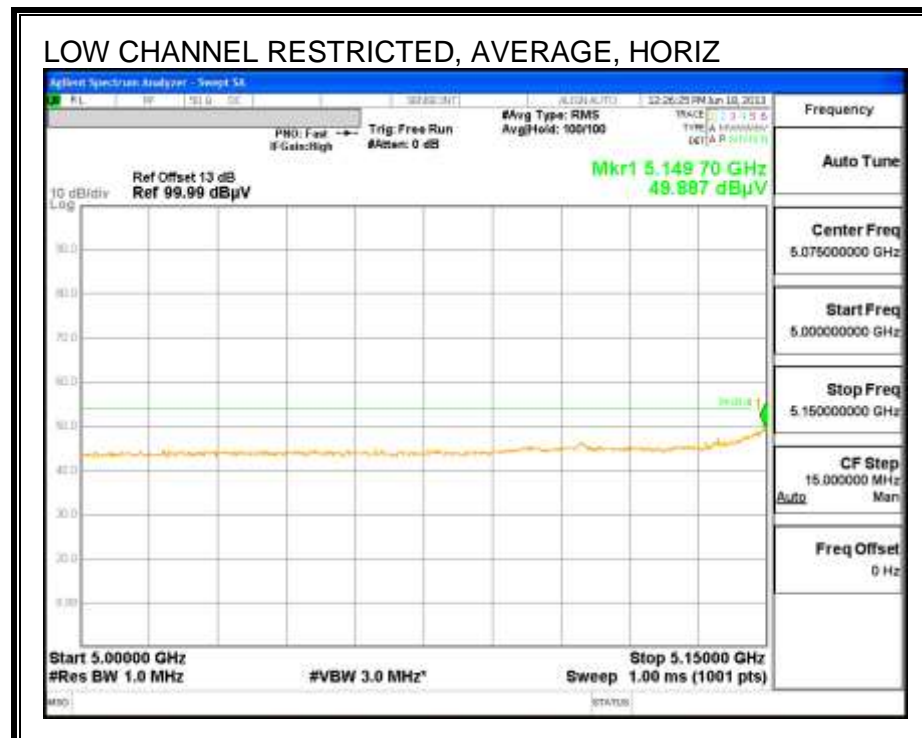
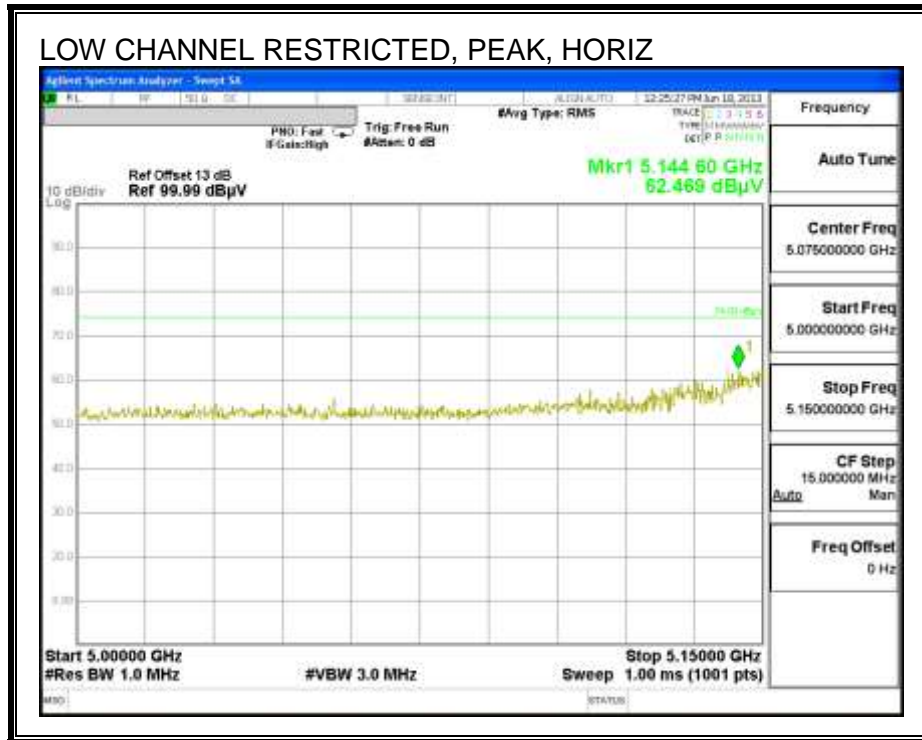

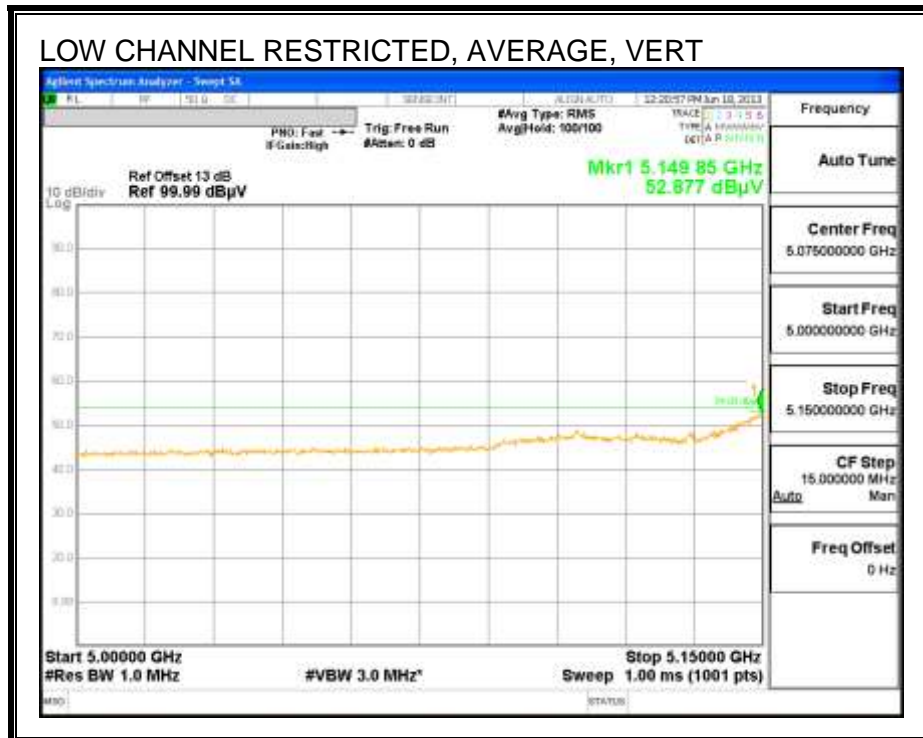
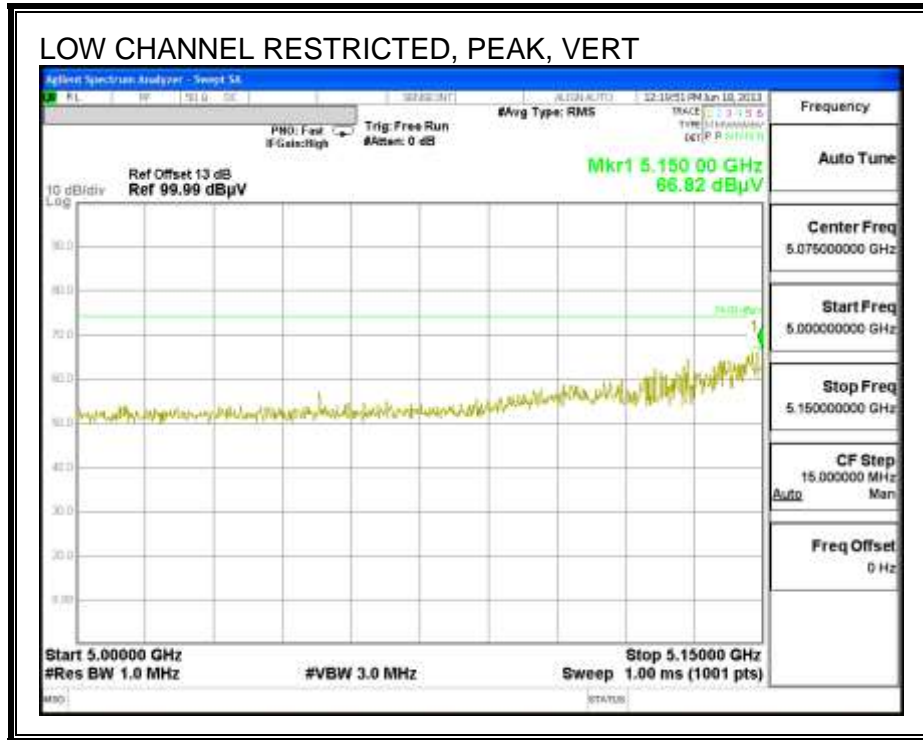

**HARMONICS AND SPURIOUS EMISSIONS**

**LOW CHANNEL HORIZONTAL**

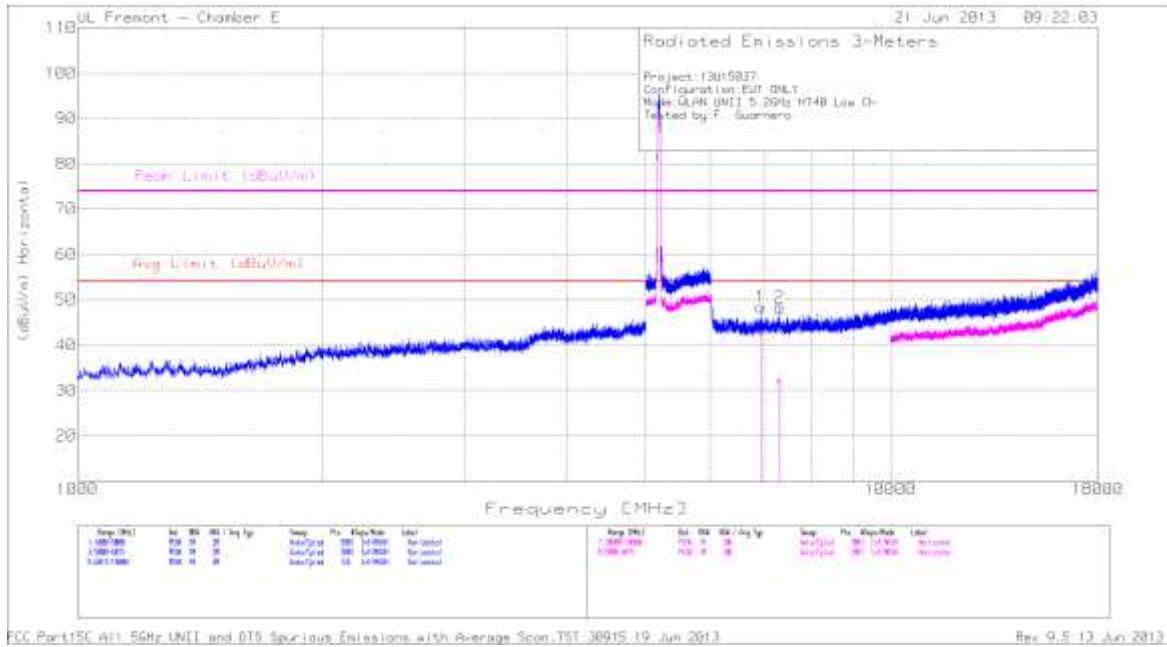

Frequency (GHz)	Meter Reading (dBuV)	Det	AF T346 (dB/m)	Amp/Cbl/6GHz HPF (dB)	Corrected Reading dBuV/m	Avg Limit (dBuV/m)	Margin (dB)	Peak Limit (dBuV/m)	Margin (dB)	Azimuth (Degs)	Height (cm)	Polarity
6.92	36.38	Av	35.9	-29.5	42.78	53.97	-11.19	74	-31.22	341	348	H
7.311	25.04	Av	36	-28.8	32.24	53.97	-21.73	74	-41.76	53	164	H

LOW CHANNEL VERTICAL

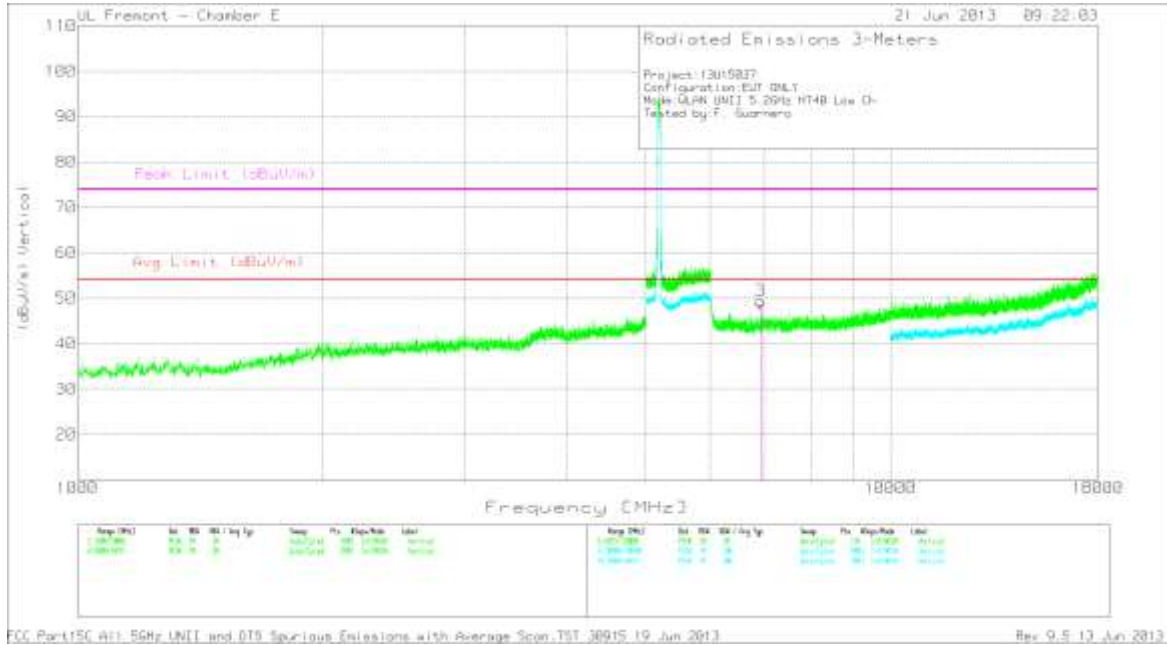

Frequency (GHz)	Meter Reading (dBuV)	Det	AF T346 (dB/m)	Amp/Cbl/6GHz HPF (dB)	Corrected Reading dBuV/m	Avg Limit (dBuV/m)	Margin (dB)	Peak Limit (dBuV/m)	Margin (dB)	Azimuth (Degs)	Height (cm)	Polarity
6.92	41.55	Av	35.9	-29.5	47.95	53.97	-6.02	74	-26.05	196	196	V

HIGH CHANNEL HORIZONTAL

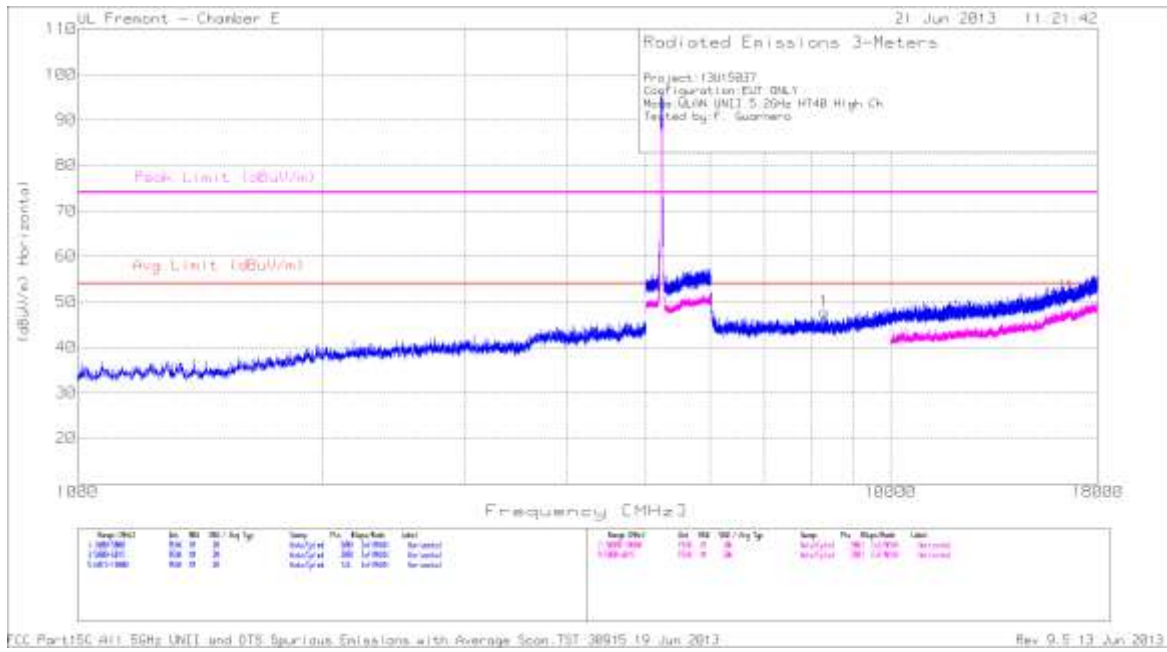

Frequency (GHz)	Meter Reading (dBuV)	Det	AF T346 (dB/m)	Amp/Cbl/6GHz HPF (dB)	Corrected Reading dBuV/m	Avg Limit (dBuV/m)	Margin (dB)	Peak Limit (dBuV/m)	Margin (dB)	Azimuth (Degs)	Height (cm)	Polarity
1	8.296	39.36	PK	36.2	-27.8	47.76	53.97	-6.21	74	-26.24	199	H

### HIGH CHANNEL VERTICAL

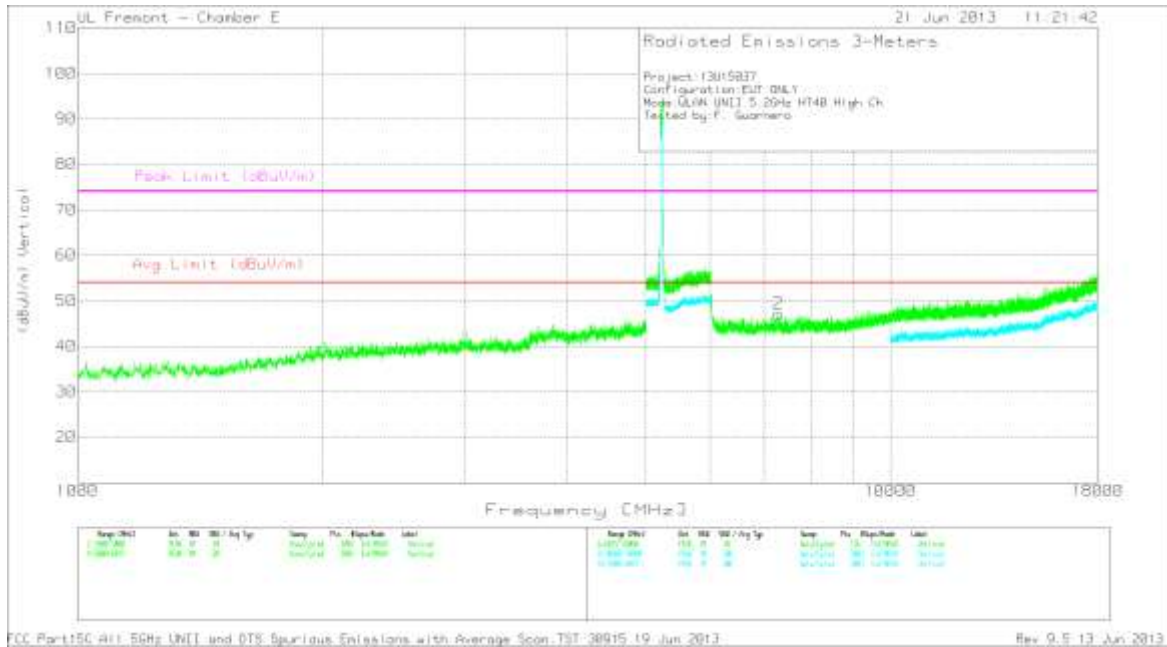

Frequency (GHz)	Meter Reading (dBuV)	Det	AF T346 (dB/m)	Amp/Cbl/6GHz HPF (dB)	Corrected Reading dBuV/m	Avg Limit (dBuV/m)	Margin (dB)	Peak Limit (dBuV/m)	Margin (dB)	Azimuth (Degs)	Height (cm)	Polarity
2	7.281	39.9	PK	36	-28.8	47.1	53.97	-6.87	74	-26.9	199	V

### 9.2.4. TX ABOVE 1 GHz 802.11a MODE IN THE 5.3 GHz BAND

#### RESTRICTED BANDEDGE (HIGH CHANNEL)

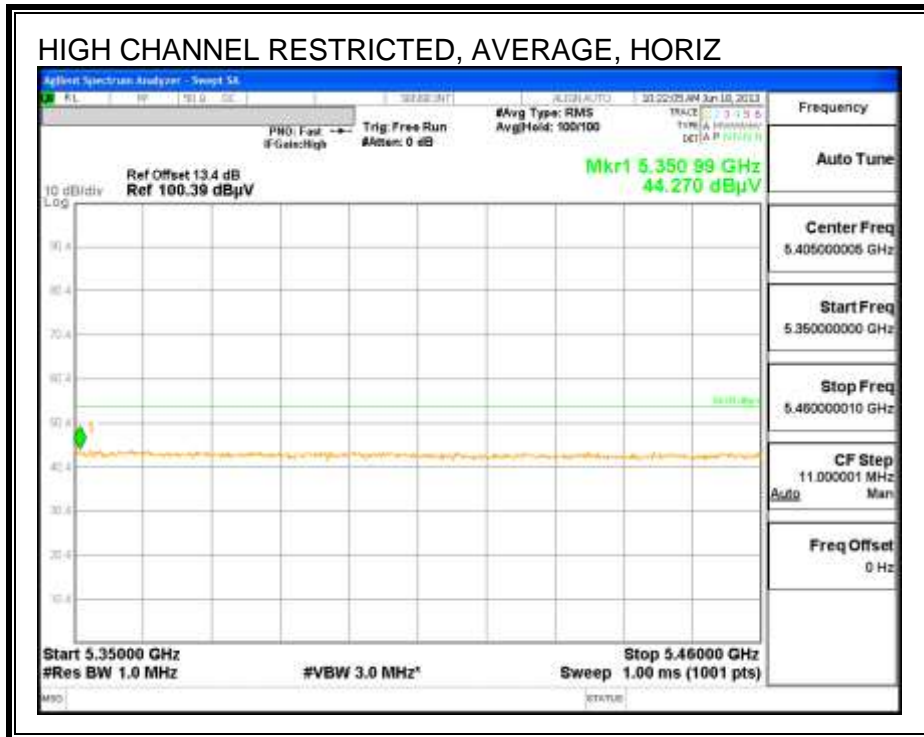
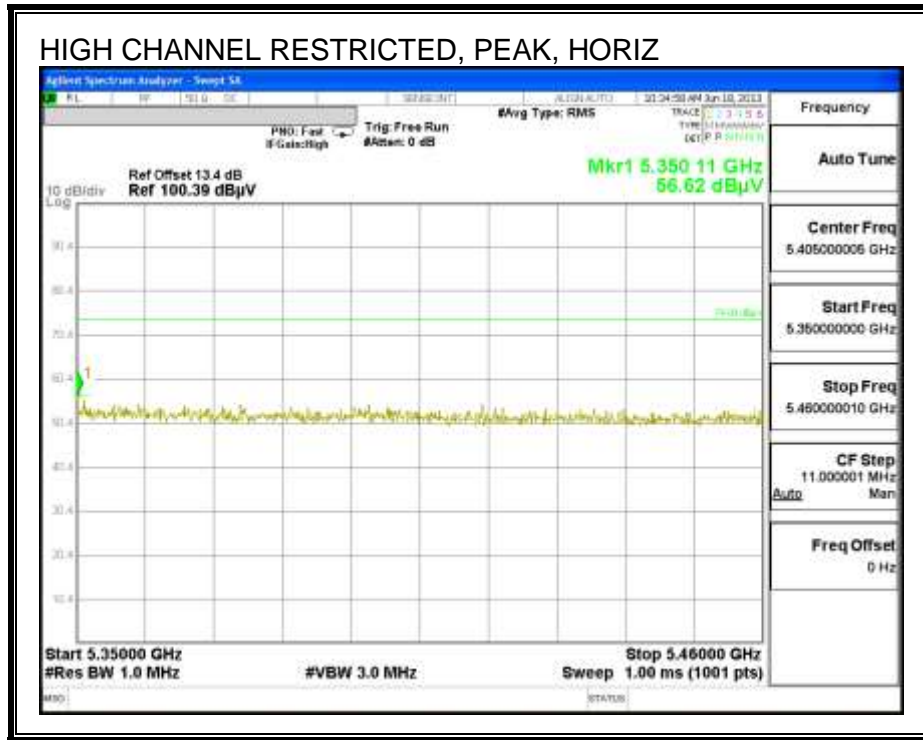



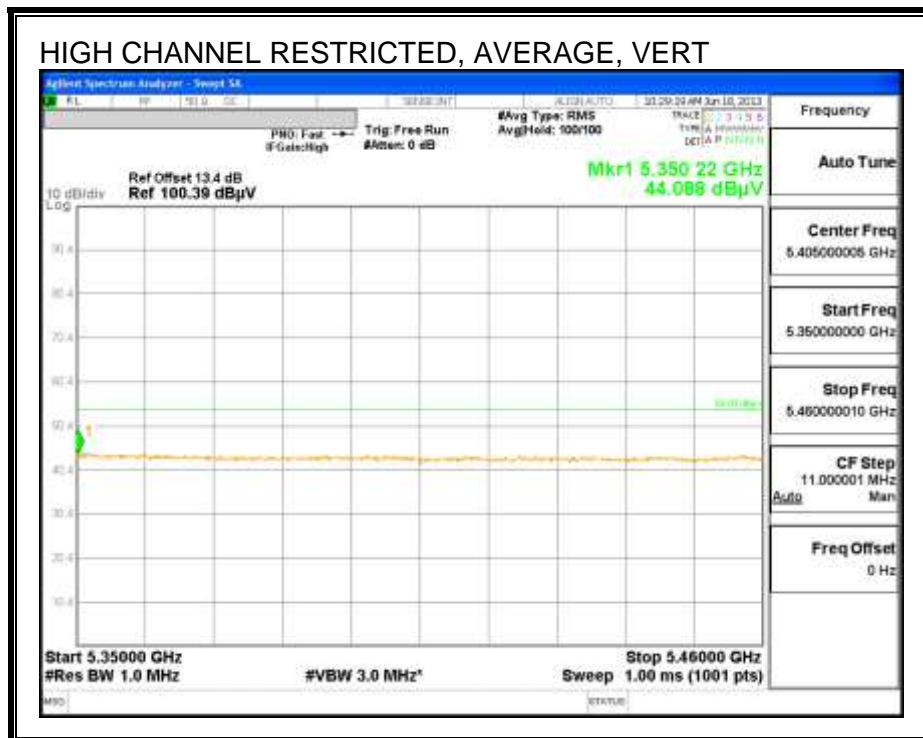
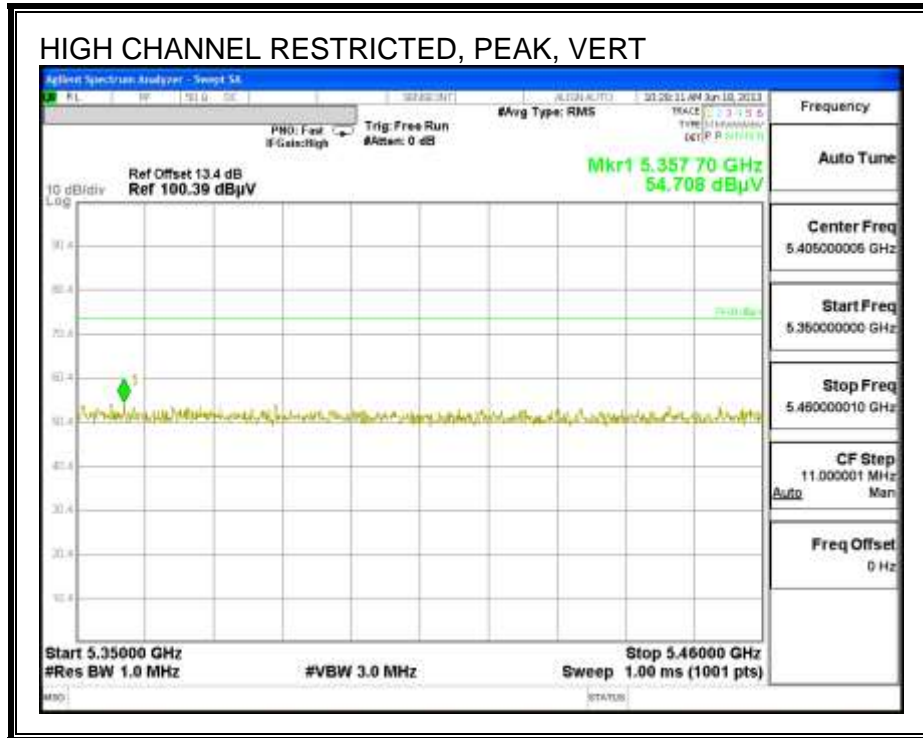

**HARMONICS AND SPURIOUS EMISSIONS**

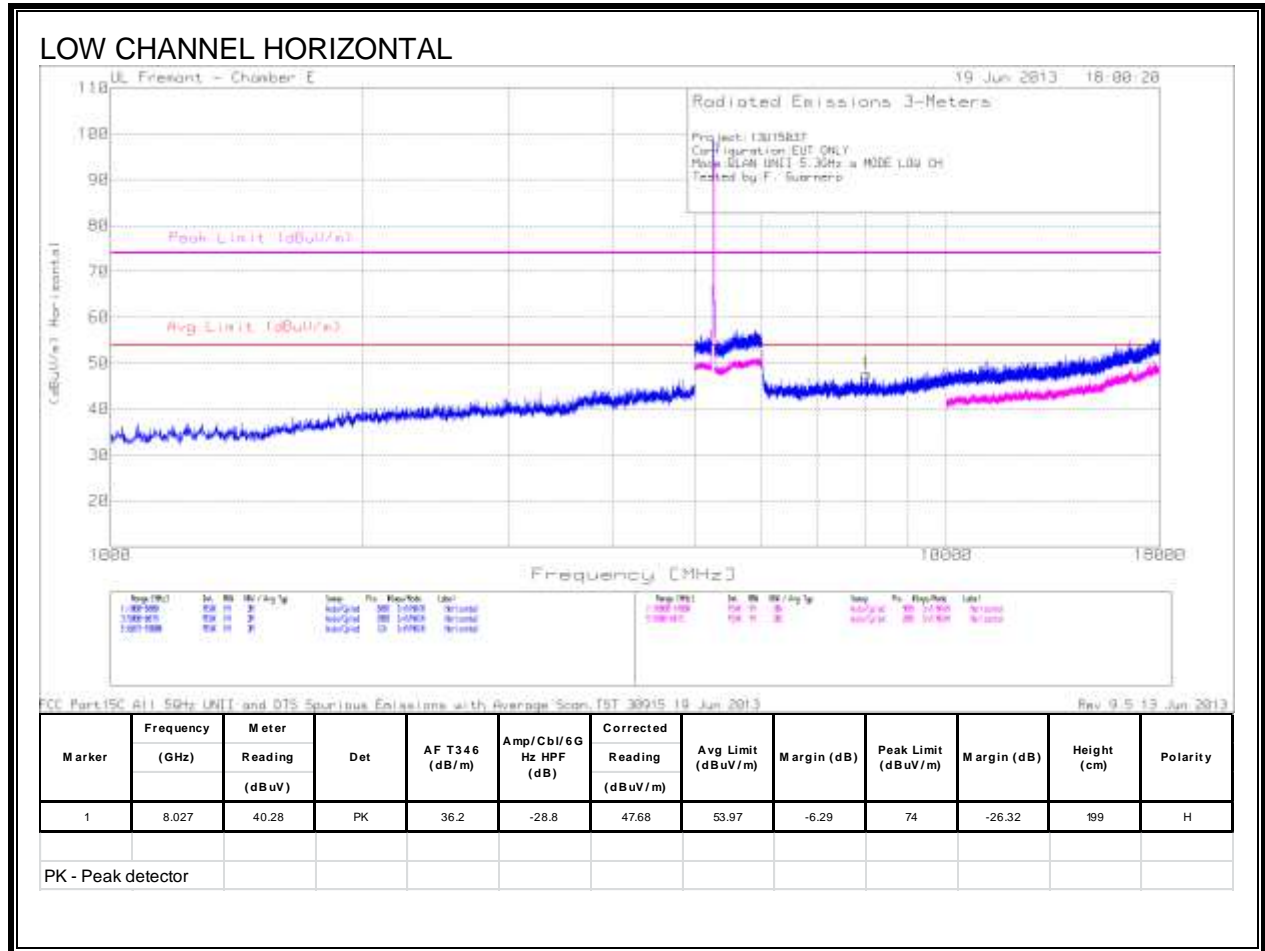

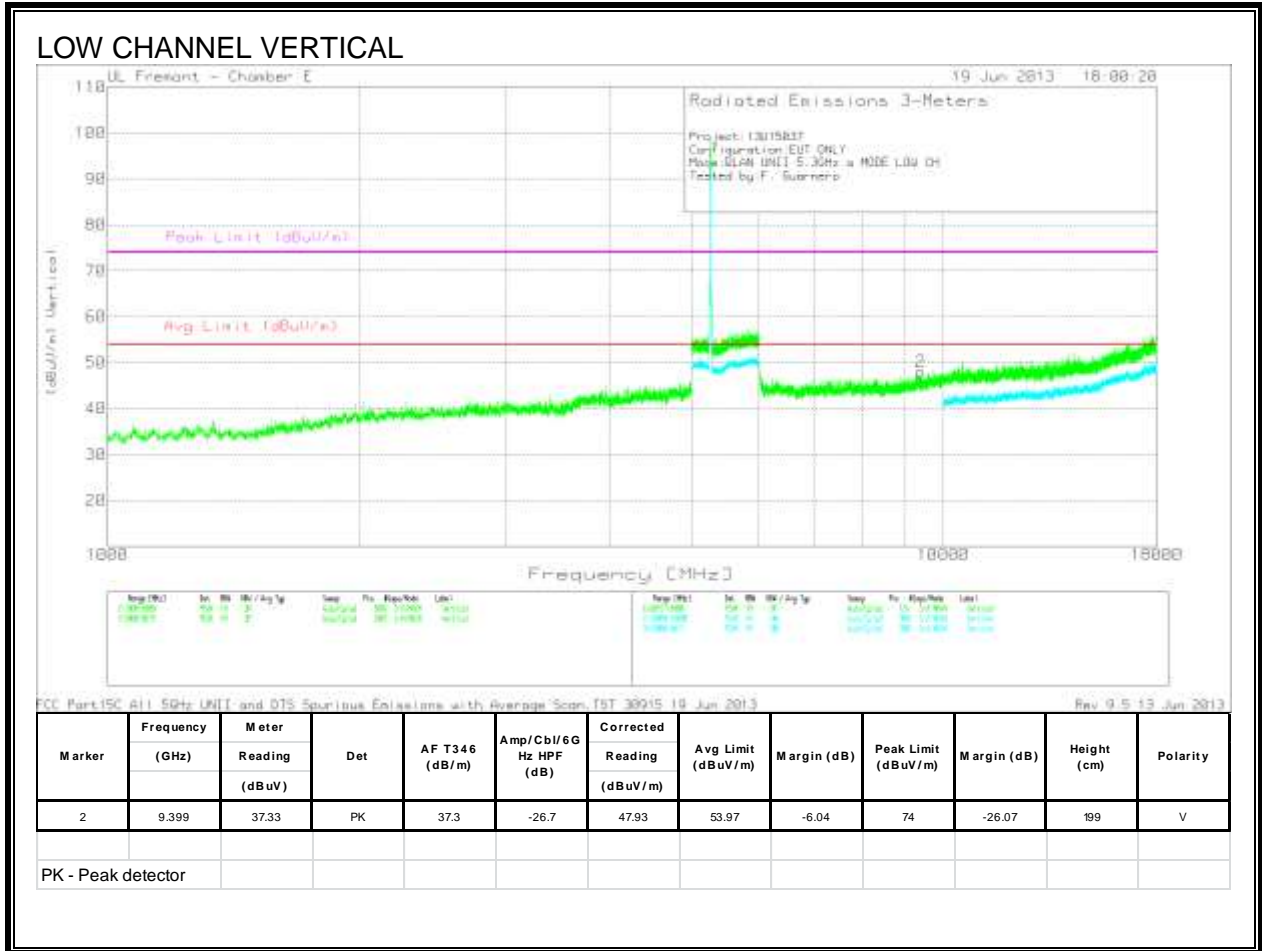

MID CHANNEL HORIZONTAL

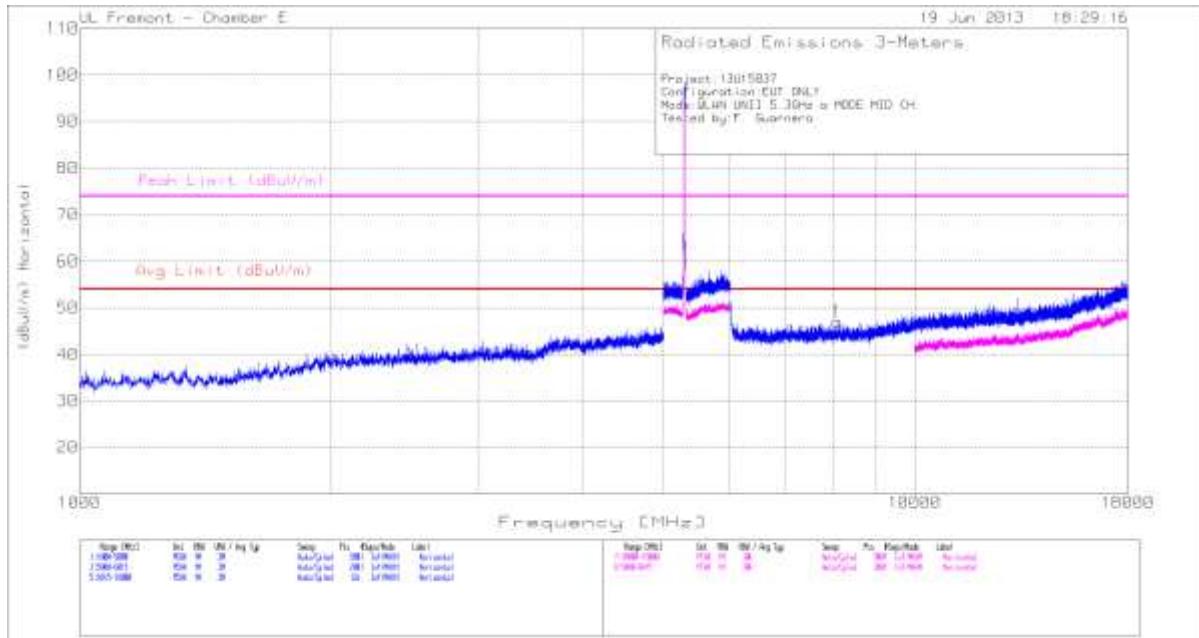

FCC Part15C B11 5GHz UNIT and DTS Spurious Emissions with Average Scan TST-3091E 19 Jun 2013 Rev 9.5 13 Jun 2013

Marker	Frequency (GHz)	Meter Reading (dBuV)	Det	AF T346 (dB/m)	Amp/Cb/6G Hz HPF (dB)	Corrected Reading (dBuV/m)	Avg Limit (dBuV/m)	Margin (dB)	Peak Limit (dBuV/m)	Margin (dB)	Height (cm)	Polarity
1	8.077	39.35	PK	36.2	-28.6	46.95	53.97	-7.02	74	-27.05	199	H

PK - Peak detector

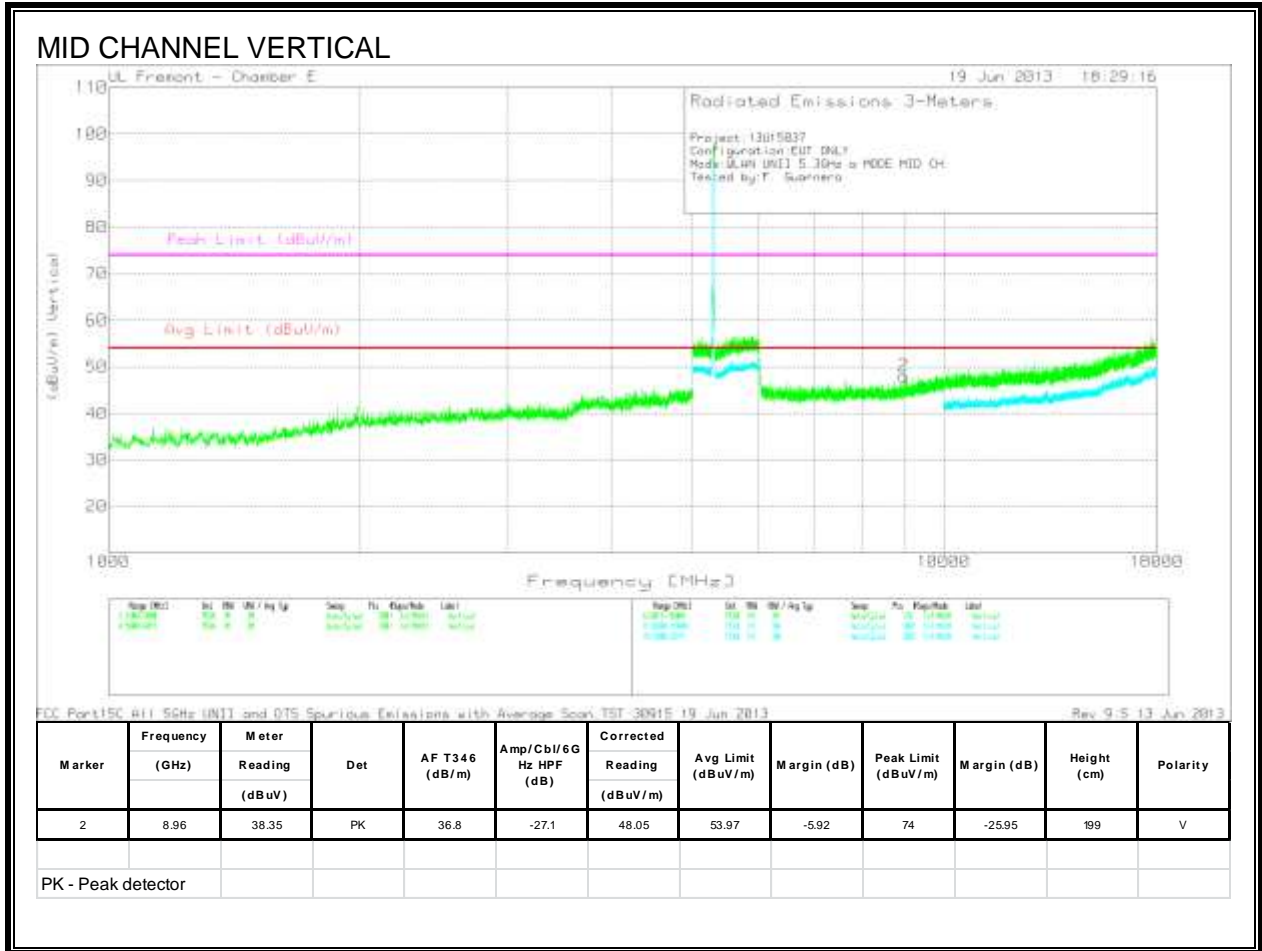

HIGH CHANNEL HORIZONTAL

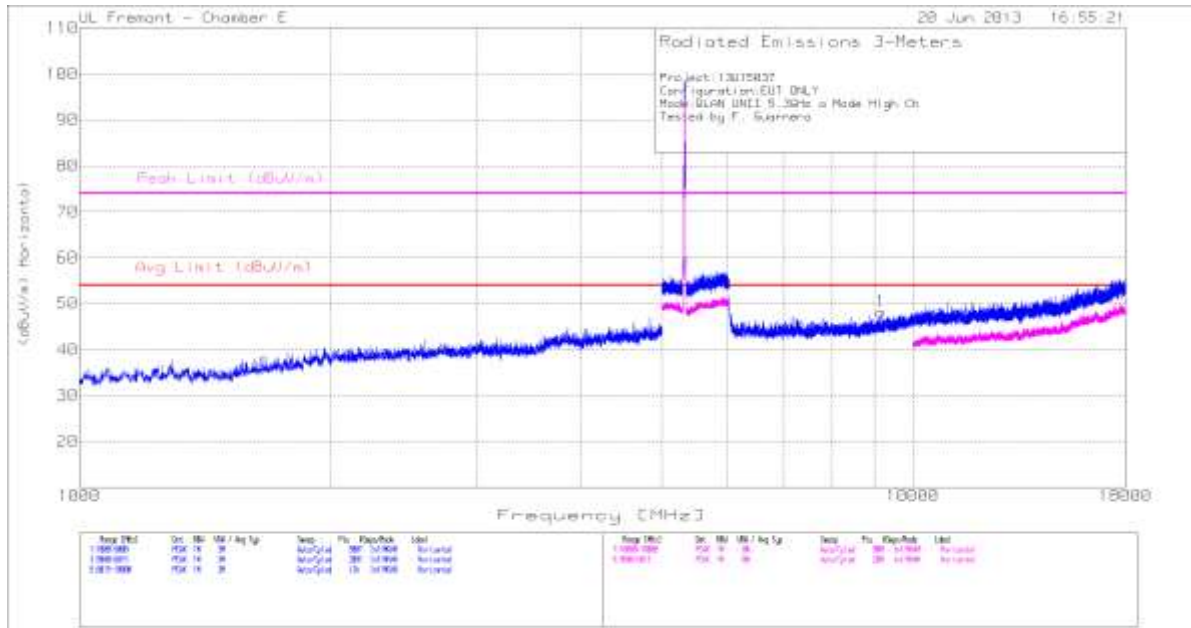

FCC Part 15C All 5GHz UNII and DFS Spurious Emissions with Average Spwr TST 30015 10 Jun 2013 Rev 9.5 13 Jun 2013

Marker	Frequency (GHz)	Meter	Det	AF T346 (dB/m)	Amp/Cb/6G Hz HPF (dB)	Corrected	Avg Limit (dBuV/m)	Margin (dB)	Peak Limit (dBuV/m)	Margin (dB)	Height (cm)	Polarity
		Reading (dBuV)				Reading (dBuV/m)						
1	9.56	38.21	PK	37	-27	48.21	53.97	-5.76	74	-25.79	199	H

PK - Peak detector

### HIGH CHANNEL VERTICAL

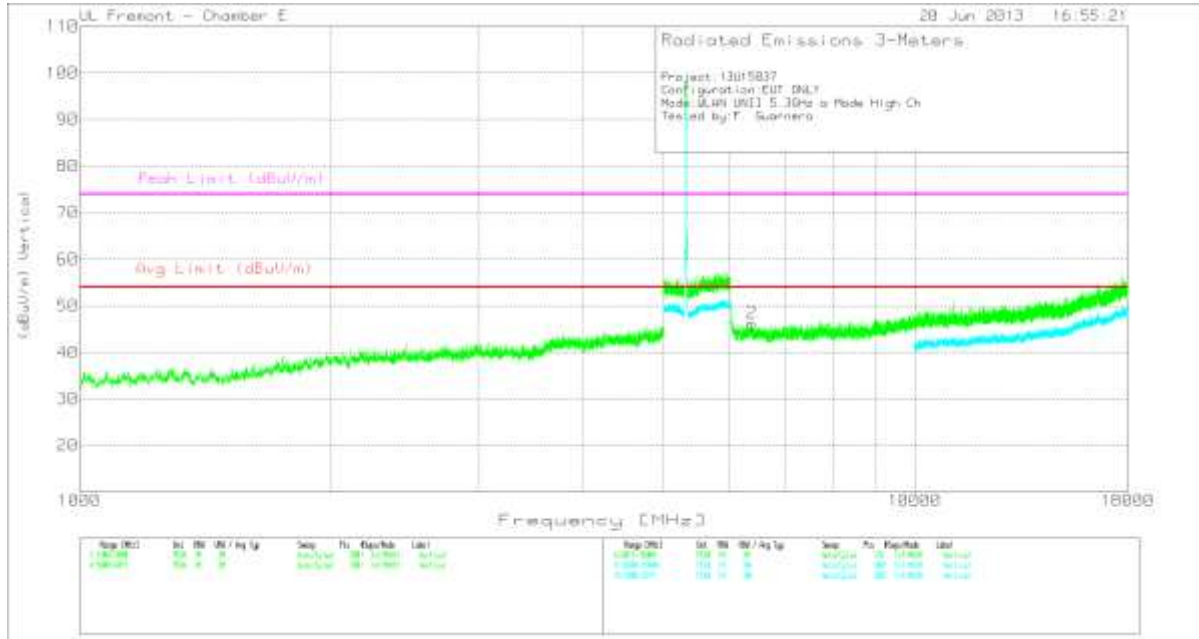

FCC Part 15C (1) 5GHz (UNII) and DTS Spurious Emissions with Average Scan TST-30915 19 Jun 2013 Rev 9.5 13 Jun 2013

Marker	Frequency (GHz)	Meter Reading (dBuV)	Det	AF T346 (dB/m)	Amp/Cb/6G Hz HPF (dB)	Corrected Reading (dBuV/m)	Avg Limit (dBuV/m)	Margin (dB)	Peak Limit (dBuV/m)	Margin (dB)	Height (cm)	Polarity
2	6.385	40.14	PK	35.8	-29.7	46.24	53.97	-7.73	74	-27.76	199	V

PK - Peak detector

### 9.2.5. TX ABOVE 1 GHz 802.11n HT20 MODE IN THE 5.3 GHz BAND

#### RESTRICTED BANDEDGE (HIGH CHANNEL)

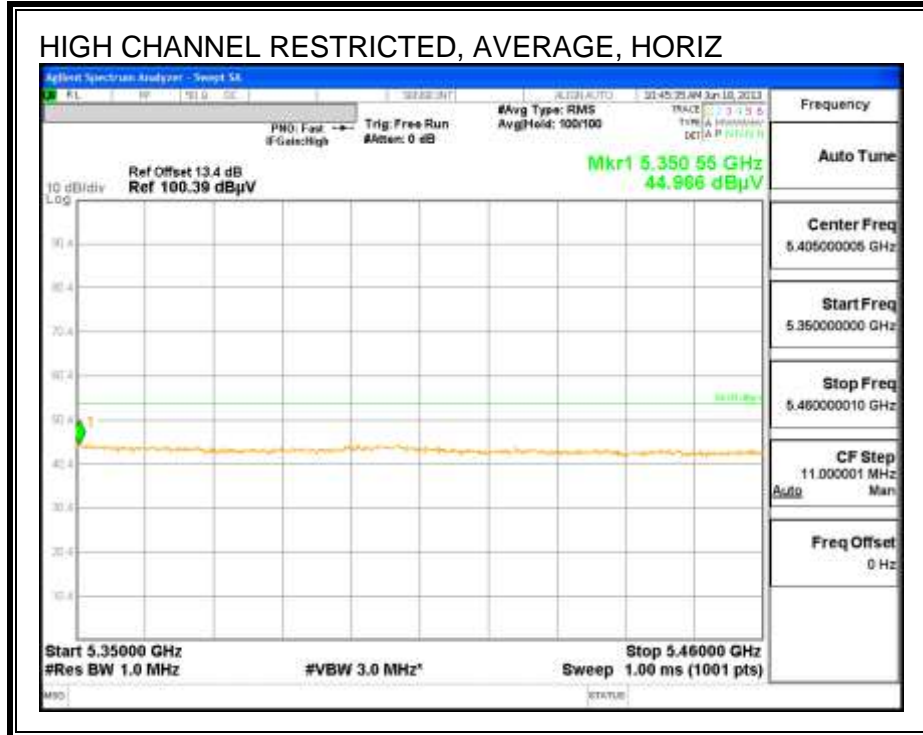
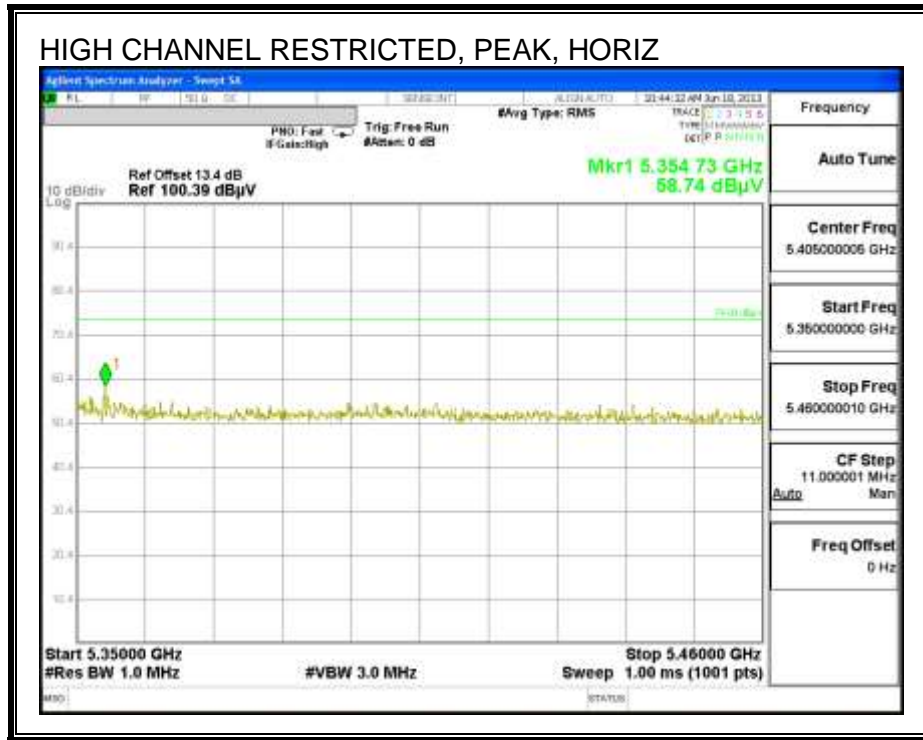



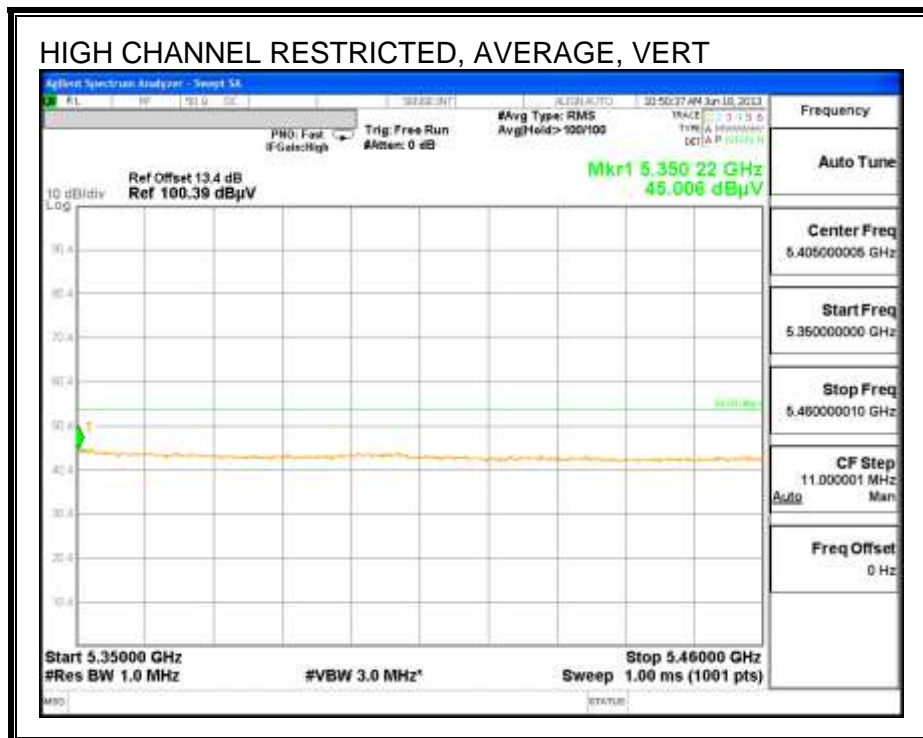
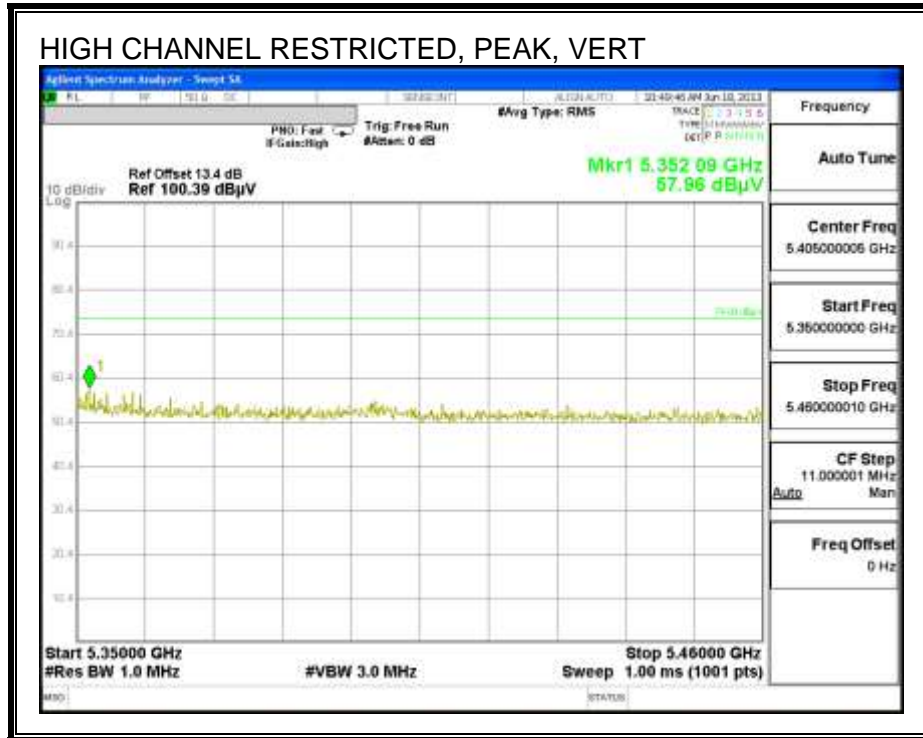

**HARMONICS AND SPURIOUS EMISSIONS**

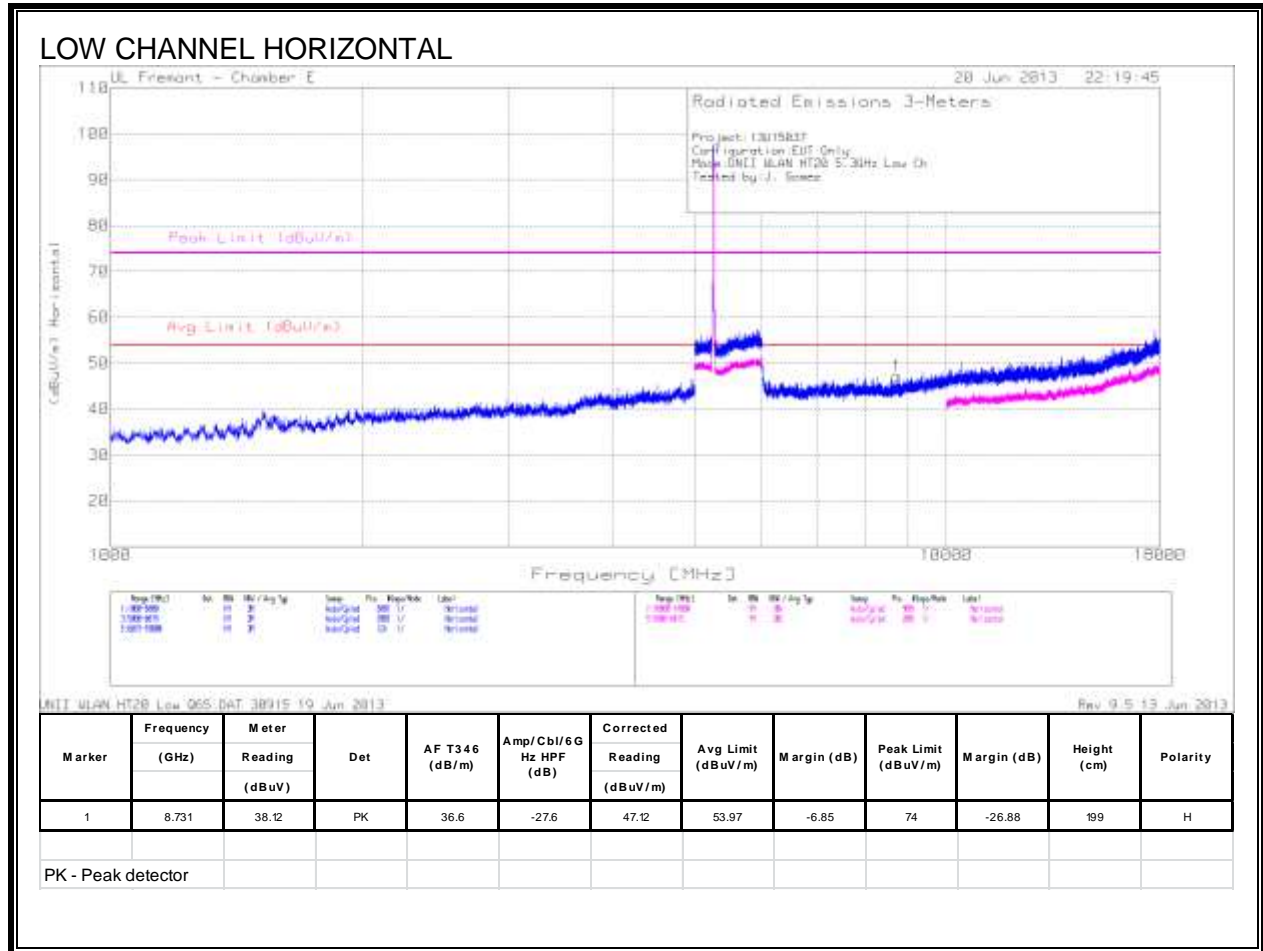

LOW CHANNEL VERTICAL

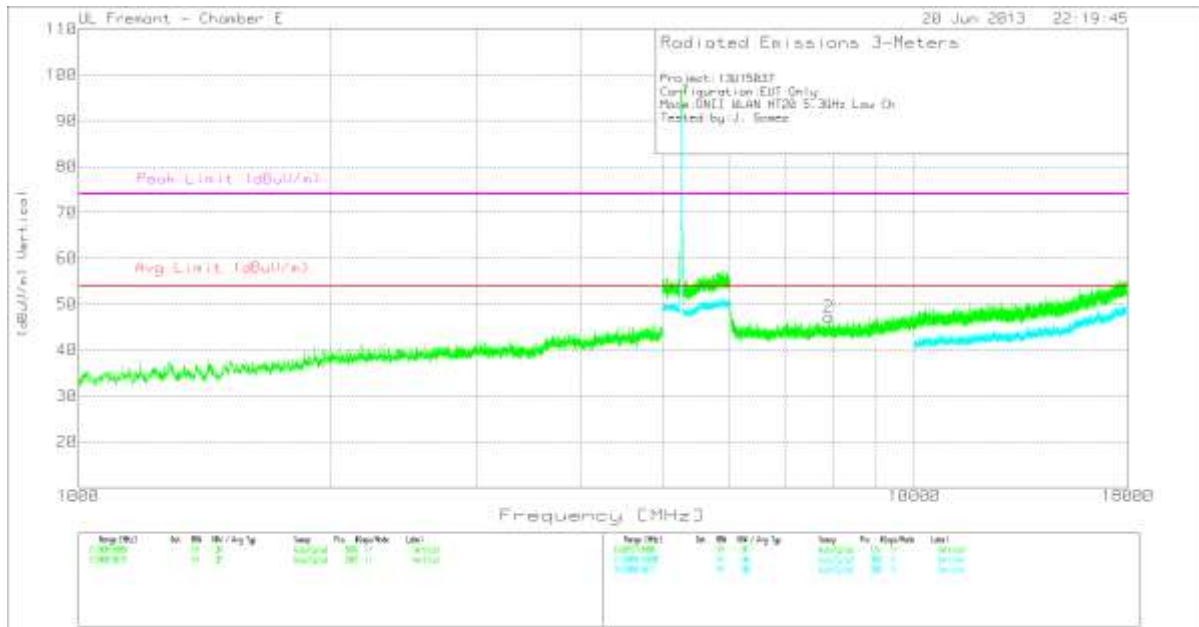

MIIT\_MLAN\_HT20\_Low\_QSS\_GAT\_38915\_19\_Jun\_2013  
 Rev: 9.5\_13 Jun 2013

Marker	Frequency (GHz)	Meter	Det	AF T346 (dB/m)	Amp/Cbl/6G Hz HPF (dB)	Corrected	Avg Limit (dBuV/m)	Margin (dB)	Peak Limit (dBuV/m)	Margin (dB)	Height (cm)	Polarity
		Reading (dBuV)				Reading (dBuV/m)						
2	7.899	39.24	PK	36.2	-28.3	47.14	53.97	-6.83	74	-26.86	199	V

PK - Peak detector

MID CHANNEL HORIZONTAL

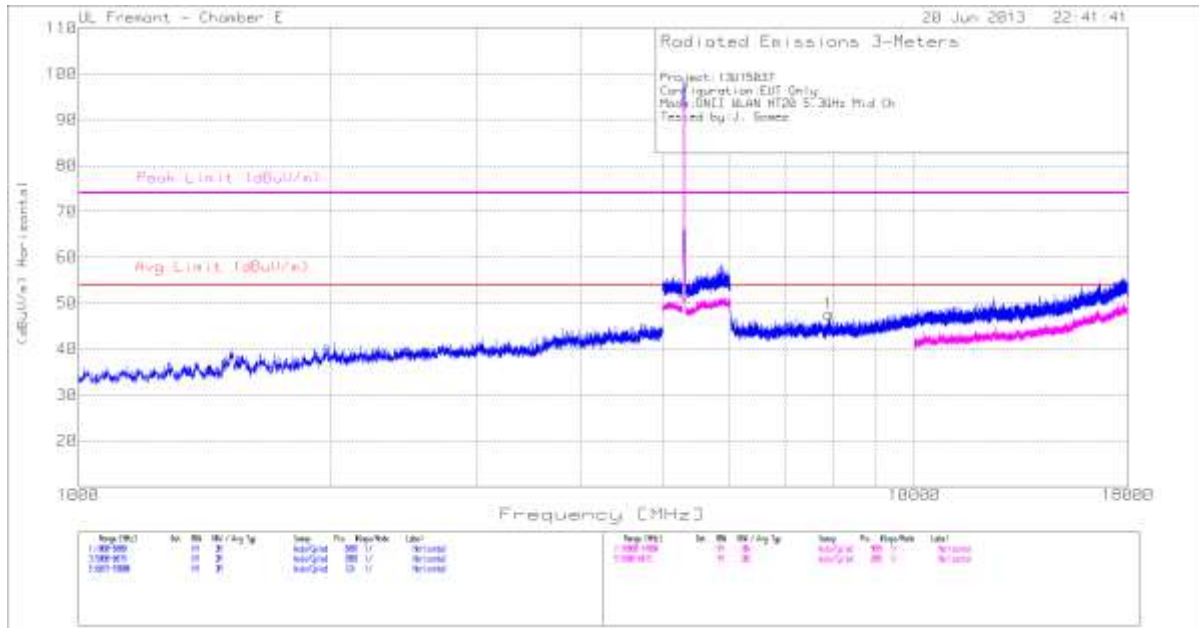

TST 30015 10 Jun 2013 Rev: 0.5 13 Jun 2013

Marker	Frequency (GHz)	Meter	Det	AF T346 (dB/m)	Amp/Cbl/6G Hz HPF (dB)	Corrected	Avg Limit (dBuV/m)	Margin (dB)	Peak Limit (dBuV/m)	Margin (dB)	Height (cm)	Polarity
		Reading (dBuV)				Reading (dBuV/m)						
1	7.903	39.62	PK	36.2	-28.2	47.62	53.97	-6.35	74	-26.38	199	H

PK - Peak detector

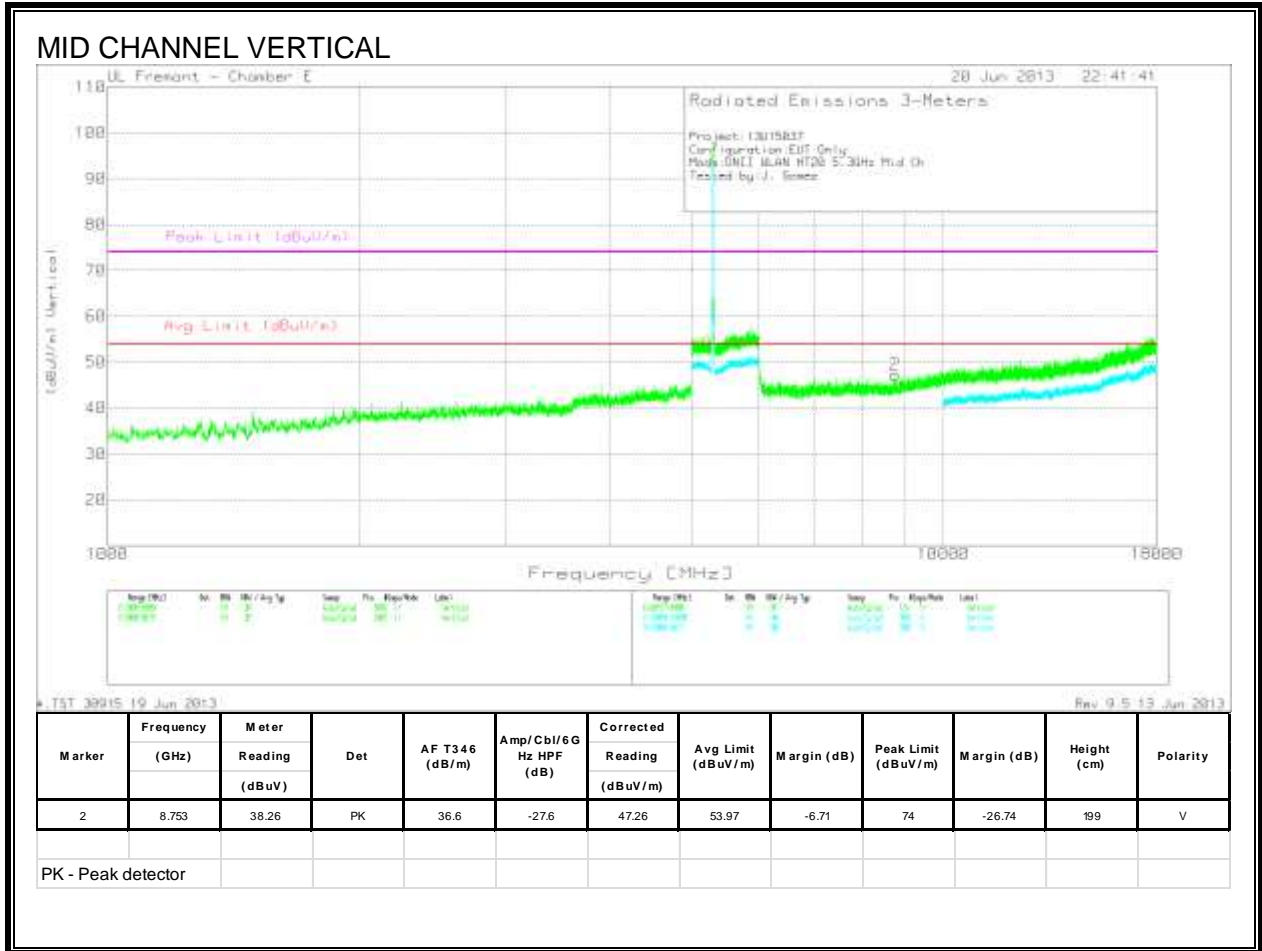

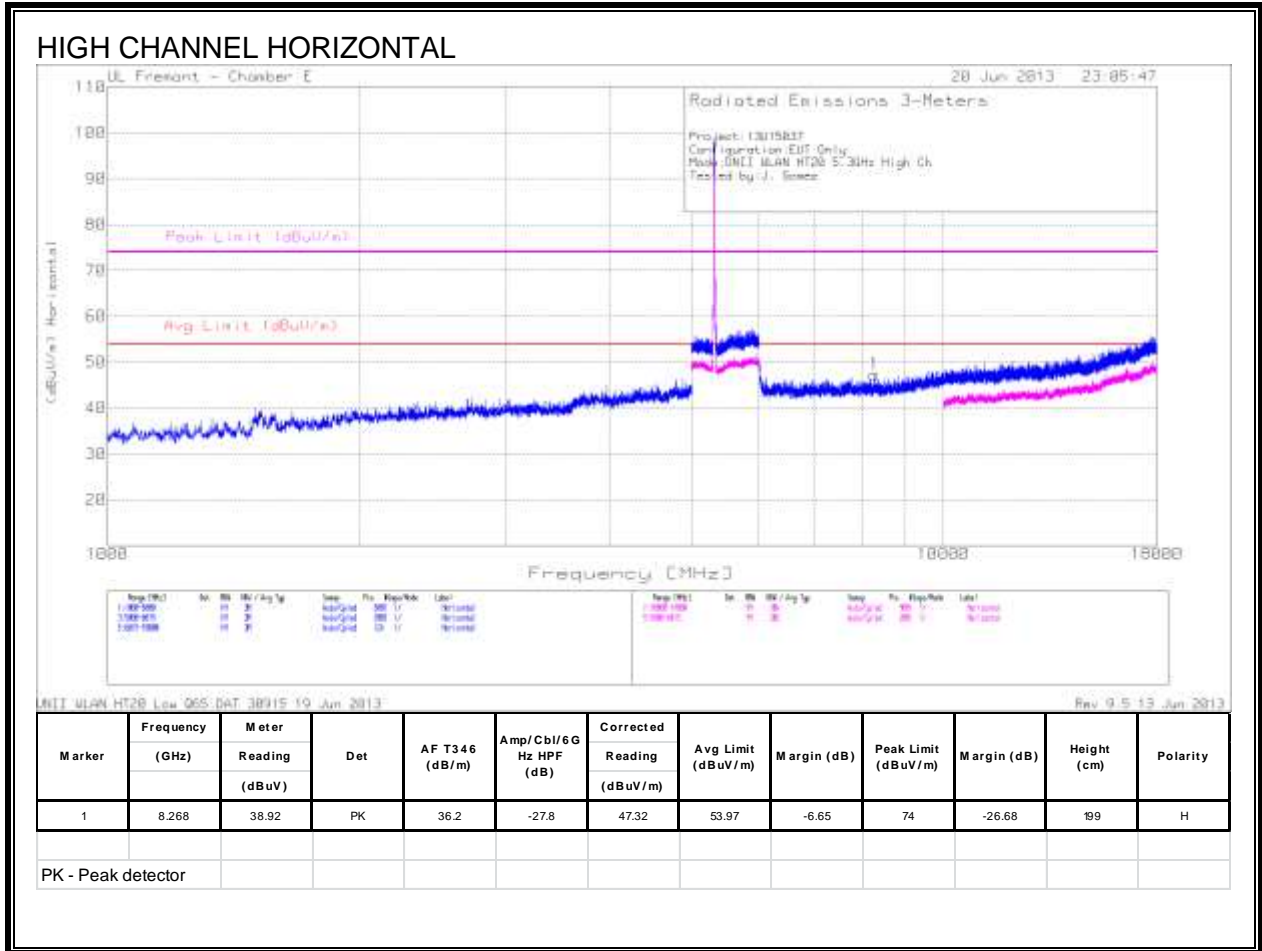

HIGH CHANNEL VERTICAL

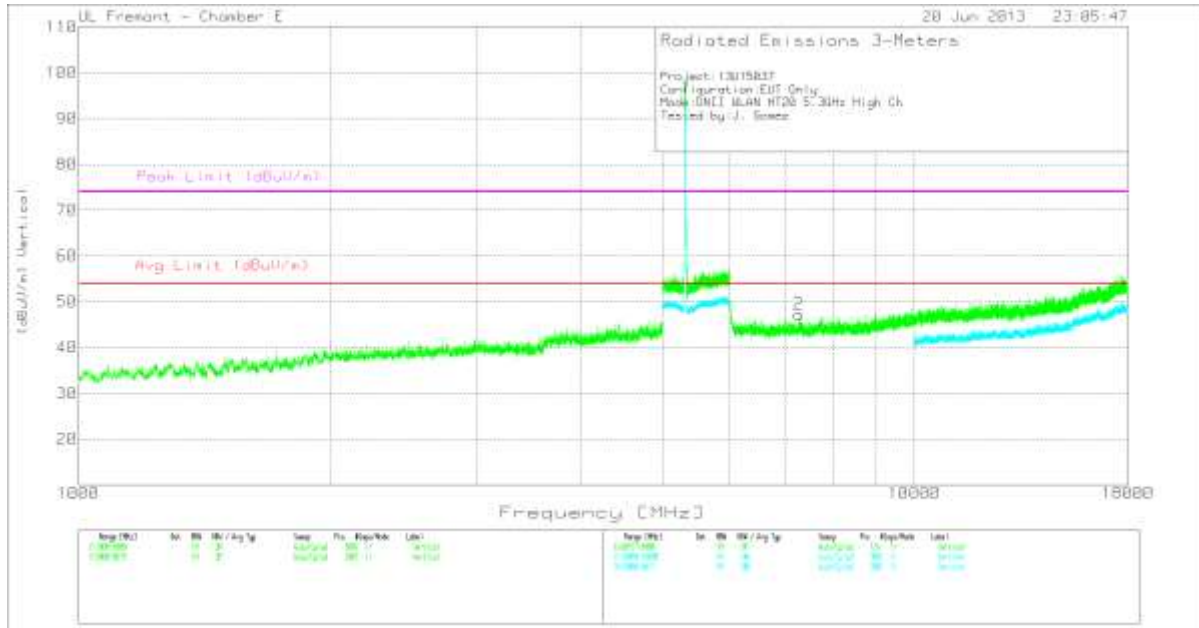

MIAN HT28 Low Q65 DAT: 38915 19 Jun 2013 Rev: 9.5 13 Jun 2013

Marker	Frequency (GHz)	Meter	Det	AF T346 (dB/m)	Amp/Cb/6G Hz HPF (dB)	Corrected	Avg Limit (dBuV/m)	Margin (dB)	Peak Limit (dBuV/m)	Margin (dB)	Height (cm)	Polarity
		Reading (dBuV)				Reading (dBuV/m)						
2	7.272	40.16	PK	36	-28.9	47.26	53.97	-6.71	74	-26.74	199	V

PK - Peak detector

### 9.2.6. TX ABOVE 1 GHz 802.11n HT40 MODE IN THE 5.3 GHz BAND

#### RESTRICTED BANDEDGE (HIGH CHANNEL)

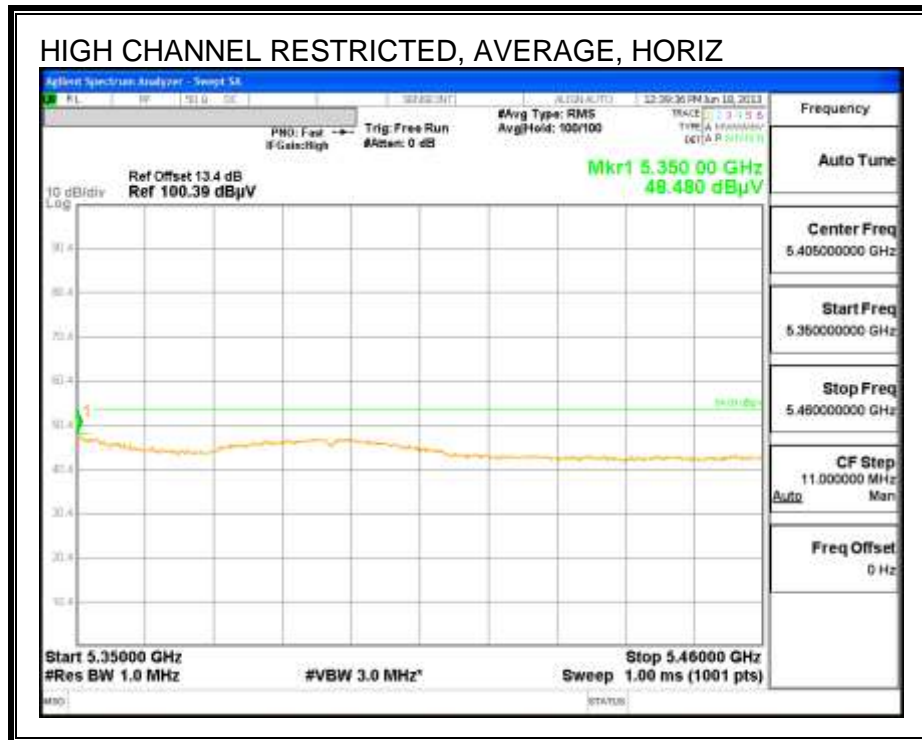
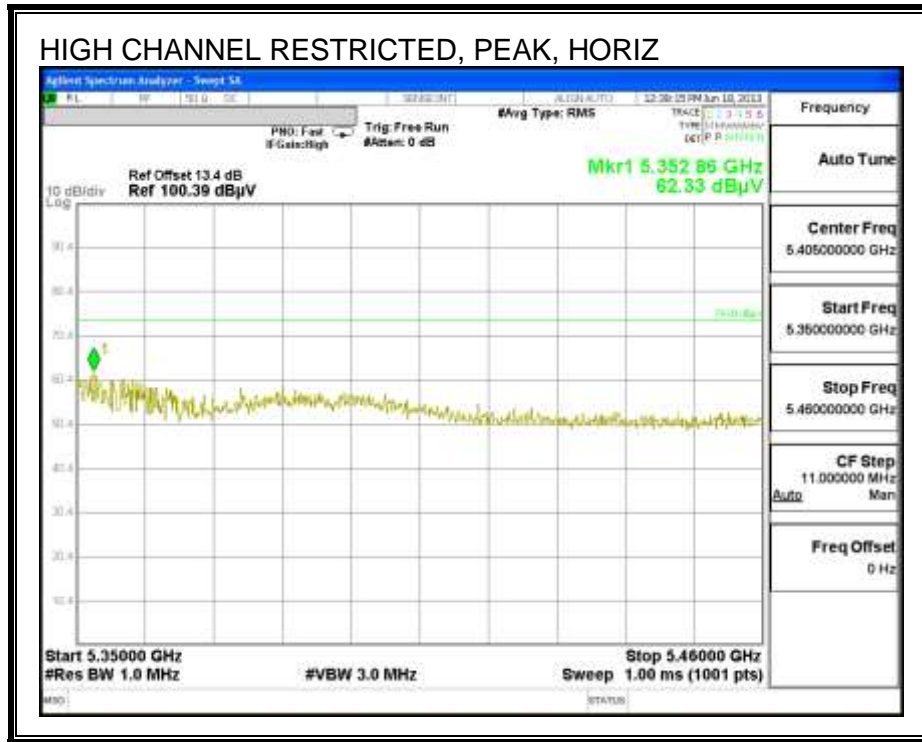



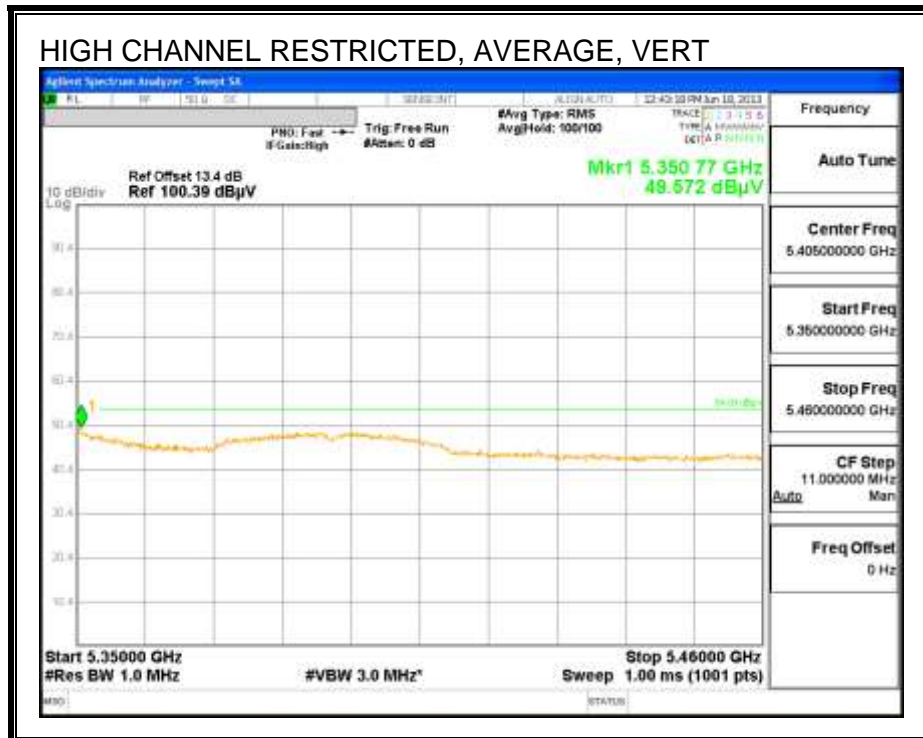
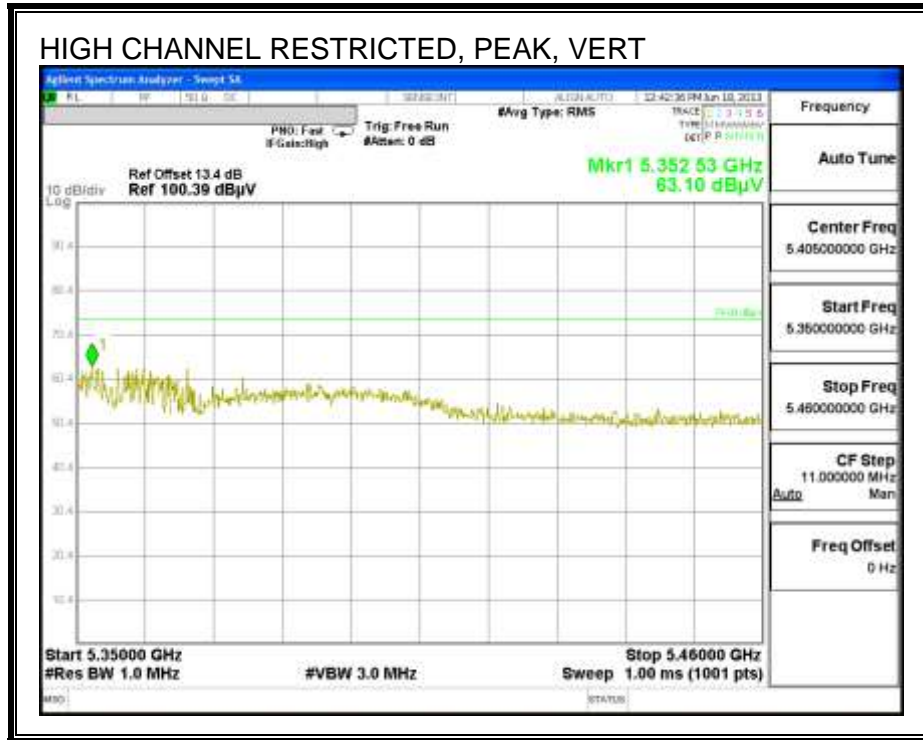

**HARMONICS AND SPURIOUS EMISSIONS**

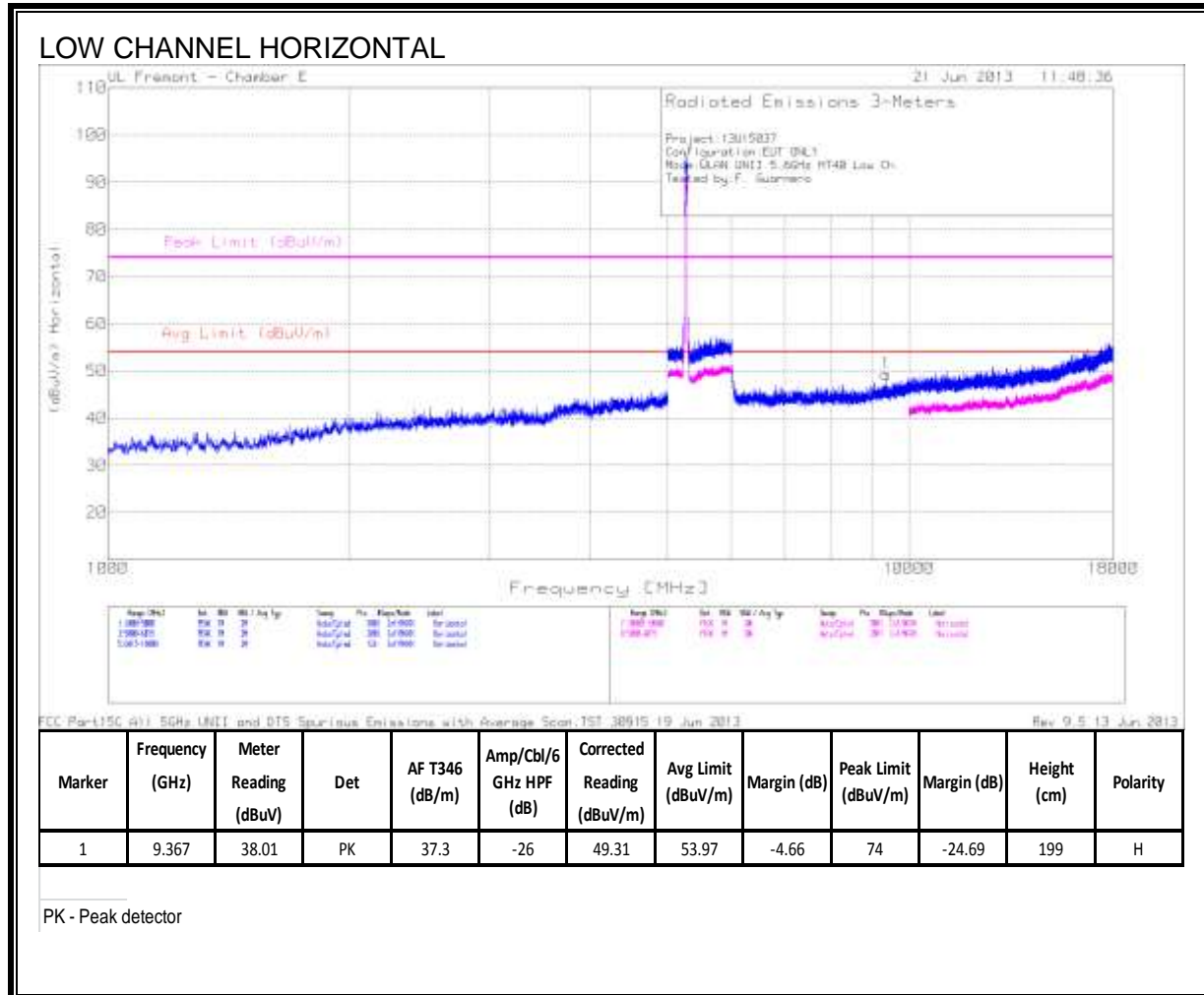

LOW CHANNEL VERTICAL

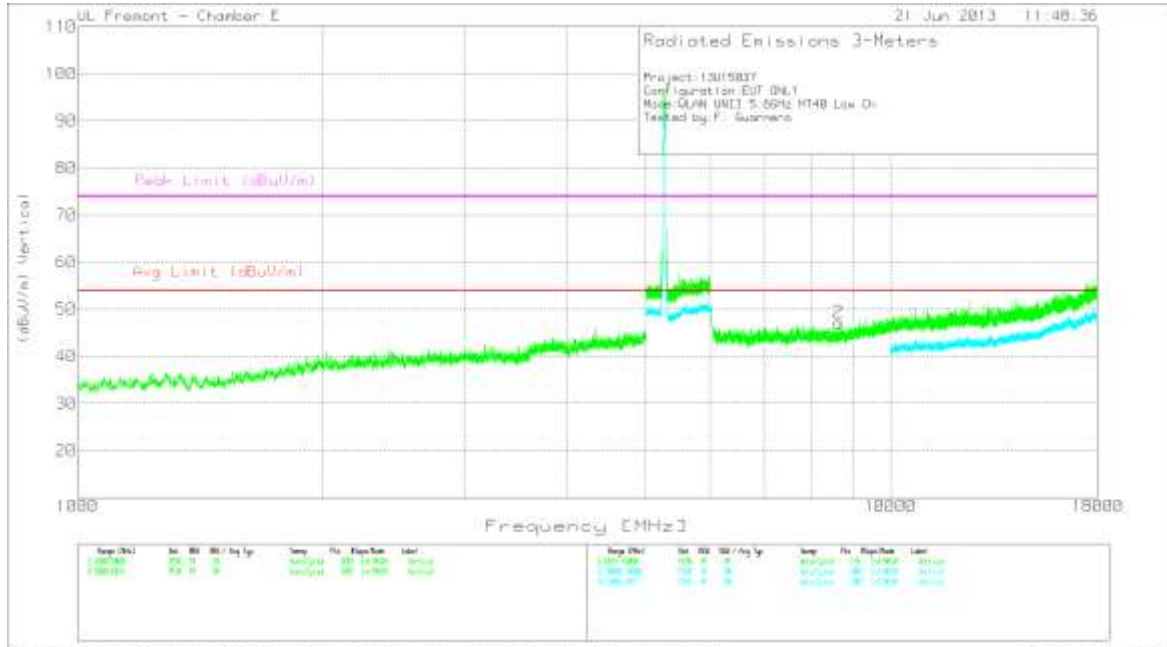

ETC Part 15C @ 1500 MHz UNII and DTS Spurious Emissions with Average Span TST 20115 19 Jun 2013 Rev: 9.6 (3 Jun 2013)

Marker	Frequency (GHz)	Meter Reading (dBuV)	Det	AF T346 (dB/m)	Amp/Cbl/6 GHz HPF (dB)	Corrected Reading (dBuV/m)	Avg Limit (dBuV/m)	Margin (dB)	Peak Limit (dBuV/m)	Margin (dB)	Height (cm)	Polarity
2	8.635	38.27	PK	36.4	-27.5	47.17	53.97	-6.8	74	-26.83	199	V

PK - Peak detector

HIGH CHANNEL HORIZONTAL

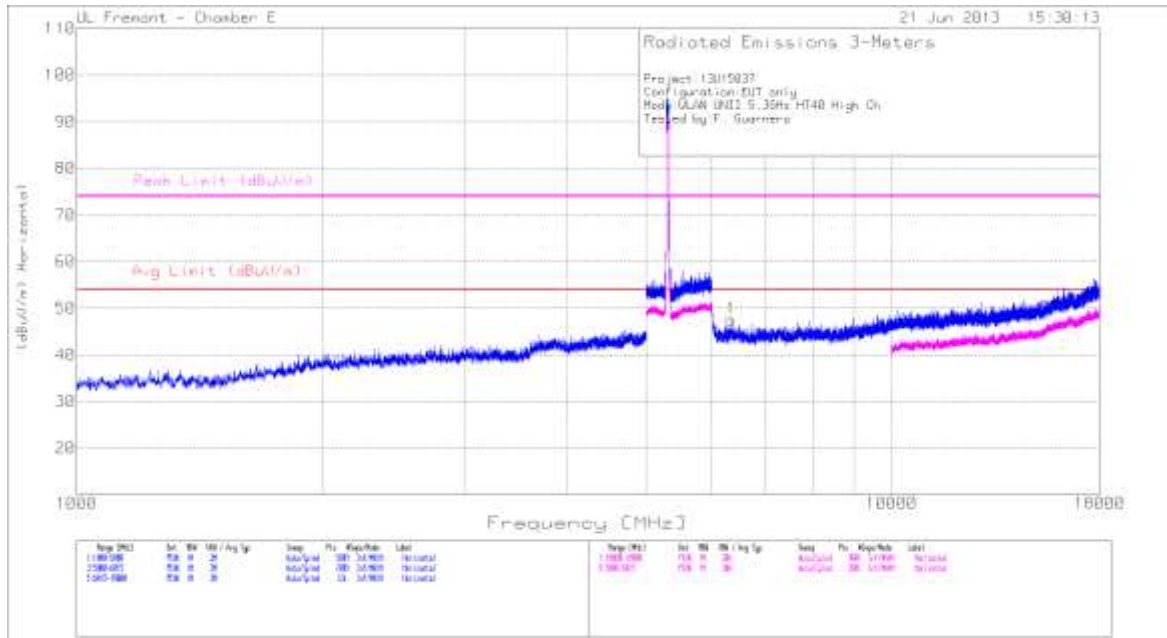

FCC Part 15C 411.5GHz UNIT and OTS Spurious Emissions with Average Scan TST 38615 19 Jun 2013

Rev: 0.5 13 Jun 2013

Marker	Frequency (GHz)	Meter Reading (dBuV)	Det	AF T346 (dB/m)	Amp/Cbl/6 GHz HPF (dB)	Corrected Reading (dBuV/m)	Avg Limit (dBuV/m)	Margin (dB)	Peak Limit (dBuV/m)	Margin (dB)	Height (cm)	Polarity
1	6.355	40.72	PK	35.9	-29	47.62	53.97	-6.35	74	-26.38	199	H

PK - Peak detector

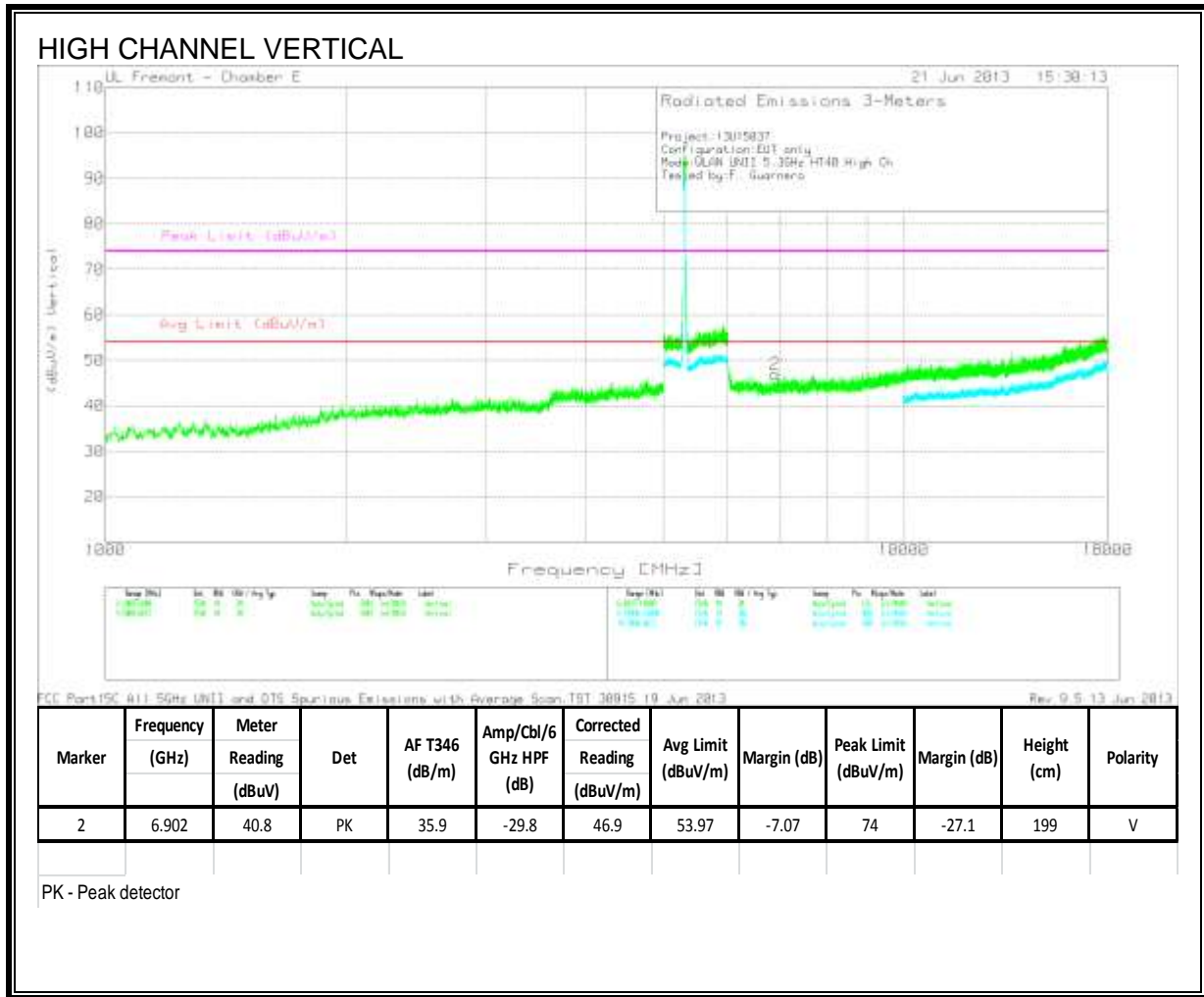

### 9.2.7. TX ABOVE 1 GHz 802.11a MODE IN THE 5.6 GHz BAND

#### RESTRICTED & AUTHORIZED BANDEDGE (LOW CHANNEL)

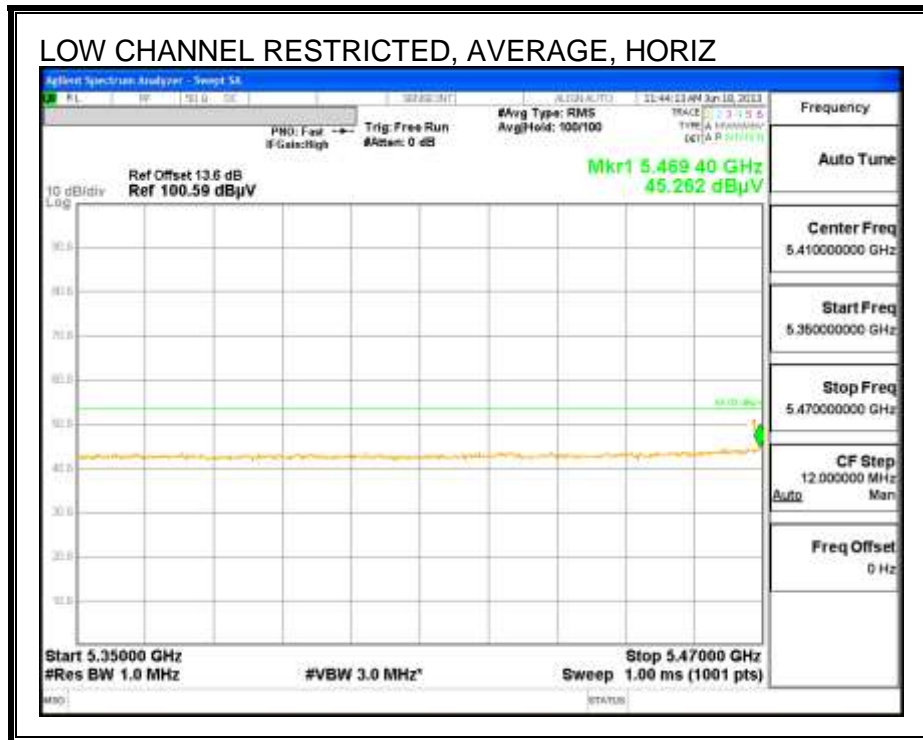
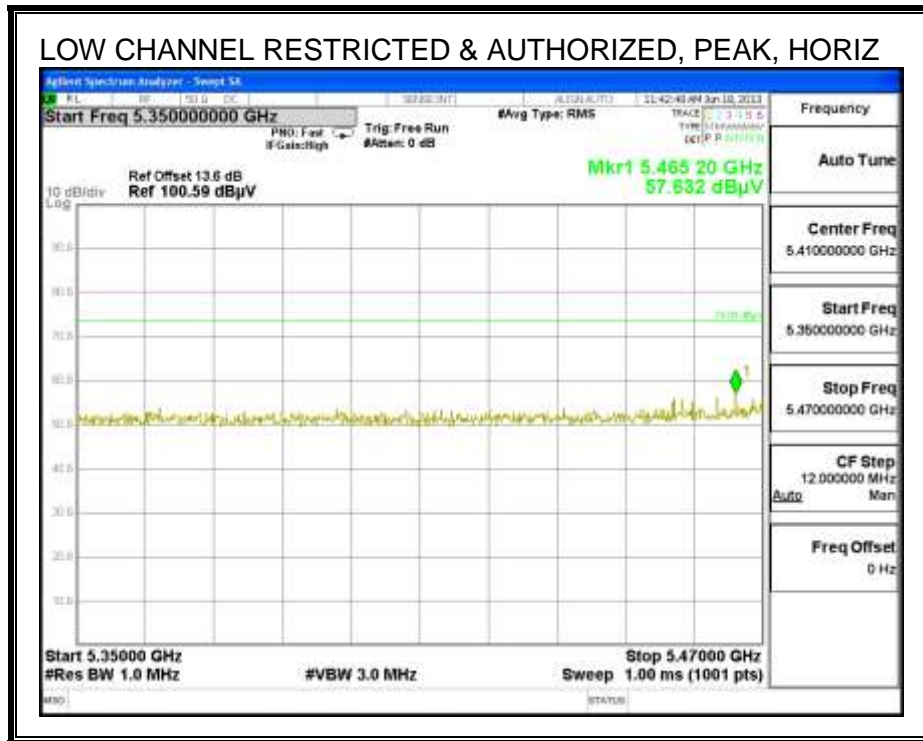

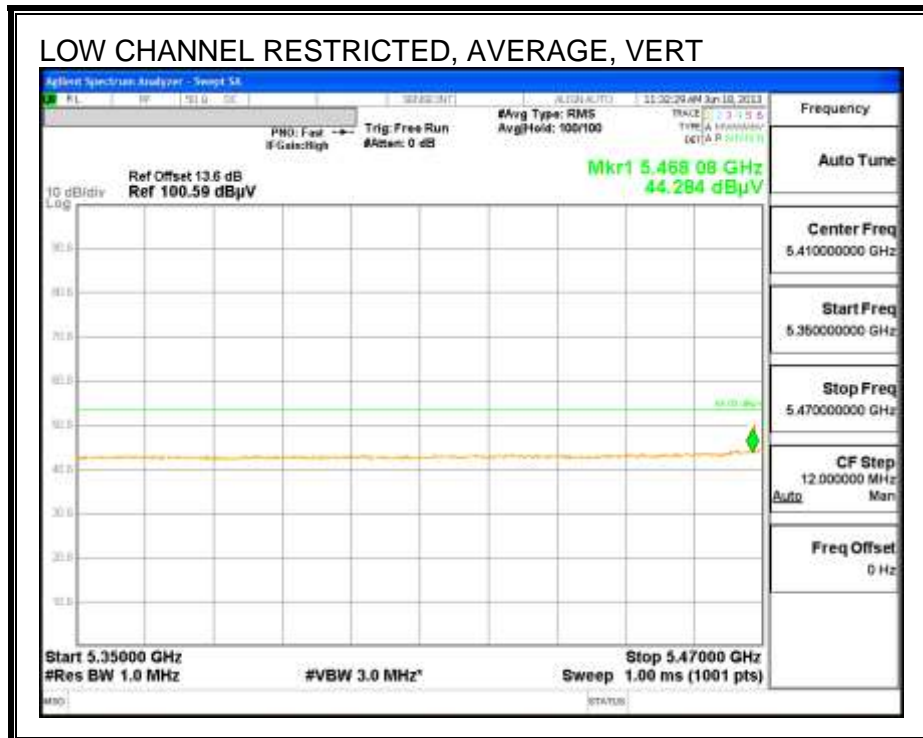
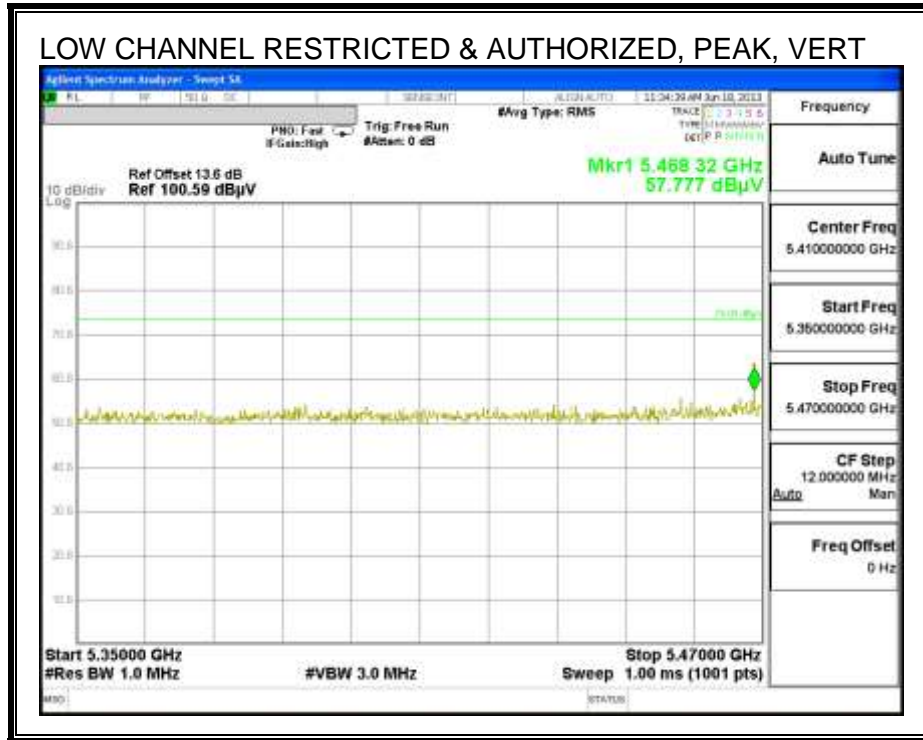

**AUTHORIZED BANDEDGE (HIGH CHANNEL)**

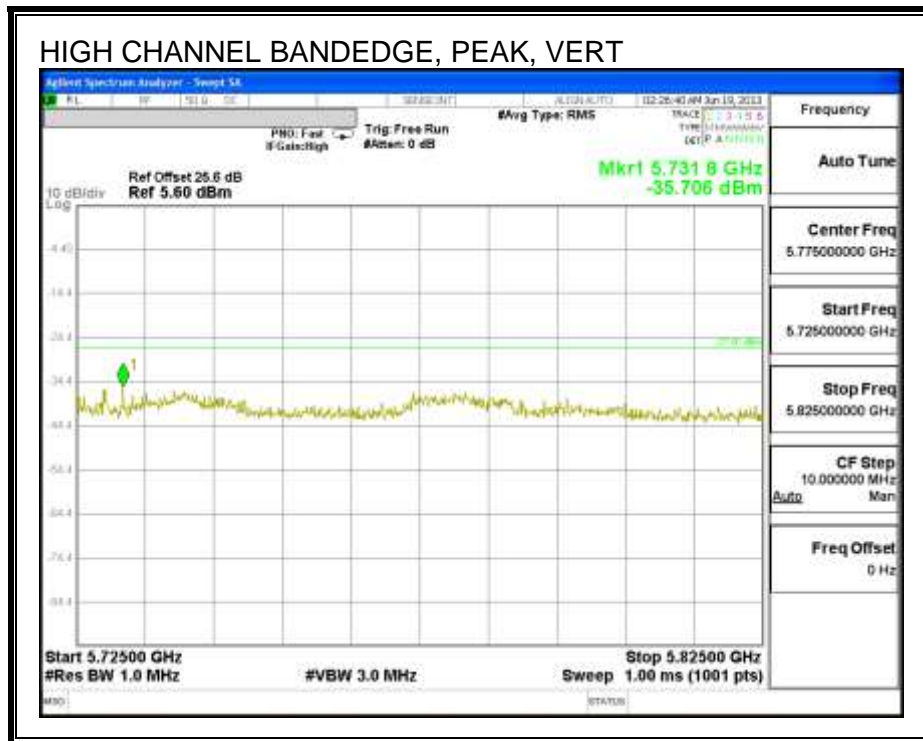
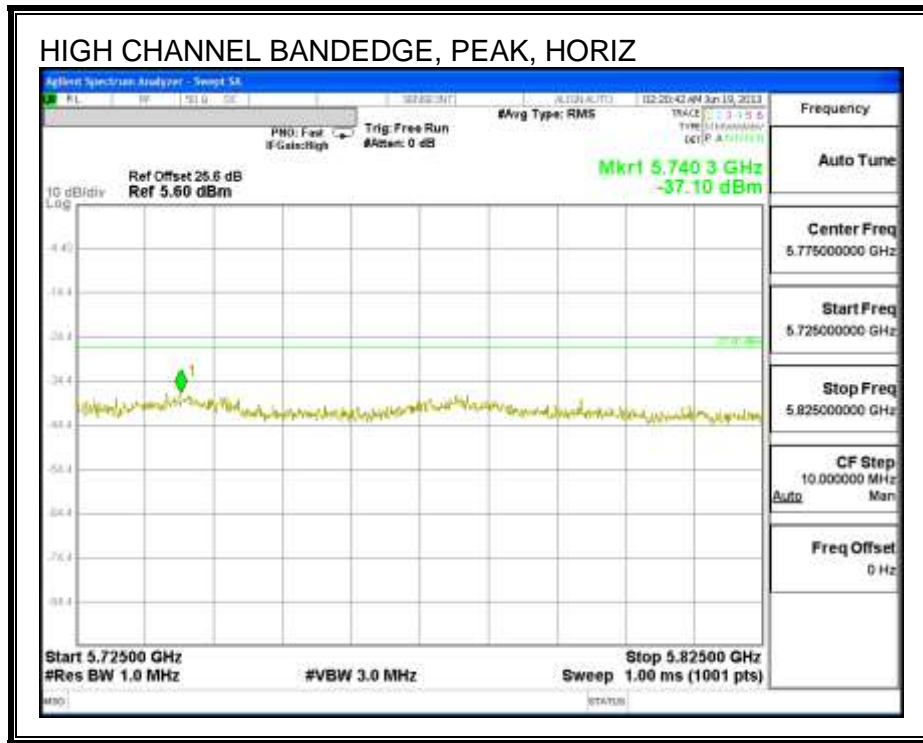



**HARMONICS AND SPURIOUS EMISSIONS**

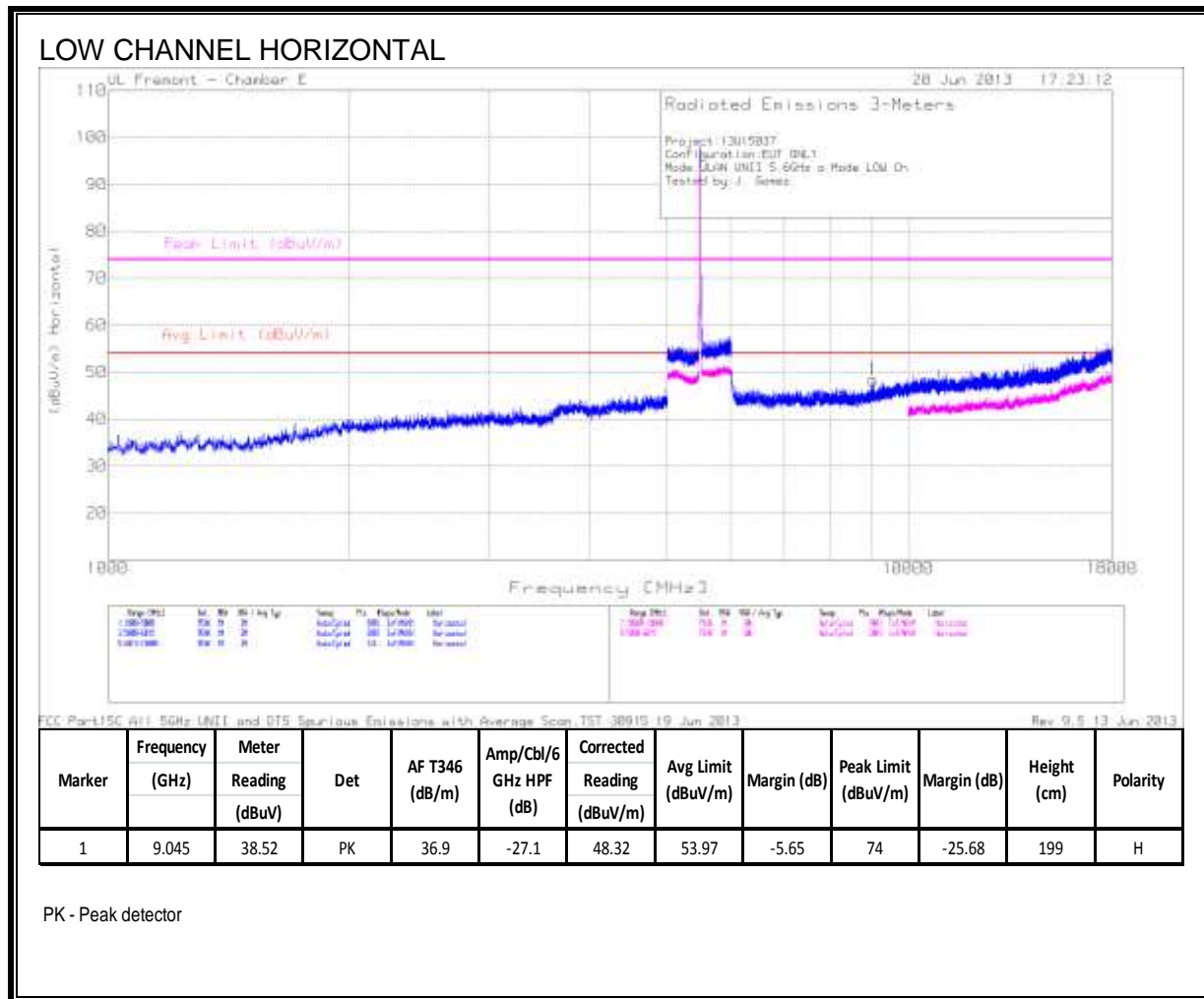

LOW CHANNEL VERTICAL

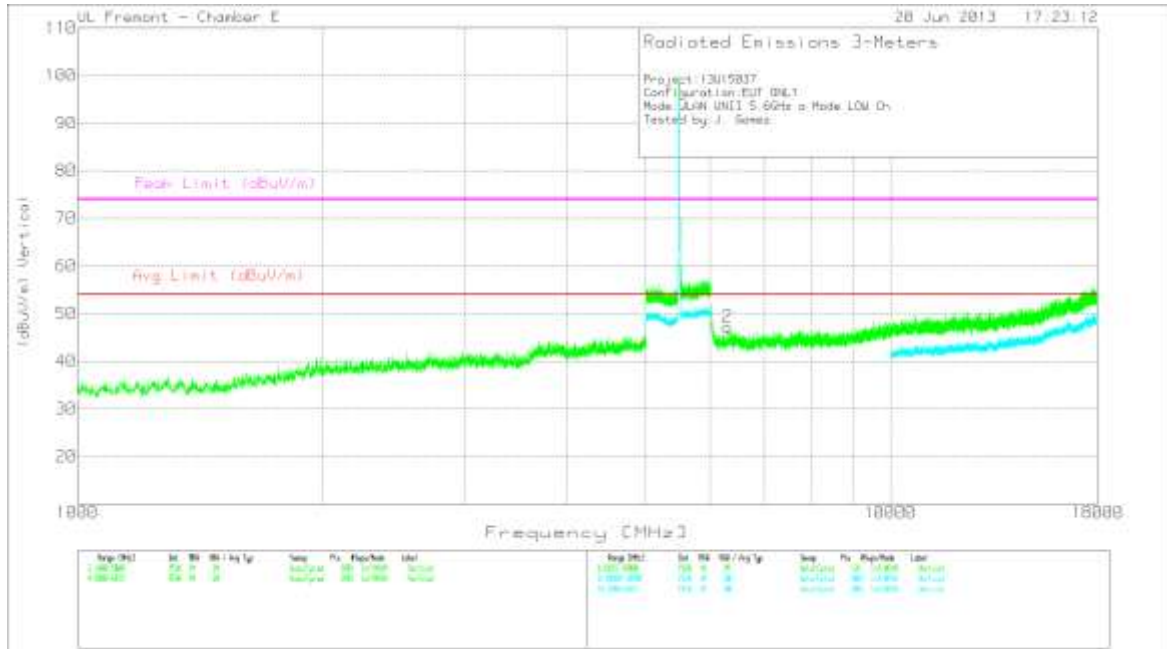

FCC Part 15C (47) 5GHz UNII and DTS Spurious Emissions with Average Scan, TST 38915, 19 Jun 2013 Rev: 9.5, 13 Jun 2013

Marker	Frequency (GHz)	Meter	Det	AF T346 (dB/m)	Amp/Cbl/6 GHz HPF (dB)	Corrected	Avg Limit (dBuV/m)	Margin (dB)	Peak Limit (dBuV/m)	Margin (dB)	Height (cm)	Polarity
		Reading (dBuV)				Reading (dBuV/m)						
2	6.304	40.58	PK	35.9	-29.4	47.08	53.97	-6.89	74	-26.92	199	V

PK - Peak detector

MID CHANNEL HORIZONTAL

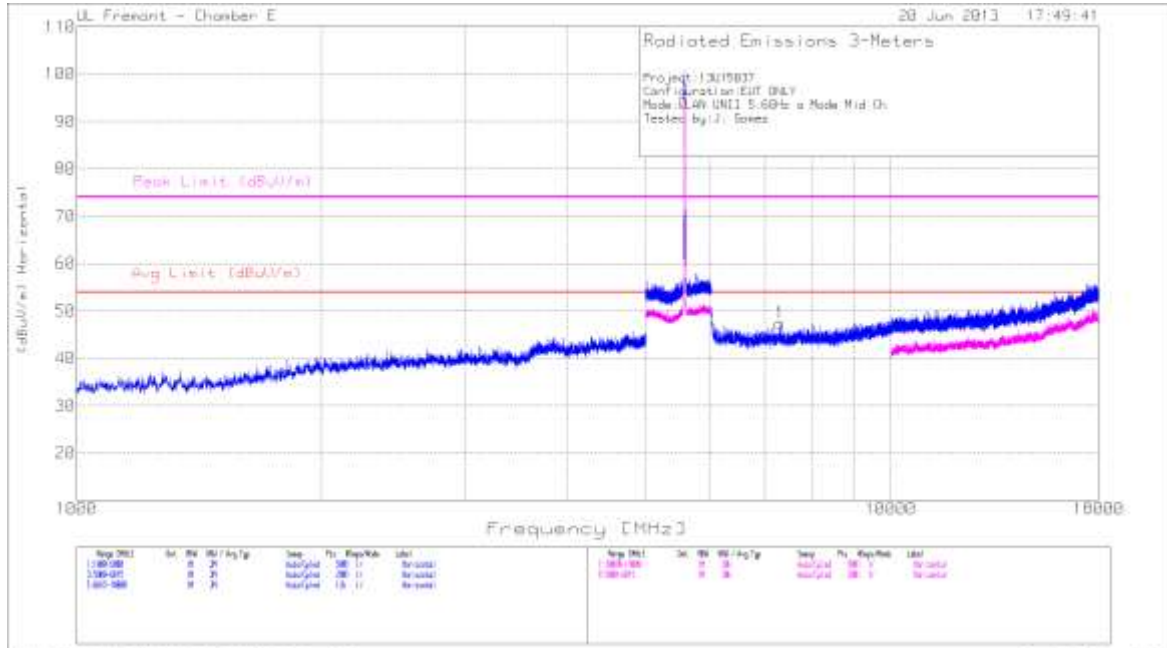

ULW UNIT @ MODE MID 067.DWT 200915 19 Jun 2013 Rev: 9.5 13 Jun 2013

Marker	Frequency (GHz)	Meter Reading (dBuV)	Det	AF T346 (dB/m)	Amp/Cbl/6 GHz HPF (dB)	Corrected Reading (dBuV/m)	Avg Limit (dBuV/m)	Margin (dB)	Peak Limit (dBuV/m)	Margin (dB)	Height (cm)	Polarity
1	7.304	40.18	PK	36	-28.8	47.38	53.97	-6.59	74	-26.62	199	H

PK - Peak detector

MID CHANNEL VERTICAL

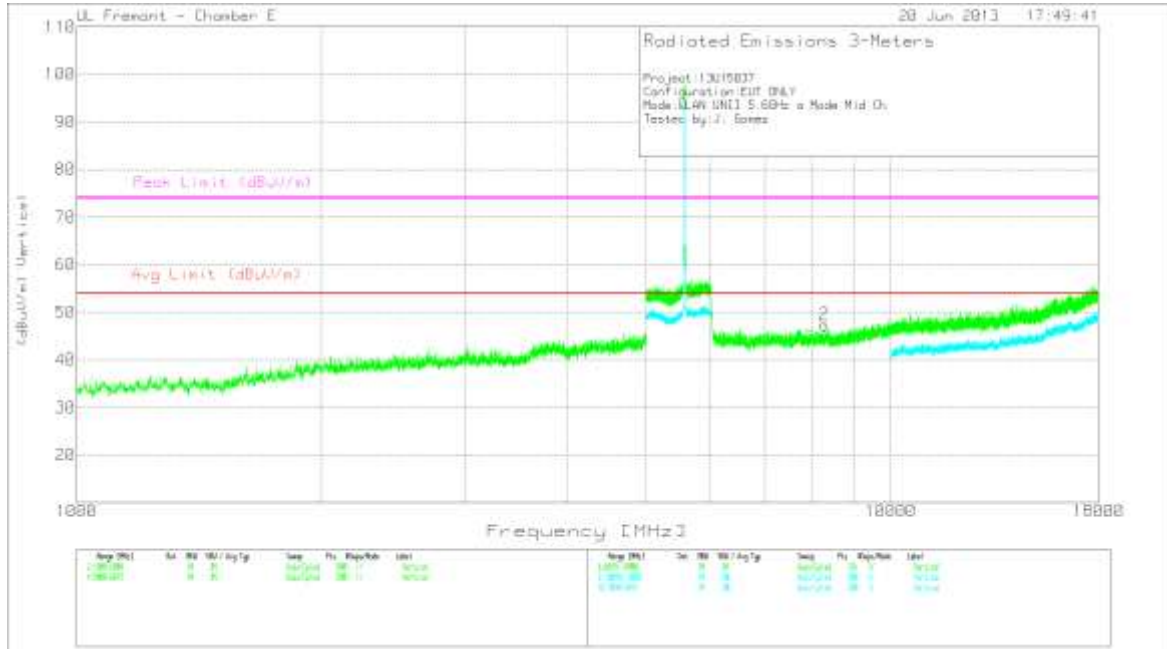

ULAN UNIT @ MODE MID 067.DAT 30915 10 Jun 2013 Rev: 9.5 13 Jun 2013

Marker	Frequency (GHz)	Meter	Det	AF T346 (dB/m)	Amp/Cbl/6 GHz HPF (dB)	Corrected	Avg Limit (dBuV/m)	Margin (dB)	Peak Limit (dBuV/m)	Margin (dB)	Height (cm)	Polarity
		Reading (dBuV)				Reading (dBuV/m)						
2	8.287	38.91	PK	36.2	-27.8	47.31	53.97	-6.66	74	-26.69	199	V

PK - Peak detector

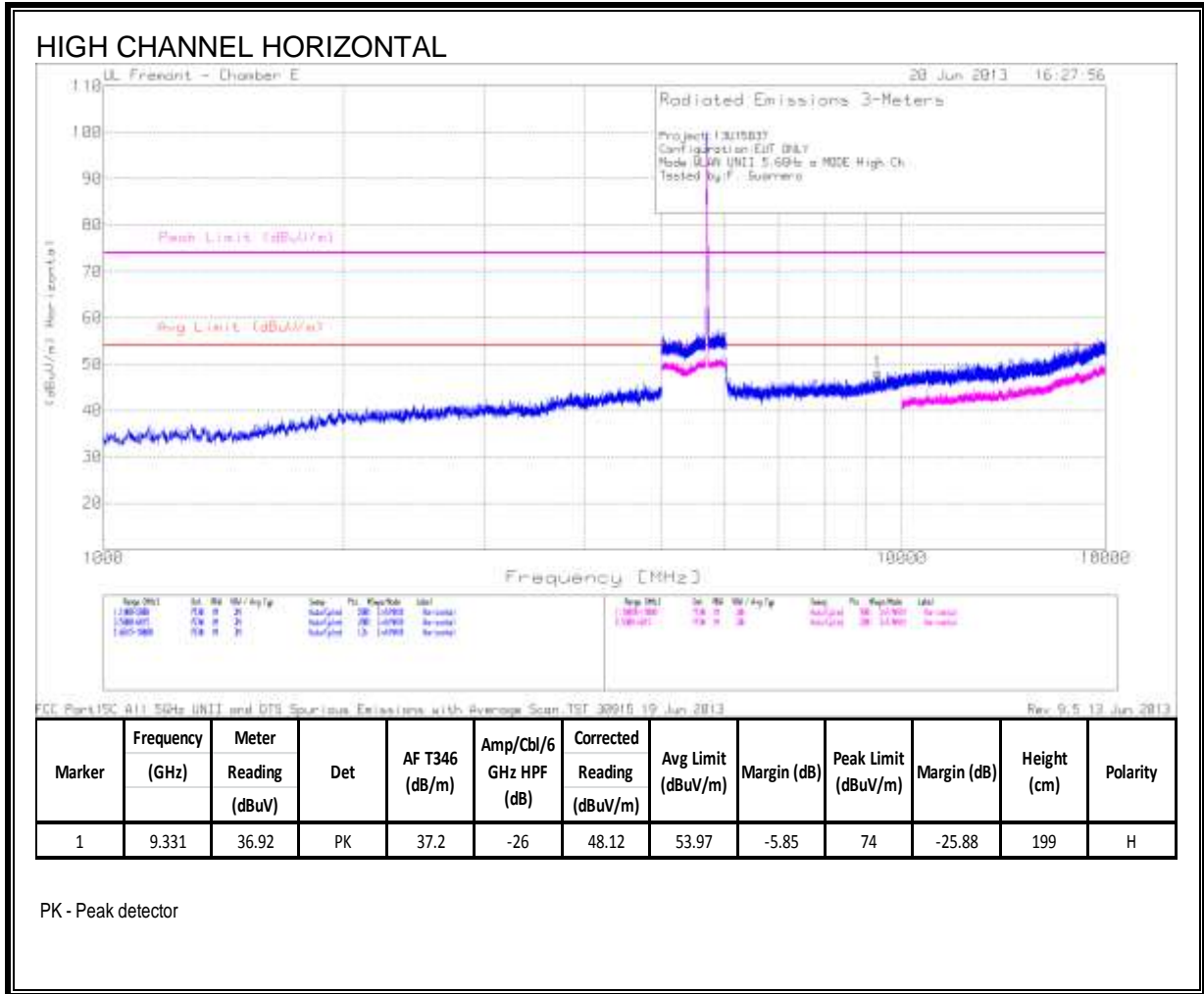

### HIGH CHANNEL VERTICAL

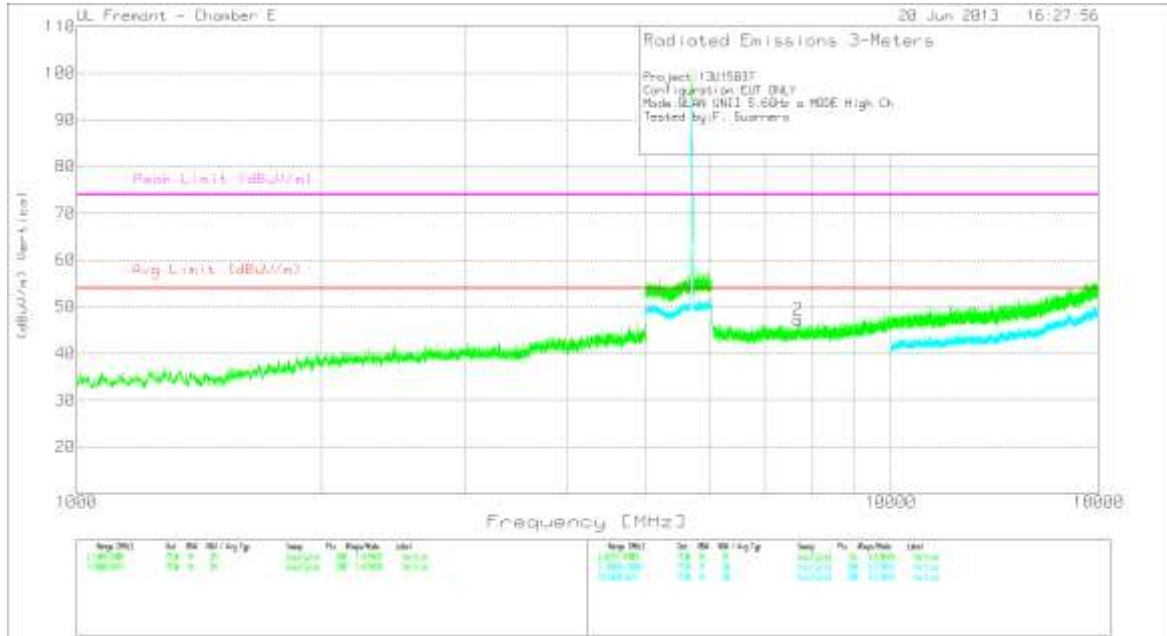

FCC Part15C: All 5GHz UNII and DFS Spurious Emissions with Average Scan TST 30915 19 Jun 2013 Rev: 9.5 13 Jun 2013

Marker	Frequency (GHz)	Meter Reading (dBuV)	Det	AF T346 (dB/m)	Amp/Cbl/6 GHz HPF (dB)	Corrected Reading (dBuV/m)	Avg Limit (dBuV/m)	Margin (dB)	Peak Limit (dBuV/m)	Margin (dB)	Height (cm)	Polarity
2	7.692	39.74	PK	36.2	-28.8	47.14	53.97	-6.83	74	-26.86	199	V

PK - Peak detector

### 9.2.8. TX ABOVE 1 GHz 802.11n HT20 MODE IN THE 5.6 GHz BAND

#### RESTRICTED & AUTHORIZED BANDEDGE (LOW CHANNEL)

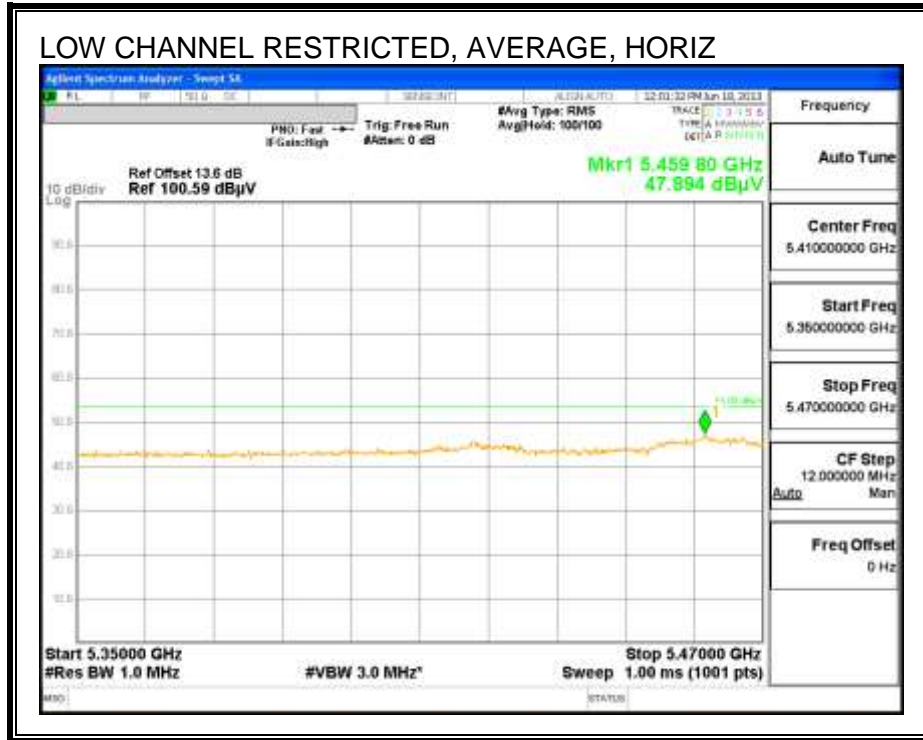
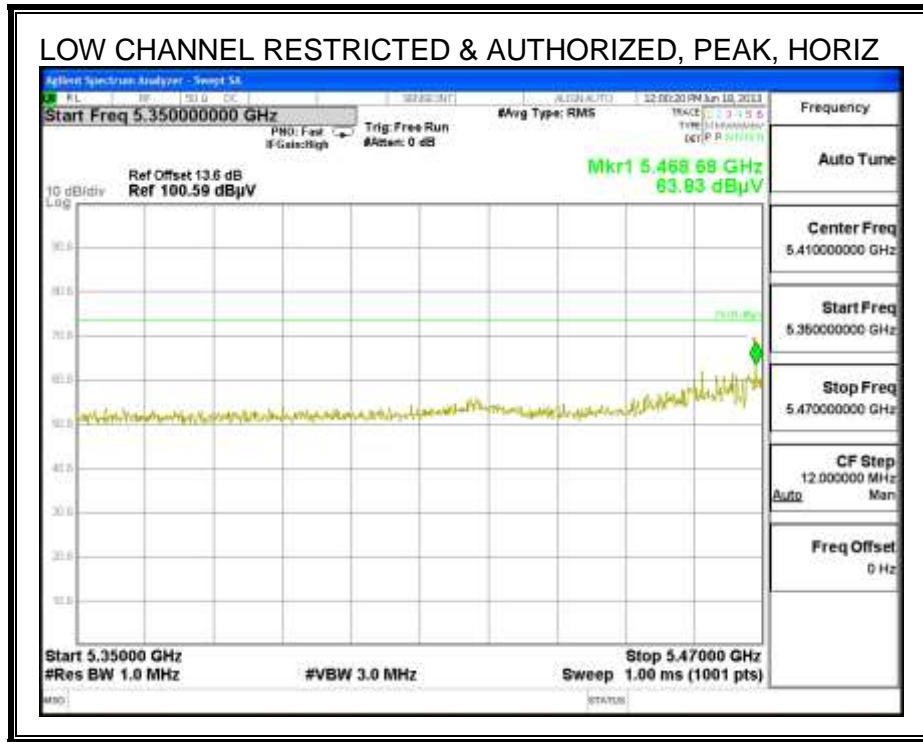

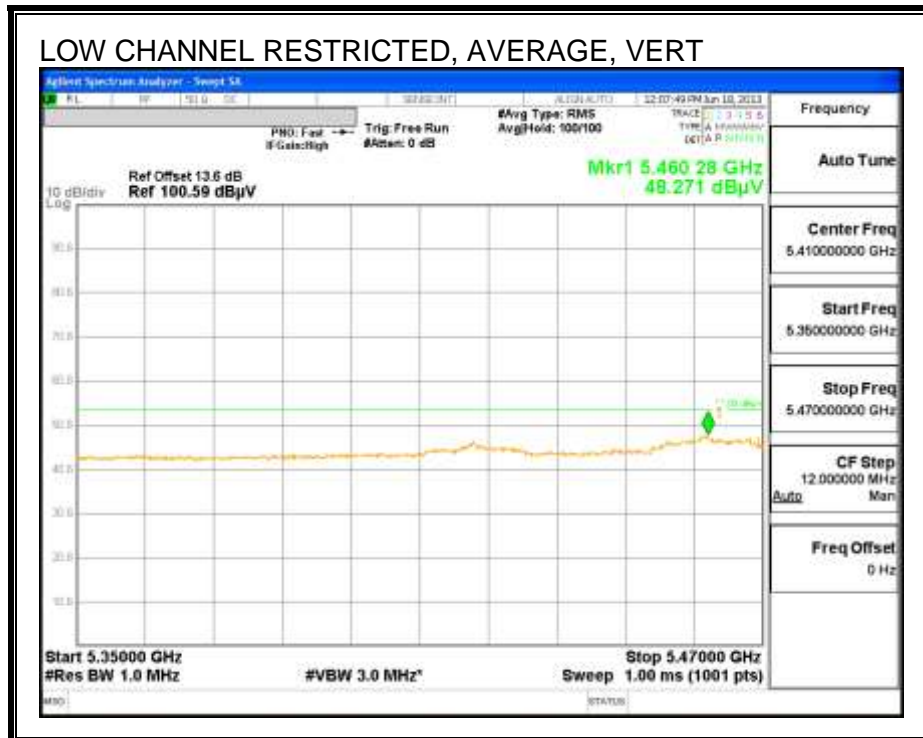
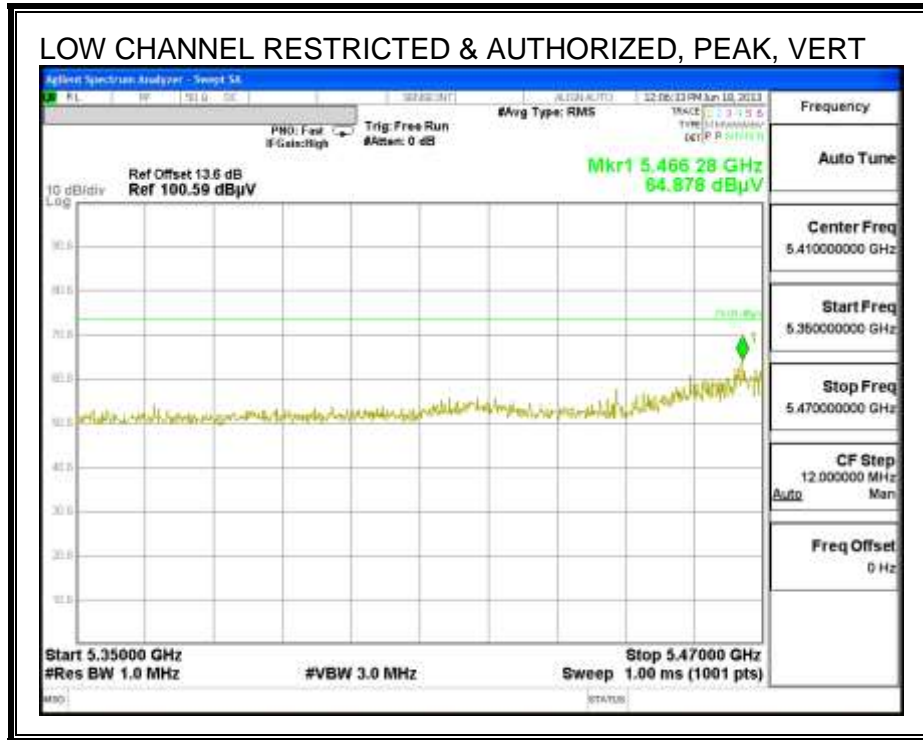



**AUTHORIZED BANDEDGE (HIGH CHANNEL)**

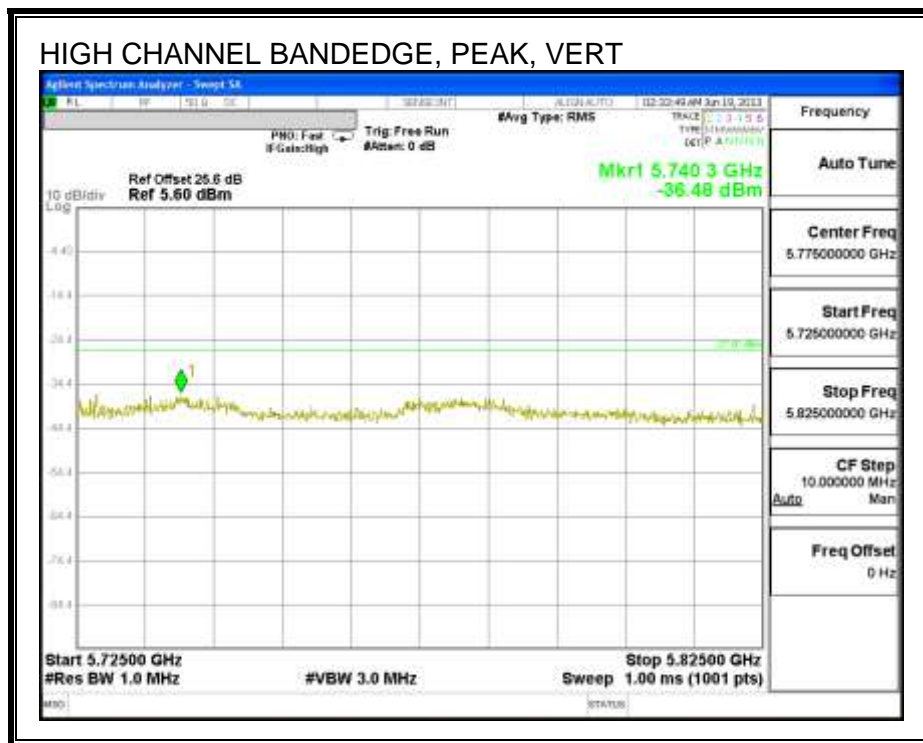
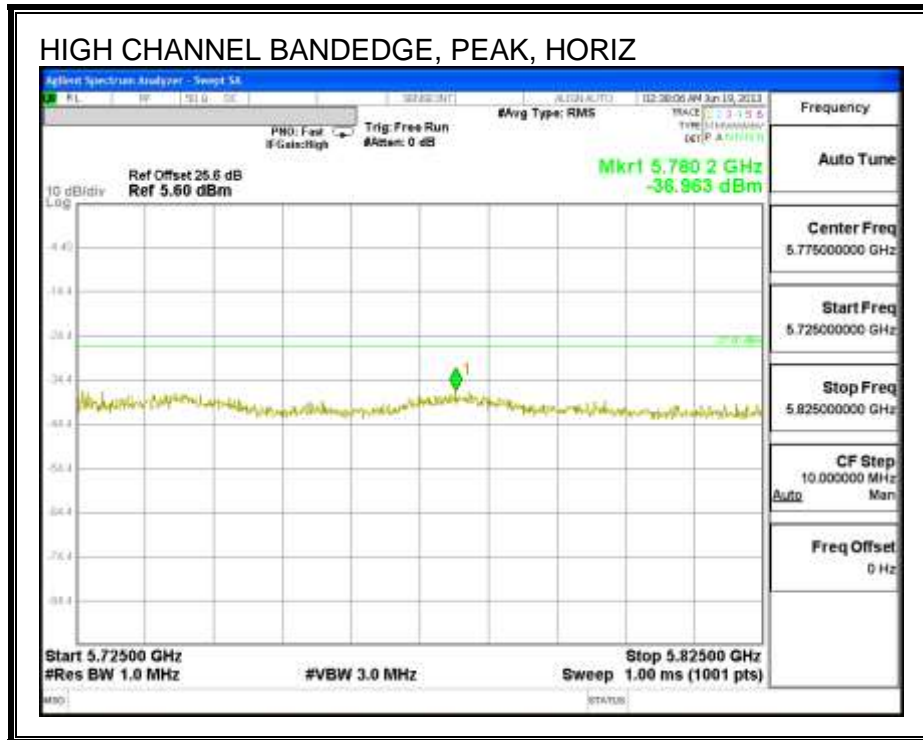

**HARMONICS AND SPURIOUS EMISSIONS**

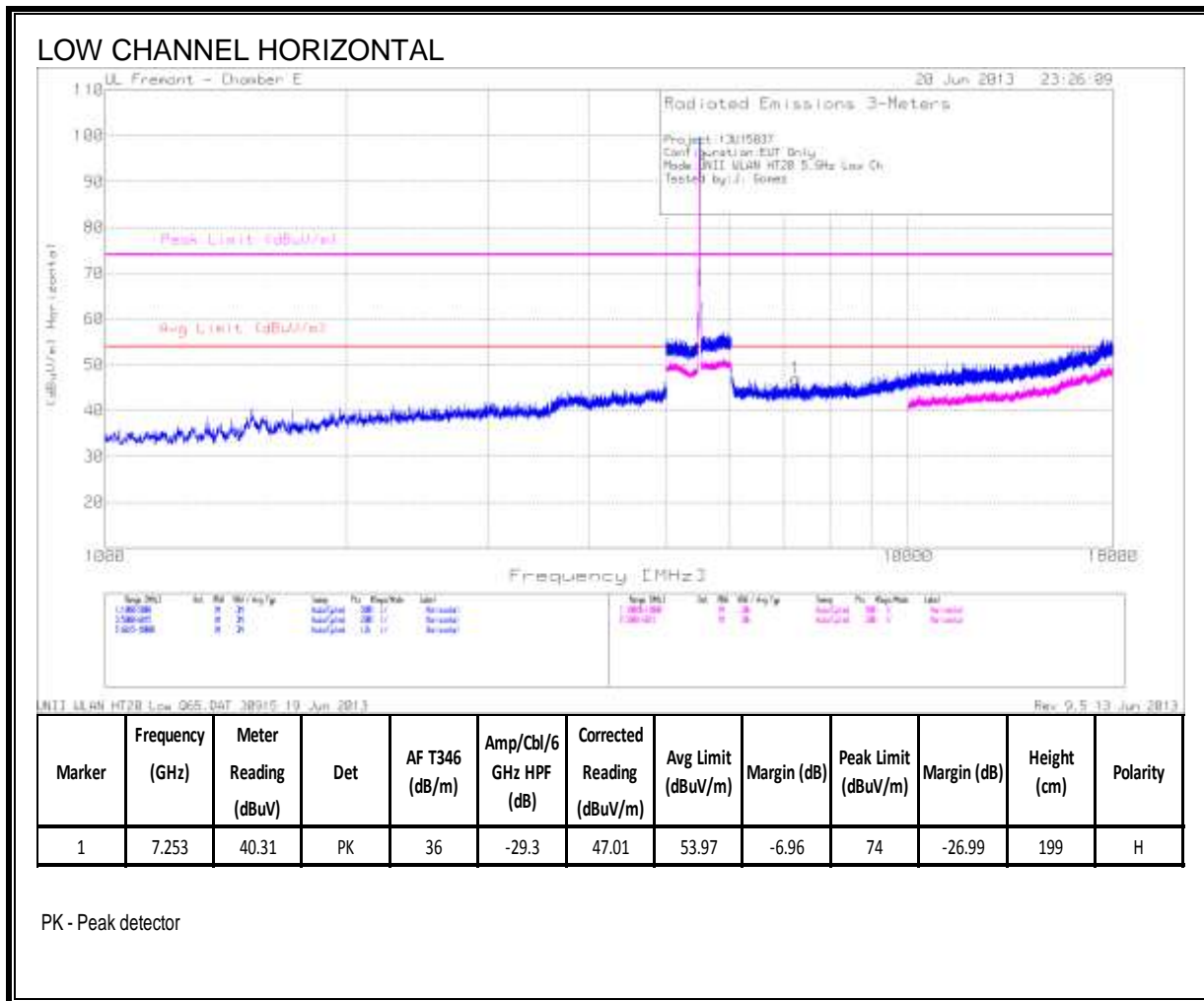

LOW CHANNEL VERTICAL

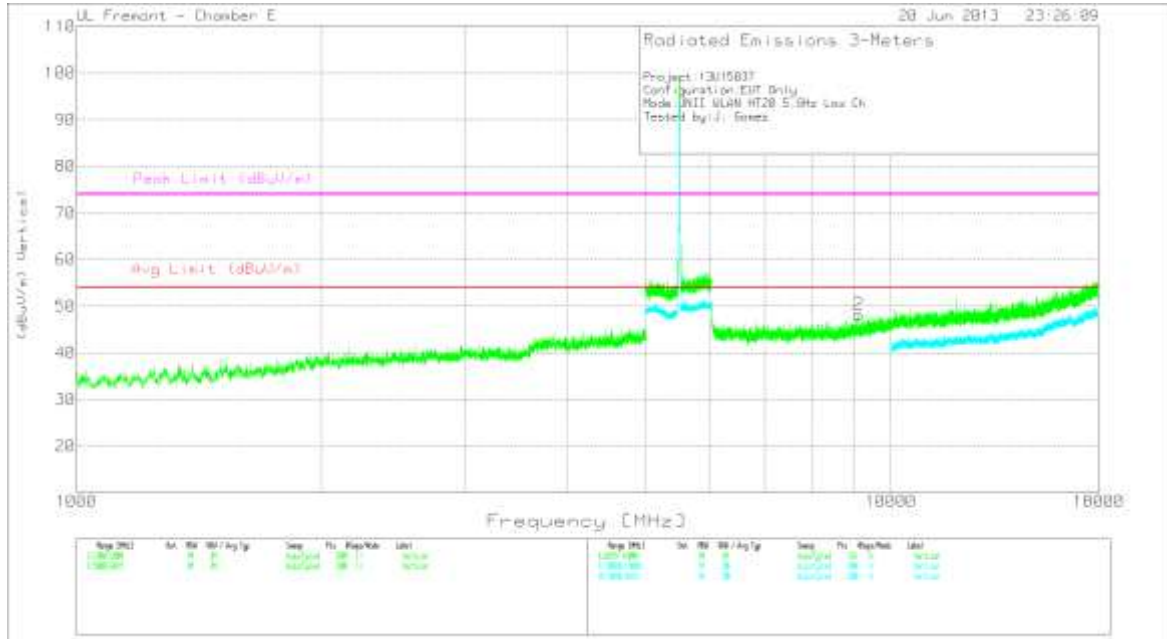

NIIT WLAN HT20 Low 065.DAT 30915 19 Jun 2013 Rev: 0.5 13 Jun 2013

Marker	Frequency (GHz)	Meter Reading (dBuV)	Det	AF T346 (dB/m)	Amp/Cbl/6 GHz HPF (dB)	Corrected Reading (dBuV/m)	Avg Limit (dBuV/m)	Margin (dB)	Peak Limit (dBuV/m)	Margin (dB)	Height (cm)	Polarity
2	9.133	38.08	PK	37	-26.9	48.18	53.97	-5.79	74	-25.82	199	V

PK - Peak detector

MID CHANNEL HORIZONTAL

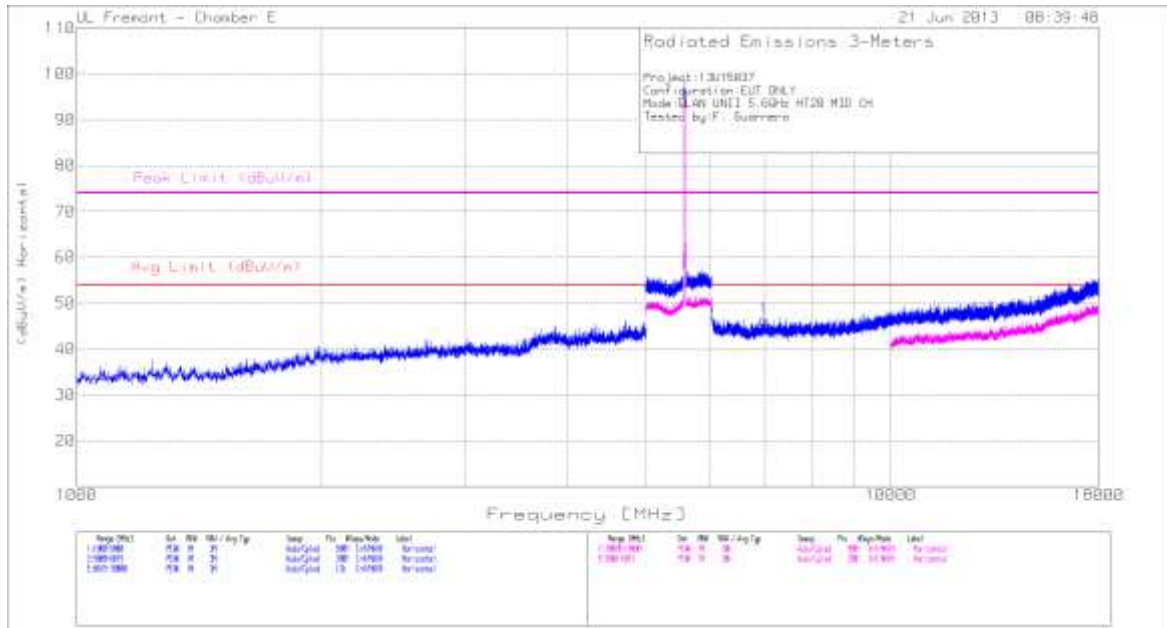

FCC Part 15C 411 5GHz UNIT and DFS Spurious Emissions with Average Sign. TST 30915 12 Jun 2013  
 Rev: 2.5 13 Jun 2013

Marker	Frequency (GHz)	Meter Reading (dBuV)	Det	AF T346 (dB/m)	Amp/Cbl/6 GHz HPF (dB)	Corrected Reading (dBuV/m)	Avg Limit (dBuV/m)	Margin (dB)	Peak Limit (dBuV/m)	Margin (dB)	Height (cm)	Polarity
1	6.994	39.46	PK	36	-29	46.46	53.97	-7.51	74	-27.54	199	H

PK - Peak detector

MID CHANNEL VERTICAL

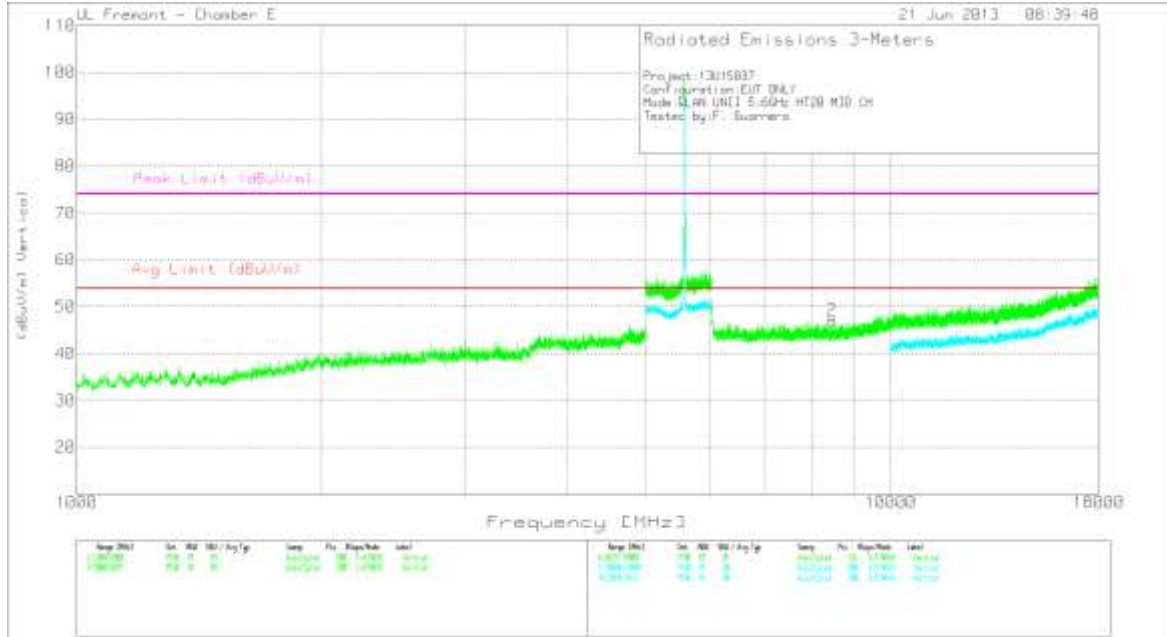

FCC Part 15C 911 5GHz UNIT and OTS Spurious Emissions with Average Scan TST 30915 19 Jun 2013 Rev. 9.5 13 Jun 2013

Marker	Frequency (GHz)	Meter Reading (dBuV)	Det	AF T346 (dB/m)	Amp/Cbl/6 GHz HPF (dB)	Corrected Reading (dBuV/m)	Avg Limit (dBuV/m)	Margin (dB)	Peak Limit (dBuV/m)	Margin (dB)	Height (cm)	Polarity
2	8.472	38.64	PK	36.2	-27.8	47.04	53.97	-6.93	74	-26.96	199	V

PK - Peak detector

HIGH CHANNEL HORIZONTAL

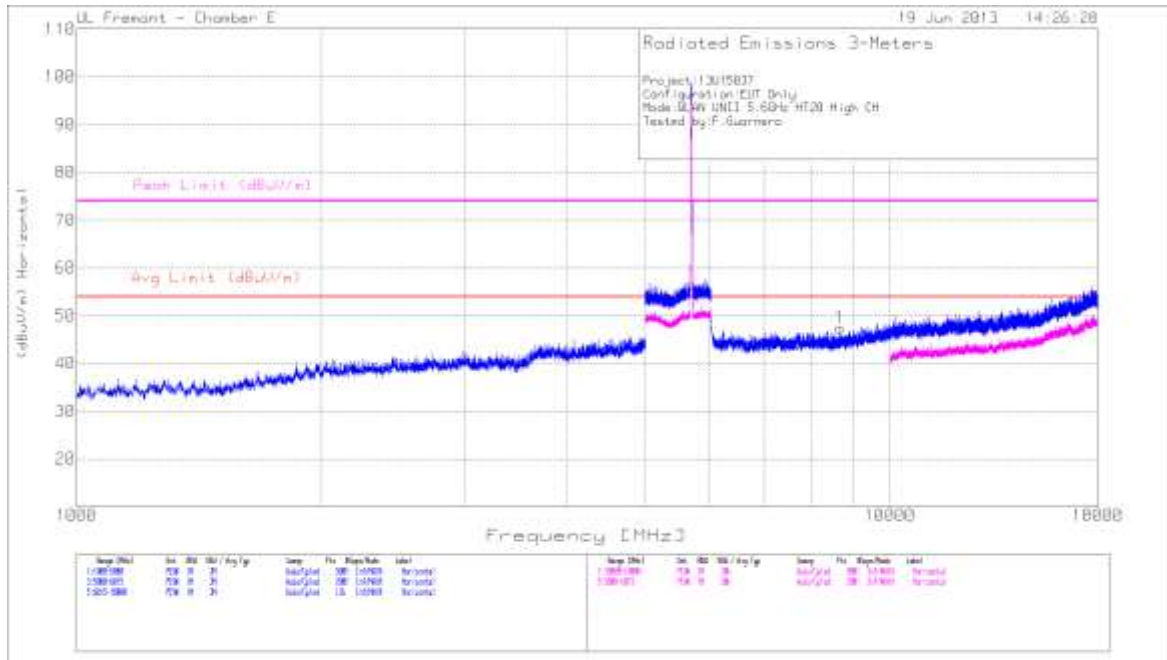

FCC Part 15C 611 5GHz UNII and DFS Spurious Emissions with Averaged Scan TST 38915 19 Jun 2013 Rev: 9.5 13 Jun 2013

Marker	Frequency (GHz)	Meter	Det	AF T346 (dB/m)	Amp/Cbl/6 GHz HPF (dB)	Corrected	Avg Limit (dBuV/m)	Margin (dB)	Peak Limit (dBuV/m)	Margin (dB)	Height (cm)	Polarity
		Reading (dBuV)				Reading (dBuV/m)						
1	8.683	38.26	PK	36.5	-27.4	47.36	53.97	-6.61	74	-26.64	199	H

PK - Peak detector

HIGH CHANNEL VERTICAL

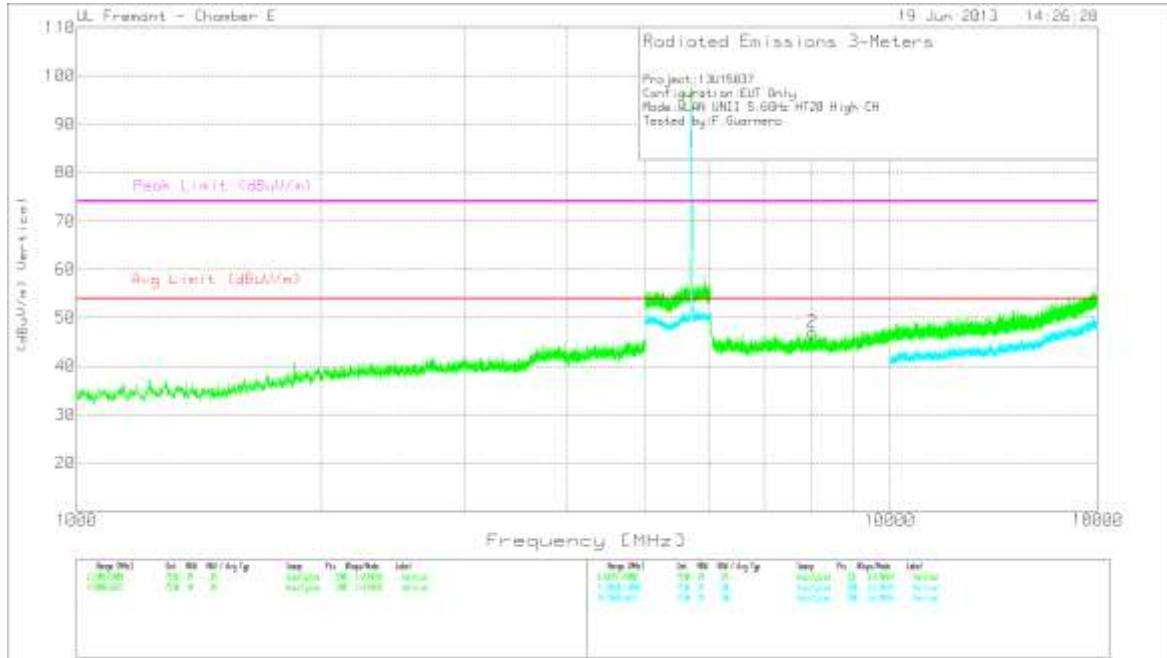

FCC Part 15C 611 5GHz UN11 and DTS Spurious Emissions with Average Scan TST 30515 19 Jun 2013 Rev 9.5 13 Jun 2013

Marker	Frequency (GHz)	Meter Reading (dBuV)	Det	AF T346 (dB/m)	Amp/Cbl/6 GHz HPF (dB)	Corrected Reading (dBuV/m)	Avg Limit (dBuV/m)	Margin (dB)	Peak Limit (dBuV/m)	Margin (dB)	Height (cm)	Polarity
2	8.018	39.6	PK	36.2	-28.8	47	53.97	-6.97	74	-27	199	V

PK - Peak detector

### 9.2.9. TX ABOVE 1 GHz 802.11n HT40 MODE IN THE 5.6 GHz BAND

#### RESTRICTED & AUTHORIZED BANDEDGE (LOW CHANNEL)

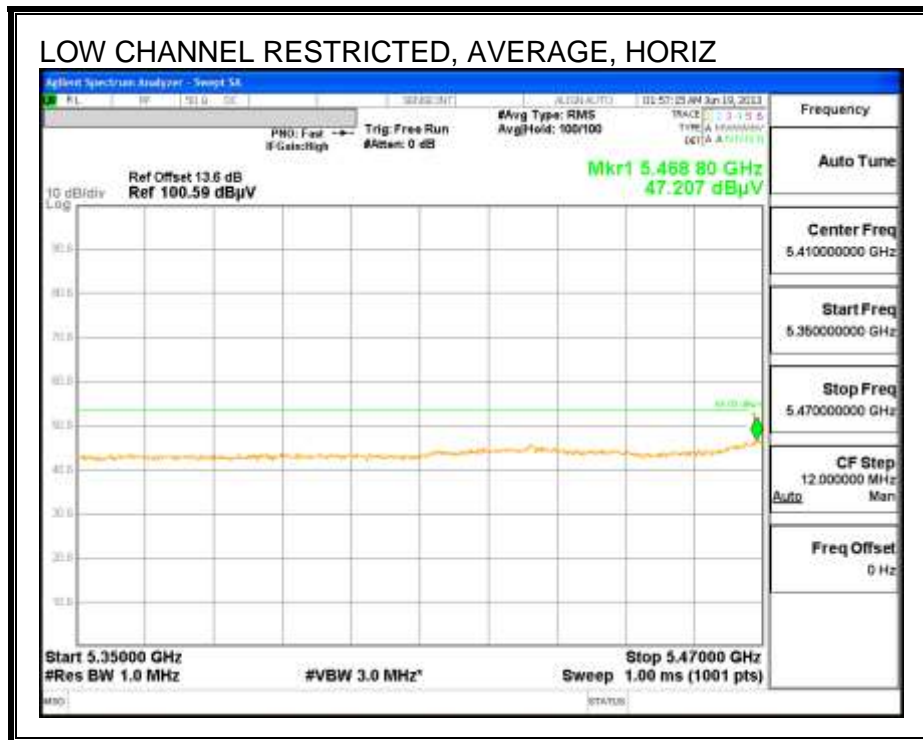
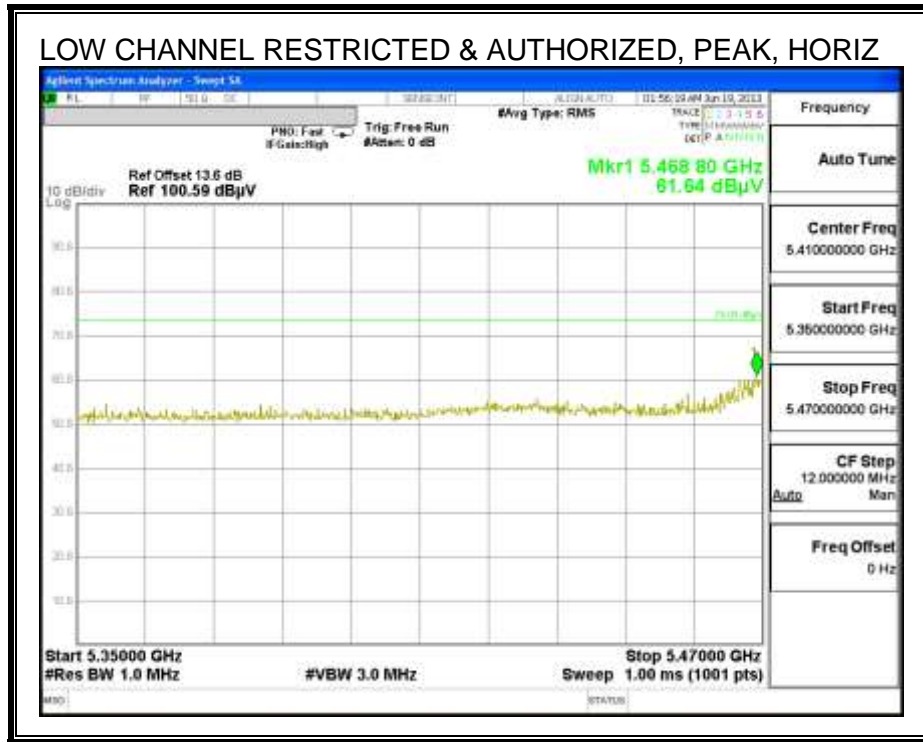



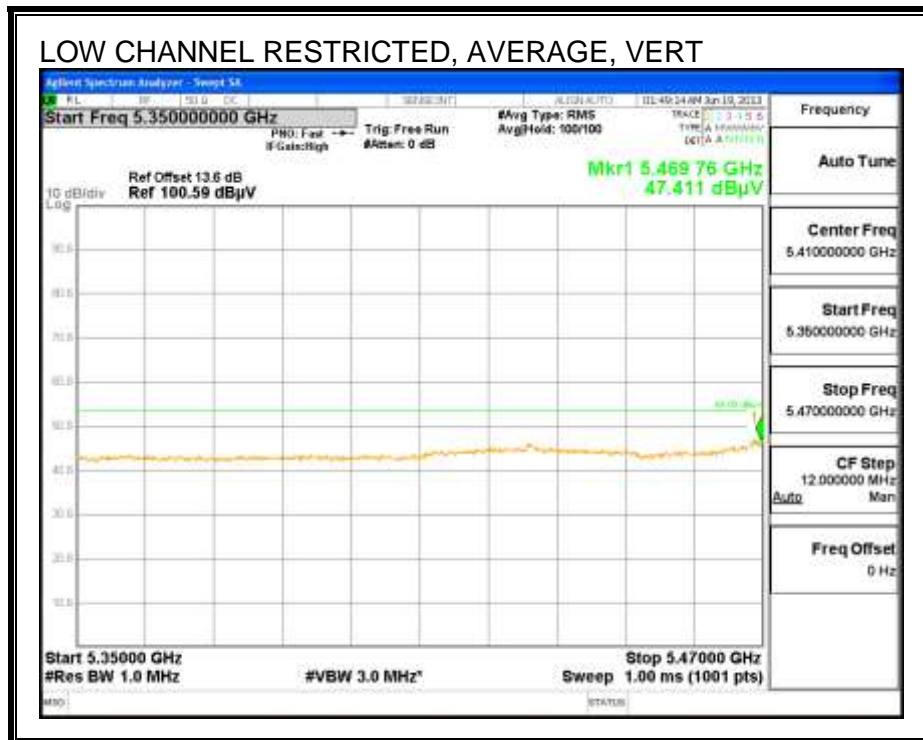
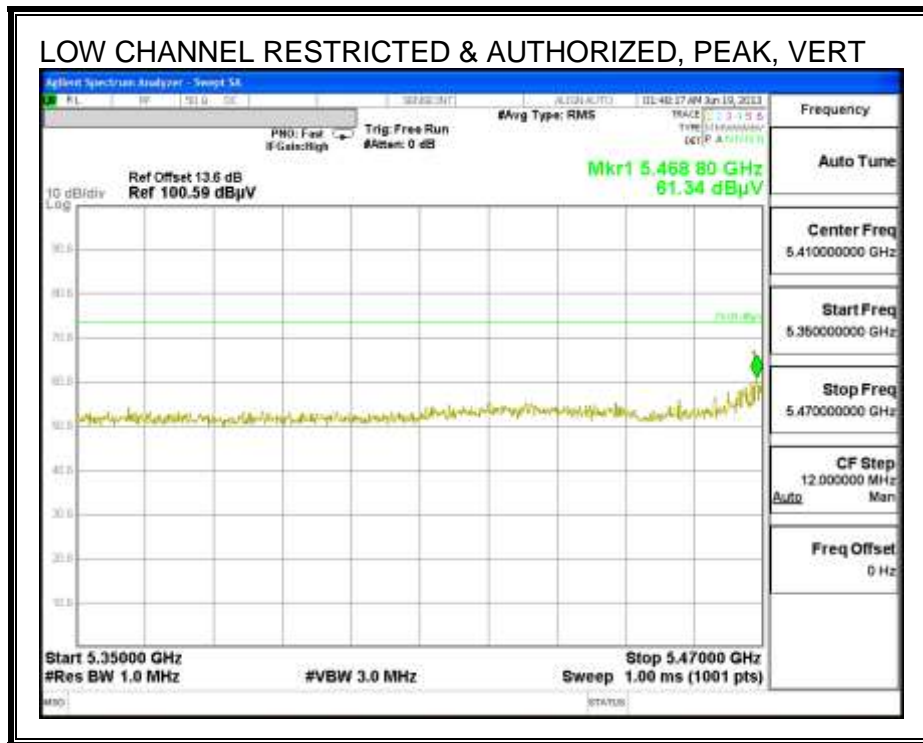

**AUTHORIZED BANDEDGE (HIGH CHANNEL)**

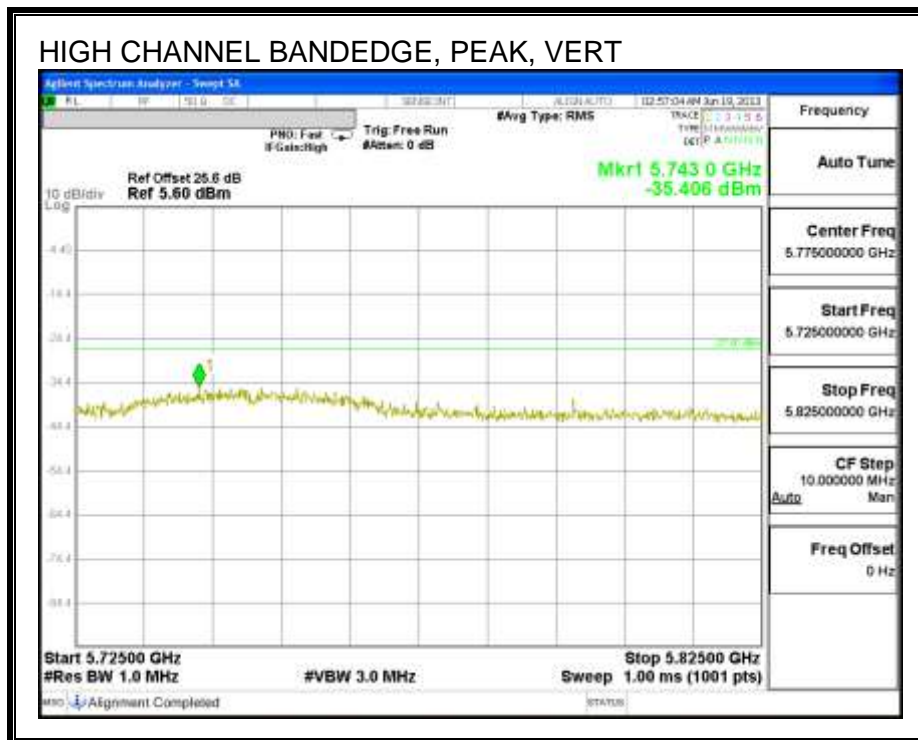
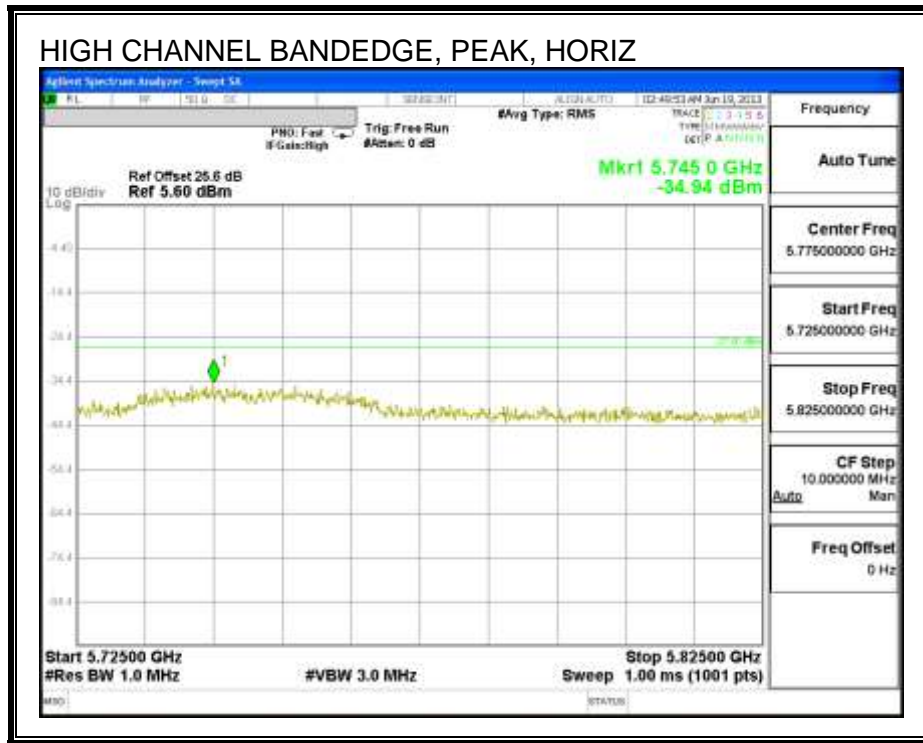

**HARMONICS AND SPURIOUS EMISSIONS**

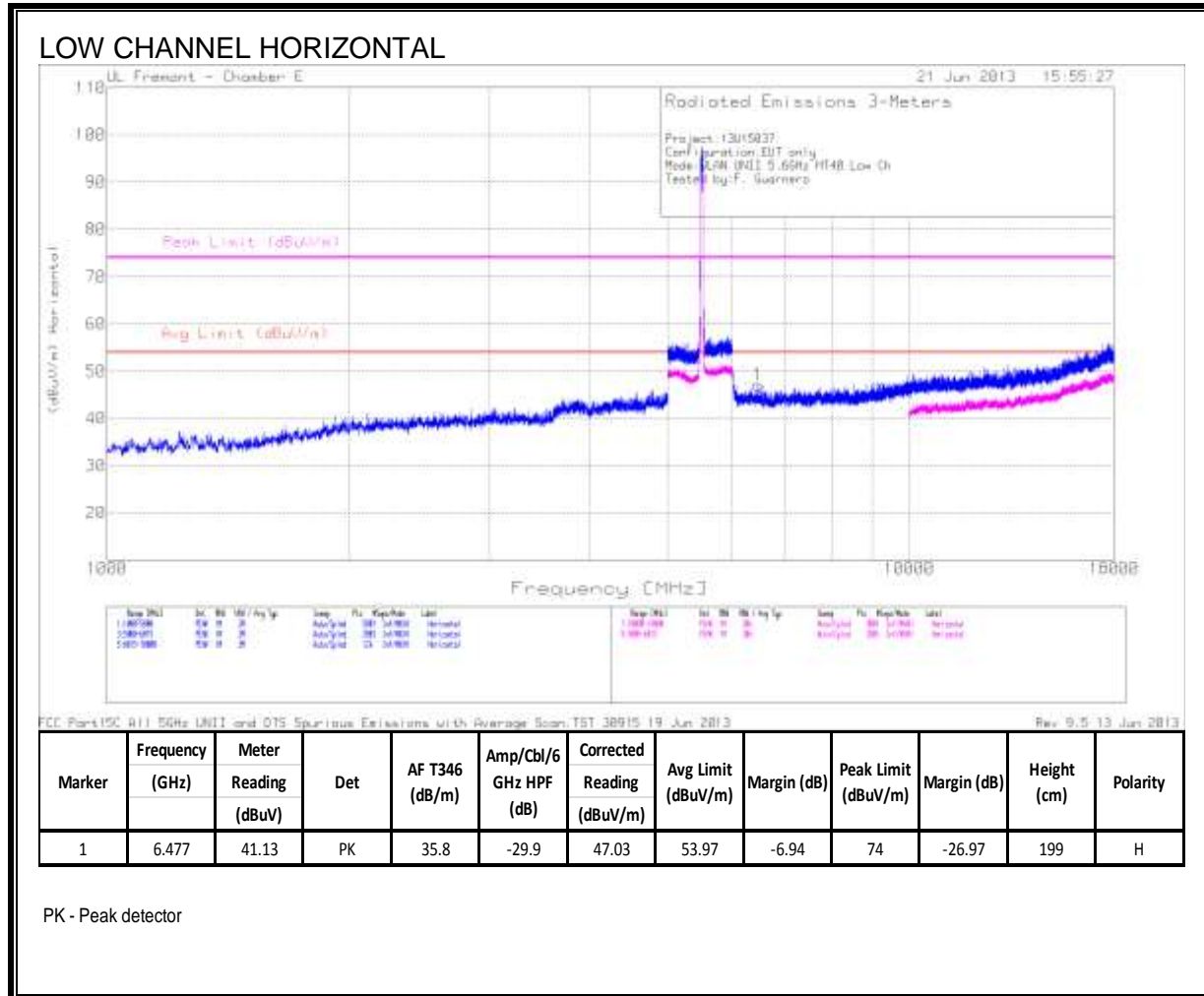

LOW CHANNEL VERTICAL

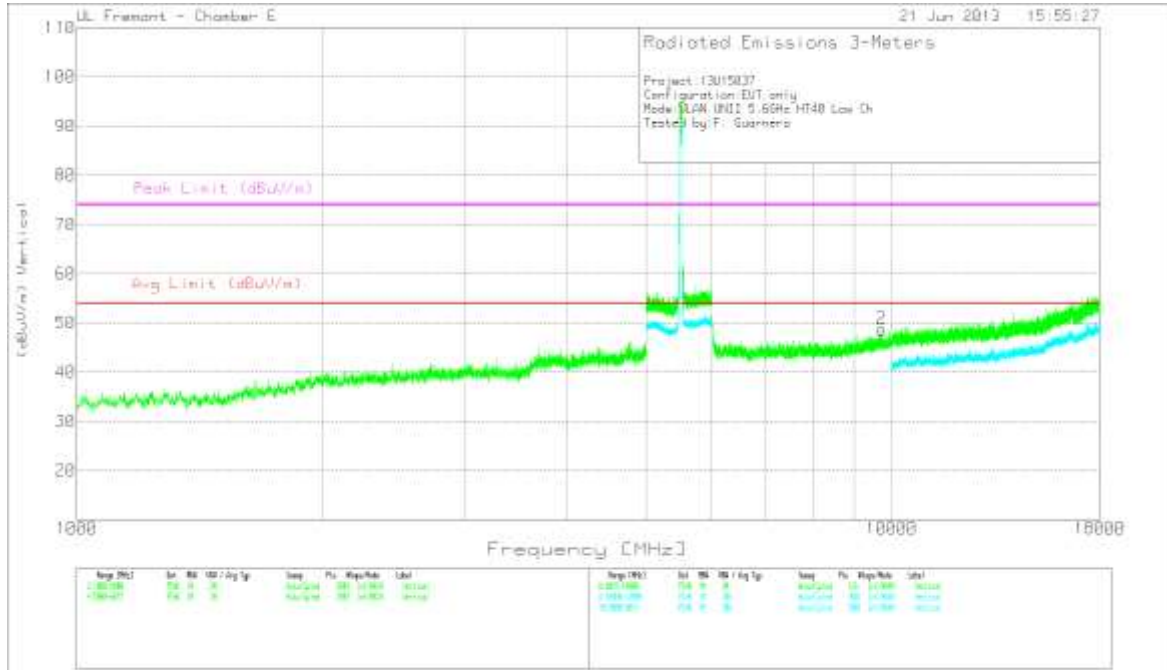

FCC Part 15C 611 56Hz UNII and 015 Spurious Emissions with Average Scan TST 26915 18 Jun 2013 Rev: 9.5 13 Jun 2013

Marker	Frequency (GHz)	Meter Reading (dBuV)	Det	AF T346 (dB/m)	Amp/Cbl/6 GHz HPF (dB)	Corrected Reading (dBuV/m)	Avg Limit (dBuV/m)	Margin (dB)	Peak Limit (dBuV/m)	Margin (dB)	Height (cm)	Polarity
2	9.729	36.75	PK	37.6	-25.7	48.65	53.97	-5.32	74	-25.35	199	V

PK - Peak detector

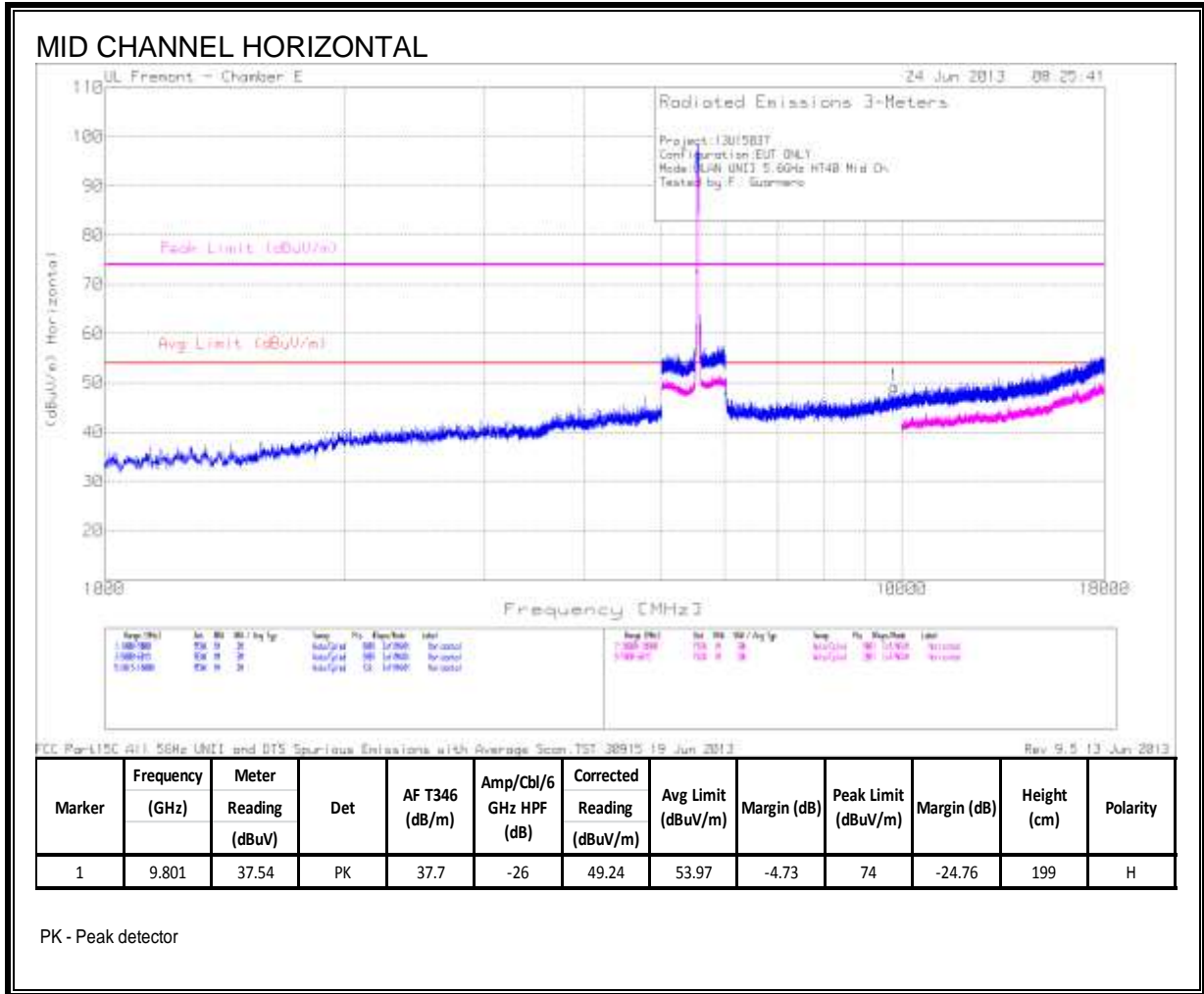

MID CHANNEL VERTICAL

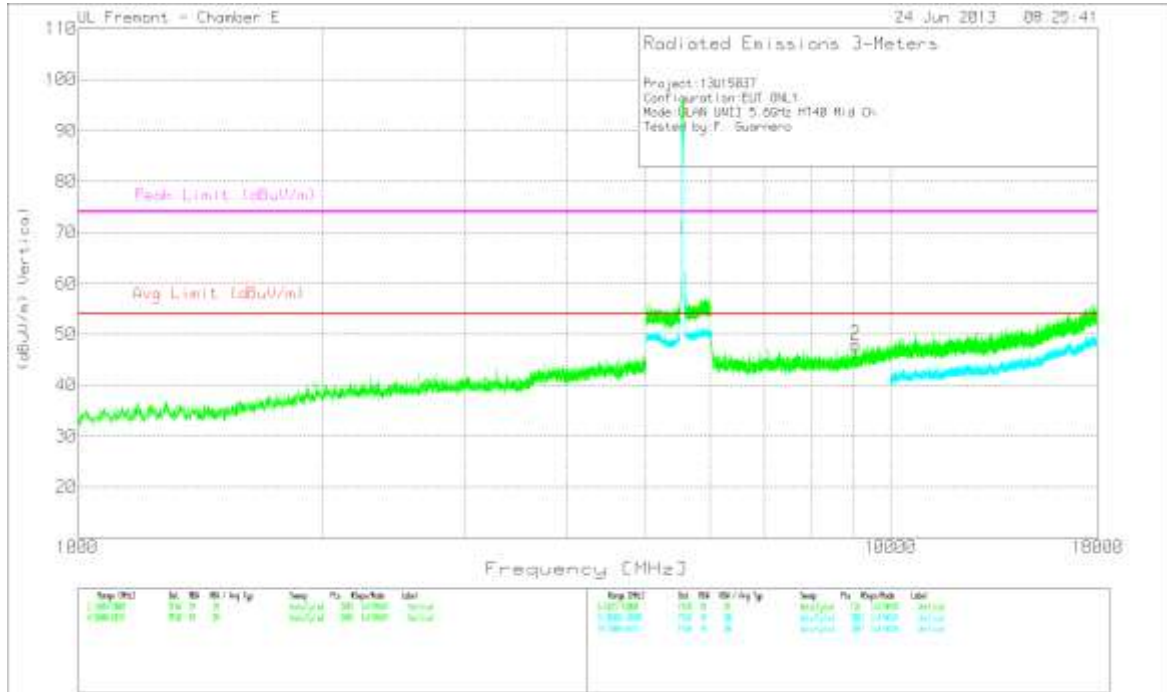

FCC Part 15C all 5GHz U-NII and DFS Spurious Emissions with Average Scan TST 38915 19 Jun 2013 Rev 9.5 13 Jun 2013

Marker	Frequency (GHz)	Meter Reading (dBuV)	Det	AF T346 (dB/m)	Amp/Cbl/6 GHz HPF (dB)	Corrected Reading (dBuV/m)	Avg Limit (dBuV/m)	Margin (dB)	Peak Limit (dBuV/m)	Margin (dB)	Height (cm)	Polarity
2	9.065	37.92	PK	36.9	-26.9	47.92	53.97	-6.05	74	-26.08	199	V

PK - Peak detector

HIGH CHANNEL HORIZONTAL

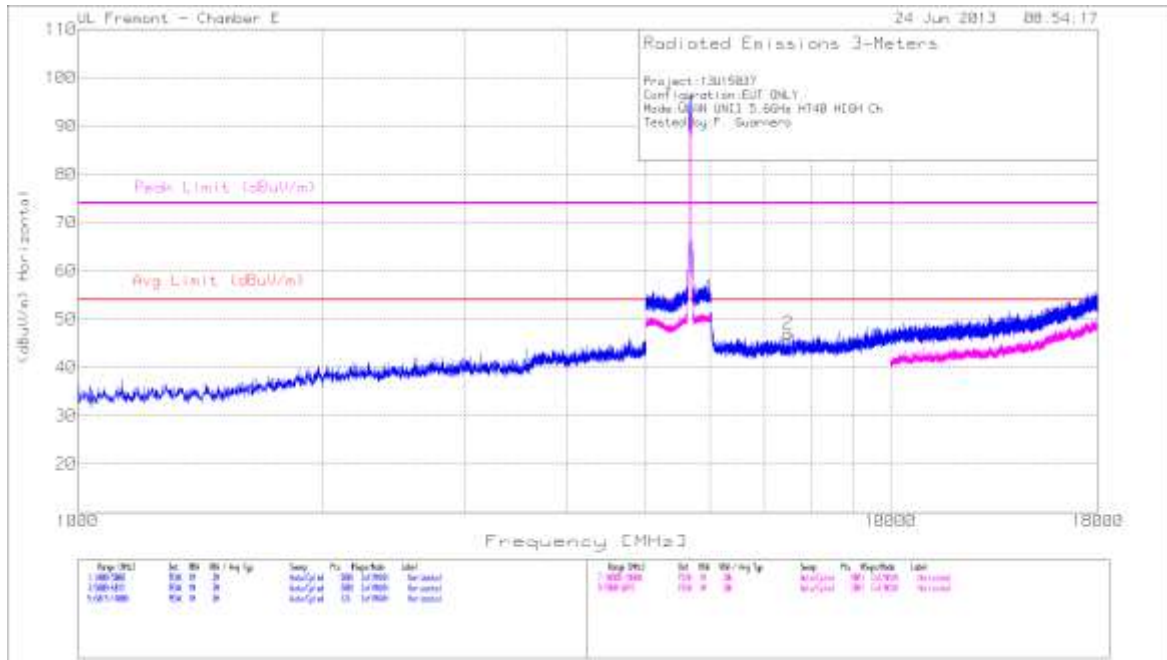

FCC Part15C @ 5GHz UNII and DTS Spurious Emissions with Average Scan TST 38915 19 Jun 2013 Rev 9.5 13 Jun 2013

Marker	Frequency (GHz)	Meter Reading (dBuV)	Det	AF T346 (dB/m)	Amp/Cbl/6 GHz HPF (dB)	Corrected Reading (dBuV/m)	Avg Limit (dBuV/m)	Margin (dB)	Peak Limit (dBuV/m)	Margin (dB)	Height (cm)	Polarity
2	7.491	40.28	PK	36.1	-29.4	46.98	53.97	-6.99	74	-27.02	199	H

PK - Peak detector

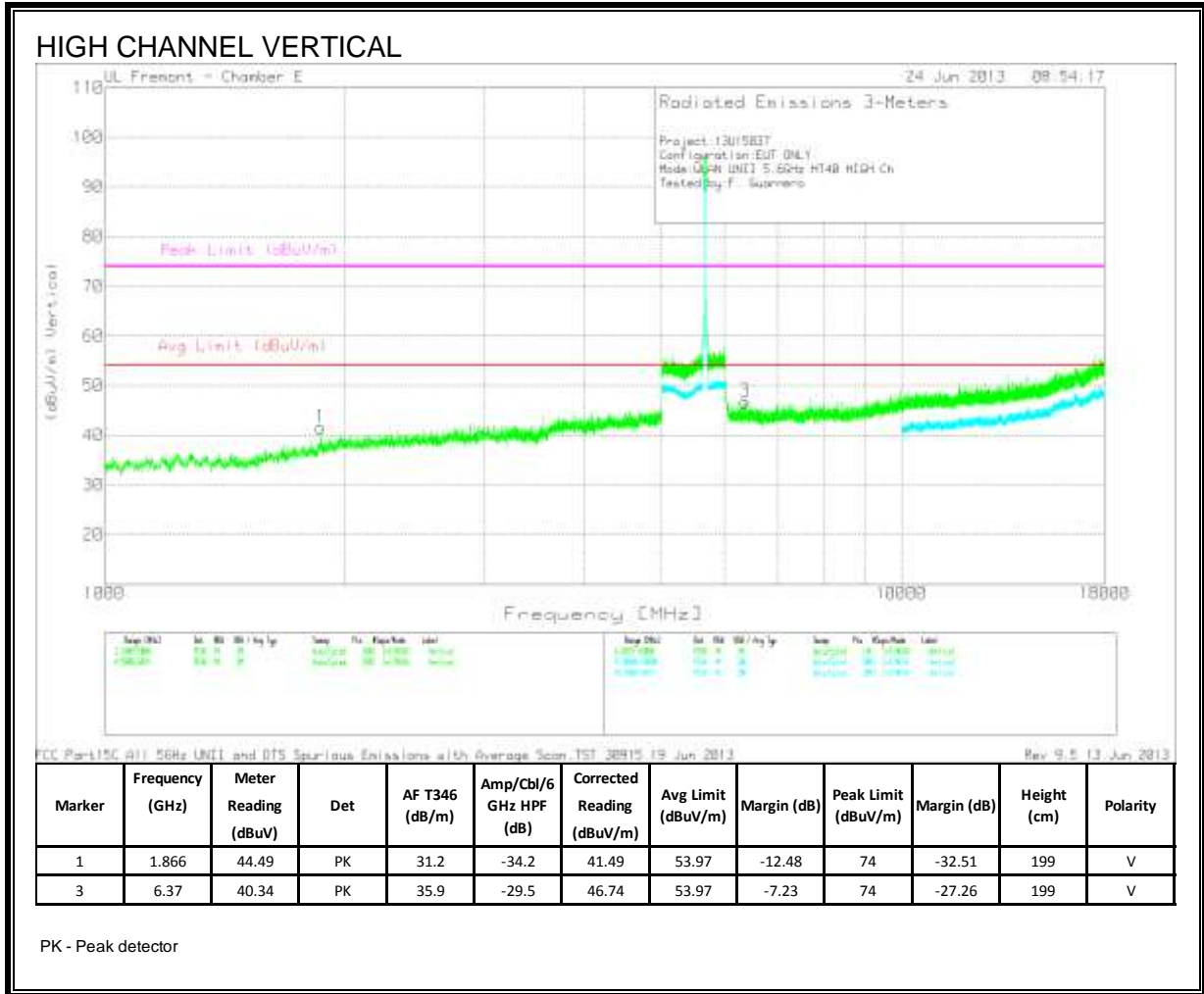



### 9.2.10. 2.4GHz and 5GHz Band Co-Location

#### BLUETOOTH ON

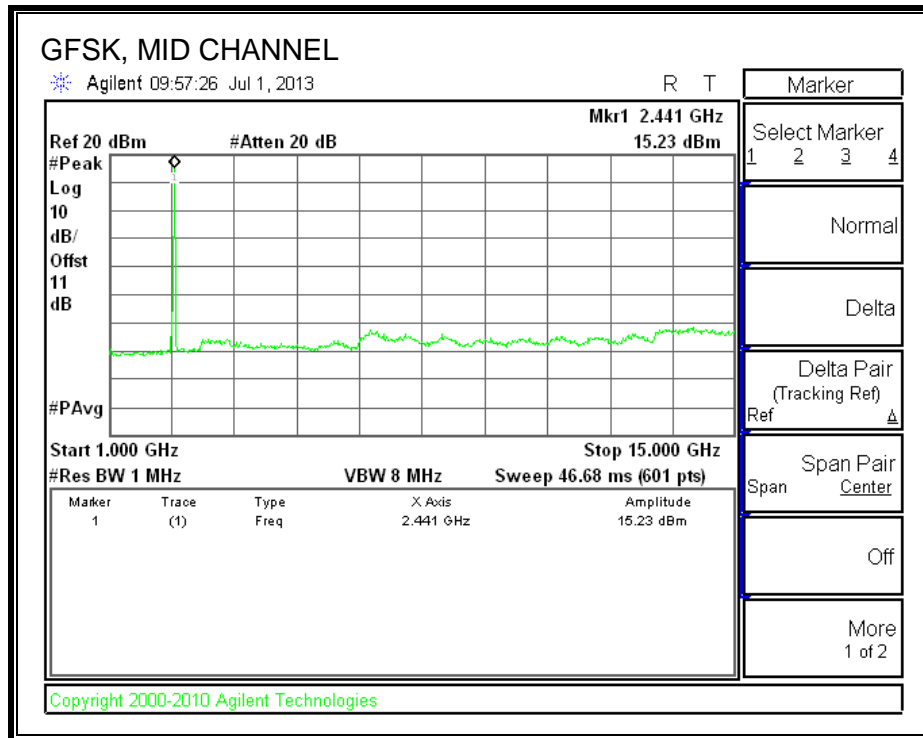

#### BLUETOOTH AND WiFi ON

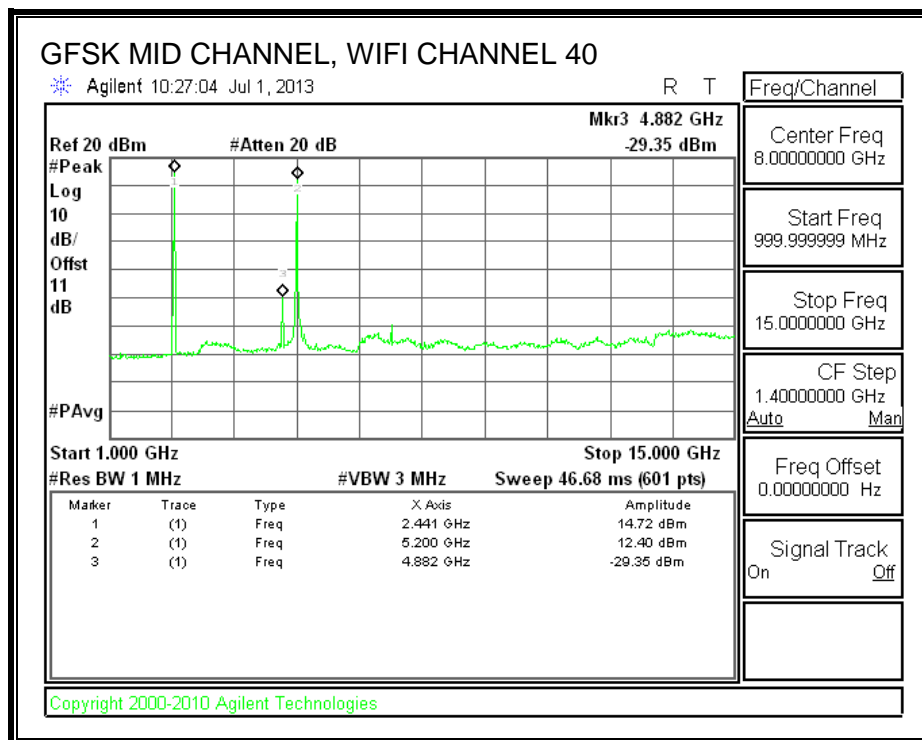

**BLUETOOTH OFF WiFi ON**

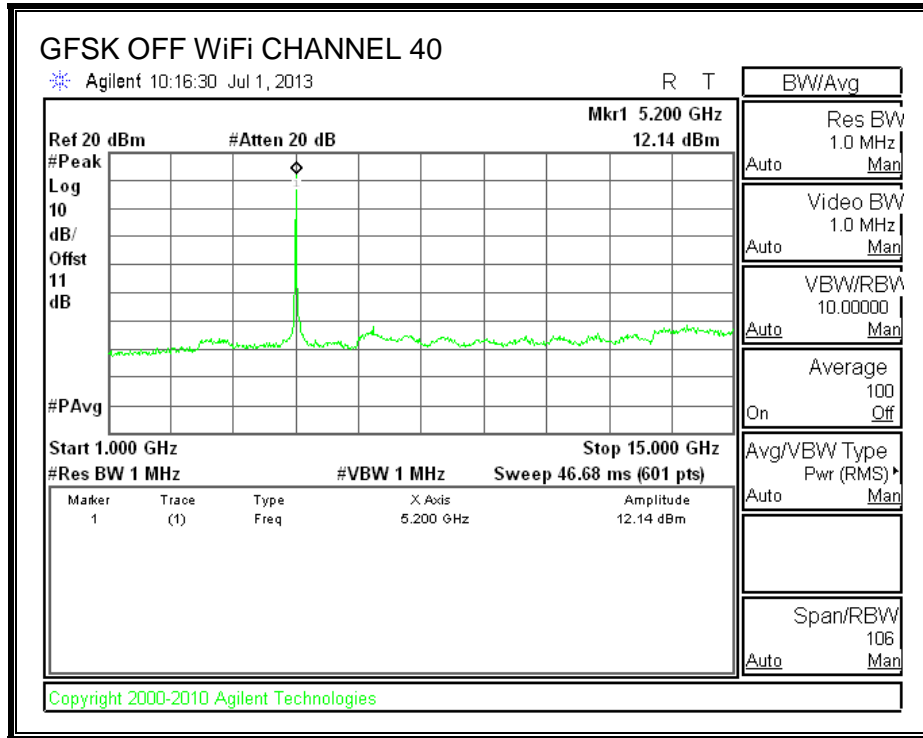

**HARMONICS AND SPURIOUS EMISSIONS**

**CO-LOCATION HORIZONTAL**

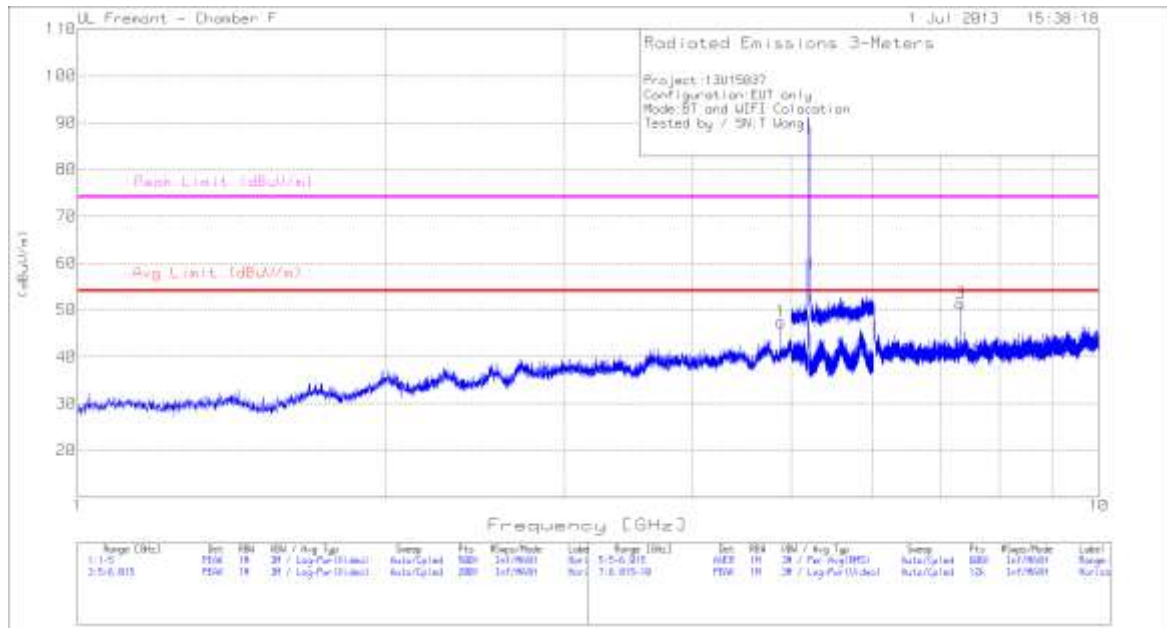

Marker	Frequency (GHz)	Meter Reading (dBuV)	Det	T344 Ant Factor [dB/m]	Amp/Cbl/FI tr/Pad (dB)	Corrected Reading (dBuV/m)	Avg Limit (dBuV/m)	Av Margin (dB)	Peak Limit (dBuV/m)	Margin (dB)	Azimuth (Degs)	Height (cm)	Polarity
1	4.882	44.02	PK	34.3	-30.9	47.42	53.07	-5.65	74	-26.58	0-360	101	H
3	7.324	43.94	PK	35.9	-28.5	51.34	53.07	-1.73	74	-22.66	0-360	100	H

PK - Peak detector

CO-LOCATION VERTICAL



sa-loc a33 DAT 12746 Rev: 9.5.12 Jun 2013

Marker	Frequency (GHz)	Meter Reading (dBuV)	Det	T344 Ant Factor [dB/m]	Amp/Cbl/Fi tr/Pad (dB)	Corrected Reading (dBuV/m)	Avg Limit (dBuV/m)	Av Margin (dB)	Peak Limit (dBuV/m)	Margin (dB)	Azimuth (Degs)	Height (cm)	Polarity
2	4.882	45.44	PK	34.3	-30.9	48.84	53.07	-4.23	74	-25.16	0-360	100	V
4	7.323	45.01	PK	35.9	-28.5	52.41	53.07	-0.66	74	-21.59	0-360	100	V

PK - Peak detector

### 9.3. WORST-CASE BELOW 1 GHz

#### SPURIOUS EMISSIONS 30 TO 1000 MHz (WORST-CASE CONFIGURATION, HORIZONTAL)

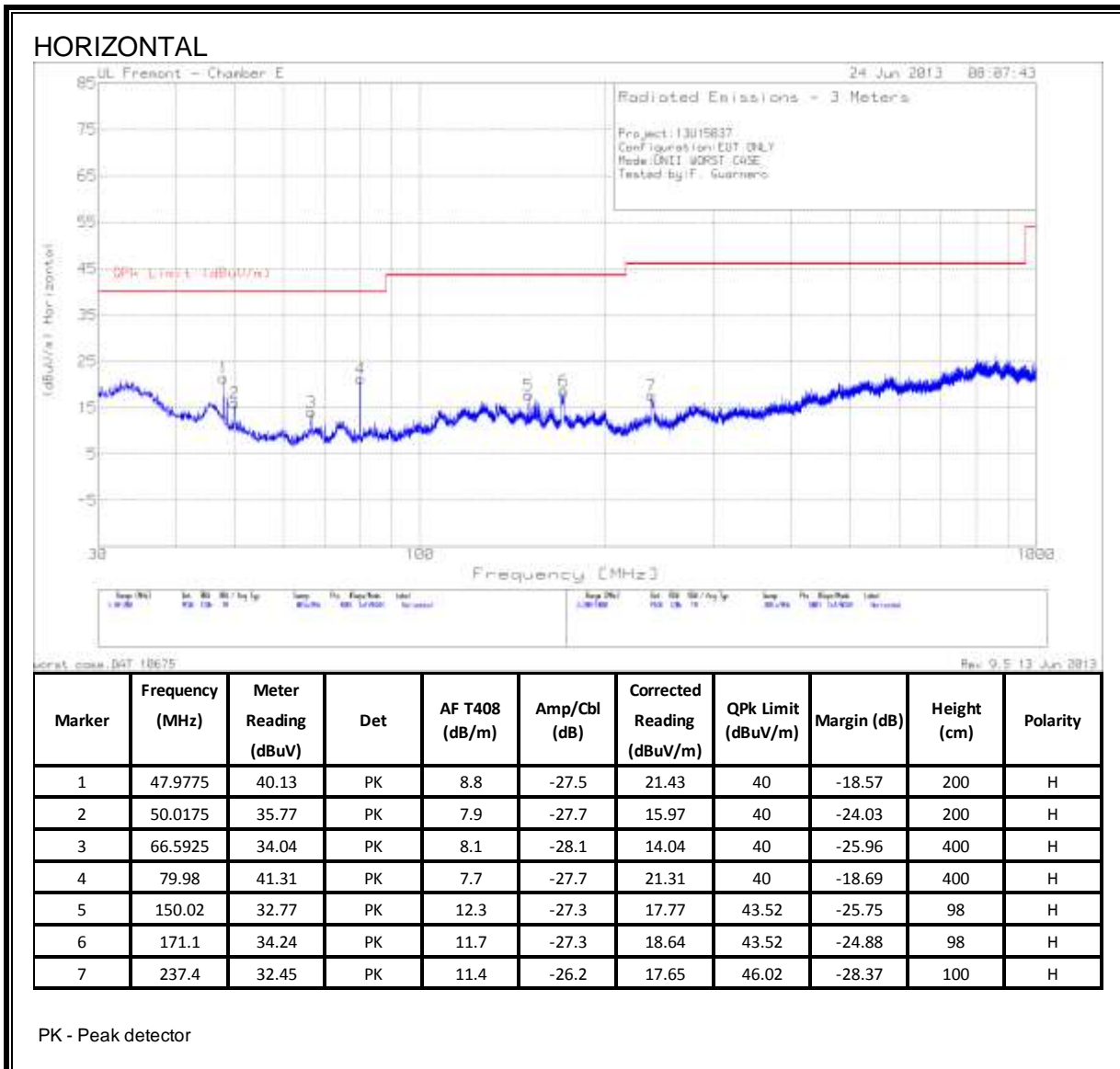

**SPURIOUS EMISSIONS 30 TO 1000 MHz (WORST-CASE CONFIGURATION, VERTICAL)**

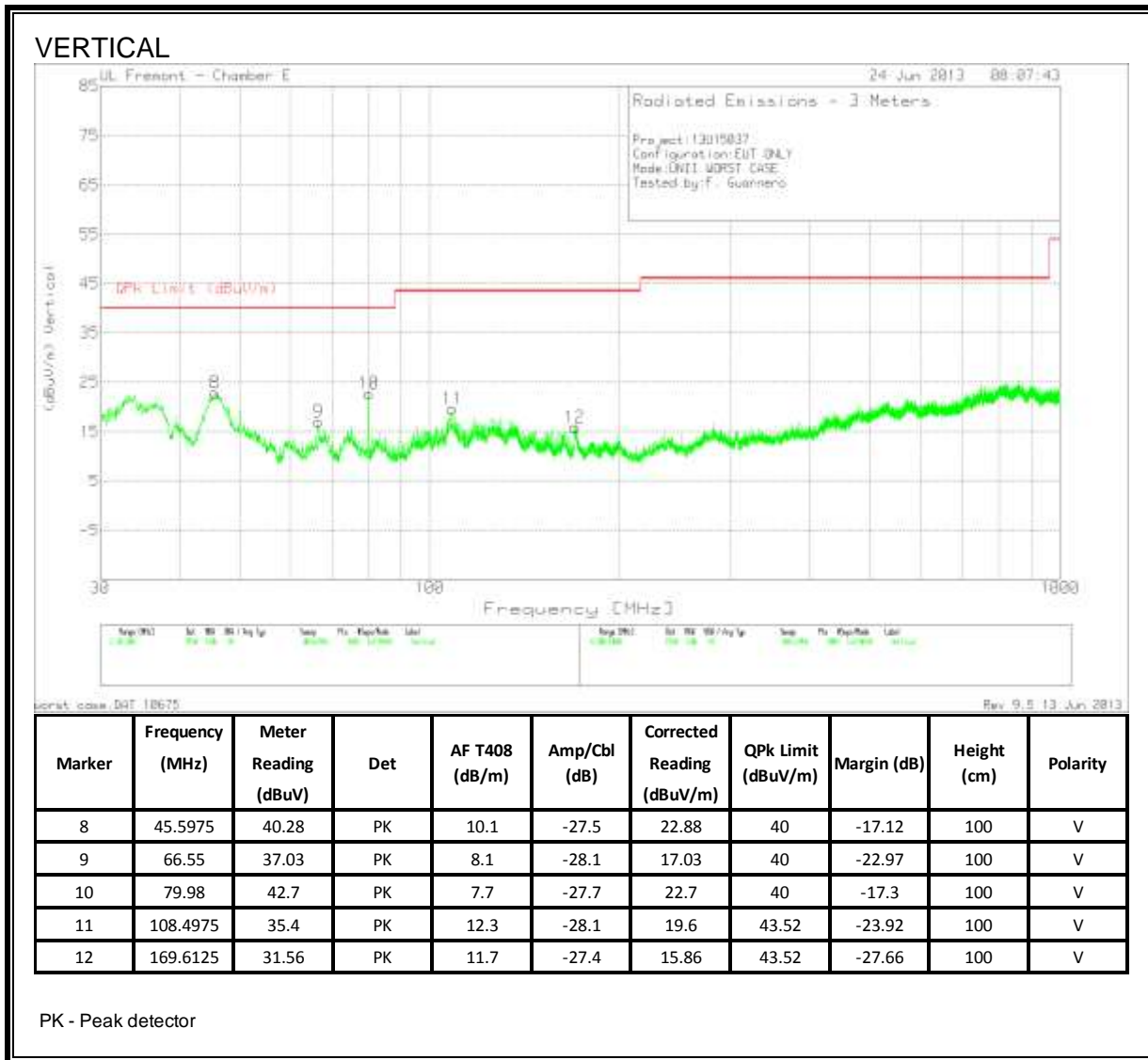

#### **9.4. RECEIVER ABOVE 1 GHz**

Note: No emissions were detected above the system noise floor.

## 10. AC POWER LINE CONDUCTED EMISSIONS

### LIMITS

FCC §15.207 (a)

RSS-Gen 7.2.2

Frequency of Emission (MHz)	Conducted Limit (dBuV)	
	Quasi-peak	Average
0.15-0.5	66 to 56 <sup>*</sup>	56 to 46 <sup>*</sup>
0.5-5	56	46
5-30	60	50

<sup>\*</sup>Decreases with the logarithm of the frequency.

### TEST PROCEDURE

The EUT is placed on a non-conducting table 40 cm from the vertical ground plane and 80 cm above the horizontal ground plane. The EUT is configured in accordance with ANSI C63.4.

The receiver is set to a resolution bandwidth of 9 kHz. Peak detection is used unless otherwise noted as quasi-peak or average.

Line conducted data is recorded for both NEUTRAL and HOT lines.

### RESULTS



**6 WORST EMISSIONS**

**Line-L1 .15 - 30MHz**

Test Frequency	Meter Reading	Detector	T24 IL L1.TXT (dB)	LC Cables 1&3.TXT (dB)	dB(uVolts)	CISPR 11/22 Class B Quasi-peak	Margin	CISPR 11/22 Class B Average	Margin
0.159	54.38	QP	0.1	0	54.48	65.52	-11.04	-	-
0.159	48.7	Av	0.1	0	48.8	-	-	55.5	-6.7
0.8295	48.8	PK	0.1	0	48.9	56	-7.1	-	-
0.8295	30.76	Av	0.1	0	30.86	-	-	46	-15.14
7.278	39.71	PK	0.1	0.1	39.91	60	-20.09	-	-
7.278	25.72	Av	0.1	0.1	25.92	-	-	50	-24.08
16.854	45.42	PK	0.2	0.2	45.82	60	-14.18	-	-
16.854	28.85	Av	0.2	0.2	29.25	-	-	50	-20.75

**Line-L2 .15 - 30MHz**

Test Frequency	Meter Reading	Detector	T24 IL L2.TXT (dB)	LC Cables 2&3.TXT (dB)	dB(uVolts)	CISPR 11/22 Class B Quasi-peak	Margin	CISPR 11/22 Class B Average	Margin
0.1545	54.75	PK	0.1	0	54.85	65.8	-10.95	-	-
0.1545	40.25	Av	0.1	0	40.35	-	-	55.8	-15.45
0.78	42.3	PK	0.1	0	42.4	56	-13.6	-	-
0.78	24.89	Av	0.1	0	24.99	-	-	46	-21.01
2.4585	35.55	PK	0.1	0.1	35.75	56	-20.25	-	-
2.4585	22.07	Av	0.1	0.1	22.27	-	-	46	-23.73
17.5425	42	PK	0.2	0.2	42.4	60	-17.6	-	-
17.5425	29.72	Av	0.2	0.2	30.12	-	-	50	-19.88

PK - Peak detector  
 QP - Quasi-Peak detector  
 Av - Average detector

**LINE 1 RESULTS**

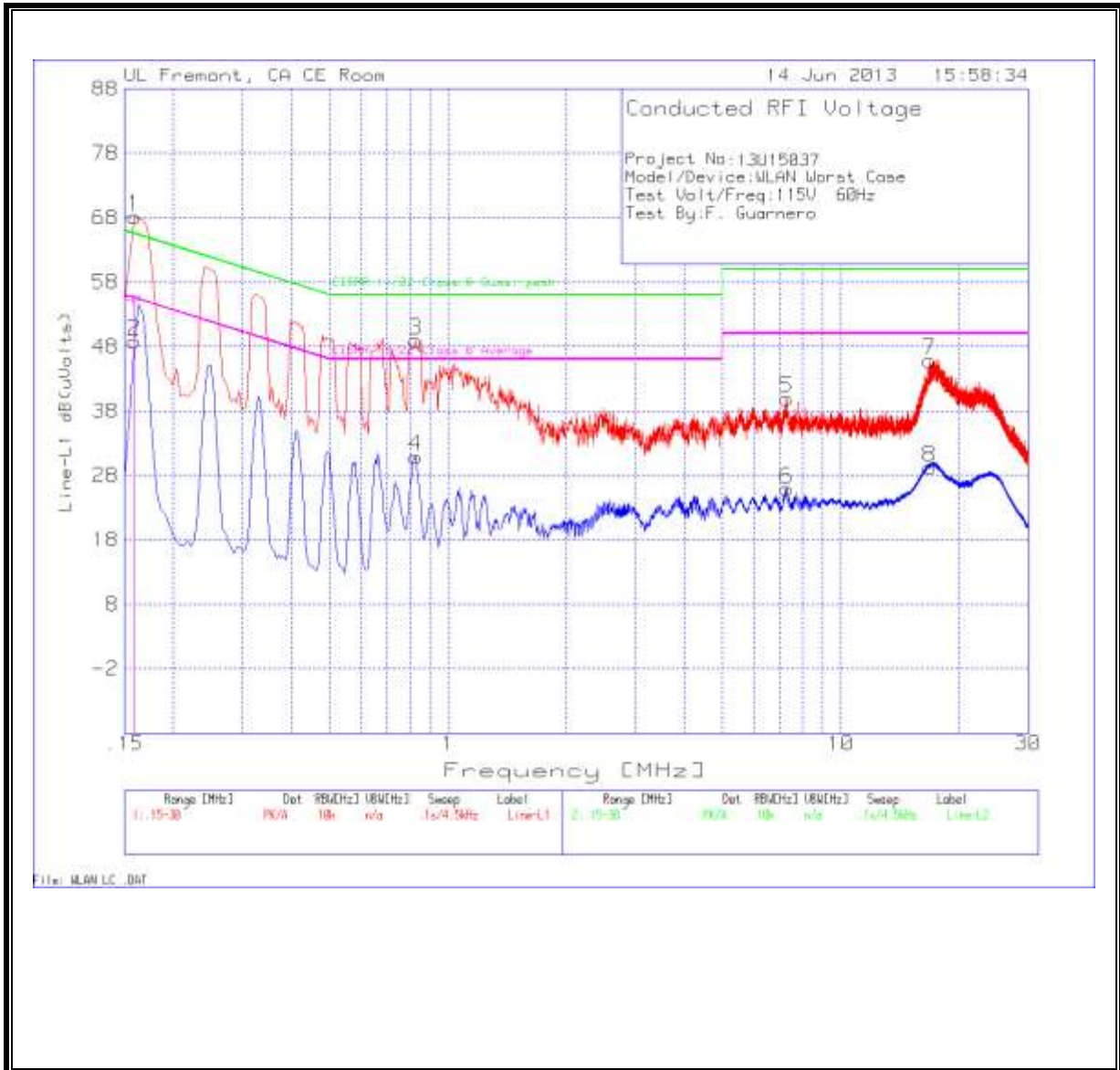

**LINE 2 RESULTS**

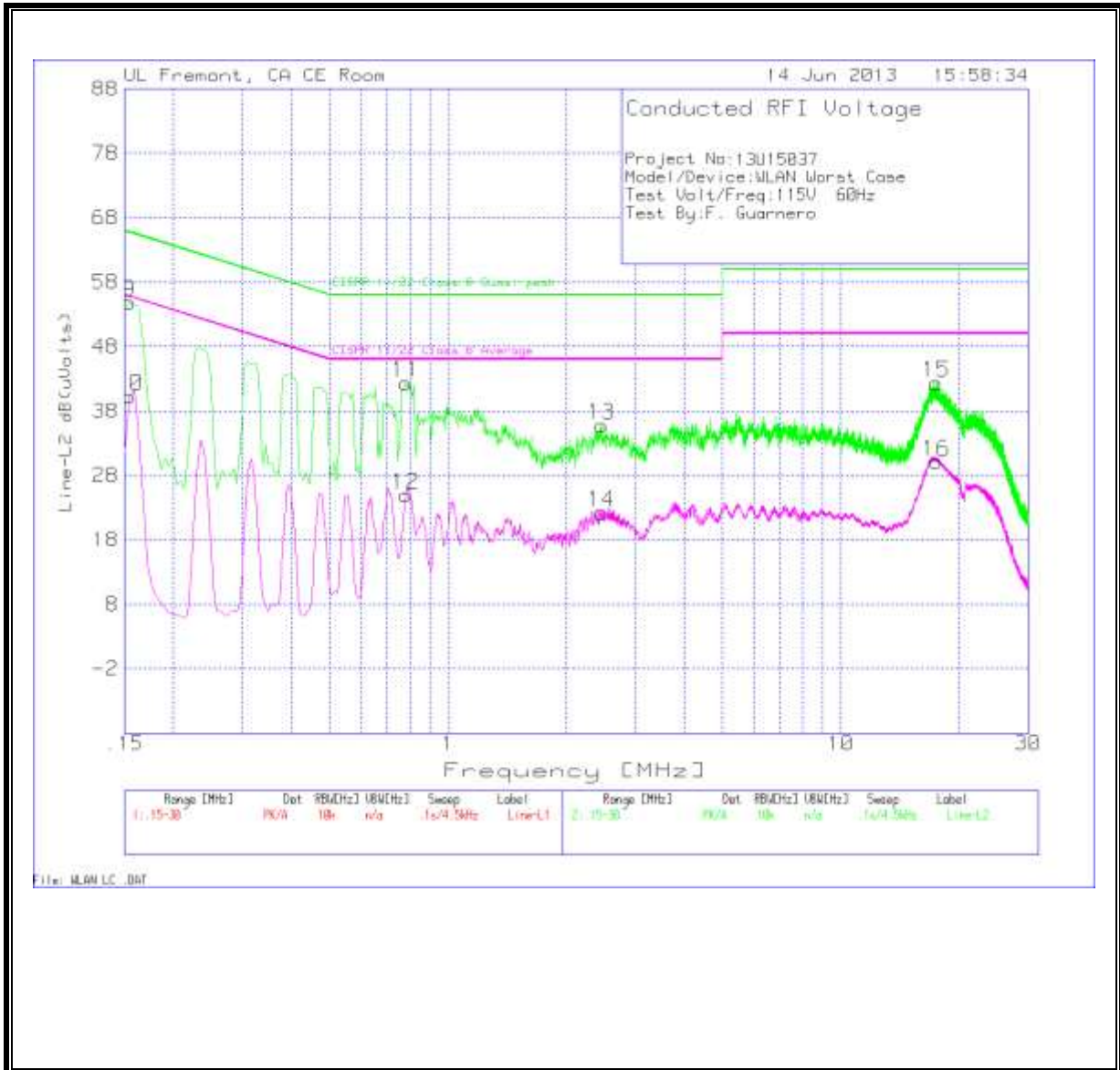

## 11. DYNAMIC FREQUENCY SELECTION

### 11.1. OVERVIEW

#### 11.1.1. LIMITS

##### INDUSTRY CANADA

IC RSS-210 is closely harmonized with FCC Part 15 DFS rules. The deviations are as follows:

RSS-210 Issue 7 A9.4 (b) (ii) **Channel Availability Check Time:** ...

**Additional requirements for the band 5600-5650 MHz:** Until further notice, devices subject to this Section shall not be capable of transmitting in the band 5600-5650 MHz, so that Environment Canada weather radars operating in this band are protected.

RSS-210 Issue 7 A9.4 (b) (iv) **Channel closing time:** the maximum channel closing time is 260 ms.

##### FCC

§15.407 (h) and FCC 06-96 APPENDIX "COMPLIANCE MEASUREMENT PROCEDURES FOR UNLICENSED-NATIONAL INFORMATION INFRASTRUCTURE DEVCIES OPERATING IN THE 5250-5350 MHz AND 5470-5725 MHz BANDS INCORPORATING DYNAMIC FREQUENCY SELECTION".

**Table 1: Applicability of DFS requirements prior to use of a channel**

Requirement	Operational Mode		
	Master	Client (without radar detection)	Client (with radar detection)
Non-Occupancy Period	Yes	Not required	Yes
DFS Detection Threshold	Yes	Not required	Yes
Channel Availability Check Time	Yes	Not required	Not required
Uniform Spreading	Yes	Not required	Not required

**Table 2: Applicability of DFS requirements during normal operation**

Requirement	Operational Mode		
	Master	Client (without DFS)	Client (with DFS)
DFS Detection Threshold	Yes	Not required	Yes
Channel Closing Transmission Time	Yes	Yes	Yes
Channel Move Time	Yes	Yes	Yes

**Table 3: Interference Threshold values, Master or Client incorporating In-Service Monitoring**

Maximum Transmit Power	Value (see note)
≥ 200 milliwatt	-64 dBm
< 200 milliwatt	-62 dBm
Note 1: This is the level at the input of the receiver assuming a 0 dBi receive antenna Note 2: Throughout these test procedures an additional 1 dB has been added to the amplitude of the test transmission waveforms to account for variations in measurement equipment. This will ensure that the test signal is at or above the detection threshold level to trigger a DFS response.	

**Table 4: DFS Response requirement values**

Parameter	Value
<i>Non-occupancy period</i>	30 minutes
<i>Channel Availability Check Time</i>	60 seconds
<i>Channel Move Time</i>	10 seconds
<i>Channel Closing Transmission Time</i>	200 milliseconds + approx. 60 milliseconds over remaining 10 second period

The instant that the *Channel Move Time* and the *Channel Closing Transmission Time* begins is as follows:  
 For the Short pulse radar Test Signals this instant is the end of the *Burst*.  
 For the Frequency Hopping radar Test Signal, this instant is the end of the last radar burst generated.  
 For the Long Pulse radar Test Signal this instant is the end of the 12 second period defining the radar transmission.  
 The Channel Closing Transmission Time is comprised of 200 milliseconds starting at the beginning of the Channel Move Time plus any additional intermittent control signals required to facilitate channel changes (an aggregate of approximately 60 milliseconds) during the remainder of the 10 second period. The aggregate duration of control signals will not count quiet periods in between transmissions.

**Table 5 – Short Pulse Radar Test Waveforms**

Radar Type	Pulse Width (Microseconds)	PRI (Microseconds)	Pulses	Minimum Percentage of Successful Detection	Minimum Trials
1	1	1428	18	60%	30
2	1-5	150-230	23-29	60%	30
3	6-10	200-500	16-18	60%	30
4	11-20	200-500	12-16	60%	30
Aggregate (Radar Types 1-4)				80%	120

**Table 6 – Long Pulse Radar Test Signal**

Radar Waveform	Bursts	Pulses per Burst	Pulse Width (µsec)	Chirp Width (MHz)	PRI (µsec)	Minimum Percentage of Successful Detection	Minimum Trials
5	8-20	1-3	50-100	5-20	1000-2000	80%	30

**Table 7 – Frequency Hopping Radar Test Signal**

Radar Waveform	Pulse Width (µsec)	PRI (µsec)	Burst Length (ms)	Pulses per Hop	Hopping Rate (kHz)	Minimum Percentage of Successful Detection	Minimum Trials
6	1	333	300	9	.333	70%	30

### 11.1.2. TEST AND MEASUREMENT SYSTEM

#### RADIATED METHOD SYSTEM BLOCK DIAGRAM

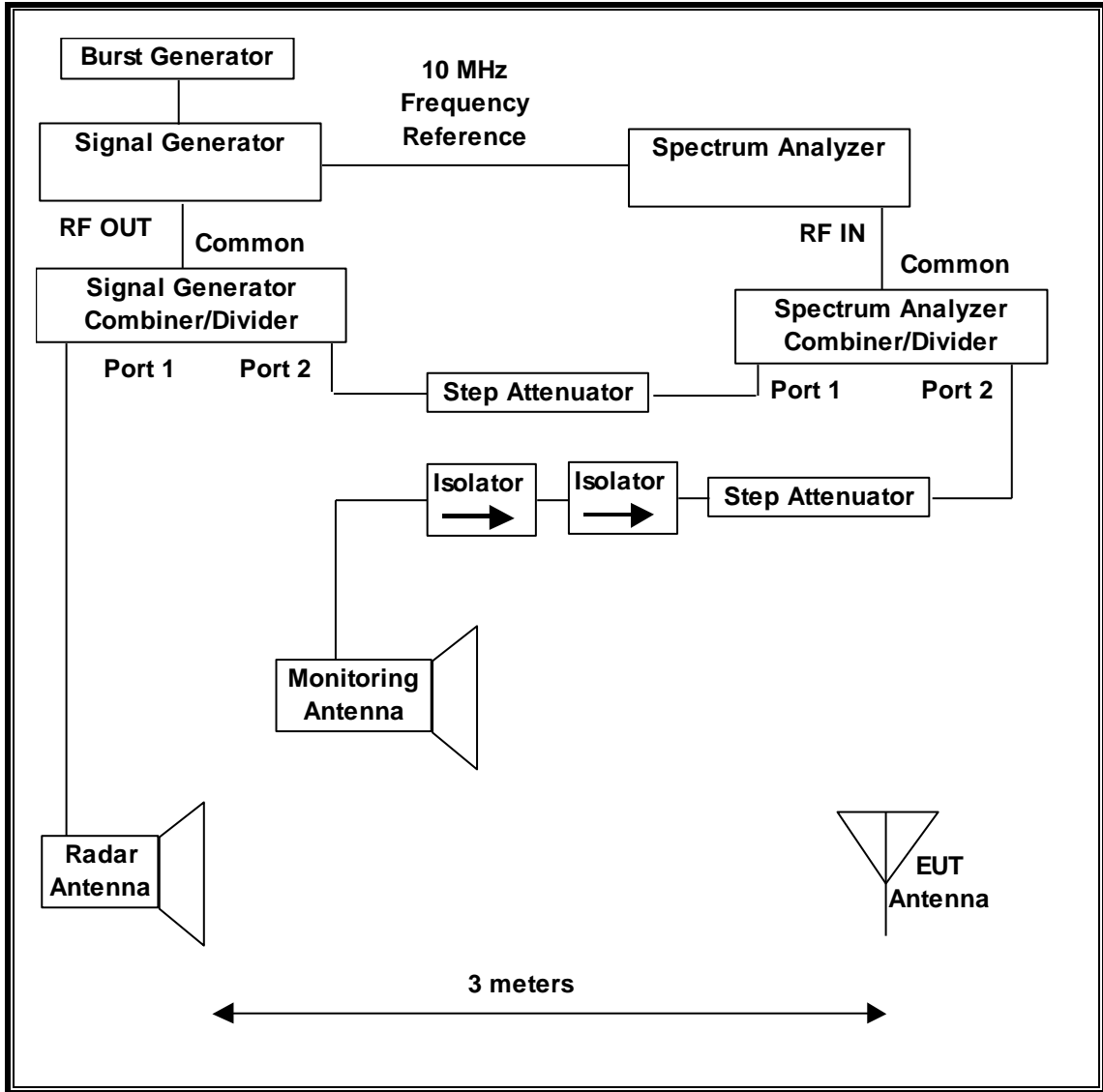

## **SYSTEM OVERVIEW**

The short pulse and long pulse signal generating system utilizes the NTIA software. The Vector Signal Generator has been validated by the NTIA. The hopping signal generating system utilizes the CCS simulated hopping method and system, which has been validated by the DoD, FCC and NTIA. The software selects waveform parameters from within the bounds of the signal type on a random basis using uniform distribution.

The short pulse types 2, 3 and 4, and the long pulse type 5 parameters are randomized at run-time.

The hopping type 6 pulse parameters are fixed while the hopping sequence is based on the August 2005 NTIA Hopping Frequency List. The initial starting point randomized at run-time and each subsequent starting point is incremented by 475. Each frequency in the 100-length segment is compared to the boundaries of the EUT Detection Bandwidth and the software creates a hopping burst pattern in accordance with Section 7.4.1.3 Method #2 Simulated Frequency Hopping Radar Waveform Generating Subsystem of FCC 06-96 APPENDIX. The frequency of the signal generator is incremented in 1 MHz steps from  $F_L$  to  $F_H$  for each successive trial. This incremental sequence is repeated as required to generate a minimum of 30 total trials and to maintain a uniform frequency distribution over the entire Detection Bandwidth.

The signal monitoring equipment consists of a spectrum analyzer. The aggregate ON time is calculated by multiplying the number of bins above a threshold during a particular observation period by the dwell time per bin, with the analyzer set to peak detection and max hold.

## **SYSTEM CALIBRATION**

A 50-ohm load is connected in place of the spectrum analyzer, and the spectrum analyzer is connected to a horn antenna via a coaxial cable, with the reference level offset set to (horn antenna gain – coaxial cable loss). The signal generator is set to CW mode. The amplitude of the signal generator is adjusted to yield a level of –64 dBm as measured on the spectrum analyzer.

Without changing any of the instrument settings, the spectrum analyzer is reconnected to the Common port of the Spectrum Analyzer Combiner/Divider. The Reference Level Offset of the spectrum analyzer is adjusted so that the displayed amplitude of the signal is –64 dBm.

The spectrum analyzer displays the level of the signal generator as received at the antenna ports of the Master Device. The interference detection threshold may be varied from the calibrated value of –64 dBm and the spectrum analyzer will still indicate the level as received by the Master Device.



**ADJUSTMENT OF DISPLAYED TRAFFIC LEVEL**

A link is established between the Master and Slave and the distance between the units is adjusted as needed to provide a suitable received level at the Master and Slave devices. The video test file is streamed to generate WLAN traffic. The monitoring antenna is adjusted so that the WLAN traffic level, as displayed on the spectrum analyzer, is at lower amplitude than the radar detection threshold.

**TEST AND MEASUREMENT EQUIPMENT**

The following test and measurement equipment was utilized for the DFS tests documented in this report:

<b>TEST EQUIPMENT LIST</b>				
<b>Description</b>	<b>Manufacturer</b>	<b>Model</b>	<b>Asset Number</b>	<b>Cal Due</b>
Spectrum Analyzer, 26.5 GHz	Agilent / HP	E4440A	C01178	08/18/13
Vector Signal Generator, 20GHz	Agilent / HP	E8267C	C01066	11/20/13

### 11.1.3. SETUP OF EUT (CLIENT MODE)

#### RADIATED METHOD EUT TEST SETUP

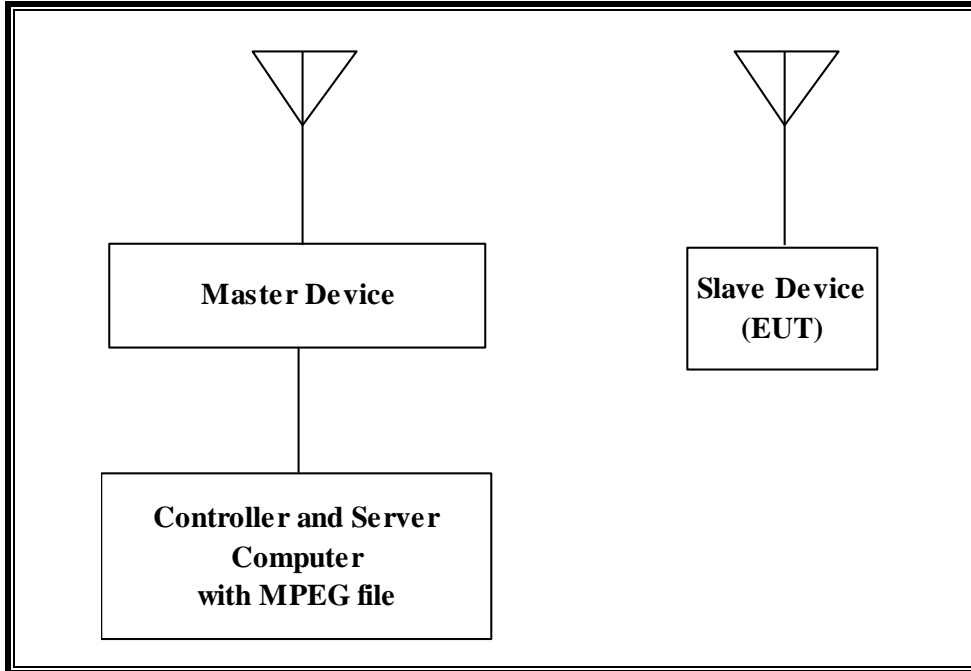

#### SUPPORT EQUIPMENT

The following support equipment was utilized for the DFS tests documented in this report:

PERIPHERAL SUPPORT EQUIPMENT LIST				
Description	Manufacturer	Model	Serial Number	FCC ID
Wireless Access Point (Master Device)	Cisco	AIR-AP1252AG-A-K9	FTX130390D9	LDK102061
AC Adapter (AP)	Delta Electronics	EADP-45BB B	DTH1049902N	DoC
Notebook PC (Controller/Server)	Apple	MacBook Pro A1150	AOU257941	DoC
AC Adapter (Controller/Server PC)	Delta Electronics	A1330	MV952157KAGKA	DoC

### 11.1.4. SETUP OF EUT (CLIENT-TO-CLIENT COMMUNICATIONS MODE)

#### RADIATED METHOD EUT TEST SETUP

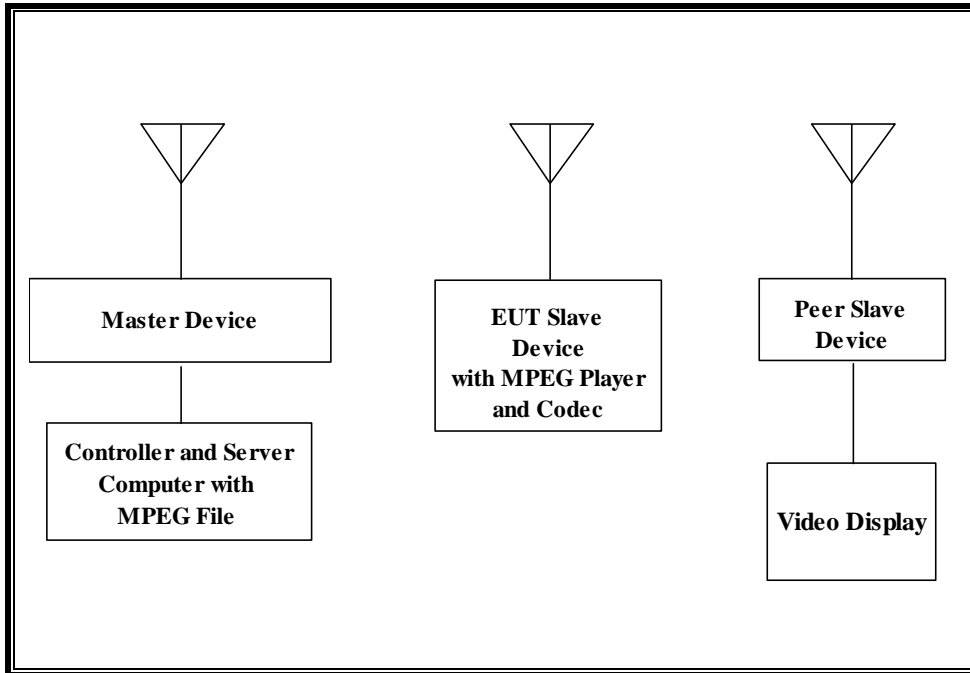

#### SUPPORT EQUIPMENT

The following support equipment was utilized for the DFS tests documented in this report:

PERIPHERAL SUPPORT EQUIPMENT LIST				
Description	Manufacturer	Model	Serial Number	FCC ID
Wireless Access Point (Master Device)	Cisco	AIR-AP1252AG-A-K9	FTX130390D9	LDK102061
AC Adapter (AP)	Delta Electronics	EADP-45BB B	DTH1049902N	DoC
Notebook PC (Controller/Server)	Apple	MacBook Pro A1150	AOU257941	DoC
AC Adapter (Controller/Server PC)	Delta Electronics	A1330	MV952157KAGKA	DoC
Apple TV (Peer Slave)	Apple	A1469	V07JV1Z7FF54	BCGA1469
Video Display	Dell	U2410f	CN-0FJ525N-72872-1B5-AGAL	DoC

### **11.1.5. DESCRIPTION OF EUT**

The EUT operates over the 5250-5350 MHz and 5470-5725 MHz ranges.

The EUT is a Slave Device without Radar Detection.

The highest power level within these bands is 15.81 dBm EIRP in the 5250-5350 MHz band and 15.45 dBm EIRP in the 5470-5725 MHz band.

The only antenna assembly utilized with the EUT has a gain of  $-0.37\text{dBi}$  in the 5250-5350 MHz band and  $1.31\text{dBi}$  in the 5470-5725 MHz band.

The rated output power of the Master unit is  $> 23\text{dBm}$  (EIRP). Therefore the required interference threshold level is  $-64\text{ dBm}$ . After correction for procedural adjustments, the required radiated threshold at the antenna port is  $-64 + 1 = -63\text{ dBm}$ .

The calibrated radiated DFS Detection Threshold level is set to  $-64\text{ dBm}$ . The tested level is lower than the required level hence it provides margin to the limit.

The EUT uses one transmitter/receiver chain connected to an antenna to perform radiated tests.

WLAN traffic is generated by streaming the video file TestFile.mp2 "6 ½ Magic Hours" from the Master to the Slave in full motion video mode using Safari web browser.

TPC is not required since the maximum EIRP is less than 500 mW (27 dBm).

The EUT utilizes the 802.11a/n architecture. Two nominal channel bandwidths of 20 MHz and 40 MHz are implemented.

The software installed in the EUT is 11A5400f.

### **UNIFORM CHANNEL SPREADING**

This requirement is not applicable to Slave radio devices.

**OVERVIEW OF MASTER DEVICE WITH RESPECT TO §15.407 (h) REQUIREMENTS**

The Master Device is a Cisco Access Point, FCC ID: LDK102061. The minimum antenna gain for the Master Device is 3.5 dBi.

The rated output power of the Master unit is  $> 23\text{dBm}$  (EIRP). Therefore the required interference threshold level is  $-64\text{ dBm}$ . After correction for procedural adjustments, the required radiated threshold at the antenna port is  $-64 + 1 = -63\text{ dBm}$ .

The calibrated radiated DFS Detection Threshold level is set to  $-64\text{ dBm}$ . The tested level is lower than the required level hence it provides margin to the limit.

The software installed in the access point is 12.4(25d)JA1.

## 11.2. CLIENT MODE RESULTS FOR 20 MHz BANDWIDTH

### 11.2.1. TEST CHANNEL

All tests were performed at a channel center frequency of 5500 MHz.

### 11.2.2. RADAR WAVEFORM AND TRAFFIC

#### RADAR WAVEFORM

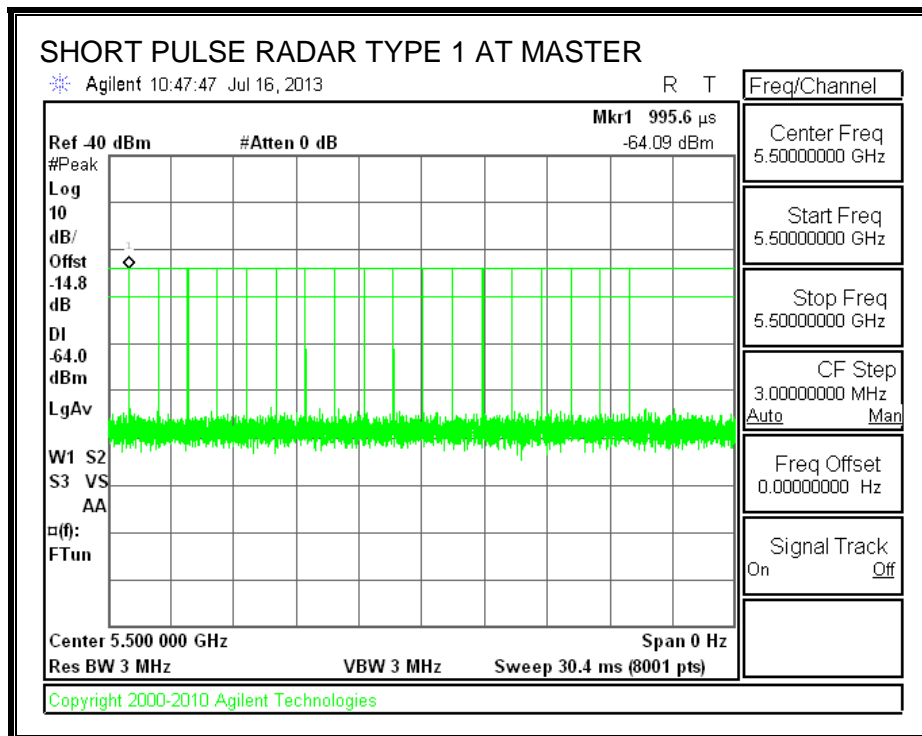

**TRAFFIC**

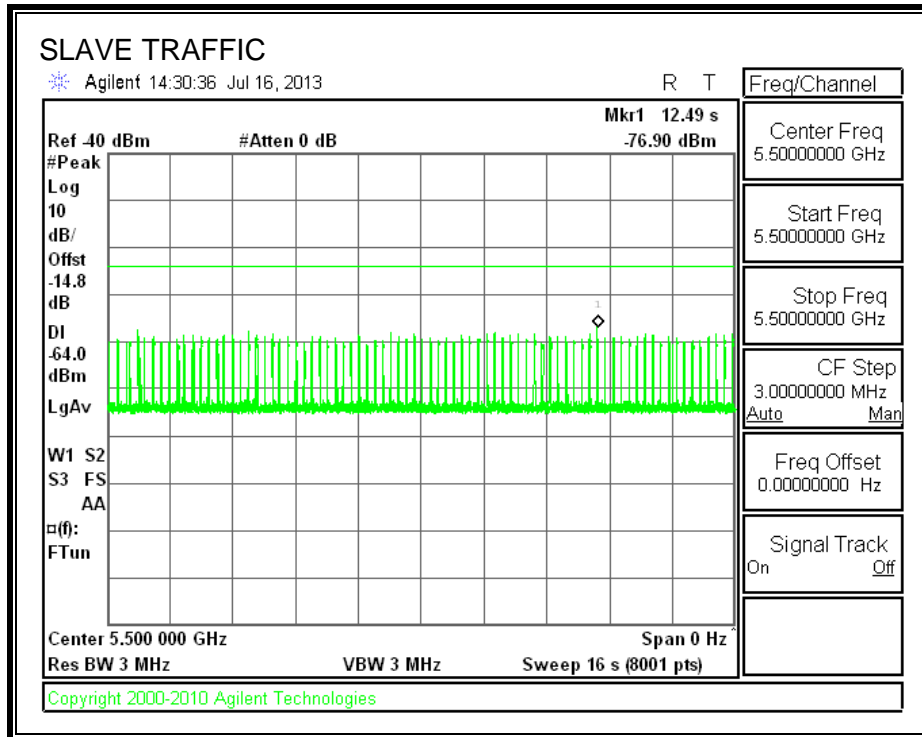

**11.2.3. OVERLAPPING CHANNEL TESTS**

**RESULTS**

These tests are not applicable.

**11.2.4. MOVE AND CLOSING TIME**

**REPORTING NOTES**

The reference marker is set at the end of last radar pulse.

The delta marker is set at the end of the last WLAN transmission following the radar pulse. This delta is the channel move time.

The aggregate channel closing transmission time is calculated as follows:

Aggregate Transmission Time =  
 (Number of analyzer bins showing transmission) \* (dwell time per bin)

The observation period over which the FCC aggregate time is calculated begins at (Reference Marker + 200 msec) and ends no earlier than (Reference Marker + 10 sec).

The observation period over which the IC aggregate time is calculated begins at (Reference Marker) and ends no earlier than (Reference Marker + 10 sec).

**RESULTS**

Agency	Channel Move Time (sec)	Limit (sec)
FCC / IC	0.036	10

Agency	Aggregate Channel Closing Transmission Time (msec)	Limit (msec)
FCC	0.0	60
IC	2.0	260



**MOVE TIME**

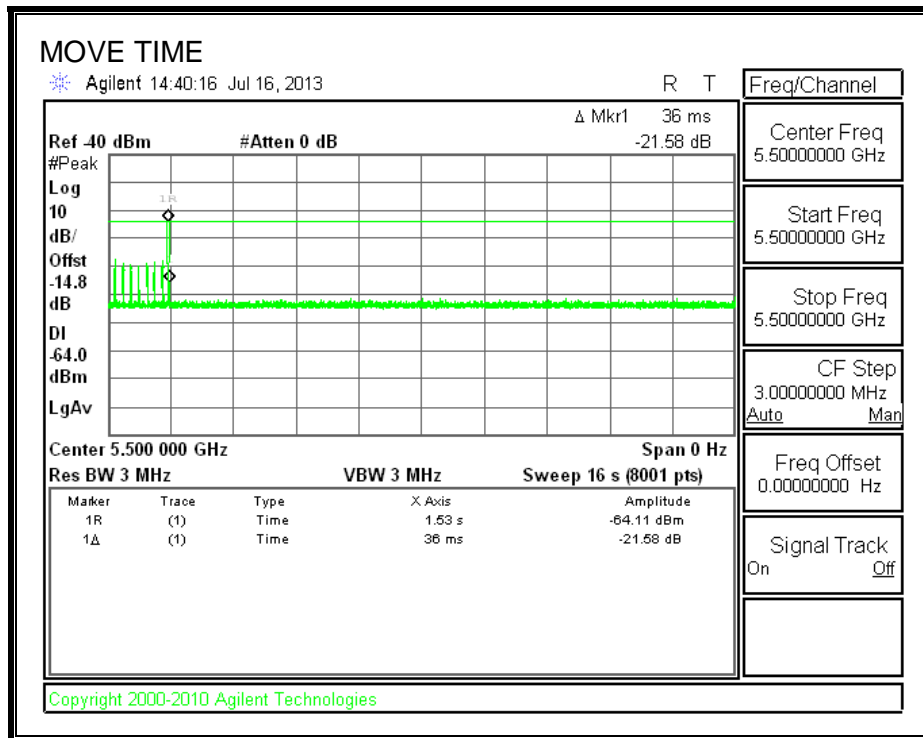

**CHANNEL CLOSING TIME**

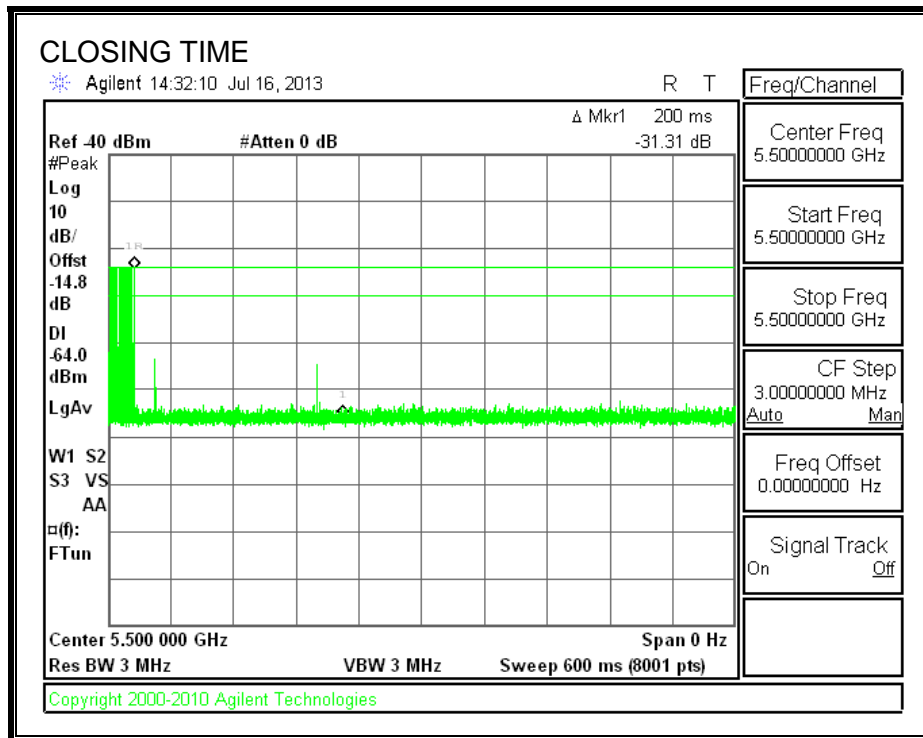

**AGGREGATE CHANNEL CLOSING TRANSMISSION TIME**

No transmissions are observed during the FCC aggregate monitoring period.

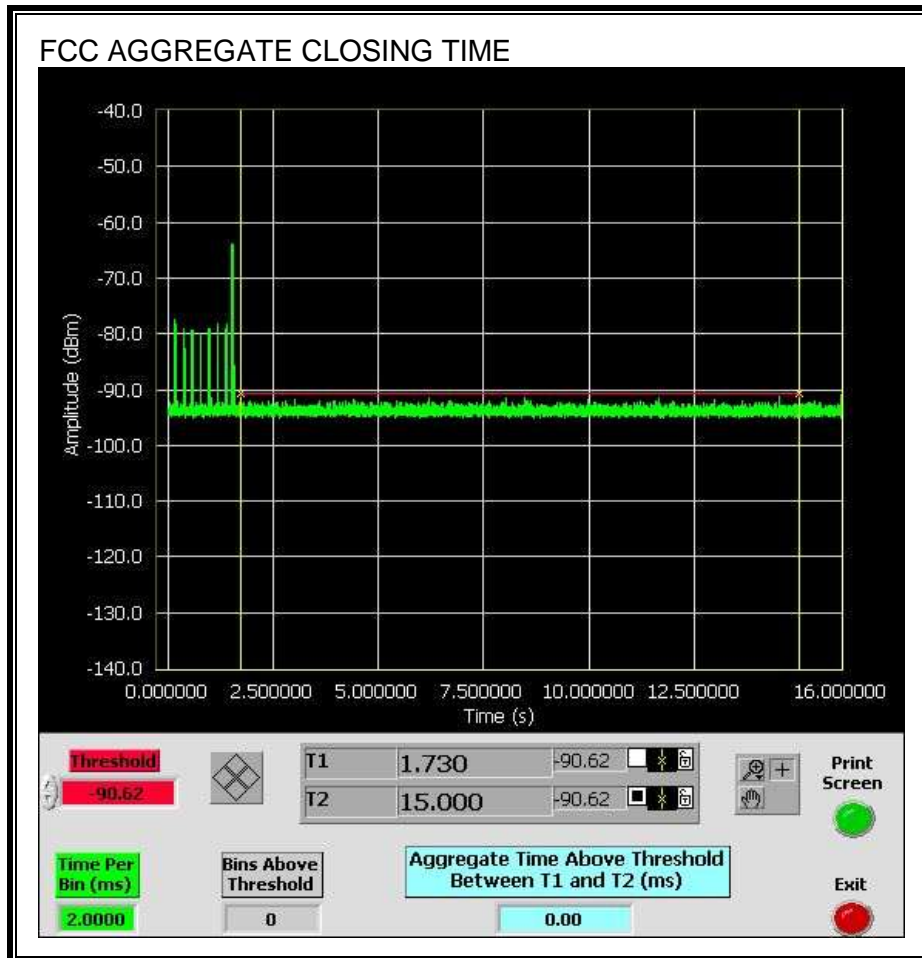

Only intermittent transmissions are observed during the IC aggregate monitoring period.

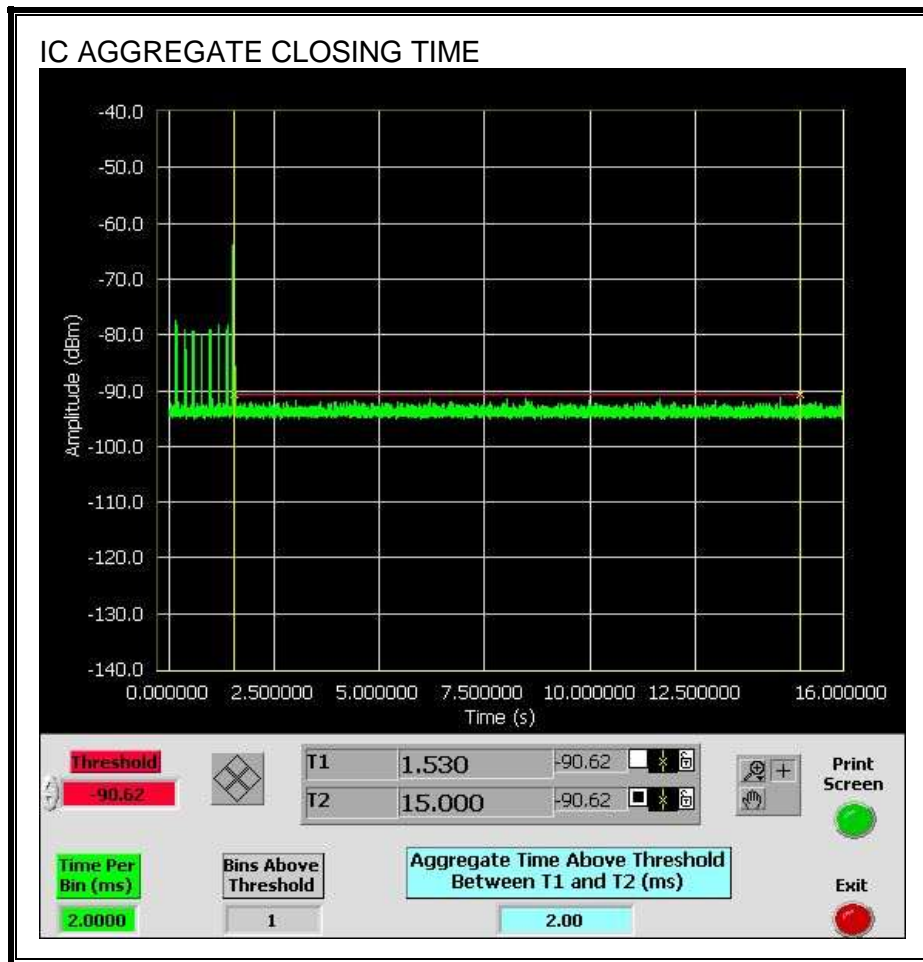

### 11.3. CLIENT MODE RESULTS FOR 40 MHz BANDWIDTH

#### 11.3.1. TEST CHANNEL

All tests were performed at a channel center frequency of 5510 MHz.

#### 11.3.2. RADAR WAVEFORM AND TRAFFIC

##### RADAR WAVEFORM

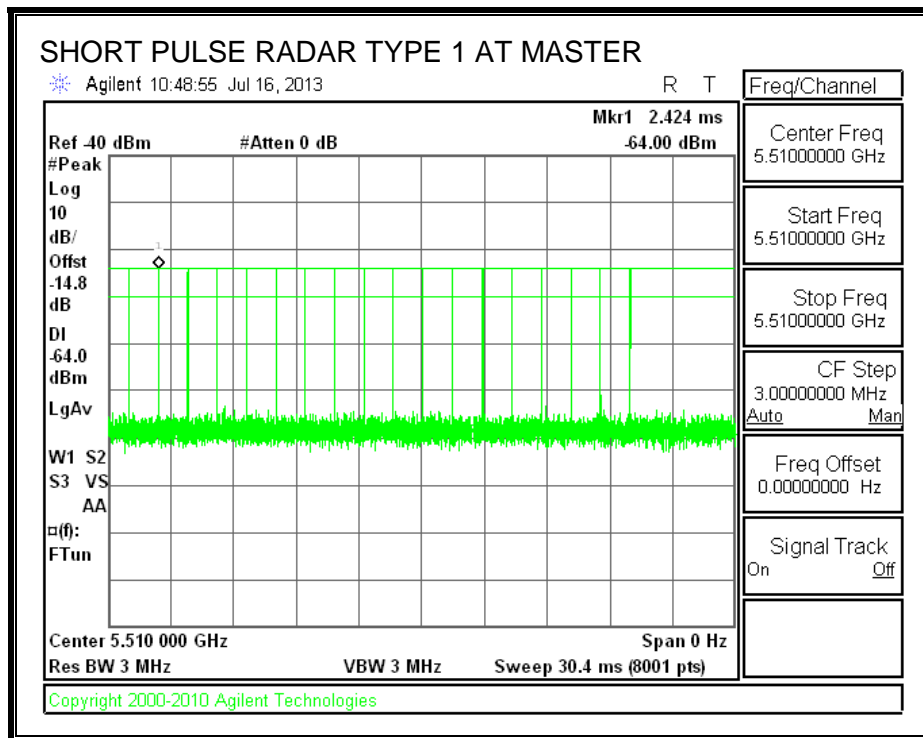

**TRAFFIC**

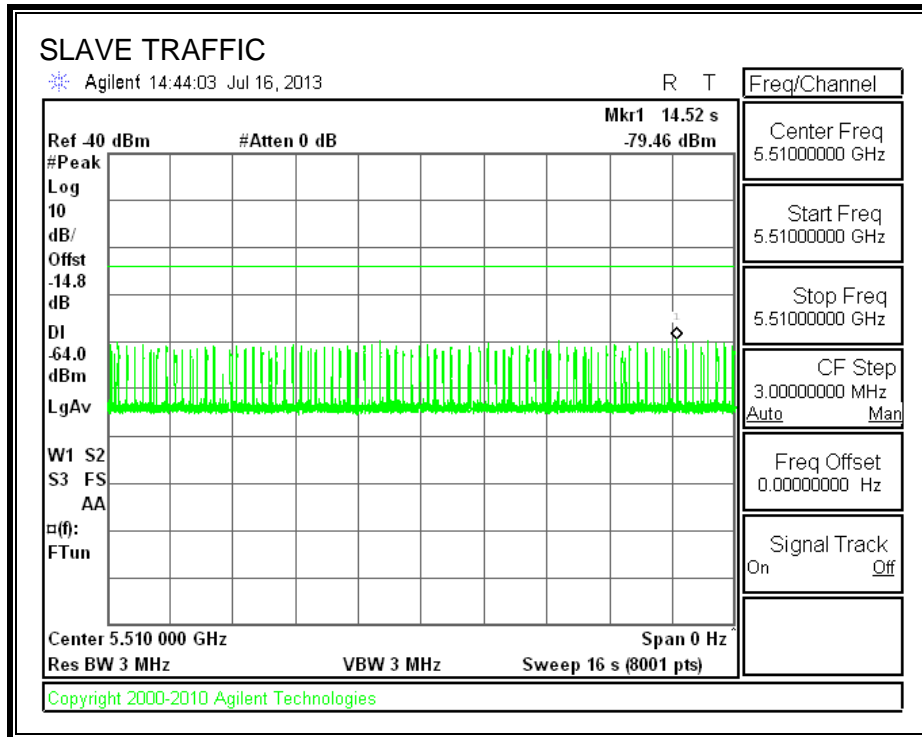

### 11.3.3. OVERLAPPING CHANNEL TESTS

#### RESULTS

These tests are not applicable.

### 11.3.4. MOVE AND CLOSING TIME

#### REPORTING NOTES

The reference marker is set at the end of last radar pulse.

The delta marker is set at the end of the last WLAN transmission following the radar pulse. This delta is the channel move time.

The aggregate channel closing transmission time is calculated as follows:

Aggregate Transmission Time =  
(Number of analyzer bins showing transmission) \* (dwell time per bin)

The observation period over which the FCC aggregate time is calculated begins at (Reference Marker + 200 msec) and ends no earlier than (Reference Marker + 10 sec).

The observation period over which the IC aggregate time is calculated begins at (Reference Marker) and ends no earlier than (Reference Marker + 10 sec).

#### RESULTS

Agency	Channel Move Time (sec)	Limit (sec)
FCC / IC	0.000	10

Agency	Aggregate Channel Closing Transmission Time (msec)	Limit (msec)
FCC	0.0	60
IC	0.0	260

**MOVE TIME**

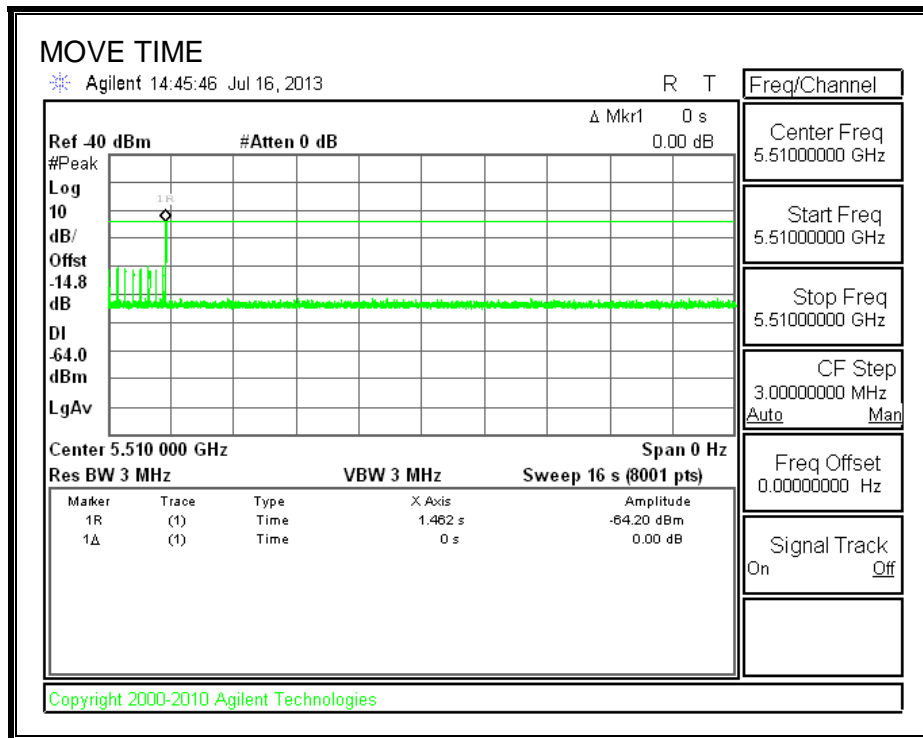



**CHANNEL CLOSING TIME**

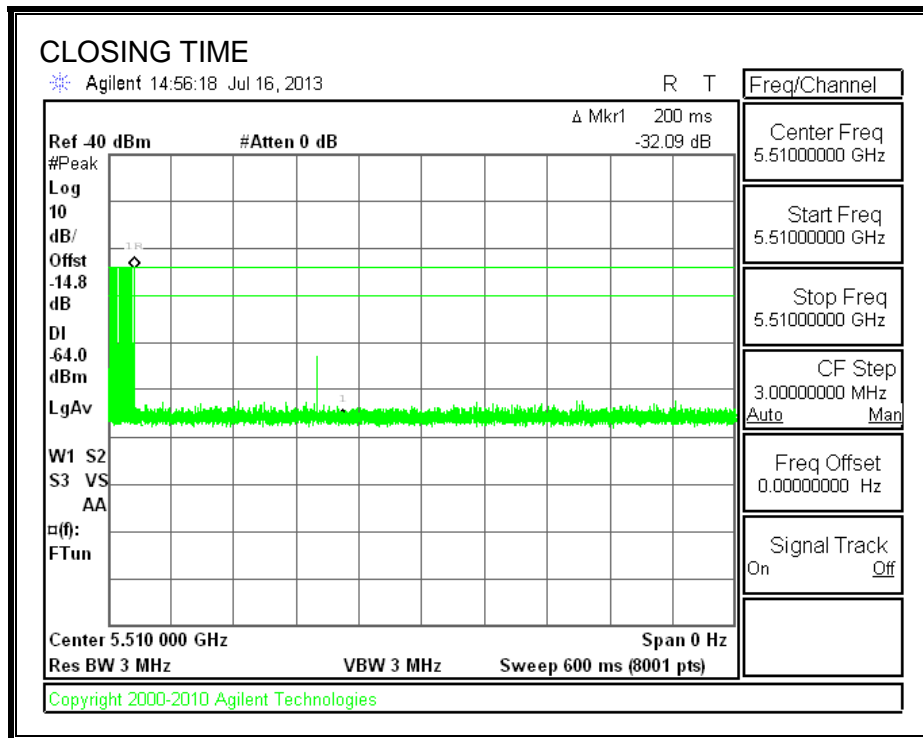

**AGGREGATE CHANNEL CLOSING TRANSMISSION TIME**

No transmissions are observed during the FCC aggregate monitoring period.

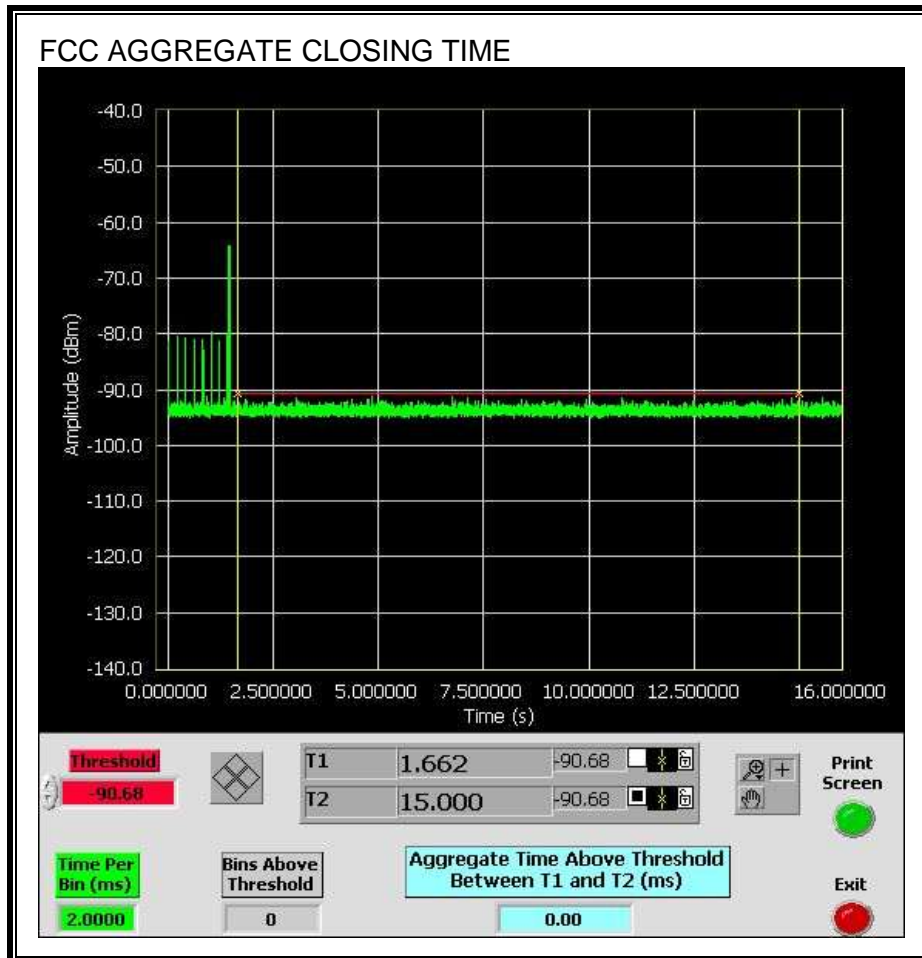

No transmissions are observed during the IC aggregate monitoring period.

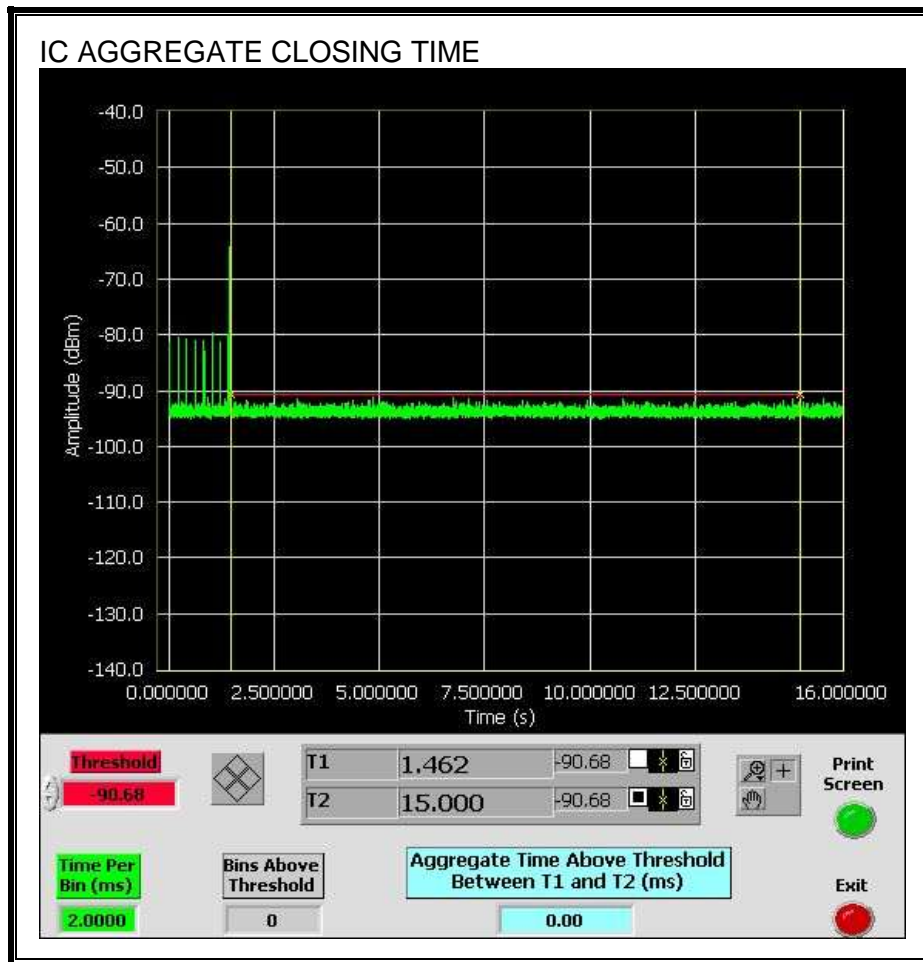

### 11.3.5. NON-OCCUPANCY PERIOD

#### RESULTS

No EUT transmissions were observed on the test channel during the 30-minute observation time.

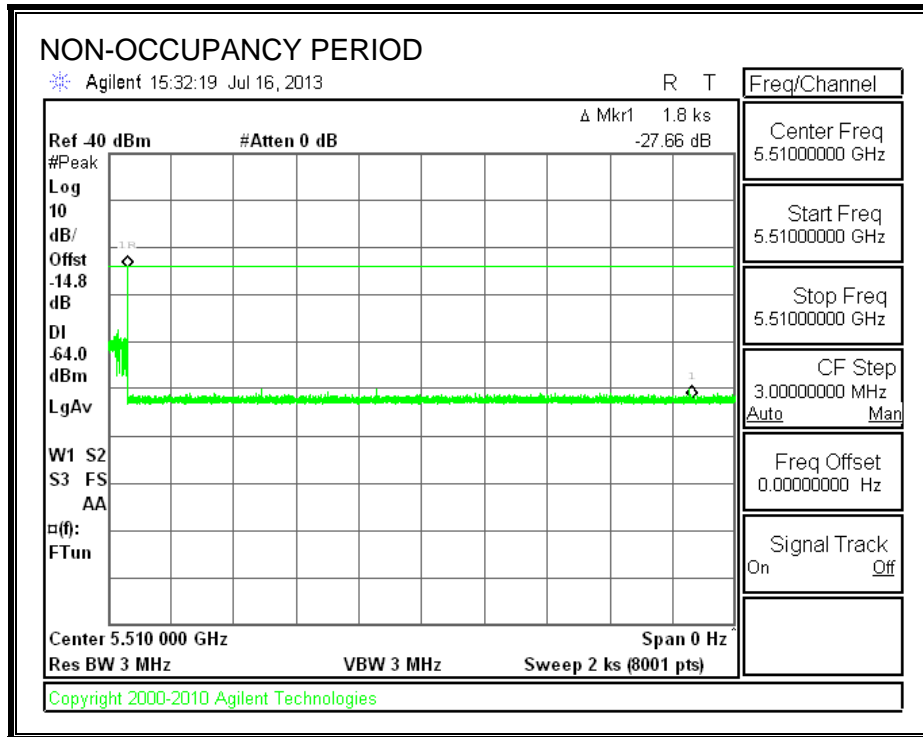

## 11.4. CLIENT-TO-CLIENT COMMUNICATIONS MODE RESULTS FOR 20 MHz BANDWIDTH

### 11.4.1. TEST CHANNEL

All tests were performed at a channel center frequency of 5500 MHz.

### 11.4.2. RADAR WAVEFORM AND TRAFFIC

#### RADAR WAVEFORM

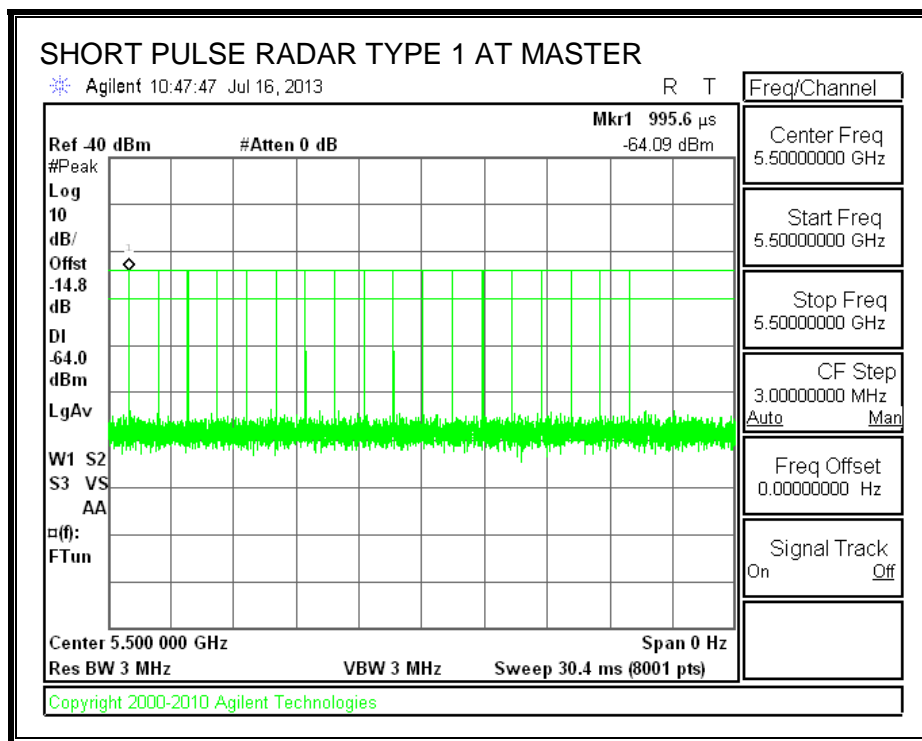

**TRAFFIC**

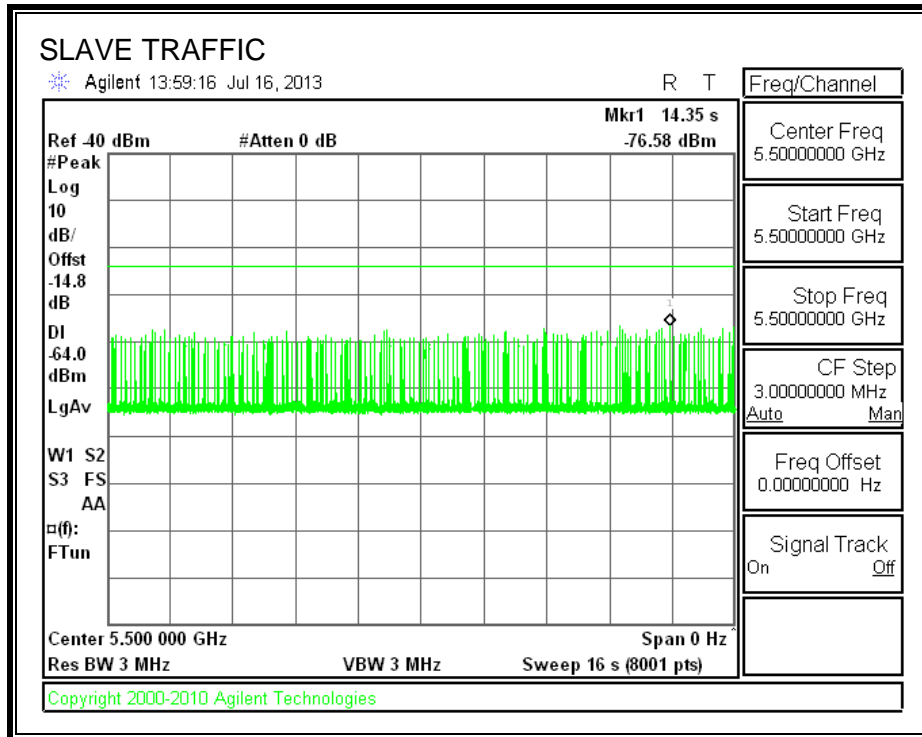

### 11.4.3. OVERLAPPING CHANNEL TESTS

#### RESULTS

These tests are not applicable.

### 11.4.4. MOVE AND CLOSING TIME

#### REPORTING NOTES

The reference marker is set at the end of last radar pulse.

The delta marker is set at the end of the last WLAN transmission following the radar pulse. This delta is the channel move time.

The aggregate channel closing transmission time is calculated as follows:

Aggregate Transmission Time =  
(Number of analyzer bins showing transmission) \* (dwell time per bin)

The observation period over which the FCC aggregate time is calculated begins at (Reference Marker + 200 msec) and ends no earlier than (Reference Marker + 10 sec).

The observation period over which the IC aggregate time is calculated begins at (Reference Marker) and ends no earlier than (Reference Marker + 10 sec).

#### RESULTS

Agency	Channel Move Time (sec)	Limit (sec)
FCC / IC	0.180	10

Agency	Aggregate Channel Closing Transmission Time (msec)	Limit (msec)
FCC	0.0	60
IC	10.0	260

**MOVE TIME**

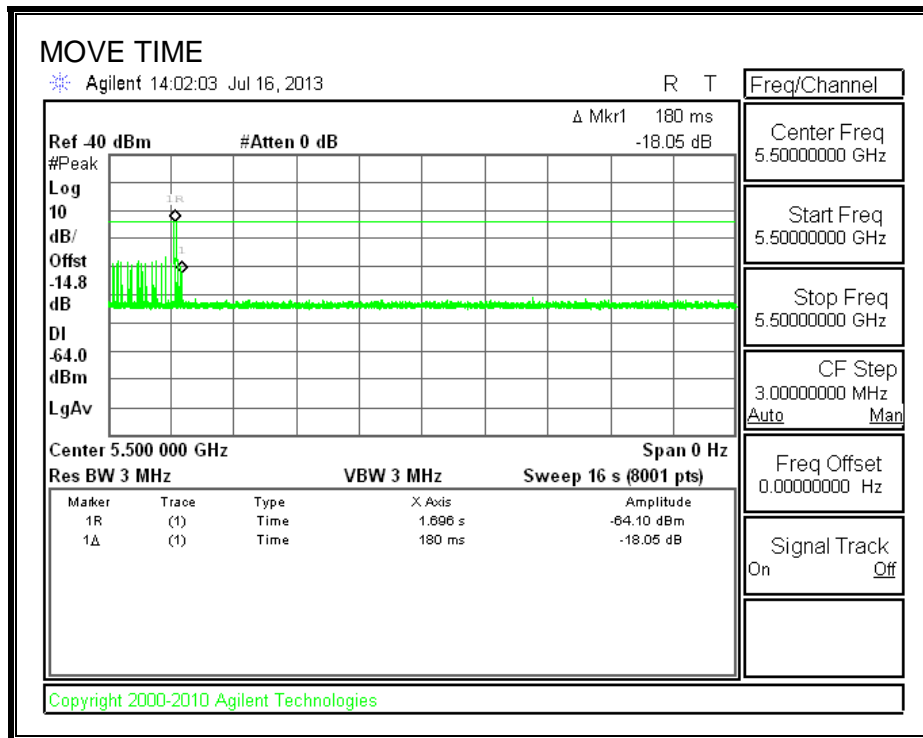



**CHANNEL CLOSING TIME**

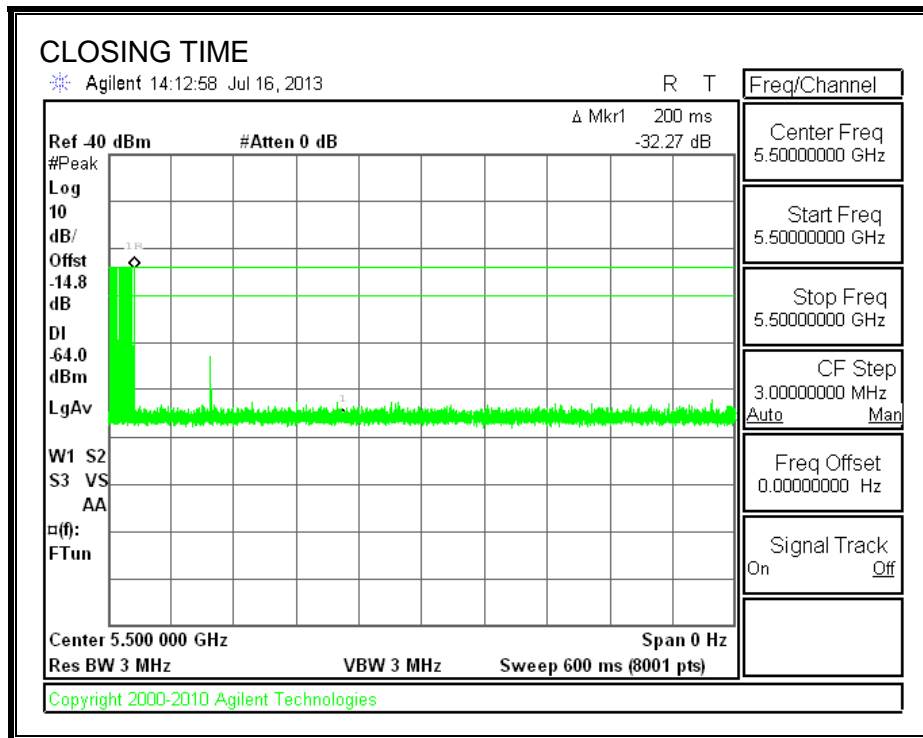

**AGGREGATE CHANNEL CLOSING TRANSMISSION TIME**

No transmissions are observed during the FCC aggregate monitoring period.

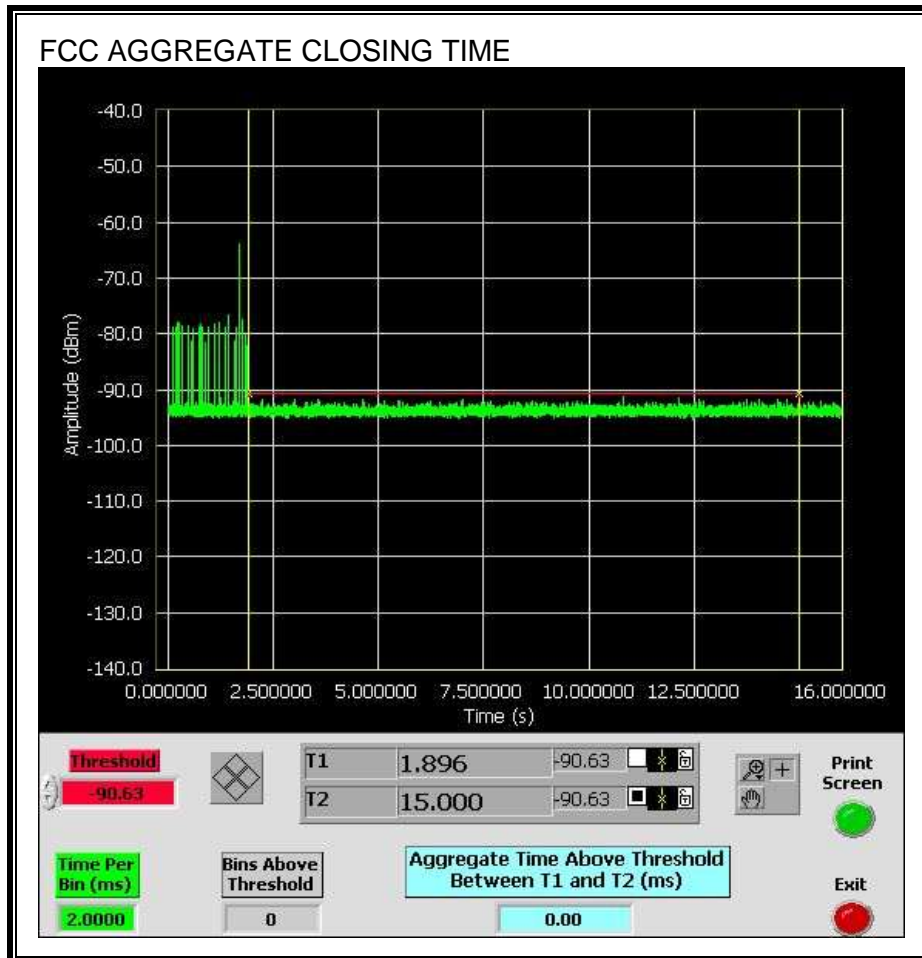

Only intermittent transmissions are observed during the IC aggregate monitoring period.

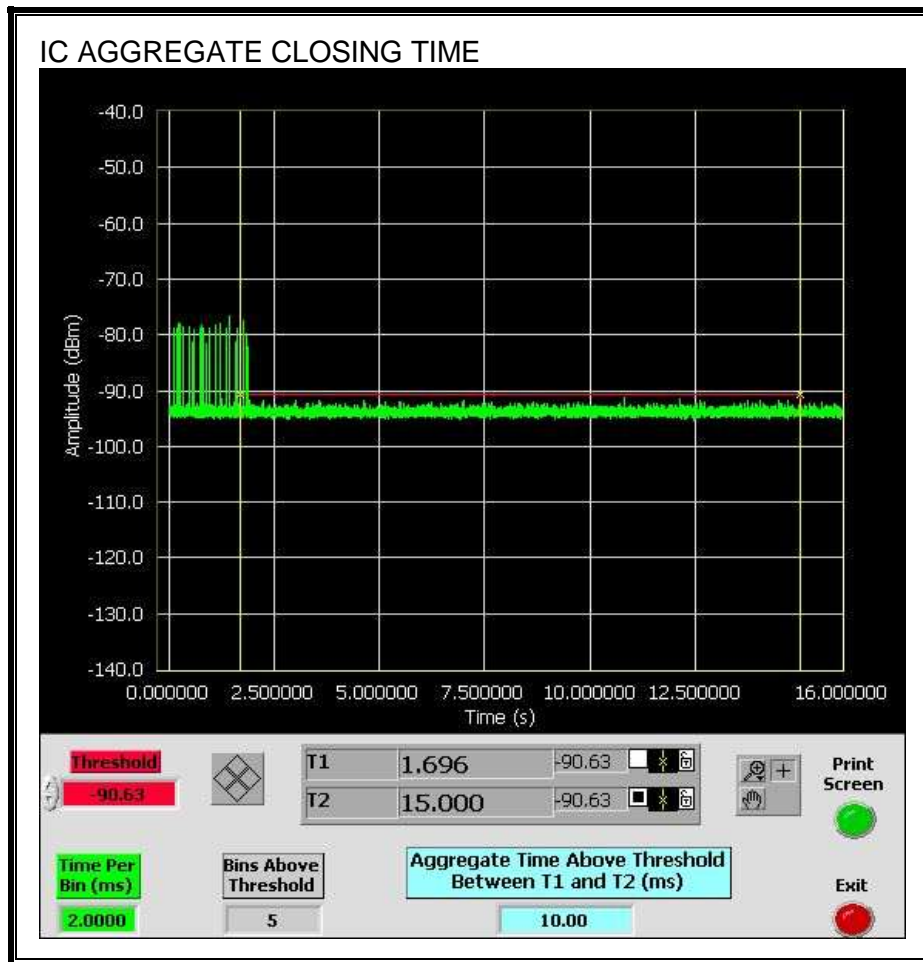

## 11.5. CLIENT-TO-CLIENT COMMUNICATIONS MODE RESULTS FOR 40 MHz BANDWIDTH

### 11.5.1. TEST CHANNEL

All tests were performed at a channel center frequency of 5510 MHz.

### 11.5.2. RADAR WAVEFORM AND TRAFFIC

#### RADAR WAVEFORM

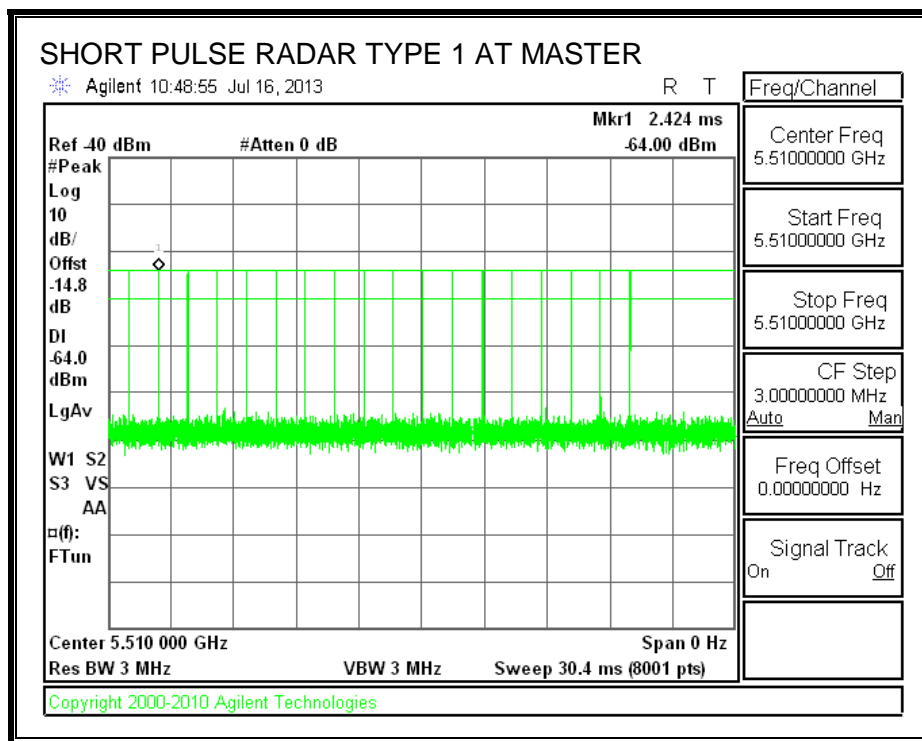

**TRAFFIC**

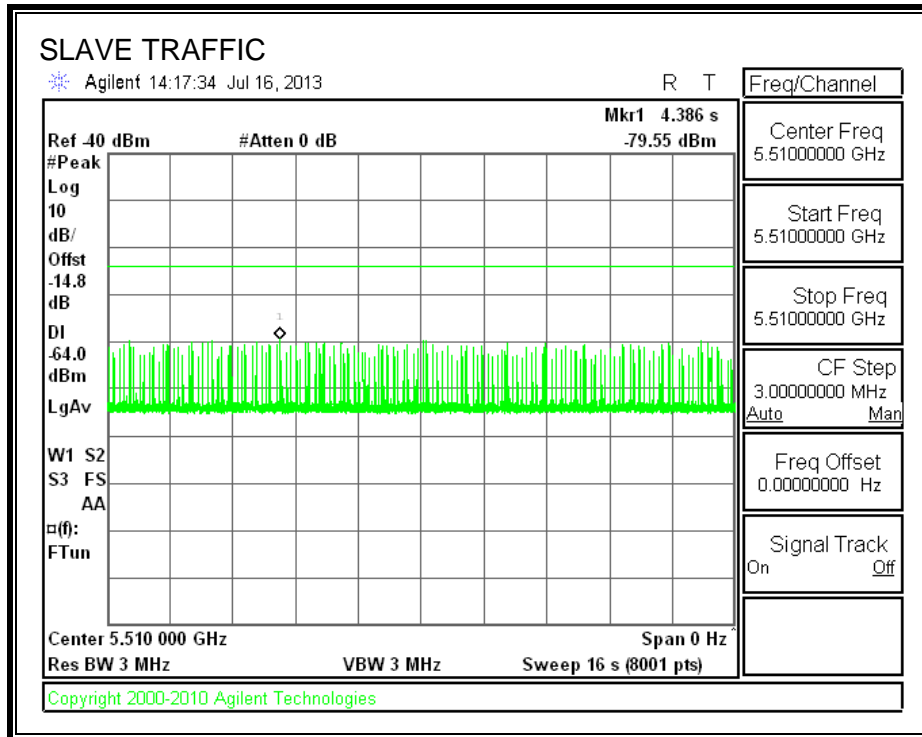

### 11.5.3. OVERLAPPING CHANNEL TESTS

#### RESULTS

These tests are not applicable.

### 11.5.4. MOVE AND CLOSING TIME

#### REPORTING NOTES

The reference marker is set at the end of last radar pulse.

The delta marker is set at the end of the last WLAN transmission following the radar pulse. This delta is the channel move time.

The aggregate channel closing transmission time is calculated as follows:

Aggregate Transmission Time =  
(Number of analyzer bins showing transmission) \* (dwell time per bin)

The observation period over which the FCC aggregate time is calculated begins at (Reference Marker + 200 msec) and ends no earlier than (Reference Marker + 10 sec).

The observation period over which the IC aggregate time is calculated begins at (Reference Marker) and ends no earlier than (Reference Marker + 10 sec).

#### RESULTS

Agency	Channel Move Time (sec)	Limit (sec)
FCC / IC	0.138	10

Agency	Aggregate Channel Closing Transmission Time (msec)	Limit (msec)
FCC	0.0	60
IC	4.0	260

**MOVE TIME**

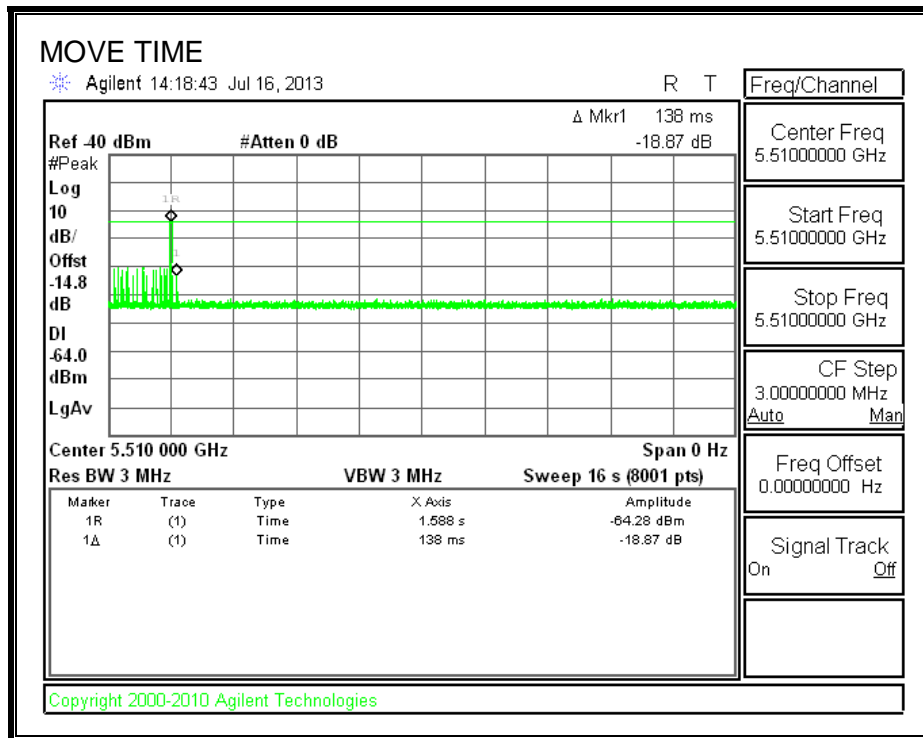

**CHANNEL CLOSING TIME**

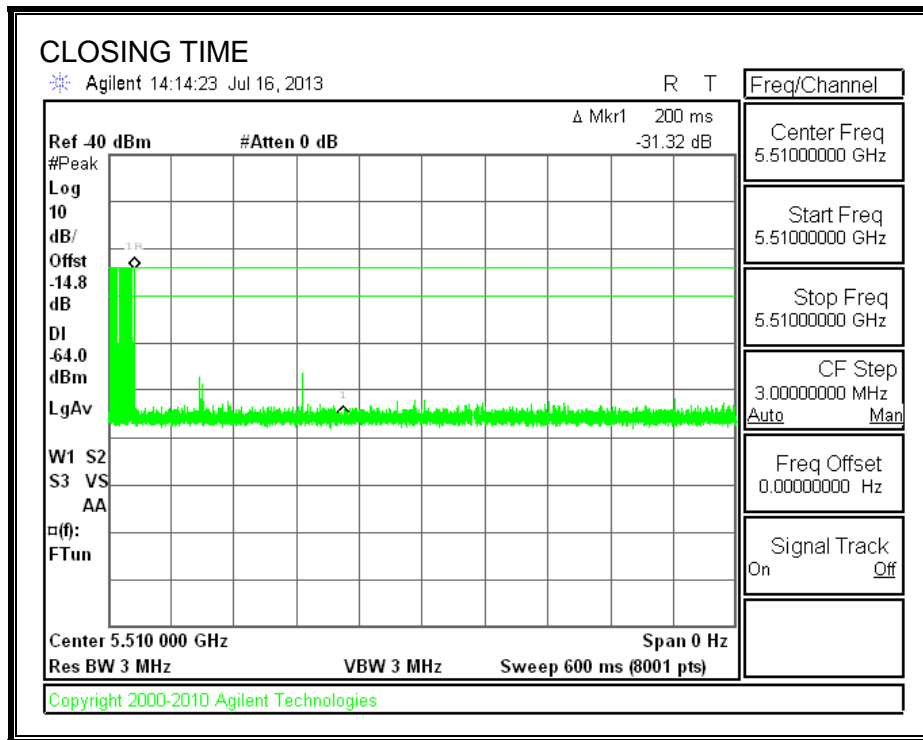



**AGGREGATE CHANNEL CLOSING TRANSMISSION TIME**

No transmissions are observed during the FCC aggregate monitoring period.

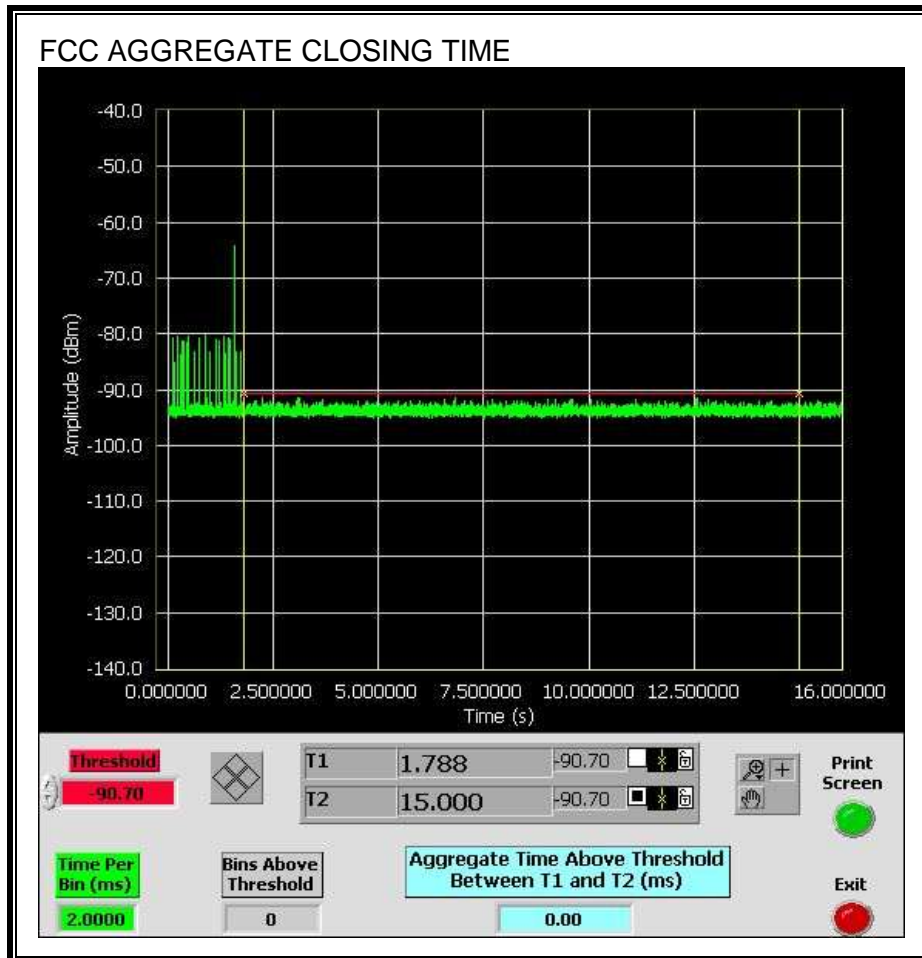

Only intermittent transmissions are observed during the IC aggregate monitoring period.

