



**FCC CFR47 PART 15 SUBPART C
INDUSTRY CANADA RSS-210 ISSUE 8**

CERTIFICATION TEST REPORT

FOR

QUAD-BAND RADIO WITH WLAN AND BT RADIO

MODEL NUMBER: A1530

**FCC ID: BCG-E2643A
IC: 579C-E2643A**

REPORT NUMBER: 13U15037-4

ISSUE DATE: JULY 22, 2013

Prepared for
**APPLE, INC.
1 INFINITE LOOP
CUPERTINO, CA 95014, U.S.A.**

Prepared by
**UL VERIFICATION SERVICES INC.
47173 BENICIA STREET
FREMONT, CA 94538, U.S.A.
TEL: (510) 771-1000
FAX: (510) 661-0888**



NVLAP LAB CODE 200065-0

Revision History

<u>Rev.</u>	<u>Issue Date</u>	<u>Revisions</u>	<u>Revised By</u>
---	07/22/13	Initial Issue	T. Chan

TABLE OF CONTENTS

1. ATTESTATION OF TEST RESULTS	5
2. TEST METHODOLOGY	6
3. FACILITIES AND ACCREDITATION	6
4. CALIBRATION AND UNCERTAINTY	6
4.1. <i>MEASURING INSTRUMENT CALIBRATION</i>	<i>6</i>
4.2. <i>SAMPLE CALCULATION</i>	<i>6</i>
4.3. <i>MEASUREMENT UNCERTAINTY.....</i>	<i>6</i>
5. EQUIPMENT UNDER TEST	7
5.1. <i>DESCRIPTION OF EUT</i>	<i>7</i>
5.2. <i>MAXIMUM OUTPUT POWER.....</i>	<i>7</i>
5.3. <i>DESCRIPTION OF AVAILABLE ANTENNAS</i>	<i>7</i>
5.4. <i>SOFTWARE AND FIRMWARE.....</i>	<i>7</i>
5.5. <i>WORST-CASE CONFIGURATION AND MODE.....</i>	<i>7</i>
5.6. <i>DESCRIPTION OF TEST SETUP.....</i>	<i>8</i>
6. TEST AND MEASUREMENT EQUIPMENT	10
7. ANTENNA PORT TEST RESULTS	11
7.1. <i>20 dB AND 99% BANDWIDTH</i>	<i>11</i>
7.1.1. <i>GFSK.....</i>	<i>11</i>
7.1.2. <i>8PSK</i>	<i>11</i>
7.2. <i>HOPPING FREQUENCY SEPARATION</i>	<i>20</i>
7.2.1. <i>GFSK.....</i>	<i>21</i>
7.2.2. <i>8PSK</i>	<i>21</i>
7.3. <i>NUMBER OF HOPPING CHANNELS.....</i>	<i>22</i>
7.3.1. <i>GFSK.....</i>	<i>23</i>
7.3.2. <i>8PSK</i>	<i>25</i>
7.4. <i>AVERAGE TIME OF OCCUPANCY.....</i>	<i>27</i>
7.4.1. <i>GFSK.....</i>	<i>28</i>
7.4.2. <i>8PSK</i>	<i>28</i>
7.5. <i>OUTPUT POWER.....</i>	<i>35</i>
7.5.1. <i>GFSK.....</i>	<i>35</i>
7.5.2. <i>8PSK</i>	<i>35</i>
7.6. <i>AVERAGE POWER.....</i>	<i>40</i>
7.6.1. <i>GFSK.....</i>	<i>40</i>
7.6.2. <i>8PSK</i>	<i>40</i>
7.7. <i>CONDUCTED SPURIOUS EMISSIONS.....</i>	<i>41</i>
7.7.1. <i>GFSK.....</i>	<i>42</i>

7.7.2. 8PSK	46
8. RADIATED TEST RESULTS.....	50
8.1. LIMITS AND PROCEDURE.....	50
8.2. TRANSMITTER ABOVE 1 GHz.....	51
8.2.1. BASIC DATA RATE GFSK MODULATION.....	51
8.2.2. ENHANCED DATA RATE 8PSK MODULATION	61
8.3. WORST-CASE BELOW 1 GHz.....	71
9. AC POWER LINE CONDUCTED EMISSIONS.....	74
10. SETUP PHOTOS	78

1. ATTESTATION OF TEST RESULTS

COMPANY NAME: APPLE, INC.
1 INFINITE LOOP
CUPERTINO, CA 95014, U.S.A.

EUT DESCRIPTION: QUAD-BAND RADIO WITH WLAN AND BT RADIO

MODEL: A1530

SERIAL NUMBER: C39KD00CFJ0Y

DATE TESTED: MAY 02-JUNE 28, 2013

APPLICABLE STANDARDS	
STANDARD	TEST RESULTS
CFR 47 Part 15 Subpart C	Pass
INDUSTRY CANADA RSS-210 Issue 8 Annex 8	Pass
INDUSTRY CANADA RSS-GEN Issue 3	Pass

UL Verification Services Inc. tested the above equipment in accordance with the requirements set forth in the above standards. All indications of Pass/Fail in this report are opinions expressed by UL Verification Services Inc. based on interpretations and/or observations of test results. Measurement Uncertainties were not taken into account and are published for informational purposes only. The test results show that the equipment tested is capable of demonstrating compliance with the requirements as documented in this report.

Note: The results documented in this report apply only to the tested sample, under the conditions and modes of operation as described herein. This document may not be altered or revised in any way unless done so by UL Verification Services Inc. and all revisions are duly noted in the revisions section. Any alteration of this document not carried out by UL Verification Services Inc. will constitute fraud and shall nullify the document. This report must not be used by the client to claim product certification, approval, or endorsement by NVLAP, NIST, any agency of the Federal Government, or any agency of any government.

Approved & Released For
UL Verification Services Inc. By:

Tested By:

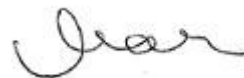

Thu Chan
WiSE Operations Manager
UL Verification Services Inc.

Mona Hua
WiSE Lab Technician
UL Verification Services Inc.

2. TEST METHODOLOGY

The tests documented in this report were performed in accordance with ANSI C63.10-2009, FCC CFR 47 Part 2, and FCC CFR 47 Part 15, RSS-GEN Issue 3, and RSS-210 Issue 8.

3. FACILITIES AND ACCREDITATION

The test sites and measurement facilities used to collect data are located at 47173 Benicia Street, Fremont, California, USA.

UL Verification Services Inc. is accredited by NVLAP, Laboratory Code 200065-0. The full scope of accreditation can be viewed at <http://www.ccsemc.com>.

4. CALIBRATION AND UNCERTAINTY

4.1. MEASURING INSTRUMENT CALIBRATION

The measuring equipment utilized to perform the tests documented in this report has been calibrated in accordance with the manufacturer's recommendations, and is traceable to recognized national standards.

4.2. SAMPLE CALCULATION

Where relevant, the following sample calculation is provided:

$$\begin{aligned} \text{Field Strength (dBuV/m)} &= \text{Measured Voltage (dBuV)} + \text{Antenna Factor (dB/m)} + \\ &\text{Cable Loss (dB)} - \text{Preamp Gain (dB)} \\ 36.5 \text{ dBuV} + 18.7 \text{ dB/m} + 0.6 \text{ dB} - 26.9 \text{ dB} &= 28.9 \text{ dBuV/m} \end{aligned}$$

4.3. MEASUREMENT UNCERTAINTY

Where relevant, the following measurement uncertainty levels have been estimated for tests performed on the apparatus:

PARAMETER	UNCERTAINTY
Conducted Disturbance, 0.15 to 30 MHz	3.52 dB
Radiated Disturbance, 30 to 1000 MHz	4.94 dB

Uncertainty figures are valid to a confidence level of 95%.

5. EQUIPMENT UNDER TEST

5.1. DESCRIPTION OF EUT

Model A1530 is a mobile phone with multimedia functions (music, application support, and video), cellular GSM/GPRS/EGPRS/WCDMA/HSPA+/DC-HSDPA/LTE radio, IEEE 802.11a/b/g/n, Bluetooth and GPS radio. The rechargeable battery is not user accessible.

5.2. MAXIMUM OUTPUT POWER

The transmitter has a maximum peak conducted output power as follows:

Frequency Range (MHz)	Mode	Output Power (dBm)	Output Power (mW)
2402 - 2480	Basic GFSK	13.81	24.04
2402 - 2480	Enhanced 8PSK	13.53	22.54

5.3. DESCRIPTION OF AVAILABLE ANTENNAS

The radio utilizes a PiFA antenna, with a maximum gain of 1.09dBi.

5.4. SOFTWARE AND FIRMWARE

The firmware installed in the EUT during testing was Broadcom Bluetooth Version 1.4.8.7.

5.5. WORST-CASE CONFIGURATION AND MODE

For Radiated Emissions below 1 GHz and Power line Conducted Emissions, the channel with the highest conducted output power was selected as worst-case scenario.

The worst-position was the EUT with highest emissions. To determine the worst-case, the EUT is a portable device that has three orientations; therefore X, Y and Z orientations have been investigated with and without AC adapter, and the worst case was found to be at Z position without AC Adapter.

5.6. DESCRIPTION OF TEST SETUP

SUPPORT EQUIPMENT

Support Equipment List			
Description	Manufacturer	Model	Serial Number
AC adapter	Apple	A1385	NA

I/O CABLES (Conducted Setup)

I/O Cable List						
Cable No	Port	# of identical ports	Connector Type	Cable Type	Cable Length (m)	Remarks
1	Antenna	1	SMA	Shielded	0.1m	To Spectrum Analyzer

I/O CABLES (Radiated Setup)

I/O Cable List						
Cable No	Port	# of identical ports	Connector Type	Cable Type	Cable Length (m)	Remarks
1	Jack	1	Earphone	Unshielded	0.5m	N/A

TEST SETUP

The EUT is a stand-alone device.

SETUP DIAGRAM FOR TESTS (CONDUCTED)

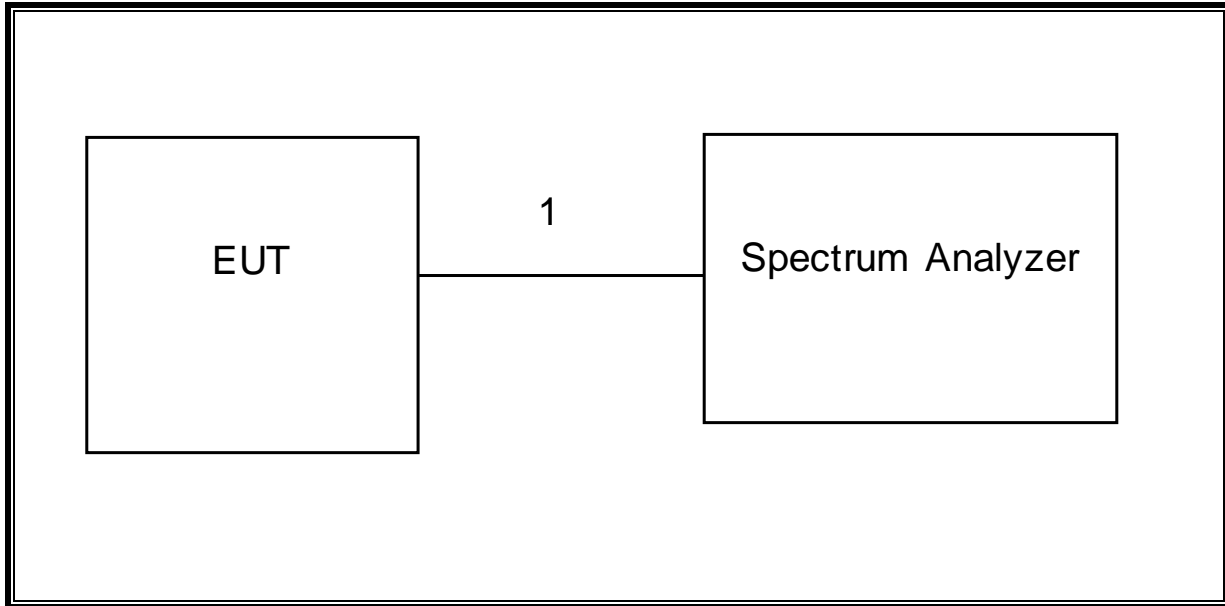

SETUP DIAGRAM FOR TESTS (RADIATED)

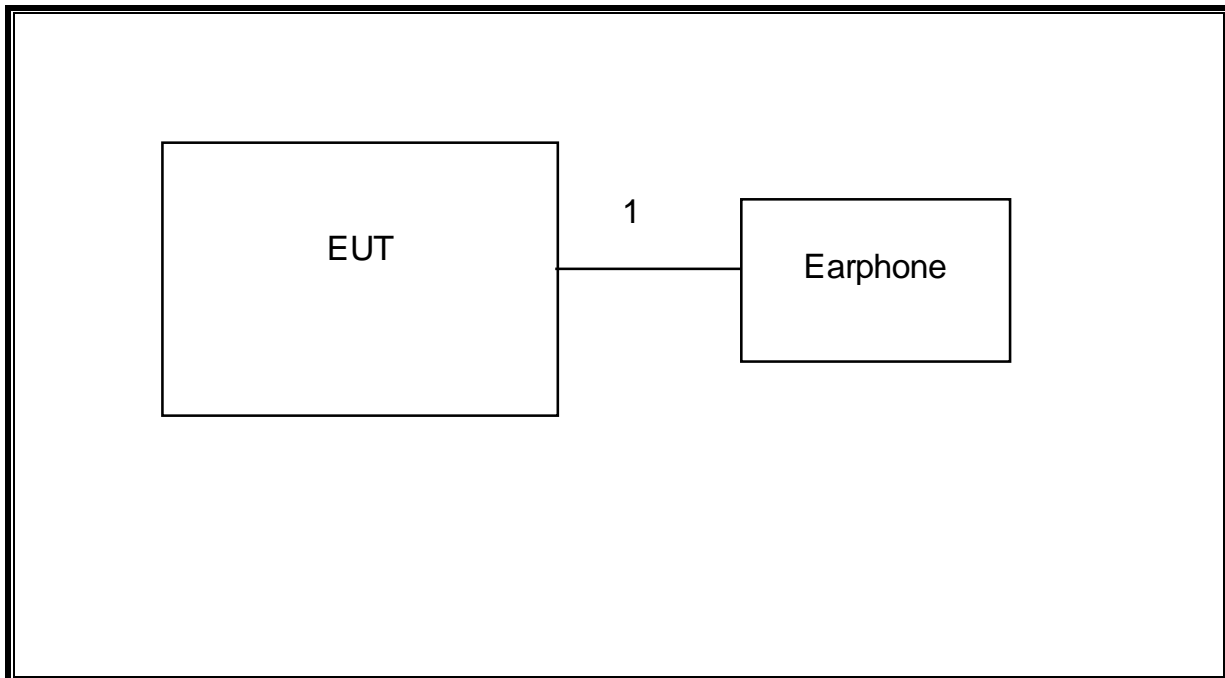

6. TEST AND MEASUREMENT EQUIPMENT

The following test and measurement equipment was utilized for the tests documented in this report:

TEST EQUIPMENT LIST				
Description	Manufacturer	Model	Asset	Cal Due
Spectrum Analyzer, 44 GHz	Agilent / HP	N9030A	F00126	02/22/14
Antenna, Horn, 18 GHz	ETS Lindgren	3117	F00131	02/19/14
Antenna, Horn, 26.5 GHz	ARA	MWH-1826/B	C00589	04/28/14
Antenna, Bilog, 2 GHz	Sunol Sciences	JB1	F00168	03/07/14
Preamplifier, 1300 MHz	Sonoma	310	F00008	11/06/13
Preamplifier, 26.5 GHz	Agilent / HP	8449B	F00165	03/18/14
EMI Test Receiver, 9 kHz-7 GHz	R & S	ESCI 7	1000741	07/06/14
LISN, 30 MHz	FCC	LISN-50/250-25-2	N02625	04/17/14
Peak / Average Power Sensor	Agilent / HP	N1911A	F00153	04/05/14
Peak Power Meter	Agilent / HP	E9323A	F00025	04/03/14

7. ANTENNA PORT TEST RESULTS

7.1. 20 dB AND 99% BANDWIDTH

LIMIT

None; for reporting purposes only.

TEST PROCEDURE

The transmitter output is connected to a spectrum analyzer. The RBW is set to $\geq 1\%$ of the 20 dB bandwidth. The VBW is set to \geq RBW. The sweep time is coupled.

RESULTS

7.1.1. GFSK

Channel	Frequency (MHz)	20 dB Bandwidth (MHz)	99% Bandwidth (MHz)
Low	2402	0.962519	0.9092326
Middle	2441	0.967180	0.9334830
High	2480	0.962283	0.8923548

7.1.2. 8PSK

Channel	Frequency (MHz)	20 dB Bandwidth (MHz)	99% Bandwidth (MHz)
Low	2402	1.347	1.5805
Middle	2441	1.344	1.3744
High	2480	1.332	1.2913

GFSK

20 dB BANDWIDTH

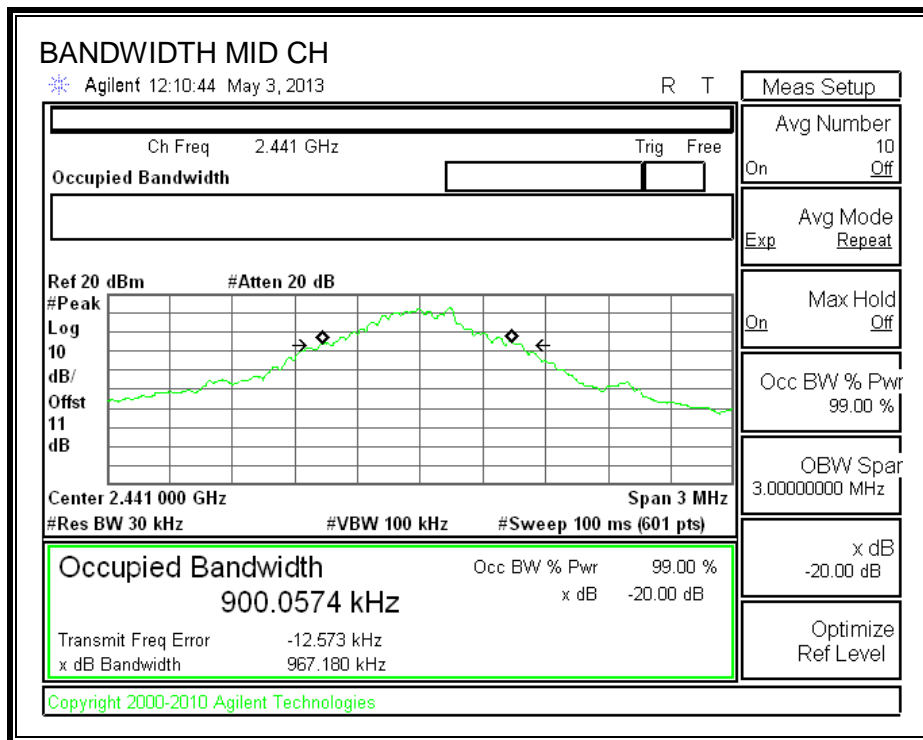
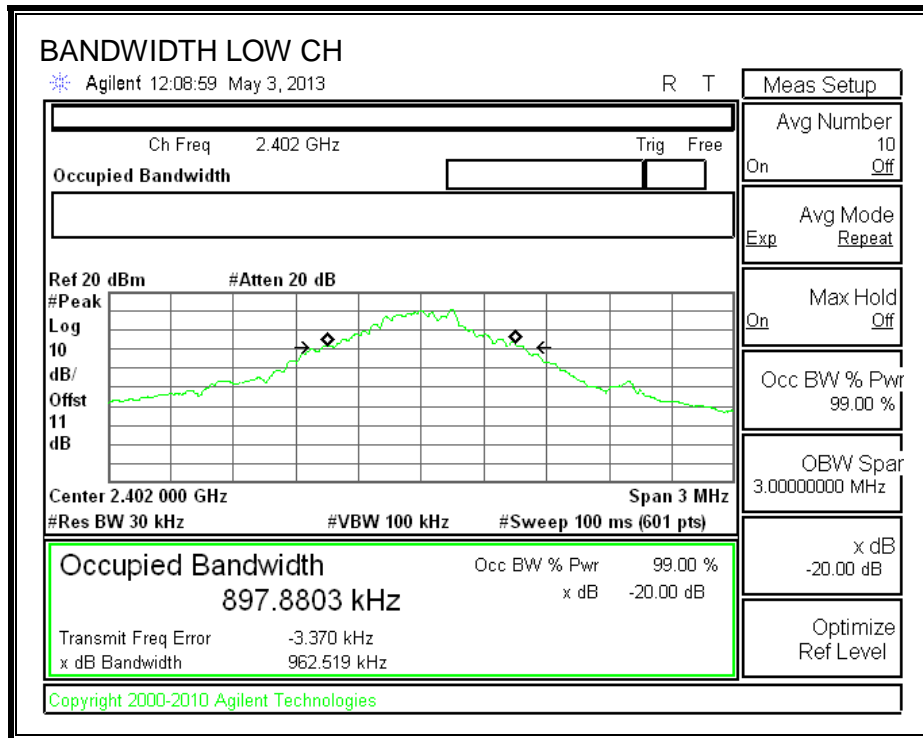

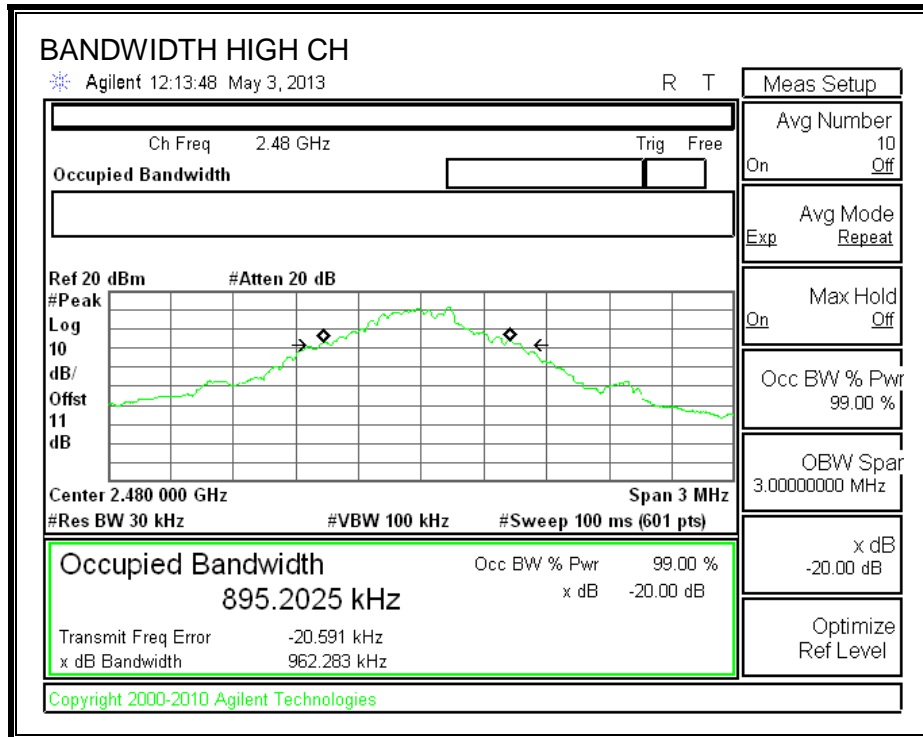

GFSK

99% BANDWIDTH

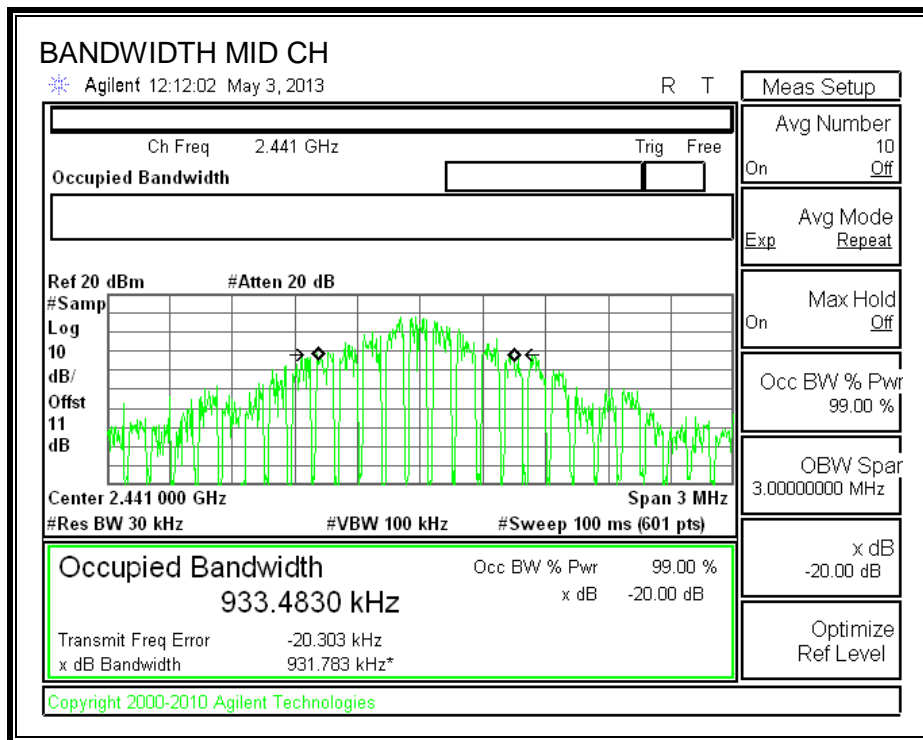
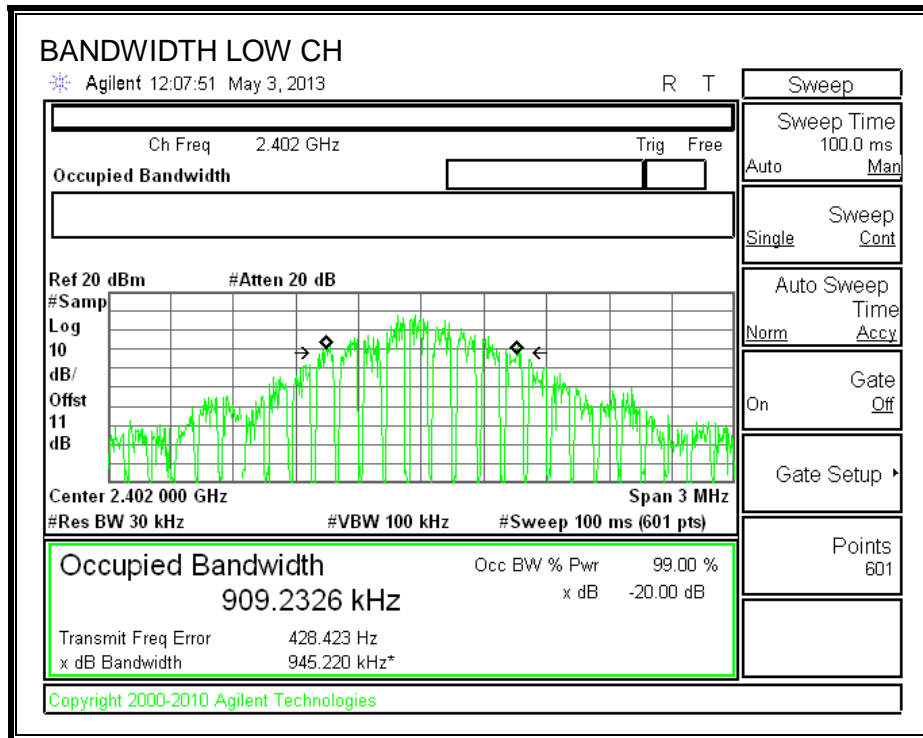

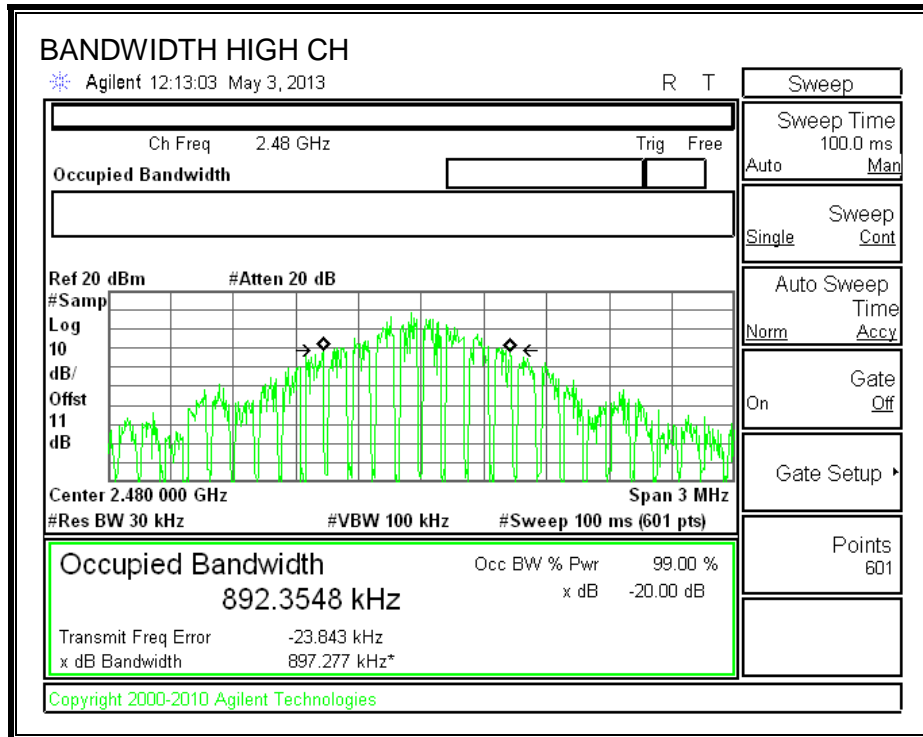

8PSK

20 dB BANDWIDTH

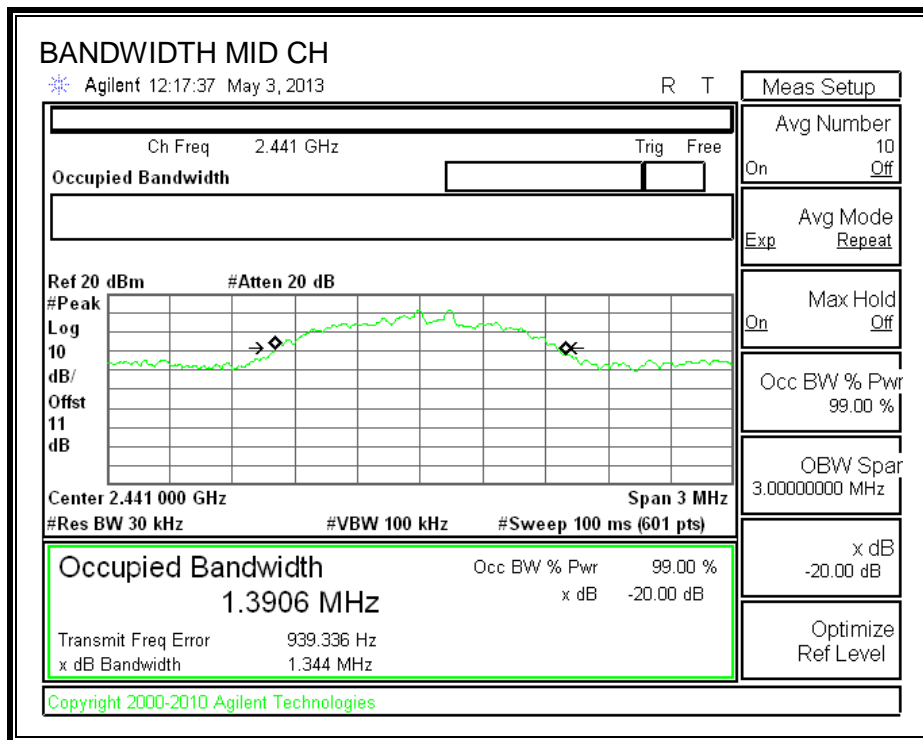
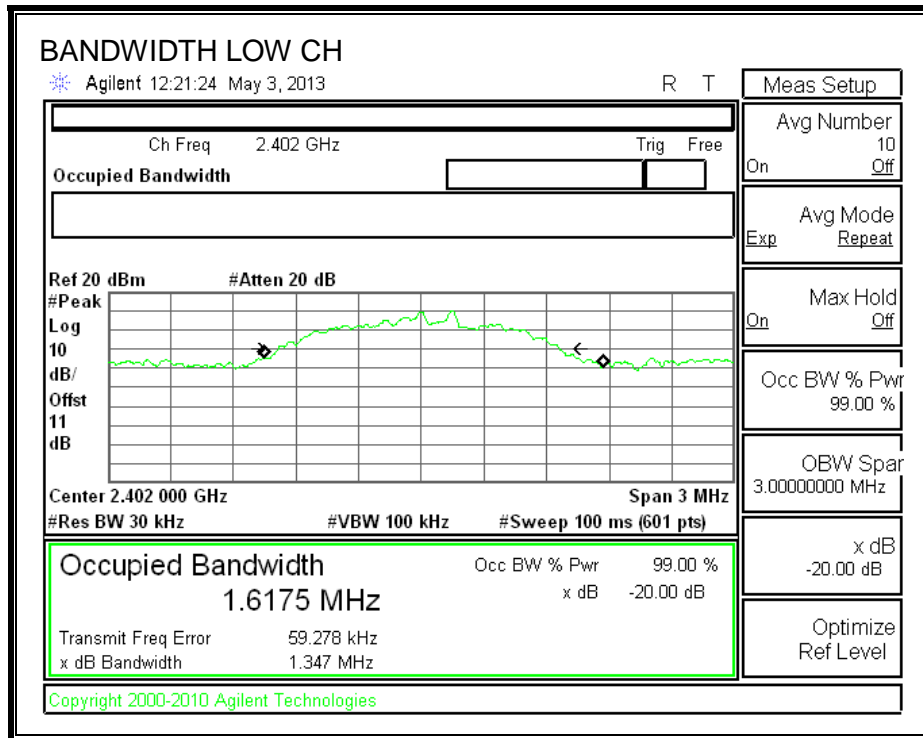

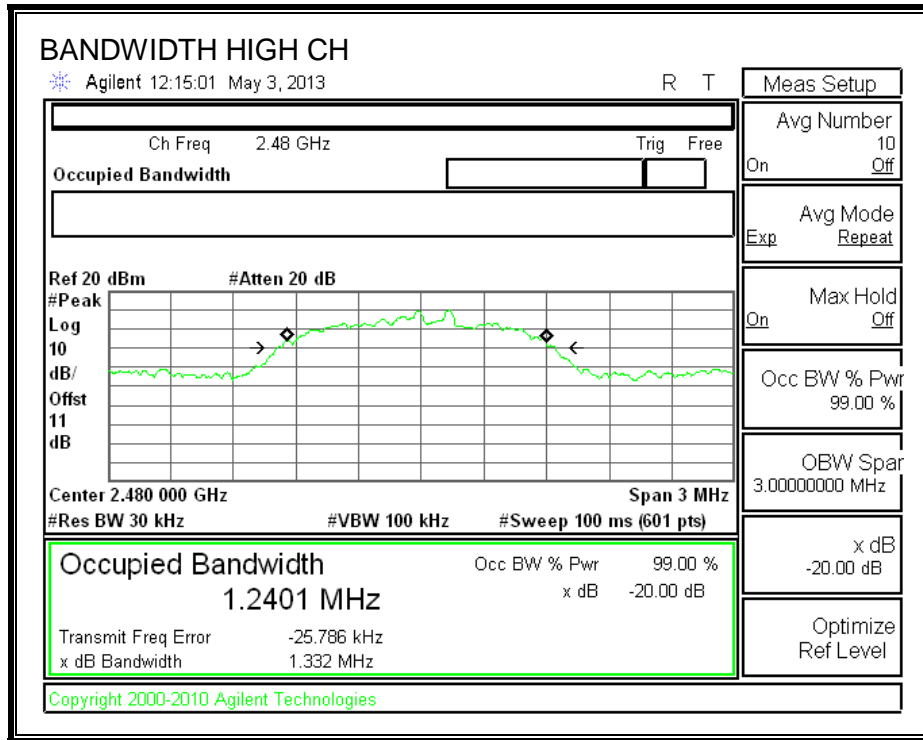

99% BANDWIDTH

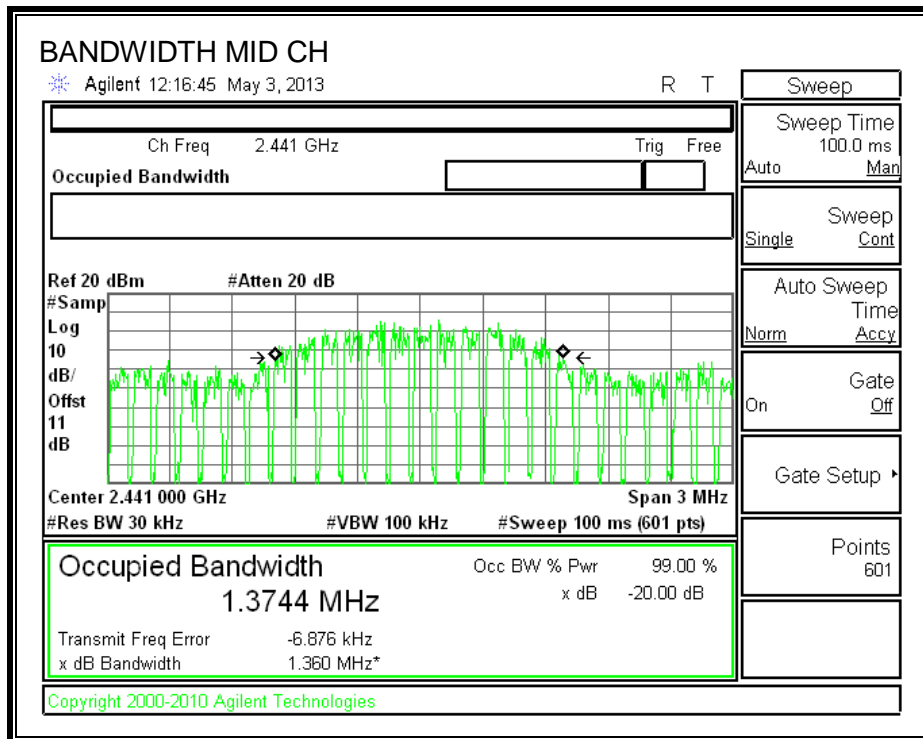
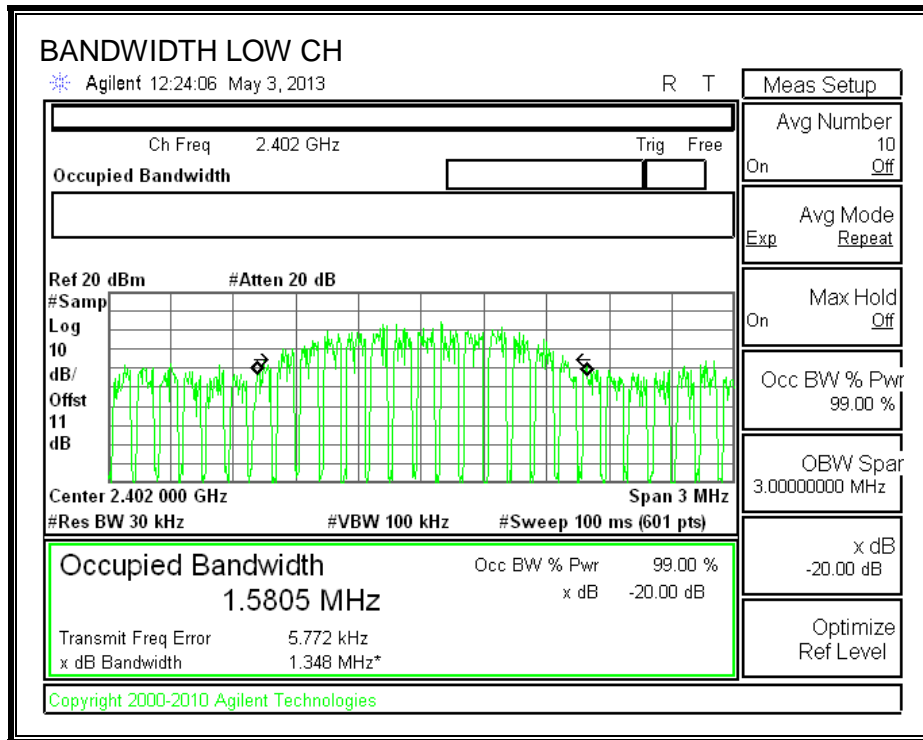

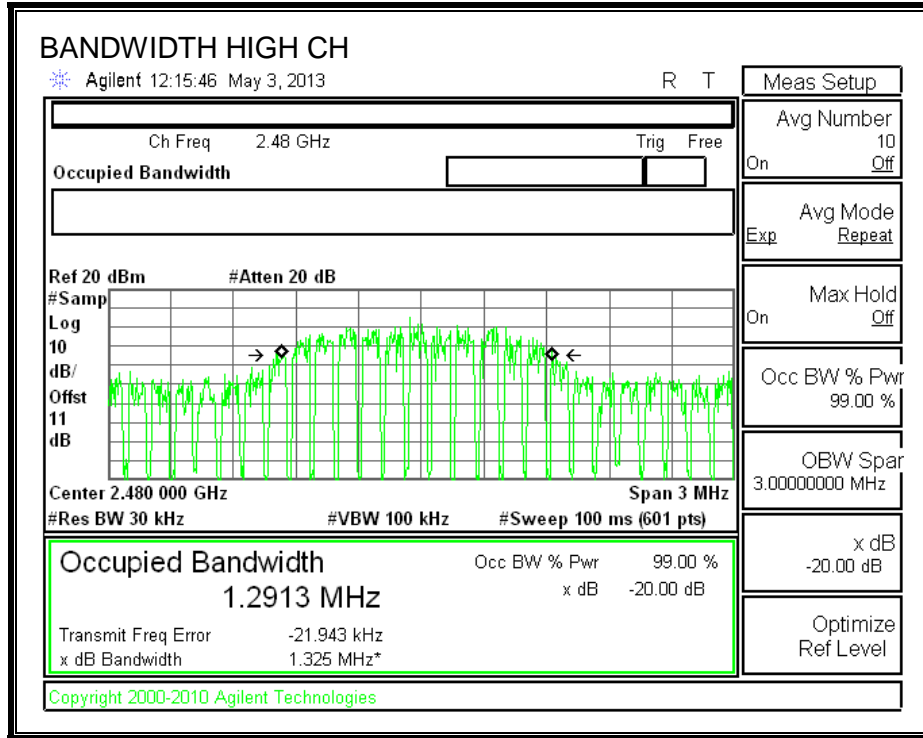

7.2. HOPPING FREQUENCY SEPARATION

LIMIT

FCC §15.247 (a) (1)

IC RSS-210 A8.1 (b)

Frequency hopping systems shall have hopping channel carrier frequencies separated by a minimum of 25 kHz or the 20 dB bandwidth of the hopping channel, whichever is greater.

Alternatively, frequency hopping systems operating in the 2400-2483.5 MHz band may have hopping channel carrier frequencies that are separated by 25 kHz or two-thirds of the 20 dB bandwidth of the hopping channel, whichever is greater, provided the systems operate with an output power no greater than 125 mW.

TEST PROCEDURE

The transmitter output is connected to a spectrum analyzer. The RBW is set to 100 kHz and the VBW is set to 100 kHz. The sweep time is coupled.

7.2.1. GFSK

HOPPING FREQUENCY SEPARATION

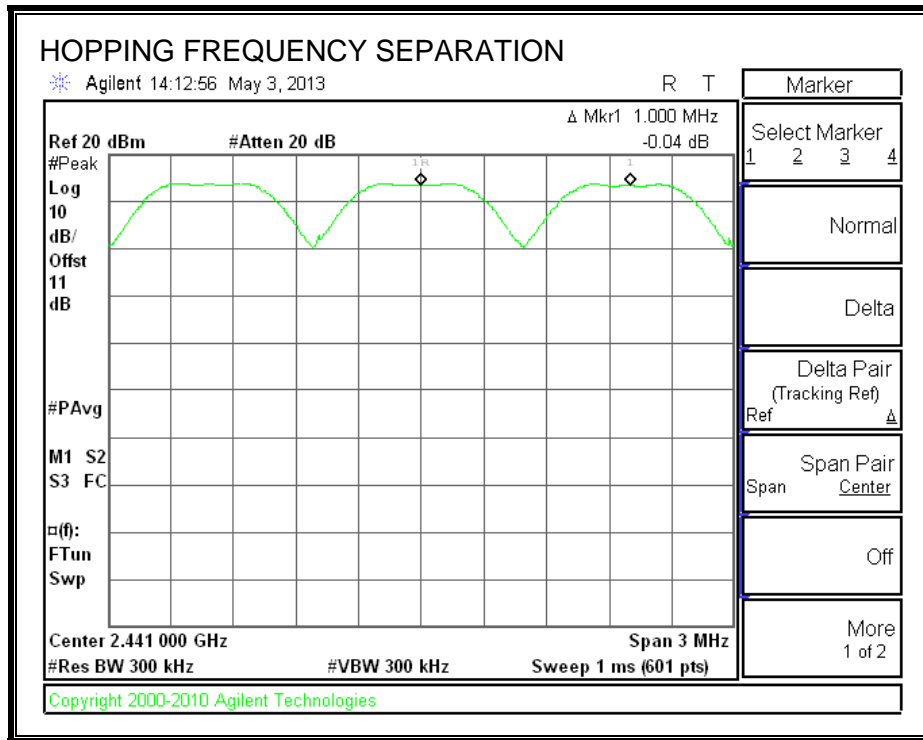

7.2.2. 8PSK

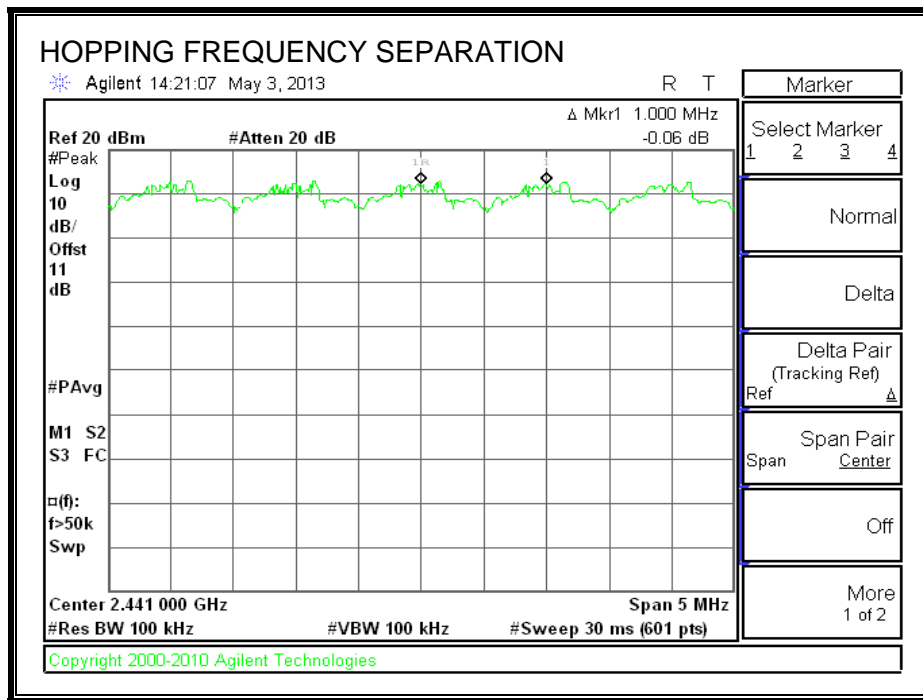

7.3. NUMBER OF HOPPING CHANNELS

LIMIT

FCC §15.247 (a) (1) (iii)

IC RSS-210 A8.1 (d)

Frequency hopping systems in the 2400 – 2483.5 MHz band shall use at least 15 non-overlapping channels.

TEST PROCEDURE

The transmitter output is connected to a spectrum analyzer. The span is set to cover the entire authorized band, in either a single sweep or in multiple contiguous sweeps. The RBW is set to a maximum of 1 % of the span. The analyzer is set to Max Hold.

RESULTS

79 Channels observed.

7.3.1. GFSK

NUMBER OF HOPPING CHANNELS

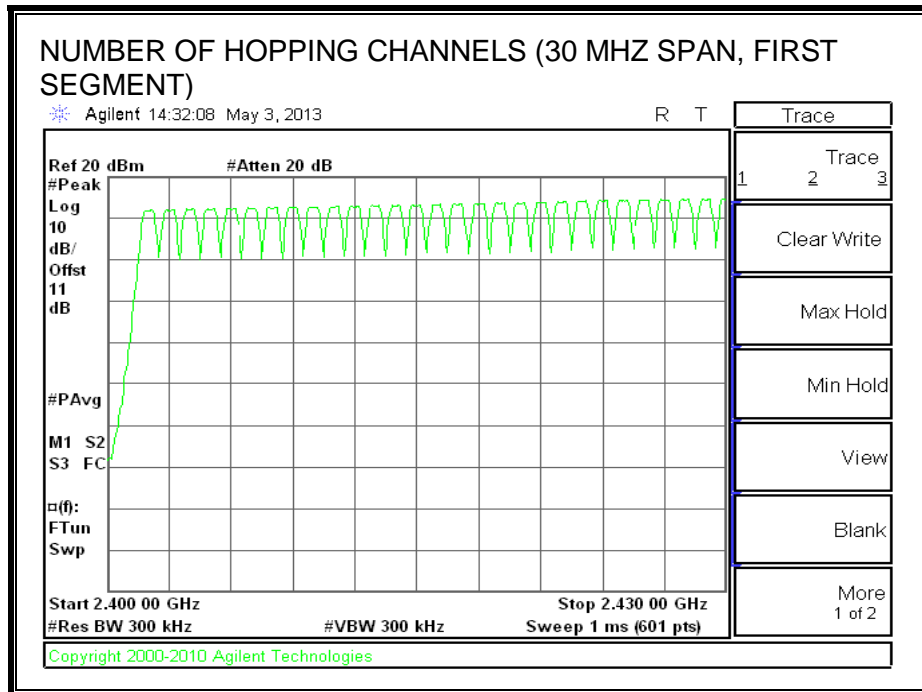
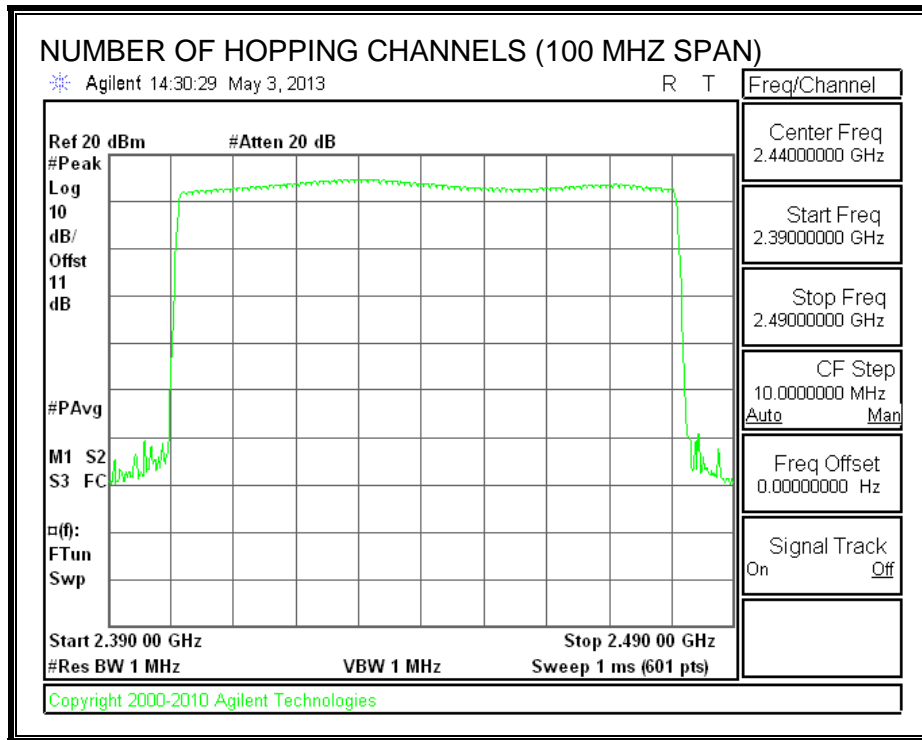

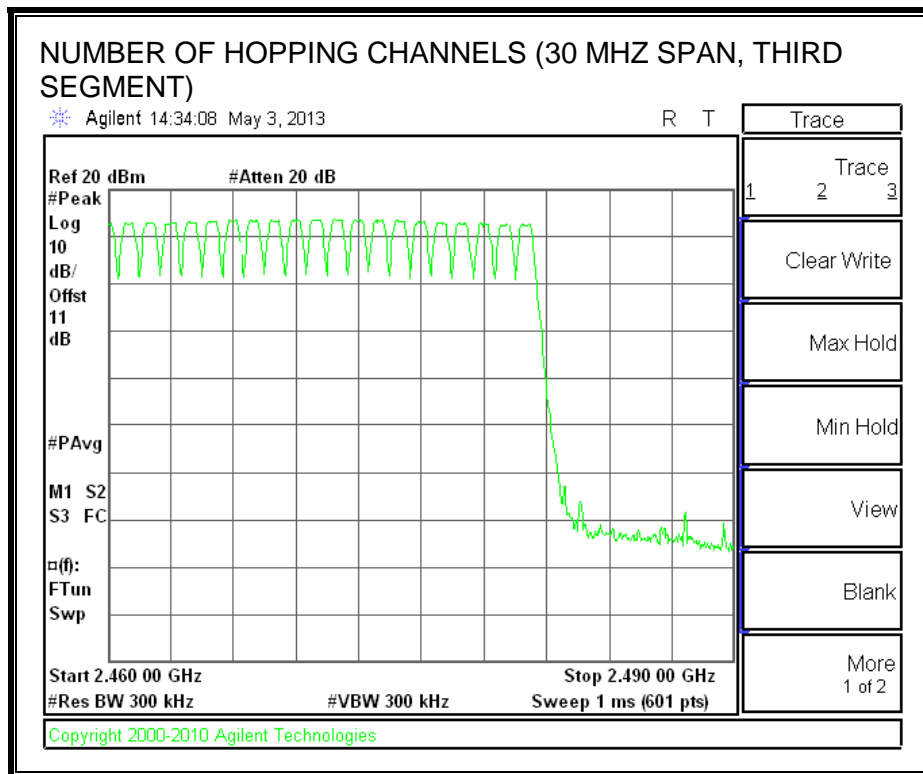
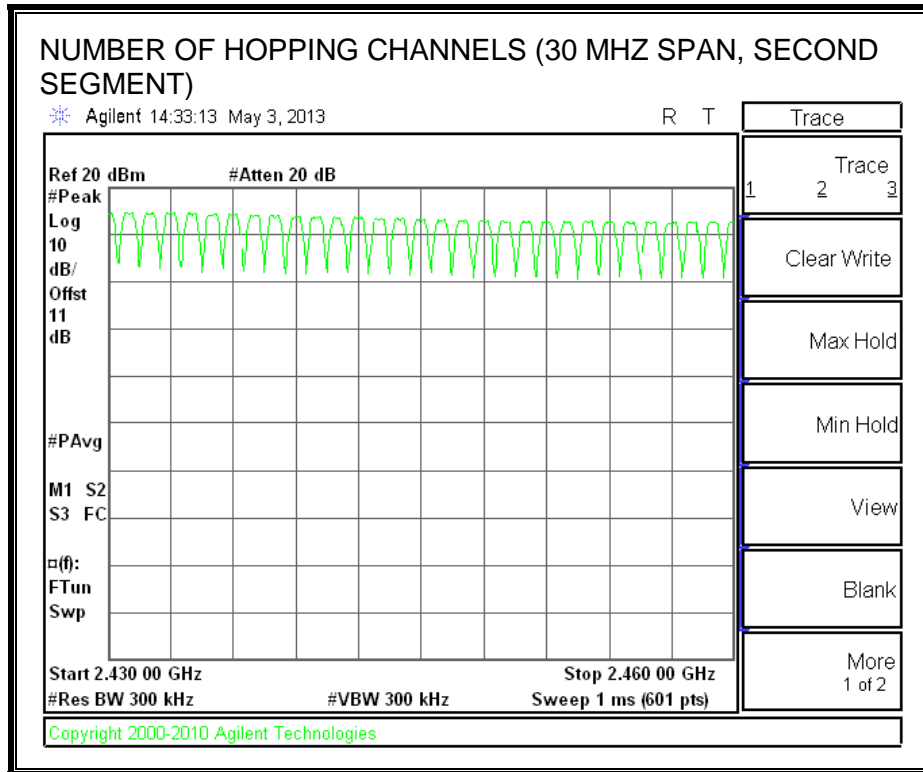

7.3.2. 8PSK

NUMBER OF HOPPING CHANNELS

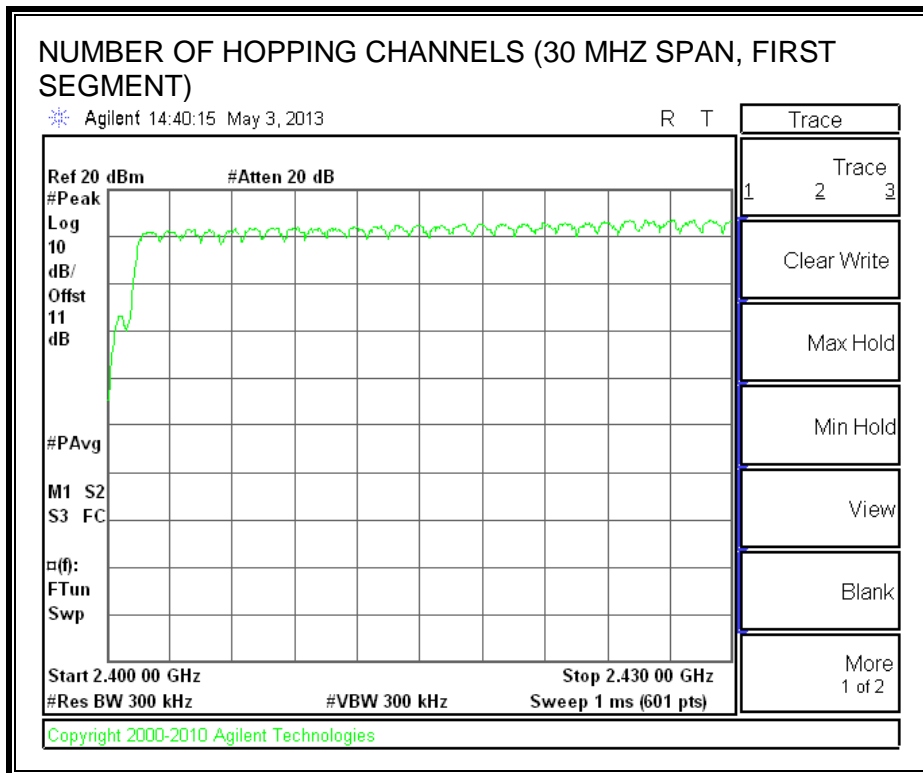
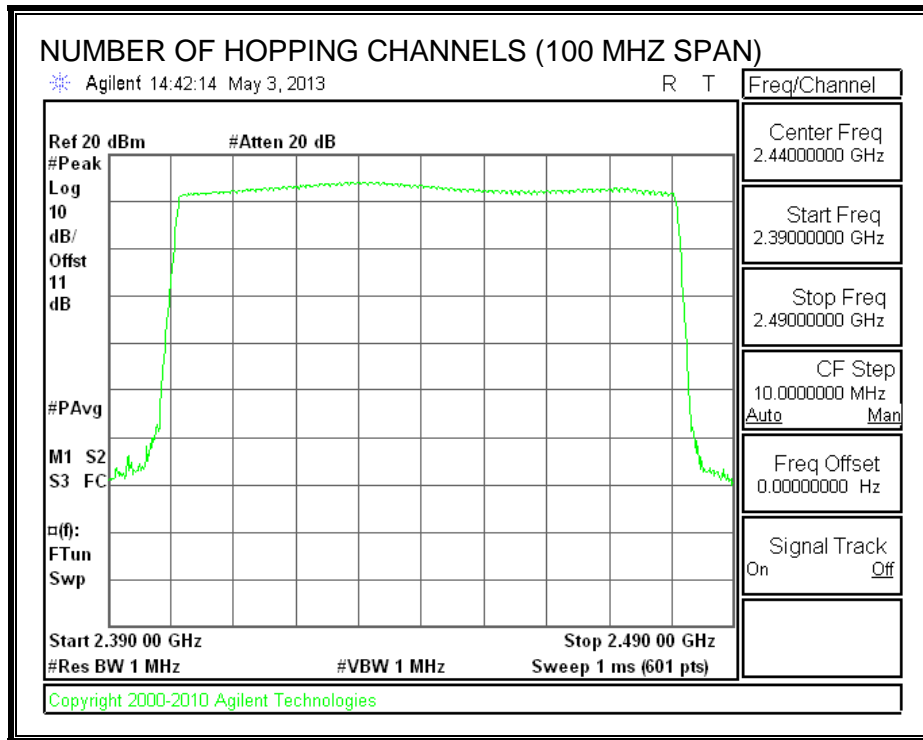

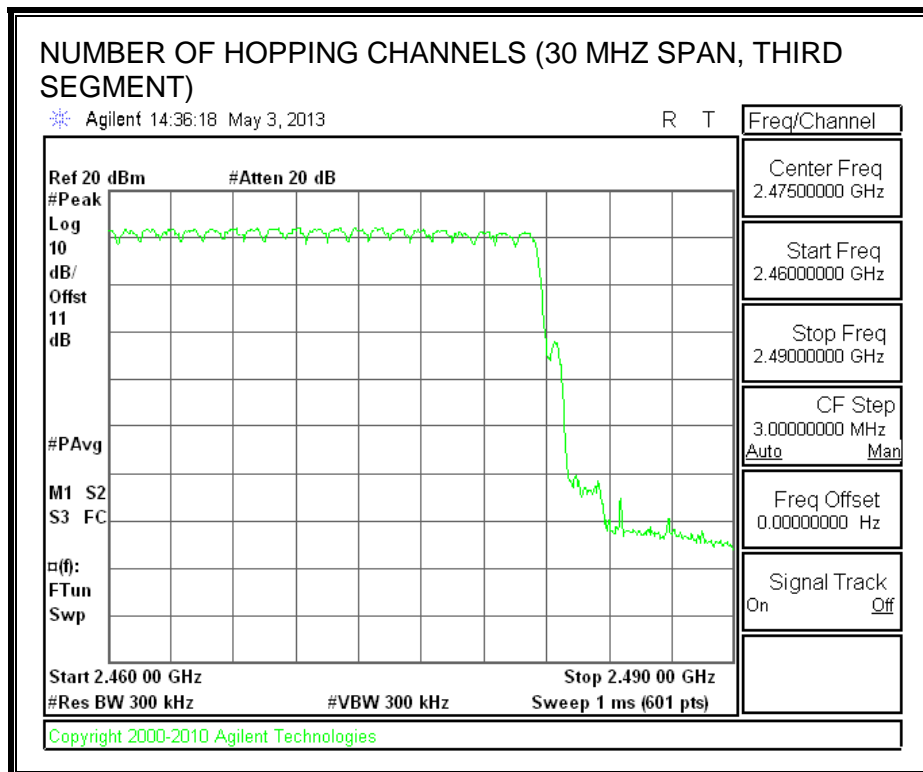
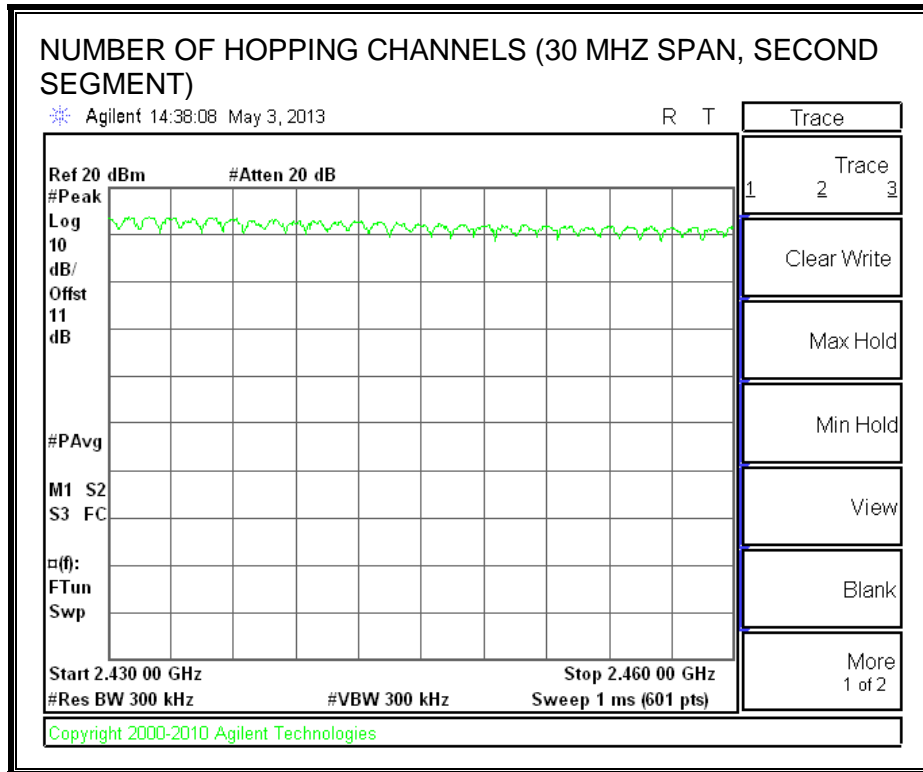

7.4. AVERAGE TIME OF OCCUPANCY

LIMIT

FCC §15.247 (a) (1) (iii)

IC RSS-210 A8.1 (d)

The average time of occupancy on any channel shall not be greater than 0.4 seconds within a period of 0.4 seconds multiplied by the number of hopping channels employed.

TEST PROCEDURE

The transmitter output is connected to a spectrum analyzer. The span is set to 0 Hz, centered on a single, selected hopping channel. The width of a single pulse is measured in a fast scan. The number of pulses is measured in a 3.16 second scan, to enable resolution of each occurrence.

The average time of occupancy in the specified 31.6 second period (79 channels * 0.4 s) is equal to $10 * (\# \text{ of pulses in } 3.16 \text{ s}) * \text{ pulse width}$.

RESULT

7.4.1. GFSK

GFSK Mode

DH Packet	Pulse Width (msec)	Number of Pulses in 3.16 seconds	Average Time of (sec)	Limit (sec)	Margin (sec)
DH1	0.4139	30	0.124	0.4	-0.276
DH3	1.673	17	0.284	0.4	-0.116
DH5	2.899	12	0.348	0.4	-0.052

7.4.2. 8PSK

8PSK Mode

DH Packet	Pulse Width (msec)	Number of Pulses in 3.16 seconds	Average Time of Occupancy (sec)	Limit (sec)	Margin (sec)
DH1	0.4100	31	0.127	0.4	-0.273
DH3	1.6670	16	0.267	0.4	-0.133
DH5	2.9080	13	0.378	0.4	-0.022

GFSK, PULSE WIDTH, DH1

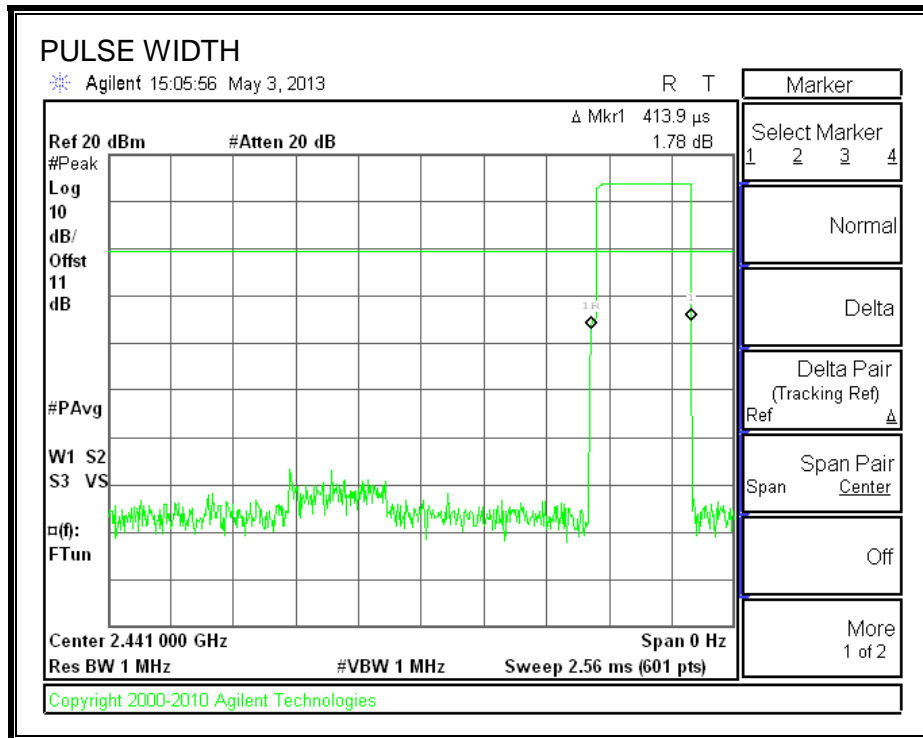

NUMBER OF PULSES IN 3.16 SECOND OBSERVATION PERIOD

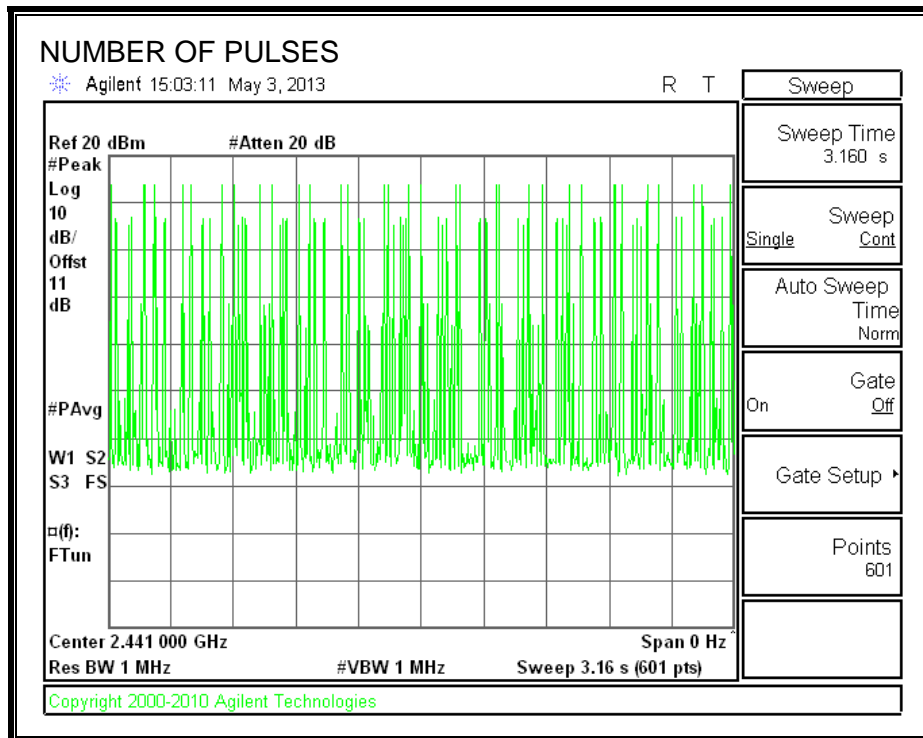

PULSE WIDTH GFSK DH3

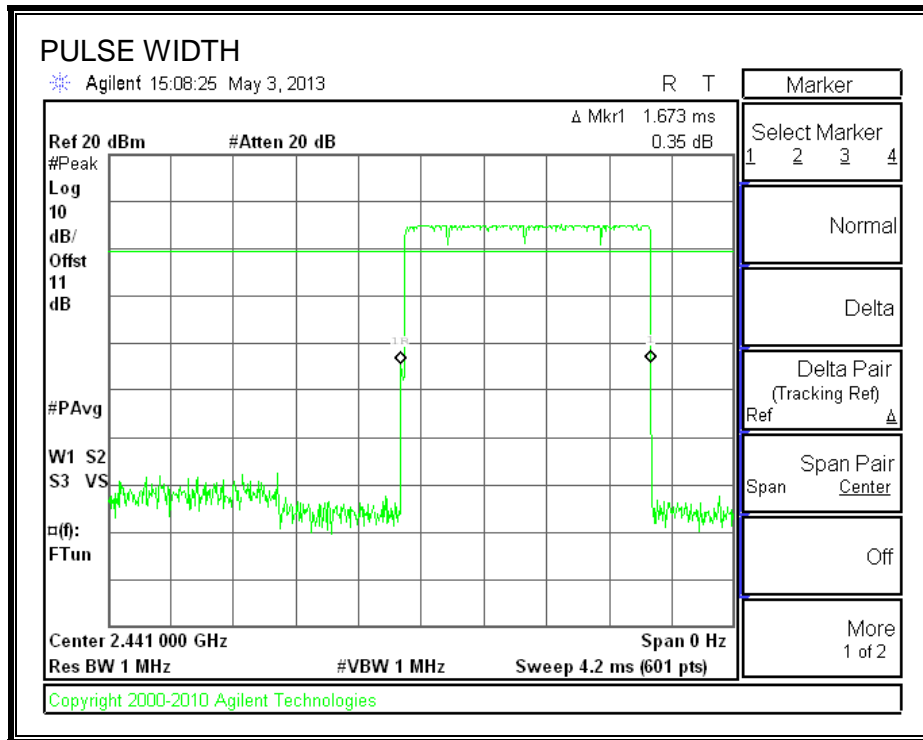

NUMBER OF PULSES IN 3.16 SECOND OBSERVATION PERIOD

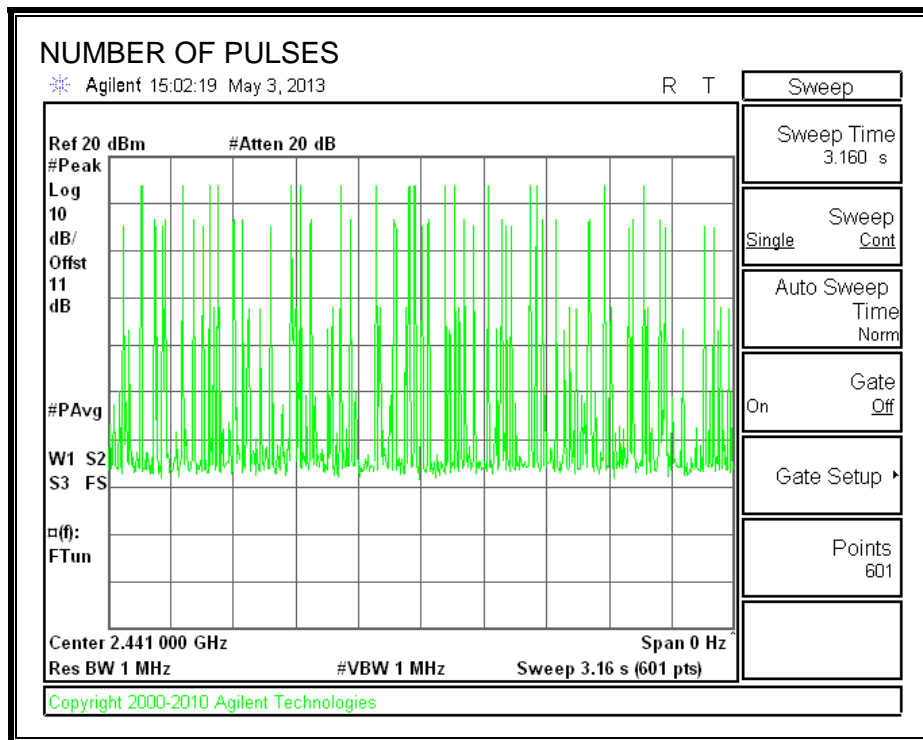

PULSE WIDTH GFSK DH5

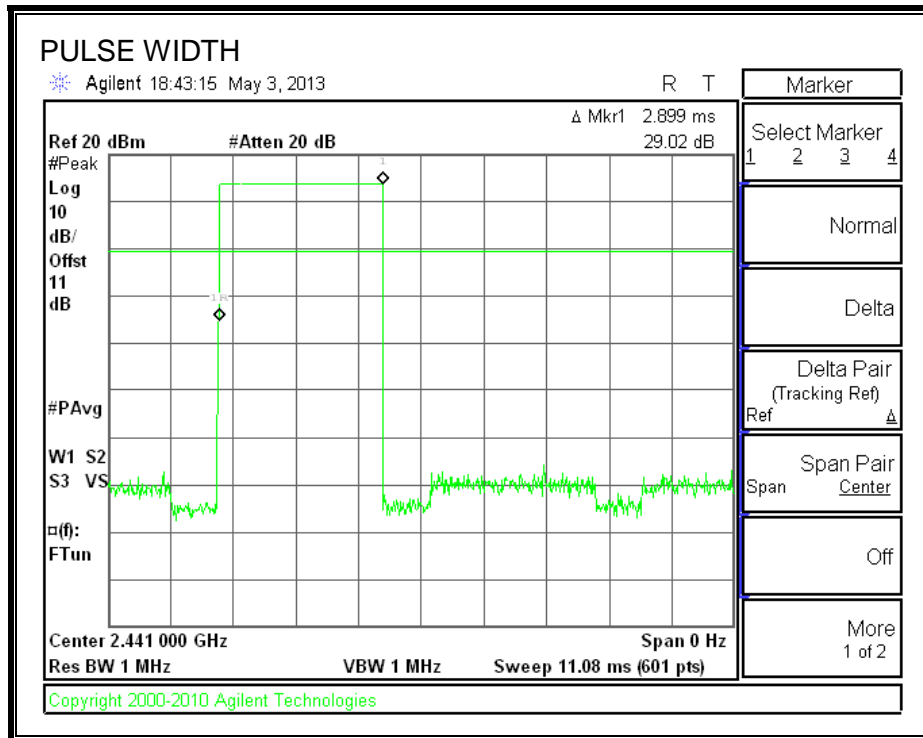

NUMBER OF PULSES IN 3.16 SECOND OBSERVATION PERIOD

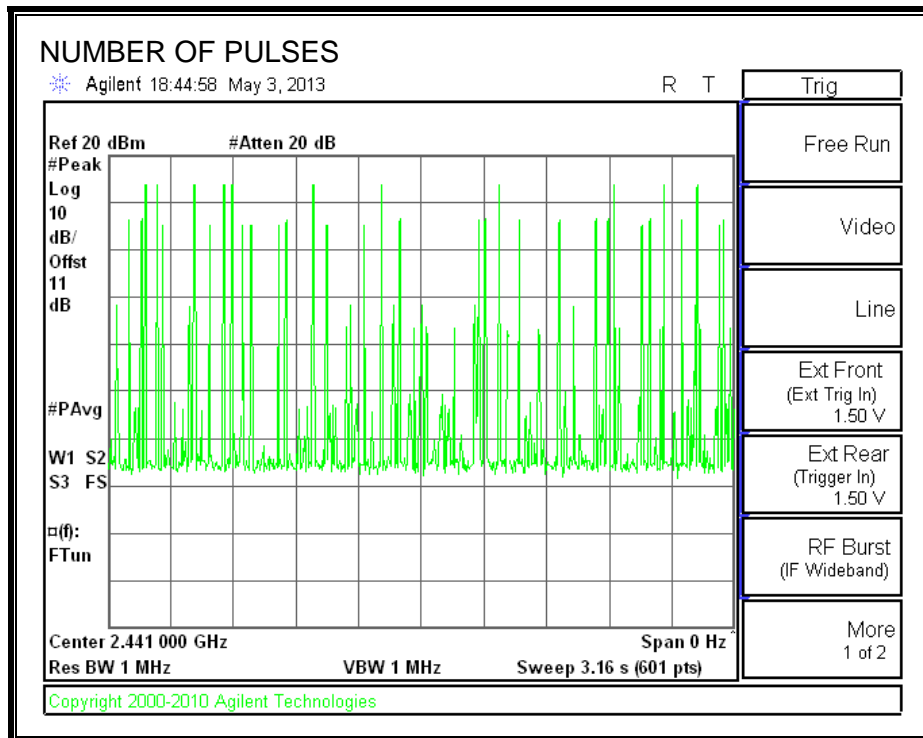

8PSK, PULSE WIDTH DH1

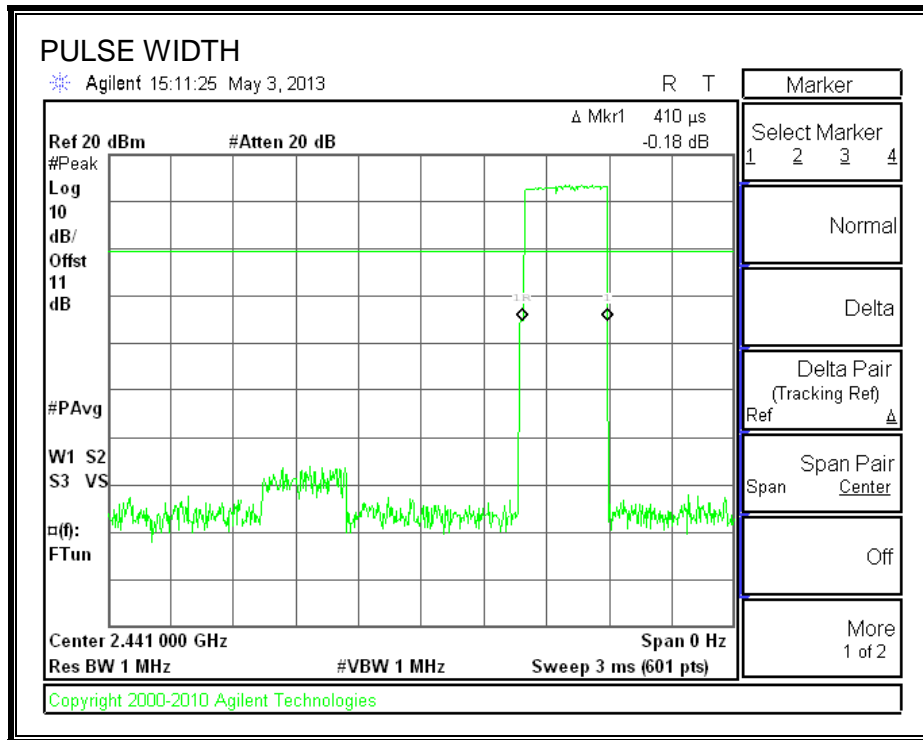

NUMBER OF PULSES IN 3.16 SECOND OBSERVATION PERIOD

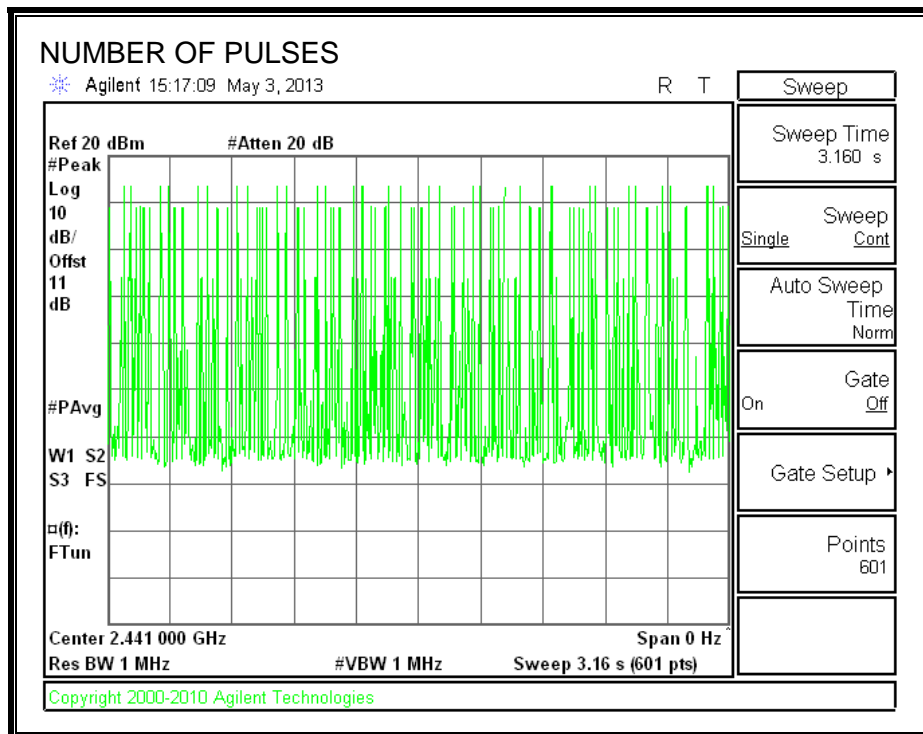

PULSE WIDTH 8PSK DH3

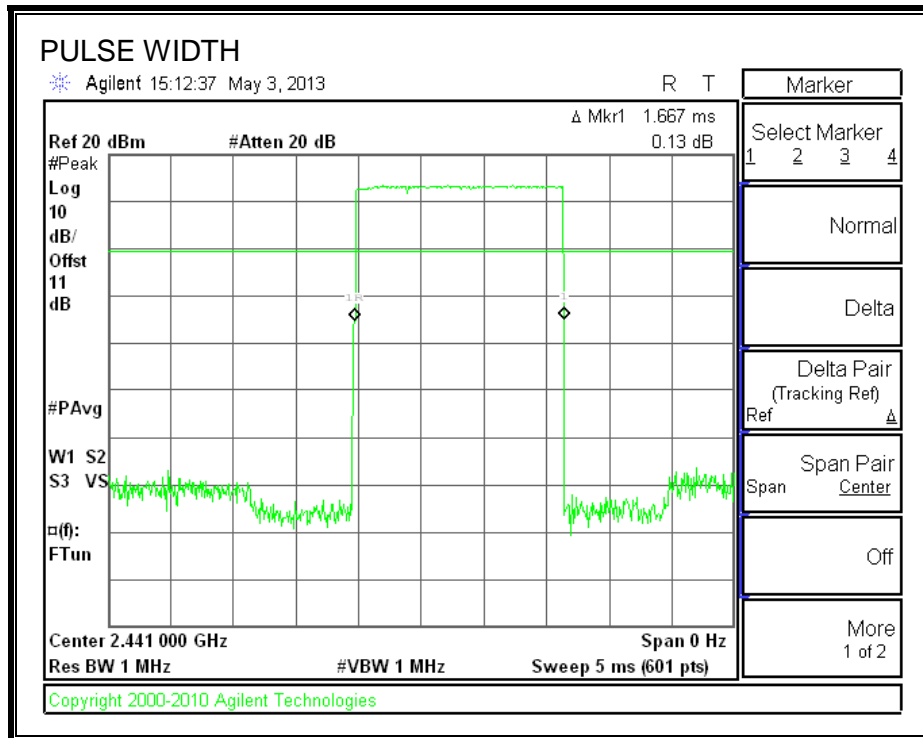

NUMBER OF PULSES IN 3.16 SECOND OBSERVATION PERIOD

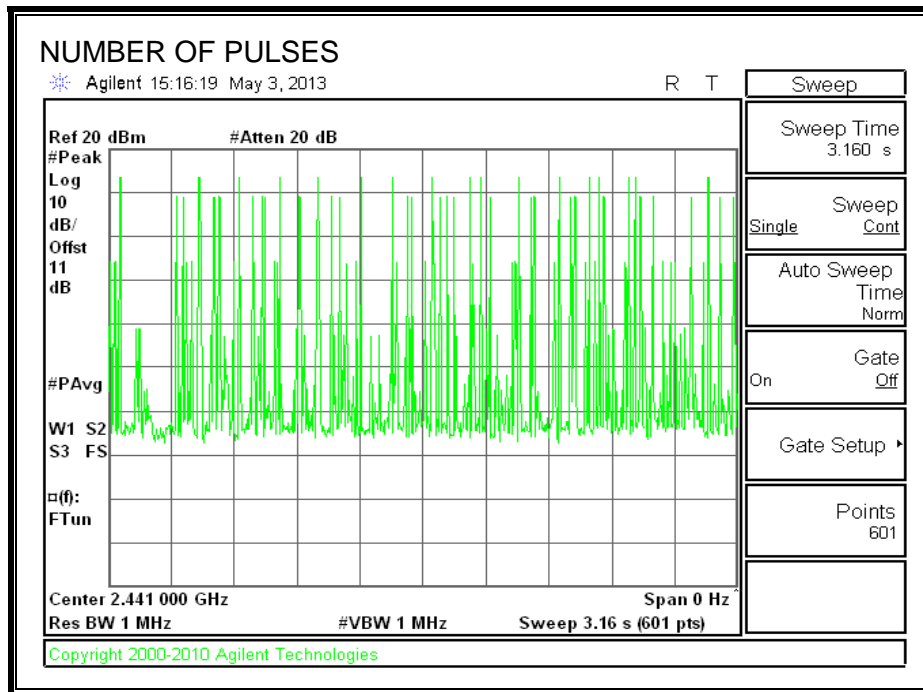

PULSE WIDTH 8PSK DH5

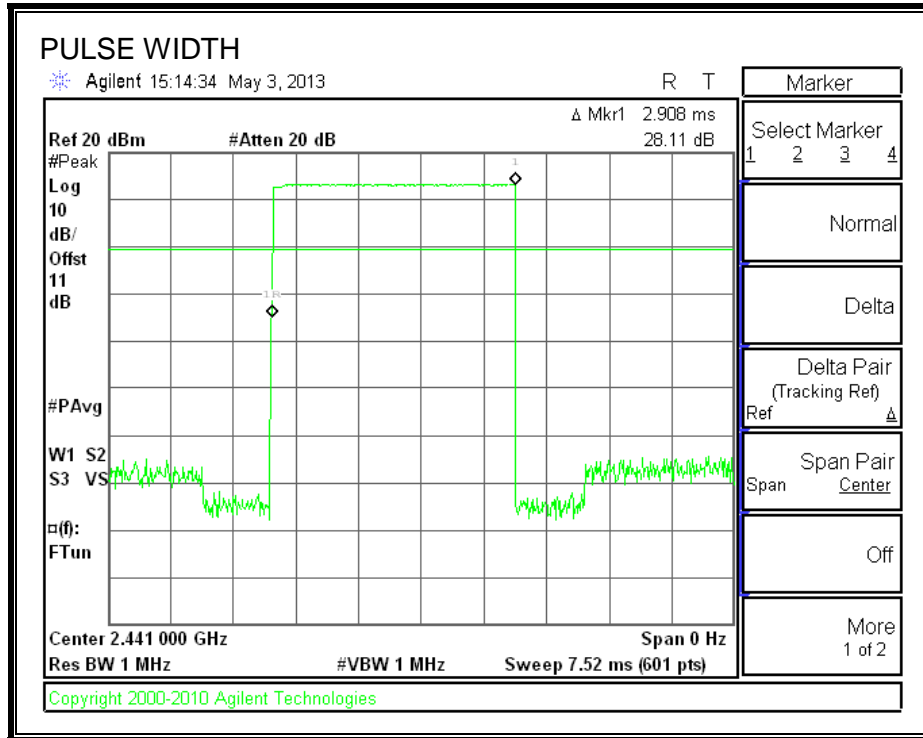

NUMBER OF PULSES IN 3.16 SECOND OBSERVATION PERIOD

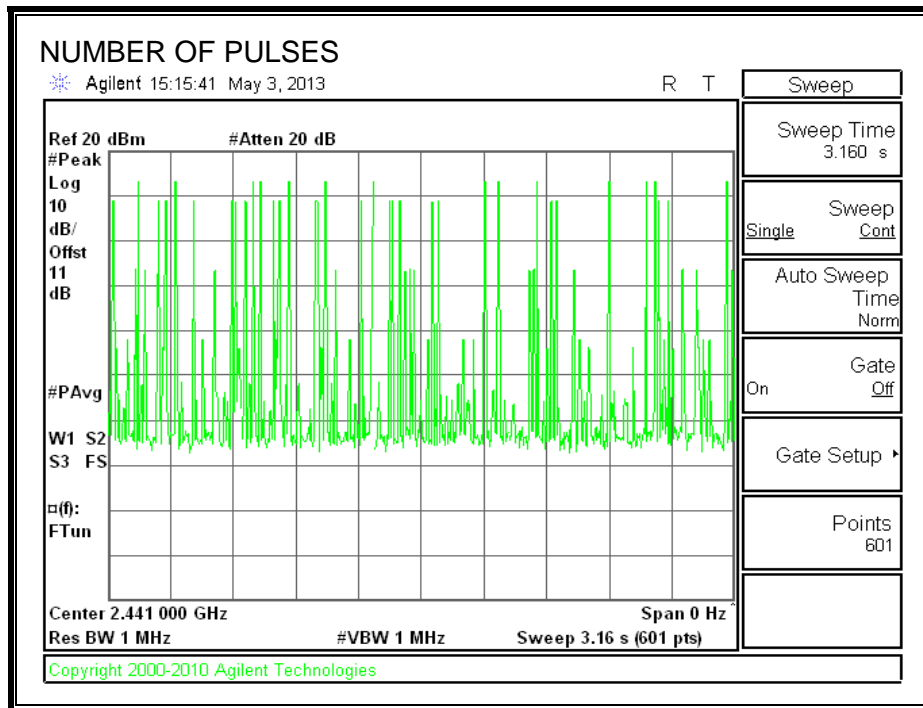

7.5. OUTPUT POWER

LIMIT

§15.247 (b) (1)

RSS-210 Issue 7 Clause A8.4

The maximum antenna gain is less than 6 dBi, therefore the limit is 30 dBm.

TEST PROCEDURE

The transmitter output is connected to a spectrum analyzer the analyzer bandwidth is set to a value greater than the 20 dB bandwidth of the EUT.

7.5.1. GFSK

Channel	Frequency (MHz)	Output Power (dBm)	Limit (dBm)	Margin (dB)
Low	2402	11.98	30	-18.02
Middle	2441	13.81	30	-16.19
High	2480	12.61	30	-17.39

7.5.2. 8PSK

Channel	Frequency (MHz)	Output Power (dBm)	Limit (dBm)	Margin (dB)
Low	2402	11.69	21	-9.31
Middle	2441	13.53	21	-7.47
High	2480	12.16	21	-8.84

GFSK

OUTPUT POWER

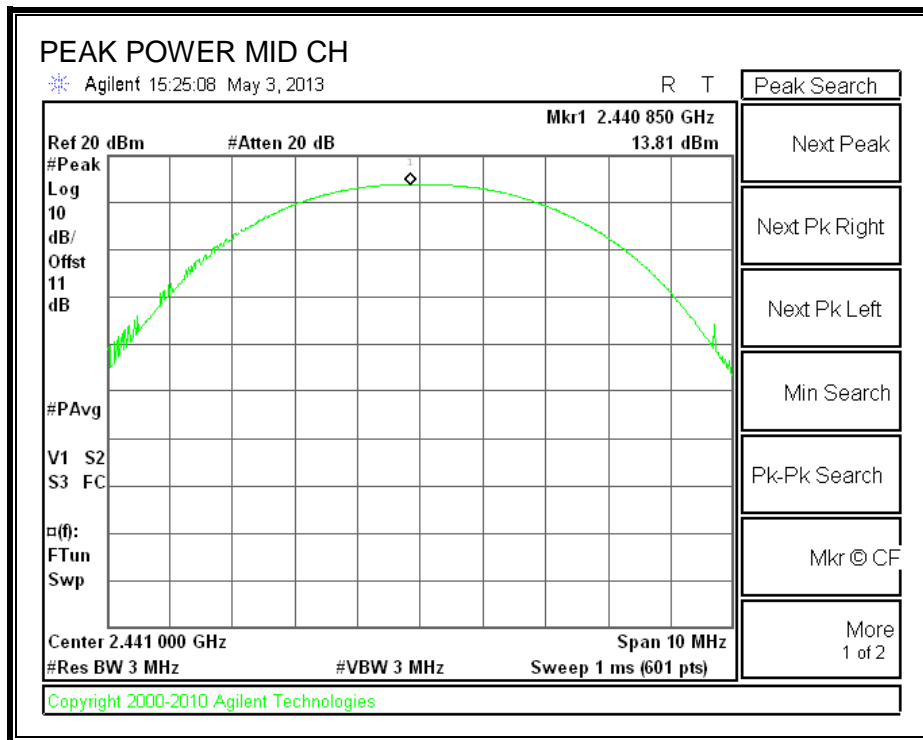
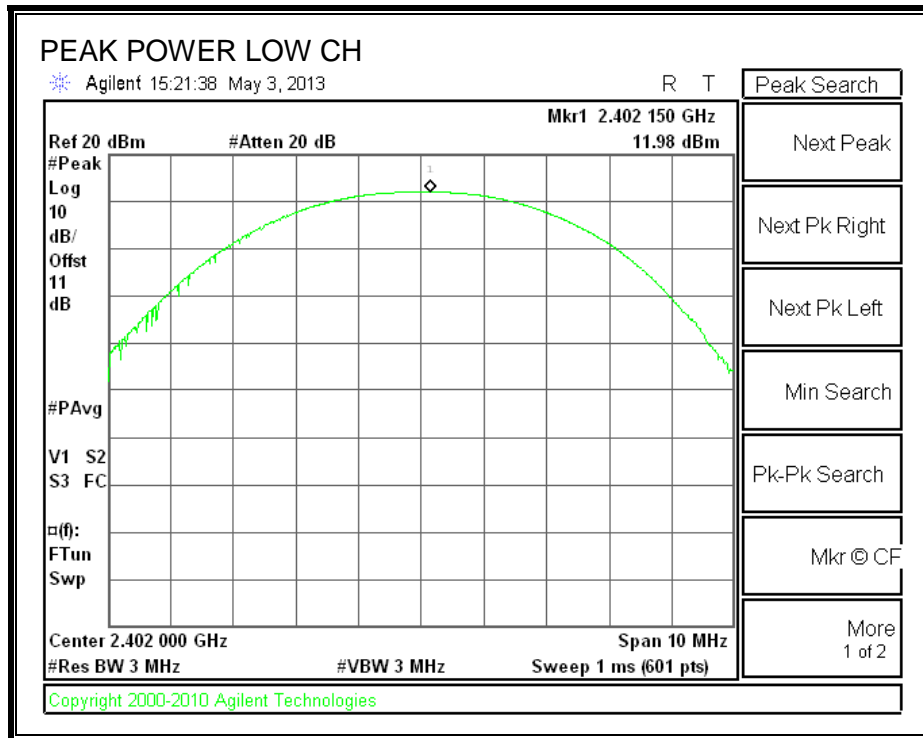

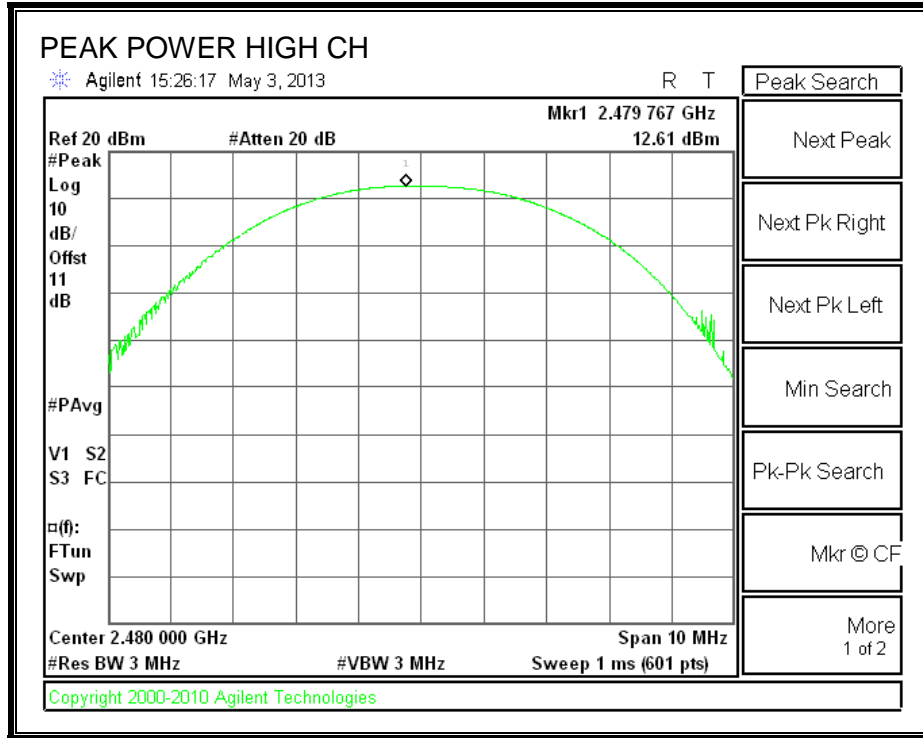

8PSK

OUTPUT POWER

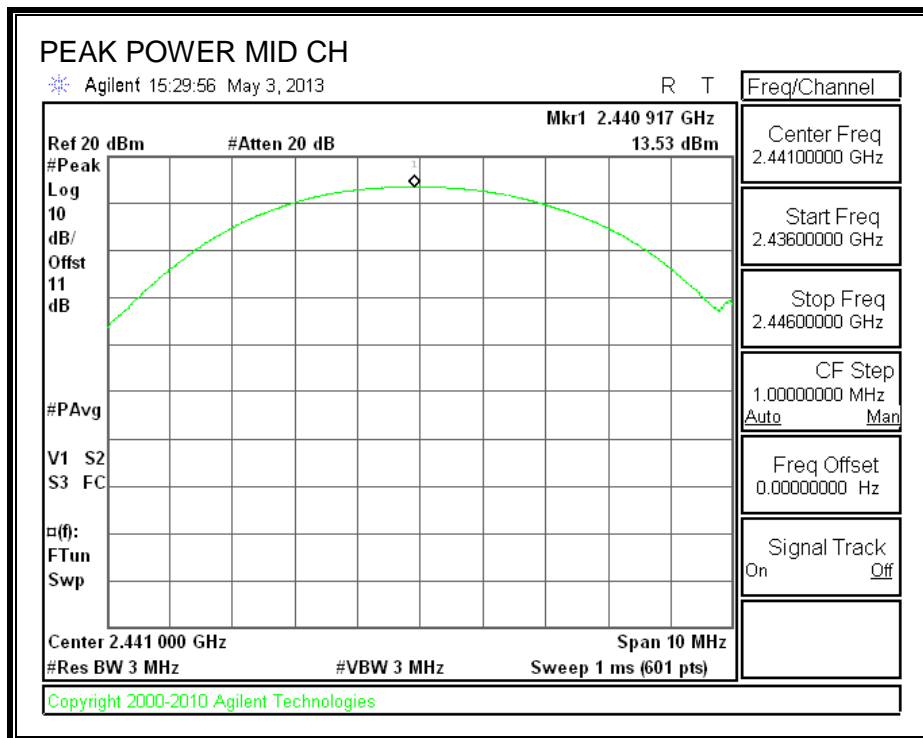
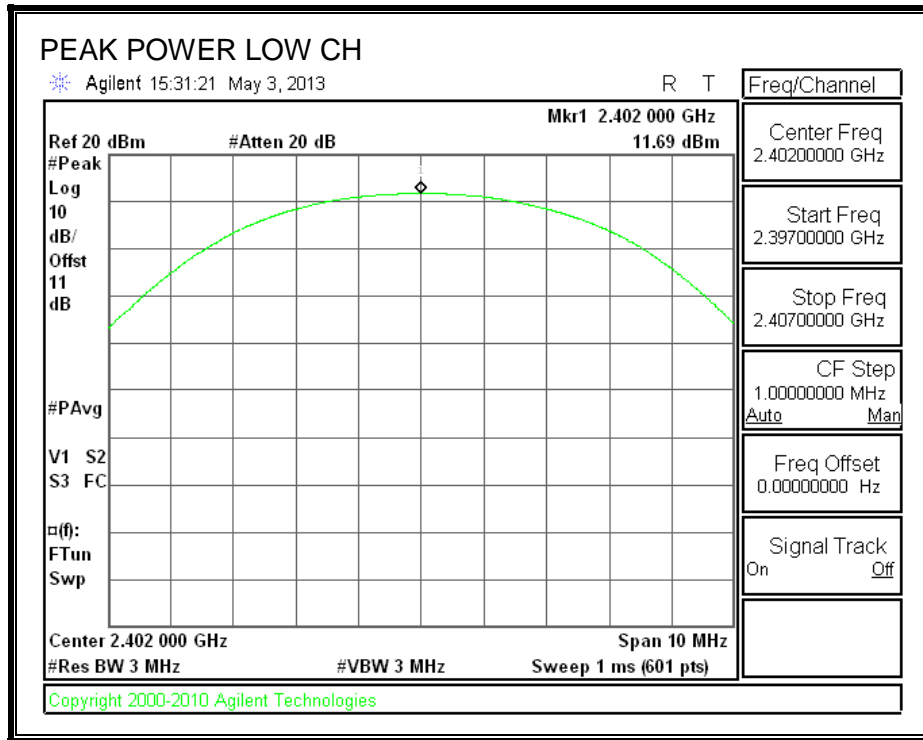

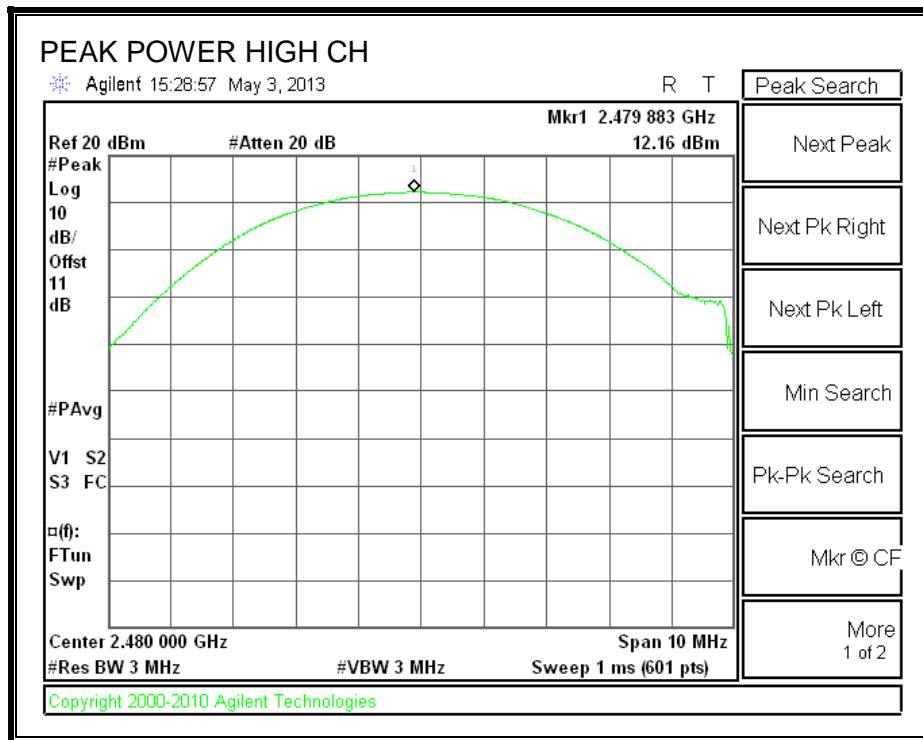

7.6. AVERAGE POWER

LIMIT

None; for reporting purposes only.

TEST PROCEDURE

The transmitter output is connected to a power meter.

RESULTS

The cable assembly insertion loss of 11.0 dB (including 10 dB pad and 1.0 dB cable) was entered as an offset in the power meter to allow for direct reading of power.

7.6.1. GFSK

Channel	Frequency (MHz)	Average Power (dBm)
Low	2402	11.32
Middle	2441	13.06
High	2480	11.80

7.6.2. 8PSK

Channel	Frequency (MHz)	Average Power (dBm)
Low	2402	10.30
Middle	2441	12.15
High	2480	10.28

7.7. CONDUCTED SPURIOUS EMISSIONS

LIMITS

FCC §15.247 (d)

IC RSS-210 A8.5

Limit = -20 dBc

TEST PROCEDURE

The transmitter output is connected to a spectrum analyzer. The resolution bandwidth is set to 100 kHz. The video bandwidth is set to 300 kHz.

The spectrum from 30 MHz to 26 GHz is investigated with the transmitter set to the lowest, middle, and highest channels.

The bandedges at 2.4 and 2.4835 GHz are investigated with the transmitter set to the normal hopping mode.

RESULTS

7.7.1. GFSK

SPURIOUS EMISSIONS, LOW CHANNEL

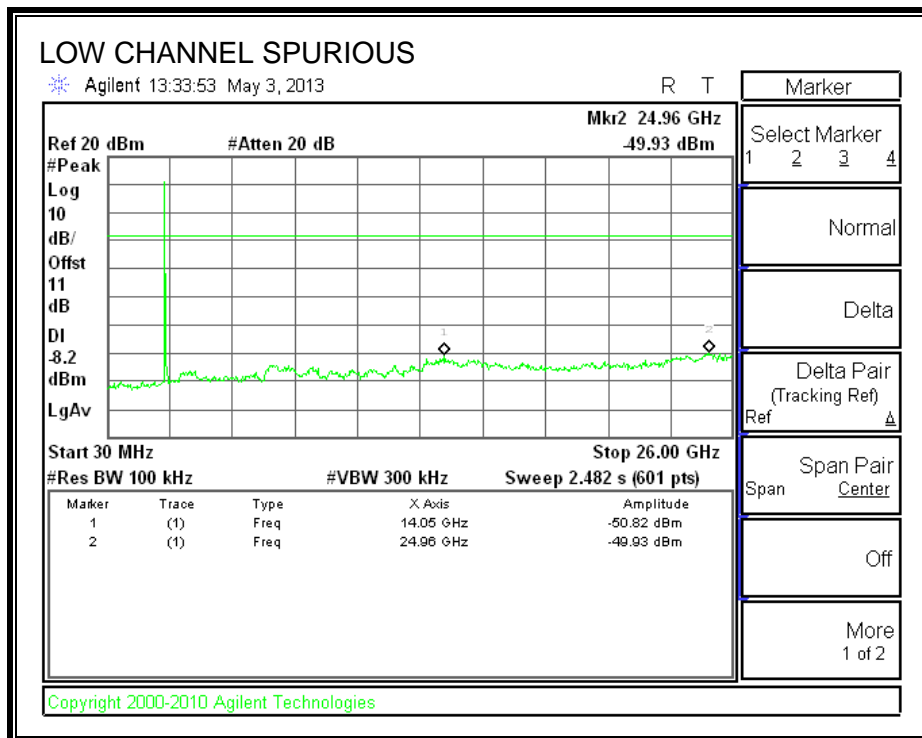
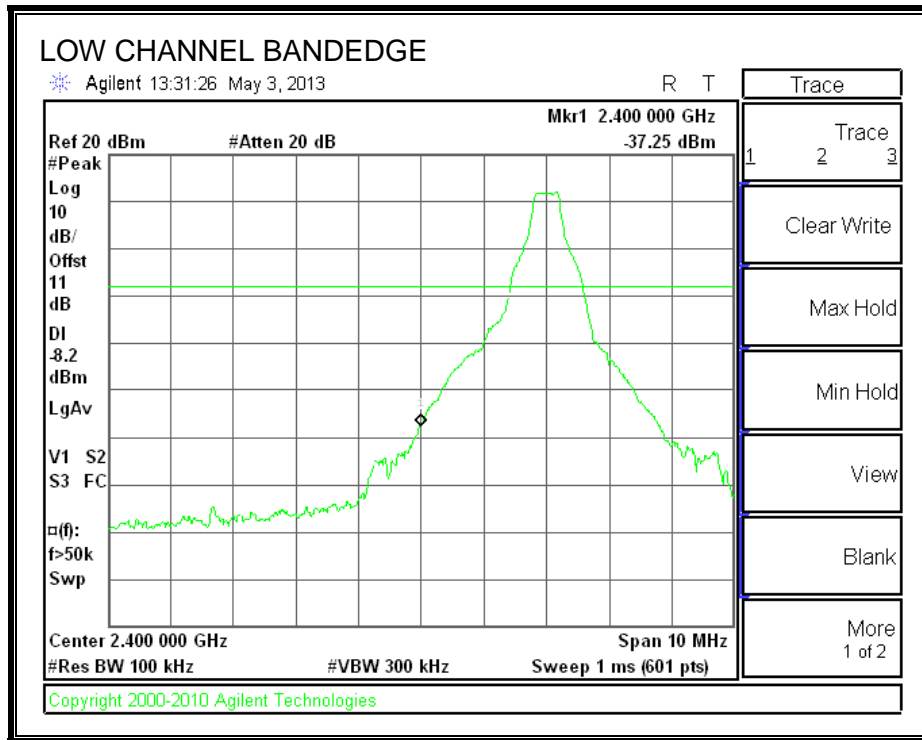

SPURIOUS EMISSIONS, MID CHANNEL

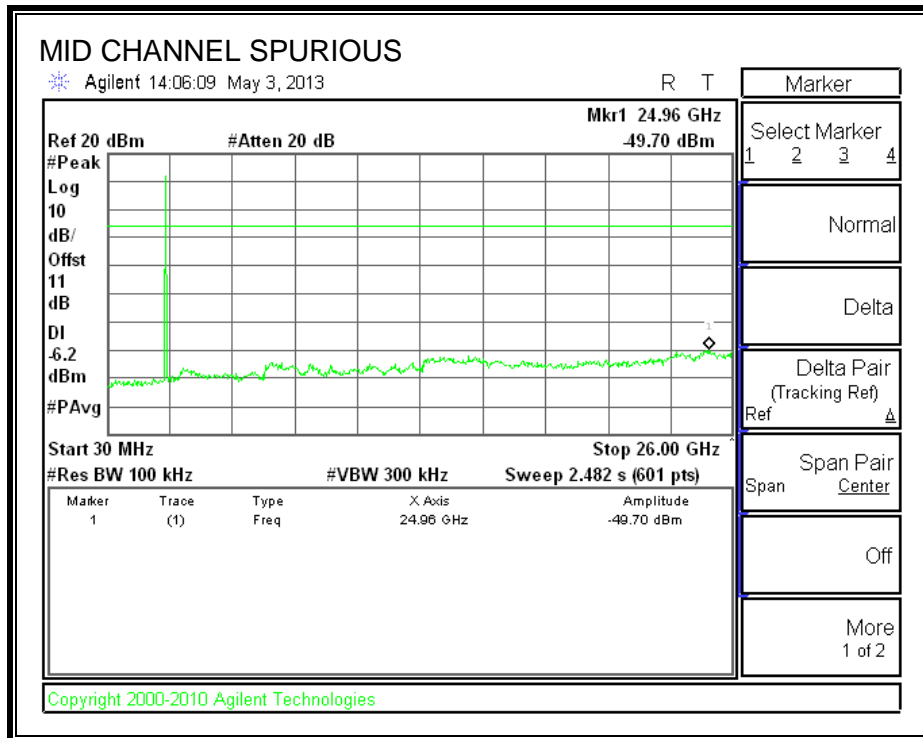
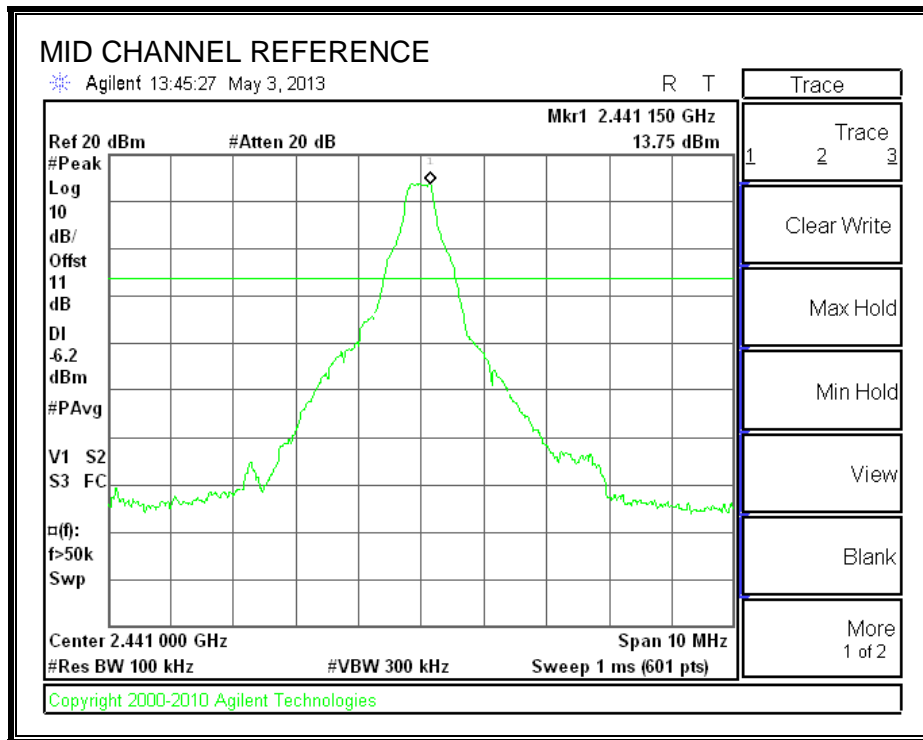

SPURIOUS EMISSIONS, HIGH CHANNEL

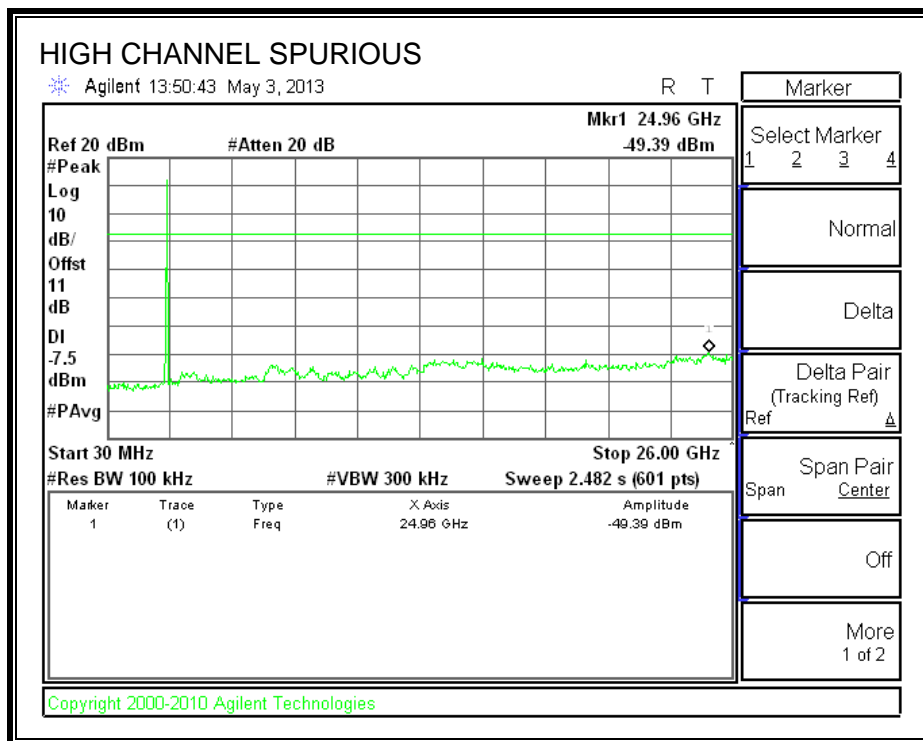
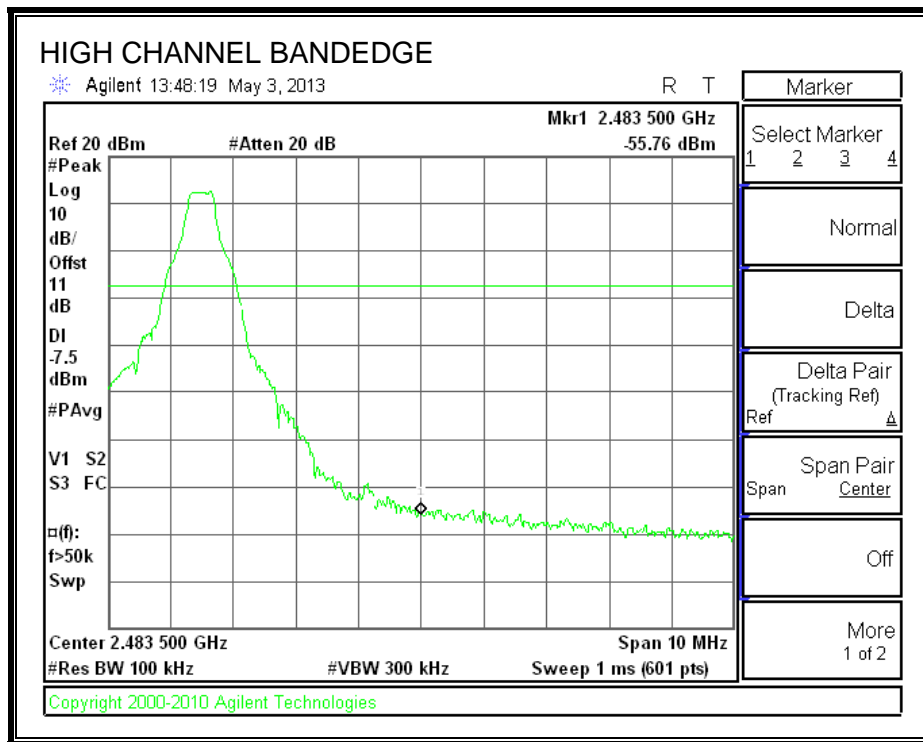

SPURIOUS BANDEDGE EMISSIONS WITH HOPPING ON

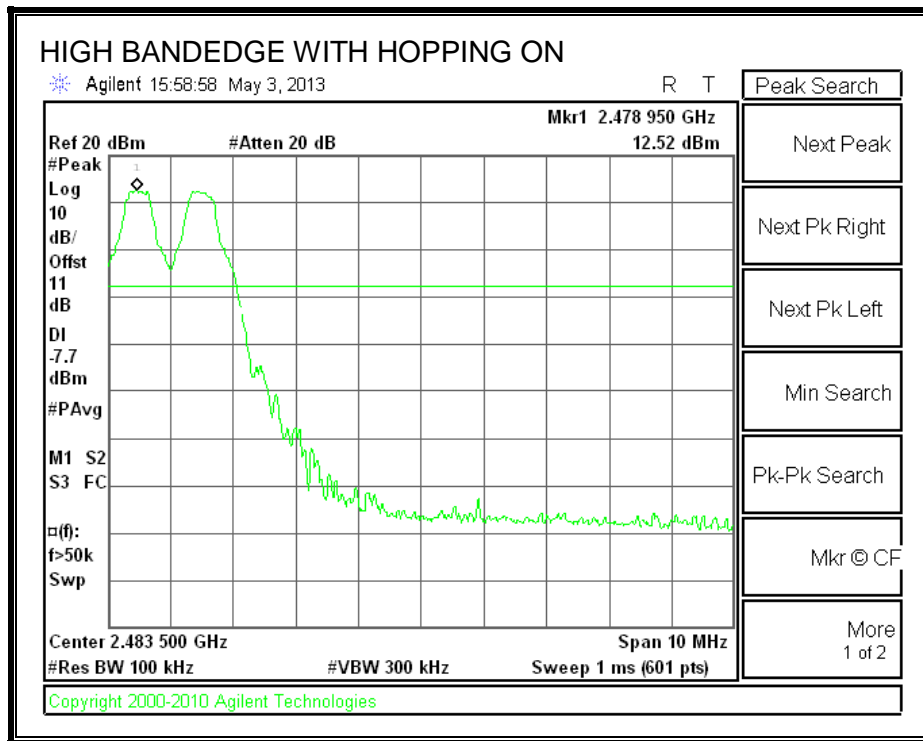
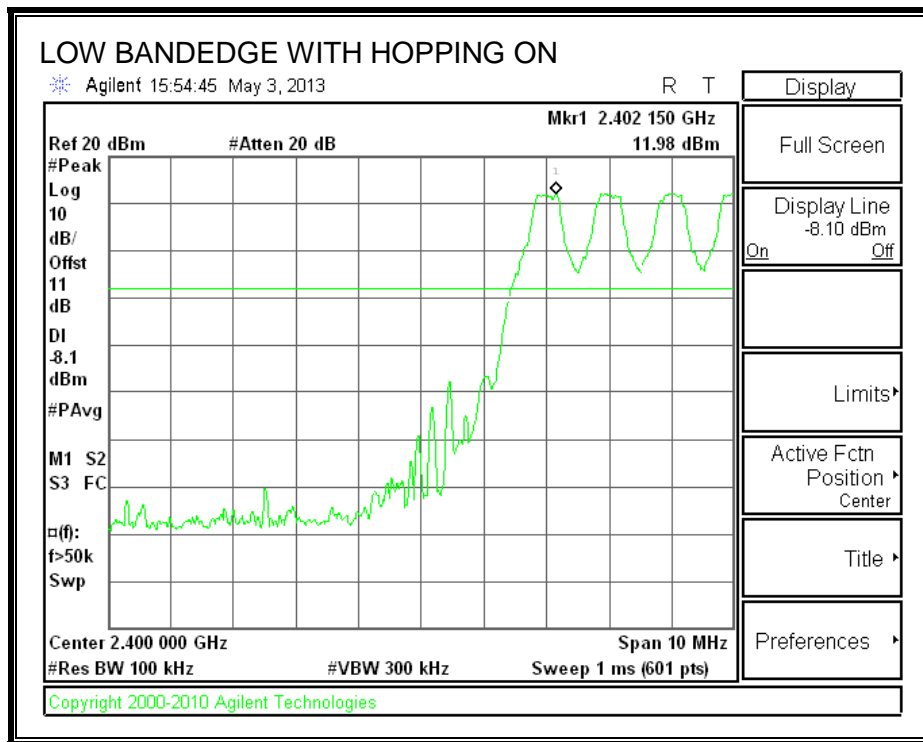

7.7.2. 8PSK

SPURIOUS EMISSIONS, LOW CHANNEL

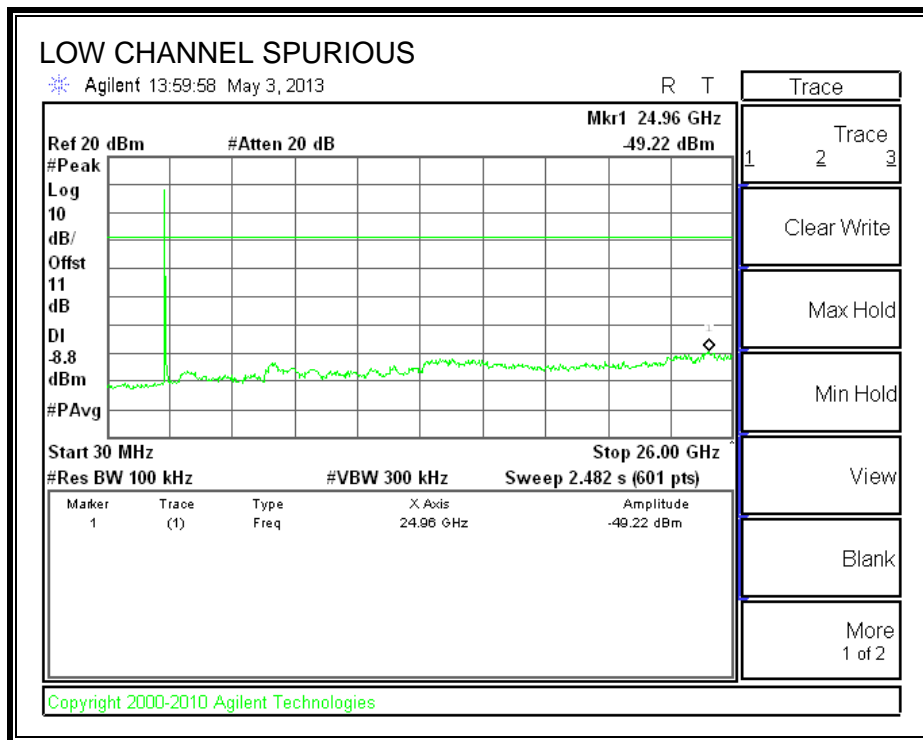
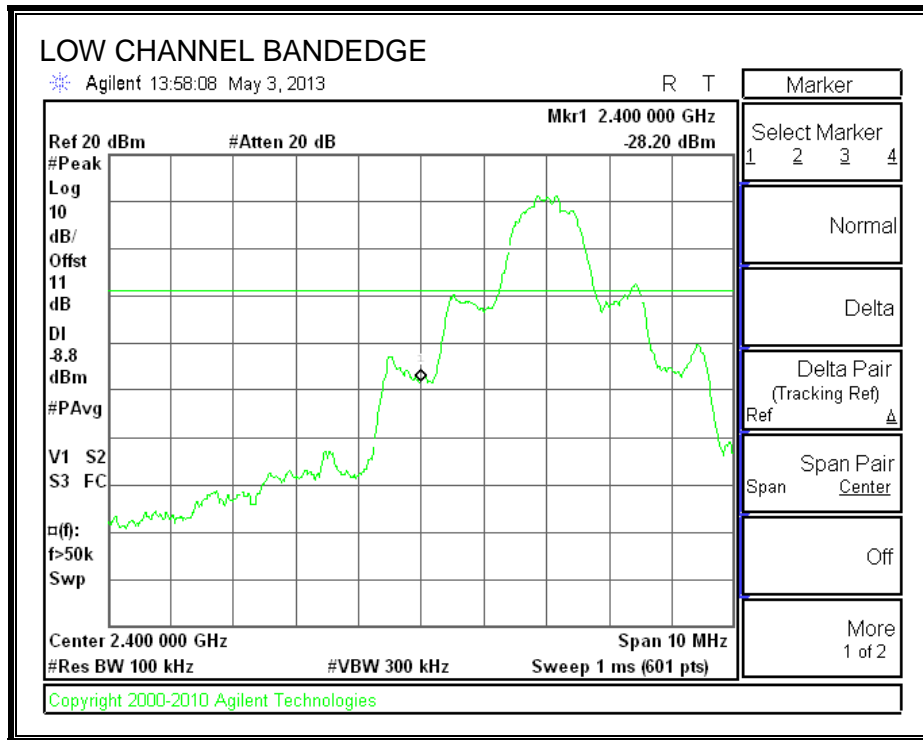

SPURIOUS EMISSIONS, MID CHANNEL

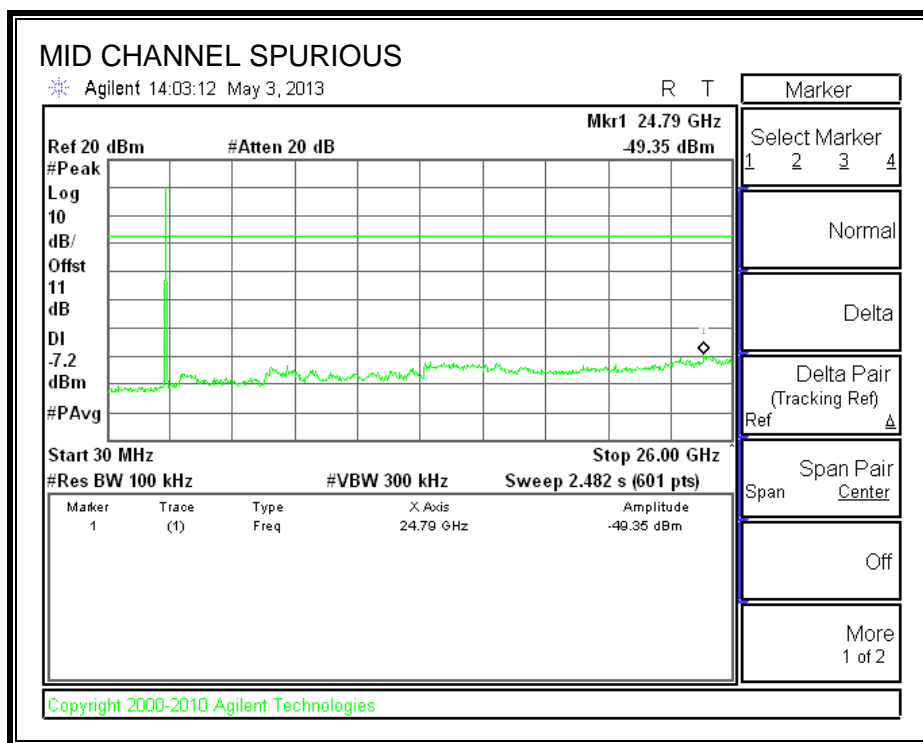
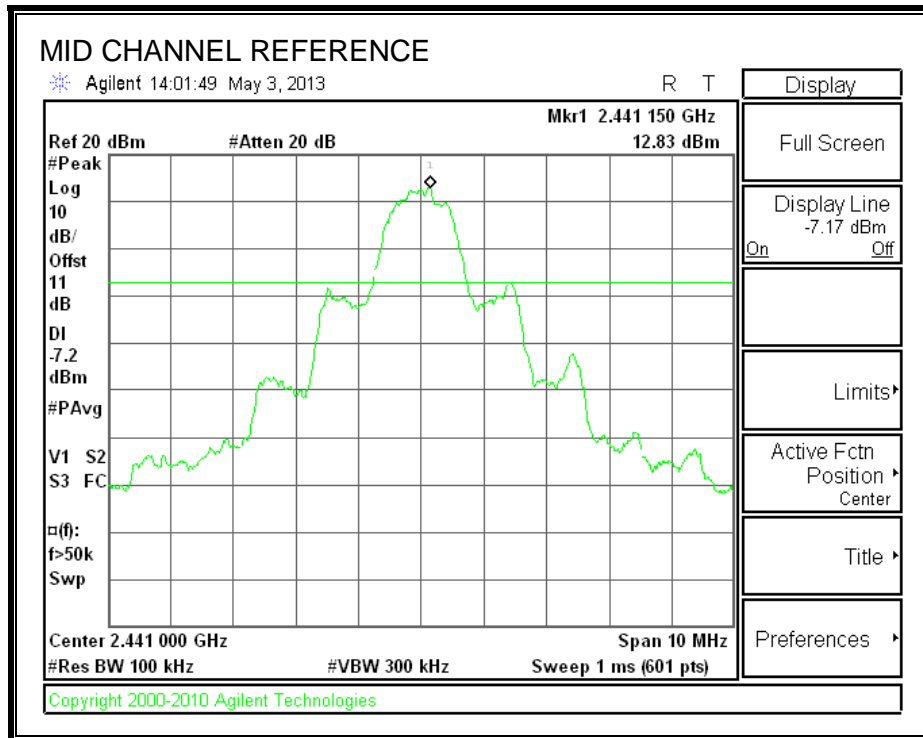

SPURIOUS EMISSIONS, HIGH CHANNEL

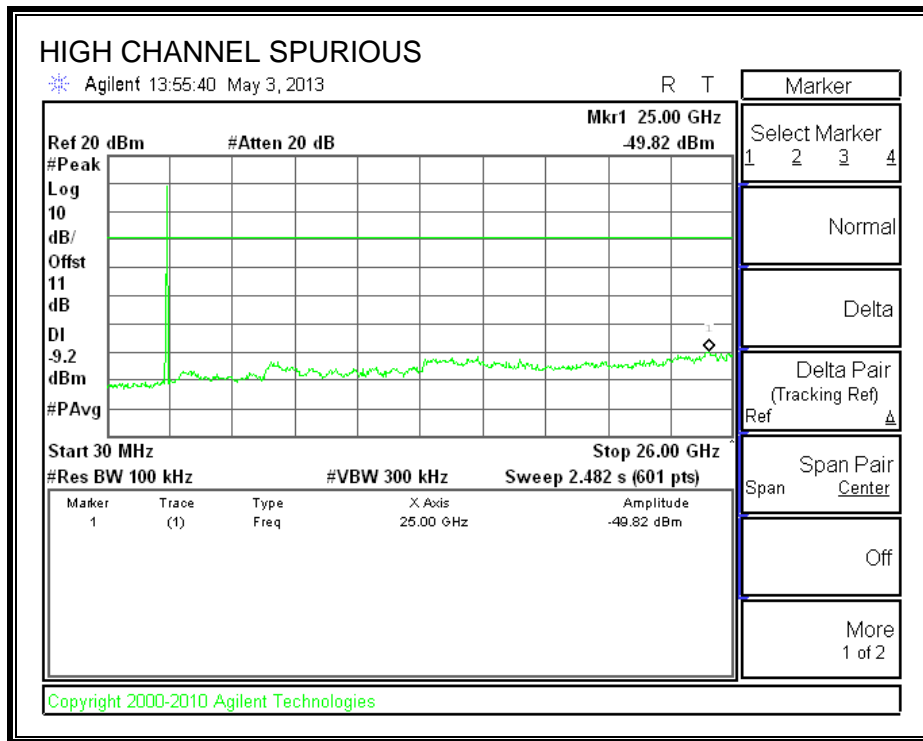
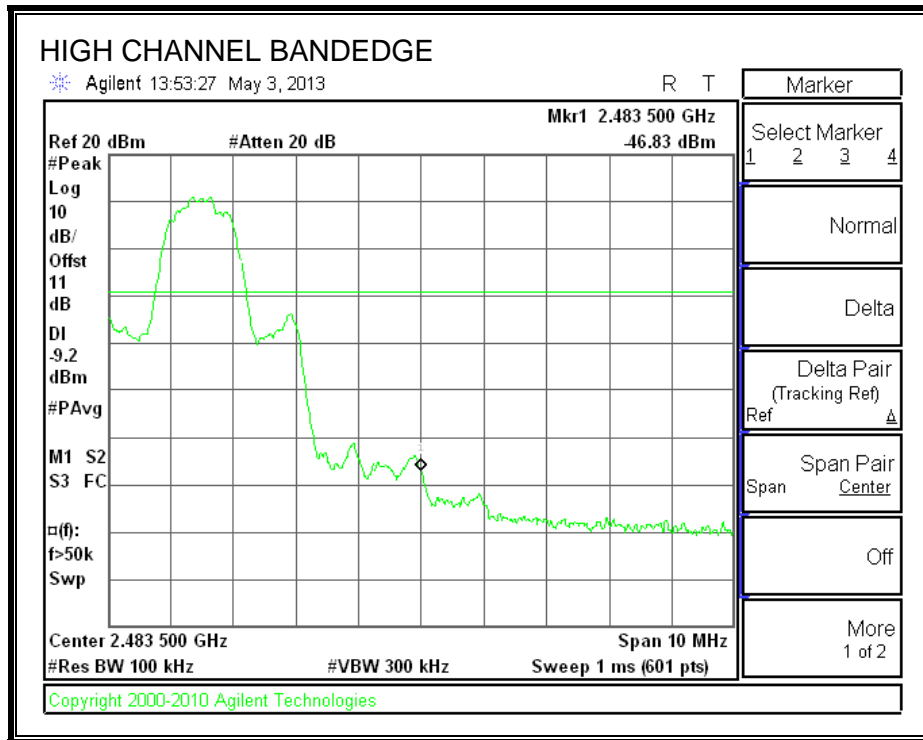

SPURIOUS BANDEDGE EMISSIONS WITH HOPPING ON

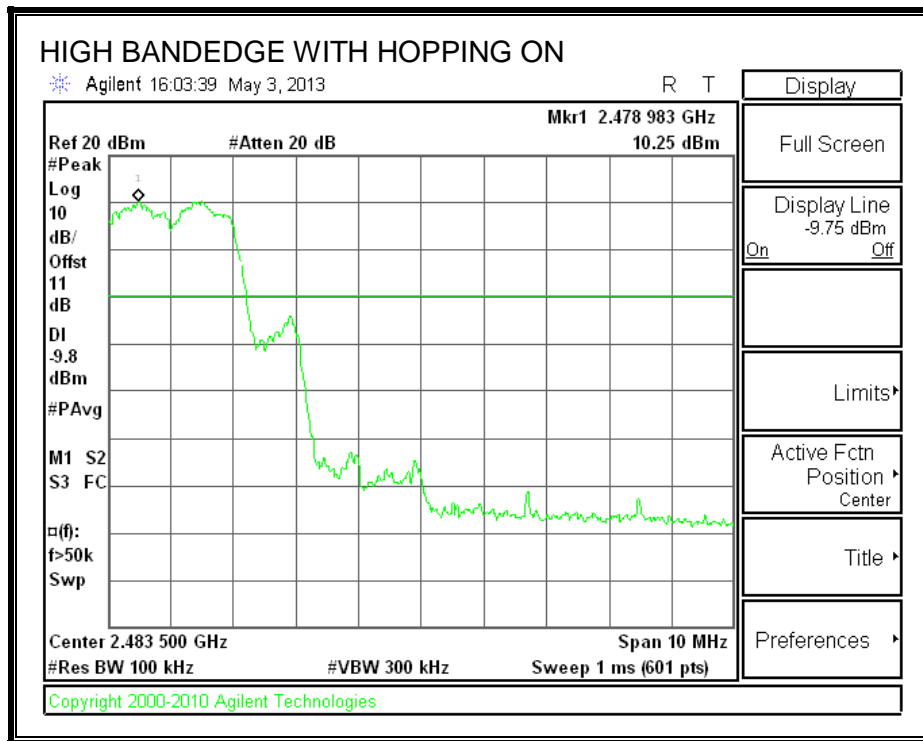
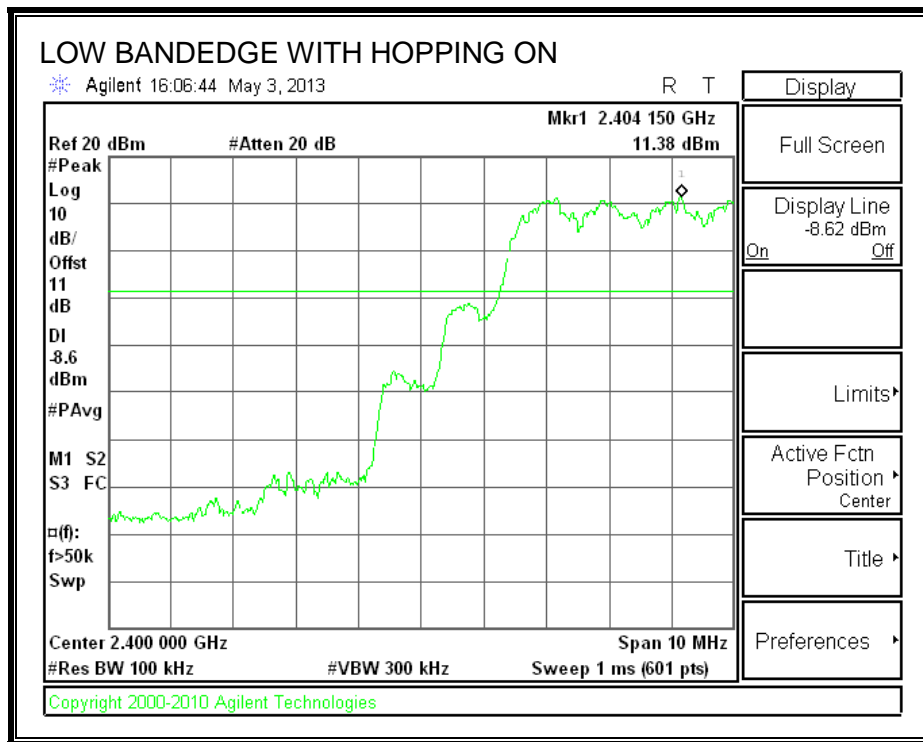

8. RADIATED TEST RESULTS

8.1. LIMITS AND PROCEDURE

LIMITS

FCC §15.205 and §15.209

IC RSS-210 Clause 2.6 (Transmitter)

IC RSS-GEN Clause 6 (Receiver)

Frequency Range (MHz)	Field Strength Limit (uV/m) at 3 m	Field Strength Limit (dBuV/m) at 3 m
30 - 88	100	40
88 - 216	150	43.5
216 - 960	200	46
Above 960	500	54

TEST PROCEDURE

The EUT is placed on a non-conducting table 80 cm above the ground plane. The antenna to EUT distance is 3 meters. The EUT is configured in accordance with ANSI C63.4. The EUT is set to transmit in a continuous mode.

For measurements below 1 GHz the resolution bandwidth is set to 100 kHz for peak detection measurements or 120 kHz for quasi-peak detection measurements. Peak detection is used unless otherwise noted as quasi-peak.

For measurements above 1 GHz the resolution bandwidth is set to 1 MHz, then the video bandwidth is set to 1 MHz for peak measurements and 10 Hz for average measurements.

The spectrum from 30 MHz to 26 GHz is investigated with the transmitter set to the lowest, middle, and highest channels in the 2.4 GHz band.

The frequency range of interest is monitored at a fixed antenna height and EUT azimuth. The EUT is rotated through 360 degrees to maximize emissions received. The antenna is scanned from 1 to 4 meters above the ground plane to further maximize the emission. Measurements are made with the antenna polarized in both the vertical and the horizontal positions.

RESULTS

For the Bandedge measurement, there is no need for the average reading since the peak reading passed with the peak limit. The average reading = peak reading – 20*log (1/duty cycle), and the 20*log (1/duty cycle) is greater than 20dB.

8.2. TRANSMITTER ABOVE 1 GHz

8.2.1. BASIC DATA RATE GFSK MODULATION

RESTRICTED BANDEDGE (LOW CHANNEL, HORIZONTAL)

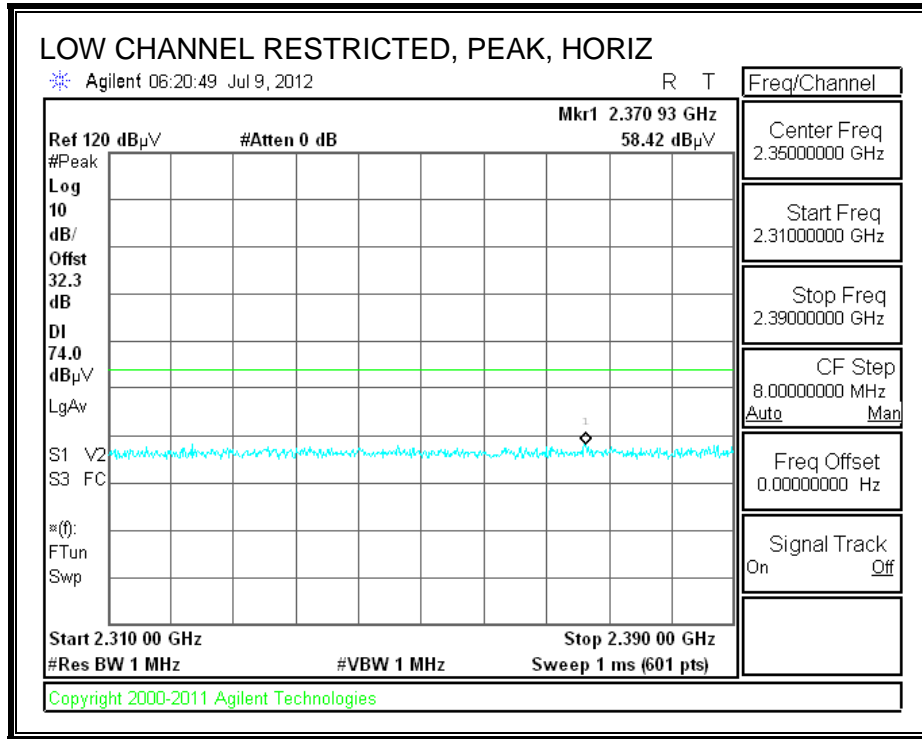

RESTRICTED BANDEDGE (LOW CHANNEL, VERTICAL)

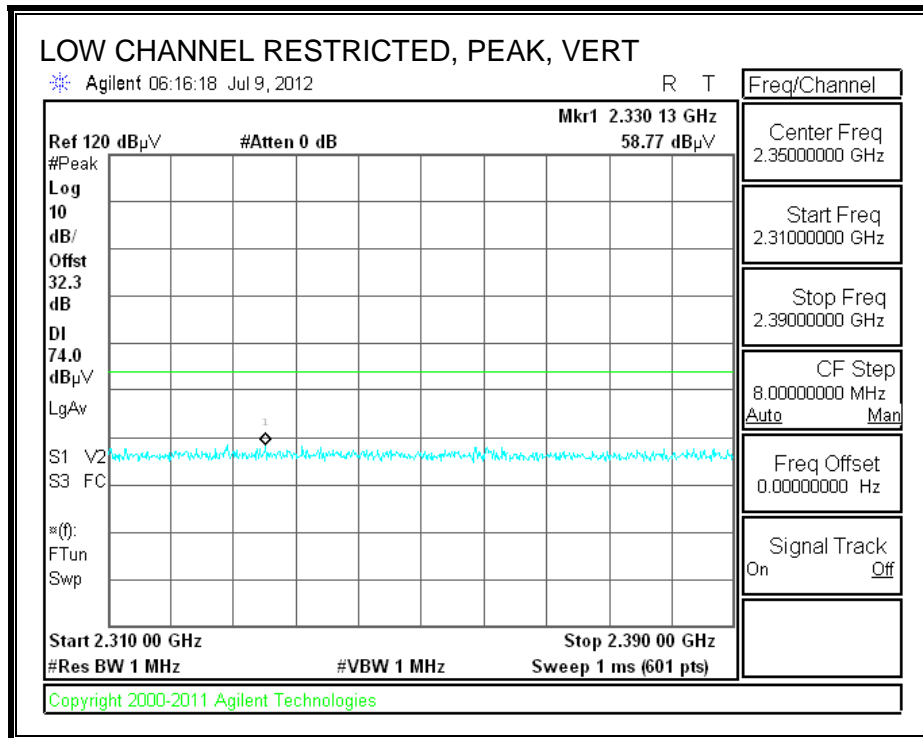

RESTRICTED BANDEDGE (HIGH CHANNEL, HORIZONTAL)

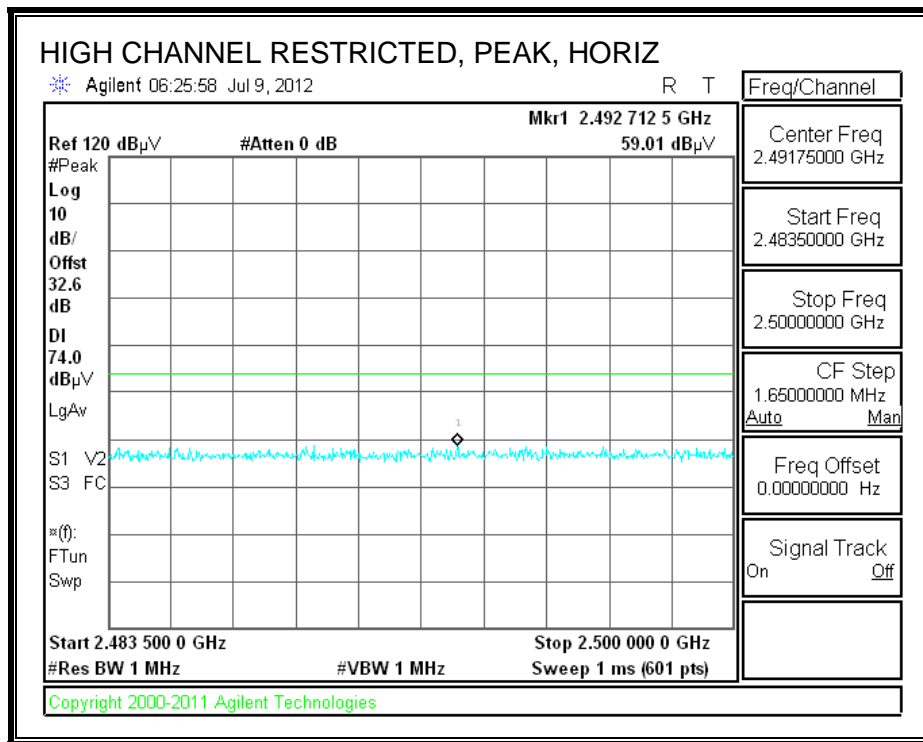

RESTRICTED BANDEDGE (HIGH CHANNEL, VERTICAL)

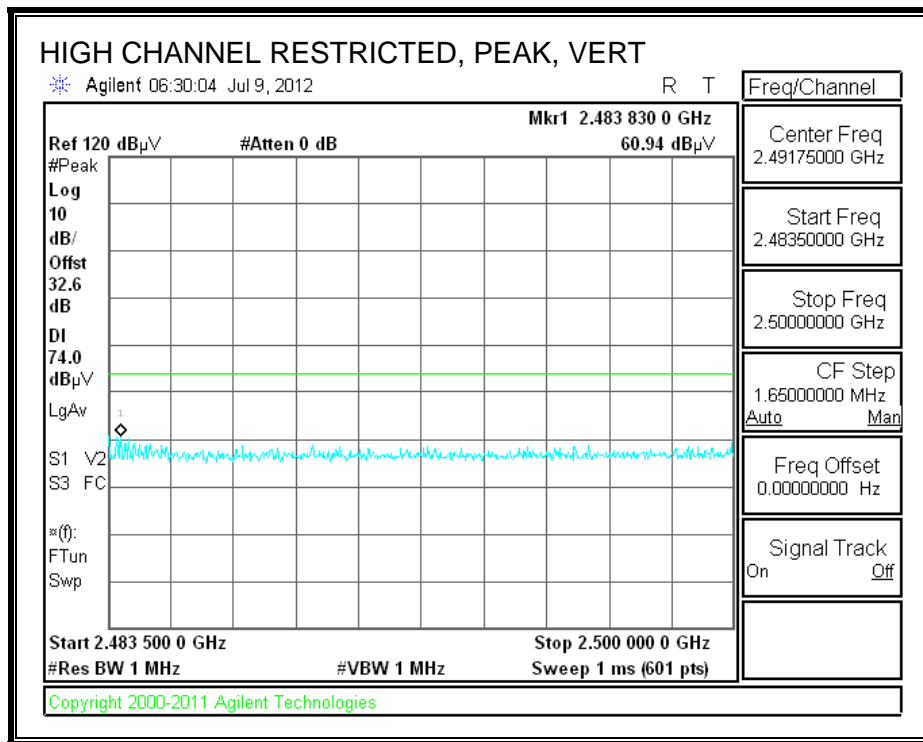

HARMONICS AND SPURIOUS EMISSIONS

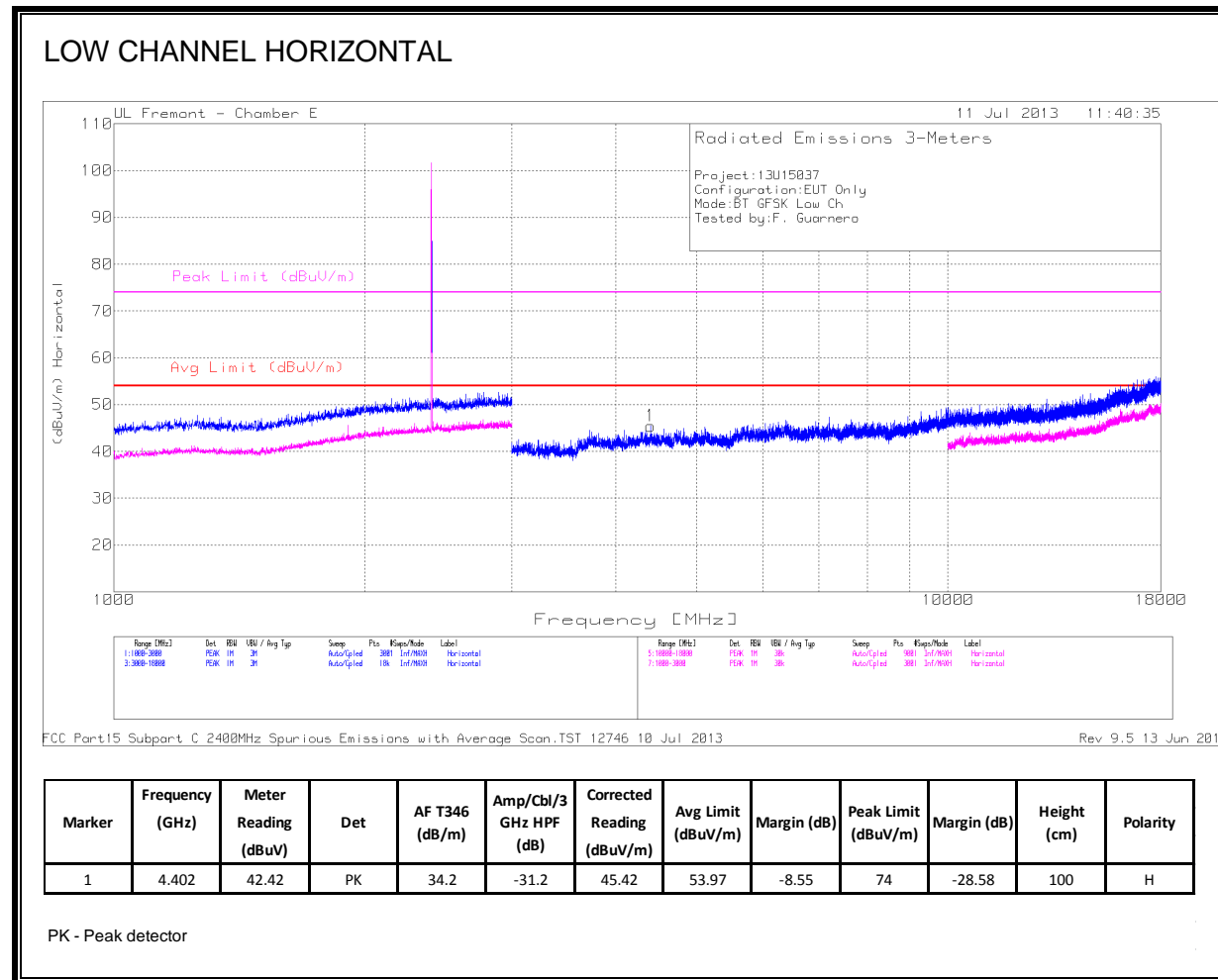

LOW CHANNEL VERTICAL

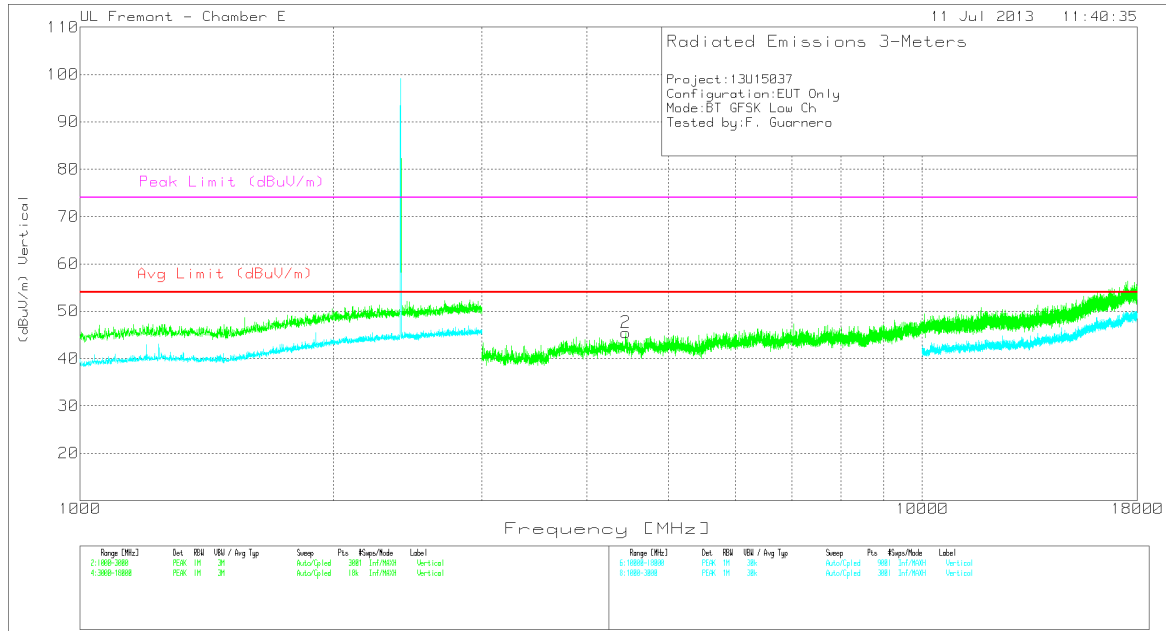

FCC Part15 Subpart C 2400MHz Spurious Emissions with Average Scan.TSI 12746 10 Jul 2013 Rev 9.5 13 Jun 2013

Marker	Frequency (GHz)	Meter Reading (dBUV)	Det	AF T346 (dB/m)	Amp/Cbl/3 GHz HPF (dB)	Corrected Reading (dBUV/m)	Avg Limit (dBUV/m)	Margin (dB)	Peak Limit (dBUV/m)	Margin (dB)	Height (cm)	Polarity
2	4.446	42.77	PK	34.2	-31.5	45.47	53.97	-8.5	74	-28.53	100	V

PK - Peak detector

MID CHANNEL HORIZONTAL

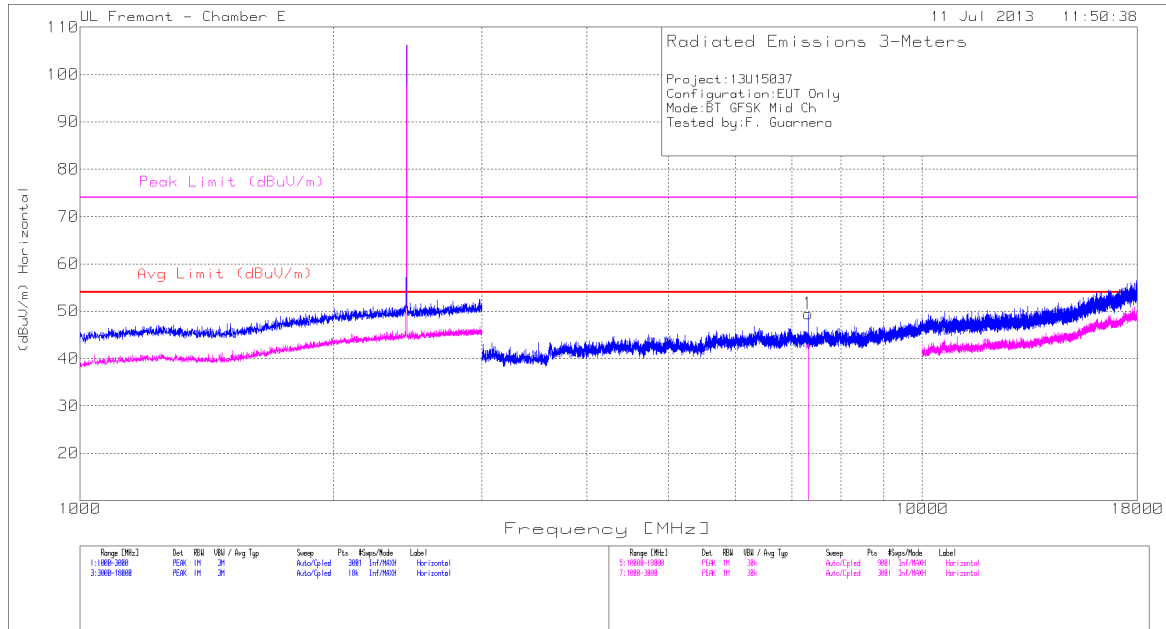

FCC Part15 Subpart C 2400MHz Spurious Emissions with Average Scan.TST 12746 10 Jul 2013 Rev 9.5 13 Jun 2013

Marker	Frequency (GHz)	Meter Reading (dBuV)	Det	AF T346 (dB/m)	Amp/Cbl/3 GHz HPF (dB)	Corrected Reading (dBuV/m)	Avg Limit (dBuV/m)	Margin (dB)	Peak Limit (dBuV/m)	Margin (dB)	Height (cm)	Polarity
1	7.324	41.84	PK	36	-28.4	49.44	53.97	-4.53	74	-24.56	199	H
	7.323	34.98	Av	36	-28.4	42.58	53.97	-11.39	74	-31.42	158	H

Av - average detection
 PK - Peak detector

MID CHANNEL VERTICAL

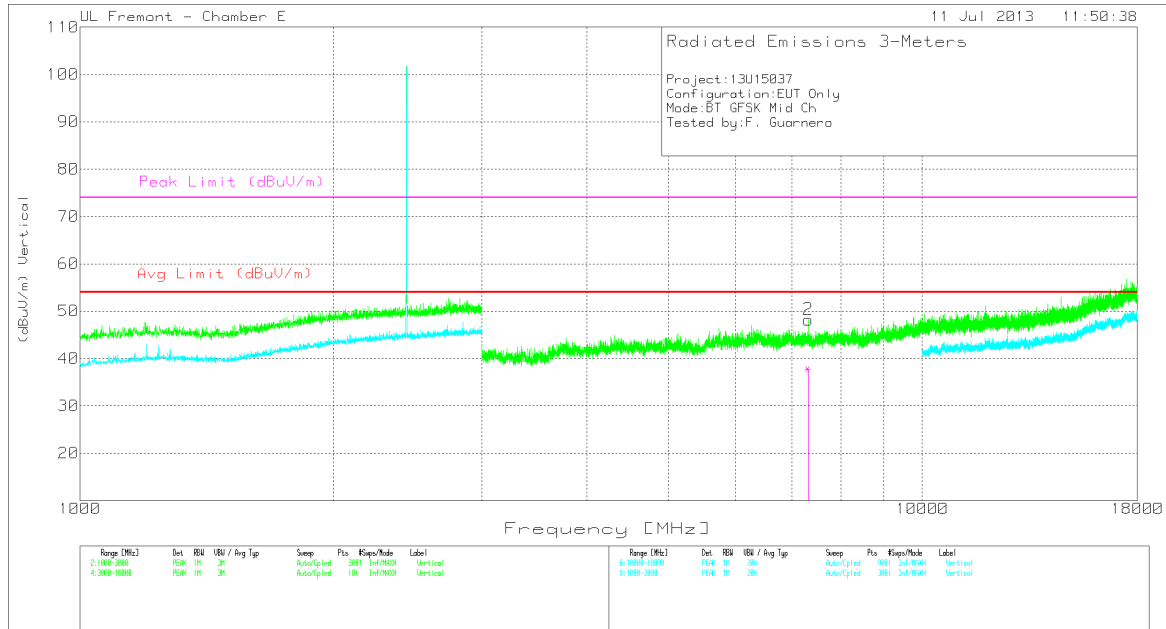

FCC Part15 Subpart C 2400MHz Spurious Emissions with Average Scan.TSI 12746 10 Jul 2013

Rev 9.5 13 Jun 2013

Marker	Frequency (GHz)	Meter Reading (dBuV)	Det	AF T346 (dB/m)	Amp/Cbl/3 GHz HPF (dB)	Corrected Reading (dBuV/m)	Avg Limit (dBuV/m)	Margin (dB)	Peak Limit (dBuV/m)	Margin (dB)	Height (cm)	Polarity
2	7.324	40.61	PK	36	-28.4	48.21	53.97	-5.76	74	-25.79	199	V
	7.323	30.11	Av	36	-28.4	37.71	53.97	-16.26	74	-36.29	142	V

Av - average detection
 PK - Peak detector

HIGH CHANNEL HORIZONTAL

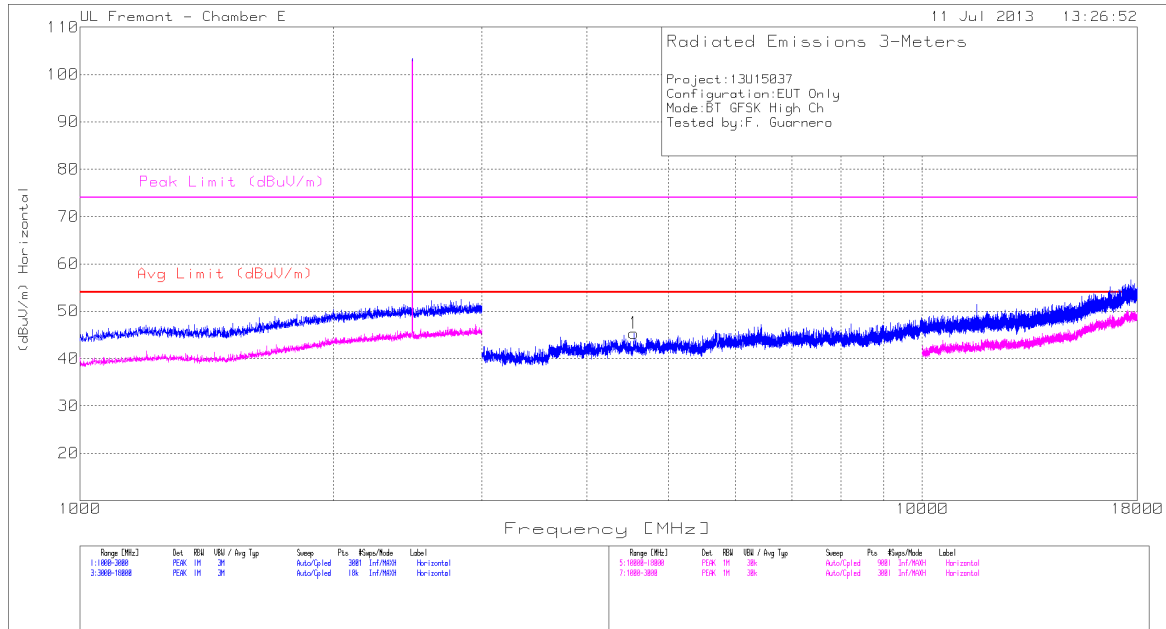

FCC Part15 Subpart C 2400MHz Spurious Emissions with Average Scan.TST 12746 10 Jul 2013 Rev 9.5 13 Jun 2013

Marker	Frequency (GHz)	Meter Reading (dBuV)	Det	AF T346 (dB/m)	Amp/Cbl/3 GHz HPF (dB)	Corrected Reading (dBuV/m)	Avg Limit (dBuV/m)	Margin (dB)	Peak Limit (dBuV/m)	Margin (dB)	Height (cm)	Polarity
1	4.546	43.1	PK	34.3	-32.1	45.3	53.97	-8.67	74	-28.7	100	H

PK - Peak detector

HIGH CHANNEL VERTICAL

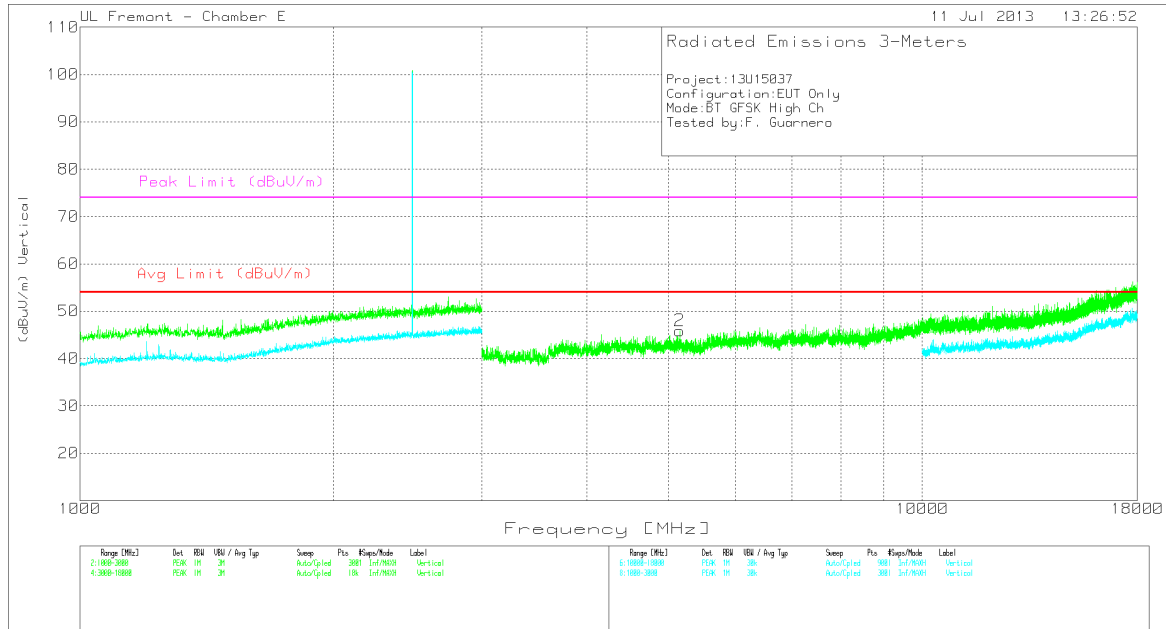

FCC Part15 Subpart C 2400MHz Spurious Emissions with Average Scan.TSI 12746 10 Jul 2013

Rev 9.5 13 Jun 2013

Marker	Frequency (GHz)	Meter Reading (dBuV)	Det	AF T346 (dB/m)	Amp/Cbl/3 GHz HPF (dB)	Corrected Reading (dBuV/m)	Avg Limit (dBuV/m)	Margin (dB)	Peak Limit (dBuV/m)	Margin (dB)	Height (cm)	Polarity
2	5.152	42.05	PK	34.6	-30.8	45.85	53.97	-8.12	74	-28.15	199	V

PK - Peak detector

8.2.2. ENHANCED DATA RATE 8PSK MODULATION

RESTRICTED BANDEDGE (LOW CHANNEL, HORIZONTAL)

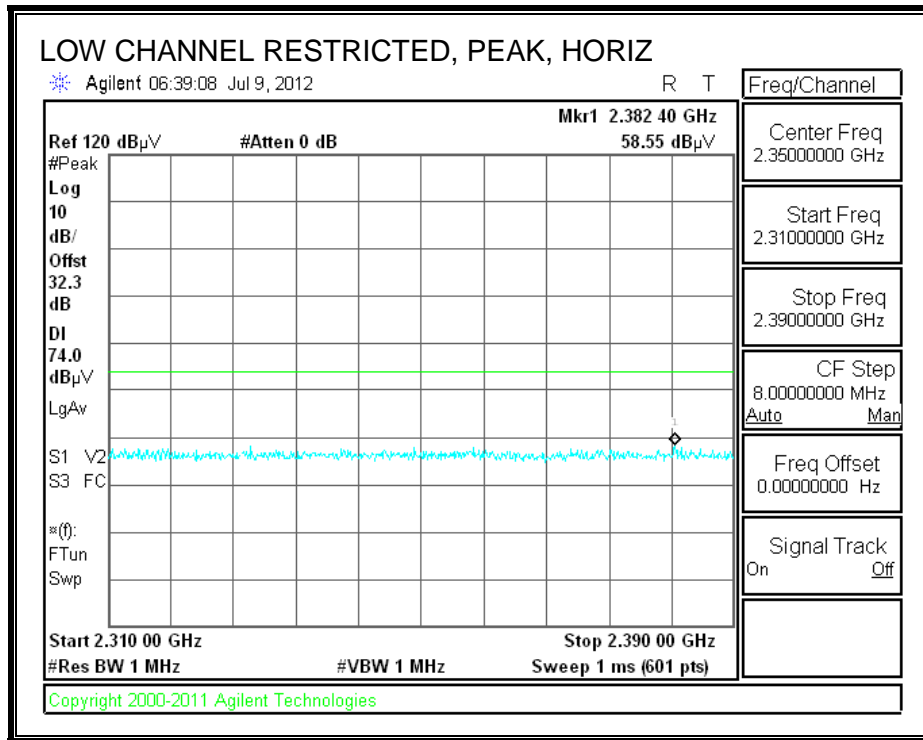

RESTRICTED BANDEDGE (LOW CHANNEL, VERTICAL)

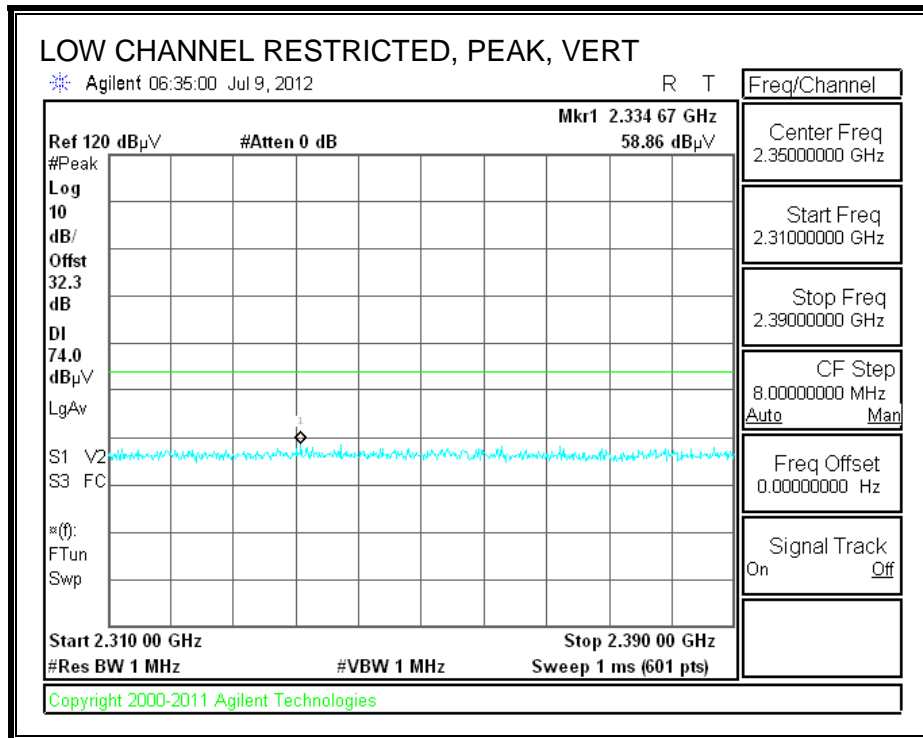

RESTRICTED BANDEDGE (HIGH CHANNEL, HORIZONTAL)

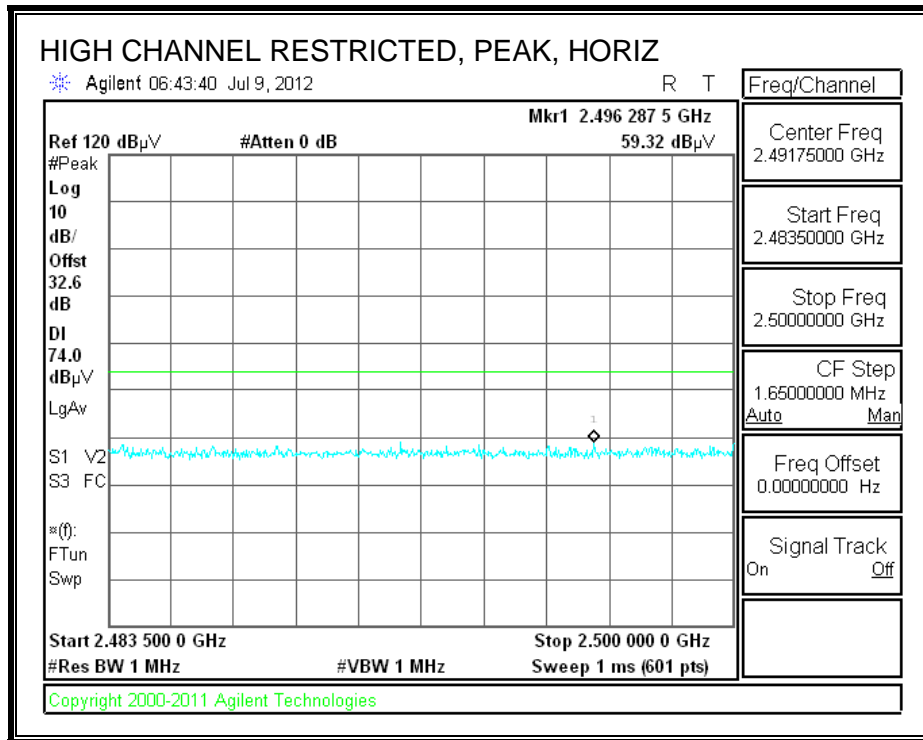

RESTRICTED BANDEDGE (HIGH CHANNEL, VERTICAL)

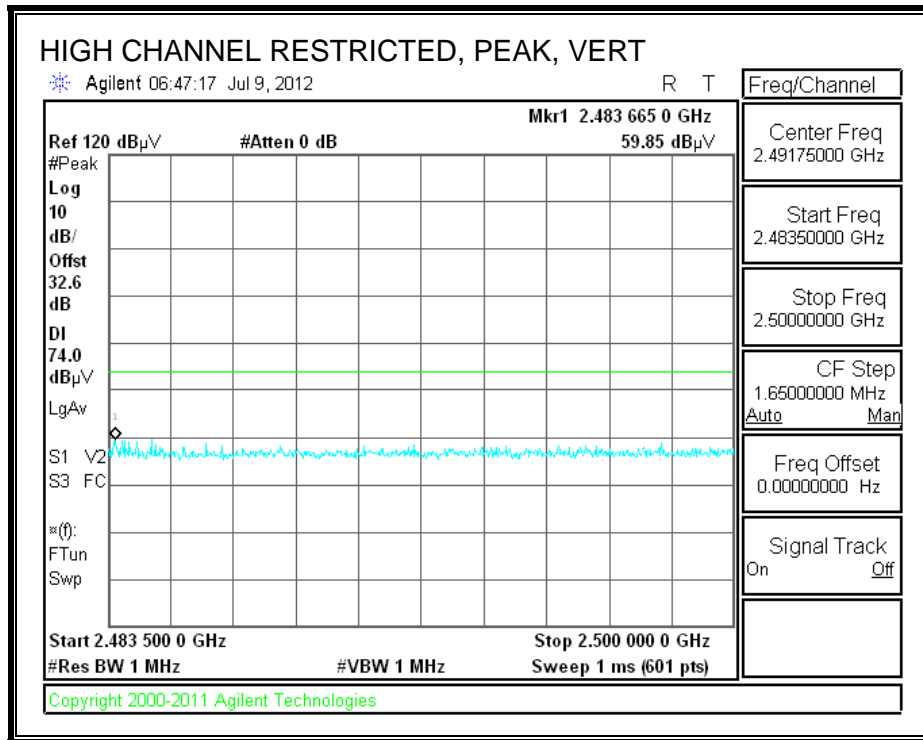

HARMONICS AND SPURIOUS EMISSIONS

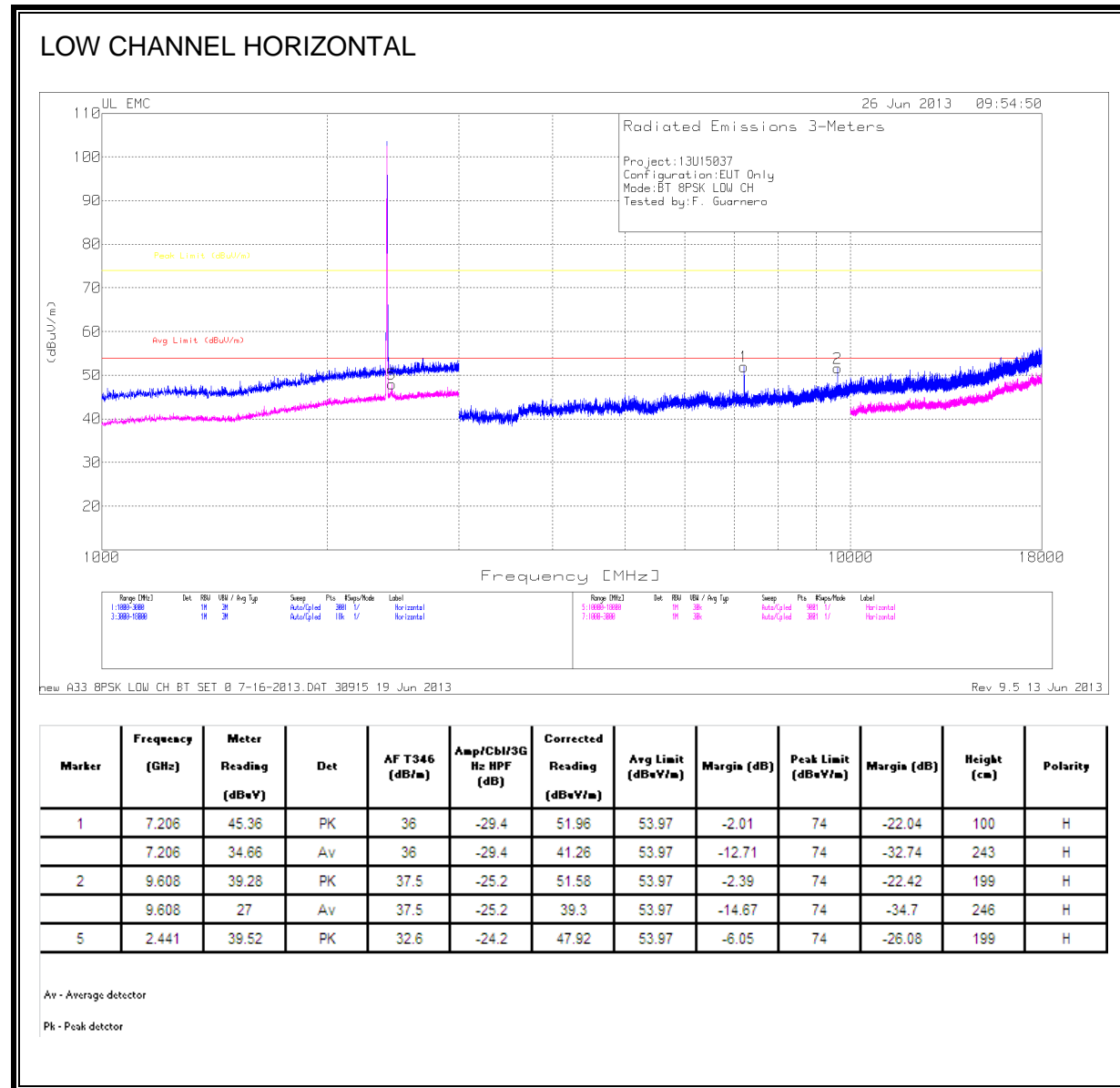

LOW CHANNEL VERTICAL

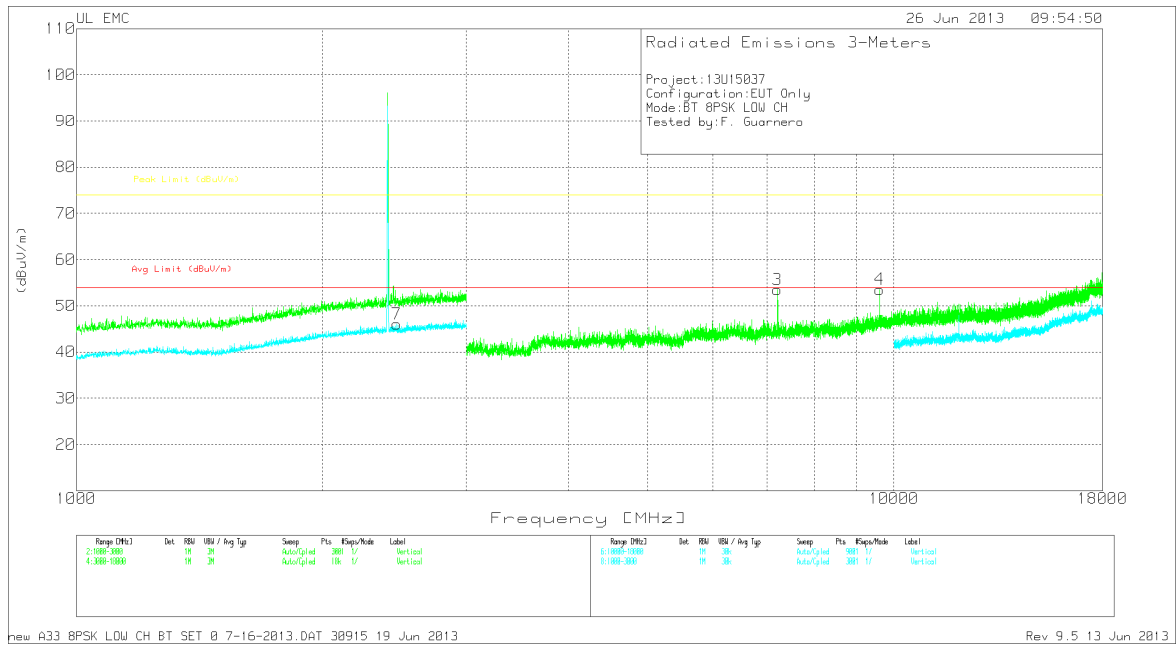

Marker	Frequency (GHz)	Meter Reading (dBuV)	Det	AF T346 (dB/m)	Amp/Cb/3G Hz HPF (dB)	Corrected Reading (dBuV/m)	Avg Limit (dBuV/m)	Margin (dB)	Peak Limit (dBuV/m)	Margin (dB)	Height (cm)	Polarity
3	7.206	46.89	PK	36	-29.4	53.49	53.97	-0.48	74	-20.51	100	V
	7.206	39.83	Av	36	-29.4	46.43	53.97	-7.54	74	-27.57	323	V
4	9.608	41.26	PK	37.5	-25.2	53.56	53.97	-0.41	74	-20.44	199	V
	9.608	31.81	Av	37.5	-25.2	44.11	53.97	-9.86	74	-29.89	150	V
7	2.441	37.08	PK	32.6	-24.2	45.48	53.97	-8.49	74	-28.52	199	V

Av - Average detector
 Pk - Peak detector

MID CHANNEL HORIZONTAL

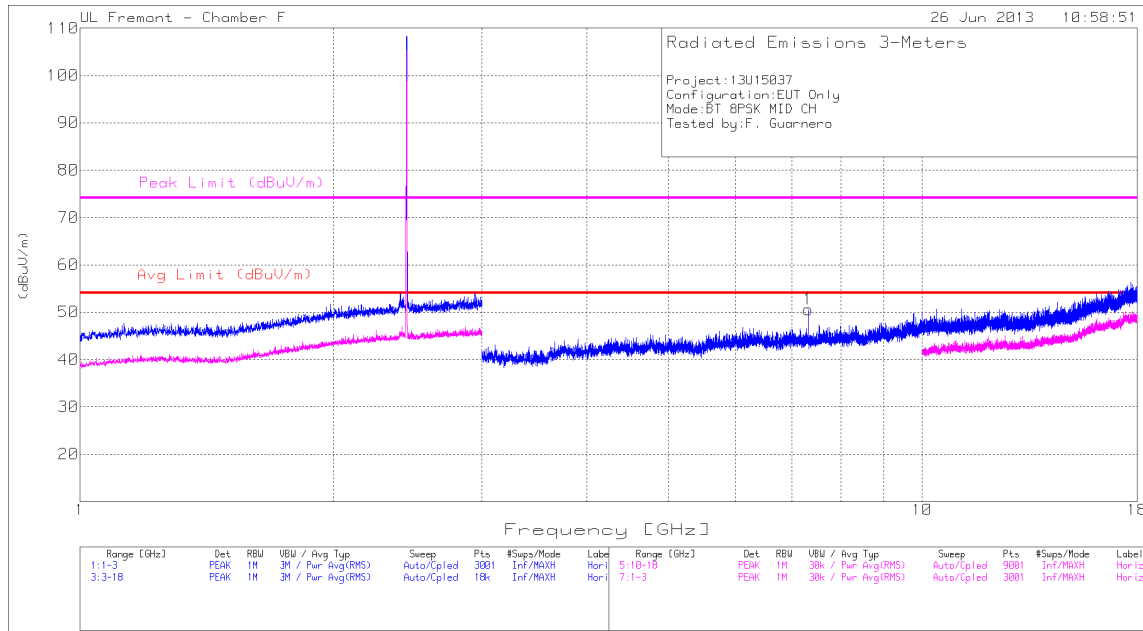

R33 mid 8PSK SET 0.DAT 30915 28 Jun 2013

Rev 9.5 12 Jun 201

Marker	Frequency (GHz)	Meter Reading (dBuV)	Det	AF T346 (dB/m)	Amp/Cbl/3 GHz HPF (dB)	Corrected Reading (dBuV/m)	Avg Limit (dBuV/m)	Margin (dB)	Peak Limit (dBuV/m)	Margin (dB)	Azimuth (Degs)	Height (cm)	Polarity
1	7.323	42.97	PK	36	-28.4	50.57	53.97	-3.4	74	-23.43	0-360	199	H
	7.323	29.07	Av	36	-28.4	36.67	53.97	-17.3	74	-37.33	96	123	H

Av - average detection
 PK - Peak detector

MID CHANNEL VERTICAL

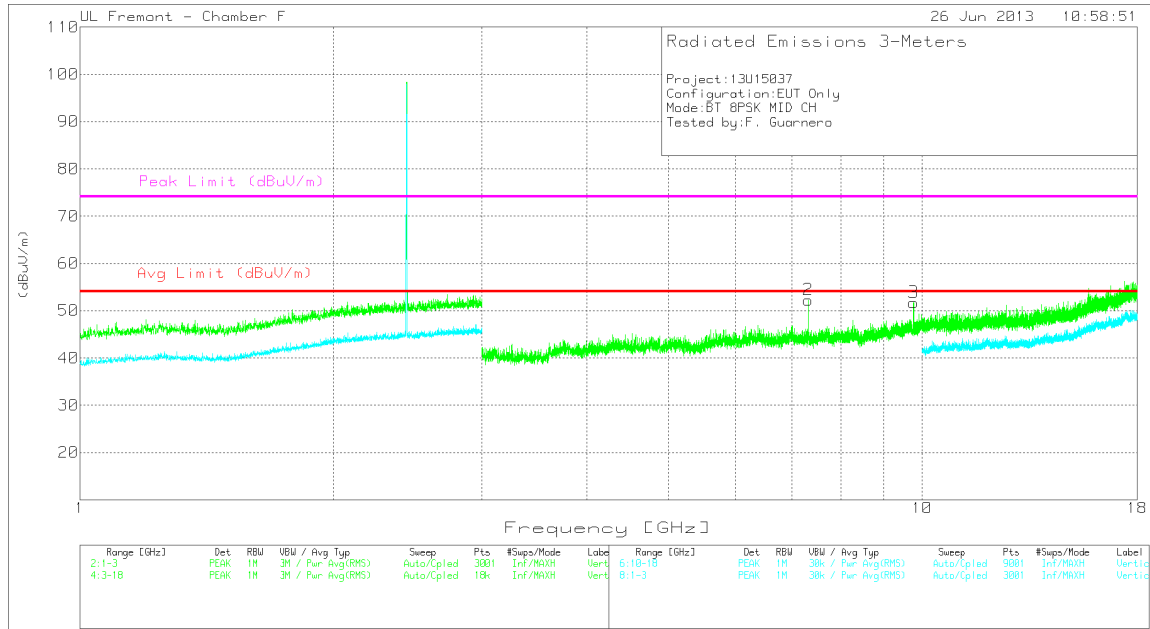

R33 mid 8PSK SET 0.DAT 30915 28 Jun 2013

Rev 9.5 12 Jun 2013

Marker	Frequency (GHz)	Meter Reading (dBuV)	Det	AF T346 (dB/m)	Amp/Cbl/3 GHz HPF (dB)	Corrected Reading (dBuV/m)	Avg Limit (dBuV/m)	Margin (dB)	Peak Limit (dBuV/m)	Margin (dB)	Azimuth (Degs)	Height (cm)	Polarity
2	7.324	44.68	PK	36	-28.4	52.28	53.97	-1.69	74	-21.72	0-360	199	V
	7.323	33.97	Av	36	-28.4	41.57	53.97	-12.4	74	-32.43	112	140	V
3	9.765	39.98	PK	37.6	-25.9	51.68	53.97	-2.29	74	-22.32	0-360	199	V
	9.764	26.37	Av	37.6	-25.9	38.07	53.97	-15.9	74	-35.93	156	307	V

Av - average detection
 PK - Peak detector

HIGH CHANNEL HORIZONTAL

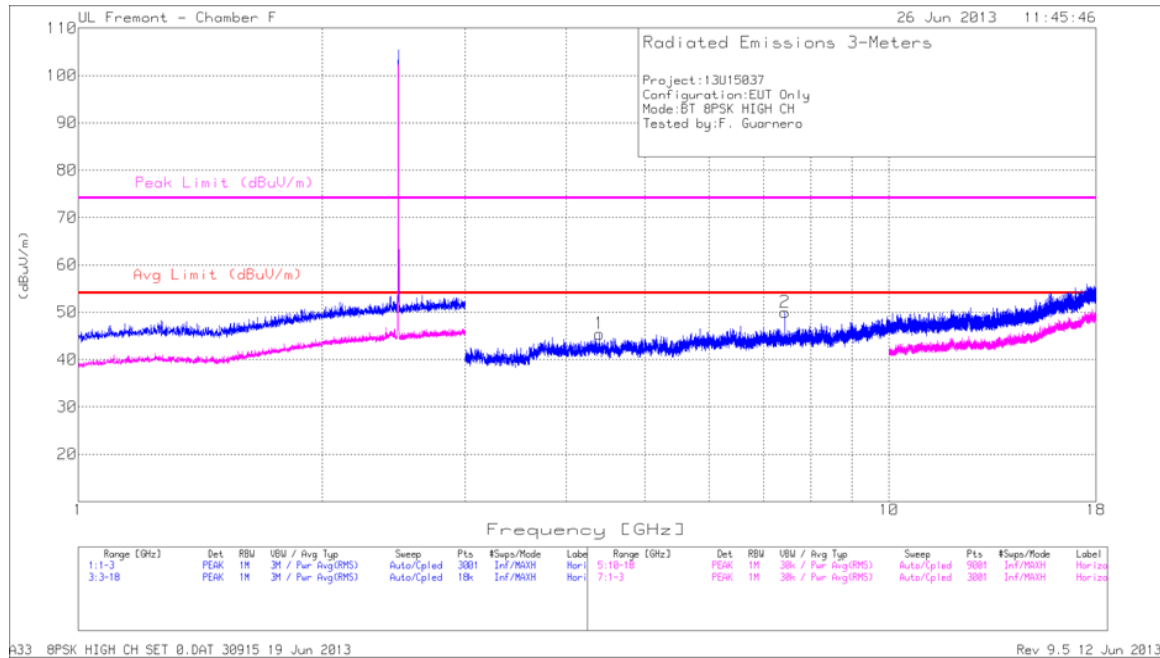

Marker	Frequency (GHz)	Meter Reading (dBuV)	Det	AF T346 (dB/m)	Amp/Cbl/3 GHz HPF (dB)	Corrected Reading (dBuV/m)	Avg Limit (dBuV/m)	Margin (dB)	Peak Limit (dBuV/m)	Margin (dB)	Azimuth (Degs)	Height (cm)	Polarity
1	4.393	42.52	PK	34.2	-31.3	45.42	53.97	-8.55	74	-28.58	0-360	101	H
2	7.441	43.09	PK	36.1	-29.2	49.99	53.97	-3.98	74	-24.01	0-360	199	H
	7.44	33.59	Av	36.1	-29.2	40.49	53.97	-13.48	74	-35.55	23	333	H

Av - average detection
 PK - Peak detector

HIGH CHANNEL VERTICAL

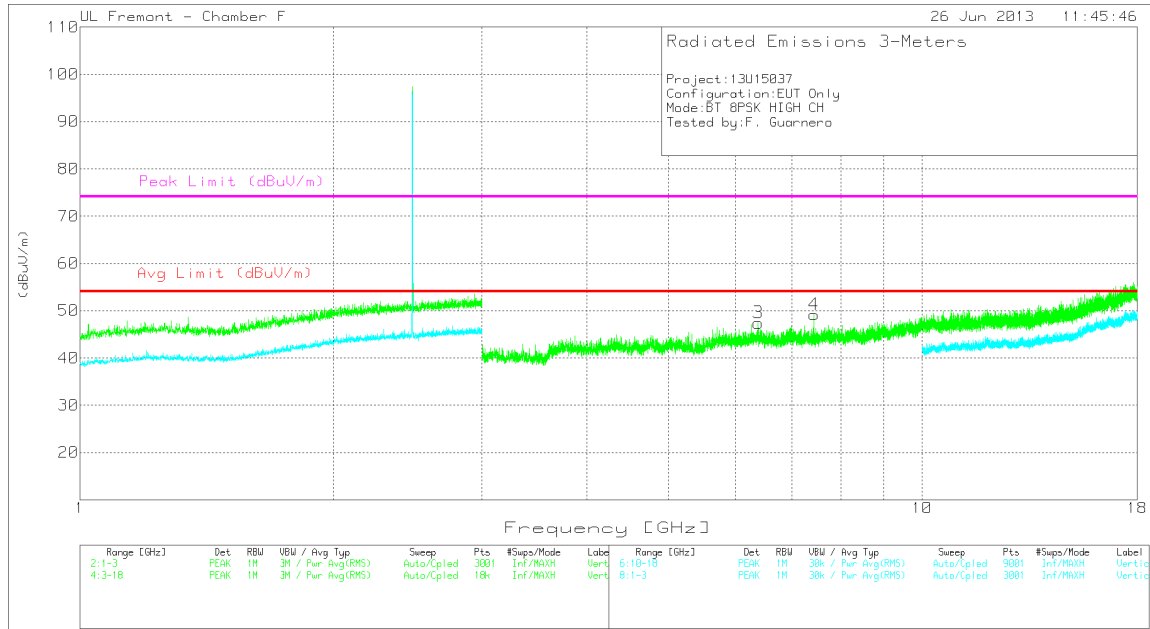

R33 BPSK HIGH CH SET 0.DAT 30915 19 Jun 2013

Rev 9.5 12 Jun 2013

Marker	Frequency (GHz)	Meter Reading (dBuV)	Det	AF T346 (dB/m)	Amp/Cbl/3 GHz HPF (dB)	Corrected Reading (dBuV/m)	Avg Limit (dBuV/m)	Margin (dB)	Peak Limit (dBuV/m)	Margin (dB)	Azimuth (Degs)	Height (cm)	Polarity
3	6.386	40.6	PK	35.8	-29	47.4	53.97	-6.57	74	-26.6	0-360	100	V
4	7.441	42.26	PK	36.1	-29.2	49.16	53.97	-4.81	74	-24.84	0-360	100	V
	7.44	34.45	Av	36.1	-29.2	41.35	53.97	-12.62	74	-35.01	46	195	V

Av - average detection
 PK - Peak detector

8.3. WORST-CASE BELOW 1 GHz

SPURIOUS EMISSIONS 30 TO 1000 MHz (WORST-CASE CONFIGURATION, HORIZONTAL)

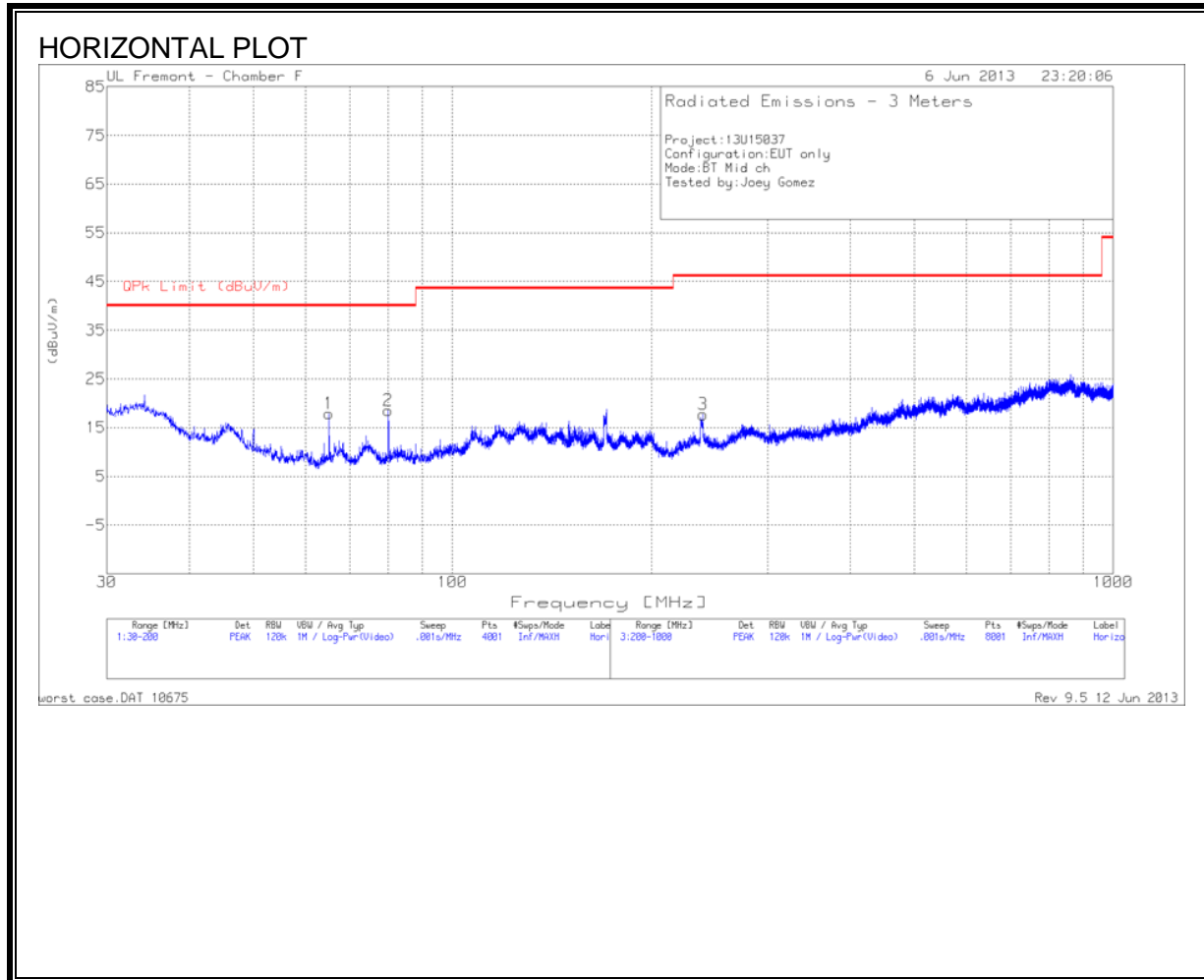

SPURIOUS EMISSIONS 30 TO 1000 MHz (WORST-CASE CONFIGURATION, VERTICAL)

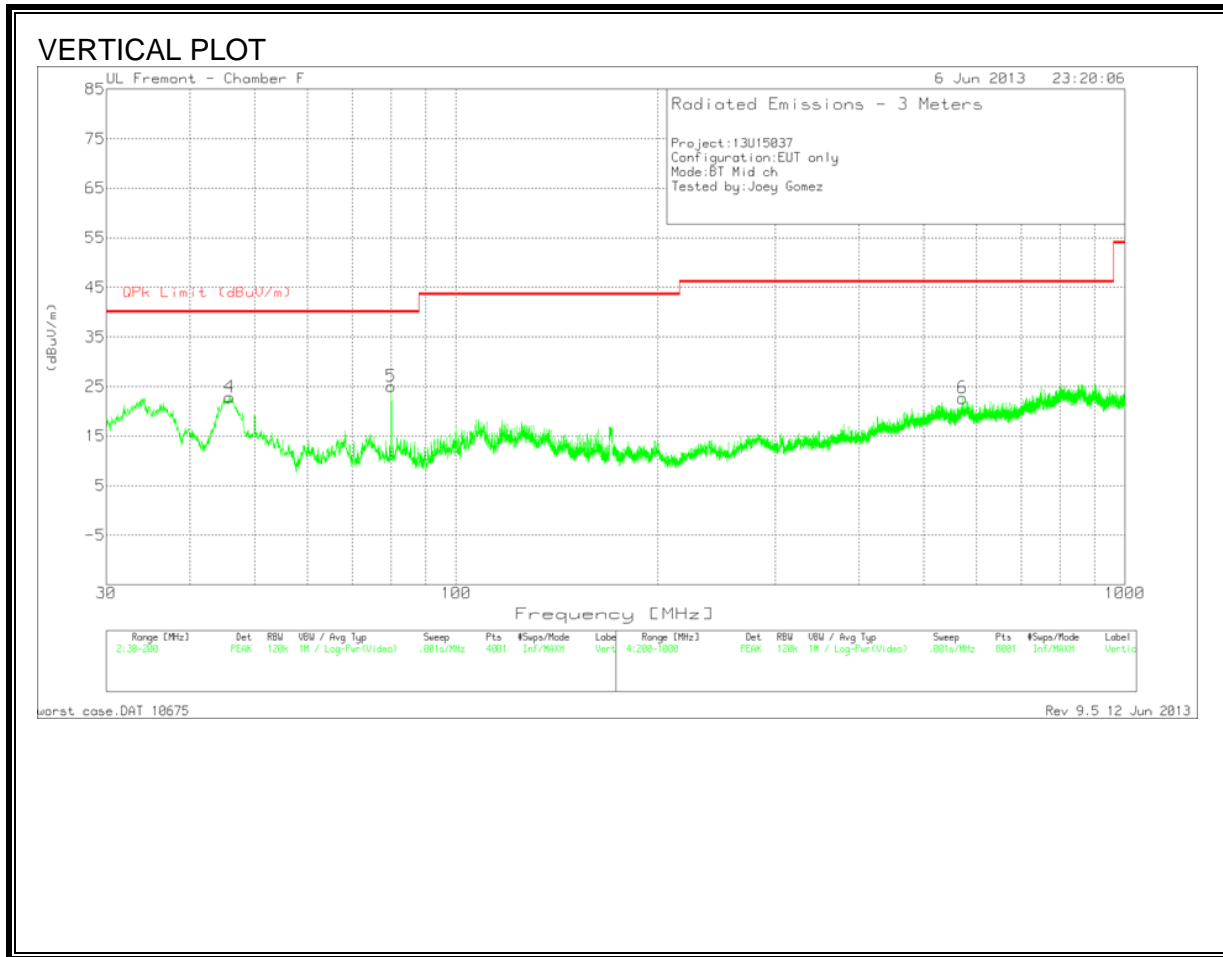

HORIZONTAL AND VERTICAL DATA

Marker	Frequency (MHz)	Meter Reading (dBuV)	Det	AF T408 (dB/m)	Amp/Cb l (dB)	Corrected Reading (dBuV/m)	QPk Limit (dBuV/m)	Margin (dB)	Azimuth (Degs)	Height (cm)	Polarity
1	65.0625	38.01	PK	8	-28.1	17.91	40	-22.09	0-360	400	H
2	79.98	38.52	PK	7.7	-27.7	18.52	40	-21.48	0-360	400	H
3	239.6	32.51	PK	11.5	-26.3	17.71	46.02	-28.31	0-360	99	H
4	45.8525	40.34	PK	10	-27.5	22.84	40	-17.16	0-360	100	V
5	79.98	45.01	PK	7.7	-27.7	25.01	40	-14.99	0-360	100	V
6	571.6	29.86	PK	18.8	-26	22.66	46.02	-23.36	0-360	200	V

9. AC POWER LINE CONDUCTED EMISSIONS

LIMITS

FCC §15.207 (a)

RSS-Gen 7.2.2

Frequency of Emission (MHz)	Conducted Limit (dBuV)	
	Quasi-peak	Average
0.15-0.5	66 to 56*	56 to 46*
0.5-5	56	46
5-30	60	50

*Decreases with the logarithm of the frequency.

TEST PROCEDURE

The EUT is placed on a non-conducting table 40 cm from the vertical ground plane and 80 cm above the horizontal ground plane. The EUT is configured in accordance with ANSI C63.4.

The receiver is set to a resolution bandwidth of 9 kHz. Peak detection is used unless otherwise noted as quasi-peak or average.

Line conducted data is recorded for both NEUTRAL and HOT lines.

RESULTS

6 WORST EMISSIONS

Project No:13U15037
 Client Name:
 Model/Device:BT Worst Case
 Test Volt/Freq:115 VAC/ 60Hz
 Test By:Mona Hua

Line-L1 .15 - 30MHz

Test Frequency (MHz)	Meter Reading (dBuV)	Detector	T24 IL L1 (dB)	LC Cables 1&3 (dB)	dB(uVolts)	CISPR 11/22 Class B Quasi-peak	Margin	CISPR 11/22 Class B Average	Margin
0.159	49.08	PK	0.1	0	49.18	65.5	-16.32	-	-
0.159	35.1	Av	0.1	0	35.2	-	-	55.5	-20.3
0.7305	45.56	PK	0.1	0	45.66	56	-10.34	-	-
0.7305	30.85	Av	0.1	0	30.95	-	-	46	-15.05
0.8205	45.82	PK	0.1	0	45.92	56	-10.08	-	-
0.8205	26.99	Av	0.1	0	27.09	-	-	46	-18.91
4.8615	40.63	PK	0.1	0.1	40.83	56	-15.17	-	-
4.8615	23.5	Av	0.1	0.1	23.7	-	-	46	-22.3
17.6775	39.17	PK	0.2	0.2	39.57	60	-20.43	-	-
17.6775	23.96	Av	0.2	0.2	24.36	-	-	50	-25.64

Line-L2 .15 - 30MHz

Test Frequency (MHz)	Meter Reading (dBuV)	Detector	T24 IL L1 (dB)	LC Cables 1&3 (dB)	dB(uVolts)	CISPR 11/22 Class B Quasi-peak	Margin	CISPR 11/22 Class B Average	Margin
0.1635	48.71	PK	0.1	0	48.81	65.3	-16.49	-	-
0.1635	29.35	Av	0.1	0	29.45	-	-	55.3	-25.85
0.8025	46.5	PK	0.1	0	46.6	56	-9.4	-	-
0.8025	25.07	Av	0.1	0	25.17	-	-	46	-20.83
6.2205	39.14	PK	0.1	0.1	39.34	60	-20.66	-	-
6.2205	23.27	Av	0.1	0.1	23.47	-	-	50	-26.53
17.8575	39.86	PK	0.2	0.2	40.26	60	-19.74	-	-
17.8575	17.83	Av	0.2	0.2	18.23	-	-	50	-31.77

PK - Peak detector
 Av - Average detector

LINE 1 RESULTS

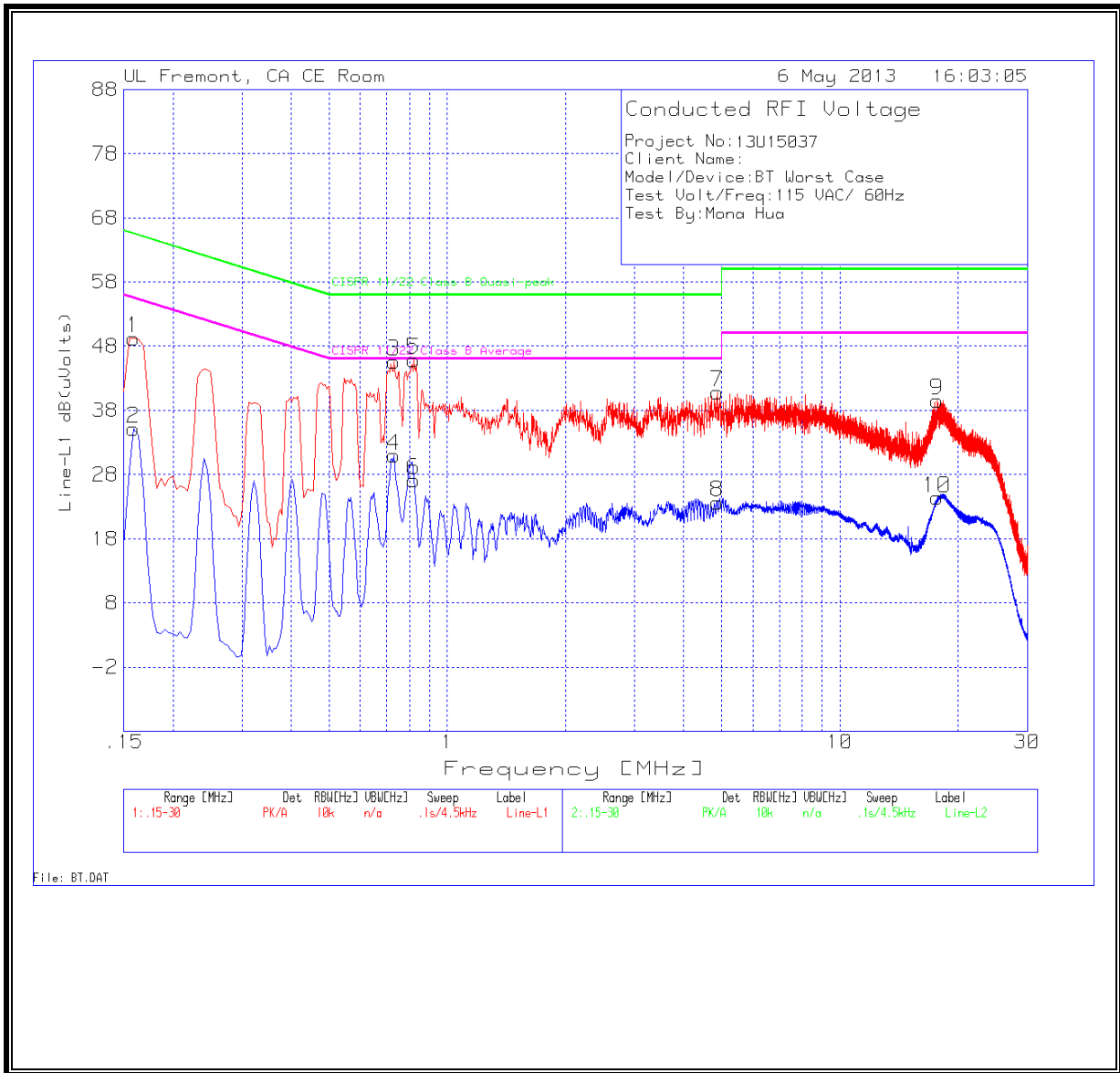

LINE 2 RESULTS

