



Accredited by the Swiss Accreditation Service (SAS)
The Swiss Accreditation Service is one of the signatories to the EA
Multilateral Agreement for the recognition of calibration certificates

Accreditation No.: **SCS 108**

Client **UL CCS USA**

Certificate No: **EX3-3749_Jan13**

CALIBRATION CERTIFICATE

Object **EX3DV4 - SN:3749**

Calibration procedure(s) **QA CAL-01.v8, QA CAL-14.v3, QA CAL-23.v4, QA CAL-25.v4
Calibration procedure for dosimetric E-field probes**

Calibration date: **January 15, 2013**

This calibration certificate documents the traceability to national standards, which realize the physical units of measurements (SI).
The measurements and the uncertainties with confidence probability are given on the following pages and are part of the certificate.

All calibrations have been conducted in the closed laboratory facility: environment temperature (22 ± 3)°C and humidity < 70%.

Calibration Equipment used (M&TE critical for calibration)

Primary Standards	ID	Cal Date (Certificate No.)	Scheduled Calibration
Power meter E4419B	GB41293874	29-Mar-12 (No. 217-01508)	Apr-13
Power sensor E4412A	MY41498087	29-Mar-12 (No. 217-01508)	Apr-13
Reference 3 dB Attenuator	SN: S5054 (3c)	27-Mar-12 (No. 217-01531)	Apr-13
Reference 20 dB Attenuator	SN: S5086 (20b)	27-Mar-12 (No. 217-01529)	Apr-13
Reference 30 dB Attenuator	SN: S5129 (30b)	27-Mar-12 (No. 217-01532)	Apr-13
Reference Probe ES3DV2	SN: 3013	28-Dec-12 (No. ES3-3013_Dec12)	Dec-13
DAE4	SN: 660	20-Jun-12 (No. DAE4-660_Jun12)	Jun-13
Secondary Standards	ID	Check Date (in house)	Scheduled Check
RF generator HP 8648C	US3642U01700	4-Aug-99 (in house check Apr-11)	In house check: Apr-13
Network Analyzer HP 8753E	US37390585	18-Oct-01 (in house check Oct-12)	In house check: Oct-13

	Name	Function	Signature
Calibrated by:	Jeton Kastrati	Laboratory Technician	
Approved by:	Katja Pokovic	Technical Manager	

Issued: January 15, 2013

This calibration certificate shall not be reproduced except in full without written approval of the laboratory.



Accredited by the Swiss Accreditation Service (SAS)

Accreditation No.: **SCS 108**

The Swiss Accreditation Service is one of the signatories to the EA Multilateral Agreement for the recognition of calibration certificates

Glossary:

TSL	tissue simulating liquid
NORM _{x,y,z}	sensitivity in free space
ConvF	sensitivity in TSL / NORM _{x,y,z}
DCP	diode compression point
CF	crest factor (1/duty_cycle) of the RF signal
A, B, C, D	modulation dependent linearization parameters
Polarization φ	φ rotation around probe axis
Polarization ϑ	ϑ rotation around an axis that is in the plane normal to probe axis (at measurement center), i.e., $\vartheta = 0$ is normal to probe axis

Calibration is Performed According to the Following Standards:

- IEEE Std 1528-2003, "IEEE Recommended Practice for Determining the Peak Spatial-Averaged Specific Absorption Rate (SAR) in the Human Head from Wireless Communications Devices: Measurement Techniques", December 2003
- IEC 62209-1, "Procedure to measure the Specific Absorption Rate (SAR) for hand-held devices used in close proximity to the ear (frequency range of 300 MHz to 3 GHz)", February 2005

Methods Applied and Interpretation of Parameters:

- NORM_{x,y,z}**: Assessed for E-field polarization $\vartheta = 0$ ($f \leq 900$ MHz in TEM-cell; $f > 1800$ MHz: R22 waveguide). NORM_{x,y,z} are only intermediate values, i.e., the uncertainties of NORM_{x,y,z} does not affect the E²-field uncertainty inside TSL (see below ConvF).
- NORM(f)_{x,y,z}** = NORM_{x,y,z} * frequency_response (see Frequency Response Chart). This linearization is implemented in DASY4 software versions later than 4.2. The uncertainty of the frequency response is included in the stated uncertainty of ConvF.
- DCP_{x,y,z}**: DCP are numerical linearization parameters assessed based on the data of power sweep with CW signal (no uncertainty required). DCP does not depend on frequency nor media.
- PAR**: PAR is the Peak to Average Ratio that is not calibrated but determined based on the signal characteristics
- A_{x,y,z}; B_{x,y,z}; C_{x,y,z}; D_{x,y,z}; VR_{x,y,z}**: A, B, C, D are numerical linearization parameters assessed based on the data of power sweep for specific modulation signal. The parameters do not depend on frequency nor media. VR is the maximum calibration range expressed in RMS voltage across the diode.
- ConvF and Boundary Effect Parameters**: Assessed in flat phantom using E-field (or Temperature Transfer Standard for $f \leq 800$ MHz) and inside waveguide using analytical field distributions based on power measurements for $f > 800$ MHz. The same setups are used for assessment of the parameters applied for boundary compensation (alpha, depth) of which typical uncertainty values are given. These parameters are used in DASY4 software to improve probe accuracy close to the boundary. The sensitivity in TSL corresponds to NORM_{x,y,z} * ConvF whereby the uncertainty corresponds to that given for ConvF. A frequency dependent ConvF is used in DASY version 4.4 and higher which allows extending the validity from ± 50 MHz to ± 100 MHz.
- Spherical isotropy (3D deviation from isotropy)**: in a field of low gradients realized using a flat phantom exposed by a patch antenna.
- Sensor Offset**: The sensor offset corresponds to the offset of virtual measurement center from the probe tip (on probe axis). No tolerance required.

Probe EX3DV4

SN:3749

Manufactured: March 26, 2010
Calibrated: January 15, 2013

Calibrated for DASY/EASY Systems
(Note: non-compatible with DASY2 system!)

DASY/EASY - Parameters of Probe: EX3DV4 - SN:3749

Basic Calibration Parameters

	Sensor X	Sensor Y	Sensor Z	Unc (k=2)
Norm ($\mu\text{V}/(\text{V}/\text{m})^2$) ^A	0.49	0.46	0.42	$\pm 10.1 \%$
DCP (mV) ^B	102.5	106.4	101.3	

Modulation Calibration Parameters

UID	Communication System Name		A dB	B dB $\sqrt{\mu\text{V}}$	C	D dB	VR mV	Unc ^E (k=2)
0	CW	X	0.0	0.0	1.0	0.00	167.4	$\pm 3.5 \%$
		Y	0.0	0.0	1.0		160.4	
		Z	0.0	0.0	1.0		147.7	

The reported uncertainty of measurement is stated as the standard uncertainty of measurement multiplied by the coverage factor $k=2$, which for a normal distribution corresponds to a coverage probability of approximately 95%.

^A The uncertainties of NormX,Y,Z do not affect the E^2 -field uncertainty inside TSL (see Pages 5 and 6).

^B Numerical linearization parameter: uncertainty not required.

^E Uncertainty is determined using the max. deviation from linear response applying rectangular distribution and is expressed for the square of the field value.

DASY/EASY - Parameters of Probe: EX3DV4 - SN:3749

Calibration Parameter Determined in Head Tissue Simulating Media

f (MHz) ^C	Relative Permittivity ^F	Conductivity (S/m) ^F	ConvF X	ConvF Y	ConvF Z	Alpha	Depth (mm)	Unct. (k=2)
750	41.9	0.89	9.09	9.09	9.09	0.25	1.25	± 12.0 %
835	41.5	0.90	8.78	8.78	8.78	0.67	0.65	± 12.0 %
900	41.5	0.97	8.84	8.84	8.84	0.17	1.48	± 12.0 %
1750	40.1	1.37	7.71	7.71	7.71	0.63	0.72	± 12.0 %
1900	40.0	1.40	7.34	7.34	7.34	0.67	0.73	± 12.0 %
1950	40.0	1.40	7.01	7.01	7.01	0.51	0.78	± 12.0 %
2000	40.0	1.40	7.16	7.16	7.16	0.67	0.73	± 12.0 %
2450	39.2	1.80	6.44	6.44	6.44	0.37	1.02	± 12.0 %
2600	39.0	1.96	6.31	6.31	6.31	0.40	1.02	± 12.0 %
5200	36.0	4.66	4.70	4.70	4.70	0.35	1.80	± 13.1 %
5300	35.9	4.76	4.48	4.48	4.48	0.35	1.80	± 13.1 %
5500	35.6	4.96	4.21	4.21	4.21	0.40	1.80	± 13.1 %
5600	35.5	5.07	3.96	3.96	3.96	0.45	1.80	± 13.1 %
5800	35.3	5.27	4.33	4.33	4.33	0.40	1.80	± 13.1 %

^C Frequency validity of ± 100 MHz only applies for DASY v4.4 and higher (see Page 2), else it is restricted to ± 50 MHz. The uncertainty is the RSS of the ConvF uncertainty at calibration frequency and the uncertainty for the indicated frequency band.

^F At frequencies below 3 GHz, the validity of tissue parameters (ϵ and σ) can be relaxed to ± 10% if liquid compensation formula is applied to measured SAR values. At frequencies above 3 GHz, the validity of tissue parameters (ϵ and σ) is restricted to ± 5%. The uncertainty is the RSS of the ConvF uncertainty for indicated target tissue parameters.

DASY/EASY - Parameters of Probe: EX3DV4 - SN:3749

Calibration Parameter Determined in Body Tissue Simulating Media

f (MHz) ^C	Relative Permittivity ^F	Conductivity (S/m) ^F	ConvF X	ConvF Y	ConvF Z	Alpha	Depth (mm)	Unct. (k=2)
750	55.5	0.96	8.78	8.78	8.78	0.34	1.04	± 12.0 %
835	55.2	0.97	8.67	8.67	8.67	0.71	0.67	± 12.0 %
900	55.0	1.05	8.62	8.62	8.62	0.53	0.77	± 12.0 %
1750	53.4	1.49	7.36	7.36	7.36	0.68	0.67	± 12.0 %
1900	53.3	1.52	6.99	6.99	6.99	0.36	0.99	± 12.0 %
1950	53.3	1.52	7.09	7.09	7.09	0.51	0.78	± 12.0 %
2000	53.3	1.52	7.02	7.02	7.02	0.49	0.79	± 12.0 %
2450	52.7	1.95	6.62	6.62	6.62	0.66	0.64	± 12.0 %
2600	52.5	2.16	6.37	6.37	6.37	0.80	0.56	± 12.0 %
5200	49.0	5.30	4.32	4.32	4.32	0.50	1.90	± 13.1 %
5300	48.9	5.42	4.07	4.07	4.07	0.55	1.90	± 13.1 %
5500	48.6	5.65	3.84	3.84	3.84	0.55	1.90	± 13.1 %
5600	48.5	5.77	3.58	3.58	3.58	0.60	1.90	± 13.1 %
5800	48.2	6.00	3.97	3.97	3.97	0.55	1.90	± 13.1 %

^C Frequency validity of ± 100 MHz only applies for DASY v4.4 and higher (see Page 2), else it is restricted to ± 50 MHz. The uncertainty is the RSS of the ConvF uncertainty at calibration frequency and the uncertainty for the indicated frequency band.

^F At frequencies below 3 GHz, the validity of tissue parameters (ϵ and σ) can be relaxed to ± 10% if liquid compensation formula is applied to measured SAR values. At frequencies above 3 GHz, the validity of tissue parameters (ϵ and σ) is restricted to ± 5%. The uncertainty is the RSS of the ConvF uncertainty for indicated target tissue parameters.

Frequency Response of E-Field

(TEM-Cell:ifi110 EXX, Waveguide: R22)

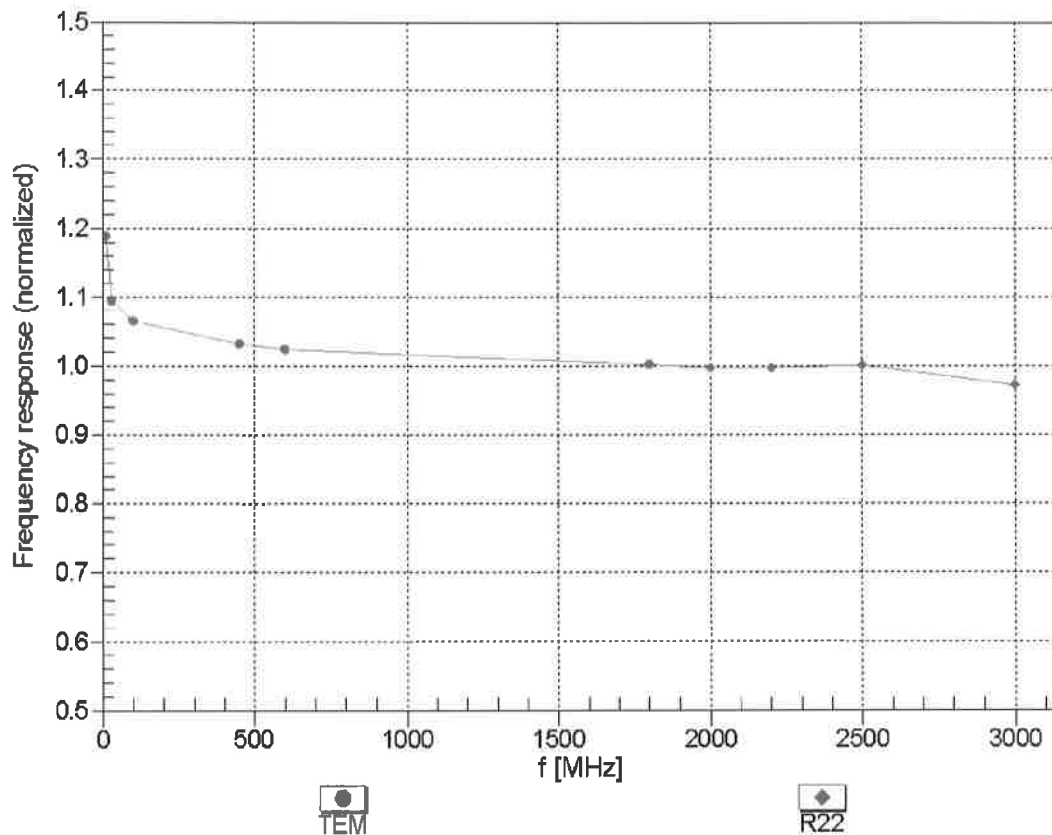

Uncertainty of Frequency Response of E-field: $\pm 6.3\%$ (k=2)

Receiving Pattern (ϕ), $\theta = 0^\circ$

f=600 MHz, TEM

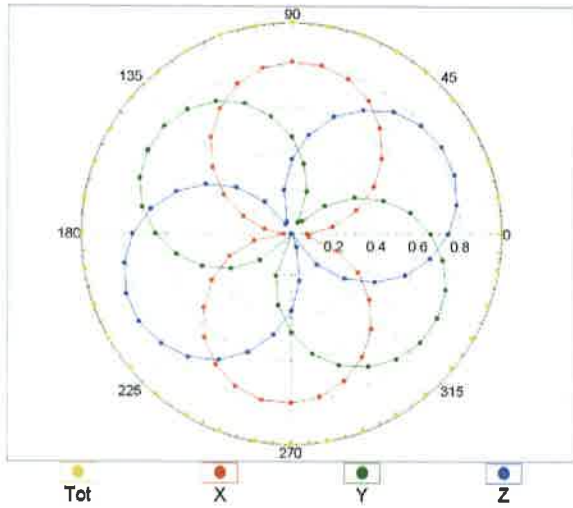

f=1800 MHz, R22

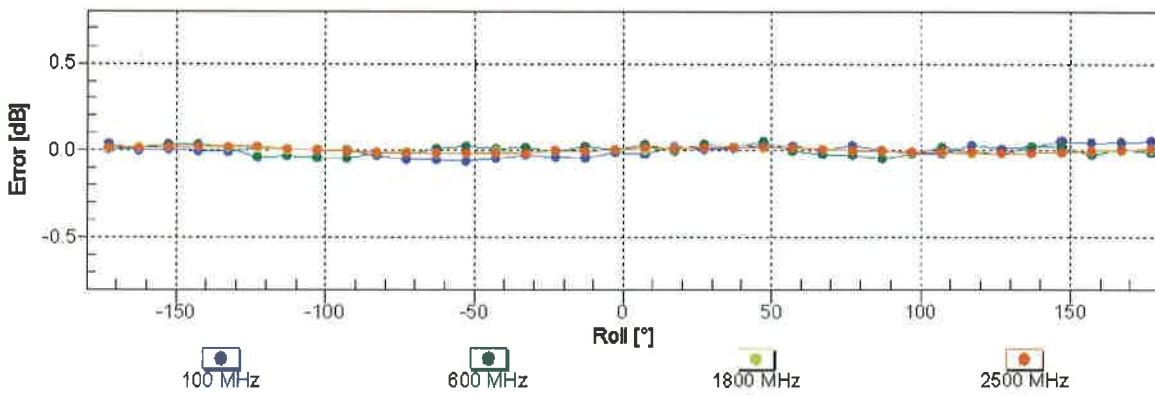
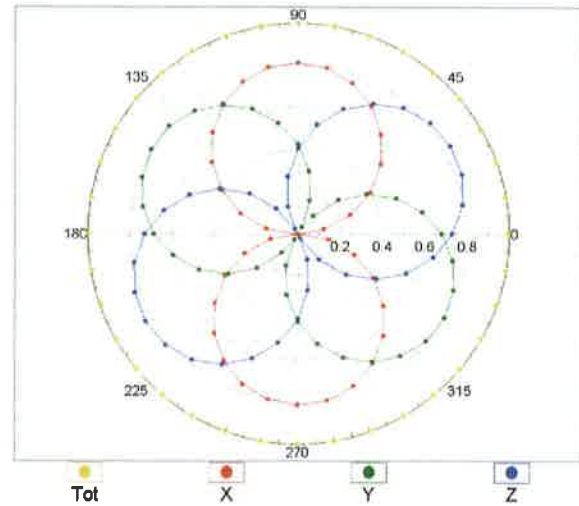

Uncertainty of Axial Isotropy Assessment: $\pm 0.5\%$ (k=2)

Dynamic Range $f(SAR_{head})$ (TEM cell , $f = 900$ MHz)

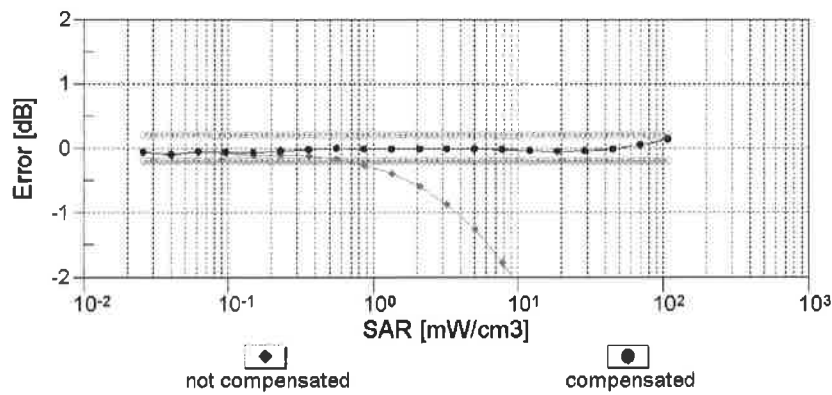
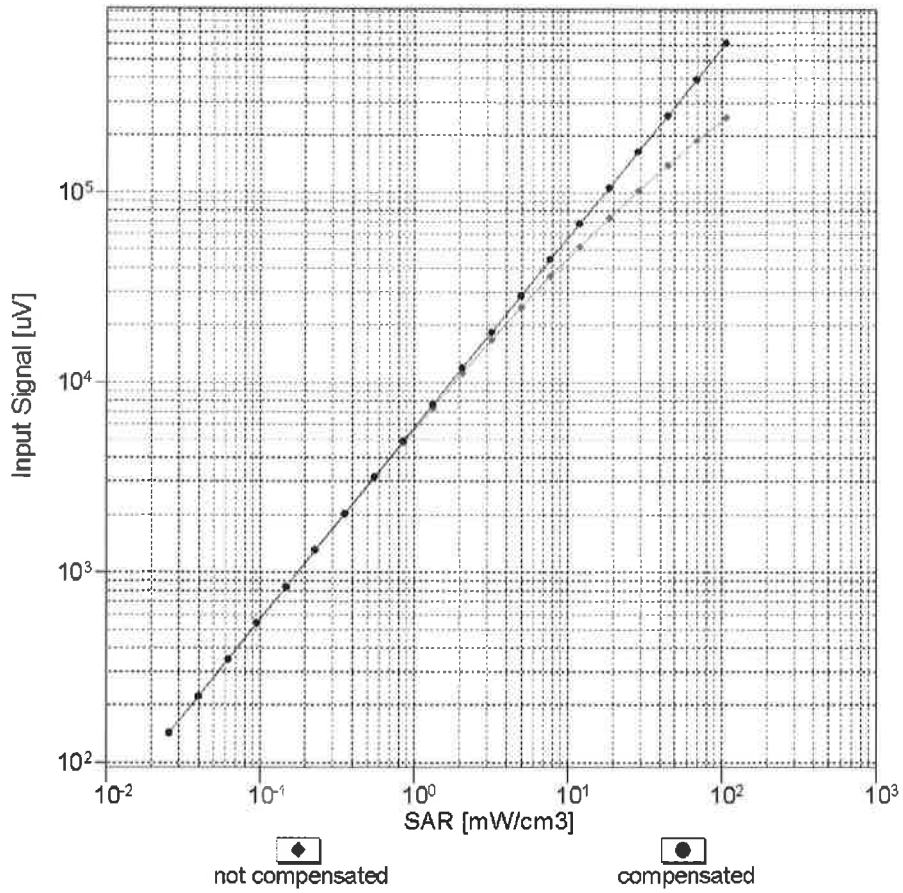

Uncertainty of Linearity Assessment: $\pm 0.6\%$ ($k=2$)

Conversion Factor Assessment

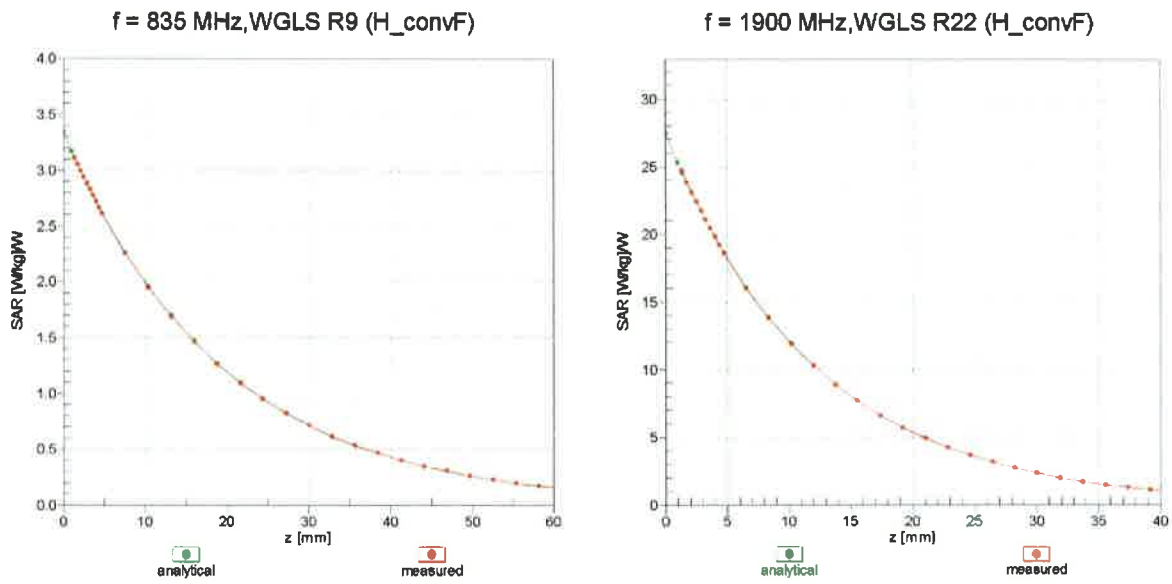

Deviation from Isotropy in Liquid Error (ϕ, ϑ), f = 900 MHz

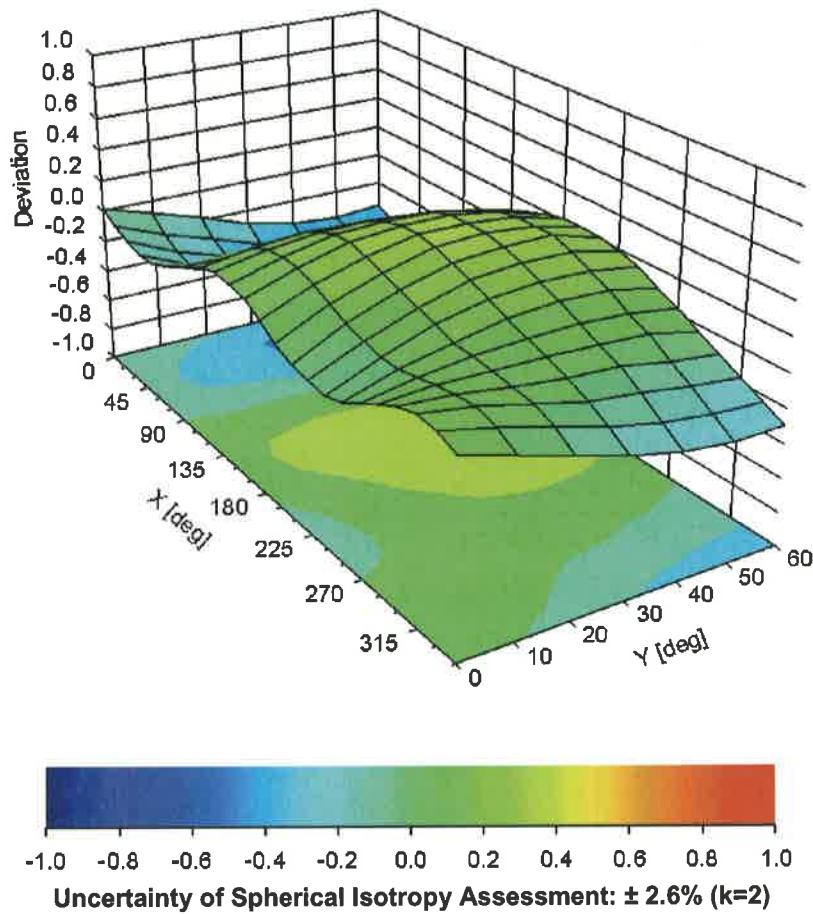

DASY/EASY - Parameters of Probe: EX3DV4 - SN:3749

Other Probe Parameters

Sensor Arrangement	Triangular
Connector Angle (°)	-62.8
Mechanical Surface Detection Mode	enabled
Optical Surface Detection Mode	disabled
Probe Overall Length	337 mm
Probe Body Diameter	10 mm
Tip Length	9 mm
Tip Diameter	2.5 mm
Probe Tip to Sensor X Calibration Point	1 mm
Probe Tip to Sensor Y Calibration Point	1 mm
Probe Tip to Sensor Z Calibration Point	1 mm
Recommended Measurement Distance from Surface	2 mm



Accredited by the Swiss Accreditation Service (SAS)
The Swiss Accreditation Service is one of the signatories to the EA
Multilateral Agreement for the recognition of calibration certificates

Accreditation No.: **SCS 108**

Client **UL CCS USA**

Certificate No: **EX3-3751_Nov12**

CALIBRATION CERTIFICATE

Object **EX3DV4 - SN:3751**

Calibration procedure(s) **QA CAL-01.v8, QA CAL-14.v3, QA CAL-23.v4, QA CAL-25.v4
Calibration procedure for dosimetric E-field probes**

Calibration date: **November 15, 2012**

This calibration certificate documents the traceability to national standards, which realize the physical units of measurements (SI).
The measurements and the uncertainties with confidence probability are given on the following pages and are part of the certificate.

All calibrations have been conducted in the closed laboratory facility: environment temperature (22 ± 3)°C and humidity < 70%.

Calibration Equipment used (M&TE critical for calibration)

Primary Standards	ID	Cal Date (Certificate No.)	Scheduled Calibration
Power meter E4419B	GB41293874	29-Mar-12 (No. 217-01508)	Apr-13
Power sensor E4412A	MY41498087	29-Mar-12 (No. 217-01508)	Apr-13
Reference 3 dB Attenuator	SN: S5054 (3c)	27-Mar-12 (No. 217-01531)	Apr-13
Reference 20 dB Attenuator	SN: S5086 (20b)	27-Mar-12 (No. 217-01529)	Apr-13
Reference 30 dB Attenuator	SN: S5129 (30b)	27-Mar-12 (No. 217-01532)	Apr-13
Reference Probe ES3DV2	SN: 3013	29-Dec-11 (No. ES3-3013_Dec11)	Dec-12
DAE4	SN: 660	20-Jun-12 (No. DAE4-660_Jun12)	Jun-13
Secondary Standards	ID	Check Date (in house)	Scheduled Check
RF generator HP 8648C	US3642U01700	4-Aug-99 (in house check Apr-11)	In house check: Apr-13
Network Analyzer HP 8753E	US37390585	18-Oct-01 (in house check Oct-12)	In house check: Oct-13

	Name	Function	Signature
Calibrated by:	Claudio Leubler	Laboratory Technician	
Approved by:	Katja Pokovic	Technical Manager	

Issued: November 15, 2012

This calibration certificate shall not be reproduced except in full without written approval of the laboratory.



Accredited by the Swiss Accreditation Service (SAS)

Accreditation No.: **SCS 108**

The Swiss Accreditation Service is one of the signatories to the EA Multilateral Agreement for the recognition of calibration certificates

Glossary:

TSL	tissue simulating liquid
NORM _{x,y,z}	sensitivity in free space
ConvF	sensitivity in TSL / NORM _{x,y,z}
DCP	diode compression point
CF	crest factor (1/duty_cycle) of the RF signal
A, B, C	modulation dependent linearization parameters
Polarization ϕ	ϕ rotation around probe axis
Polarization ϑ	ϑ rotation around an axis that is in the plane normal to probe axis (at measurement center), i.e., $\vartheta = 0$ is normal to probe axis

Calibration is Performed According to the Following Standards:

- IEEE Std 1528-2003, "IEEE Recommended Practice for Determining the Peak Spatial-Averaged Specific Absorption Rate (SAR) in the Human Head from Wireless Communications Devices: Measurement Techniques", December 2003
- IEC 62209-1, "Procedure to measure the Specific Absorption Rate (SAR) for hand-held devices used in close proximity to the ear (frequency range of 300 MHz to 3 GHz)", February 2005

Methods Applied and Interpretation of Parameters:

- NORM_{x,y,z}**: Assessed for E-field polarization $\vartheta = 0$ ($f \leq 900$ MHz in TEM-cell; $f > 1800$ MHz: R22 waveguide). NORM_{x,y,z} are only intermediate values, i.e., the uncertainties of NORM_{x,y,z} does not affect the E²-field uncertainty inside TSL (see below *ConvF*).
- NORM(f)_{x,y,z}** = NORM_{x,y,z} * *frequency_response* (see Frequency Response Chart). This linearization is implemented in DASY4 software versions later than 4.2. The uncertainty of the frequency response is included in the stated uncertainty of *ConvF*.
- DCP_{x,y,z}**: DCP are numerical linearization parameters assessed based on the data of power sweep with CW signal (no uncertainty required). DCP does not depend on frequency nor media.
- PAR**: PAR is the Peak to Average Ratio that is not calibrated but determined based on the signal characteristics
- A_{x,y,z}; B_{x,y,z}; C_{x,y,z}; VR_{x,y,z}; A, B, C** are numerical linearization parameters assessed based on the data of power sweep for specific modulation signal. The parameters do not depend on frequency nor media. VR is the maximum calibration range expressed in RMS voltage across the diode.
- ConvF and Boundary Effect Parameters**: Assessed in flat phantom using E-field (or Temperature Transfer Standard for $f \leq 800$ MHz) and inside waveguide using analytical field distributions based on power measurements for $f > 800$ MHz. The same setups are used for assessment of the parameters applied for boundary compensation (alpha, depth) of which typical uncertainty values are given. These parameters are used in DASY4 software to improve probe accuracy close to the boundary. The sensitivity in TSL corresponds to NORM_{x,y,z} * *ConvF* whereby the uncertainty corresponds to that given for *ConvF*. A frequency dependent *ConvF* is used in DASY version 4.4 and higher which allows extending the validity from ± 50 MHz to ± 100 MHz.
- Spherical isotropy (3D deviation from isotropy)**: in a field of low gradients realized using a flat phantom exposed by a patch antenna.
- Sensor Offset**: The sensor offset corresponds to the offset of virtual measurement center from the probe tip (on probe axis). No tolerance required.

Probe EX3DV4

SN:3751

Manufactured: March 26, 2010
Calibrated: November 15, 2012

Calibrated for DASY/EASY Systems
(Note: non-compatible with DASY2 system!)

DASY/EASY - Parameters of Probe: EX3DV4 - SN:3751

Basic Calibration Parameters

	Sensor X	Sensor Y	Sensor Z	Unc (k=2)
Norm ($\mu\text{V}/(\text{V}/\text{m})^2$) ^A	0.51	0.53	0.52	$\pm 10.1 \%$
DCP (mV) ^B	99.3	101.4	99.9	

Modulation Calibration Parameters

UID	Communication System Name	PAR		A dB	B dB	C dB	VR mV	Unc ^E (k=2)
0	CW	0.00	X	0.0	0.0	1.0	121.1	$\pm 1.9 \%$
			Y	0.0	0.0	1.0	124.4	
			Z	0.0	0.0	1.0	119.1	

The reported uncertainty of measurement is stated as the standard uncertainty of measurement multiplied by the coverage factor $k=2$, which for a normal distribution corresponds to a coverage probability of approximately 95%.

^A The uncertainties of NormX,Y,Z do not affect the E^2 -field uncertainty inside TSL (see Pages 5 and 6).

^B Numerical linearization parameter: uncertainty not required.

^E Uncertainty is determined using the max. deviation from linear response applying rectangular distribution and is expressed for the square of the field value.

DASY/EASY - Parameters of Probe: EX3DV4 - SN:3751

Calibration Parameter Determined in Head Tissue Simulating Media

f (MHz) ^C	Relative Permittivity ^F	Conductivity (S/m) ^F	ConvF X	ConvF Y	ConvF Z	Alpha	Depth (mm)	Unct. (k=2)
750	41.9	0.89	8.95	8.95	8.95	0.50	0.79	± 12.0 %
835	41.5	0.90	8.60	8.60	8.60	0.50	0.75	± 12.0 %
900	41.5	0.97	8.51	8.51	8.51	0.56	0.68	± 12.0 %
1750	40.1	1.37	7.51	7.51	7.51	0.36	0.88	± 12.0 %
1900	40.0	1.40	7.18	7.18	7.18	0.80	0.58	± 12.0 %
1950	40.0	1.40	6.95	6.95	6.95	0.46	0.75	± 12.0 %
2000	40.0	1.40	7.15	7.15	7.15	0.35	0.86	± 12.0 %
2450	39.2	1.80	6.47	6.47	6.47	0.28	0.99	± 12.0 %
4950	36.3	4.40	5.08	5.08	5.08	0.37	1.80	± 13.1 %
5200	36.0	4.66	4.79	4.79	4.79	0.35	1.80	± 13.1 %
5300	35.9	4.76	4.60	4.60	4.60	0.36	1.80	± 13.1 %
5500	35.6	4.96	4.47	4.47	4.47	0.37	1.80	± 13.1 %
5600	35.5	5.07	4.17	4.17	4.17	0.43	1.80	± 13.1 %
5800	35.3	5.27	4.20	4.20	4.20	0.44	1.80	± 13.1 %

^C Frequency validity of ± 100 MHz only applies for DASY v4.4 and higher (see Page 2), else it is restricted to ± 50 MHz. The uncertainty is the RSS of the ConvF uncertainty at calibration frequency and the uncertainty for the indicated frequency band.

^F At frequencies below 3 GHz, the validity of tissue parameters (ϵ and σ) can be relaxed to ± 10% if liquid compensation formula is applied to measured SAR values. At frequencies above 3 GHz, the validity of tissue parameters (ϵ and σ) is restricted to ± 5%. The uncertainty is the RSS of the ConvF uncertainty for indicated target tissue parameters.

DASY/EASY - Parameters of Probe: EX3DV4 - SN:3751

Calibration Parameter Determined in Body Tissue Simulating Media

f (MHz) ^C	Relative Permittivity ^F	Conductivity (S/m) ^F	ConvF X	ConvF Y	ConvF Z	Alpha	Depth (mm)	Unct. (k=2)
750	55.5	0.96	8.74	8.74	8.74	0.48	0.81	± 12.0 %
835	55.2	0.97	8.58	8.58	8.58	0.38	0.93	± 12.0 %
900	55.0	1.05	8.52	8.52	8.52	0.40	0.90	± 12.0 %
1750	53.4	1.49	7.38	7.38	7.38	0.46	0.81	± 12.0 %
1900	53.3	1.52	6.95	6.95	6.95	0.30	1.01	± 12.0 %
1950	53.3	1.52	7.16	7.16	7.16	0.34	0.89	± 12.0 %
2000	53.3	1.52	7.10	7.10	7.10	0.47	0.74	± 12.0 %
2450	52.7	1.95	6.61	6.61	6.61	0.80	0.50	± 12.0 %
4950	49.4	5.01	4.32	4.32	4.32	0.40	1.90	± 13.1 %
5200	49.0	5.30	4.26	4.26	4.26	0.40	1.90	± 13.1 %
5300	48.9	5.42	4.00	4.00	4.00	0.45	1.90	± 13.1 %
5500	48.6	5.65	3.69	3.69	3.69	0.48	1.90	± 13.1 %
5600	48.5	5.77	3.63	3.63	3.63	0.43	1.90	± 13.1 %
5800	48.2	6.00	3.88	3.88	3.88	0.48	1.90	± 13.1 %

^C Frequency validity of ± 100 MHz only applies for DASY v4.4 and higher (see Page 2), else it is restricted to ± 50 MHz. The uncertainty is the RSS of the ConvF uncertainty at calibration frequency and the uncertainty for the indicated frequency band.

^F At frequencies below 3 GHz, the validity of tissue parameters (ϵ and σ) can be relaxed to ± 10% if liquid compensation formula is applied to measured SAR values. At frequencies above 3 GHz, the validity of tissue parameters (ϵ and σ) is restricted to ± 5%. The uncertainty is the RSS of the ConvF uncertainty for indicated target tissue parameters.

Frequency Response of E-Field

(TEM-Cell:ifi110 EXX, Waveguide: R22)

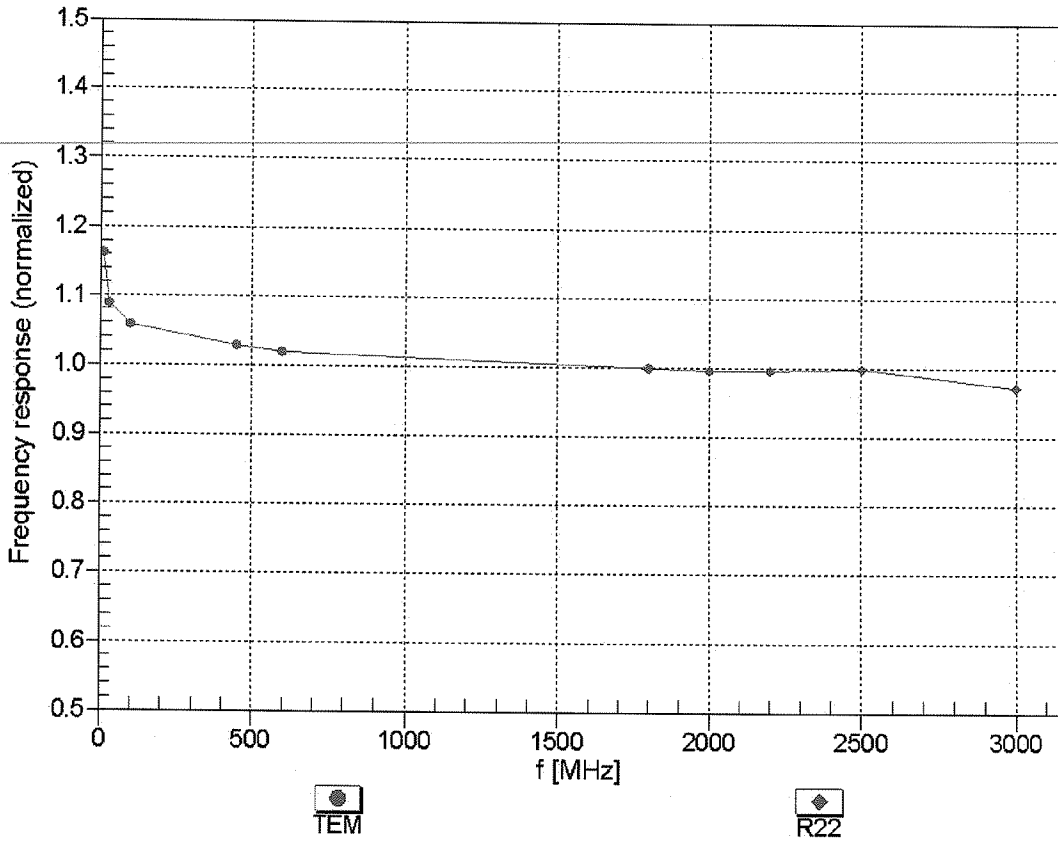

Uncertainty of Frequency Response of E-field: $\pm 6.3\%$ (k=2)

Receiving Pattern (ϕ), $\vartheta = 0^\circ$

f=600 MHz, TEM

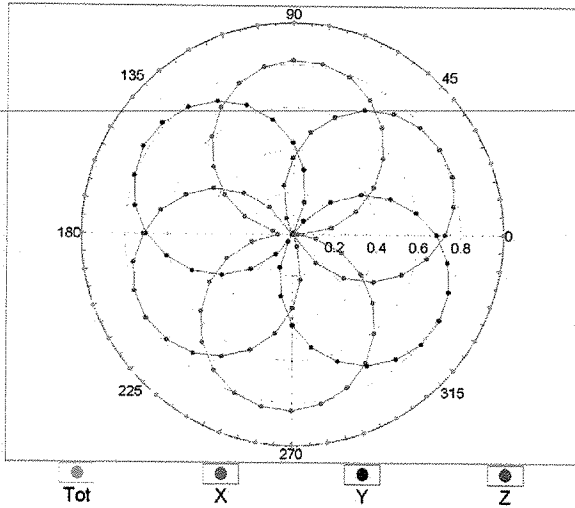

f=1800 MHz, R22

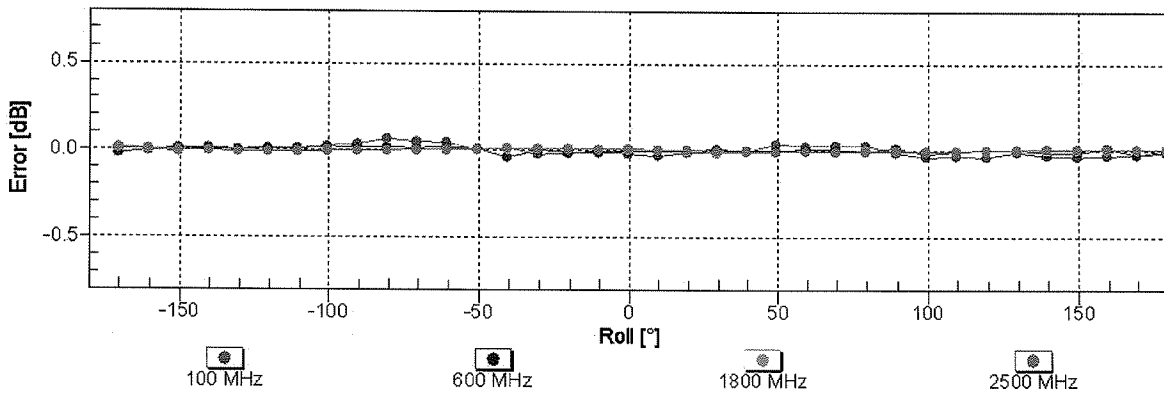
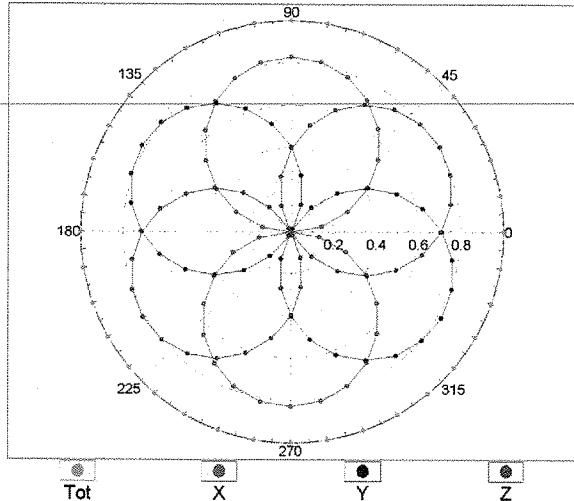

Uncertainty of Axial Isotropy Assessment: $\pm 0.5\%$ (k=2)

Dynamic Range f(SAR_{head})

(TEM cell , f = 900 MHz)

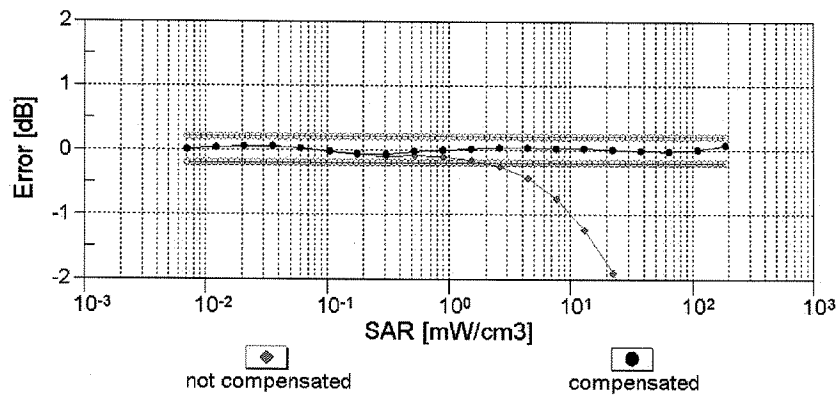
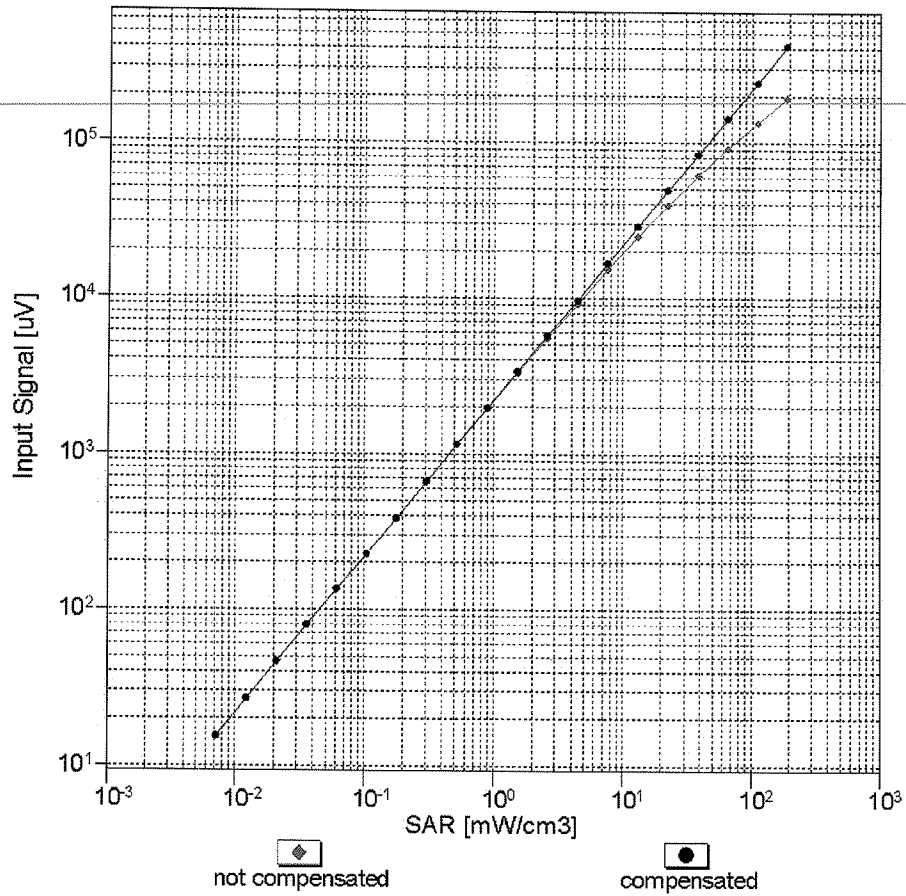

Uncertainty of Linearity Assessment: ± 0.6% (k=2)

Conversion Factor Assessment

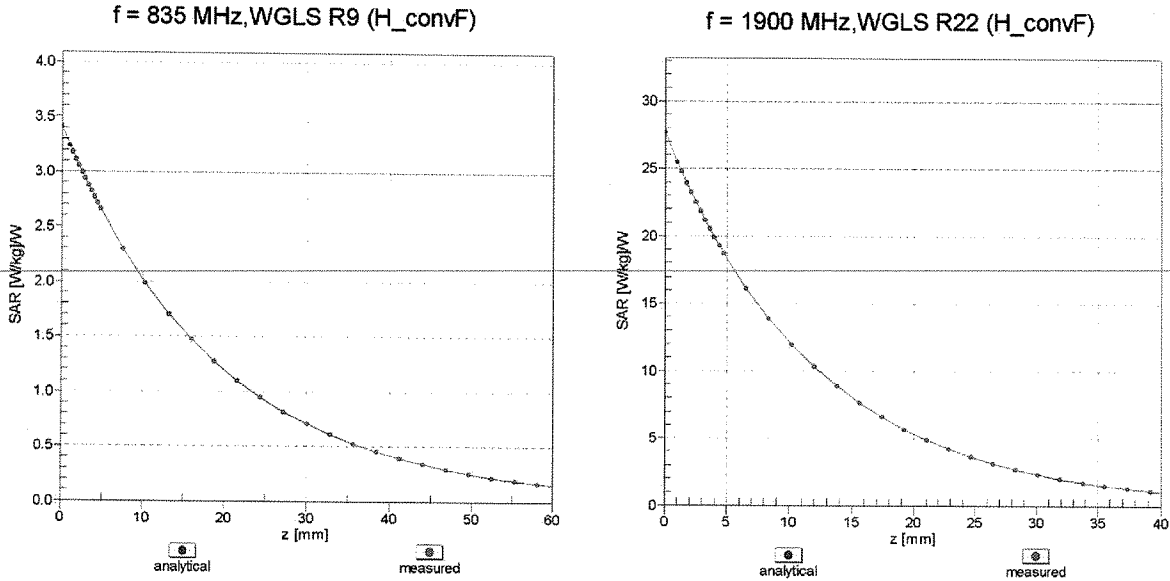

Deviation from Isotropy in Liquid Error (ϕ, θ), f = 900 MHz

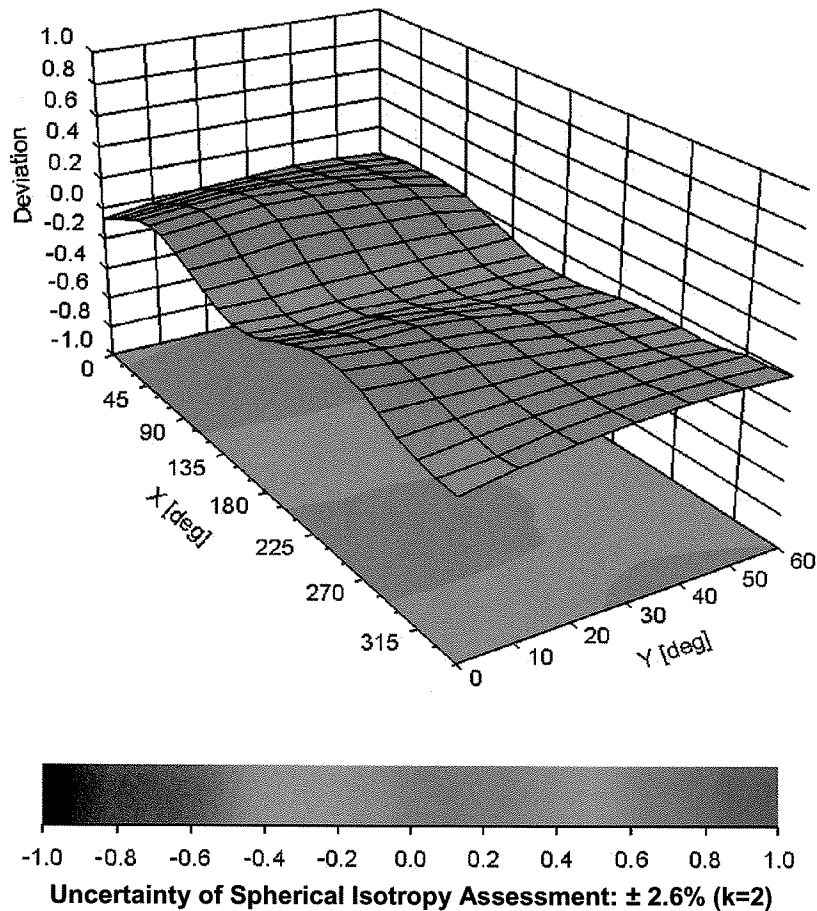

DASY/EASY - Parameters of Probe: EX3DV4 - SN:3751

Other Probe Parameters

Sensor Arrangement	Triangular
Connector Angle (°)	9.4
Mechanical Surface Detection Mode	enabled
Optical Surface Detection Mode	disabled
Probe Overall Length	337 mm
Probe Body Diameter	10 mm
Tip Length	9 mm
Tip Diameter	2.5 mm
Probe Tip to Sensor X Calibration Point	1 mm
Probe Tip to Sensor Y Calibration Point	1 mm
Probe Tip to Sensor Z Calibration Point	1 mm
Recommended Measurement Distance from Surface	2 mm



Accredited by the Swiss Accreditation Service (SAS)
The Swiss Accreditation Service is one of the signatories to the EA
Multilateral Agreement for the recognition of calibration certificates

Accreditation No.: **SCS 108**

Client **UL CCS USA**

Certificate No: **EX3-3772_Feb13**

CALIBRATION CERTIFICATE

Object **EX3DV4 - SN:3772**

Calibration procedure(s) **QA CAL-01.v8, QA CAL-12.v7, QA CAL-14.v3, QA CAL-23.v4,
QA CAL-25.v4
Calibration procedure for dosimetric E-field probes**

Calibration date: **February 20, 2013**

This calibration certificate documents the traceability to national standards, which realize the physical units of measurements (SI).
The measurements and the uncertainties with confidence probability are given on the following pages and are part of the certificate.

All calibrations have been conducted in the closed laboratory facility: environment temperature (22 ± 3)°C and humidity < 70%.

Calibration Equipment used (M&TE critical for calibration)

Primary Standards	ID	Cal Date (Certificate No.)	Scheduled Calibration
Power meter E4419B	GB41293874	29-Mar-12 (No. 217-01508)	Apr-13
Power sensor E4412A	MY41498087	29-Mar-12 (No. 217-01508)	Apr-13
Reference 3 dB Attenuator	SN: S5054 (3c)	27-Mar-12 (No. 217-01531)	Apr-13
Reference 20 dB Attenuator	SN: S5086 (20b)	27-Mar-12 (No. 217-01529)	Apr-13
Reference 30 dB Attenuator	SN: S5129 (30b)	27-Mar-12 (No. 217-01532)	Apr-13
Reference Probe ES3DV2	SN: 3013	28-Dec-12 (No. ES3-3013_Dec12)	Dec-13
DAE4	SN: 660	31-Jan-13 (No. DAE4-660_Jan13)	Jan-13
Secondary Standards	ID	Check Date (in house)	Scheduled Check
RF generator HP 8648C	US3642U01700	4-Aug-99 (in house check Apr-11)	In house check: Apr-13
Network Analyzer HP 8753E	US37390585	18-Oct-01 (in house check Oct-12)	In house check: Oct-13

	Name	Function	Signature
Calibrated by:	Jeton Kastrati	Laboratory Technician	
Approved by:	Katja Pokovic	Technical Manager	

Issued: February 22, 2013

This calibration certificate shall not be reproduced except in full without written approval of the laboratory.



Accredited by the Swiss Accreditation Service (SAS)

Accreditation No.: **SCS 108**

The Swiss Accreditation Service is one of the signatories to the EA Multilateral Agreement for the recognition of calibration certificates

Glossary:

TSL	tissue simulating liquid
NORM _{x,y,z}	sensitivity in free space
ConvF	sensitivity in TSL / NORM _{x,y,z}
DCP	diode compression point
CF	crest factor (1/duty_cycle) of the RF signal
A, B, C, D	modulation dependent linearization parameters
Polarization φ	φ rotation around probe axis
Polarization ϑ	ϑ rotation around an axis that is in the plane normal to probe axis (at measurement center), i.e., $\vartheta = 0$ is normal to probe axis

Calibration is Performed According to the Following Standards:

- IEEE Std 1528-2003, "IEEE Recommended Practice for Determining the Peak Spatial-Averaged Specific Absorption Rate (SAR) in the Human Head from Wireless Communications Devices: Measurement Techniques", December 2003
- IEC 62209-1, "Procedure to measure the Specific Absorption Rate (SAR) for hand-held devices used in close proximity to the ear (frequency range of 300 MHz to 3 GHz)", February 2005

Methods Applied and Interpretation of Parameters:

- NORM_{x,y,z}**: Assessed for E-field polarization $\vartheta = 0$ ($f \leq 900$ MHz in TEM-cell; $f > 1800$ MHz: R22 waveguide). NORM_{x,y,z} are only intermediate values, i.e., the uncertainties of NORM_{x,y,z} does not affect the E²-field uncertainty inside TSL (see below ConvF).
- NORM(f)_{x,y,z}** = NORM_{x,y,z} * frequency_response (see Frequency Response Chart). This linearization is implemented in DASY4 software versions later than 4.2. The uncertainty of the frequency response is included in the stated uncertainty of ConvF.
- DCP_{x,y,z}**: DCP are numerical linearization parameters assessed based on the data of power sweep with CW signal (no uncertainty required). DCP does not depend on frequency nor media.
- PAR**: PAR is the Peak to Average Ratio that is not calibrated but determined based on the signal characteristics
- A_{x,y,z}; B_{x,y,z}; C_{x,y,z}; D_{x,y,z}; VR_{x,y,z}**: A, B, C, D are numerical linearization parameters assessed based on the data of power sweep for specific modulation signal. The parameters do not depend on frequency nor media. VR is the maximum calibration range expressed in RMS voltage across the diode.
- ConvF and Boundary Effect Parameters**: Assessed in flat phantom using E-field (or Temperature Transfer Standard for $f \leq 800$ MHz) and inside waveguide using analytical field distributions based on power measurements for $f > 800$ MHz. The same setups are used for assessment of the parameters applied for boundary compensation (alpha, depth) of which typical uncertainty values are given. These parameters are used in DASY4 software to improve probe accuracy close to the boundary. The sensitivity in TSL corresponds to NORM_{x,y,z} * ConvF whereby the uncertainty corresponds to that given for ConvF. A frequency dependent ConvF is used in DASY version 4.4 and higher which allows extending the validity from ± 50 MHz to ± 100 MHz.
- Spherical isotropy (3D deviation from isotropy)**: in a field of low gradients realized using a flat phantom exposed by a patch antenna.
- Sensor Offset**: The sensor offset corresponds to the offset of virtual measurement center from the probe tip (on probe axis). No tolerance required.

Probe EX3DV4

SN:3772

Manufactured: January 10, 2011
Calibrated: February 20, 2013

Calibrated for DASY/EASY Systems
(Note: non-compatible with DASY2 system!)

DASY/EASY - Parameters of Probe: EX3DV4 - SN:3772

Basic Calibration Parameters

	Sensor X	Sensor Y	Sensor Z	Unc (k=2)
Norm ($\mu\text{V}/(\text{V}/\text{m})^2$) ^A	0.49	0.55	0.55	$\pm 10.1 \%$
DCP (mV) ^B	99.2	98.9	100.2	

Modulation Calibration Parameters

UID	Communication System Name		A dB	B dB $\sqrt{\mu\text{V}}$	C	D dB	VR mV	Unc ^E (k=2)
0	CW	X	0.0	0.0	1.0	0.00	162.4	$\pm 3.5 \%$
		Y	0.0	0.0	1.0		131.6	
		Z	0.0	0.0	1.0		172.3	

The reported uncertainty of measurement is stated as the standard uncertainty of measurement multiplied by the coverage factor k=2, which for a normal distribution corresponds to a coverage probability of approximately 95%.

^A The uncertainties of NormX,Y,Z do not affect the E²-field uncertainty inside TSL (see Pages 5 and 6).

^B Numerical linearization parameter: uncertainty not required.

^E Uncertainty is determined using the max. deviation from linear response applying rectangular distribution and is expressed for the square of the field value.

DASY/EASY - Parameters of Probe: EX3DV4 - SN:3772

Calibration Parameter Determined in Head Tissue Simulating Media

f (MHz) ^C	Relative Permittivity ^F	Conductivity (S/m) ^F	ConvF X	ConvF Y	ConvF Z	Alpha	Depth (mm)	Unct. (k=2)
450	43.5	0.87	9.08	9.08	9.08	0.14	1.20	± 13.4 %
750	41.9	0.89	9.03	9.03	9.03	0.24	1.22	± 12.0 %
835	41.5	0.90	8.77	8.77	8.77	0.65	0.65	± 12.0 %
900	41.5	0.97	8.70	8.70	8.70	0.60	0.70	± 12.0 %
1450	40.5	1.20	7.65	7.65	7.65	0.39	1.09	± 12.0 %
1640	40.3	1.29	7.94	7.94	7.94	0.76	0.57	± 12.0 %
1750	40.1	1.37	7.69	7.69	7.69	0.68	0.63	± 12.0 %
1900	40.0	1.40	7.42	7.42	7.42	0.43	0.79	± 12.0 %
1950	40.0	1.40	7.19	7.19	7.19	0.42	0.80	± 12.0 %
2000	40.0	1.40	7.36	7.36	7.36	0.32	0.93	± 12.0 %
2300	39.5	1.67	7.05	7.05	7.05	0.43	0.78	± 12.0 %
2450	39.2	1.80	6.72	6.72	6.72	0.40	0.82	± 12.0 %
2600	39.0	1.96	6.51	6.51	6.51	0.30	0.99	± 12.0 %
3500	37.9	2.91	6.54	6.54	6.54	0.50	0.95	± 13.1 %
3700	37.7	3.12	6.13	6.13	6.13	0.48	0.94	± 13.1 %
4950	36.3	4.40	5.23	5.23	5.23	0.40	1.80	± 13.1 %
5200	36.0	4.66	4.66	4.66	4.66	0.42	1.80	± 13.1 %
5300	35.9	4.76	4.47	4.47	4.47	0.42	1.80	± 13.1 %
5500	35.6	4.96	4.38	4.38	4.38	0.42	1.80	± 13.1 %
5600	35.5	5.07	4.28	4.28	4.28	0.38	1.80	± 13.1 %
5800	35.3	5.27	4.12	4.12	4.12	0.48	1.80	± 13.1 %

^C Frequency validity of ± 100 MHz only applies for DASY v4.4 and higher (see Page 2), else it is restricted to ± 50 MHz. The uncertainty is the RSS of the ConvF uncertainty at calibration frequency and the uncertainty for the indicated frequency band.

^F At frequencies below 3 GHz, the validity of tissue parameters (ϵ and σ) can be relaxed to ± 10% if liquid compensation formula is applied to measured SAR values. At frequencies above 3 GHz, the validity of tissue parameters (ϵ and σ) is restricted to ± 5%. The uncertainty is the RSS of the ConvF uncertainty for indicated target tissue parameters.

DASY/EASY - Parameters of Probe: EX3DV4 - SN:3772

Calibration Parameter Determined in Body Tissue Simulating Media

f (MHz) ^C	Relative Permittivity ^F	Conductivity (S/m) ^F	ConvF X	ConvF Y	ConvF Z	Alpha	Depth (mm)	Unct. (k=2)
450	56.7	0.94	9.90	9.90	9.90	0.06	1.20	± 13.4 %
750	55.5	0.96	8.82	8.82	8.82	0.67	0.70	± 12.0 %
835	55.2	0.97	8.67	8.67	8.67	0.35	1.01	± 12.0 %
900	55.0	1.05	8.59	8.59	8.59	0.80	0.63	± 12.0 %
1450	54.0	1.30	7.54	7.54	7.54	0.42	0.85	± 12.0 %
1640	53.8	1.40	7.70	7.70	7.70	0.76	0.63	± 12.0 %
1750	53.4	1.49	7.10	7.10	7.10	0.51	0.79	± 12.0 %
1900	53.3	1.52	6.96	6.96	6.96	0.50	0.76	± 12.0 %
1950	53.3	1.52	7.17	7.17	7.17	0.30	0.89	± 12.0 %
2000	53.3	1.52	7.03	7.03	7.03	0.29	0.97	± 12.0 %
2300	52.9	1.81	6.80	6.80	6.80	0.80	0.59	± 12.0 %
2450	52.7	1.95	6.57	6.57	6.57	0.80	0.57	± 12.0 %
2600	52.5	2.16	6.49	6.49	6.49	0.80	0.50	± 12.0 %
3500	51.3	3.31	5.93	5.93	5.93	0.34	1.29	± 13.1 %
3700	51.0	3.55	5.74	5.74	5.74	0.27	1.60	± 13.1 %
4950	49.4	5.01	4.34	4.34	4.34	0.42	1.90	± 13.1 %
5200	49.0	5.30	4.03	4.03	4.03	0.52	1.90	± 13.1 %
5300	48.9	5.42	3.74	3.74	3.74	0.58	1.90	± 13.1 %
5500	48.6	5.65	3.56	3.56	3.56	0.59	1.90	± 13.1 %
5600	48.5	5.77	3.37	3.37	3.37	0.60	1.90	± 13.1 %
5800	48.2	6.00	3.67	3.67	3.67	0.60	1.90	± 13.1 %

^C Frequency validity of ± 100 MHz only applies for DASY v4.4 and higher (see Page 2), else it is restricted to ± 50 MHz. The uncertainty is the RSS of the ConvF uncertainty at calibration frequency and the uncertainty for the indicated frequency band.

^F At frequencies below 3 GHz, the validity of tissue parameters (ϵ and σ) can be relaxed to ± 10% if liquid compensation formula is applied to measured SAR values. At frequencies above 3 GHz, the validity of tissue parameters (ϵ and σ) is restricted to ± 5%. The uncertainty is the RSS of the ConvF uncertainty for indicated target tissue parameters.

Frequency Response of E-Field

(TEM-Cell:ifi110 EXX, Waveguide: R22)

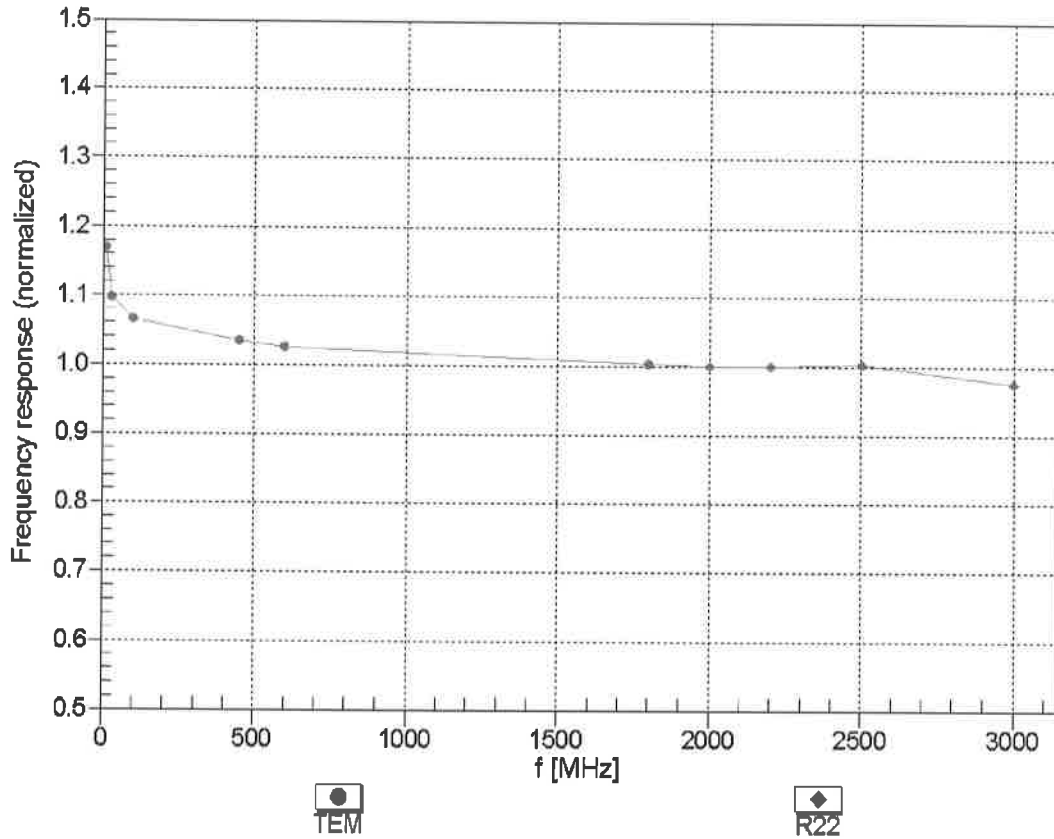

Uncertainty of Frequency Response of E-field: $\pm 6.3\%$ (k=2)

Receiving Pattern (ϕ), $\theta = 0^\circ$

f=600 MHz,TEM

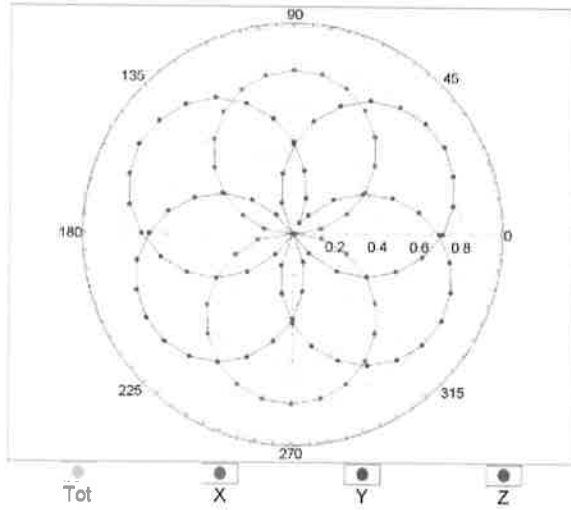

f=1800 MHz,R22

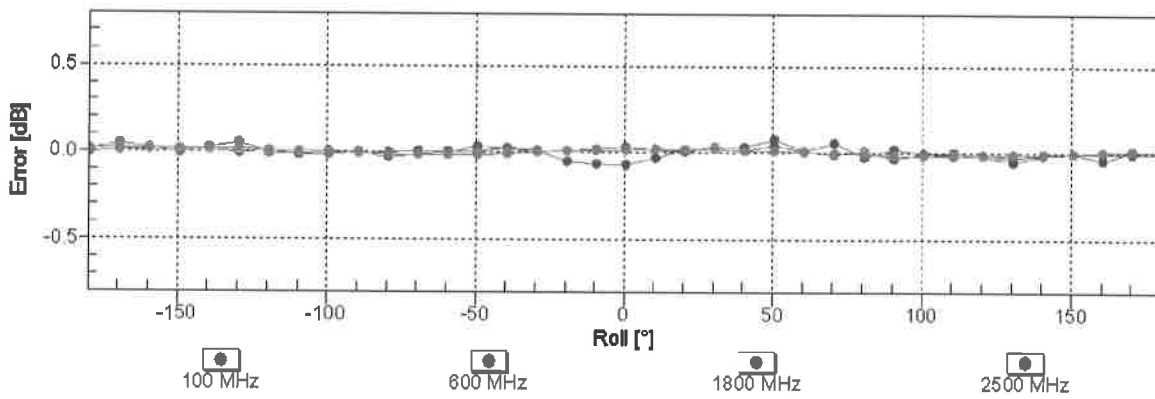
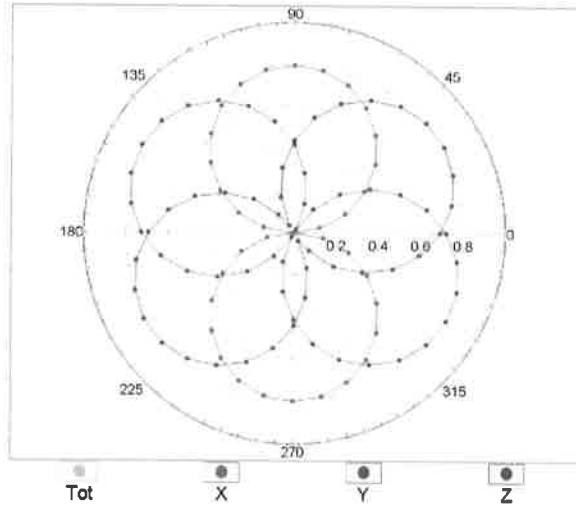

Uncertainty of Axial Isotropy Assessment: $\pm 0.5\%$ (k=2)

Dynamic Range f(SAR_{head}) (TEM cell , f = 900 MHz)

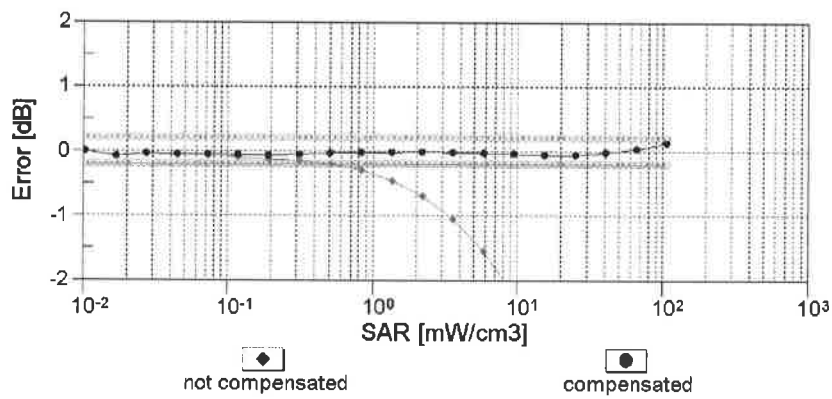
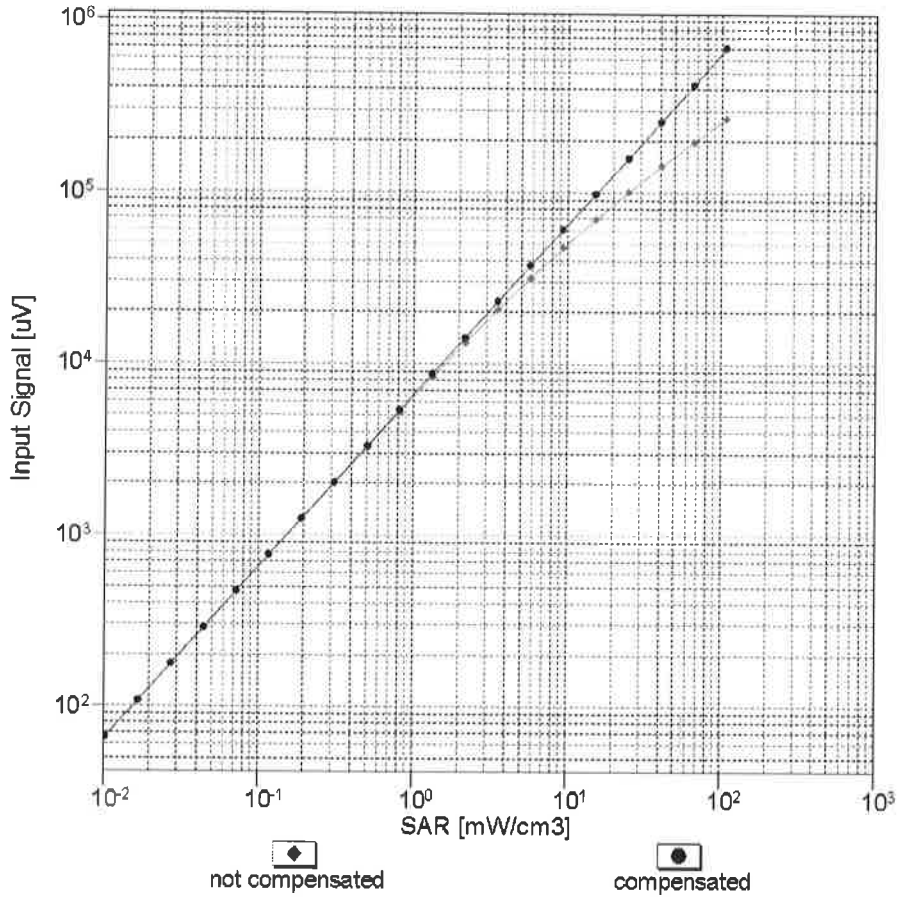

Uncertainty of Linearity Assessment: ± 0.6% (k=2)

Conversion Factor Assessment

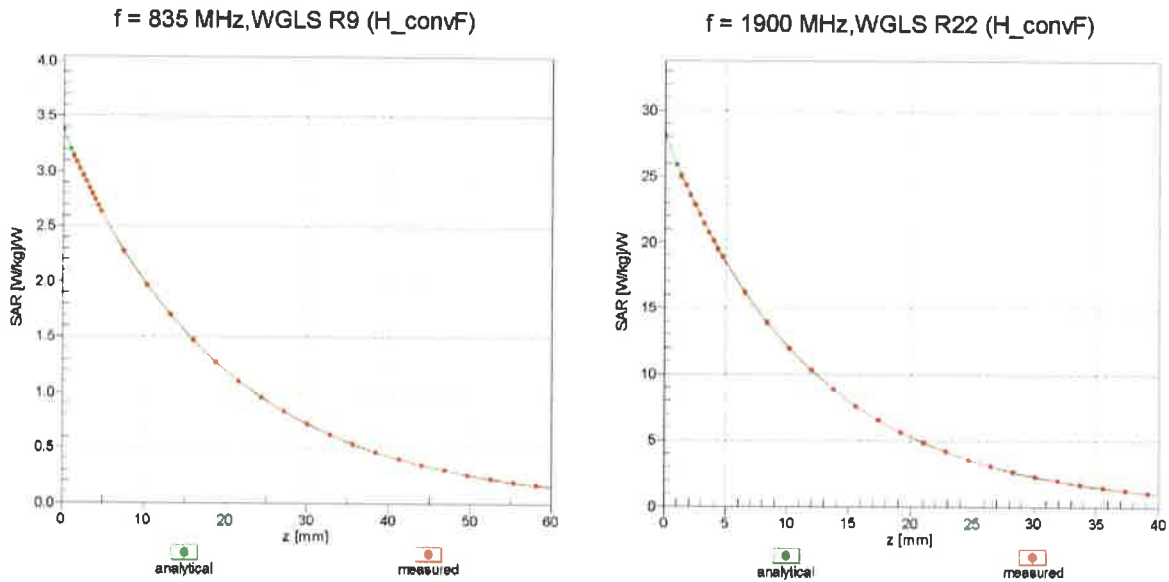

Deviation from Isotropy in Liquid Error (ϕ, ϑ), f = 900 MHz

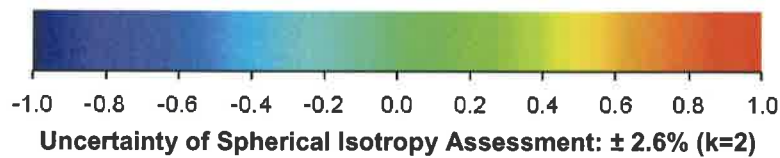
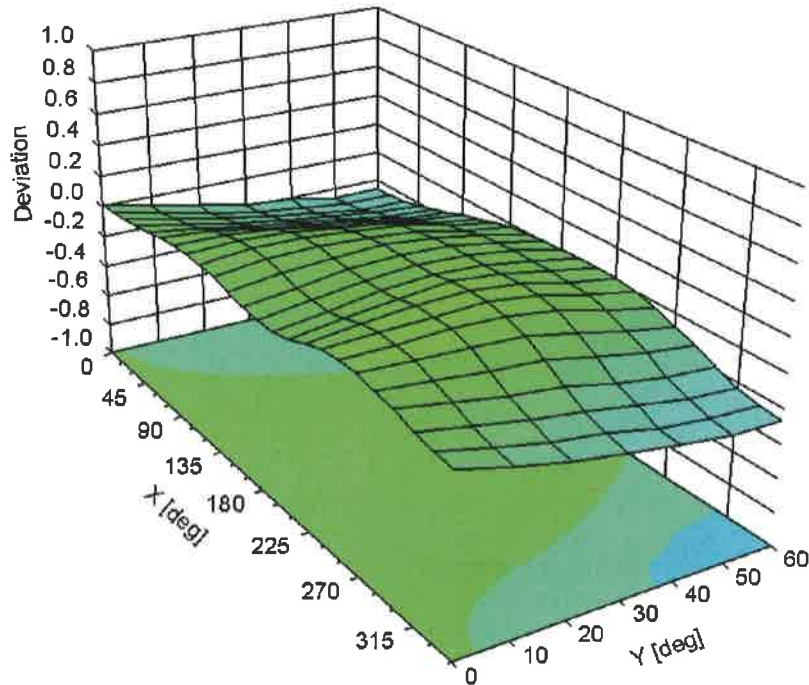

DASY/EASY - Parameters of Probe: EX3DV4 - SN:3772

Other Probe Parameters

Sensor Arrangement	Triangular
Connector Angle (°)	-99.4
Mechanical Surface Detection Mode	enabled
Optical Surface Detection Mode	disabled
Probe Overall Length	337 mm
Probe Body Diameter	10 mm
Tip Length	9 mm
Tip Diameter	2.5 mm
Probe Tip to Sensor X Calibration Point	1 mm
Probe Tip to Sensor Y Calibration Point	1 mm
Probe Tip to Sensor Z Calibration Point	1 mm
Recommended Measurement Distance from Surface	2 mm



Accredited by the Swiss Accreditation Service (SAS)
The Swiss Accreditation Service is one of the signatories to the EA
Multilateral Agreement for the recognition of calibration certificates

Accreditation No.: **SCS 108**

Client **UL CCS USA**

Certificate No: **EX3-3686_Mar13**

CALIBRATION CERTIFICATE

Object **EX3DV4 - SN:3686**

Calibration procedure(s) **QA CAL-01.v8, QA CAL-14.v3, QA CAL-23.v4, QA CAL-25.v4
Calibration procedure for dosimetric E-field probes**

Calibration date: **March 11, 2013**

This calibration certificate documents the traceability to national standards, which realize the physical units of measurements (SI).
The measurements and the uncertainties with confidence probability are given on the following pages and are part of the certificate.

All calibrations have been conducted in the closed laboratory facility: environment temperature (22 ± 3)°C and humidity < 70%.

Calibration Equipment used (M&TE critical for calibration)

Primary Standards	ID	Cal Date (Certificate No.)	Scheduled Calibration
Power meter E4419B	GB41293874	29-Mar-12 (No. 217-01508)	Apr-13
Power sensor E4412A	MY41498087	29-Mar-12 (No. 217-01508)	Apr-13
Reference 3 dB Attenuator	SN: S5054 (3c)	27-Mar-12 (No. 217-01531)	Apr-13
Reference 20 dB Attenuator	SN: S5086 (20b)	27-Mar-12 (No. 217-01529)	Apr-13
Reference 30 dB Attenuator	SN: S5129 (30b)	27-Mar-12 (No. 217-01532)	Apr-13
Reference Probe ES3DV2	SN: 3013	28-Dec-12 (No. ES3-3013_Dec12)	Dec-13
DAE4	SN: 660	31-Jan-13 (No. DAE4-660_Jan13)	Jan-14
Secondary Standards	ID	Check Date (in house)	Scheduled Check
RF generator HP 8648C	US3642U01700	4-Aug-99 (in house check Apr-11)	In house check: Apr-13
Network Analyzer HP 8753E	US37390585	18-Oct-01 (in house check Oct-12)	In house check: Oct-13

Calibrated by:	Name Claudio Leubler	Function Laboratory Technician	Signature
Approved by:	Name Katja Pokovic	Function Technical Manager	Signature

Issued: March 11, 2013

This calibration certificate shall not be reproduced except in full without written approval of the laboratory.



Accredited by the Swiss Accreditation Service (SAS)

Accreditation No.: **SCS 108**

The Swiss Accreditation Service is one of the signatories to the EA
Multilateral Agreement for the recognition of calibration certificates

Glossary:

TSL	tissue simulating liquid
NORM _{x,y,z}	sensitivity in free space
ConvF	sensitivity in TSL / NORM _{x,y,z}
DCP	diode compression point
CF	crest factor (1/duty_cycle) of the RF signal
A, B, C, D	modulation dependent linearization parameters
Polarization φ	φ rotation around probe axis
Polarization ϑ	ϑ rotation around an axis that is in the plane normal to probe axis (at measurement center), i.e., $\vartheta = 0$ is normal to probe axis

Calibration is Performed According to the Following Standards:

- IEEE Std 1528-2003, "IEEE Recommended Practice for Determining the Peak Spatial-Averaged Specific Absorption Rate (SAR) in the Human Head from Wireless Communications Devices: Measurement Techniques", December 2003
- IEC 62209-1, "Procedure to measure the Specific Absorption Rate (SAR) for hand-held devices used in close proximity to the ear (frequency range of 300 MHz to 3 GHz)", February 2005

Methods Applied and Interpretation of Parameters:

- NORM_{x,y,z}**: Assessed for E-field polarization $\vartheta = 0$ ($f \leq 900$ MHz in TEM-cell; $f > 1800$ MHz: R22 waveguide). NORM_{x,y,z} are only intermediate values, i.e., the uncertainties of NORM_{x,y,z} does not affect the E^2 -field uncertainty inside TSL (see below *ConvF*).
- NORM(f)_{x,y,z}** = NORM_{x,y,z} * *frequency_response* (see Frequency Response Chart). This linearization is implemented in DASY4 software versions later than 4.2. The uncertainty of the frequency response is included in the stated uncertainty of *ConvF*.
- DCP_{x,y,z}**: DCP are numerical linearization parameters assessed based on the data of power sweep with CW signal (no uncertainty required). DCP does not depend on frequency nor media.
- PAR**: PAR is the Peak to Average Ratio that is not calibrated but determined based on the signal characteristics
- A_{x,y,z}; B_{x,y,z}; C_{x,y,z}; D_{x,y,z}; VR_{x,y,z}**: A, B, C, D are numerical linearization parameters assessed based on the data of power sweep for specific modulation signal. The parameters do not depend on frequency nor media. VR is the maximum calibration range expressed in RMS voltage across the diode.
- ConvF and Boundary Effect Parameters**: Assessed in flat phantom using E-field (or Temperature Transfer Standard for $f \leq 800$ MHz) and inside waveguide using analytical field distributions based on power measurements for $f > 800$ MHz. The same setups are used for assessment of the parameters applied for boundary compensation (alpha, depth) of which typical uncertainty values are given. These parameters are used in DASY4 software to improve probe accuracy close to the boundary. The sensitivity in TSL corresponds to NORM_{x,y,z} * *ConvF* whereby the uncertainty corresponds to that given for *ConvF*. A frequency dependent *ConvF* is used in DASY version 4.4 and higher which allows extending the validity from ± 50 MHz to ± 100 MHz.
- Spherical isotropy (3D deviation from isotropy)**: in a field of low gradients realized using a flat phantom exposed by a patch antenna.
- Sensor Offset**: The sensor offset corresponds to the offset of virtual measurement center from the probe tip (on probe axis). No tolerance required.

Probe EX3DV4

SN:3686

Manufactured: March 10, 2009
Calibrated: March 11, 2013

Calibrated for DASY/EASY Systems
(Note: non-compatible with DASY2 system!)

DASY/EASY - Parameters of Probe: EX3DV4 - SN:3686

Basic Calibration Parameters

	Sensor X	Sensor Y	Sensor Z	Unc (k=2)
Norm ($\mu\text{V}/(\text{V}/\text{m})^2$) ^A	0.49	0.49	0.51	$\pm 10.1 \%$
DCP (mV) ^B	100.1	97.3	98.3	

Modulation Calibration Parameters

UID	Communication System Name		A dB	B dB $\sqrt{\mu\text{V}}$	C	D dB	VR mV	Unc ^E (k=2)
0	CW	X	0.0	0.0	1.0	0.00	163.7	$\pm 3.3 \%$
		Y	0.0	0.0	1.0		154.4	
		Z	0.0	0.0	1.0		160.4	

The reported uncertainty of measurement is stated as the standard uncertainty of measurement multiplied by the coverage factor $k=2$, which for a normal distribution corresponds to a coverage probability of approximately 95%.

^A The uncertainties of NormX,Y,Z do not affect the E²-field uncertainty inside TSL (see Pages 5 and 6).

^B Numerical linearization parameter: uncertainty not required.

^E Uncertainty is determined using the max. deviation from linear response applying rectangular distribution and is expressed for the square of the field value.

DASY/EASY - Parameters of Probe: EX3DV4 - SN:3686

Calibration Parameter Determined in Head Tissue Simulating Media

f (MHz) ^C	Relative Permittivity ^F	Conductivity (S/m) ^F	ConvF X	ConvF Y	ConvF Z	Alpha	Depth (mm)	Unct. (k=2)
750	41.9	0.89	9.47	9.47	9.47	0.25	1.19	± 12.0 %
835	41.5	0.90	9.13	9.13	9.13	0.27	1.05	± 12.0 %
900	41.5	0.97	9.07	9.07	9.07	0.16	1.48	± 12.0 %
1750	40.1	1.37	7.65	7.65	7.65	0.68	0.66	± 12.0 %
1900	40.0	1.40	7.43	7.43	7.43	0.37	0.81	± 12.0 %
1950	40.0	1.40	7.27	7.27	7.27	0.55	0.68	± 12.0 %
2000	40.0	1.40	7.42	7.42	7.42	0.33	0.88	± 12.0 %
2450	39.2	1.80	6.82	6.82	6.82	0.27	1.02	± 12.0 %
2600	39.0	1.96	6.72	6.72	6.72	0.38	0.88	± 12.0 %
5200	36.0	4.66	4.50	4.50	4.50	0.46	1.80	± 13.1 %
5300	35.9	4.76	4.36	4.36	4.36	0.41	1.80	± 13.1 %
5500	35.6	4.96	4.17	4.17	4.17	0.46	1.80	± 13.1 %
5600	35.5	5.07	4.23	4.23	4.23	0.30	1.80	± 13.1 %
5800	35.3	5.27	4.06	4.06	4.06	0.48	1.80	± 13.1 %

^C Frequency validity of ± 100 MHz only applies for DASY v4.4 and higher (see Page 2), else it is restricted to ± 50 MHz. The uncertainty is the RSS of the ConvF uncertainty at calibration frequency and the uncertainty for the indicated frequency band.

^F At frequencies below 3 GHz, the validity of tissue parameters (ϵ and σ) can be relaxed to ± 10% if liquid compensation formula is applied to measured SAR values. At frequencies above 3 GHz, the validity of tissue parameters (ϵ and σ) is restricted to ± 5%. The uncertainty is the RSS of the ConvF uncertainty for indicated target tissue parameters.

DASY/EASY - Parameters of Probe: EX3DV4 - SN:3686

Calibration Parameter Determined in Body Tissue Simulating Media

f (MHz) ^C	Relative Permittivity ^F	Conductivity (S/m) ^F	ConvF X	ConvF Y	ConvF Z	Alpha	Depth (mm)	Unct. (k=2)
750	55.5	0.96	9.20	9.20	9.20	0.59	0.73	± 12.0 %
835	55.2	0.97	9.04	9.04	9.04	0.58	0.76	± 12.0 %
900	55.0	1.05	8.96	8.96	8.96	0.80	0.65	± 12.0 %
1750	53.4	1.49	7.63	7.63	7.63	0.44	0.86	± 12.0 %
1900	53.3	1.52	7.28	7.28	7.28	0.31	1.08	± 12.0 %
1950	53.3	1.52	7.39	7.39	7.39	0.36	0.92	± 12.0 %
2000	53.3	1.52	7.35	7.35	7.35	0.42	0.85	± 12.0 %
2450	52.7	1.95	6.92	6.92	6.92	0.75	0.58	± 12.0 %
2600	52.5	2.16	6.71	6.71	6.71	0.80	0.50	± 12.0 %
5200	49.0	5.30	4.28	4.28	4.28	0.41	1.90	± 13.1 %
5300	48.9	5.42	4.02	4.02	4.02	0.45	1.90	± 13.1 %
5500	48.6	5.65	3.70	3.70	3.70	0.49	1.90	± 13.1 %
5600	48.5	5.77	3.82	3.82	3.82	0.30	1.90	± 13.1 %
5800	48.2	6.00	3.75	3.75	3.75	0.55	1.90	± 13.1 %

^C Frequency validity of ± 100 MHz only applies for DASY v4.4 and higher (see Page 2), else it is restricted to ± 50 MHz. The uncertainty is the RSS of the ConvF uncertainty at calibration frequency and the uncertainty for the indicated frequency band.

^F At frequencies below 3 GHz, the validity of tissue parameters (ϵ and σ) can be relaxed to ± 10% if liquid compensation formula is applied to measured SAR values. At frequencies above 3 GHz, the validity of tissue parameters (ϵ and σ) is restricted to ± 5%. The uncertainty is the RSS of the ConvF uncertainty for indicated target tissue parameters.

Frequency Response of E-Field (TEM-Cell:ifi110 EXX, Waveguide: R22)

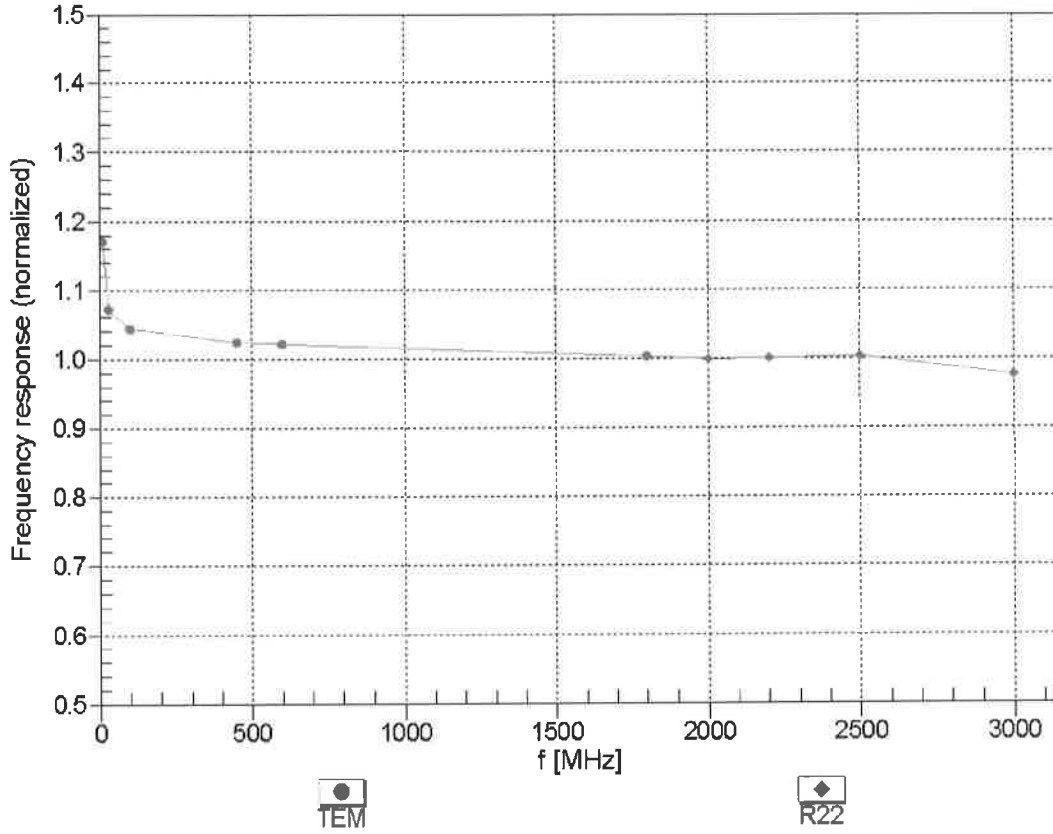

Uncertainty of Frequency Response of E-field: $\pm 6.3\%$ (k=2)

Receiving Pattern (ϕ), $\theta = 0^\circ$

f=600 MHz,TEM

f=1800 MHz,R22

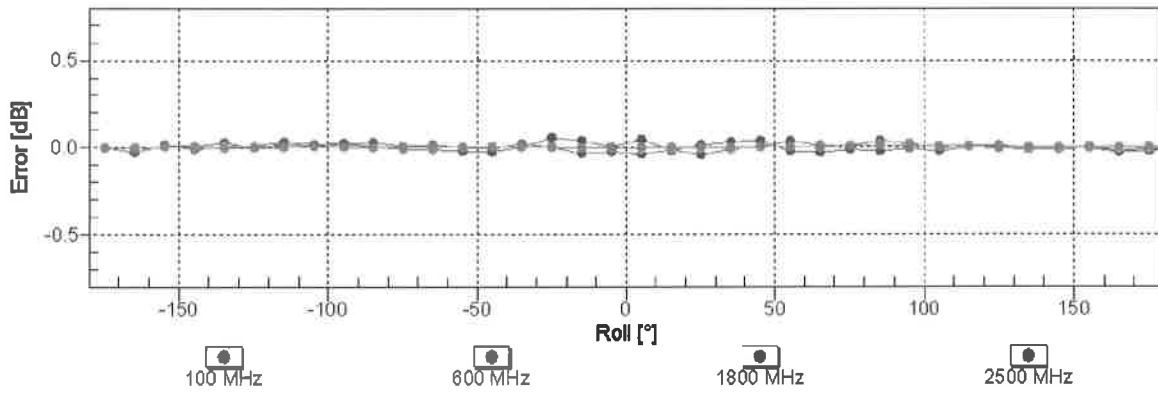
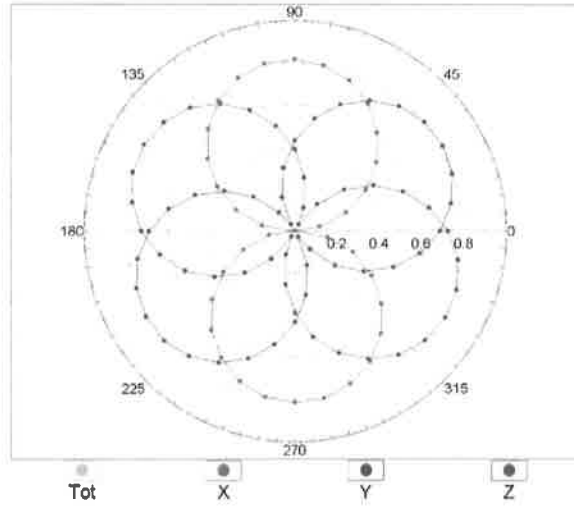
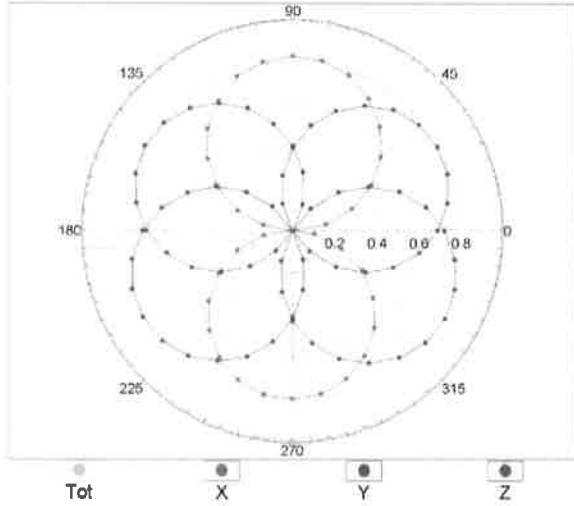

Uncertainty of Axial Isotropy Assessment: $\pm 0.5\%$ ($k=2$)

Dynamic Range f(SAR_{head}) (TEM cell , f = 900 MHz)

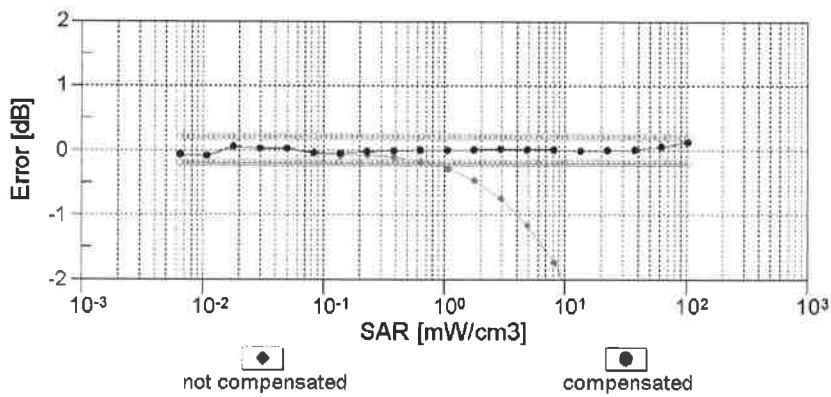
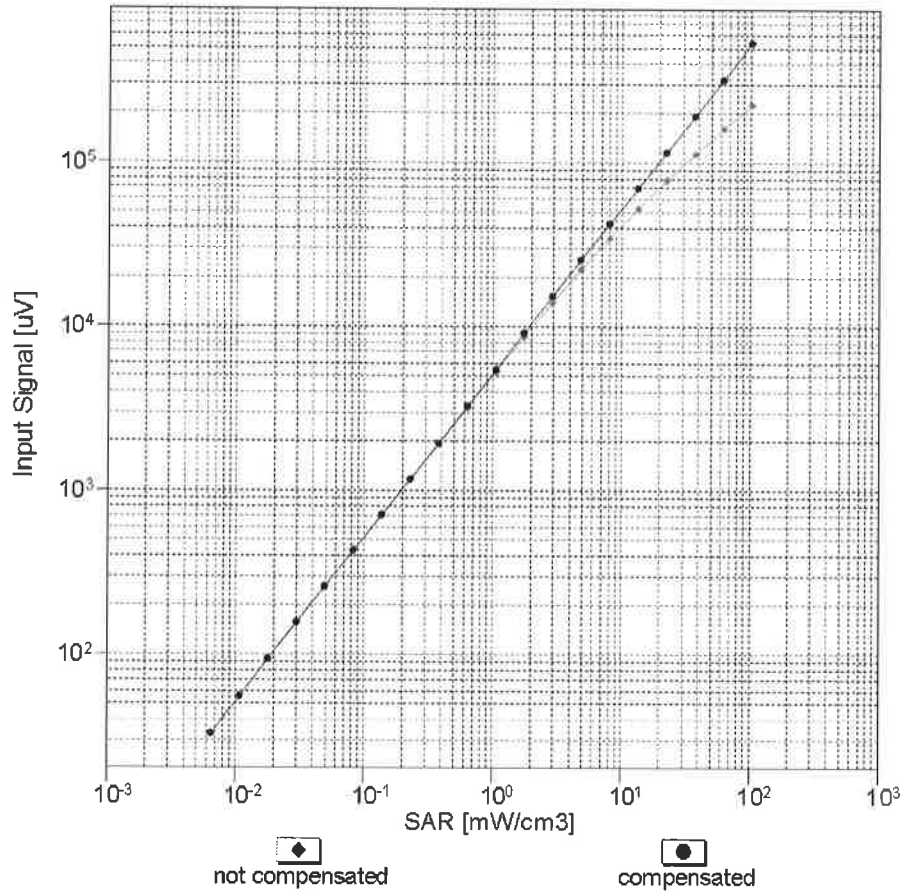

Uncertainty of Linearity Assessment: ± 0.6% (k=2)

Conversion Factor Assessment

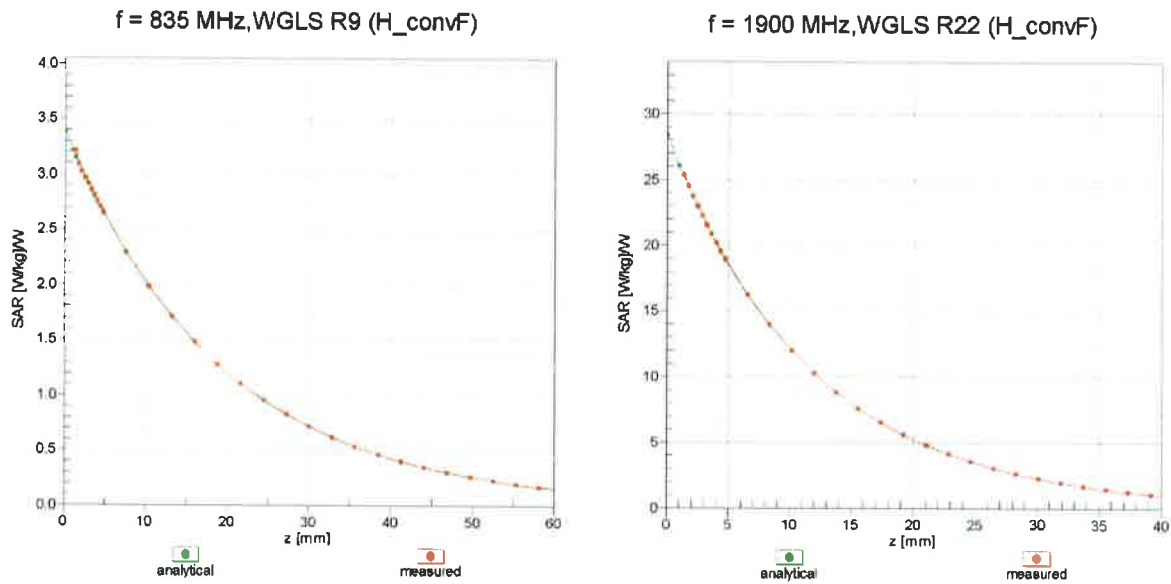

Deviation from Isotropy in Liquid Error (ϕ, θ), f = 900 MHz

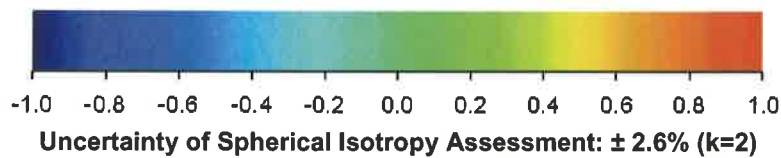
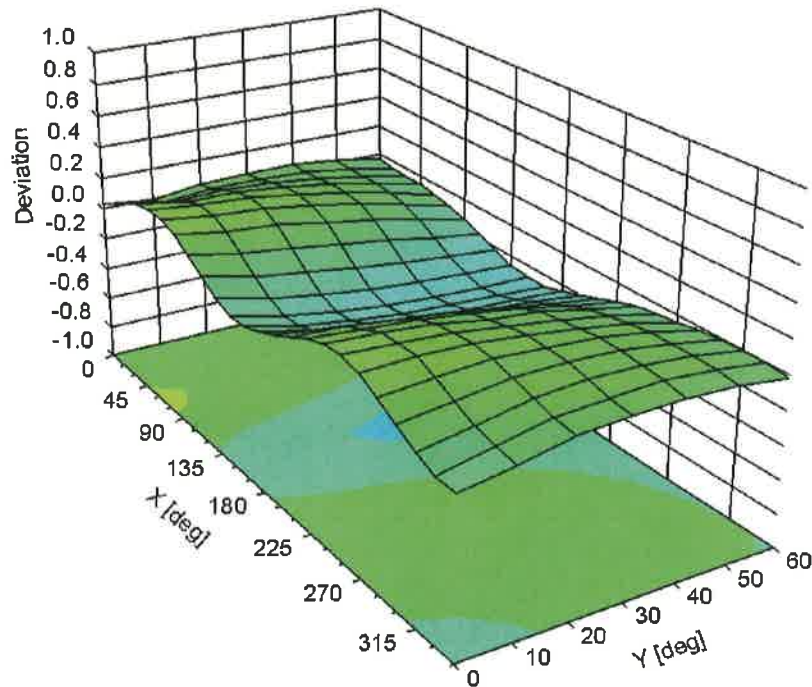

DASY/EASY - Parameters of Probe: EX3DV4 - SN:3686

Other Probe Parameters

Sensor Arrangement	Triangular
Connector Angle (°)	-104.8
Mechanical Surface Detection Mode	enabled
Optical Surface Detection Mode	disabled
Probe Overall Length	337 mm
Probe Body Diameter	10 mm
Tip Length	9 mm
Tip Diameter	2.5 mm
Probe Tip to Sensor X Calibration Point	1 mm
Probe Tip to Sensor Y Calibration Point	1 mm
Probe Tip to Sensor Z Calibration Point	1 mm
Recommended Measurement Distance from Surface	2 mm



Accredited by the Swiss Accreditation Service (SAS)
The Swiss Accreditation Service is one of the signatories to the EA
Multilateral Agreement for the recognition of calibration certificates

Accreditation No.: **SCS 108**

Client **UL CCS USA**

Certificate No: **EX3-3901_Feb13**

CALIBRATION CERTIFICATE

Object **EX3DV4 - SN:3901**

Calibration procedure(s) **QA CAL-01.v8, QA CAL-12.v7, QA CAL-14.v3, QA CAL-23.v4,
QA CAL-25.v4
Calibration procedure for dosimetric E-field probes**

Calibration date: **February 13, 2013**

This calibration certificate documents the traceability to national standards, which realize the physical units of measurements (SI).
The measurements and the uncertainties with confidence probability are given on the following pages and are part of the certificate.

All calibrations have been conducted in the closed laboratory facility: environment temperature (22 ± 3)°C and humidity < 70%.

Calibration Equipment used (M&TE critical for calibration)

Primary Standards	ID	Cal Date (Certificate No.)	Scheduled Calibration
Power meter E4419B	GB41293874	29-Mar-12 (No. 217-01508)	Apr-13
Power sensor E4412A	MY41498087	29-Mar-12 (No. 217-01508)	Apr-13
Reference 3 dB Attenuator	SN: S5054 (3c)	27-Mar-12 (No. 217-01531)	Apr-13
Reference 20 dB Attenuator	SN: S5086 (20b)	27-Mar-12 (No. 217-01529)	Apr-13
Reference 30 dB Attenuator	SN: S5129 (30b)	27-Mar-12 (No. 217-01532)	Apr-13
Reference Probe ES3DV2	SN: 3013	28-Dec-12 (No. ES3-3013_Dec12)	Dec-13
DAE4	SN: 660	31-Jan-13 (No. DAE4-660_Jan13)	Jan-13
Secondary Standards	ID	Check Date (in house)	Scheduled Check
RF generator HP 8648C	US3642U01700	4-Aug-99 (in house check Apr-11)	In house check: Apr-13
Network Analyzer HP 8753E	US37390585	18-Oct-01 (in house check Oct-12)	In house check: Oct-13

	Name	Function	Signature
Calibrated by:	Jeton Kastrati	Laboratory Technician	
Approved by:	Katja Pokovic	Technical Manager	

Issued: February 14, 2013

This calibration certificate shall not be reproduced except in full without written approval of the laboratory.



Accredited by the Swiss Accreditation Service (SAS)

Accreditation No.: **SCS 108**

The Swiss Accreditation Service is one of the signatories to the EA Multilateral Agreement for the recognition of calibration certificates

Glossary:

TSL	tissue simulating liquid
NORM _{x,y,z}	sensitivity in free space
ConvF	sensitivity in TSL / NORM _{x,y,z}
DCP	diode compression point
CF	crest factor (1/duty_cycle) of the RF signal
A, B, C, D	modulation dependent linearization parameters
Polarization φ	φ rotation around probe axis
Polarization ϑ	ϑ rotation around an axis that is in the plane normal to probe axis (at measurement center), i.e., $\vartheta = 0$ is normal to probe axis

Calibration is Performed According to the Following Standards:

- IEEE Std 1528-2003, "IEEE Recommended Practice for Determining the Peak Spatial-Averaged Specific Absorption Rate (SAR) in the Human Head from Wireless Communications Devices: Measurement Techniques", December 2003
- IEC 62209-1, "Procedure to measure the Specific Absorption Rate (SAR) for hand-held devices used in close proximity to the ear (frequency range of 300 MHz to 3 GHz)", February 2005

Methods Applied and Interpretation of Parameters:

- NORM_{x,y,z}**: Assessed for E-field polarization $\vartheta = 0$ ($f \leq 900$ MHz in TEM-cell; $f > 1800$ MHz: R22 waveguide). NORM_{x,y,z} are only intermediate values, i.e., the uncertainties of NORM_{x,y,z} does not affect the E^2 -field uncertainty inside TSL (see below *ConvF*).
- NORM(f)_{x,y,z}** = NORM_{x,y,z} * *frequency_response* (see Frequency Response Chart). This linearization is implemented in DASY4 software versions later than 4.2. The uncertainty of the frequency response is included in the stated uncertainty of *ConvF*.
- DCP_{x,y,z}**: DCP are numerical linearization parameters assessed based on the data of power sweep with CW signal (no uncertainty required). DCP does not depend on frequency nor media.
- PAR**: PAR is the Peak to Average Ratio that is not calibrated but determined based on the signal characteristics
- A_{x,y,z}; B_{x,y,z}; C_{x,y,z}; D_{x,y,z}; VR_{x,y,z}**: A, B, C, D are numerical linearization parameters assessed based on the data of power sweep for specific modulation signal. The parameters do not depend on frequency nor media. VR is the maximum calibration range expressed in RMS voltage across the diode.
- ConvF and Boundary Effect Parameters**: Assessed in flat phantom using E-field (or Temperature Transfer Standard for $f \leq 800$ MHz) and inside waveguide using analytical field distributions based on power measurements for $f > 800$ MHz. The same setups are used for assessment of the parameters applied for boundary compensation (alpha, depth) of which typical uncertainty values are given. These parameters are used in DASY4 software to improve probe accuracy close to the boundary. The sensitivity in TSL corresponds to NORM_{x,y,z} * *ConvF* whereby the uncertainty corresponds to that given for *ConvF*. A frequency dependent *ConvF* is used in DASY version 4.4 and higher which allows extending the validity from ± 50 MHz to ± 100 MHz.
- Spherical isotropy (3D deviation from isotropy)**: in a field of low gradients realized using a flat phantom exposed by a patch antenna.
- Sensor Offset**: The sensor offset corresponds to the offset of virtual measurement center from the probe tip (on probe axis). No tolerance required.

Probe EX3DV4

SN:3901

Manufactured: October 9, 2012
Calibrated: February 13, 2013

Calibrated for DASY/EASY Systems
(Note: non-compatible with DASY2 system!)

DASY/EASY - Parameters of Probe: EX3DV4 - SN:3901

Basic Calibration Parameters

	Sensor X	Sensor Y	Sensor Z	Unc (k=2)
Norm ($\mu\text{V}/(\text{V}/\text{m})^2$) ^A	0.42	0.41	0.40	$\pm 10.1 \%$
DCP (mV) ^B	96.5	103.2	107.8	

Modulation Calibration Parameters

UID	Communication System Name		A dB	B dB $\sqrt{\mu\text{V}}$	C	D dB	VR mV	Unc ^E (k=2)
0	CW	X	0.0	0.0	1.0	0.00	151.0	$\pm 2.7 \%$
		Y	0.0	0.0	1.0		144.1	
		Z	0.0	0.0	1.0		144.0	

The reported uncertainty of measurement is stated as the standard uncertainty of measurement multiplied by the coverage factor $k=2$, which for a normal distribution corresponds to a coverage probability of approximately 95%.

^A The uncertainties of NormX,Y,Z do not affect the E^2 -field uncertainty inside TSL (see Pages 5 and 6).

^B Numerical linearization parameter: uncertainty not required.

^E Uncertainty is determined using the max. deviation from linear response applying rectangular distribution and is expressed for the square of the field value.

DASY/EASY - Parameters of Probe: EX3DV4 - SN:3901

Calibration Parameter Determined in Head Tissue Simulating Media

f (MHz) ^C	Relative Permittivity ^F	Conductivity (S/m) ^F	ConvF X	ConvF Y	ConvF Z	Alpha	Depth (mm)	Unct. (k=2)
450	43.5	0.87	10.74	10.74	10.74	0.13	1.48	± 13.4 %
750	41.9	0.89	10.48	10.48	10.48	0.62	0.70	± 12.0 %
835	41.5	0.90	9.98	9.98	9.98	0.80	0.50	± 12.0 %
900	41.5	0.97	9.89	9.89	9.89	0.39	0.79	± 12.0 %
1450	40.5	1.20	9.01	9.01	9.01	0.28	1.18	± 12.0 %
1640	40.3	1.29	8.47	8.47	8.47	0.80	0.57	± 12.0 %
1750	40.1	1.37	8.25	8.25	8.25	0.47	0.74	± 12.0 %
1900	40.0	1.40	8.03	8.03	8.03	0.44	0.76	± 12.0 %
1950	40.0	1.40	7.80	7.80	7.80	0.31	0.93	± 12.0 %
2000	40.0	1.40	8.05	8.05	8.05	0.56	0.69	± 12.0 %
2300	39.5	1.67	7.64	7.64	7.64	0.62	0.66	± 12.0 %
2450	39.2	1.80	7.32	7.32	7.32	0.34	0.90	± 12.0 %
2600	39.0	1.96	7.02	7.02	7.02	0.39	0.87	± 12.0 %
3500	37.9	2.91	6.66	6.66	6.66	0.36	1.12	± 13.1 %
3700	37.7	3.12	6.10	6.10	6.10	0.54	0.86	± 13.1 %
4950	36.3	4.40	5.25	5.25	5.25	0.31	1.80	± 13.1 %
5200	36.0	4.66	4.93	4.93	4.93	0.32	1.80	± 13.1 %
5300	35.9	4.76	4.71	4.71	4.71	0.32	1.80	± 13.1 %
5500	35.6	4.96	4.62	4.62	4.62	0.42	1.80	± 13.1 %
5600	35.5	5.07	4.64	4.64	4.64	0.30	1.80	± 13.1 %
5800	35.3	5.27	4.12	4.12	4.12	0.50	1.80	± 13.1 %

^C Frequency validity of ± 100 MHz only applies for DASY v4.4 and higher (see Page 2), else it is restricted to ± 50 MHz. The uncertainty is the RSS of the ConvF uncertainty at calibration frequency and the uncertainty for the indicated frequency band.

^F At frequencies below 3 GHz, the validity of tissue parameters (ϵ and σ) can be relaxed to ± 10% if liquid compensation formula is applied to measured SAR values. At frequencies above 3 GHz, the validity of tissue parameters (ϵ and σ) is restricted to ± 5%. The uncertainty is the RSS of the ConvF uncertainty for indicated target tissue parameters.

DASY/EASY - Parameters of Probe: EX3DV4 - SN:3901

Calibration Parameter Determined in Body Tissue Simulating Media

f (MHz) ^C	Relative Permittivity ^F	Conductivity (S/m) ^F	ConvF X	ConvF Y	ConvF Z	Alpha	Depth (mm)	Unct. (k=2)
450	56.7	0.94	11.40	11.40	11.40	0.07	1.00	± 13.4 %
750	55.5	0.96	10.04	10.04	10.04	0.80	0.61	± 12.0 %
835	55.2	0.97	9.82	9.82	9.82	0.37	0.91	± 12.0 %
900	55.0	1.05	9.69	9.69	9.69	0.80	0.59	± 12.0 %
1450	54.0	1.30	8.82	8.82	8.82	0.73	0.62	± 12.0 %
1640	53.8	1.40	8.67	8.67	8.67	0.41	0.84	± 12.0 %
1750	53.4	1.49	8.00	8.00	8.00	0.49	0.78	± 12.0 %
1900	53.3	1.52	7.73	7.73	7.73	0.27	1.06	± 12.0 %
1950	53.3	1.52	7.90	7.90	7.90	0.42	0.84	± 12.0 %
2000	53.3	1.52	7.86	7.86	7.86	0.34	0.90	± 12.0 %
2300	52.9	1.81	7.53	7.53	7.53	0.57	0.67	± 12.0 %
2450	52.7	1.95	7.35	7.35	7.35	0.80	0.56	± 12.0 %
2600	52.5	2.16	7.01	7.01	7.01	0.80	0.50	± 12.0 %
3500	51.3	3.31	6.26	6.26	6.26	0.33	1.30	± 13.1 %
3700	51.0	3.55	6.42	6.42	6.42	0.31	1.37	± 13.1 %
4950	49.4	5.01	4.47	4.47	4.47	0.43	1.90	± 13.1 %
5200	49.0	5.30	4.32	4.32	4.32	0.48	1.90	± 13.1 %
5300	48.9	5.42	3.98	3.98	3.98	0.57	1.90	± 13.1 %
5500	48.6	5.65	3.68	3.68	3.68	0.60	1.90	± 13.1 %
5600	48.5	5.77	3.53	3.53	3.53	0.60	1.90	± 13.1 %
5800	48.2	6.00	3.81	3.81	3.81	0.60	1.90	± 13.1 %

^C Frequency validity of ± 100 MHz only applies for DASY v4.4 and higher (see Page 2), else it is restricted to ± 50 MHz. The uncertainty is the RSS of the ConvF uncertainty at calibration frequency and the uncertainty for the indicated frequency band.

^F At frequencies below 3 GHz, the validity of tissue parameters (ϵ and σ) can be relaxed to ± 10% if liquid compensation formula is applied to measured SAR values. At frequencies above 3 GHz, the validity of tissue parameters (ϵ and σ) is restricted to ± 5%. The uncertainty is the RSS of the ConvF uncertainty for indicated target tissue parameters.

Frequency Response of E-Field

(TEM-Cell:ifi110 EXX, Waveguide: R22)

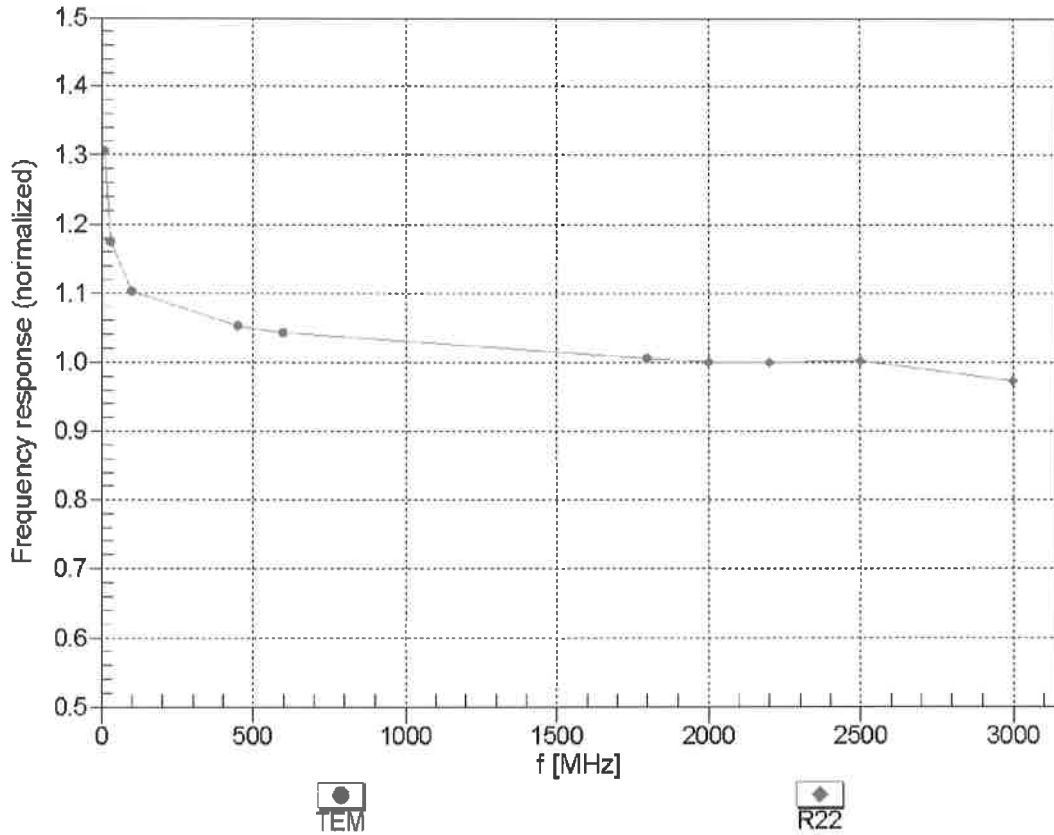

Uncertainty of Frequency Response of E-field: $\pm 6.3\%$ (k=2)

Receiving Pattern (ϕ), $\vartheta = 0^\circ$

f=600 MHz,TEM

f=1800 MHz,R22

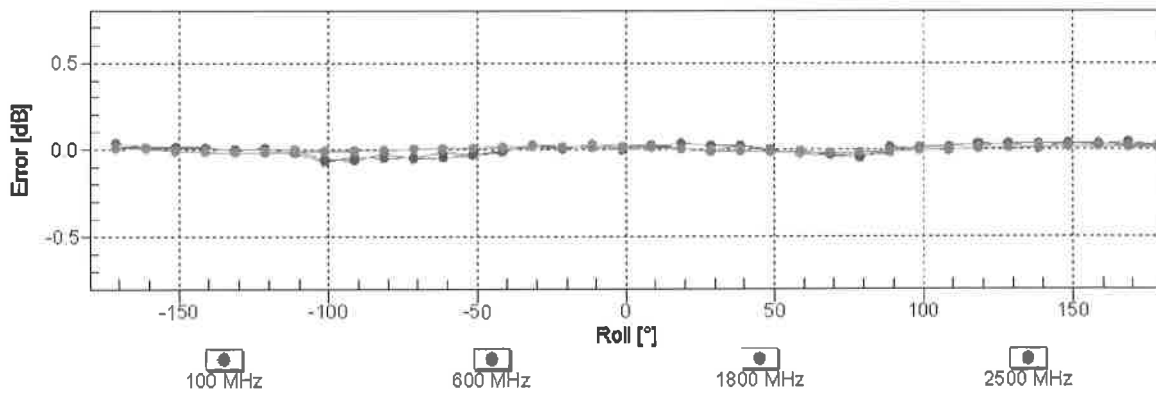
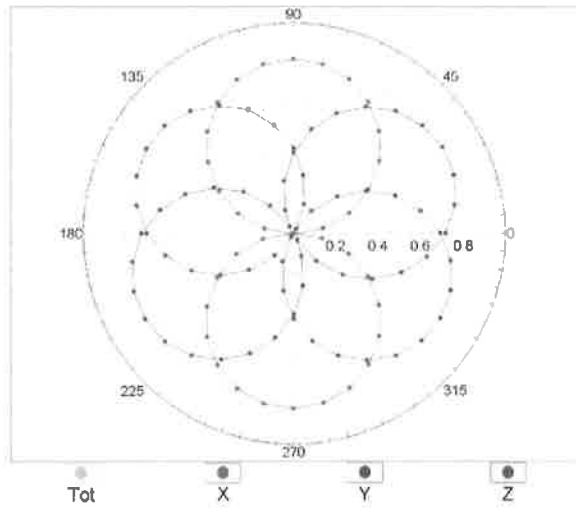
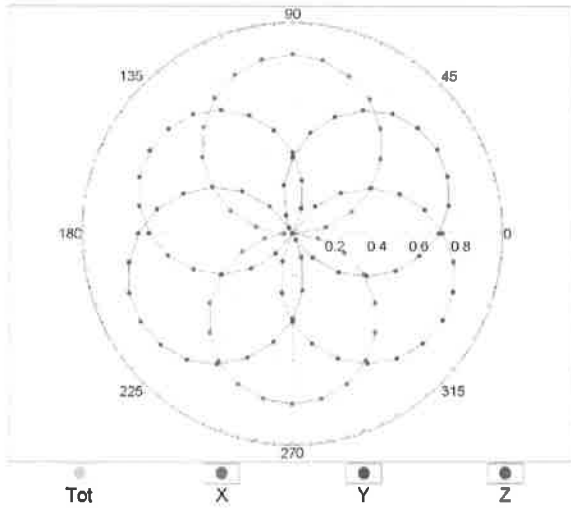

Uncertainty of Axial Isotropy Assessment: $\pm 0.5\%$ (k=2)

Dynamic Range f(SAR_{head}) (TEM cell , f = 900 MHz)

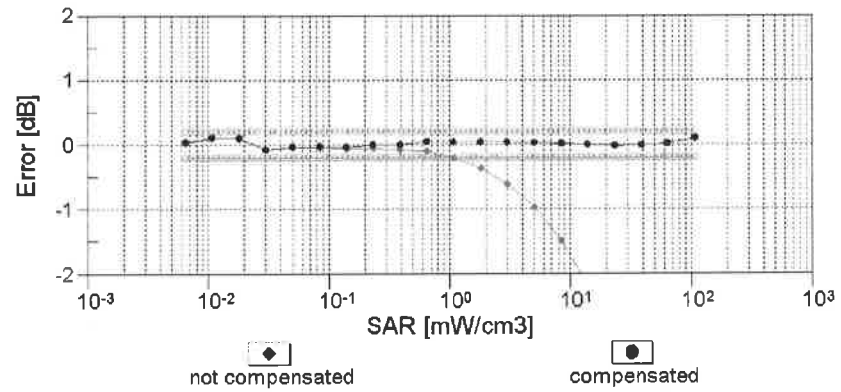
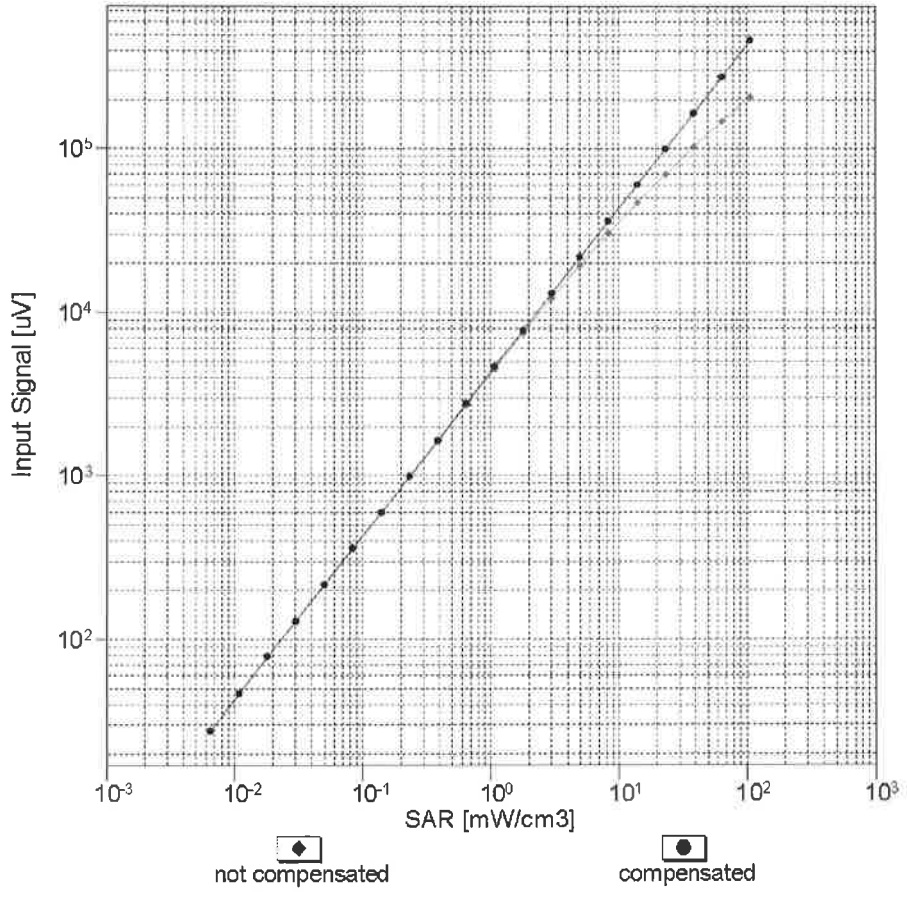

Uncertainty of Linearity Assessment: ± 0.6% (k=2)

Conversion Factor Assessment

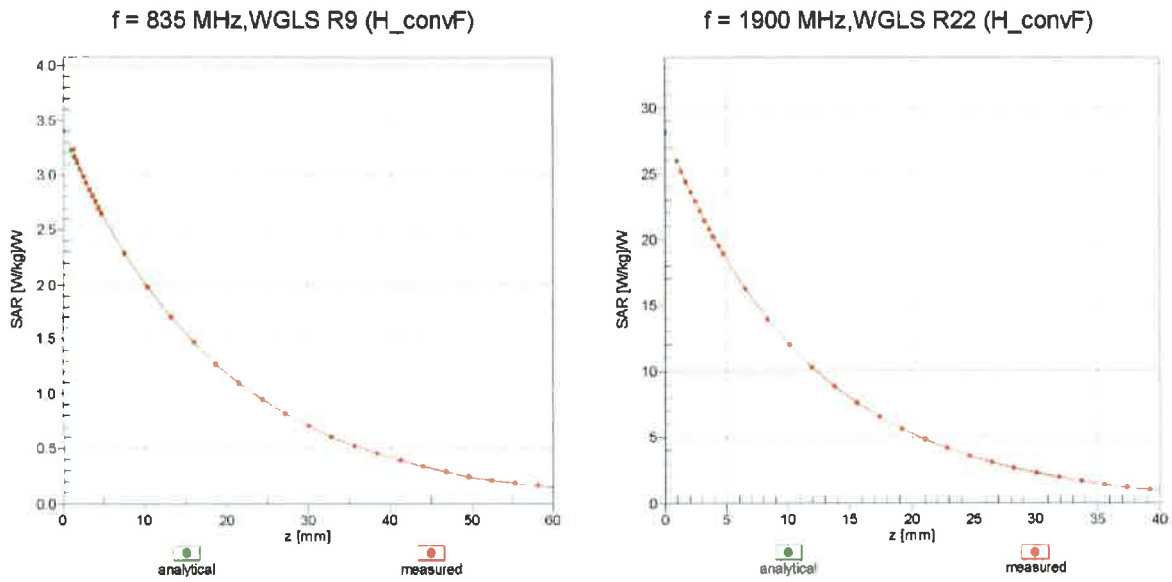

Deviation from Isotropy in Liquid Error (ϕ, ϑ), f = 900 MHz

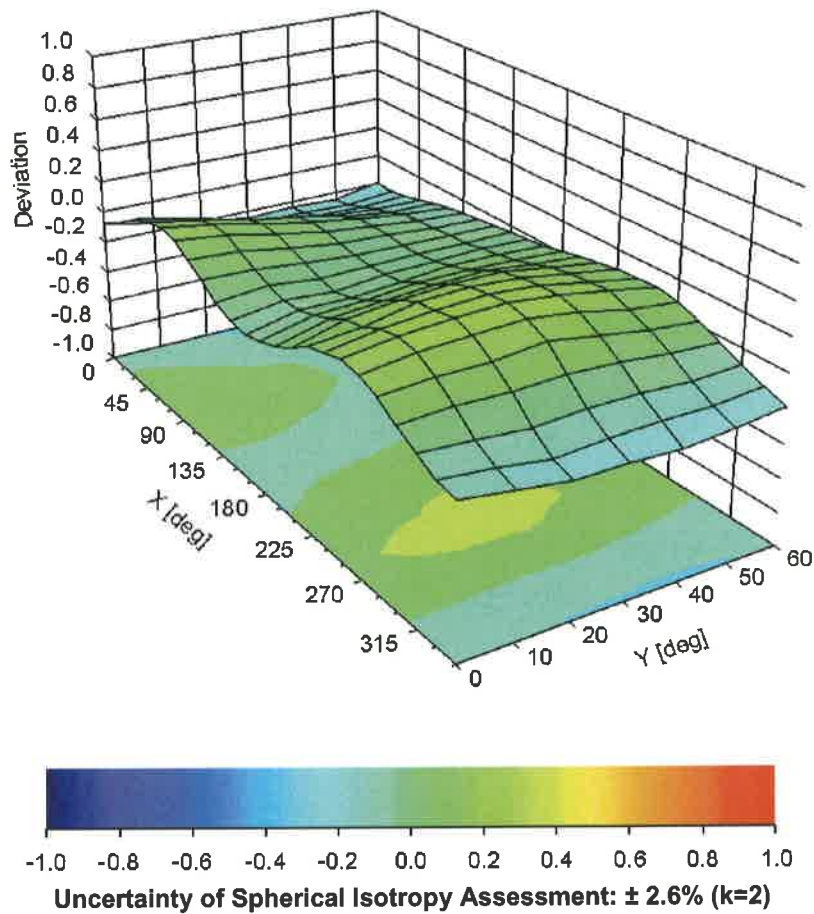

DASY/EASY - Parameters of Probe: EX3DV4 - SN:3901

Other Probe Parameters

Sensor Arrangement	Triangular
Connector Angle (°)	8.7
Mechanical Surface Detection Mode	enabled
Optical Surface Detection Mode	disabled
Probe Overall Length	337 mm
Probe Body Diameter	10 mm
Tip Length	9 mm
Tip Diameter	2.5 mm
Probe Tip to Sensor X Calibration Point	1 mm
Probe Tip to Sensor Y Calibration Point	1 mm
Probe Tip to Sensor Z Calibration Point	1 mm
Recommended Measurement Distance from Surface	2 mm



Accredited by the Swiss Accreditation Service (SAS)
The Swiss Accreditation Service is one of the signatories to the EA
Multilateral Agreement for the recognition of calibration certificates

Accreditation No.: **SCS 108**

Client **UL CCS USA**

Certificate No: **EX3-3885_Oct12**

CALIBRATION CERTIFICATE

Object **EX3DV4 - SN:3885**

Calibration procedure(s) **QA CAL-01.v8, QA CAL-12.v7, QA CAL-14.v3, QA CAL-23.v4,
QA CAL-25.v4
Calibration procedure for dosimetric E-field probes**

Calibration date: **October 9, 2012**

This calibration certificate documents the traceability to national standards, which realize the physical units of measurements (SI).
The measurements and the uncertainties with confidence probability are given on the following pages and are part of the certificate.

All calibrations have been conducted in the closed laboratory facility: environment temperature (22 ± 3)°C and humidity < 70%.

Calibration Equipment used (M&TE critical for calibration)

Primary Standards	ID	Cal Date (Certificate No.)	Scheduled Calibration
Power meter E4419B	GB41293874	29-Mar-12 (No. 217-01508)	Apr-13
Power sensor E4412A	MY41498087	29-Mar-12 (No. 217-01508)	Apr-13
Reference 3 dB Attenuator	SN: S5054 (3c)	27-Mar-12 (No. 217-01531)	Apr-13
Reference 20 dB Attenuator	SN: S5086 (20b)	27-Mar-12 (No. 217-01529)	Apr-13
Reference 30 dB Attenuator	SN: S5129 (30b)	27-Mar-12 (No. 217-01532)	Apr-13
Reference Probe ES3DV2	SN: 3013	29-Dec-11 (No. ES3-3013_Dec11)	Dec-12
DAE4	SN: 660	20-Jun-12 (No. DAE4-660_Jun12)	Jun-13
Secondary Standards	ID	Check Date (in house)	Scheduled Check
RF generator HP 8648C	US3642U01700	4-Aug-99 (in house check Apr-11)	In house check: Apr-13
Network Analyzer HP 8753E	US37390585	18-Oct-01 (in house check Oct-11)	In house check: Oct-12

	Name	Function	Signature
Calibrated by:	Jeton Kastrati	Laboratory Technician	
Approved by:	Katja Pokovic	Technical Manager	

Issued: October 9, 2012

This calibration certificate shall not be reproduced except in full without written approval of the laboratory.



Accredited by the Swiss Accreditation Service (SAS)

Accreditation No.: **SCS 108**

The Swiss Accreditation Service is one of the signatories to the EA
Multilateral Agreement for the recognition of calibration certificates

Glossary:

TSL	tissue simulating liquid
NORM _{x,y,z}	sensitivity in free space
ConvF	sensitivity in TSL / NORM _{x,y,z}
DCP	diode compression point
CF	crest factor (1/duty_cycle) of the RF signal
A, B, C	modulation dependent linearization parameters
Polarization ϕ	ϕ rotation around probe axis
Polarization ϑ	ϑ rotation around an axis that is in the plane normal to probe axis (at measurement center), i.e., $\vartheta = 0$ is normal to probe axis

Calibration is Performed According to the Following Standards:

- IEEE Std 1528-2003, "IEEE Recommended Practice for Determining the Peak Spatial-Averaged Specific Absorption Rate (SAR) in the Human Head from Wireless Communications Devices: Measurement Techniques", December 2003
- IEC 62209-1, "Procedure to measure the Specific Absorption Rate (SAR) for hand-held devices used in close proximity to the ear (frequency range of 300 MHz to 3 GHz)", February 2005

Methods Applied and Interpretation of Parameters:

- NORM_{x,y,z}**: Assessed for E-field polarization $\vartheta = 0$ ($f \leq 900$ MHz in TEM-cell; $f > 1800$ MHz: R22 waveguide). NORM_{x,y,z} are only intermediate values, i.e., the uncertainties of NORM_{x,y,z} does not affect the E²-field uncertainty inside TSL (see below ConvF).
- NORM(f)_{x,y,z} = NORM_{x,y,z} * frequency_response** (see Frequency Response Chart). This linearization is implemented in DASY4 software versions later than 4.2. The uncertainty of the frequency response is included in the stated uncertainty of ConvF.
- DCP_{x,y,z}**: DCP are numerical linearization parameters assessed based on the data of power sweep with CW signal (no uncertainty required). DCP does not depend on frequency nor media.
- PAR**: PAR is the Peak to Average Ratio that is not calibrated but determined based on the signal characteristics
- A_{x,y,z}; B_{x,y,z}; C_{x,y,z}; VR_{x,y,z}**: A, B, C are numerical linearization parameters assessed based on the data of power sweep for specific modulation signal. The parameters do not depend on frequency nor media. VR is the maximum calibration range expressed in RMS voltage across the diode.
- ConvF and Boundary Effect Parameters**: Assessed in flat phantom using E-field (or Temperature Transfer Standard for $f \leq 800$ MHz) and inside waveguide using analytical field distributions based on power measurements for $f > 800$ MHz. The same setups are used for assessment of the parameters applied for boundary compensation (alpha, depth) of which typical uncertainty values are given. These parameters are used in DASY4 software to improve probe accuracy close to the boundary. The sensitivity in TSL corresponds to NORM_{x,y,z} * ConvF whereby the uncertainty corresponds to that given for ConvF. A frequency dependent ConvF is used in DASY version 4.4 and higher which allows extending the validity from ± 50 MHz to ± 100 MHz.
- Spherical isotropy (3D deviation from isotropy)**: in a field of low gradients realized using a flat phantom exposed by a patch antenna.
- Sensor Offset**: The sensor offset corresponds to the offset of virtual measurement center from the probe tip (on probe axis). No tolerance required.

Probe EX3DV4

SN:3885

Manufactured: April 30, 2012
Calibrated: October 9, 2012

Calibrated for DASY/EASY Systems
(Note: non-compatible with DASY2 system!)

DASY/EASY - Parameters of Probe: EX3DV4 - SN:3885

Basic Calibration Parameters

	Sensor X	Sensor Y	Sensor Z	Unc (k=2)
Norm ($\mu\text{V}/(\text{V}/\text{m})^2$) ^A	0.42	0.41	0.28	$\pm 10.1\%$
DCP (mV) ^B	105.3	98.0	103.4	

Modulation Calibration Parameters

UID	Communication System Name	PAR		A dB	B dB	C dB	VR mV	Unc ^E (k=2)
0	CW	0.00	X	0.00	0.00	1.00	145.5	$\pm 3.0\%$
			Y	0.00	0.00	1.00	142.6	
			Z	0.00	0.00	1.00	151.1	

The reported uncertainty of measurement is stated as the standard uncertainty of measurement multiplied by the coverage factor k=2, which for a normal distribution corresponds to a coverage probability of approximately 95%.

^A The uncertainties of NormX,Y,Z do not affect the E²-field uncertainty inside TSL (see Pages 5 and 6).

^B Numerical linearization parameter: uncertainty not required.

^E Uncertainty is determined using the max. deviation from linear response applying rectangular distribution and is expressed for the square of the field value.

DASY/EASY - Parameters of Probe: EX3DV4 - SN:3885

Calibration Parameter Determined in Head Tissue Simulating Media

f (MHz) ^C	Relative Permittivity ^F	Conductivity (S/m) ^F	ConvF X	ConvF Y	ConvF Z	Alpha	Depth (mm)	Unct. (k=2)
450	43.5	0.87	9.85	9.85	9.85	0.12	1.10	± 13.4 %
750	41.9	0.89	9.68	9.68	9.68	0.80	0.50	± 12.0 %
835	41.5	0.90	9.35	9.35	9.35	0.80	0.50	± 12.0 %
900	41.5	0.97	9.16	9.16	9.16	0.51	0.67	± 12.0 %
1450	40.5	1.20	8.19	8.19	8.19	0.52	0.75	± 12.0 %
1640	40.3	1.29	8.19	8.19	8.19	0.65	0.62	± 12.0 %
1750	40.1	1.37	7.98	7.98	7.98	0.67	0.60	± 12.0 %
1900	40.0	1.40	7.66	7.66	7.66	0.80	0.58	± 12.0 %
1950	40.0	1.40	7.44	7.44	7.44	0.45	0.73	± 12.0 %
2000	40.0	1.40	7.62	7.62	7.62	0.74	0.60	± 12.0 %
2300	39.5	1.67	7.34	7.34	7.34	0.61	0.65	± 12.0 %
2450	39.2	1.80	6.97	6.97	6.97	0.41	0.81	± 12.0 %
2600	39.0	1.96	6.80	6.80	6.80	0.43	0.80	± 12.0 %
3500	37.9	2.91	6.81	6.81	6.81	0.76	0.63	± 13.1 %
3700	37.7	3.12	6.36	6.36	6.36	0.45	0.83	± 13.1 %
4950	36.3	4.40	5.18	5.18	5.18	0.35	1.80	± 13.1 %
5200	36.0	4.66	4.99	4.99	4.99	0.35	1.80	± 13.1 %
5300	35.9	4.76	4.91	4.91	4.91	0.30	1.80	± 13.1 %
5500	35.6	4.96	4.85	4.85	4.85	0.40	1.80	± 13.1 %
5600	35.5	5.07	4.67	4.67	4.67	0.40	1.80	± 13.1 %
5800	35.3	5.27	4.34	4.34	4.34	0.55	1.80	± 13.1 %

^C Frequency validity of ± 100 MHz only applies for DASY v4.4 and higher (see Page 2), else it is restricted to ± 50 MHz. The uncertainty is the RSS of the ConvF uncertainty at calibration frequency and the uncertainty for the indicated frequency band.

^F At frequencies below 3 GHz, the validity of tissue parameters (ϵ and σ) can be relaxed to ± 10% if liquid compensation formula is applied to measured SAR values. At frequencies above 3 GHz, the validity of tissue parameters (ϵ and σ) is restricted to ± 5%. The uncertainty is the RSS of the ConvF uncertainty for indicated target tissue parameters.

DASY/EASY - Parameters of Probe: EX3DV4 - SN:3885

Calibration Parameter Determined in Body Tissue Simulating Media

f (MHz) ^C	Relative Permittivity ^F	Conductivity (S/m) ^F	ConvF X	ConvF Y	ConvF Z	Alpha	Depth (mm)	Unct. (k=2)
450	56.7	0.94	10.62	10.62	10.62	0.05	1.10	± 13.4 %
750	55.5	0.96	9.50	9.50	9.50	0.43	0.80	± 12.0 %
835	55.2	0.97	9.36	9.36	9.36	0.80	0.59	± 12.0 %
900	55.0	1.05	9.19	9.19	9.19	0.55	0.71	± 12.0 %
1450	54.0	1.30	8.67	8.67	8.67	0.31	1.11	± 12.0 %
1640	53.8	1.40	8.78	8.78	8.78	0.48	0.84	± 12.0 %
1750	53.4	1.49	8.03	8.03	8.03	0.29	1.04	± 12.0 %
1900	53.3	1.52	7.67	7.67	7.67	0.38	0.93	± 12.0 %
1950	53.3	1.52	7.73	7.73	7.73	0.46	0.78	± 12.0 %
2000	53.3	1.52	7.60	7.60	7.60	0.22	1.13	± 12.0 %
2300	52.9	1.81	7.15	7.15	7.15	0.41	0.78	± 12.0 %
2450	52.7	1.95	6.80	6.80	6.80	0.80	0.50	± 12.0 %
2600	52.5	2.16	6.67	6.67	6.67	0.80	0.55	± 12.0 %
3500	51.3	3.31	6.49	6.49	6.49	1.00	0.44	± 13.1 %
3700	51.0	3.55	6.63	6.63	6.63	1.00	0.50	± 13.1 %
4950	49.4	5.01	4.62	4.62	4.62	0.40	1.90	± 13.1 %
5200	49.0	5.30	4.50	4.50	4.50	0.40	1.90	± 13.1 %
5300	48.9	5.42	4.28	4.28	4.28	0.50	1.90	± 13.1 %
5500	48.6	5.65	4.10	4.10	4.10	0.40	1.90	± 13.1 %
5600	48.5	5.77	4.26	4.26	4.26	0.30	1.90	± 13.1 %
5800	48.2	6.00	4.14	4.14	4.14	0.50	1.90	± 13.1 %

^C Frequency validity of ± 100 MHz only applies for DASY v4.4 and higher (see Page 2), else it is restricted to ± 50 MHz. The uncertainty is the RSS of the ConvF uncertainty at calibration frequency and the uncertainty for the indicated frequency band.

^F At frequencies below 3 GHz, the validity of tissue parameters (ϵ and σ) can be relaxed to ± 10% if liquid compensation formula is applied to measured SAR values. At frequencies above 3 GHz, the validity of tissue parameters (ϵ and σ) is restricted to ± 5%. The uncertainty is the RSS of the ConvF uncertainty for indicated target tissue parameters.

Frequency Response of E-Field

(TEM-Cell:ifi110 EXX, Waveguide: R22)

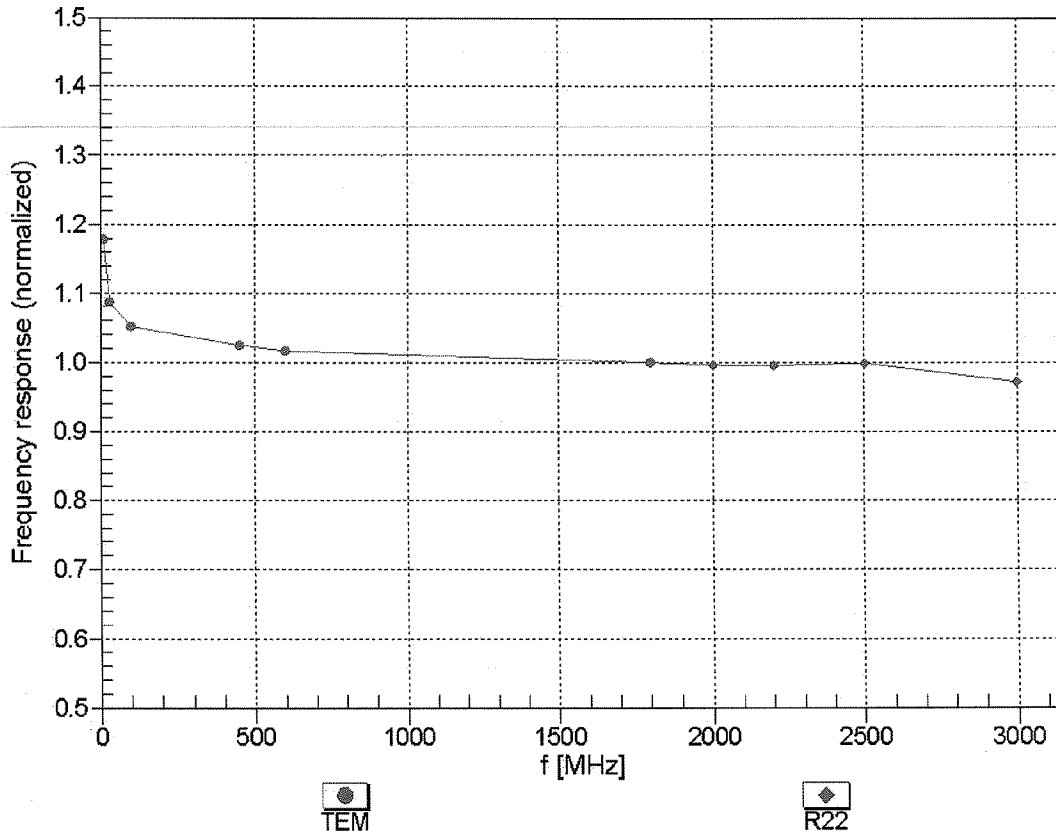

Uncertainty of Frequency Response of E-field: $\pm 6.3\%$ (k=2)

Receiving Pattern (ϕ), $\theta = 0^\circ$

f=600 MHz,TEM

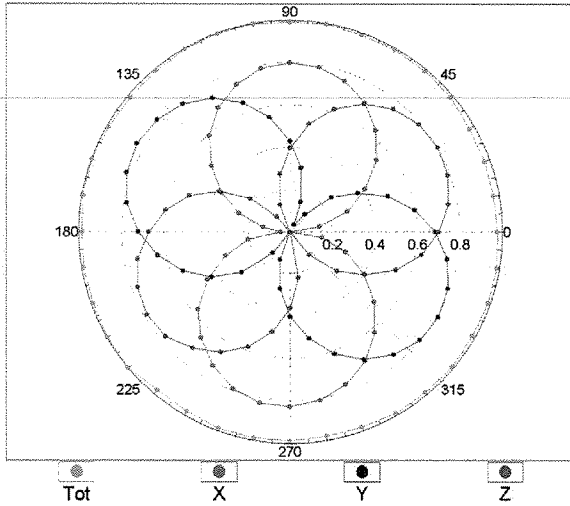

f=1800 MHz,R22

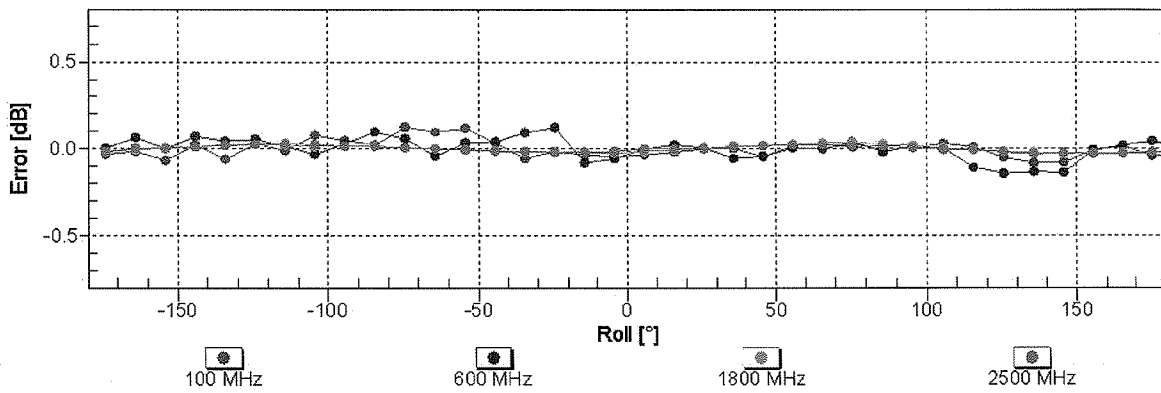
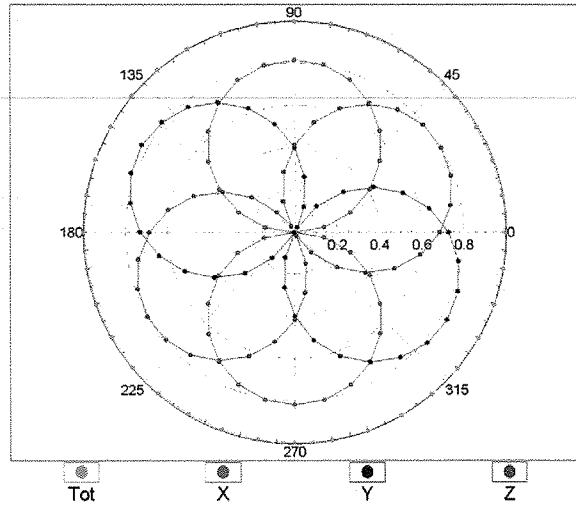

Uncertainty of Axial Isotropy Assessment: $\pm 0.5\%$ (k=2)

Dynamic Range $f(\text{SAR}_{\text{head}})$ (TEM cell , $f = 900 \text{ MHz}$)

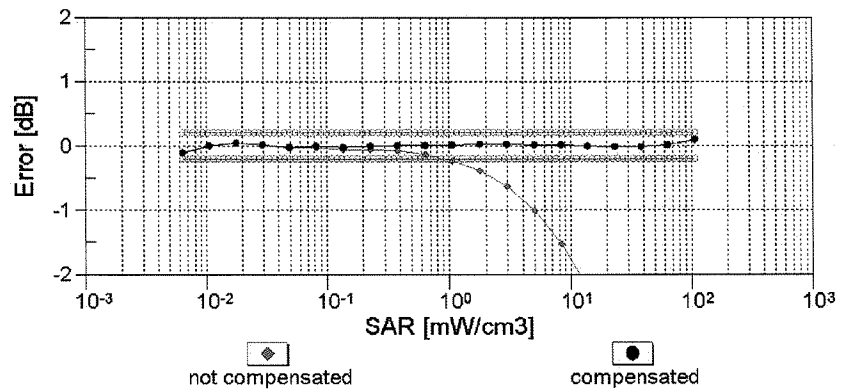
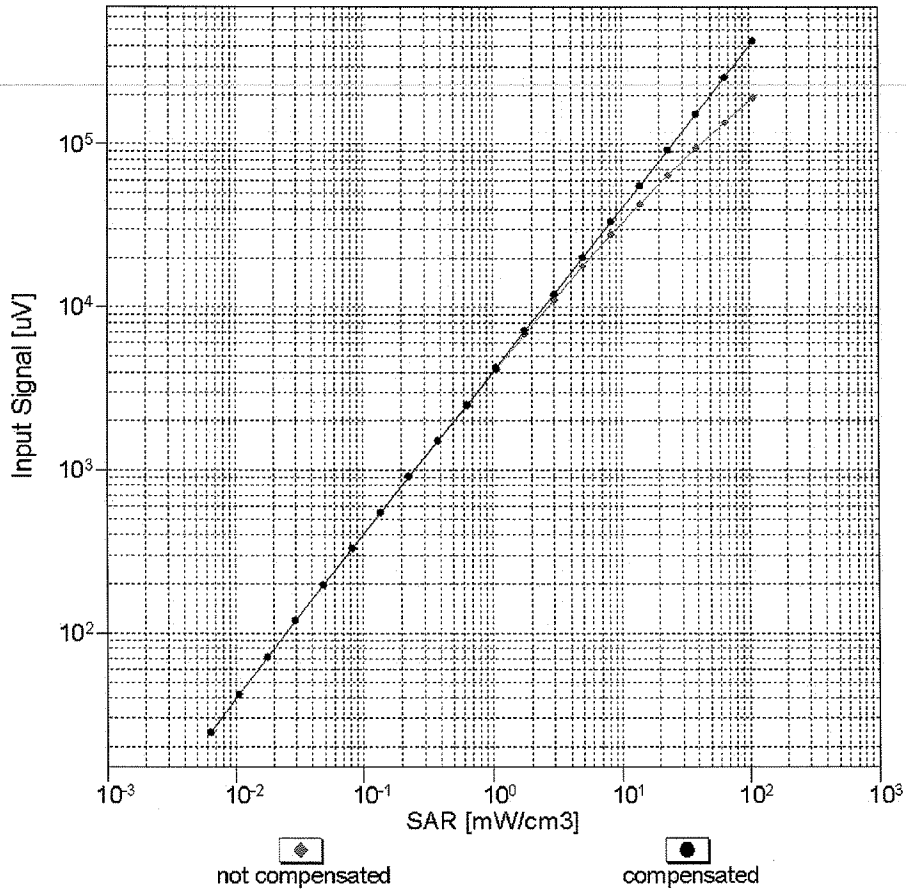

Uncertainty of Linearity Assessment: $\pm 0.6\%$ ($k=2$)

Conversion Factor Assessment

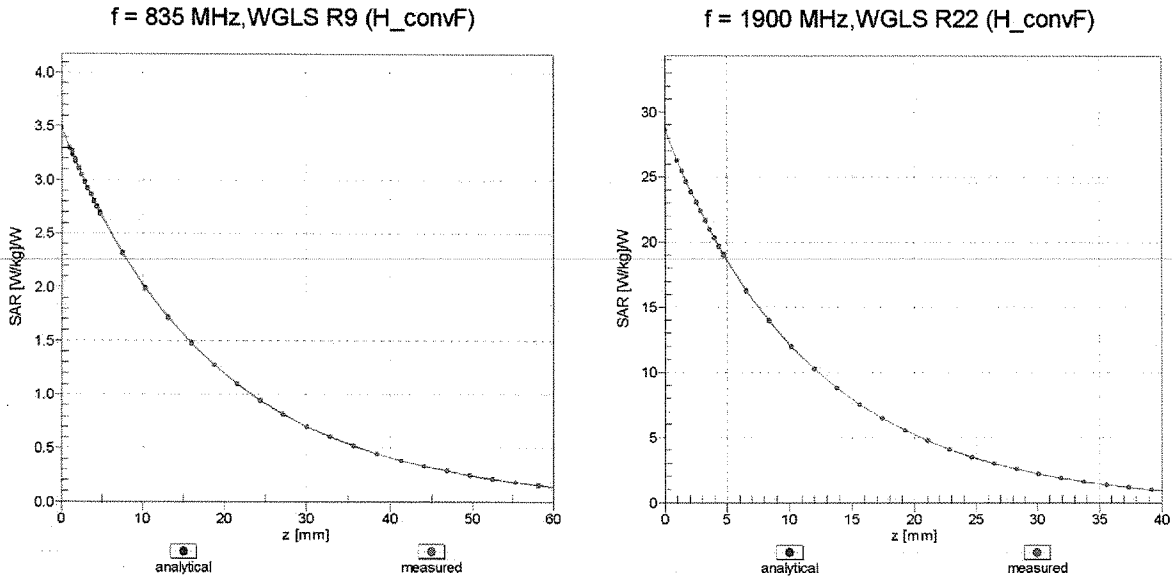

Deviation from Isotropy in Liquid Error (ϕ, θ), f = 900 MHz

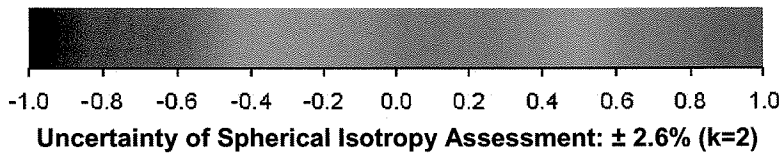
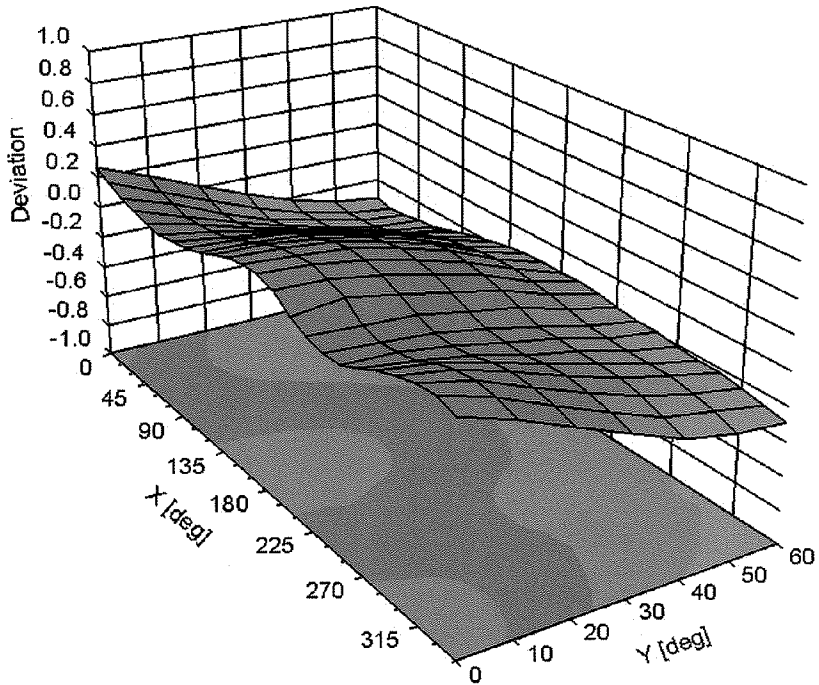

DASY/EASY - Parameters of Probe: EX3DV4 - SN:3885

Other Probe Parameters

Sensor Arrangement	Triangular
Connector Angle (°)	115.8
Mechanical Surface Detection Mode	enabled
Optical Surface Detection Mode	disabled
Probe Overall Length	337 mm
Probe Body Diameter	10 mm
Tip Length	9 mm
Tip Diameter	2.5 mm
Probe Tip to Sensor X Calibration Point	1 mm
Probe Tip to Sensor Y Calibration Point	1 mm
Probe Tip to Sensor Z Calibration Point	1 mm
Recommended Measurement Distance from Surface	2 mm