



**CFR47 PART 15 SUBPART C
INDUSTRY CANADA RSS-210 ISSUE 8**

CERTIFICATION TEST REPORT

FOR

QUAD-BAND RADIO WITH WLAN AND BT RADIO

Model: A1453 / A1533

FCC ID: BCG-E2642A

IC: 579C-E2642A

IC: 579C-E2642B

REPORT NUMBER: 13U14987-4

ISSUE DATE: JULY 22, 2013

Prepared for

APPLE, INC.

1 INFINITE LOOP

CUPERTINO, CA 95014, U.S.A.

UL VERIFICATION SERVICES INC.

47173 BENICIA STREET

FREMONT, CA 94538, U.S.A.

TEL: (510) 771-1000

FAX: (510) 661-0888



NVLAP LAB CODE 200065-0

TABLE OF CONTENTS

1. ATTESTATION OF TEST RESULTS	4
2. TEST METHODOLOGY	5
3. FACILITIES AND ACCREDITATION	5
4. CALIBRATION AND UNCERTAINTY	5
4.1. <i>MEASURING INSTRUMENT CALIBRATION</i>	<i>5</i>
4.2. <i>SAMPLE CALCULATION</i>	<i>5</i>
4.3. <i>MEASUREMENT UNCERTAINTY</i>	<i>5</i>
5. EQUIPMENT UNDER TEST	6
5.1. <i>DESCRIPTION OF EUT</i>	<i>6</i>
5.2. <i>MAXIMUM OUTPUT POWER.....</i>	<i>6</i>
5.3. <i>DESCRIPTION OF AVAILABLE ANTENNAS</i>	<i>6</i>
5.4. <i>SOFTWARE AND FIRMWARE.....</i>	<i>6</i>
5.5. <i>WORST-CASE CONFIGURATION AND MODE.....</i>	<i>6</i>
5.6. <i>DESCRIPTION OF TEST SETUP.....</i>	<i>7</i>
6. TEST AND MEASUREMENT EQUIPMENT	9
7. ANTENNA PORT TEST RESULTS	10
7.1. <i>20 dB AND 99% BANDWIDTH</i>	<i>10</i>
7.2. <i>HOPPING FREQUENCY SEPARATION</i>	<i>19</i>
7.3. <i>NUMBER OF HOPPING CHANNELS.....</i>	<i>21</i>
7.4. <i>AVERAGE TIME OF OCCUPANCY.....</i>	<i>27</i>
7.5. <i>OUTPUT POWER.....</i>	<i>35</i>
7.6. <i>AVERAGE POWER.....</i>	<i>40</i>
7.7. <i>CONDUCTED SPURIOUS EMISSIONS.....</i>	<i>41</i>
8. RADIATED TEST RESULTS.....	50
8.1. <i>LIMITS AND PROCEDURE</i>	<i>50</i>
8.2. <i>TRANSMITTER ABOVE 1 GHz</i>	<i>51</i>
8.2.1. <i>BASIC DATA RATE GFSK MODULATION</i>	<i>51</i>
8.2.2. <i>ENHANCED DATA RATE 8PSK MODULATION</i>	<i>60</i>
8.3. <i>WORST-CASE BELOW 1 GHz.....</i>	<i>68</i>
9. AC POWER LINE CONDUCTED EMISSIONS	71
10. SETUP PHOTOS	75

1. ATTESTATION OF TEST RESULTS

COMPANY NAME: APPLE, INC.
1 INFINITE LOOP
CUPERTINO, CA 95014, U.S.A.

EUT DESCRIPTION: QUAD-BAND RADIO WITH WLAN AND BT RADIO

MODEL: A1453 / A1533

SERIAL NUMBER: C39HV0HPF5P5 (Conducted), C7JKP0AEFLTW (Radiated)

DATE TESTED: MAY 22 - JUNE 9, 2013

APPLICABLE STANDARDS	
STANDARD	TEST RESULTS
CFR 47 Part 15 Subpart C	Pass
INDUSTRY CANADA RSS-210 Issue 8 Annex 8	Pass
INDUSTRY CANADA RSS-GEN Issue 3	Pass

UL Verification Services Inc. tested the above equipment in accordance with the requirements set forth in the above standards. All indications of Pass/Fail in this report are opinions expressed by UL CCS based on interpretations and/or observations of test results. Measurement Uncertainties were not taken into account and are published for informational purposes only. The test results show that the equipment tested is capable of demonstrating compliance with the requirements as documented in this report.

Note: The results documented in this report apply only to the tested sample, under the conditions and modes of operation as described herein. This document may not be altered or revised in any way unless done so by UL CCS and all revisions are duly noted in the revisions section. Any alteration of this document not carried out by UL CCS will constitute fraud and shall nullify the document. This report must not be used by the client to claim product certification, approval, or endorsement by NVLAP, NIST, any agency of the Federal Government, or any agency of any government.

Approved & Released For
UL Verification Services Inc. By:

Tested By:

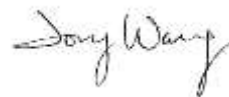

Thu Chan
WiSE Operations Manager
UL Verification Services Inc.

Tony Wang
WiSE Lab Technician
UL Verification Services Inc.

2. TEST METHODOLOGY

The tests documented in this report were performed in accordance with ANSI C63.10-2009, FCC CFR 47 Part 2, FCC CFR 47 Part 15, RSS-GEN Issue 3, and RSS-210 Issue 8.

3. FACILITIES AND ACCREDITATION

The test sites and measurement facilities used to collect data are located at 47173 Benicia Street, Fremont, California, USA.

UL Verification Services Inc. is accredited by NVLAP, Laboratory Code 200065-0. The full scope of accreditation can be viewed at <http://www.ccssemc.com>.

4. CALIBRATION AND UNCERTAINTY

4.1. MEASURING INSTRUMENT CALIBRATION

The measuring equipment utilized to perform the tests documented in this report has been calibrated in accordance with the manufacturer's recommendations, and is traceable to recognized national standards.

4.2. SAMPLE CALCULATION

Where relevant, the following sample calculation is provided:

$$\begin{aligned} \text{Field Strength (dBuV/m)} &= \text{Measured Voltage (dBuV)} + \text{Antenna Factor (dB/m)} + \\ &\text{Cable Loss (dB)} - \text{Preamp Gain (dB)} \\ 36.5 \text{ dBuV} + 18.7 \text{ dB/m} + 0.6 \text{ dB} - 26.9 \text{ dB} &= 28.9 \text{ dBuV/m} \end{aligned}$$

4.3. MEASUREMENT UNCERTAINTY

Where relevant, the following measurement uncertainty levels have been estimated for tests performed on the apparatus:

PARAMETER	UNCERTAINTY
Conducted Disturbance, 0.15 to 30 MHz	3.52 dB
Radiated Disturbance, 30 to 1000 MHz	4.94 dB

Uncertainty figures are valid to a confidence level of 95%.

5. EQUIPMENT UNDER TEST

5.1. DESCRIPTION OF EUT

Model A1453/A1533 is a mobile phone with multimedia functions (music, application support, and video), cellular GSM/GPRS/EGPRS/WCDMA/HSPA+/DC-HSDPA/CDMA/EVDO/LTE radio, IEEE 802.11a/b/g/n, Bluetooth and GPS radio. The rechargeable battery is not user accessible.

5.2. MAXIMUM OUTPUT POWER

The transmitter has a maximum peak conducted output power as follows:

Frequency Range (MHz)	Mode	Output Power (dBm)	Output Power (mW)
2402 - 2480	Basic GFSK	12.87	19.36
2402 - 2480	Enhanced 8PSK	12.69	18.58

5.3. DESCRIPTION OF AVAILABLE ANTENNAS

The radio utilizes a PiFA antenna, with a maximum gain as below table.

Frequency (MHz)	Antenna Gain (dBi)
2402 -2480	1.09

5.4. SOFTWARE AND FIRMWARE

The firmware installed in the EUT during testing was Bluetooth Version 1.4.8.7.

5.5. WORST-CASE CONFIGURATION AND MODE

For Radiated Emissions below 1 GHz and Power line Conducted Emissions, the channel with the highest conducted output power was selected as worst-case scenario.

EUT is a portable device that has three orientations; therefore, X (Lay down), Y (Landscape) and Z orientations (Standup) have been investigated, and the worst case was found to be at Y (Landscape) position.

5.6. DESCRIPTION OF TEST SETUP

SUPPORT EQUIPMENT

Support Equipment List			
Description	Manufacturer	Model	Serial Number
AC adapter	Apple	A1385	D292365D11QDHLHCA
Earphone	Apple	NA	NA

I/O CABLES (CONDUCTED)

I/O Cable List						
Cable No	Port	# of identical ports	Connector Type	Cable Type	Cable Length (m)	Remarks
1	Antenna	1	SMA	Shielded	0.1m	To Spectrum Analyzer

I/O CABLES (RADIATED)

I/O Cable List						
Cable No	Port	# of identical ports	Connector Type	Cable Type	Cable Length (m)	Remarks
1	Jack	1	Earphone	Unshielded	0.5m	N/A

TEST SETUP

The EUT is a stand-alone device.

SETUP DIAGRAM FOR TESTS (CONDUCTED)

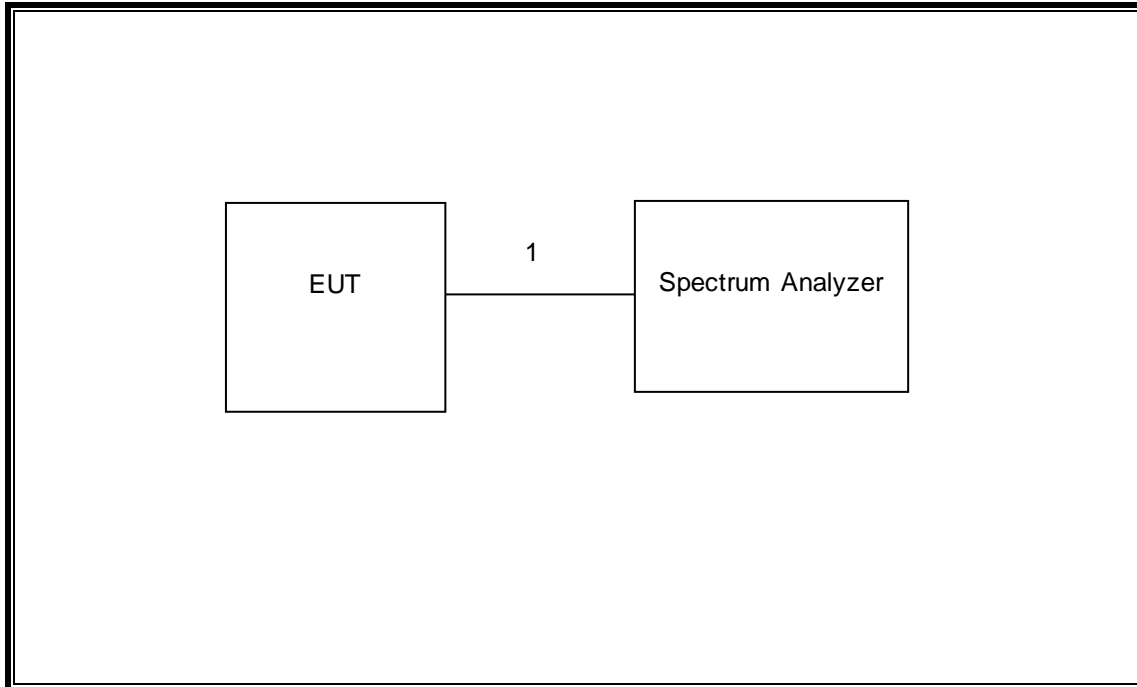

SETUP DIAGRAM FOR TESTS (RADIATED)

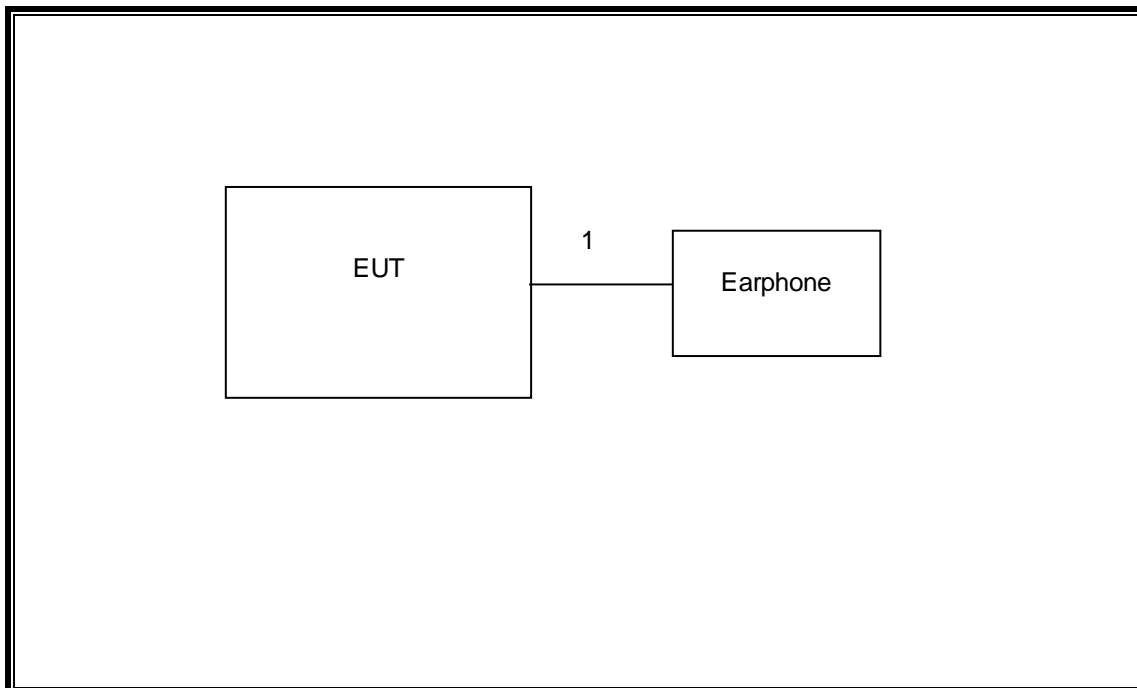

6. TEST AND MEASUREMENT EQUIPMENT

The following test and measurement equipment was utilized for the tests documented in this report:

TEST EQUIPMENT LIST				
Description	Manufacturer	Model	Asset	Cal Due
Spectrum Analyzer, 44 GHz	Agilent / HP	N9030A	F00127	02/22/14
Antenna, Horn, 18 GHz	ETS Lindgren	3117	F00132	02/19/14
Antenna, Horn, 26.5 GHz	ARA	MWH-1826/B	C00589	04/28/14
Antenna, Bilog, 2 GHz	Sunol Sciences	JB3	F00027	03/07/14
Preamplifier, 1300 MHz	Sonoma	310	981661	11/06/13
Preamplifier, 26.5 GHz	Agilent / HP	8449B	F00130	03/18/14
EMI Test Receiver, 9 kHz-7 GHz	R & S	ESCI 7	1000741	07/06/13
LISN, 30 MHz	FCC	LISN-50/250-25-2	N02625	04/17/14
Peak / Average Power Sensor	Agilent / HP	N1911A	F00153	04/05/14
Peak Power Meter	Agilent / HP	E9323A	F00026	04/03/14

7. ANTENNA PORT TEST RESULTS

7.1. 20 dB AND 99% BANDWIDTH

LIMIT

None; for reporting purposes only.

TEST PROCEDURE

The transmitter output is connected to a spectrum analyzer. The RBW is set to $\geq 1\%$ of the 20 dB bandwidth. The VBW is set to \geq RBW. The sweep time is coupled.

RESULTS

GFSK

Channel	Frequency (MHz)	20 dB Bandwidth (KHz)	99% Bandwidth (KHz)
Low	2402	1011.000	946.5324
Middle	2441	991.324	961.3418
High	2480	986.317	939.7444

8PSK

Channel	Frequency (MHz)	20 dB Bandwidth (MHz)	99% Bandwidth (MHz)
Low	2402	1.351	1.6678
Middle	2441	1.345	1.3577
High	2480	1.339	1.3200

GFSK

20 dB BANDWIDTH

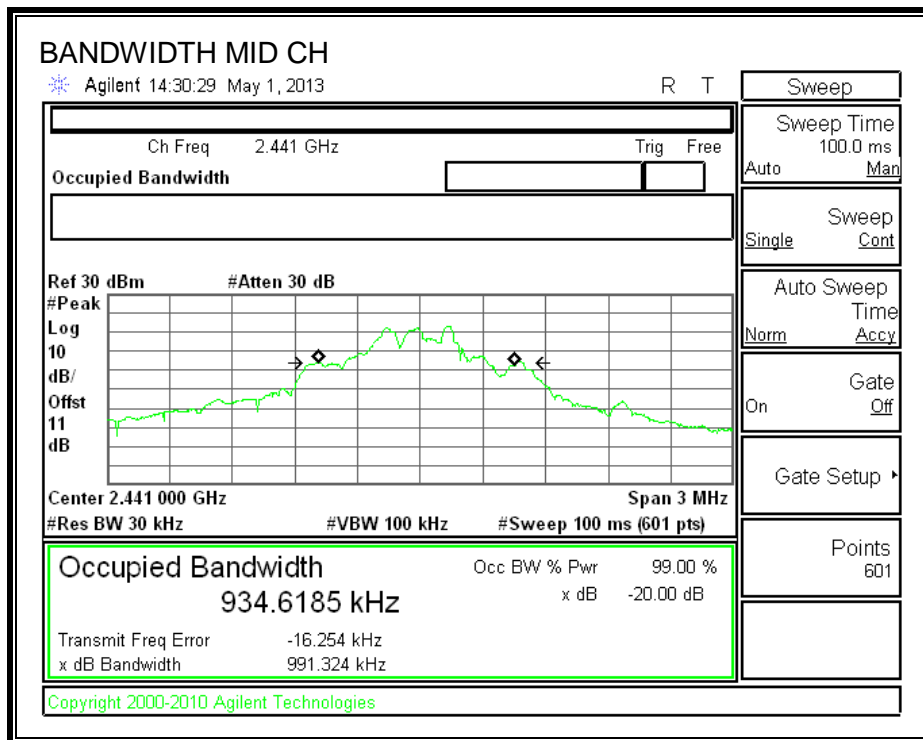
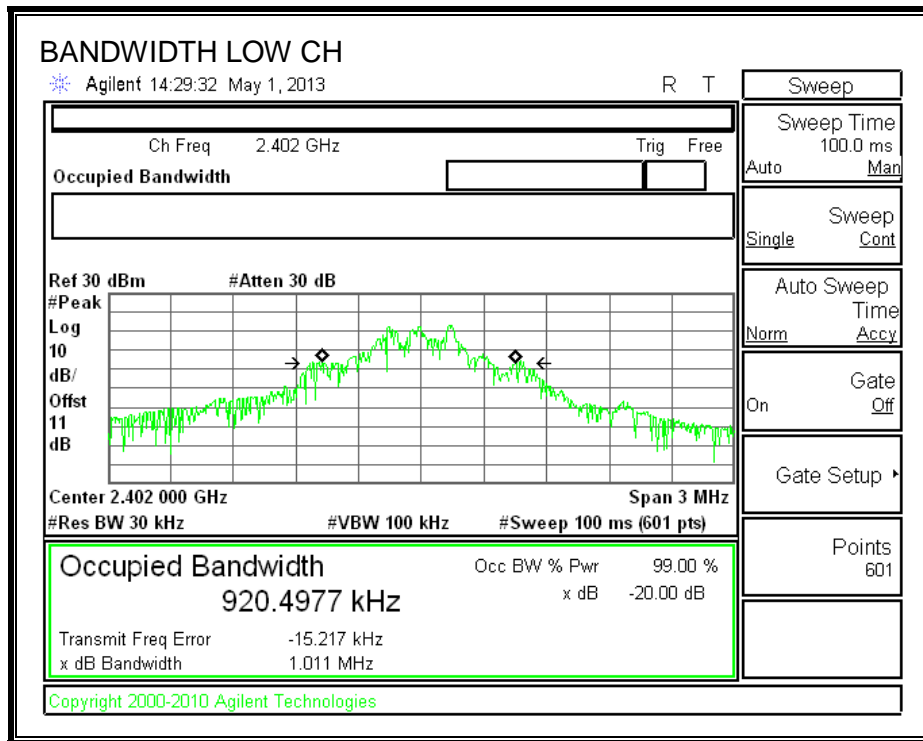

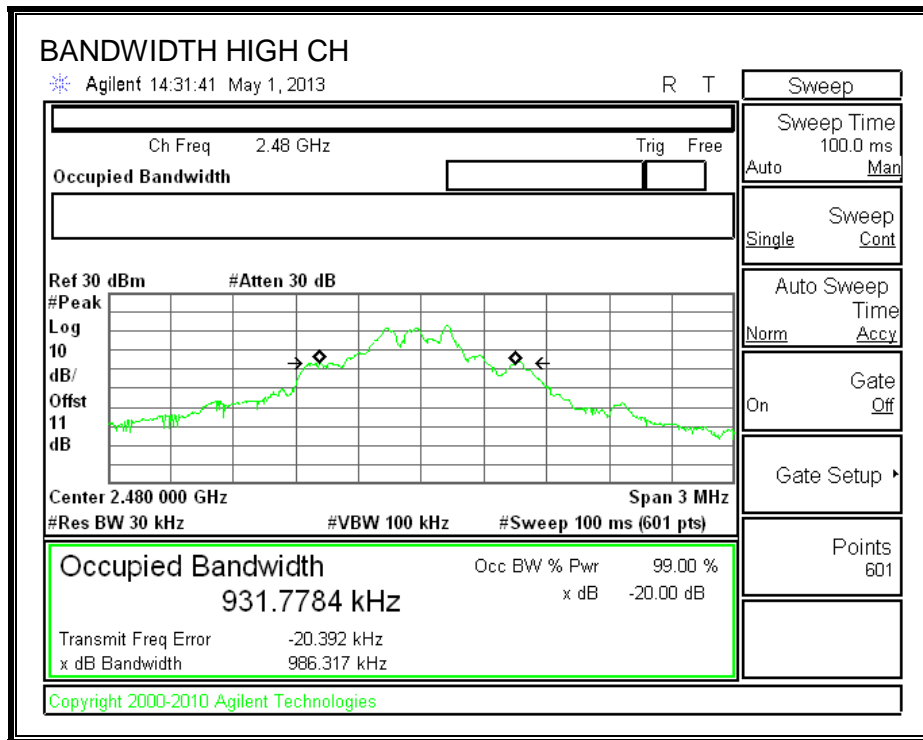

8PSK

20 dB BANDWIDTH

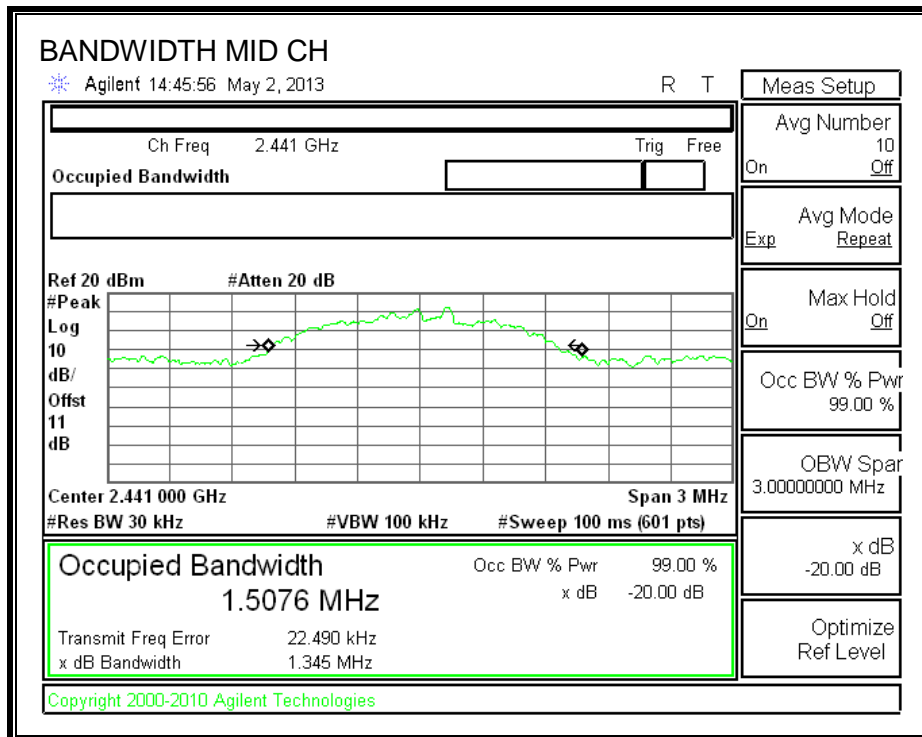
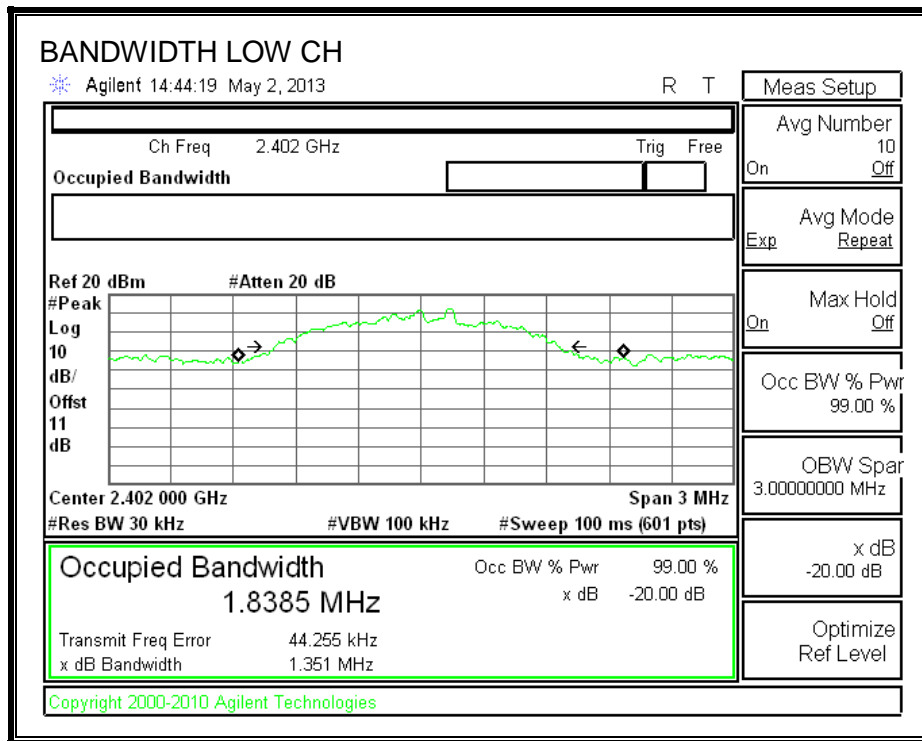

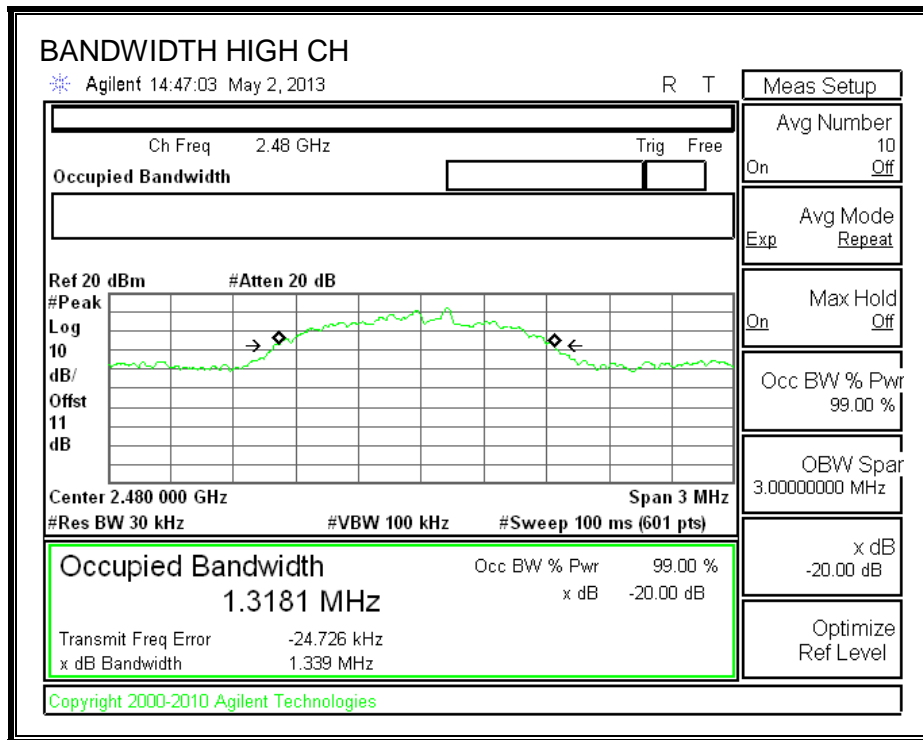

GFSK

99% BANDWIDTH

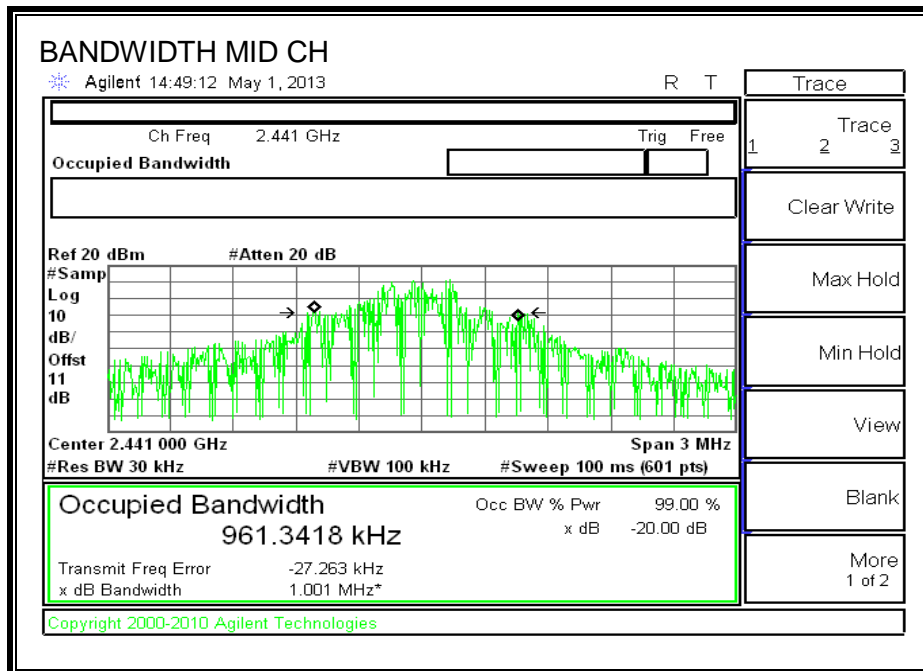
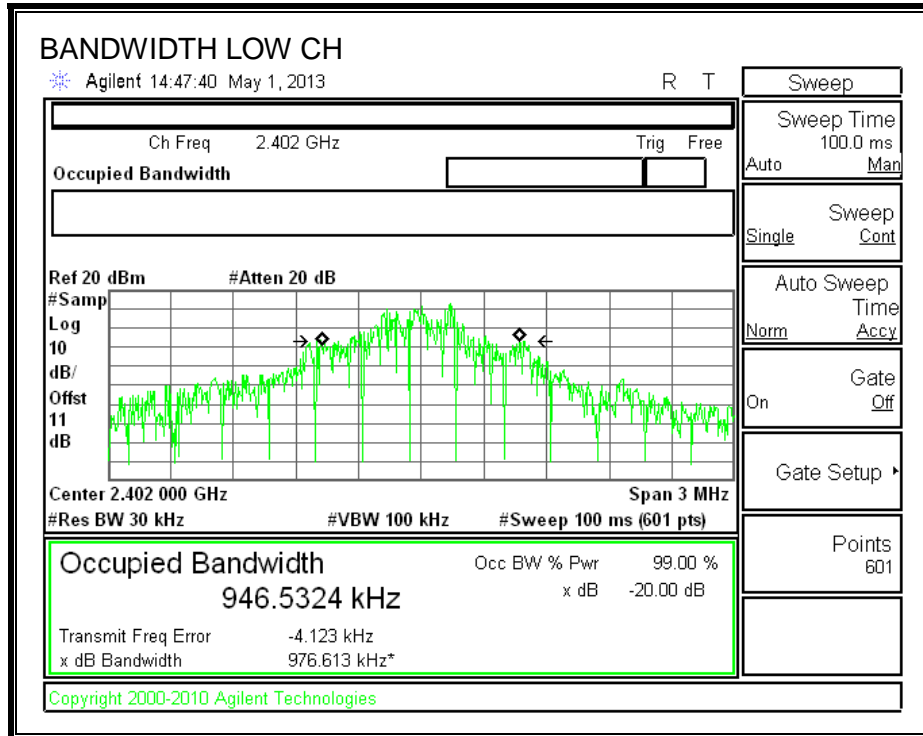

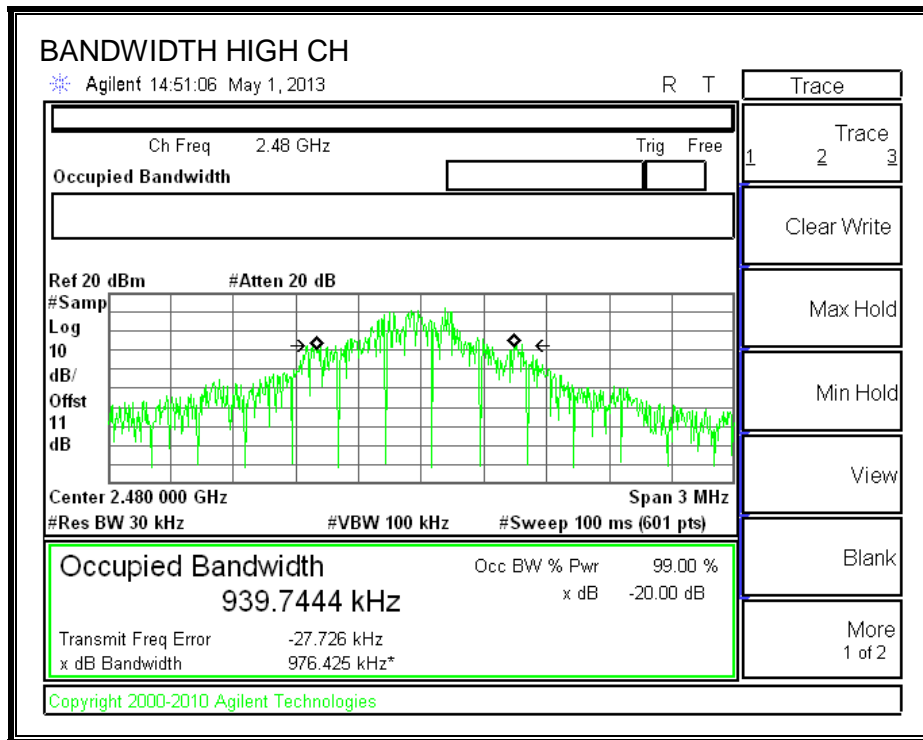

8PSK

99% BANDWIDTH

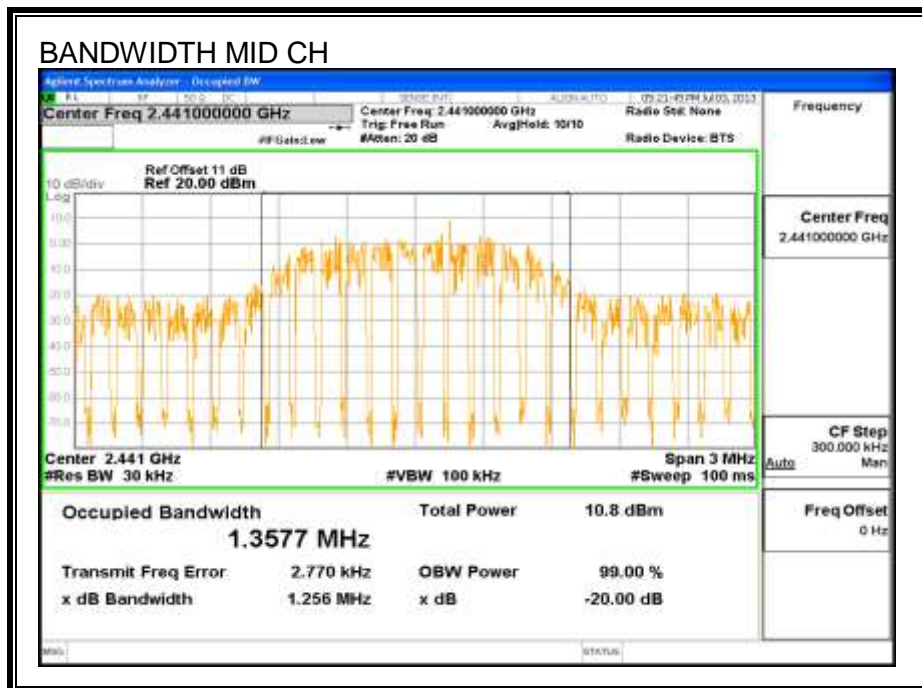
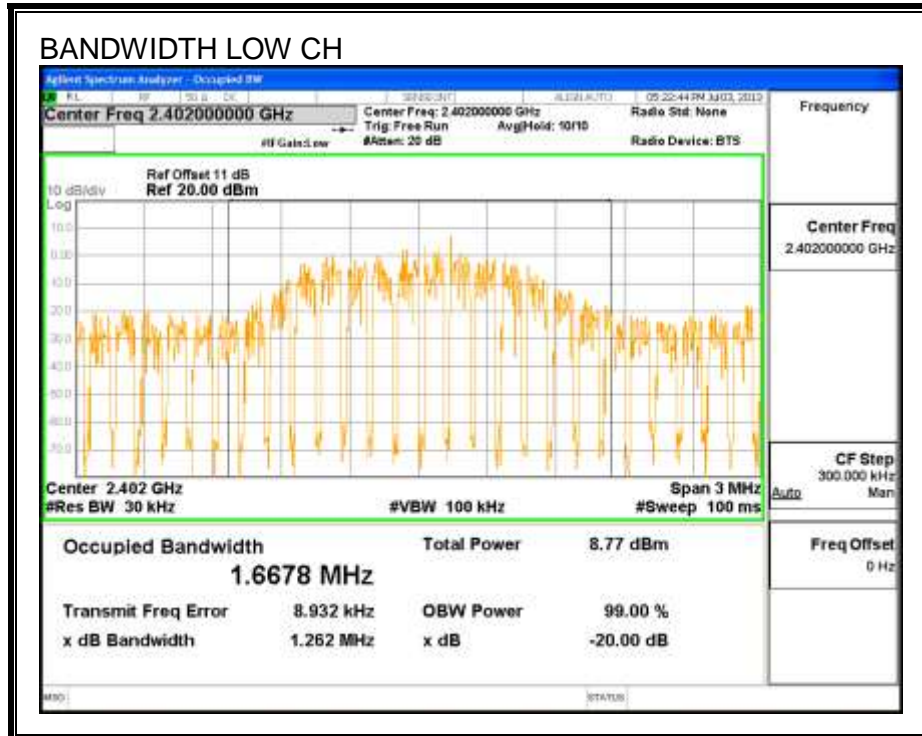

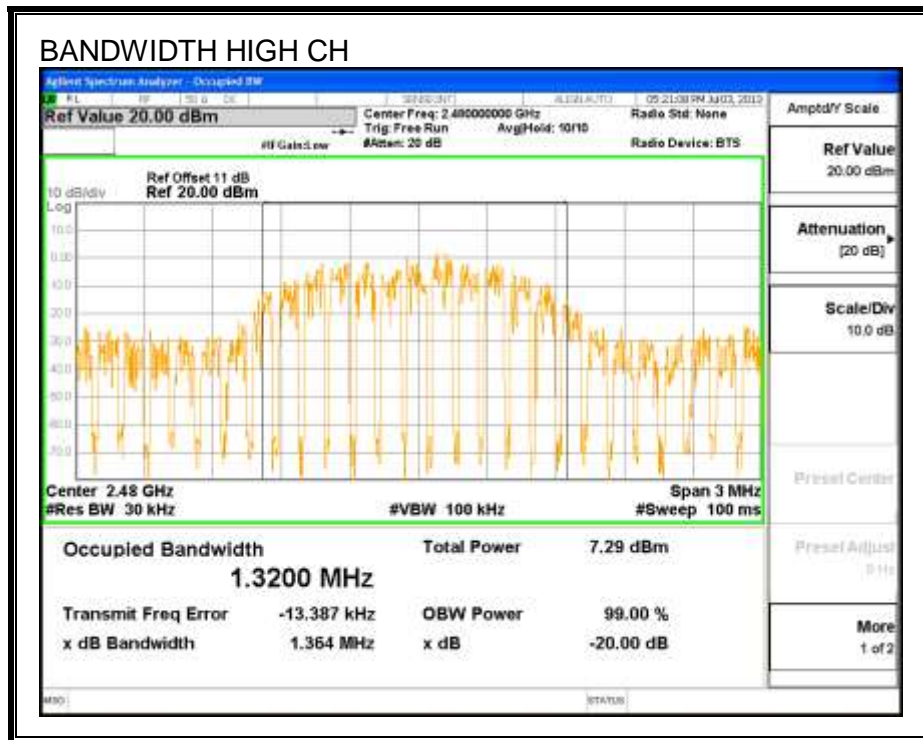

7.2. HOPPING FREQUENCY SEPARATION

LIMIT

FCC §15.247 (a) (1)

IC RSS-210 A8.1 (b)

Frequency hopping systems shall have hopping channel carrier frequencies separated by a minimum of 25 kHz or the 20 dB bandwidth of the hopping channel, whichever is greater.

Alternatively, frequency hopping systems operating in the 2400-2483.5 MHz band may have hopping channel carrier frequencies that are separated by 25 kHz or two-thirds of the 20 dB bandwidth of the hopping channel, whichever is greater, provided the systems operate with an output power no greater than 125 mW.

TEST PROCEDURE

The transmitter output is connected to a spectrum analyzer. The RBW is set to 100 kHz and the VBW is set to 100 kHz. The sweep time is coupled.

GFSK

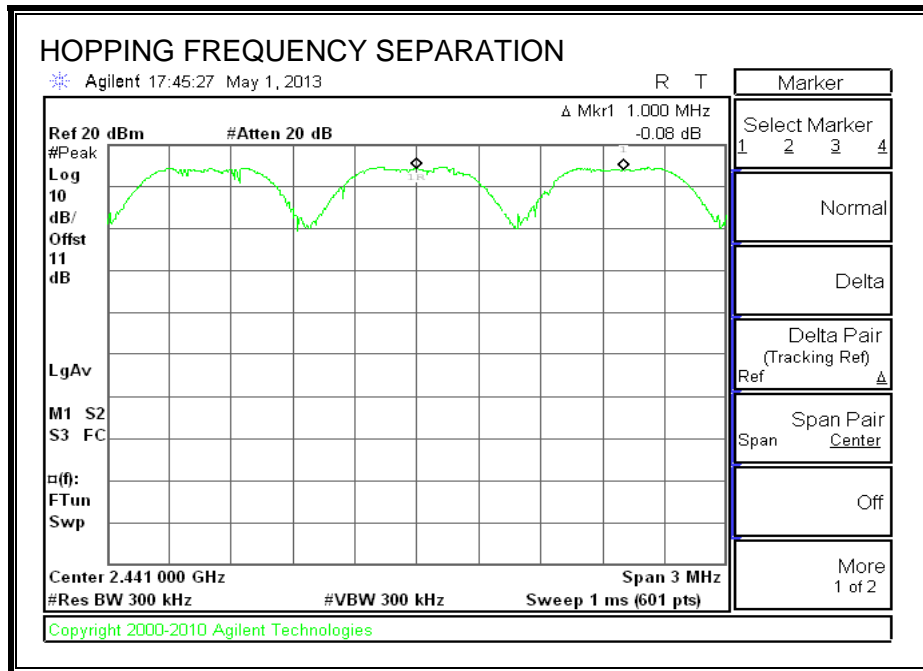

8PSK

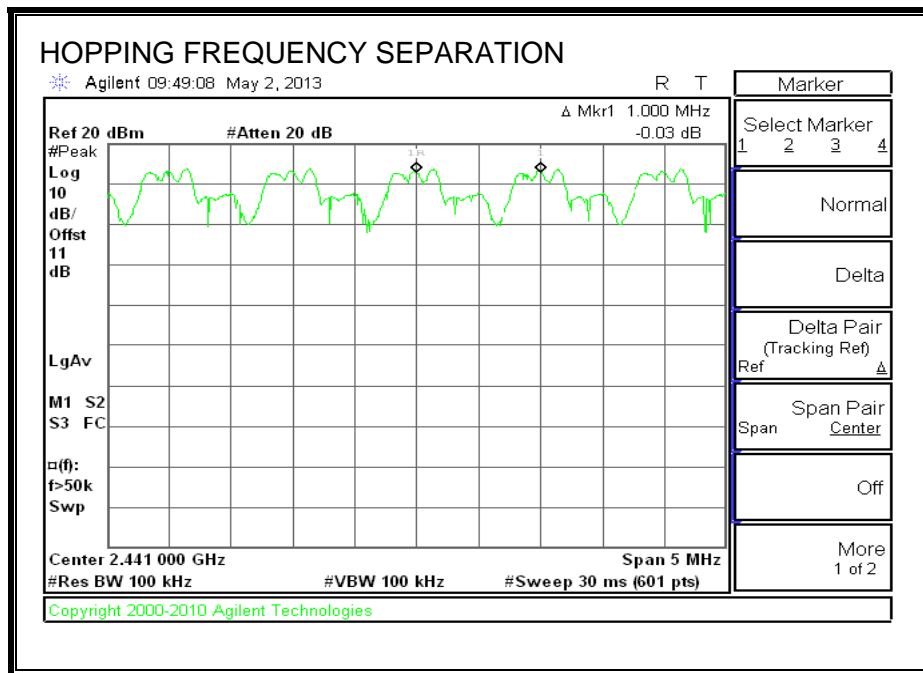

7.3. NUMBER OF HOPPING CHANNELS

LIMIT

FCC §15.247 (a) (1) (iii)

IC RSS-210 A8.1 (d)

Frequency hopping systems in the 2400 – 2483.5 MHz band shall use at least 15 non-overlapping channels.

TEST PROCEDURE

The transmitter output is connected to a spectrum analyzer. The span is set to cover the entire authorized band, in either a single sweep or in multiple contiguous sweeps. The RBW is set to a maximum of 1 % of the span. The analyzer is set to Max Hold.

RESULTS

79 Channels observed.

GFSK

NUMBER OF HOPPING CHANNELS

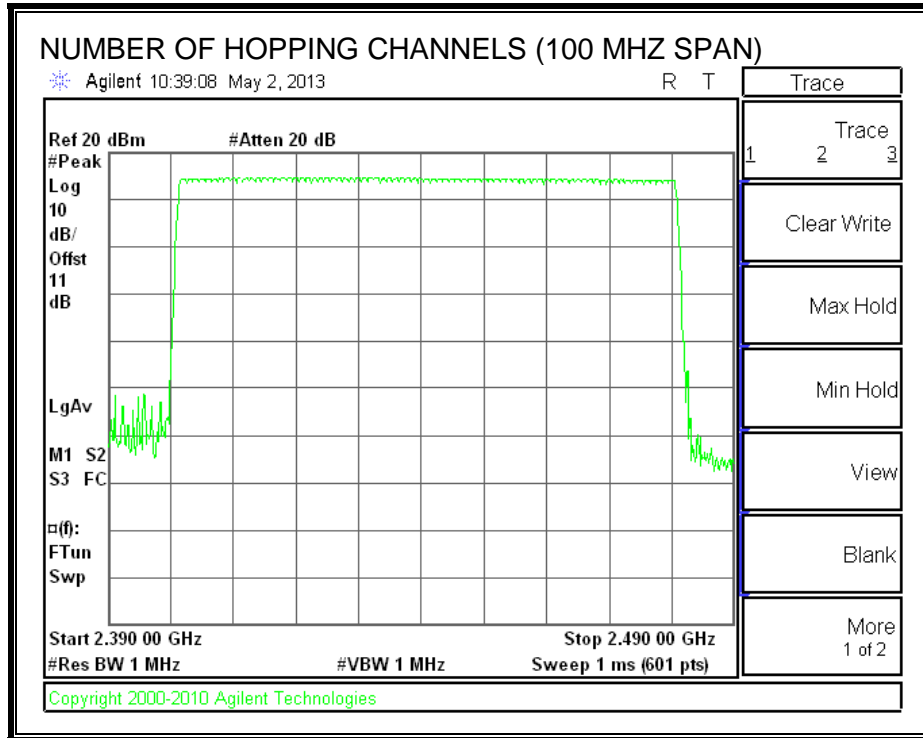

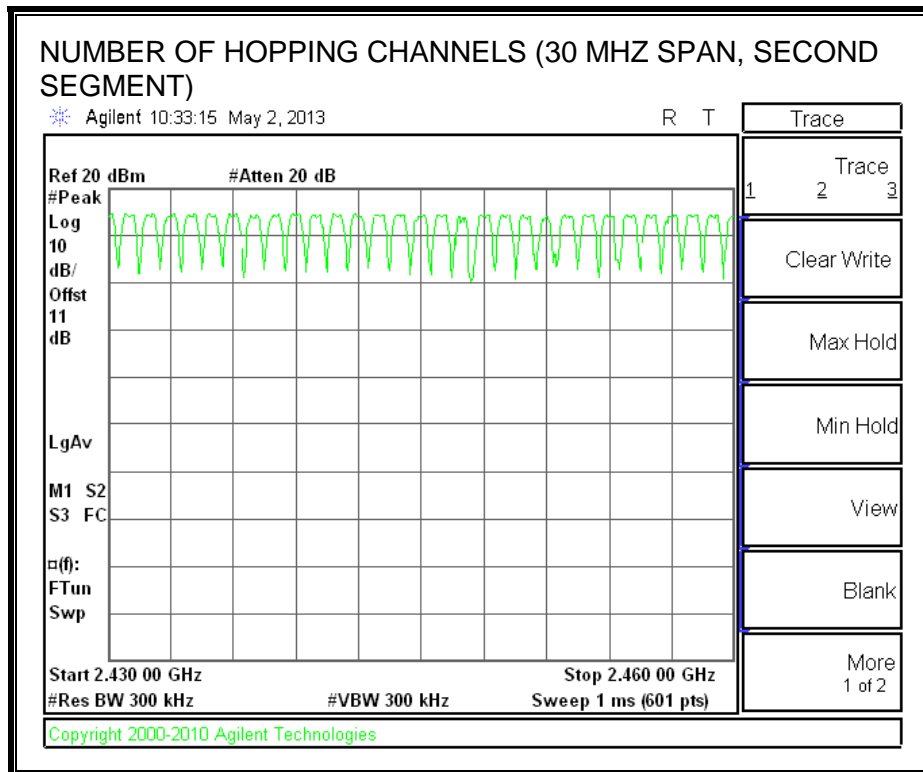
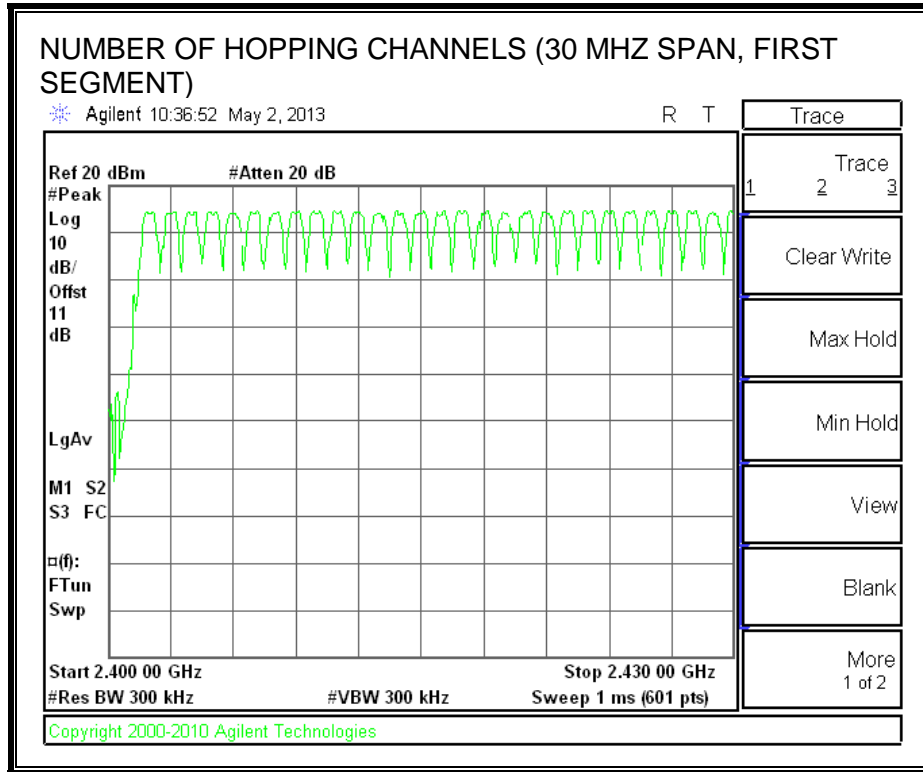

8PSK

NUMBER OF HOPPING CHANNELS

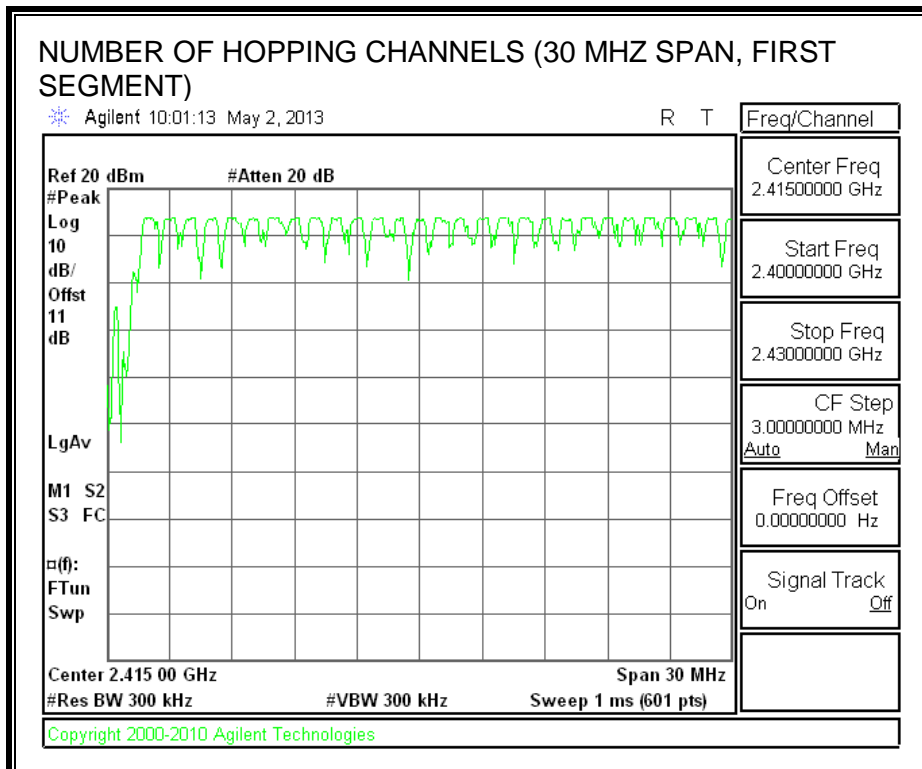
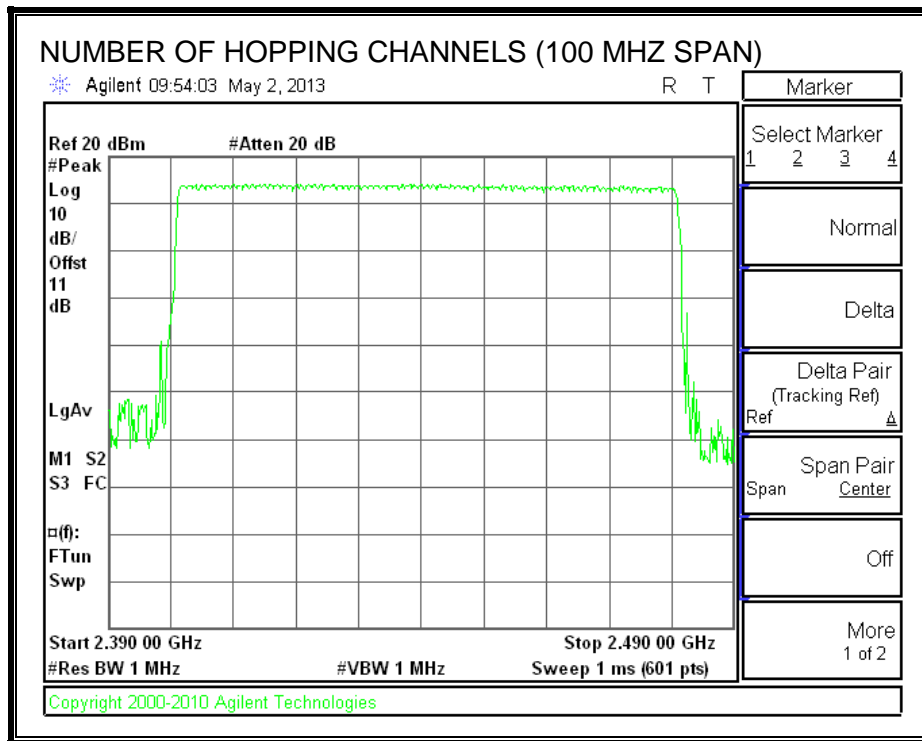

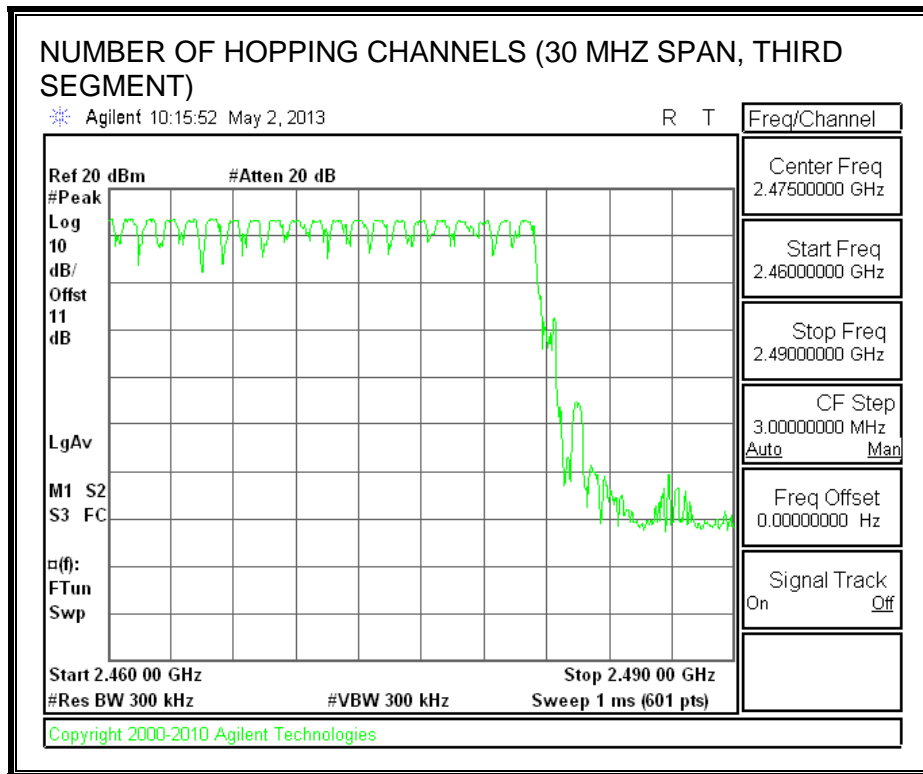
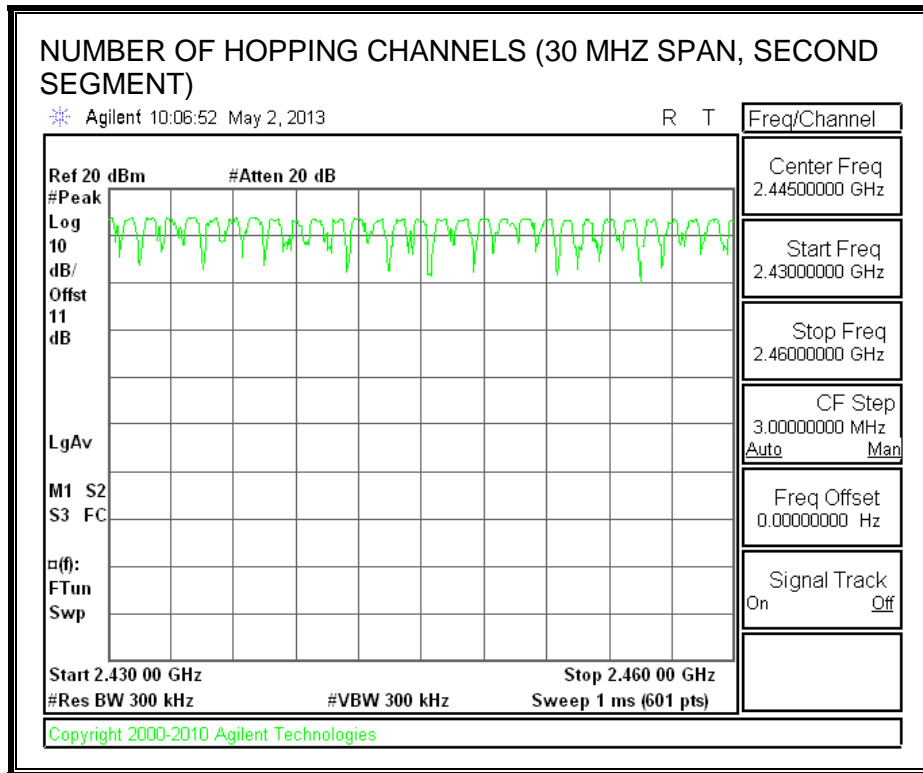

7.4. AVERAGE TIME OF OCCUPANCY

LIMIT

FCC §15.247 (a) (1) (iii)

IC RSS-210 A8.1 (d)

The average time of occupancy on any channel shall not be greater than 0.4 seconds within a period of 0.4 seconds multiplied by the number of hopping channels employed.

TEST PROCEDURE

The transmitter output is connected to a spectrum analyzer. The span is set to 0 Hz, centered on a single, selected hopping channel. The width of a single pulse is measured in a fast scan. The number of pulses is measured in a 3.16 second scan, to enable resolution of each occurrence.

The average time of occupancy in the specified 31.6 second period (79 channels * 0.4 s) is equal to $10 * (\# \text{ of pulses in } 3.16 \text{ s}) * \text{ pulse width}$.

RESULT

GFSK

GFSK Mode

DH Packet	Pulse Width (msec)	Number of Pulses in 3.16 seconds	Average Time of (sec)	Limit (sec)	Margin (sec)
DH1	0.407	31	0.126	0.4	-0.274
DH3	1.667	16	0.267	0.4	-0.133
DH5	2.907	13	0.378	0.4	-0.022

8PSK

8PSK Mode

DH Packet	Pulse Width (msec)	Number of Pulses in 3.16 seconds	Average Time of Occupancy (sec)	Limit (sec)	Margin (sec)
DH1	0.4169	32	0.133	0.4	-0.267
DH3	1.6640	17	0.283	0.4	-0.117
DH5	2.9200	13	0.380	0.4	-0.020

PULSE WIDTH GFSK DH3

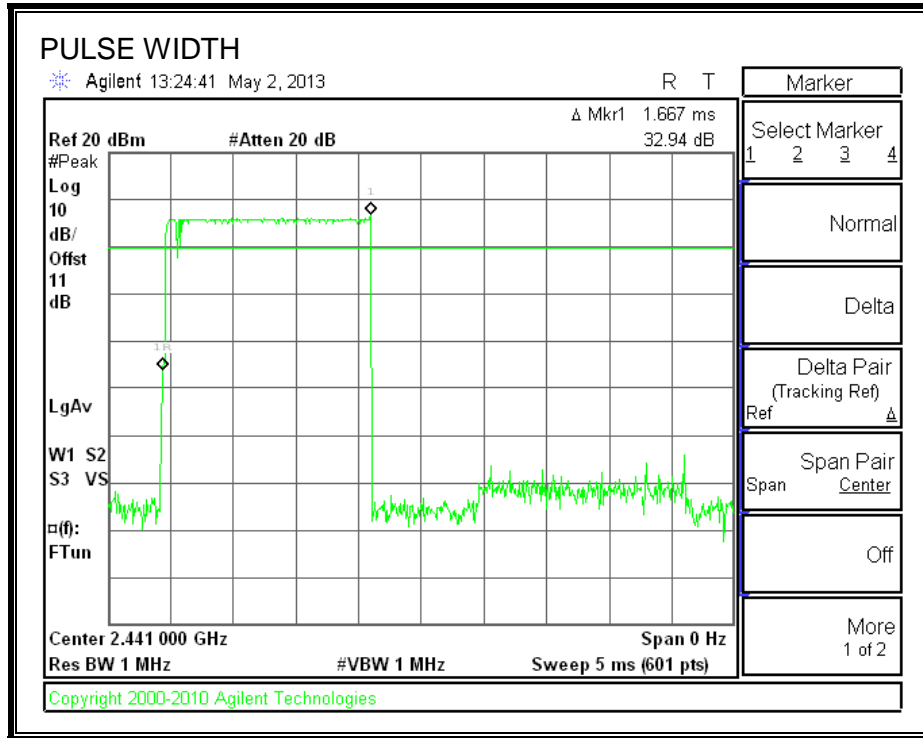

NUMBER OF PULSES IN 3.16 SECOND OBSERVATION PERIOD

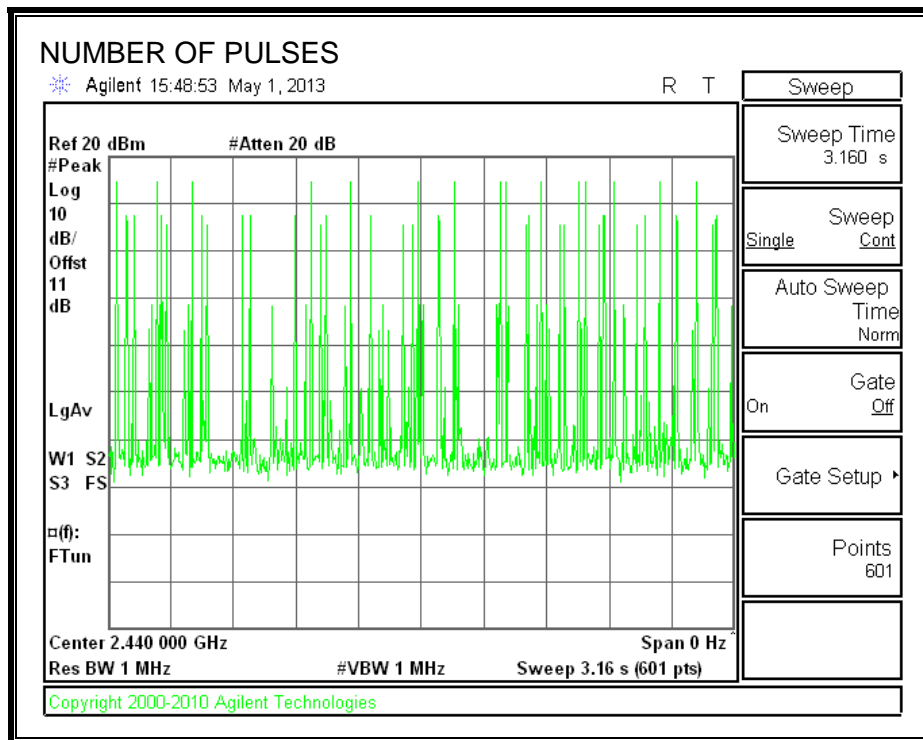

PULSE WIDTH GFSK DH5

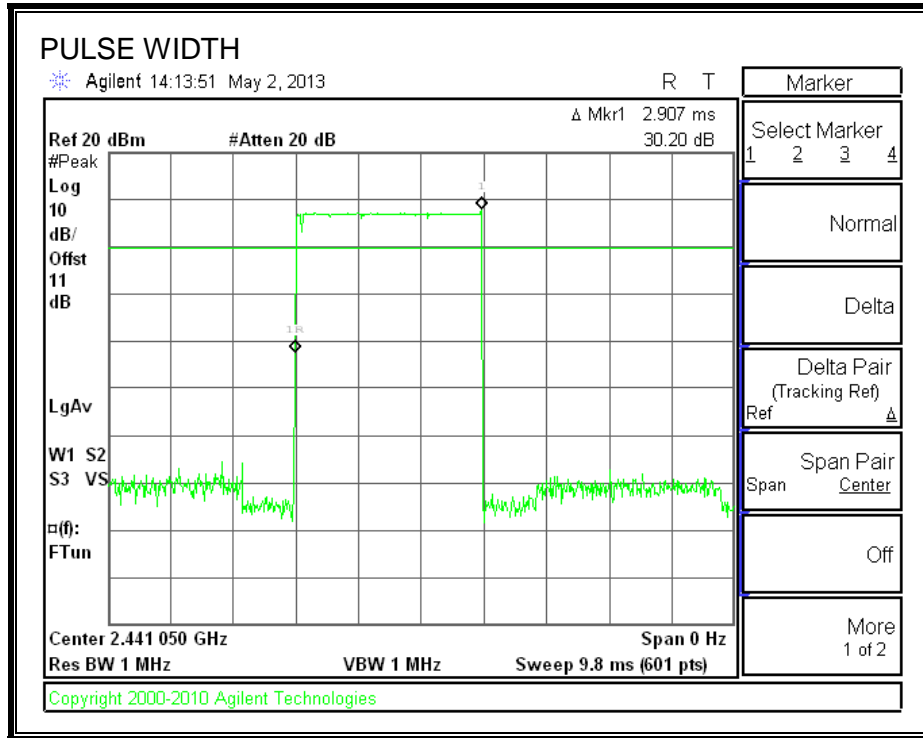

NUMBER OF PULSES IN 3.16 SECOND OBSERVATION PERIOD

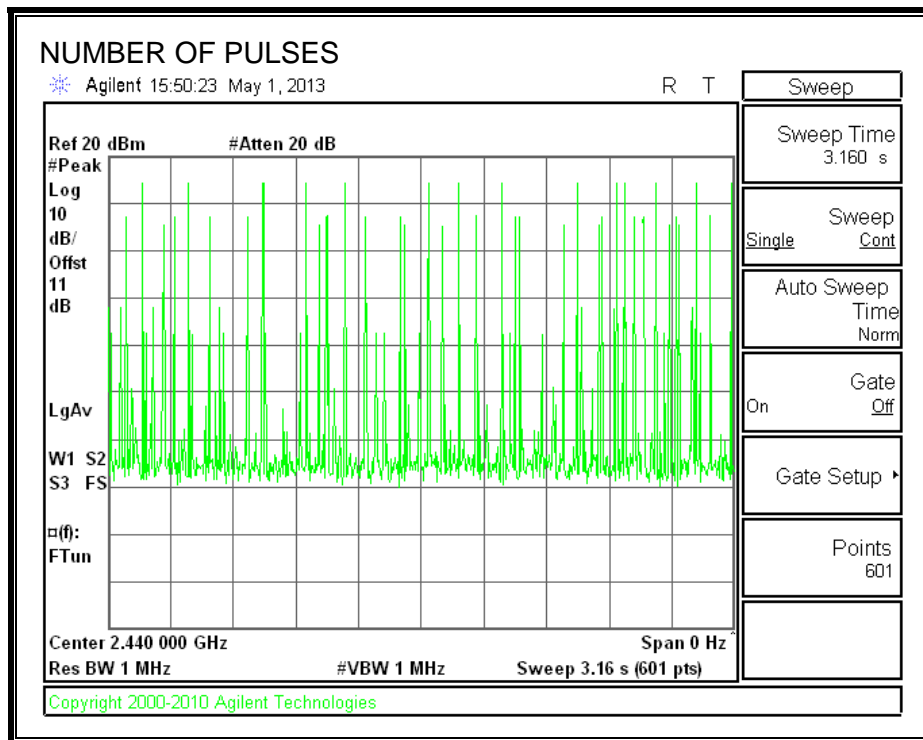

PULSE WIDTH 8PSK DH3

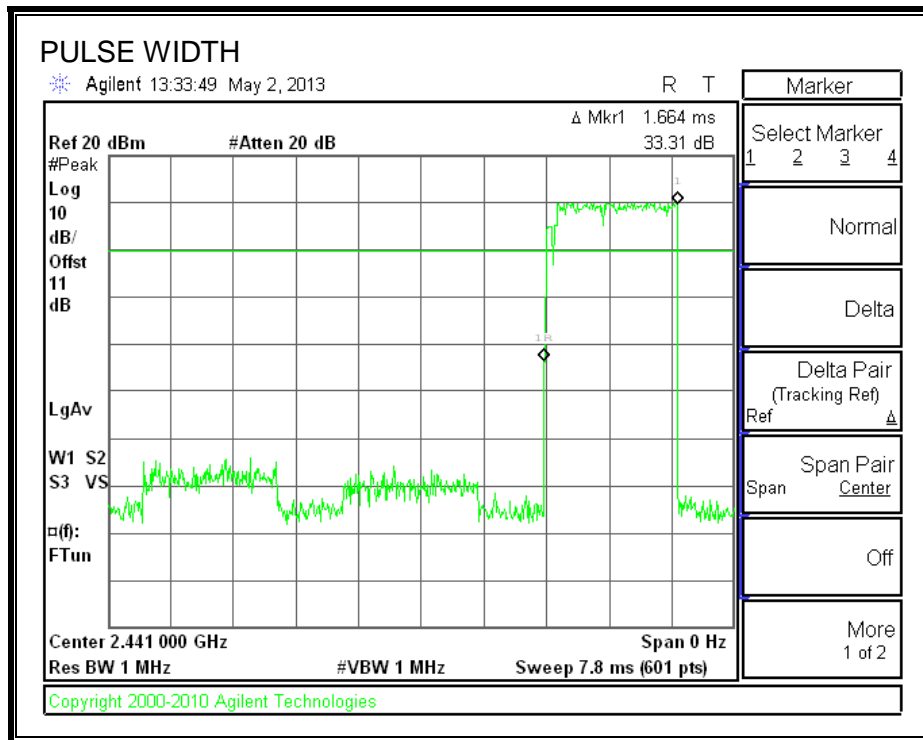

NUMBER OF PULSES IN 3.16 SECOND OBSERVATION PERIOD

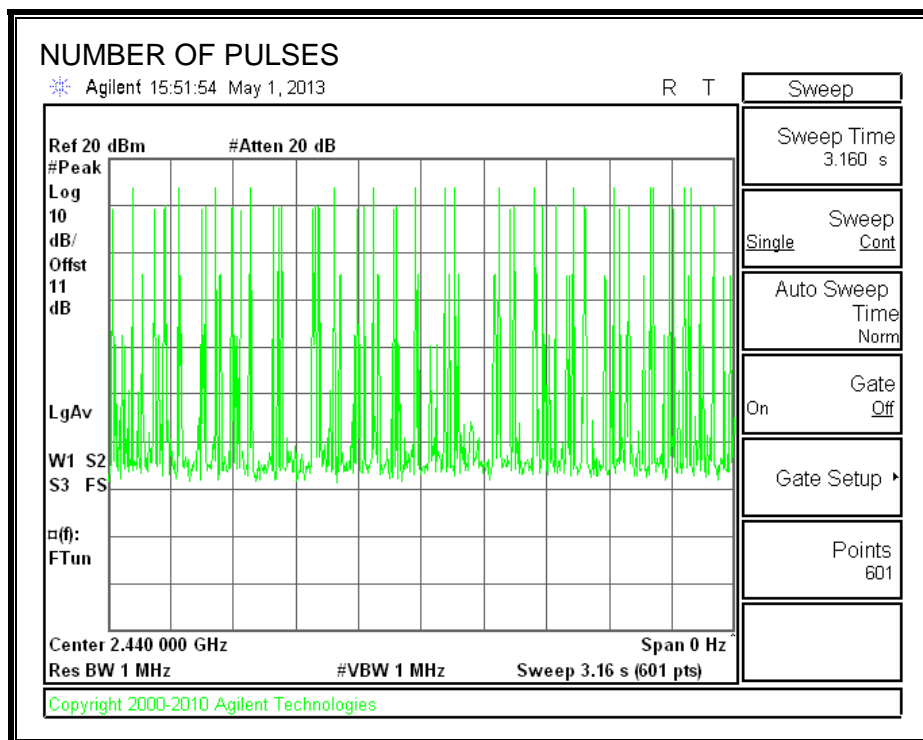

PULSE WIDTH 8PSK DH5

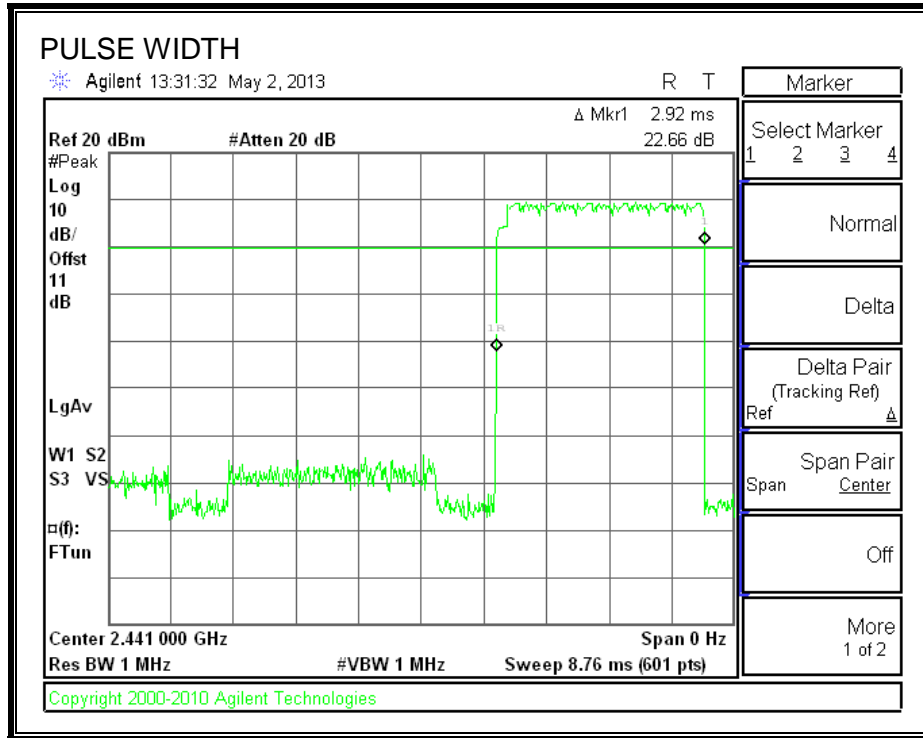

NUMBER OF PULSES IN 3.16 SECOND OBSERVATION PERIOD

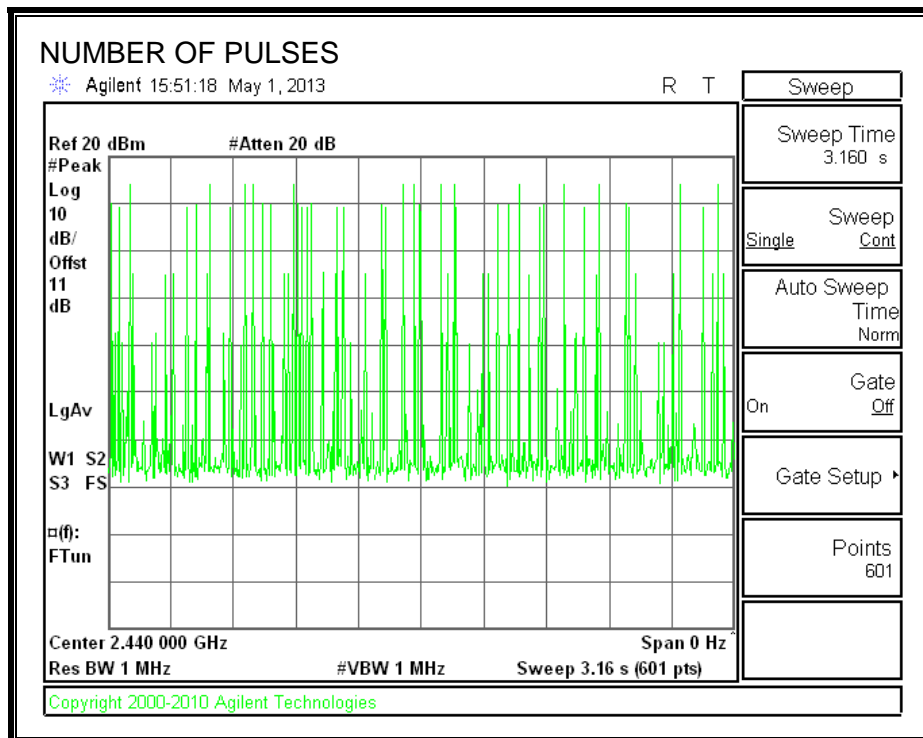

7.5. OUTPUT POWER

LIMIT

§15.247 (b) (1)

RSS-210 Issue 7 Clause A8.4

The maximum antenna gain is less than 6 dBi, therefore the limit is 30 dBm.

TEST PROCEDURE

The transmitter output is connected to a spectrum analyzer the analyzer bandwidth is set to a value greater than the 20 dB bandwidth of the EUT.

RESULTS

GFSK

Channel	Frequency (MHz)	Output Power (dBm)	Limit (dBm)	Margin (dB)
Low	2402	12.62	30	-17.38
Middle	2441	12.87	30	-17.13
High	2480	12.42	30	-17.58

8PSK

Channel	Frequency (MHz)	Output Power (dBm)	Limit (dBm)	Margin (dB)
Low	2402	12.48	21	-8.52
Middle	2441	12.69	21	-8.31
High	2480	11.95	21	-9.05

GFSK

OUTPUT POWER

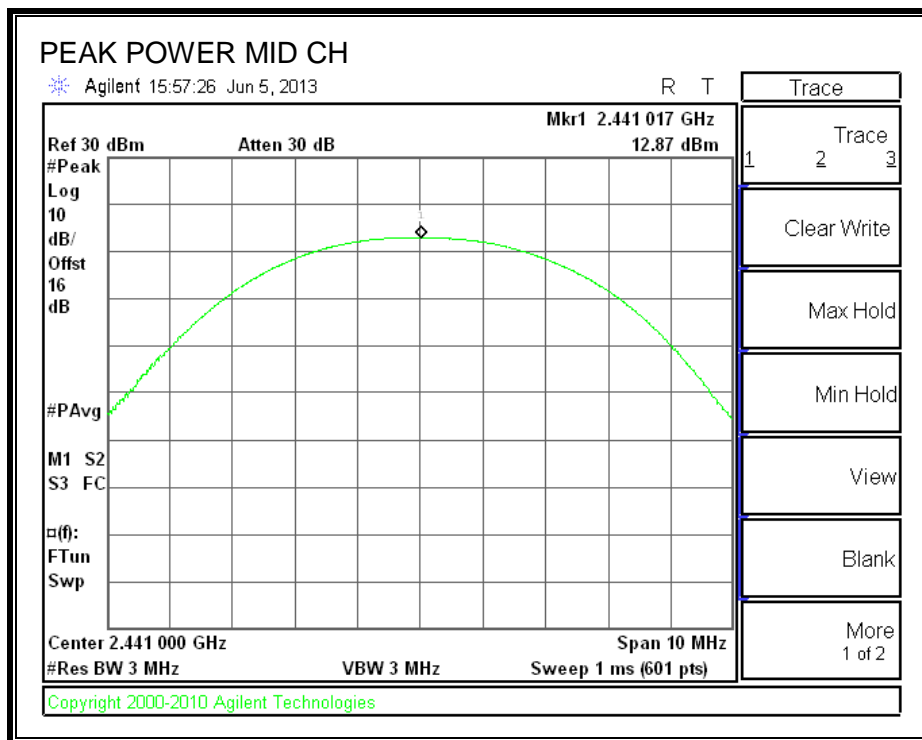
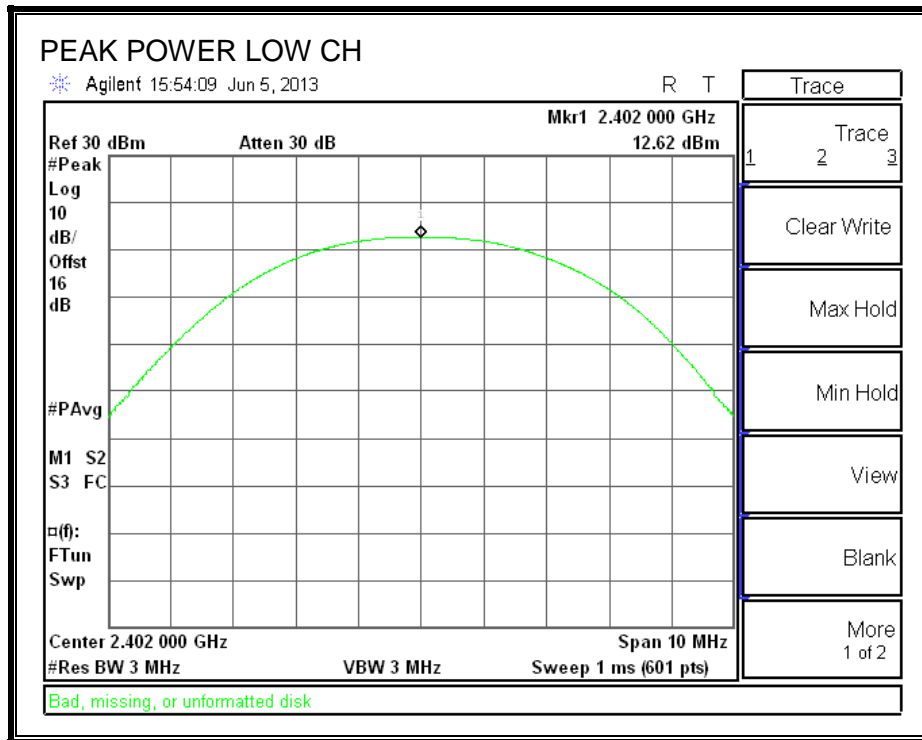

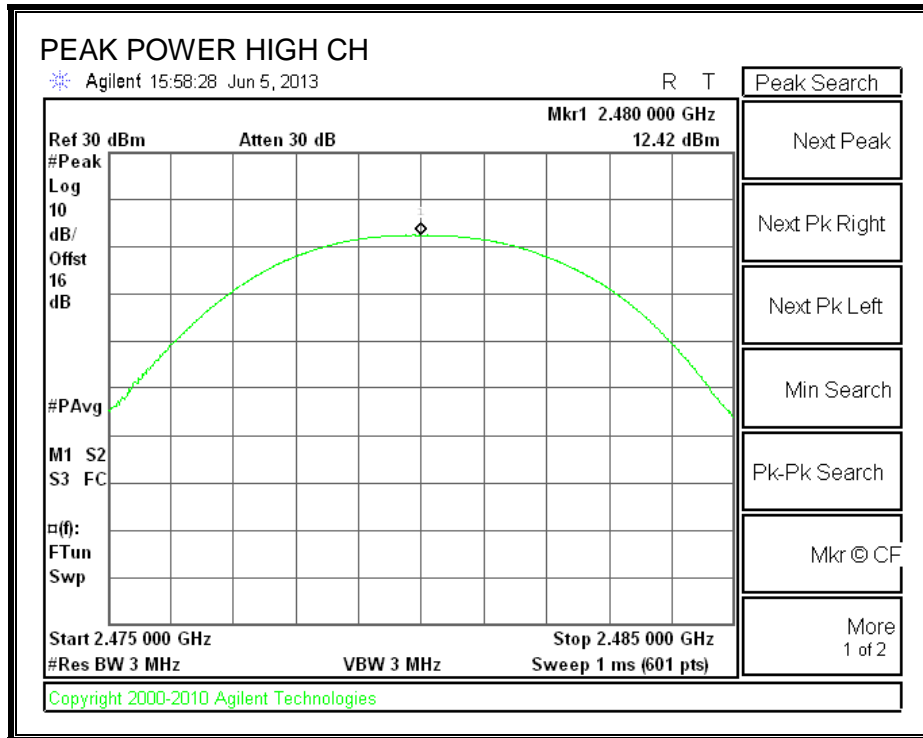

8PSK

OUTPUT POWER

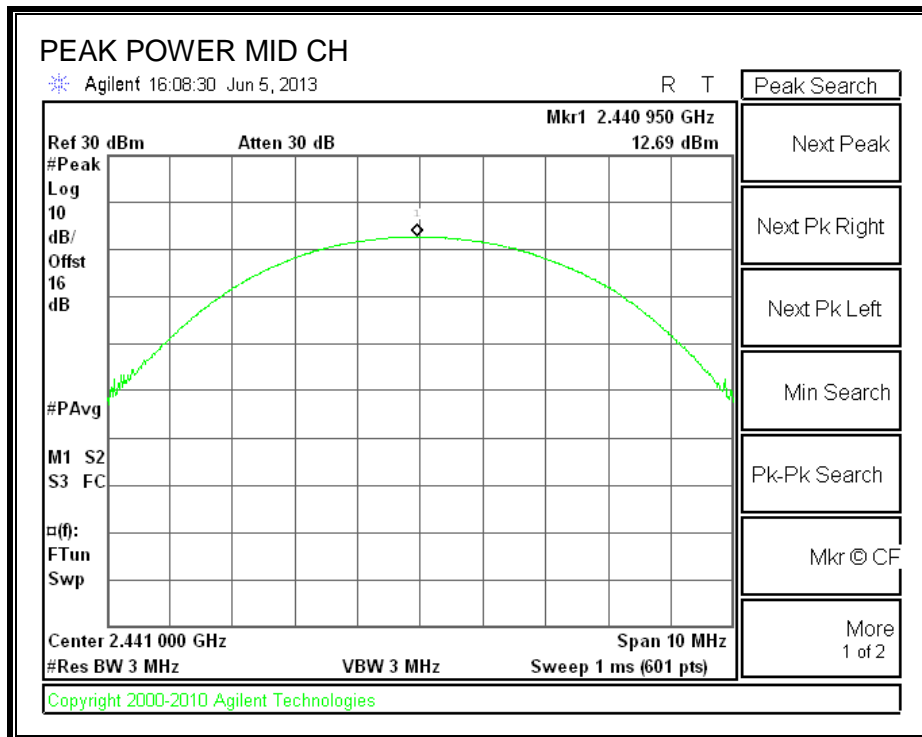
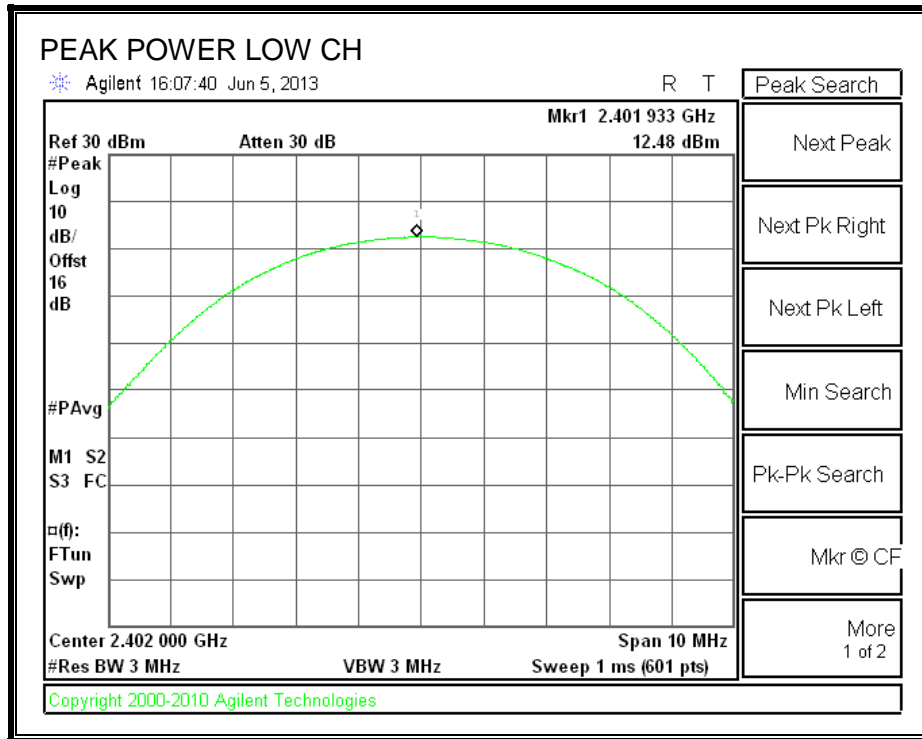

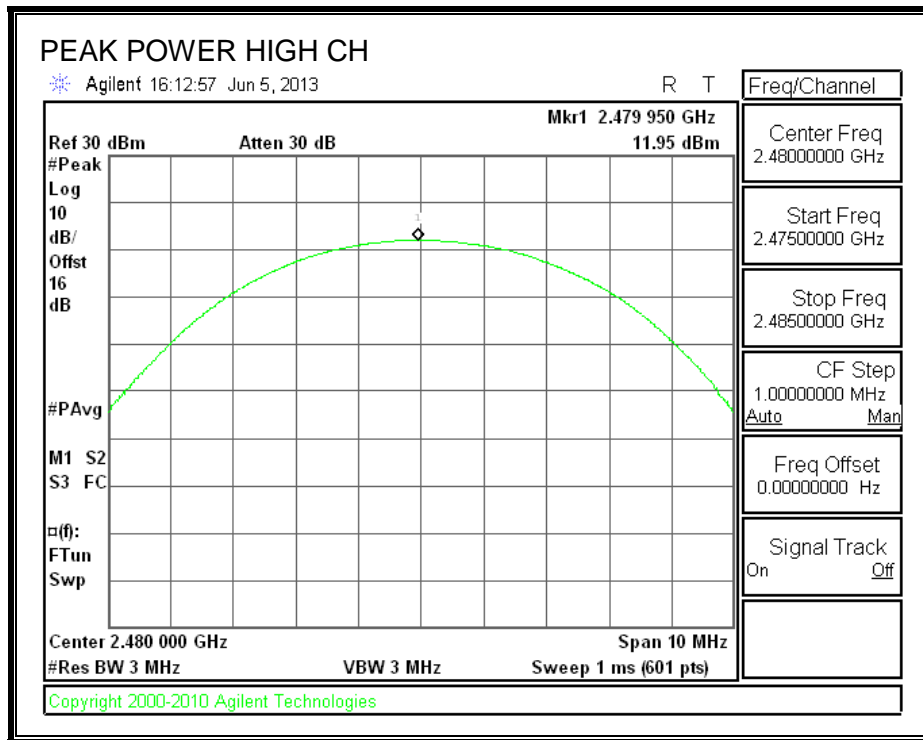

7.6. AVERAGE POWER

LIMIT

None; for reporting purposes only.

TEST PROCEDURE

The transmitter output is connected to a power meter.

RESULTS

The cable assembly insertion loss of 11.0 dB (including 10 dB pad and 1.0 dB cable) was entered as an offset in the power meter to allow for direct reading of power.

GFSK

Channel	Frequency (MHz)	Average Power (dBm)
Low	2402	12.35
Middle	2441	12.40
High	2480	12.25

8PSK

Channel	Frequency (MHz)	Average Power (dBm)
Low	2402	10.25
Middle	2441	10.30
High	2480	10.00

7.7. CONDUCTED SPURIOUS EMISSIONS

LIMITS

FCC §15.247 (d)

IC RSS-210 A8.5

Limit = -20 dBc

TEST PROCEDURE

The transmitter output is connected to a spectrum analyzer. The resolution bandwidth is set to 100 kHz. The video bandwidth is set to 300 kHz.

The spectrum from 30 MHz to 26 GHz is investigated with the transmitter set to the lowest, middle, and highest channels.

The bandedges at 2.4 and 2.4835 GHz are investigated with the transmitter set to the normal hopping mode.

RESULTS

GFSK

SPURIOUS EMISSIONS, LOW CHANNEL

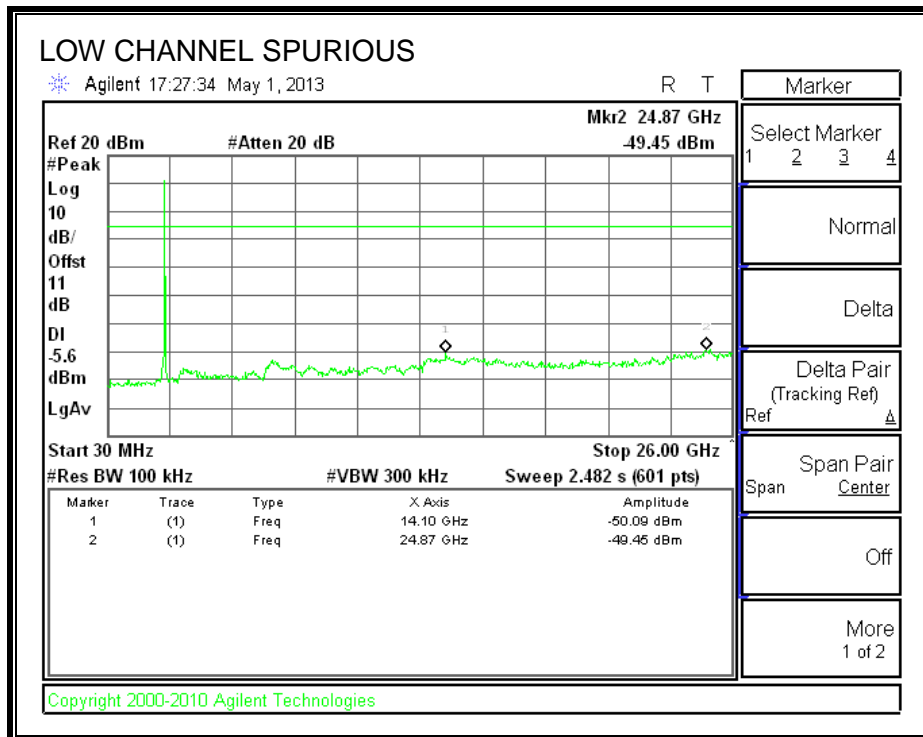
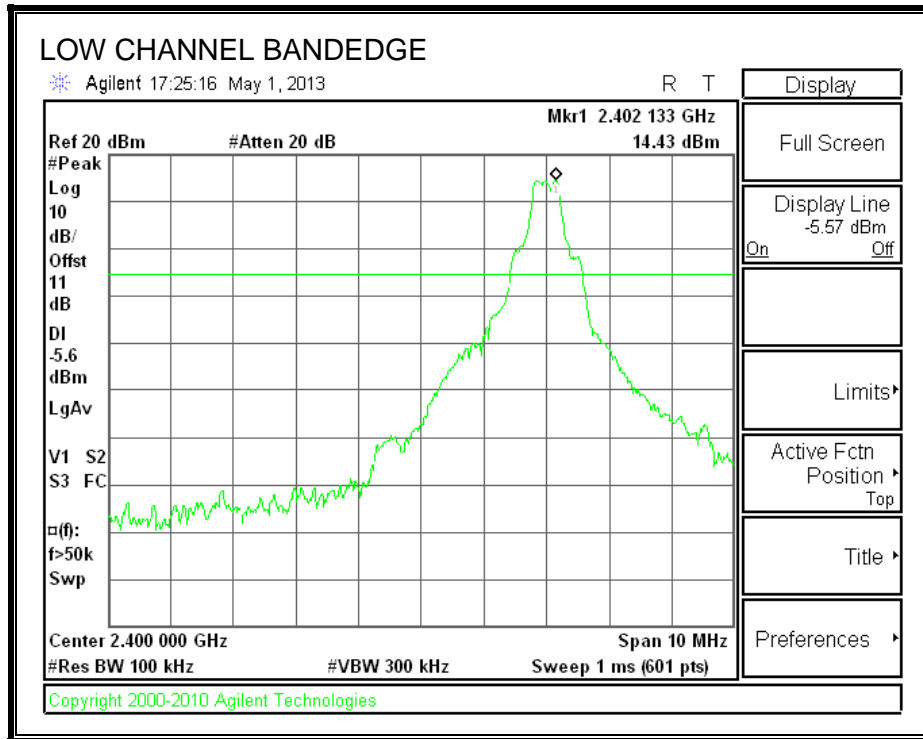

SPURIOUS EMISSIONS, MID CHANNEL

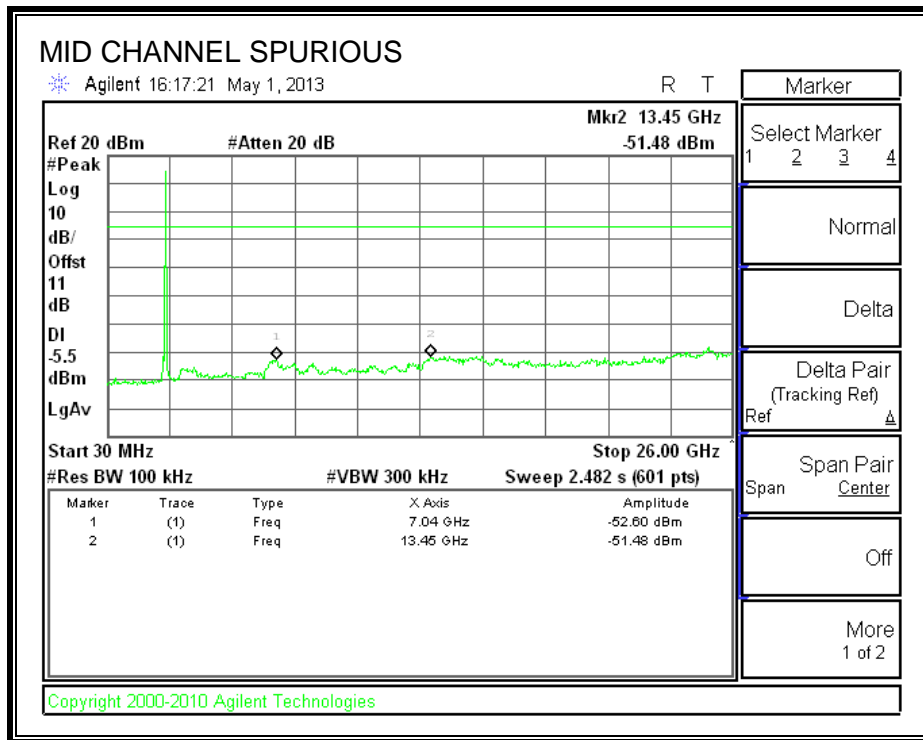
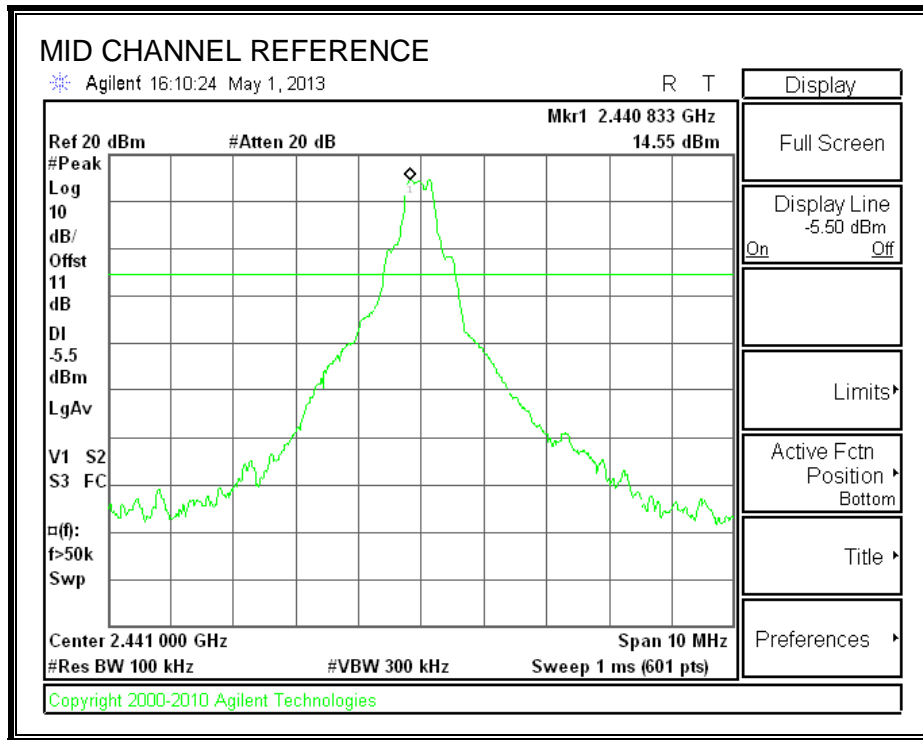

SPURIOUS EMISSIONS, HIGH CHANNEL

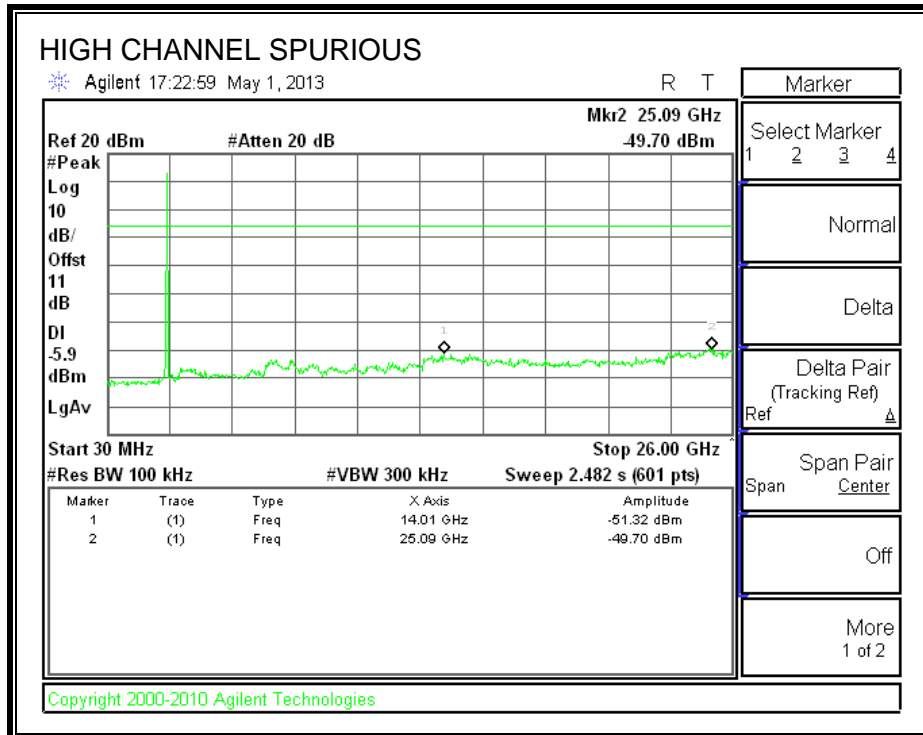
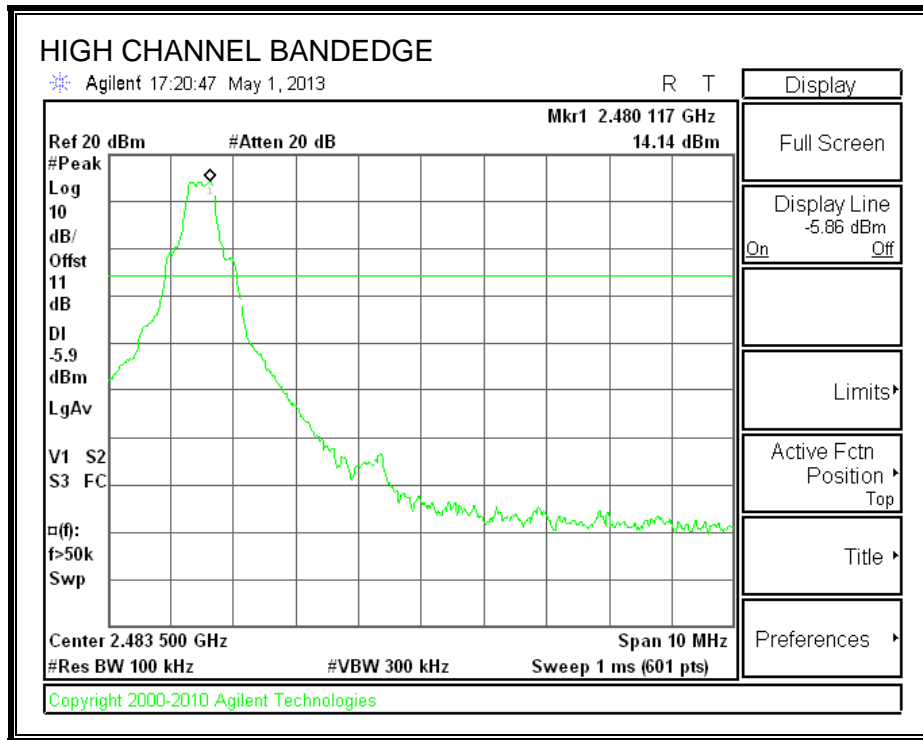

SPURIOUS BANDEDGE EMISSIONS WITH HOPPING ON

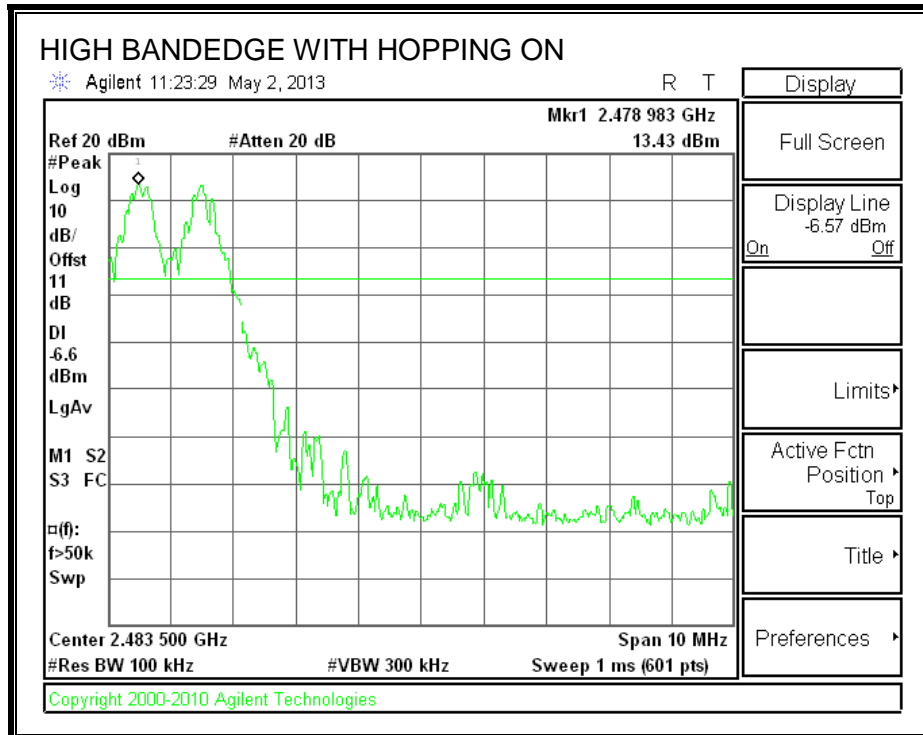
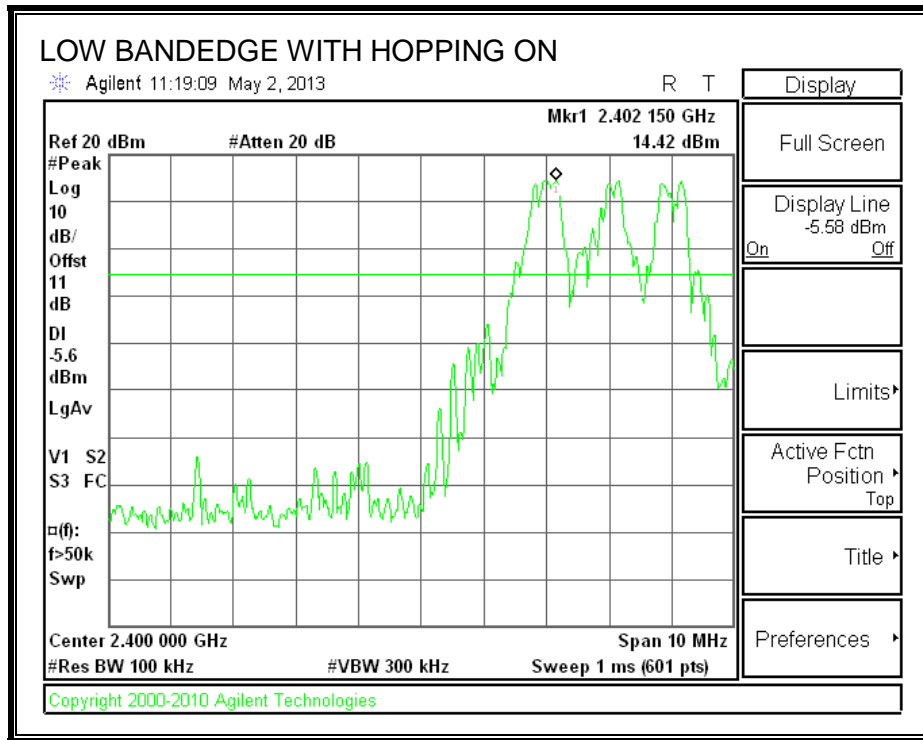

8PSK

SPURIOUS EMISSIONS, LOW CHANNEL

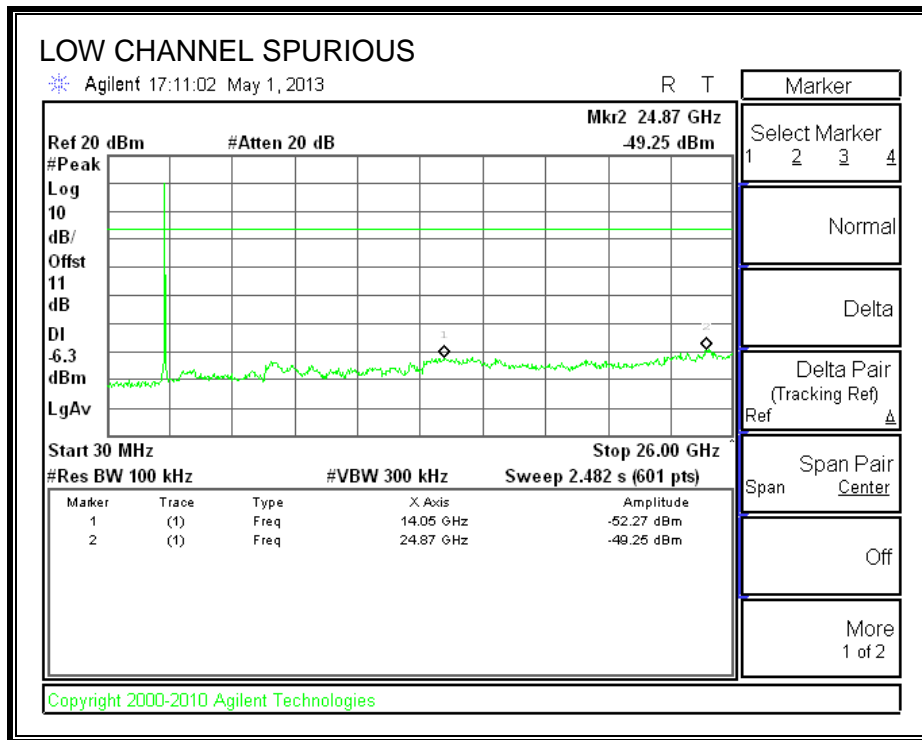
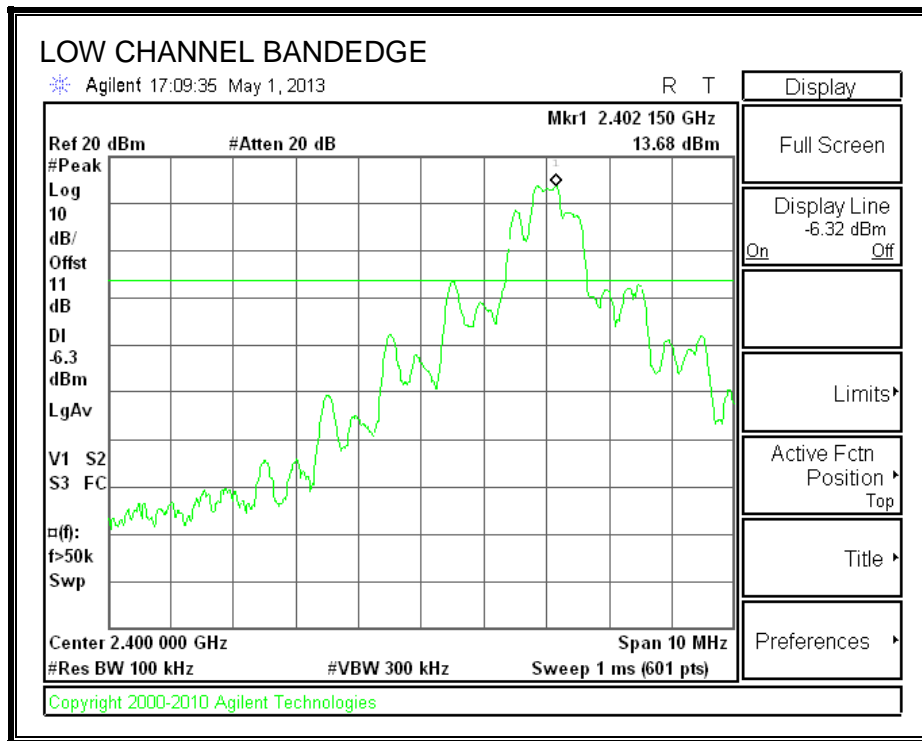

SPURIOUS EMISSIONS, MID CHANNEL

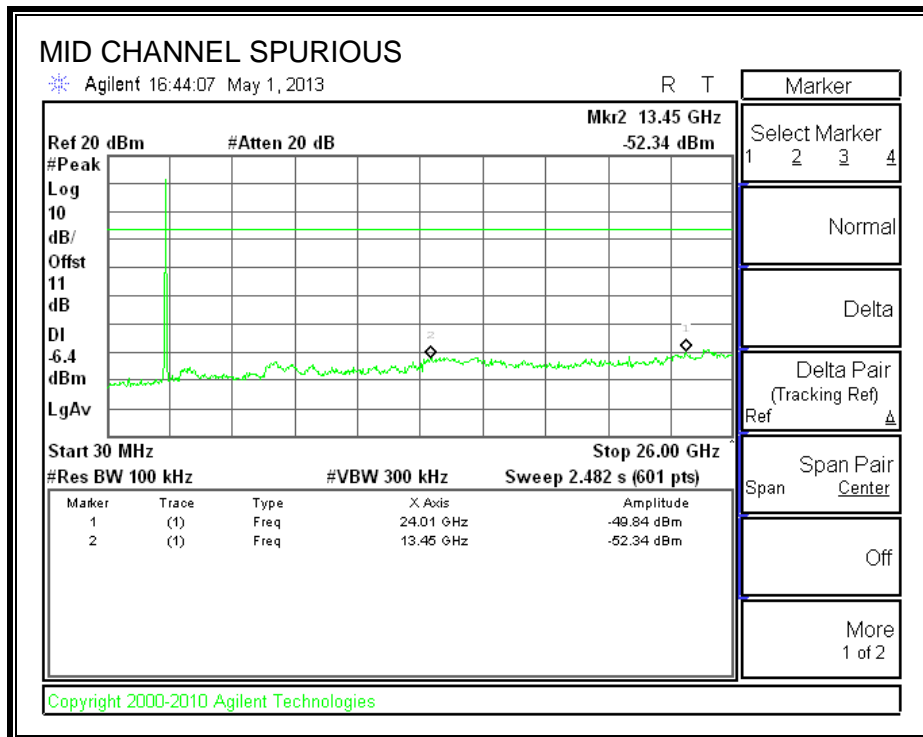
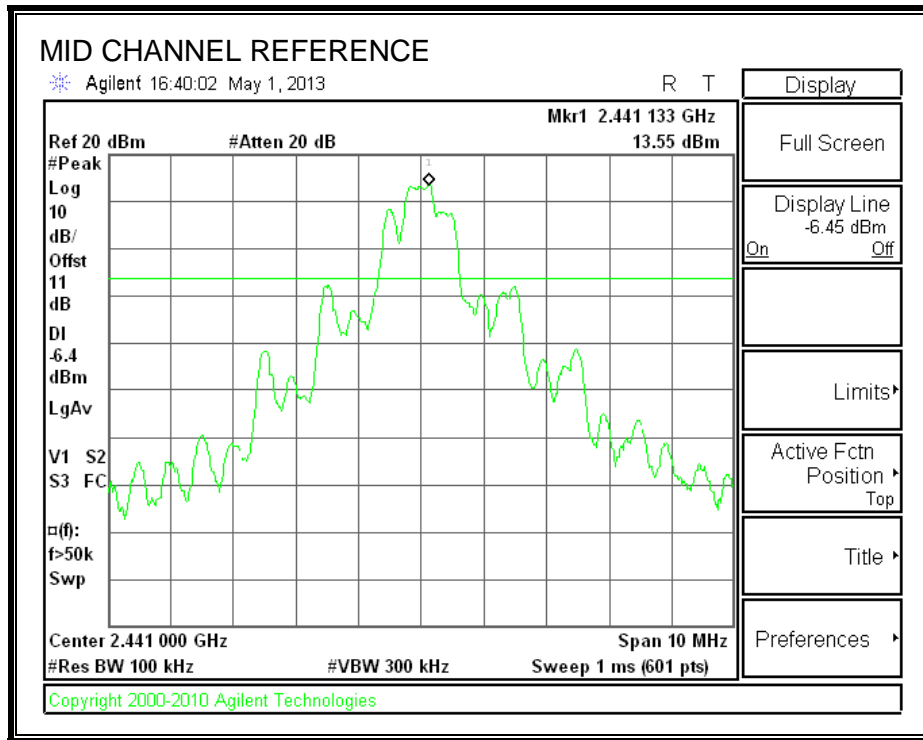

SPURIOUS EMISSIONS, HIGH CHANNEL

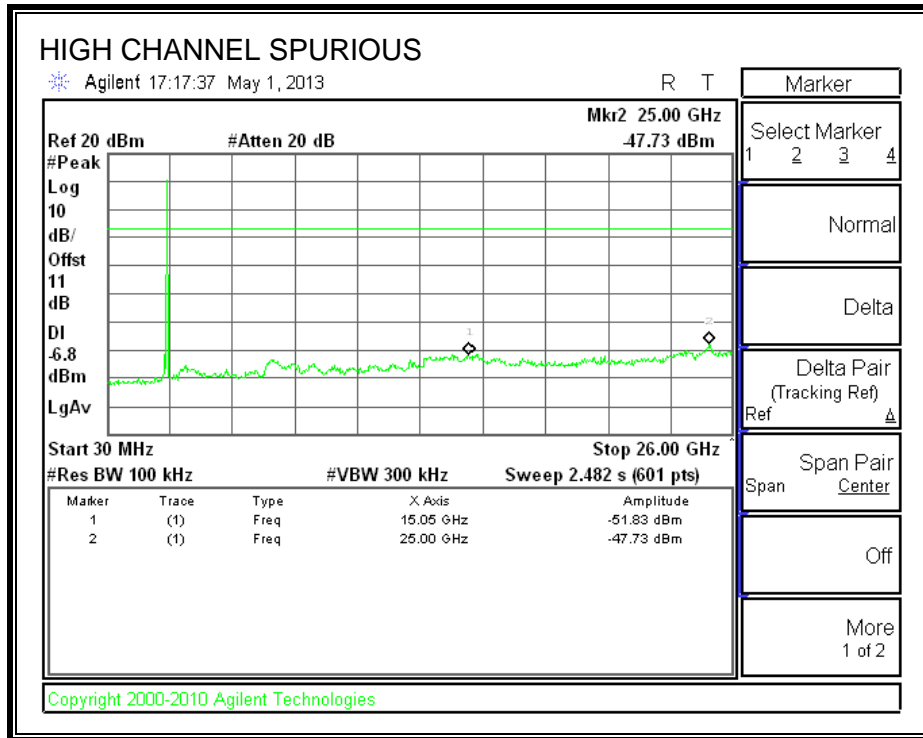
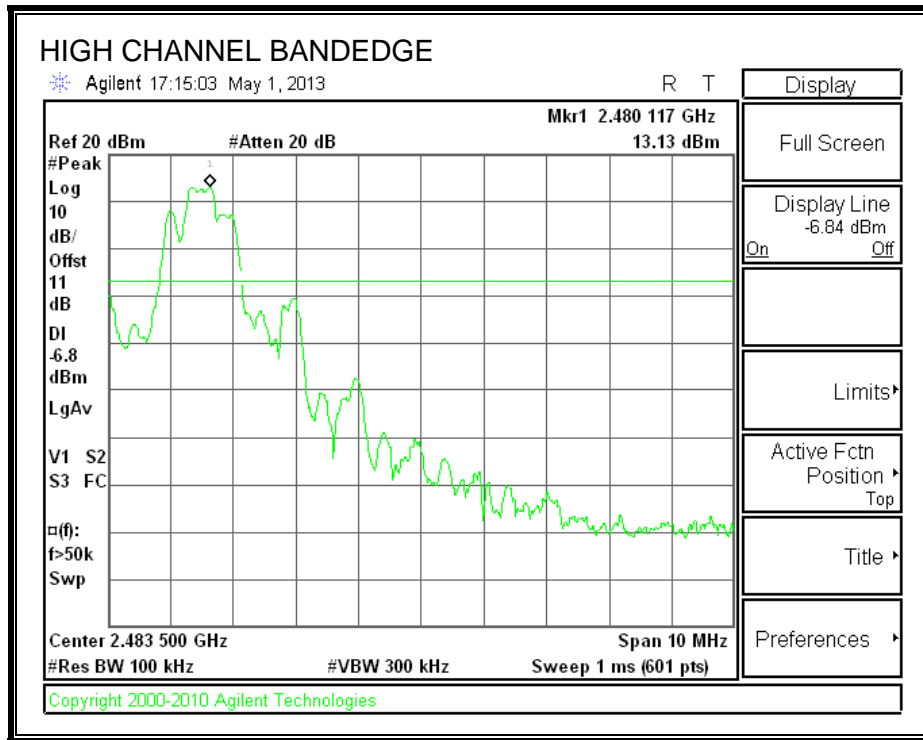

SPURIOUS BANDEDGE EMISSIONS WITH HOPPING ON

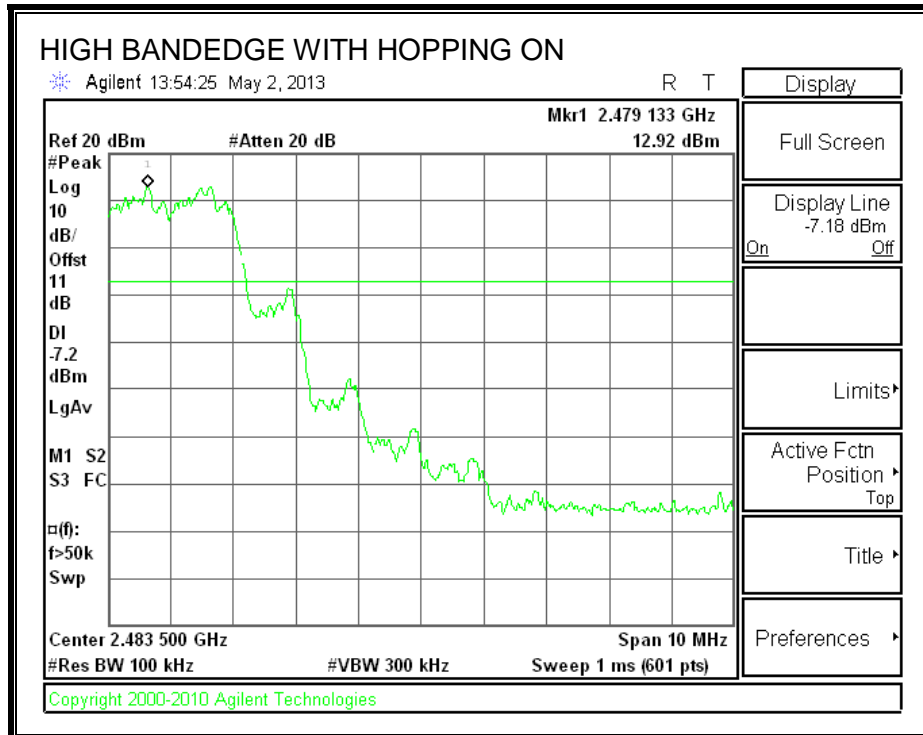
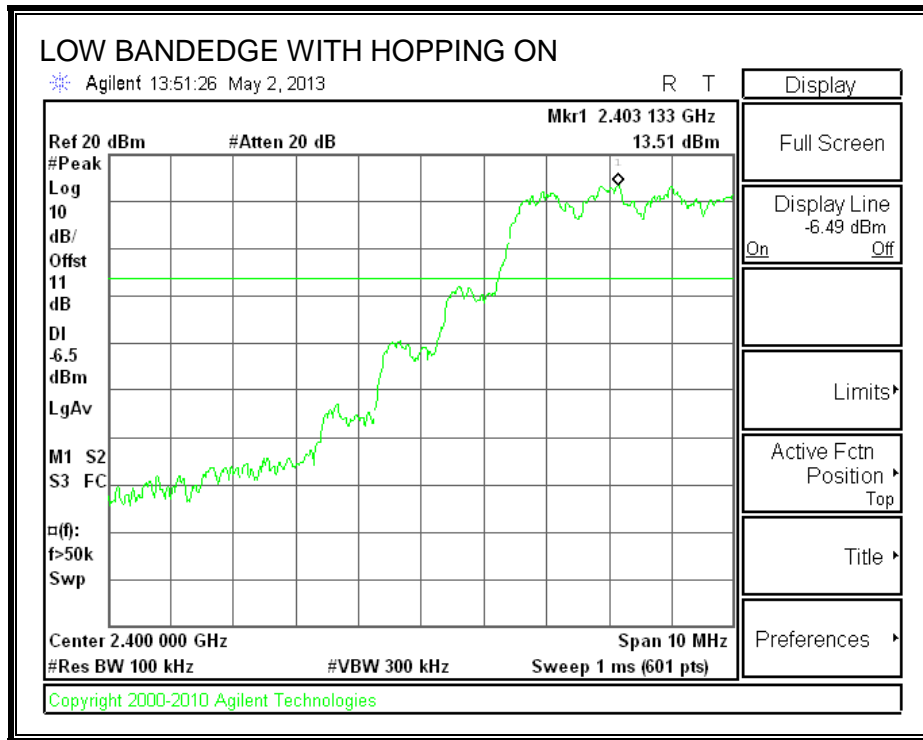

8. RADIATED TEST RESULTS

8.1. LIMITS AND PROCEDURE

LIMITS

FCC §15.205 and §15.209

IC RSS-210 Clause 2.6 (Transmitter)

IC RSS-GEN Clause 6 (Receiver)

Frequency Range (MHz)	Field Strength Limit (uV/m) at 3 m	Field Strength Limit (dBuV/m) at 3 m
30 - 88	100	40
88 - 216	150	43.5
216 - 960	200	46
Above 960	500	54

TEST PROCEDURE

The EUT is placed on a non-conducting table 80 cm above the ground plane. The antenna to EUT distance is 3 meters. The EUT is configured in accordance with ANSI C63.4. The EUT is set to transmit in a continuous mode.

For measurements below 1 GHz the resolution bandwidth is set to 100 kHz for peak detection measurements or 120 kHz for quasi-peak detection measurements. Peak detection is used unless otherwise noted as quasi-peak.

For measurements above 1 GHz the resolution bandwidth is set to 1 MHz, then the video bandwidth is set to 1 MHz for peak measurements and 10 Hz for average measurements.

The spectrum from 30 MHz to 26 GHz is investigated with the transmitter set to the lowest, middle, and highest channels in the 2.4 GHz band.

The frequency range of interest is monitored at a fixed antenna height and EUT azimuth. The EUT is rotated through 360 degrees to maximize emissions received. The antenna is scanned from 1 to 4 meters above the ground plane to further maximize the emission. Measurements are made with the antenna polarized in both the vertical and the horizontal positions.

RESULTS

For the Bandedge measurement, there is no need for the average reading since the peak reading passed with the peak limit. The average reading = peak reading – 20*log (1/duty cycle), and the 20*log (1/duty cycle) is greater than 20dB.

8.2. TRANSMITTER ABOVE 1 GHz

8.2.1. BASIC DATA RATE GFSK MODULATION

RESTRICTED BANDEDGE (LOW CHANNEL, HORIZONTAL)

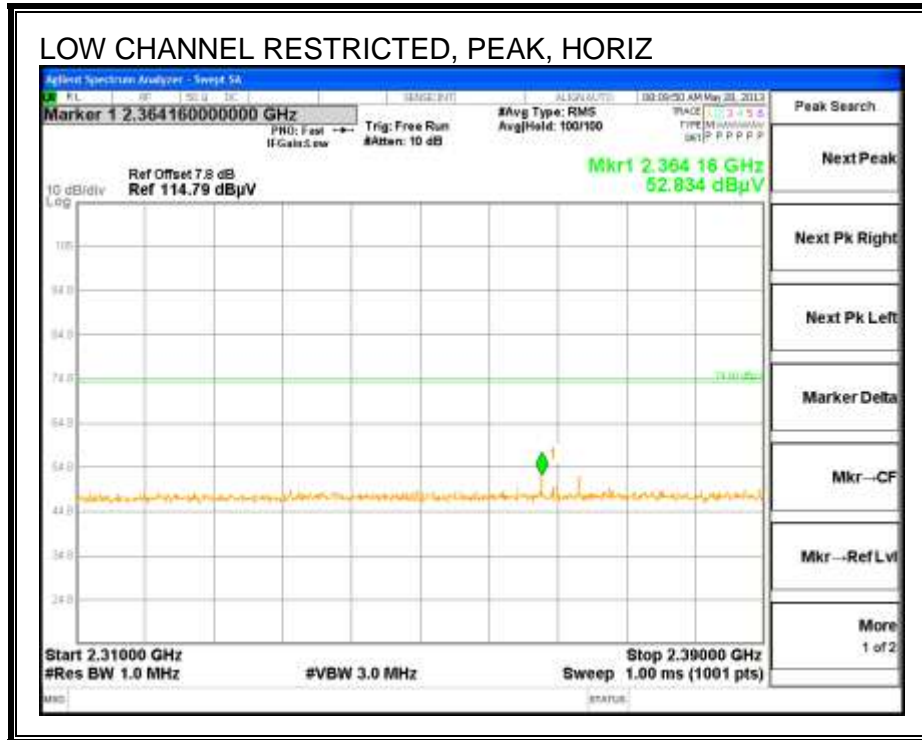

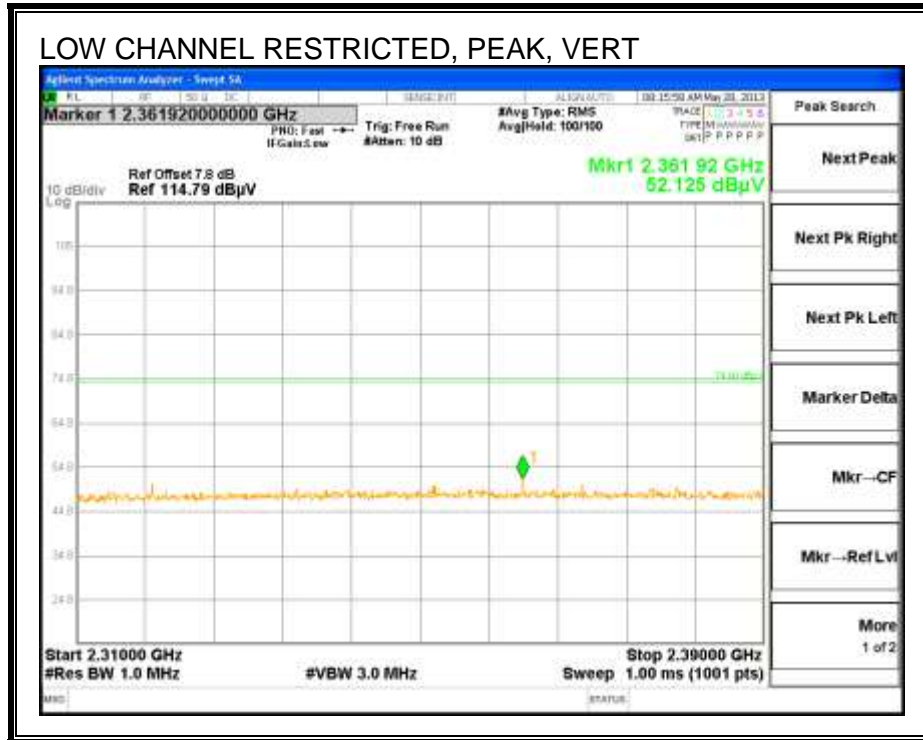

RESTRICTED BANDEDGE (HIGH CHANNEL)

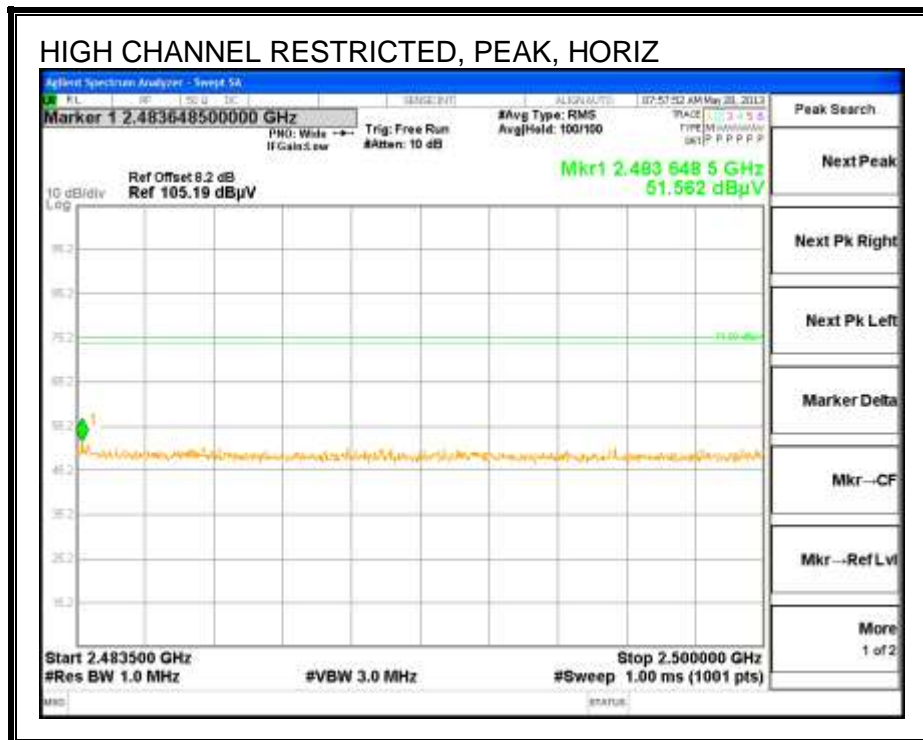

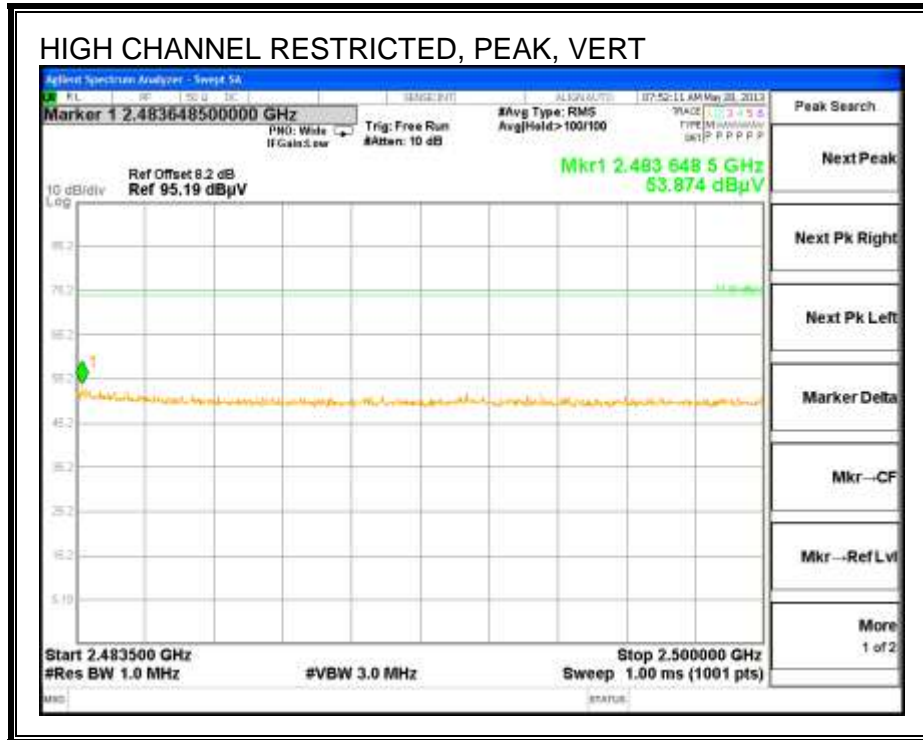

HARMONICS AND SPURIOUS EMISSIONS

LOW CHANNEL

HORIZONTAL PLOT

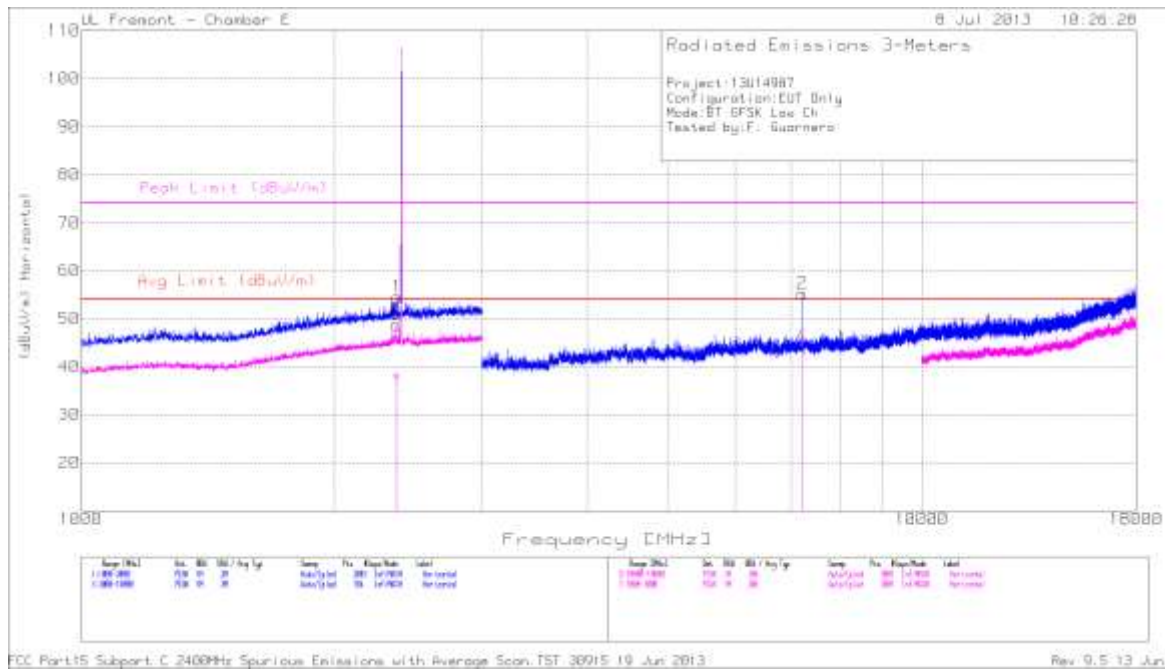

FCC Part15 Subpart C 2400MHz Spurious Emissions with Average Scan TST 30915 19 Jun 2011 Rev: 9.5 13 Jun 2011

Marker	Frequency (GHz)	Meter Reading (dBuV)	Det	AF T346 (dB/m)	Amp/Cbl/1 OdB Pad (dB)	Corrected Reading (dBuV/m)	Avg Limit (dBuV/m)	Margin (dB)	Peak Limit (dBuV/m)	Margin (dB)	Height (cm)	Polarity
2	7.207	48.61	PK	36	-29.4	55.21	53.97		74	-18.79	199	H
	7.206	40.61	Av	36	-29.4	47.21	53.97	-6.76	74	-26.79	164	H
5	2.37	40.63	PK	32.5	-24.4	48.73	53.97	-5.24	74	-25.27	199	H

Av - average detection
 PK - Peak detector

VERTICAL PLOT

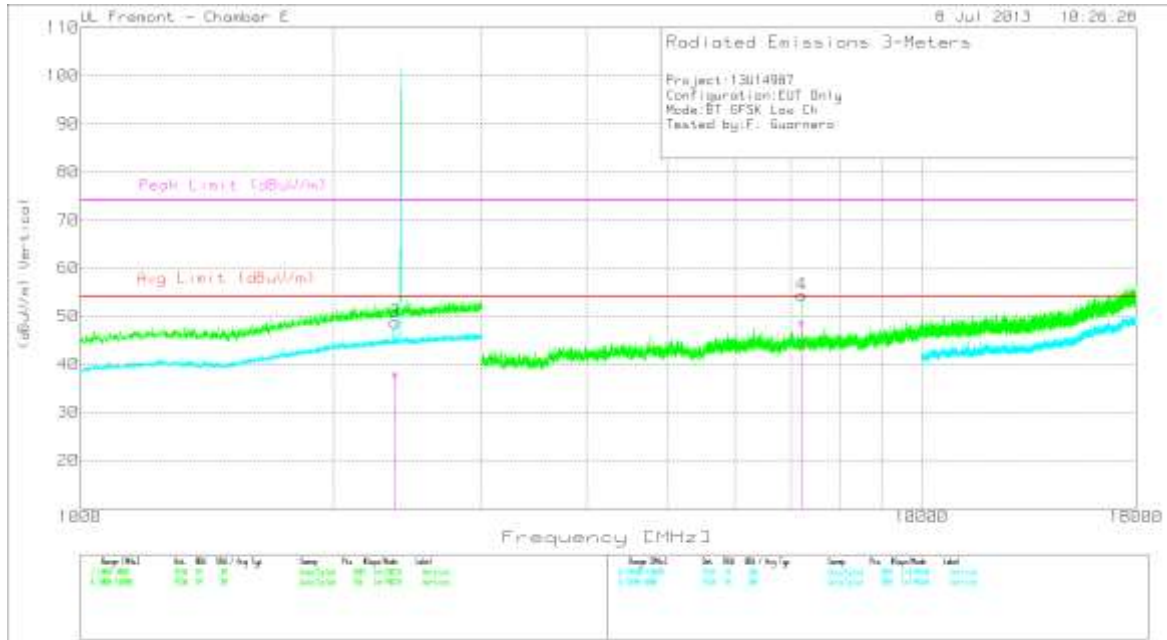

FCC Part15 Support: C 2400MHz Spurious Emissions with Average Scan TST 36915 19 Jun 2013 Rev: 9.5 13 Jun 2011

Marker	Frequency (GHz)	Meter Reading (dBuV)	Det	AF T346 (dB/m)	Amp/Cbl/3 GHz HPF (dB)	Corrected Reading (dBuV/m)	Avg Limit (dBuV/m)	Margin (dB)	Peak Limit (dBuV/m)	Margin (dB)	Height (cm)	Polarity
3	2.369	40.66	PK	32.5	-24.4	48.76	53.97	-5.21	74	-25.24	199	V
	2.368	29.63	Av	32.5	-24.4	37.73	53.97	-16.24	74	-36.27	338	V
4	7.206	47.86	PK	36	-29.4	54.46	53.97		74	-19.54	199	V
	7.206	41.88	Av	36	-29.4	48.48	53.97	-5.49	74	-25.52	217	V

Av - average detection
 PK - Peak detector

MID CHANNEL

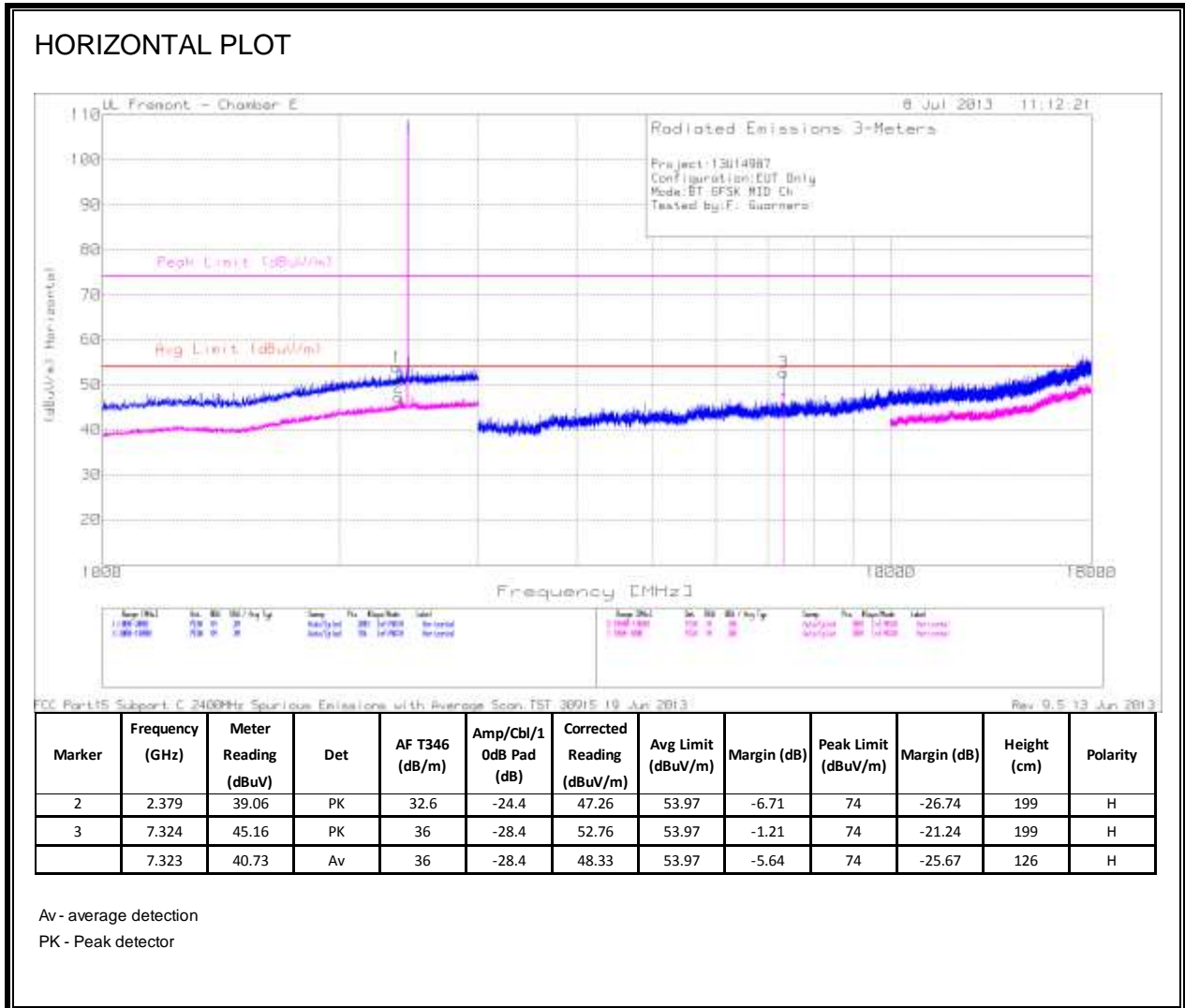

MID CHANNEL

VERTICAL PLOT

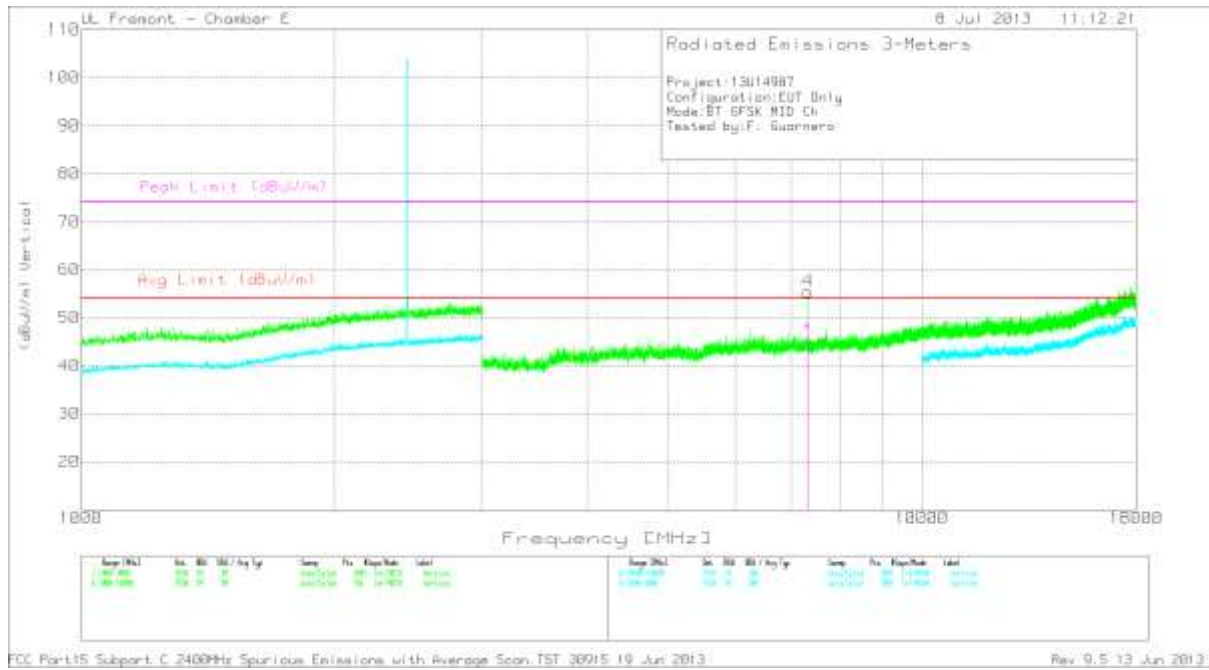

Marker	Frequency (GHz)	Meter Reading (dBuV)	Det	AF T346 (dB/m)	Amp/Cbl/3 GHz HPF (dB)	Corrected Reading (dBuV/m)	Avg Limit (dBuV/m)	Margin (dB)	Peak Limit (dBuV/m)	Margin (dB)	Height (cm)	Polarity
4	7.324	47.83	PK	36	-28.4	55.43	53.97		74	-18.57	199	V
	7.323	40.16	Av	36	-28.4	47.76	53.97	-6.21	74	-26.24	147	V

Av - average detection
 PK - Peak detector

HIGH CHANNEL

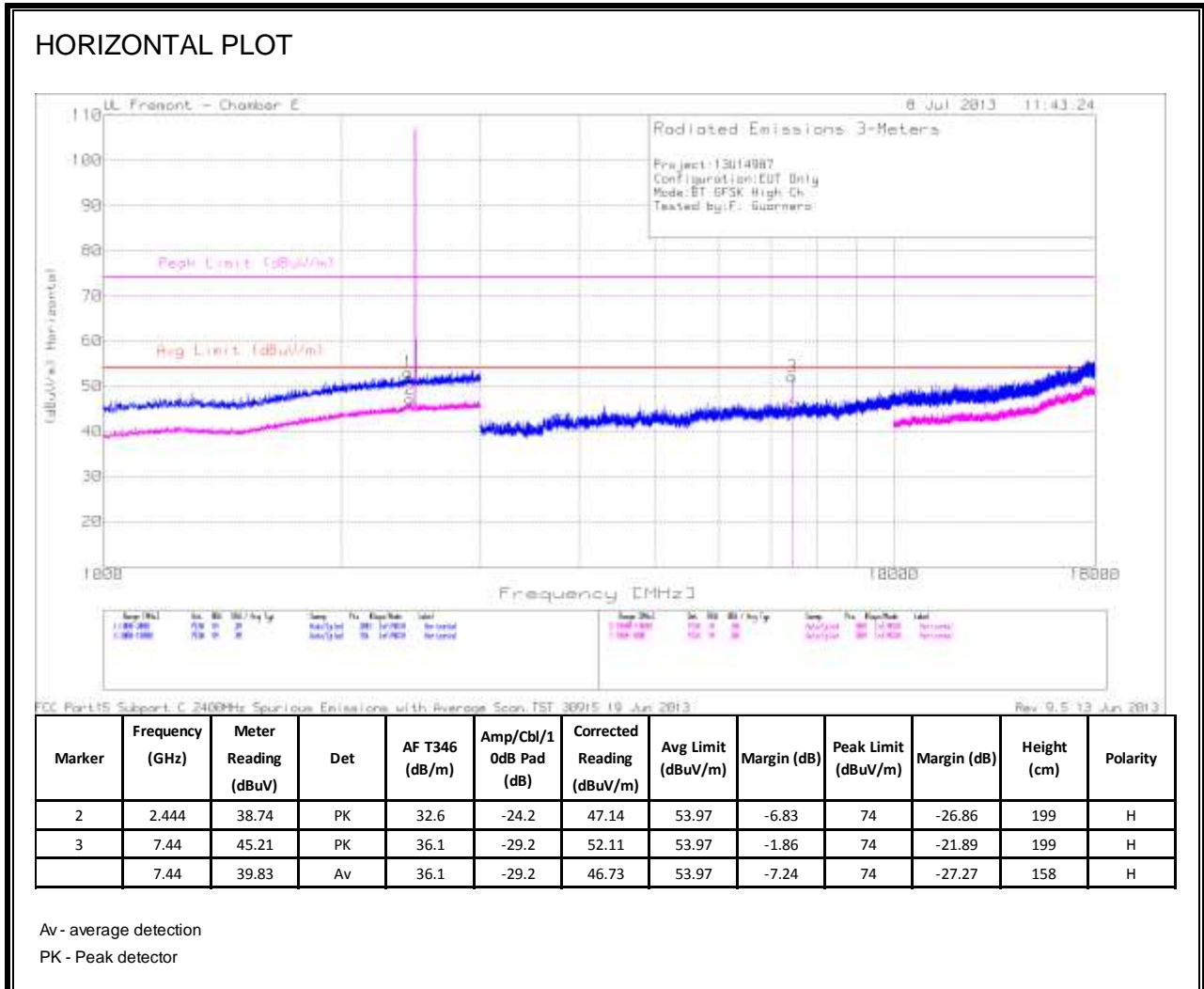

VERTICAL PLOT

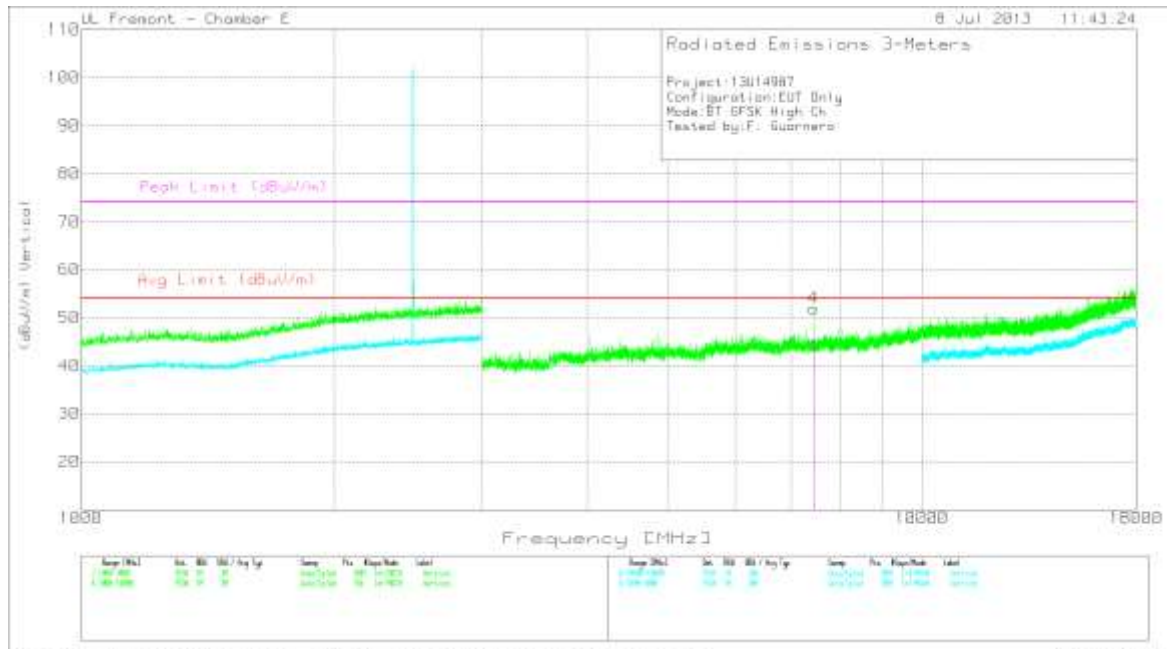

FCC Part15 Subpart C 2400MHz Spurious Emissions with Average Scan. TST 30915 19 Jun 2013 Rev: 0.5 13 Jun 2013

Marker	Frequency (GHz)	Meter Reading (dBuV)	Det	AF T346 (dB/m)	Amp/Cbl/3 GHz HPF (dB)	Corrected Reading (dBuV/m)	Avg Limit (dBuV/m)	Margin (dB)	Peak Limit (dBuV/m)	Margin (dB)	Height (cm)	Polarity
4	7.441	45.02	PK	36.1	-29.2	51.92	53.97	-2.05	74	-22.08	199	V
	7.44	37.99	Av	36.1	-29.2	44.89	53.97	-9.08	74	-29.11	172	V

Av - average detection
 PK - Peak detector

8.2.2. ENHANCED DATA RATE 8PSK MODULATION

RESTRICTED BANDEDGE (LOW CHANNEL)

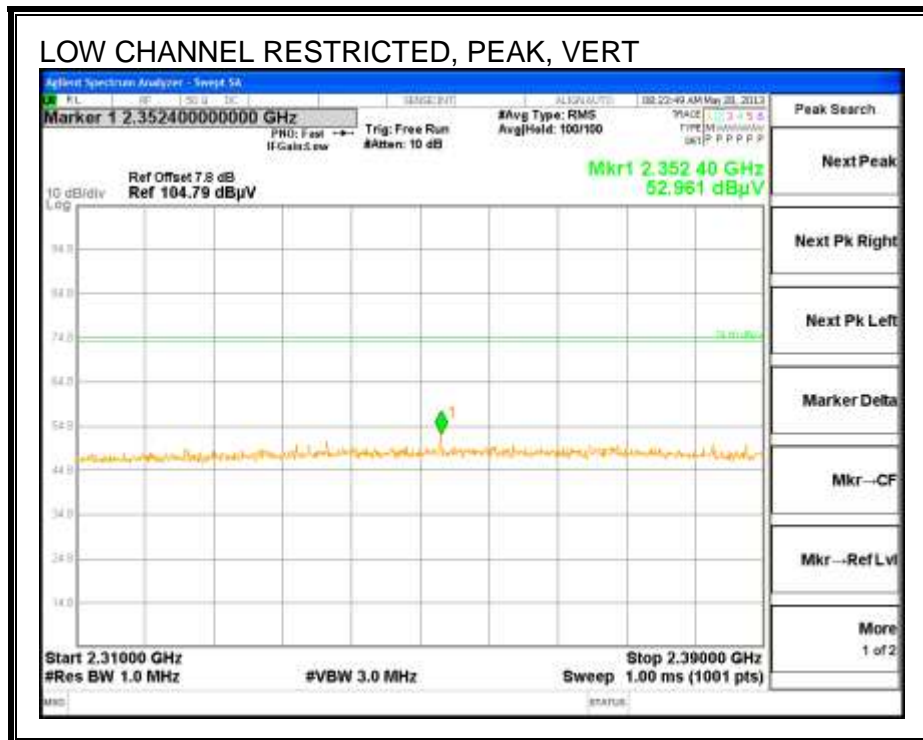
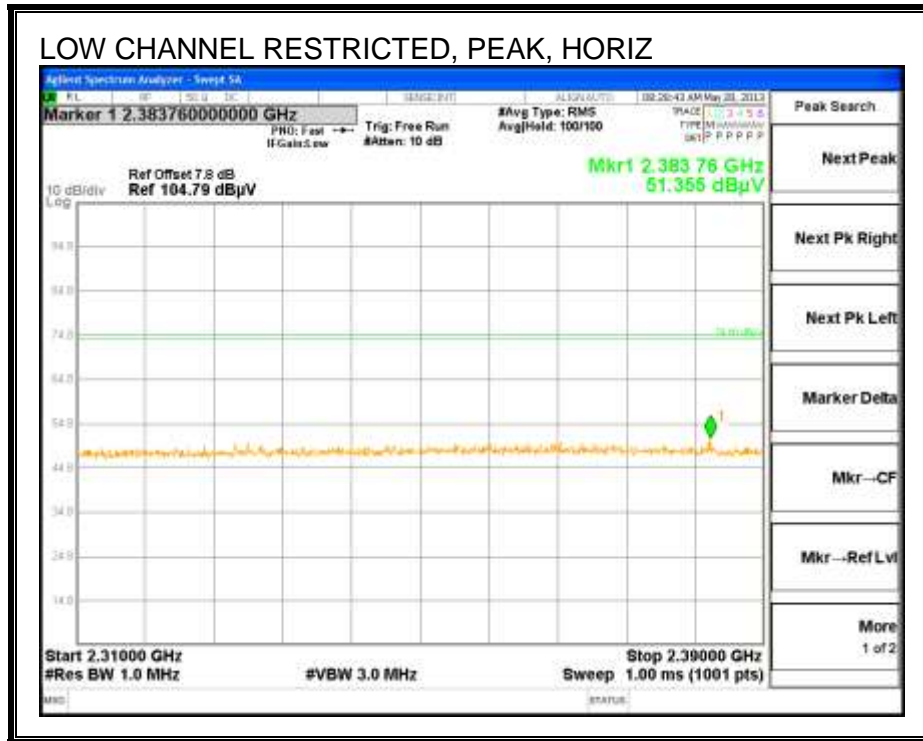

RESTRICTED BANDEDGE (HIGH CHANNEL, HORIZONTAL)

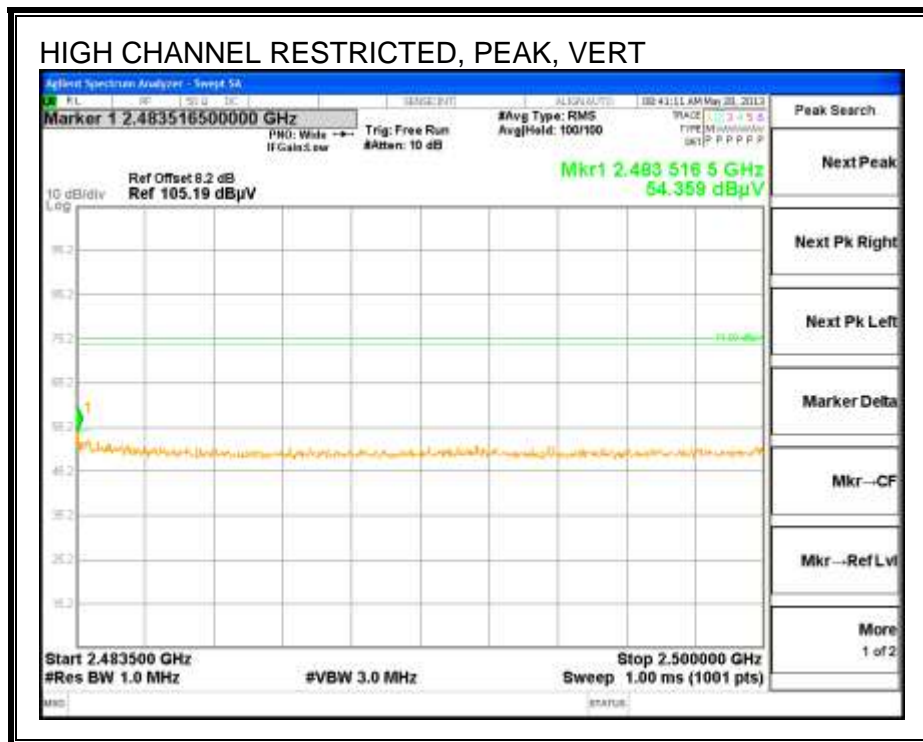
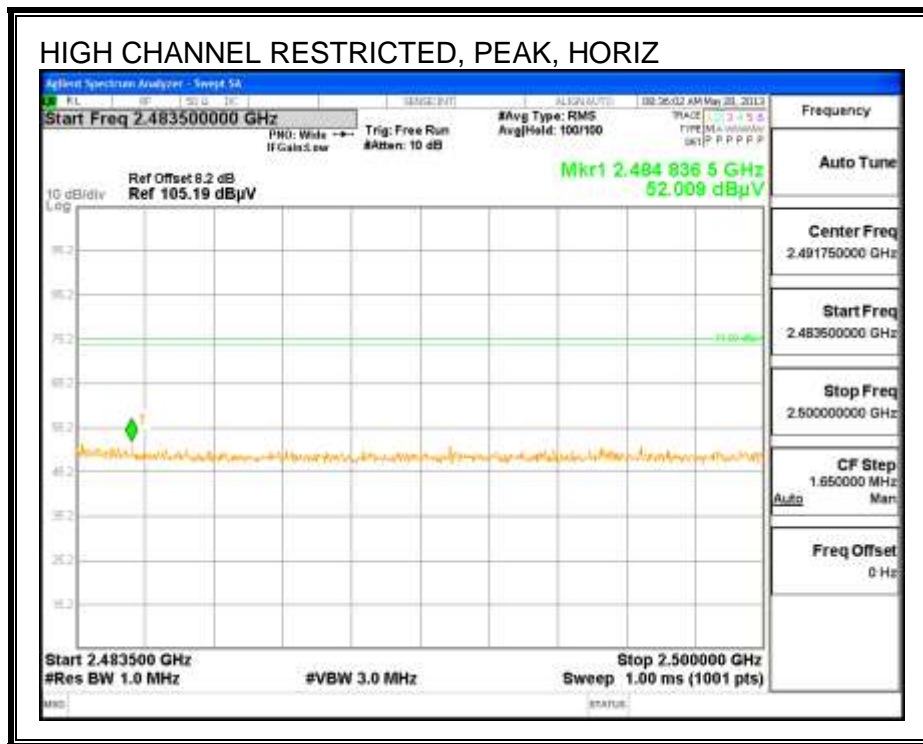

HARMONICS AND SPURIOUS EMISSIONS

LOW CHANNEL

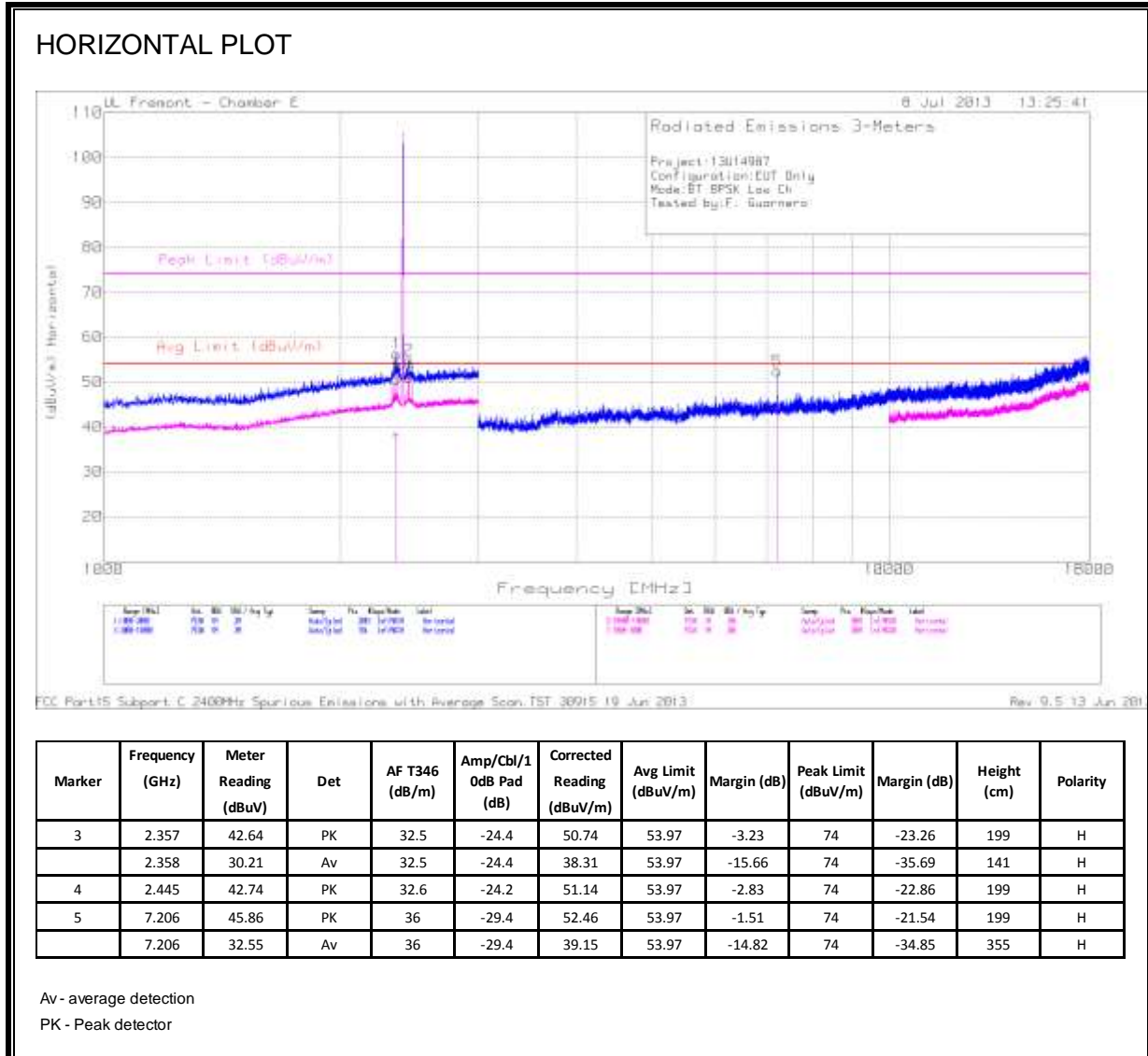

VERTICAL PLOT

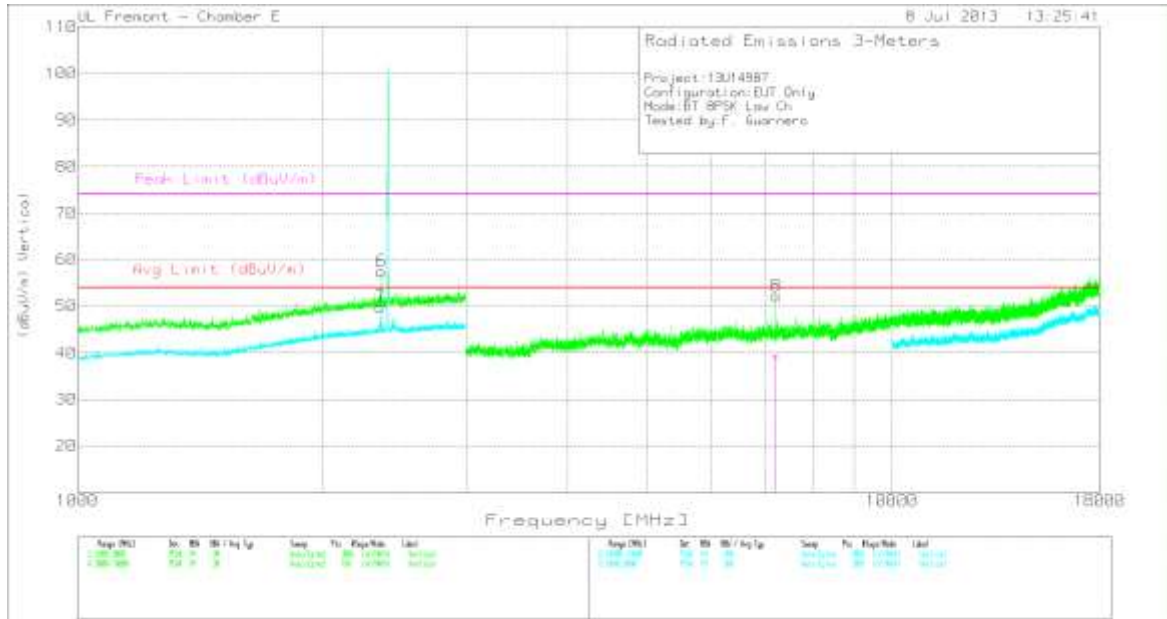

FCC Part 15, Subpart C, 2400MHz Spurious Emissions with Average Scan, TSE 30915 10 Jul 2013 Rev. 0.5 13 Jun 2013

Marker	Frequency (GHz)	Meter Reading (dBuV)	Det	AF T346 (dB/m)	Amp/Cbl/3 GHz HPF (dB)	Corrected Reading (dBuV/m)	Avg Limit (dBuV/m)	Margin (dB)	Peak Limit (dBuV/m)	Margin (dB)	Height (cm)	Polarity
7	2.354	41.66	PK	32.5	-24.4	49.76	53.97	-4.21	74	-24.24	199	V
8	7.207	45.59	PK	36	-29.4	52.19	53.97	-1.78	74	-21.81	199	V
	7.206	37.52	Av	36	-29.4	44.12	53.97	-9.85	74	-29.88	386	V

Av - average detection
 PK - Peak detector

MID CHANNEL

HORIZONTAL PLOT

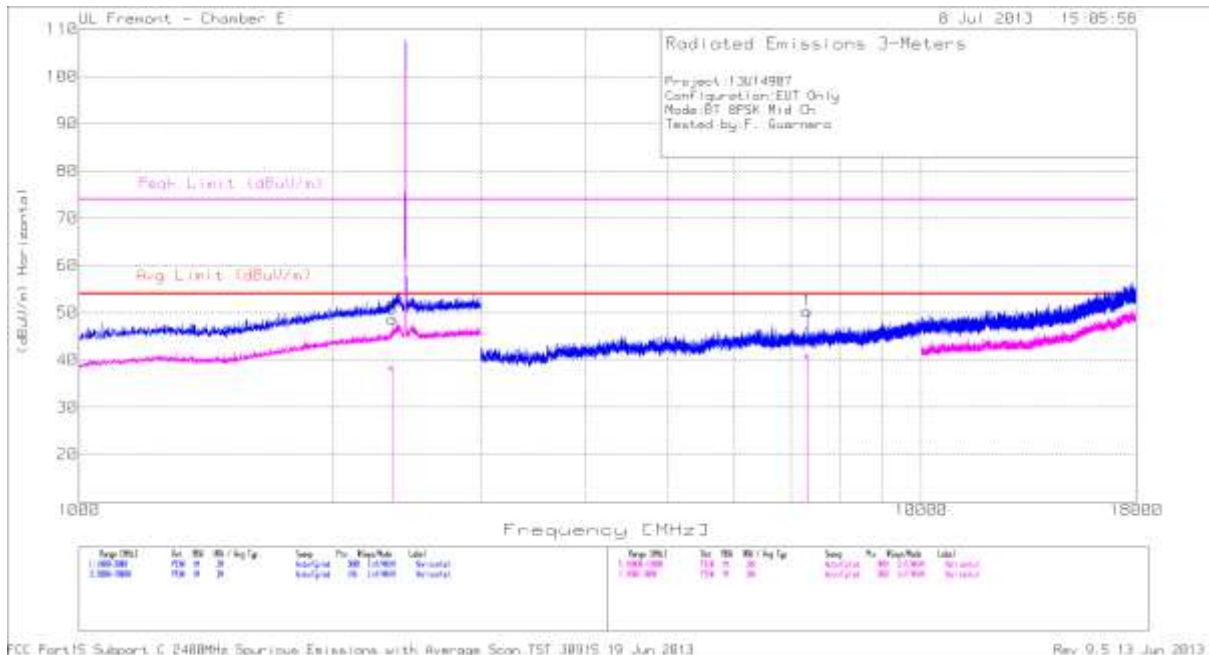

FCC Part 15 Subpart C 2400MHz Spurious Emissions with Average Scan TST 30915 19 Jun 2013

Rev 9.5 13 Jun 2013

Marker	Frequency (GHz)	Meter Reading (dBuV)	Det	AF T346 (dB/m)	Amp/Cbl/1 Odb Pad (dB)	Corrected Reading (dBuV/m)	Avg Limit (dBuV/m)	Margin (dB)	Peak Limit (dBuV/m)	Margin (dB)	Height (cm)	Polarity
1	7.324	42.7	PK	36	-28.4	50.3	53.97	-3.67	74	-23.7	199	H
	7.323	33.02	Av	36	-28.4	40.62	53.97	-13.35	74	-33.38	156	H
3	2.354	40.62	PK	32.5	-24.4	48.72	53.97	-5.25	74	-25.28	182	H
	2.352	30.1	Av	32.5	-24.4	38.2	53.97	-15.77	74	-35.8	162	H

Av - average detection
 PK - Peak detector

MID CHANNEL

VERTICAL PLOT

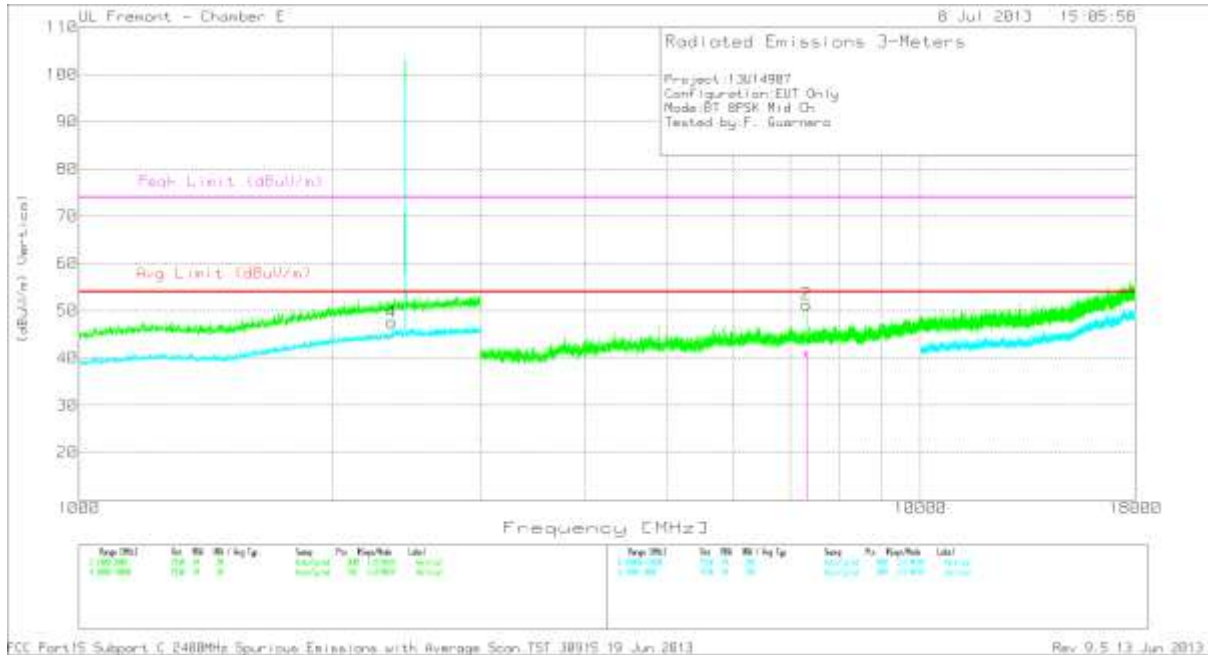

Marker	Frequency (GHz)	Meter Reading (dBuV)	Det	AF T346 (dB/m)	Amp/Cbl/3 GHz HPF (dB)	Corrected Reading (dBuV/m)	Avg Limit (dBuV/m)	Margin (dB)	Peak Limit (dBuV/m)	Margin (dB)	Height (cm)	Polarity
2	7.323	43.75	PK	36	-28.4	51.35	53.97	-2.62	74	-22.65	199	V
	7.323	33.27	Av	36	-28.4	40.87	53.97	-13.1	74	-33.13	152	V
4	2.353	39.47	PK	32.5	-24.4	47.57	53.97	-6.4	74	-26.43	100	V

Av - average detection
 PK - Peak detector

HIGH CHANNEL

HORIZONTAL PLOT

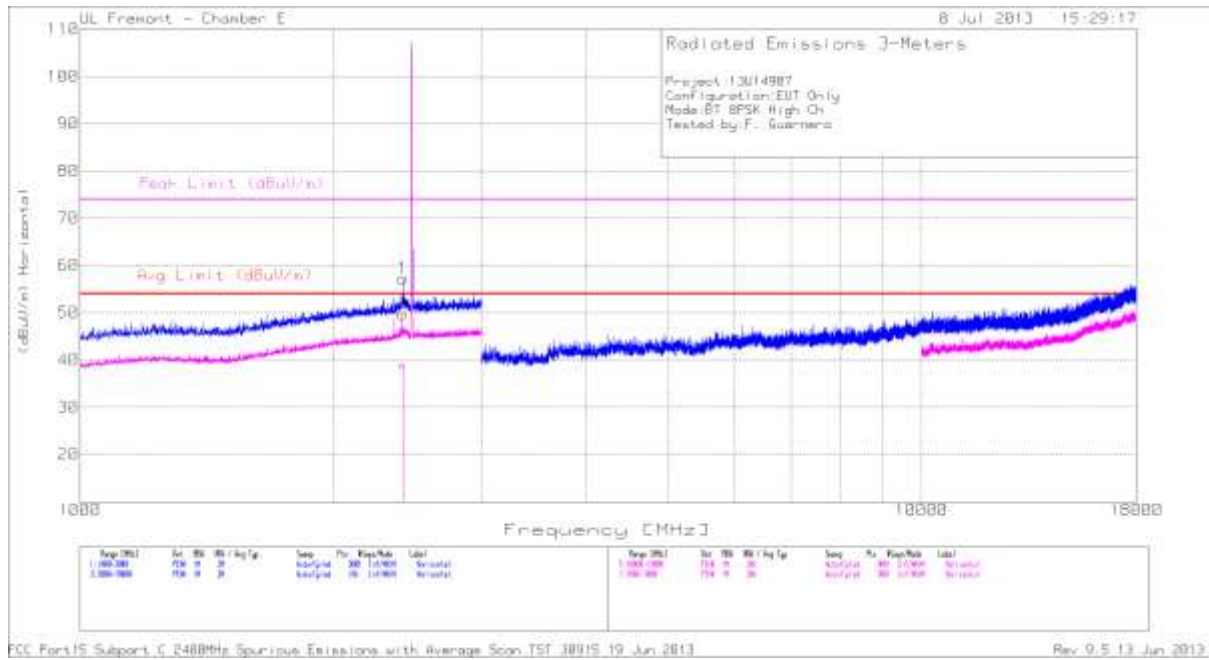

FCC Part 15 Subpart C 2400MHz Spurious Emissions with Average Scan TST 38915 19 Jun 2013

Rev 9.5 13 Jun 2013

Marker	Frequency (GHz)	Meter Reading (dBuV)	Det	AF T346 (dB/m)	Amp/Cbl/1 0dB Pad (dB)	Corrected Reading (dBuV/m)	Avg Limit (dBuV/m)	Margin (dB)	Peak Limit (dBuV/m)	Margin (dB)	Height (cm)	Polarity
3	2.417	41.45	PK	32.6	-24.3	49.75	53.97	-4.22	74	-24.25	199	H
	2.418	30.45	Av	32.6	-24.3	38.75	53.97	-15.22	74	-35.25	229	H

Av - average detection
 PK - Peak detector

VERTICAL PLOT

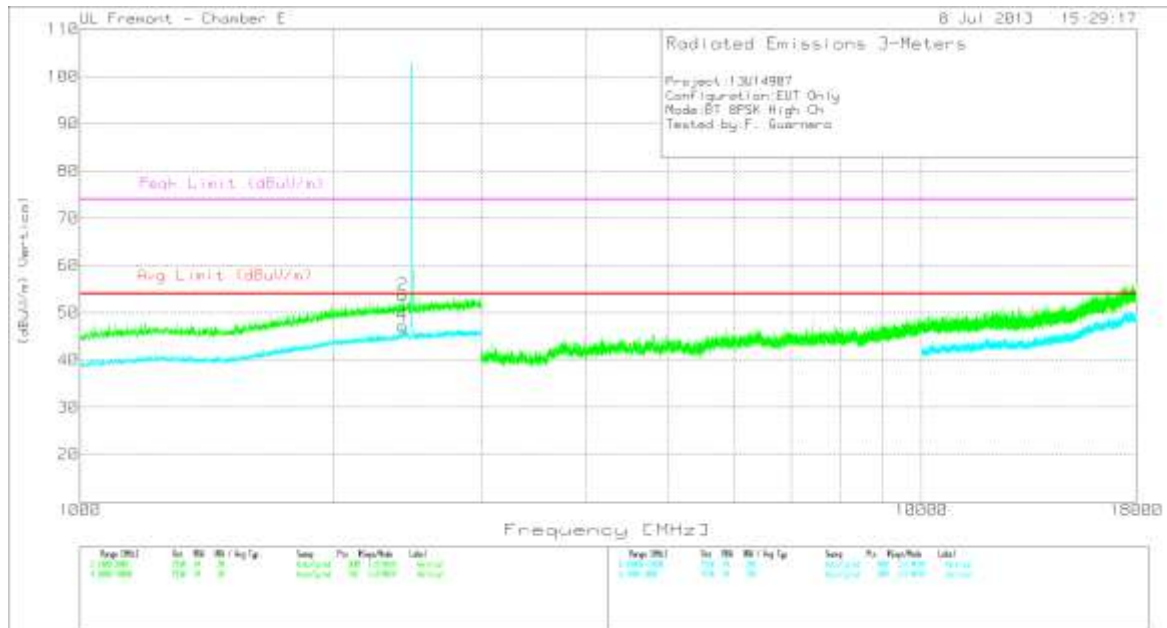

FCC Part 15 Subpart C 2400MHz Spurious Emissions with Average Scan TEST 38915 19 Jun 2013 Rev 9.5 13 Jun 2013

Marker	Frequency (GHz)	Meter Reading (dBuV)	Det	AF T346 (dB/m)	Amp/Cbl/1 OdB Pad (dB)	Corrected Reading (dBuV/m)	Avg Limit (dBuV/m)	Margin (dB)	Peak Limit (dBuV/m)	Margin (dB)	Height (cm)	Polarity
4	2.417	38.91	PK	32.6	-24.3	47.21	53.97	-6.76	74	-26.79	199	V

PK - Peak detector
 Av - average detection

8.3. WORST-CASE BELOW 1 GHz

SPURIOUS EMISSIONS 30 TO 1000 MHz (WORST-CASE CONFIGURATION, HORIZONTAL)

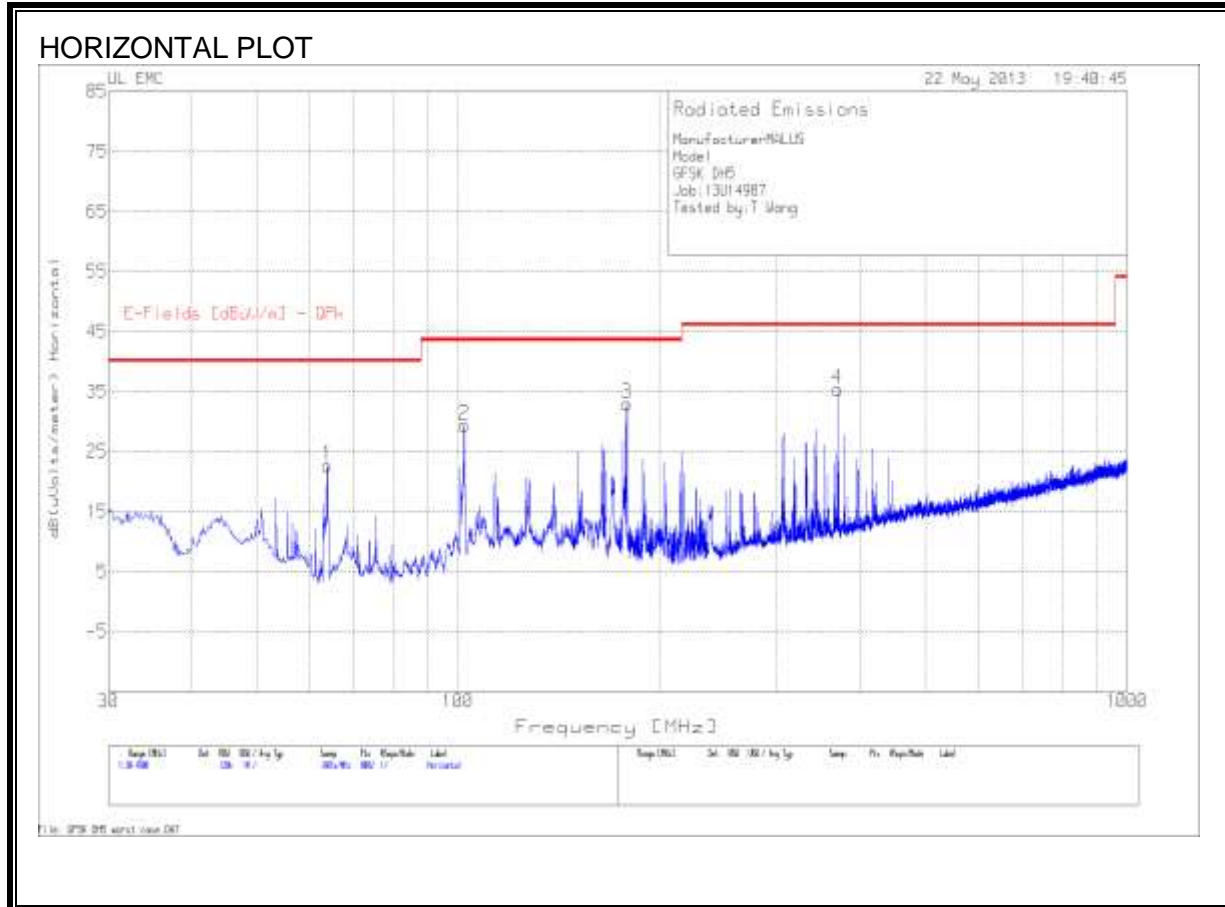

SPURIOUS EMISSIONS 30 TO 1000 MHz (WORST-CASE CONFIGURATION, VERTICAL)

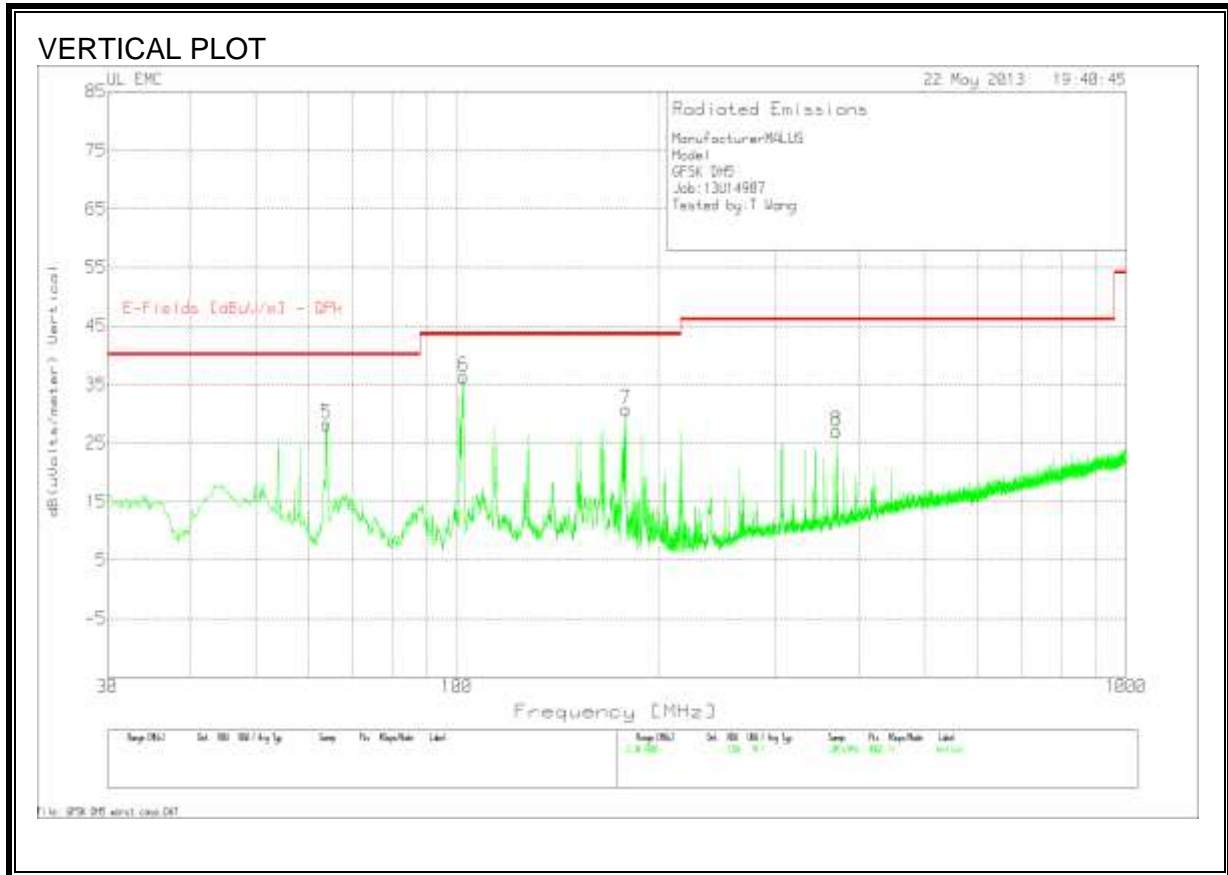

HORIZONTAL AND VERTICAL DATA										
GFSK DHS										
Job:13U14987										
Tested by:T Wang										
Horizontal 30 - 1000MHz										
Marker No.	Test Frequency	Meter Reading	Detector	T122 Antenna Factor (dB/m)	Preamp and Cable (dB)	dB(uVolts/meter)	E-Fields [dBuV/m] - QPk	Margin (dB)	Height [cm]	Polarity
1	63.8245	46.77	PK	7.8	-31.9	22.67	40	-17.33	400	Horz
2	102.1347	49.99	PK	11	-31.6	29.39	43.52	-14.13	200	Horz
3	178.7552	52.94	PK	11.2	-31.2	32.94	43.52	-10.58	300	Horz
4	369.2151	50.97	PK	15	-30.6	35.37	46.02	-10.65	200	Horz
Vertical 30 - 1000MHz										
Marker No.	Test Frequency	Meter Reading	Detector	T122 Antenna Factor (dB/m)	Preamp and Cable (dB)	dB(uVolts/meter)	E-Fields [dBuV/m] - QPk	Margin (dB)	Height [cm]	Polarity
5	63.8245	52.3	PK	7.8	-31.9	28.2	40	-11.8	300	Vert
6	102.256	56.86	PK	11.1	-31.6	36.36	43.52	-7.16	200	Vert
7	178.8764	50.74	PK	11.2	-31.2	30.74	43.52	-12.78	300	Vert
8	369.0939	42.64	PK	15	-30.6	27.04	46.02	-18.98	200	Vert

9. AC POWER LINE CONDUCTED EMISSIONS

LIMITS

FCC §15.207 (a)

RSS-Gen 7.2.2

Frequency of Emission (MHz)	Conducted Limit (dBuV)	
	Quasi-peak	Average
0.15-0.5	66 to 56*	56 to 46*
0.5-5	56	46
5-30	60	50

*Decreases with the logarithm of the frequency.

TEST PROCEDURE

The EUT is placed on a non-conducting table 40 cm from the vertical ground plane and 80 cm above the horizontal ground plane. The EUT is configured in accordance with ANSI C63.4.

The receiver is set to a resolution bandwidth of 9 kHz. Peak detection is used unless otherwise noted as quasi-peak or average.

Line conducted data is recorded for both NEUTRAL and HOT lines.

RESULTS

6 WORST EMISSIONS

BLUETOOTH									
Project No:13U14987									
Client Name:									
Model/Device:BT Worst Case									
Test Volt/Freq:115 VAC/ 60Hz									
Test By:Mona Hua									
Line-L1 .15 - 30MHz									
Test Frequency (MHz)	Meter Reading (dBuV)	Detector	T24 IL L1 (dB)	LC Cables 1&3 (dB)	dB(uVols)	CISPR 11/22 Class B Quasi-peak	Margin	CISPR 11/22 Class B Average	Margin
0.159	49.08	PK	0.1	0	49.18	65.5	-16.32	-	-
0.159	35.1	Av	0.1	0	35.2	-	-	55.5	-20.3
0.7305	45.56	PK	0.1	0	45.66	56	-10.34	-	-
0.7305	30.85	Av	0.1	0	30.95	-	-	46	-15.05
0.8205	45.82	PK	0.1	0	45.92	56	-10.08	-	-
0.8205	26.99	Av	0.1	0	27.09	-	-	46	-18.91
4.8615	40.63	PK	0.1	0.1	40.83	56	-15.17	-	-
4.8615	23.5	Av	0.1	0.1	23.7	-	-	46	-22.3
17.6775	39.17	PK	0.2	0.2	39.57	60	-20.43	-	-
17.6775	23.96	Av	0.2	0.2	24.36	-	-	50	-25.64
Line-L2 .15 - 30MHz									
Test Frequency (MHz)	Meter Reading (dBuV)	Detector	T24 IL L1 (dB)	LC Cables 1&3 (dB)	dB(uVols)	CISPR 11/22 Class B Quasi-peak	Margin	CISPR 11/22 Class B Average	Margin
0.1635	48.71	PK	0.1	0	48.81	65.3	-16.49	-	-
0.1635	29.35	Av	0.1	0	29.45	-	-	55.3	-25.85
0.8025	46.5	PK	0.1	0	46.6	56	-9.4	-	-
0.8025	25.07	Av	0.1	0	25.17	-	-	46	-20.83
6.2205	39.14	PK	0.1	0.1	39.34	60	-20.66	-	-
6.2205	23.27	Av	0.1	0.1	23.47	-	-	50	-26.53
17.8575	39.86	PK	0.2	0.2	40.26	60	-19.74	-	-
17.8575	17.83	Av	0.2	0.2	18.23	-	-	50	-31.77
PK - Peak detector									
Av - Average detector									

LINE 1 RESULTS

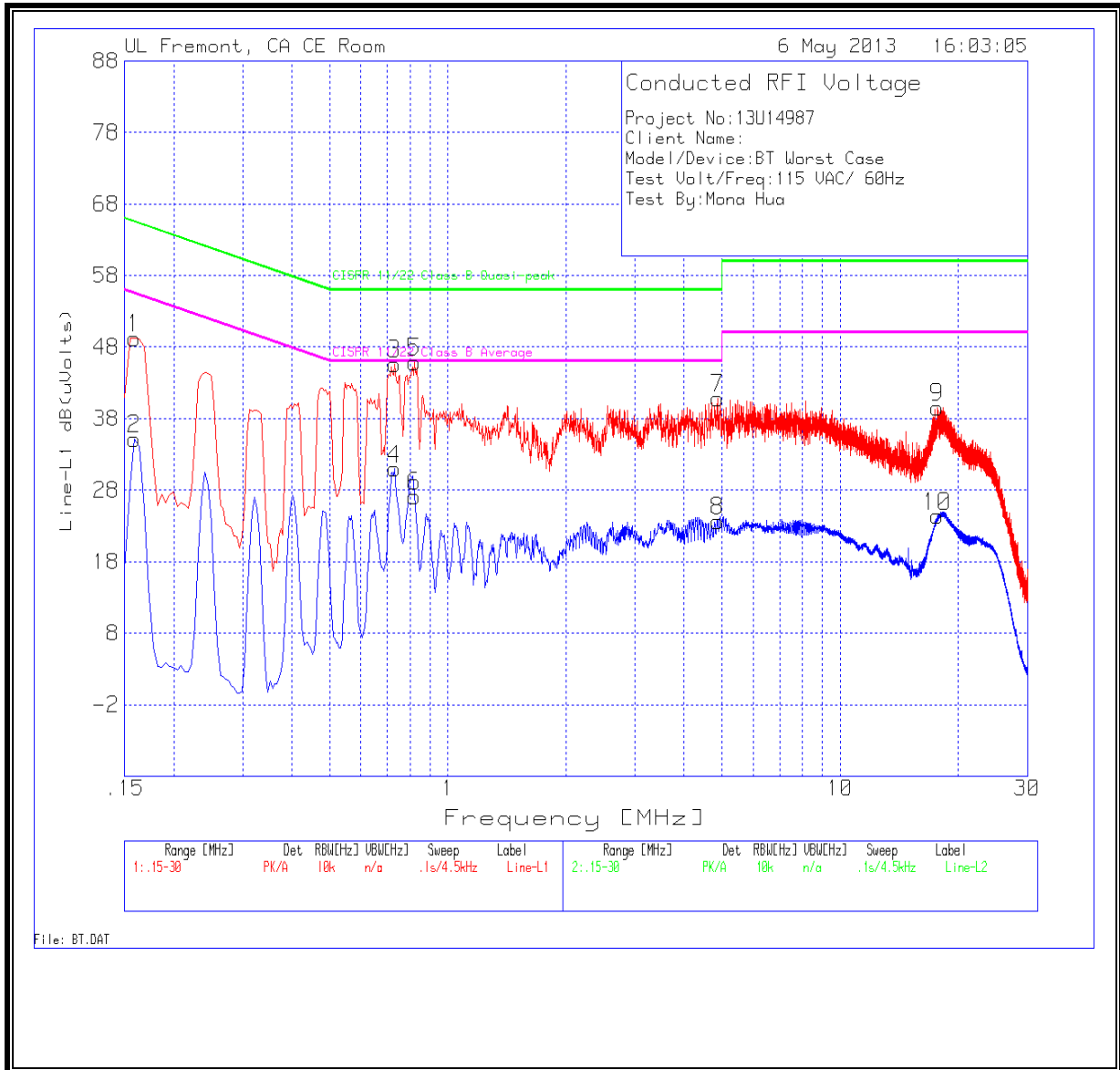

LINE 2 RESULTS

