

SystemPerformanceCheck-D1750V2 SN 1050

Frequency: 1750 MHz; Duty Cycle: 1:1; Room Ambient Temperature: 24.0°C; Liquid Temperature: 23.0°C

Medium parameters used: $f = 1750$ MHz; $\sigma = 1.346$ mho/m; $\epsilon_r = 41.076$; $\rho = 1000$ kg/m³

DASY5 Configuration:

- Area Scan setting - Find Secondary Maximum Within: 2.0 dB and with a peak SAR value greater than 0.0012W/kg
- Electronics: DAE4 Sn1239; Calibrated: 6/6/2012
- Probe: EX3DV4 - SN3773; ConvF(7.89, 7.89, 7.89); Calibrated: 3/14/2012
- Sensor-Surface: 2.5mm (Mechanical Surface Detection (Locations From Previous Scan Used)), Sensor-Surface: 2.5mm (Mechanical Surface Detection)
- Phantom: SAM v5.0 (A); Type: QD000P40CC; Serial: 1602

Head/Pin=100 mW/Area Scan (7x7x1): Measurement grid: dx=15mm, dy=15mm

Maximum value of SAR (measured) = 3.903 mW/g

Head/Pin=100 mW/Zoom Scan (7x7x7)/Cube 0: Measurement grid: dx=5mm, dy=5mm, dz=5mm

Reference Value = 53.713 V/m; Power Drift = 0.14 dB

Peak SAR (extrapolated) = 6.2350

SAR(1 g) = 3.45 mW/g; SAR(10 g) = 1.83 mW/g

Maximum value of SAR (measured) = 4.580 mW/g

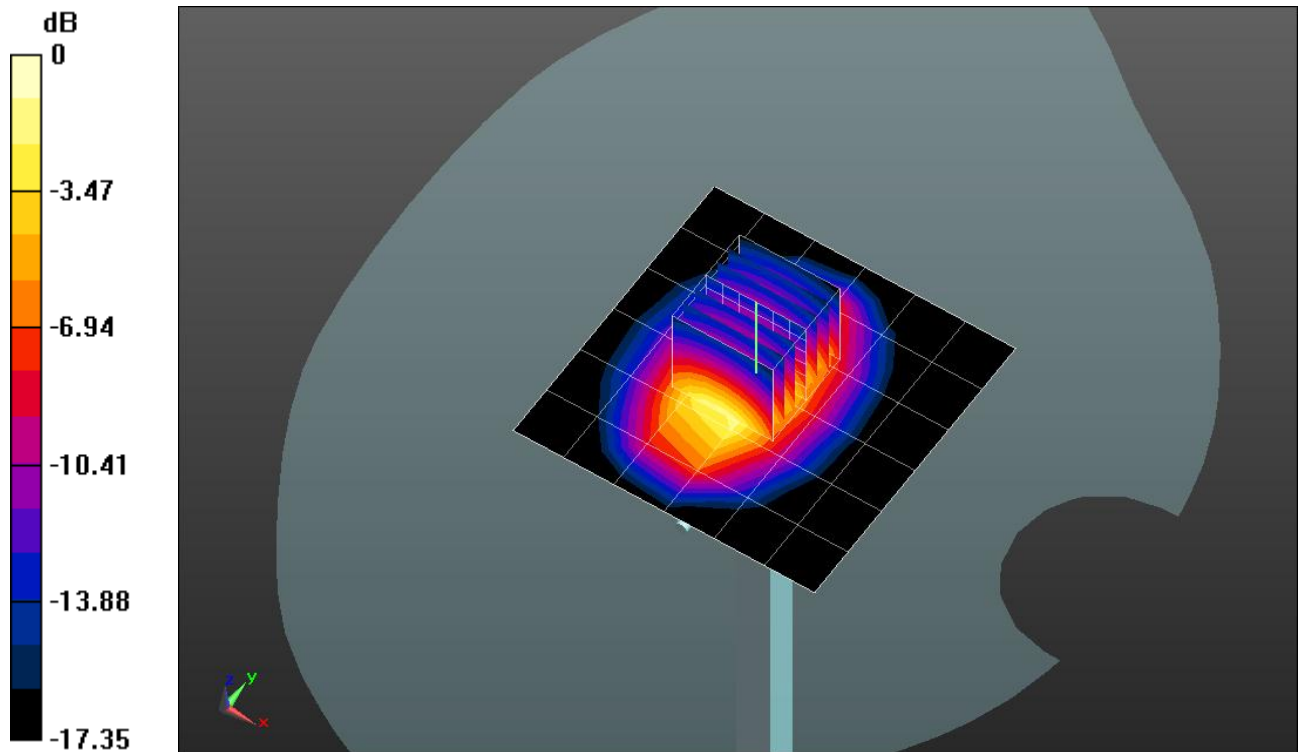

0 dB = 4.580mW/g = 13.22 dB mW/g

SystemPerformanceCheck-D1750V2 SN 1050

Frequency: 1750 MHz; Duty Cycle: 1:1

Head/Pin=100 mW/Z Scan (1x1x21): Measurement grid: dx=20mm, dy=20mm, dz=5mm
Maximum value of SAR (measured) = 3.746 mW/g

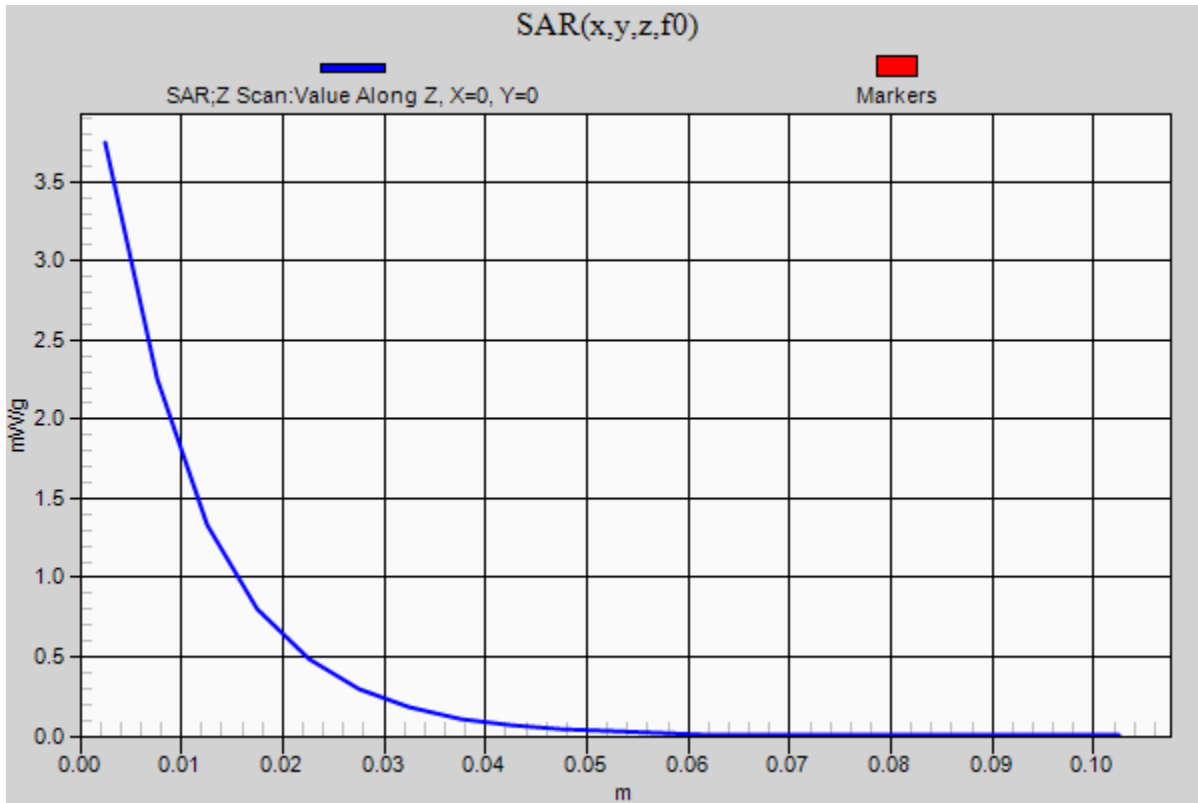

20120831_SystemPerformanceCheck-D835V2 SN 4d002

Frequency: 835 MHz; Duty Cycle: 1:1; Room Ambient Temperature: 24.0°C; Liquid Temperature: 23.0°C

Medium parameters used: $f = 835$ MHz; $\sigma = 0.982$ mho/m; $\epsilon_r = 55.221$; $\rho = 1000$ kg/m³

DASY5 Configuration:

- Area Scan setting - Find Secondary Maximum Within: 2.0 dB and with a peak SAR value greater than 0.0012W/kg
- Electronics: DAE4 Sn1259; Calibrated: 2/13/2012
- Probe: EX3DV4 - SN3686; ConvF(8.73, 8.73, 8.73); Calibrated: 2/16/2012
- Sensor-Surface: 2.5mm (Mechanical Surface Detection (Locations From Previous Scan Used)), Sensor-Surface: 2.5mm (Mechanical Surface Detection)
- Phantom: ELI v5.0 (B); Type: QDOVA001BB; Serial: 1118

Body/Pin=100 mW/Area Scan (7x7x1): Measurement grid: dx=15mm, dy=15mm

Maximum value of SAR (measured) = 0.990 mW/g

Body/Pin=100 mW/Zoom Scan (7x7x7)/Cube 0: Measurement grid: dx=5mm, dy=5mm, dz=5mm

Reference Value = 34.342 V/m; Power Drift = 0.00025 dB

Peak SAR (extrapolated) = 1.4070

SAR(1 g) = 0.950 mW/g; SAR(10 g) = 0.625 mW/g

Maximum value of SAR (measured) = 1.155 mW/g

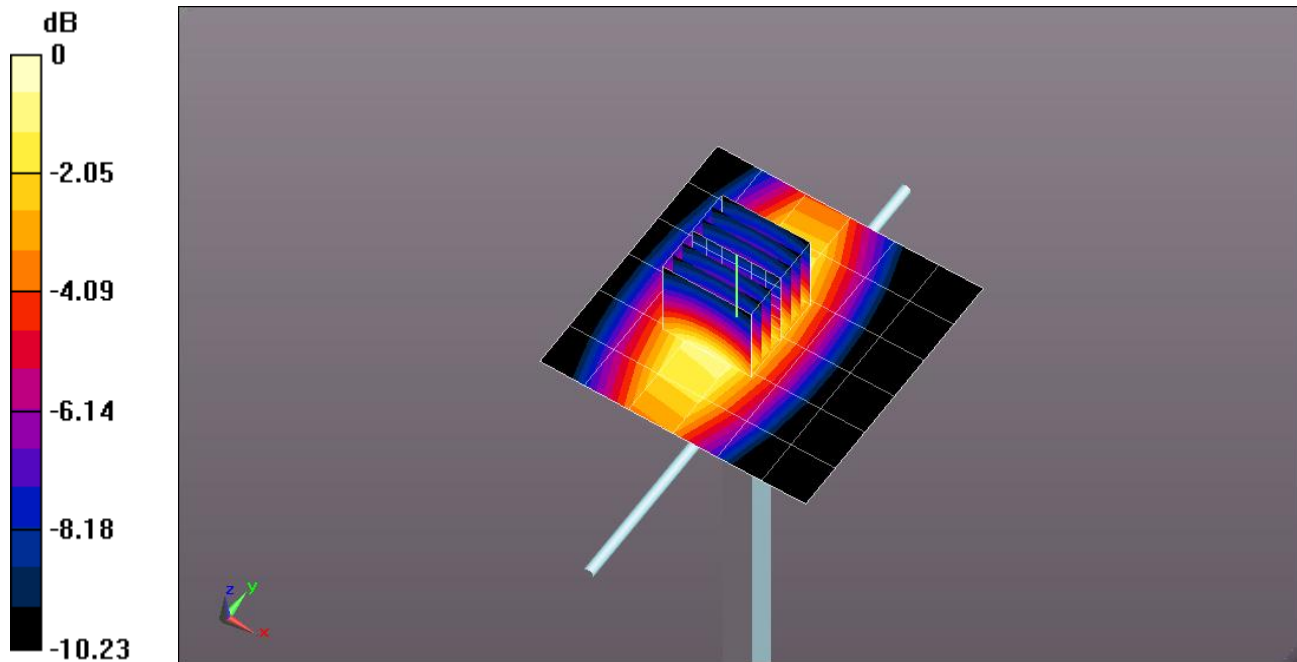

0 dB = 1.160mW/g = 1.29 dB mW/g

20120831_SystemPerformanceCheck-D835V2 SN 4d002

Frequency: 835 MHz; Duty Cycle: 1:1

Body/Pin=100 mW/Z Scan (1x1x21): Measurement grid: dx=20mm, dy=20mm, dz=5mm
Maximum value of SAR (measured) = 0.796 mW/g

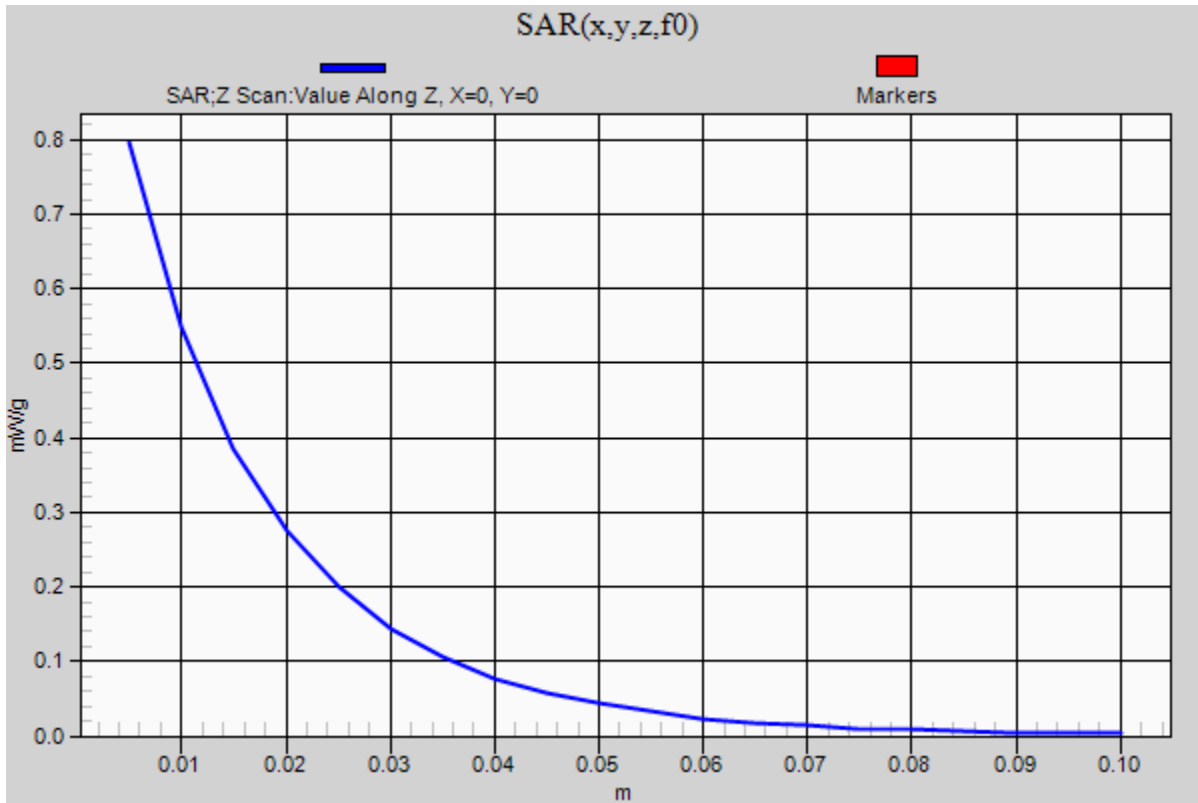

20120901_SystemPerformanceCheck-D1750V2 SN 1050

Frequency: 1750 MHz; Duty Cycle: 1:1; Room Ambient Temperature: 24.0°C; Liquid Temperature: 23.0°C
 Medium parameters used: $f = 1750 \text{ MHz}$; $\sigma = 1.331 \text{ mho/m}$; $\epsilon_r = 39.725$; $\rho = 1000 \text{ kg/m}^3$

DASY5 Configuration:

- Area Scan setting - Find Secondary Maximum Within: 2.0 dB and with a peak SAR value greater than 0.0012W/kg
- Electronics: DAE4 Sn1239; Calibrated: 6/6/2012
- Probe: EX3DV4 - SN3772; ConvF(7.79, 7.79, 7.79); Calibrated: 2/16/2012
- Sensor-Surface: 2.5mm (Mechanical Surface Detection)
- Phantom: SAM v5.0 (A); Type: QD000P40CC; Serial: 1602

Head/Pin=100 mW/Area Scan (7x7x1): Measurement grid: dx=15mm, dy=15mm

Maximum value of SAR (measured) = 4.093 mW/g

Head/Pin=100 mW/Zoom Scan (7x7x7)/Cube 0: Measurement grid: dx=5mm, dy=5mm, dz=5mm

Reference Value = 55.988 V/m; Power Drift = 0.13 dB

Peak SAR (extrapolated) = 6.6200

SAR(1 g) = 3.57 mW/g; SAR(10 g) = 1.88 mW/g

Maximum value of SAR (measured) = 4.786 mW/g

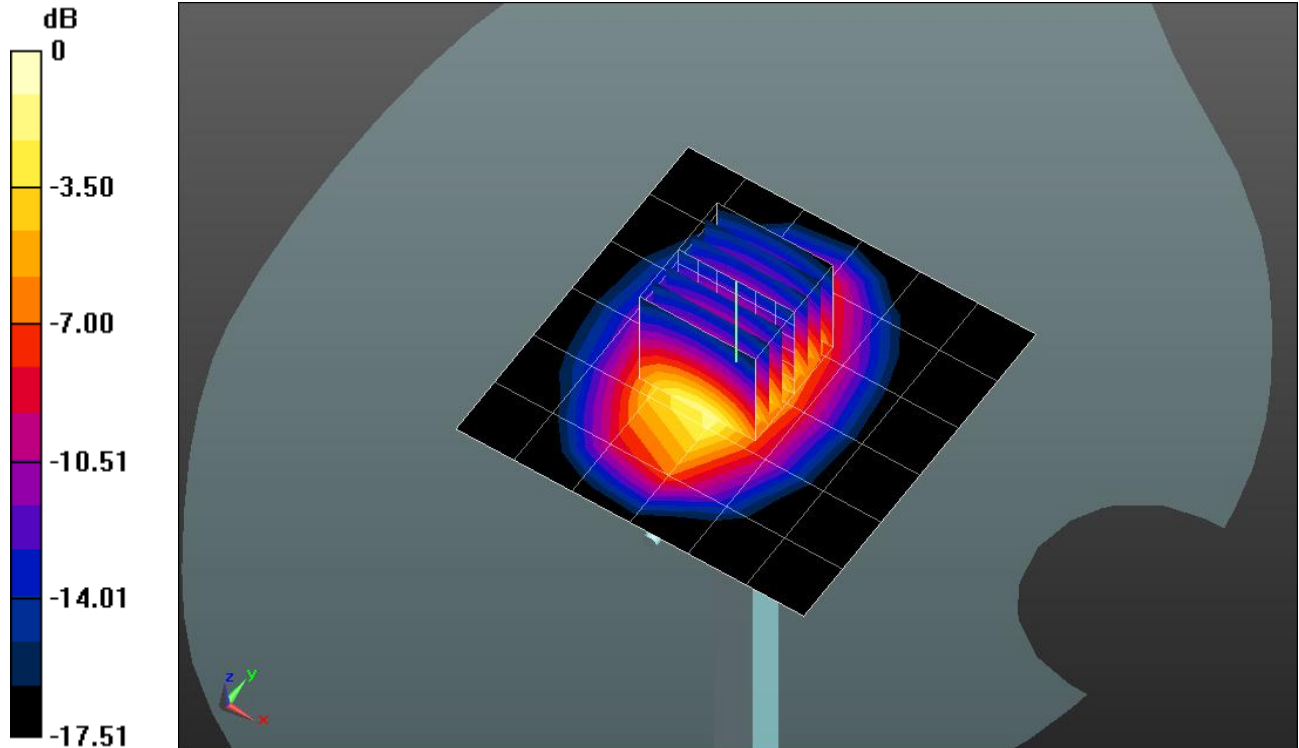

0 dB = 4.790mW/g = 13.61 dB mW/g

20120901_SystemPerformanceCheck-D1750V2 SN 1050

Frequency: 1750 MHz; Duty Cycle: 1:1

Head/Pin=100 mW/Z Scan (1x1x21): Measurement grid: dx=20mm, dy=20mm, dz=5mm
Maximum value of SAR (measured) = 4.090 mW/g

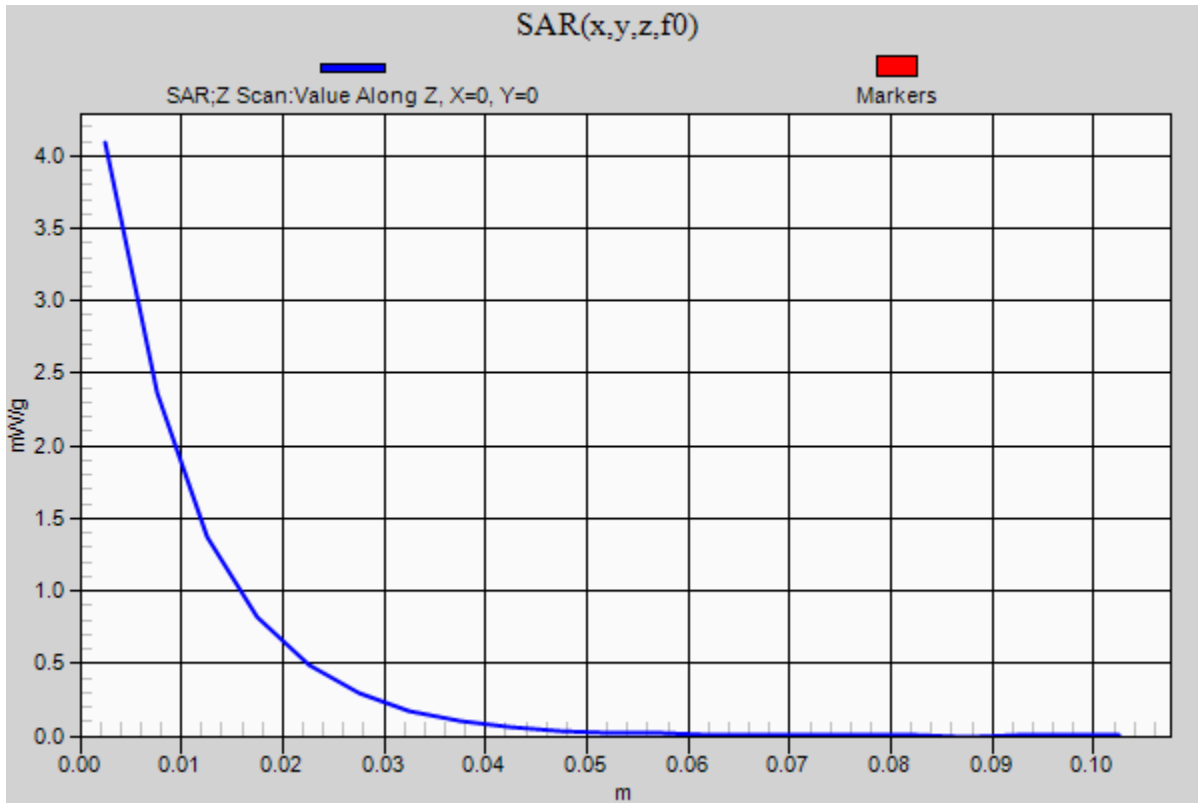

20120901_SystemPerformanceCheck-D835V2 SN 4d002

Frequency: 835 MHz; Duty Cycle: 1:1; Room Ambient Temperature: 24.0°C; Liquid Temperature: 23.0°C
Medium parameters used: $f = 835$ MHz; $\sigma = 0.99$ mho/m; $\epsilon_r = 55.001$; $\rho = 1000$ kg/m³

DASY5 Configuration:

- Area Scan setting - Find Secondary Maximum Within: 2.0 dB and with a peak SAR value greater than 0.0012W/kg
- Electronics: DAE4 Sn1259; Calibrated: 2/13/2012
- Probe: EX3DV4 - SN3686; ConvF(8.73, 8.73, 8.73); Calibrated: 2/16/2012
- Sensor-Surface: 2.5mm (Mechanical Surface Detection)
- Phantom: ELI v5.0 (B); Type: QDOVA001BB; Serial: 1118

Body/Pin=100 mW/Area Scan (7x7x1): Measurement grid: dx=15mm, dy=15mm

Maximum value of SAR (measured) = 0.985 mW/g

Body/Pin=100 mW/Zoom Scan (7x7x7)/Cube 0: Measurement grid: dx=5mm, dy=5mm, dz=5mm

Reference Value = 34.300 V/m; Power Drift = -0.18 dB

Peak SAR (extrapolated) = 1.3780

SAR(1 g) = 0.925 mW/g; SAR(10 g) = 0.607 mW/g

Maximum value of SAR (measured) = 1.138 mW/g

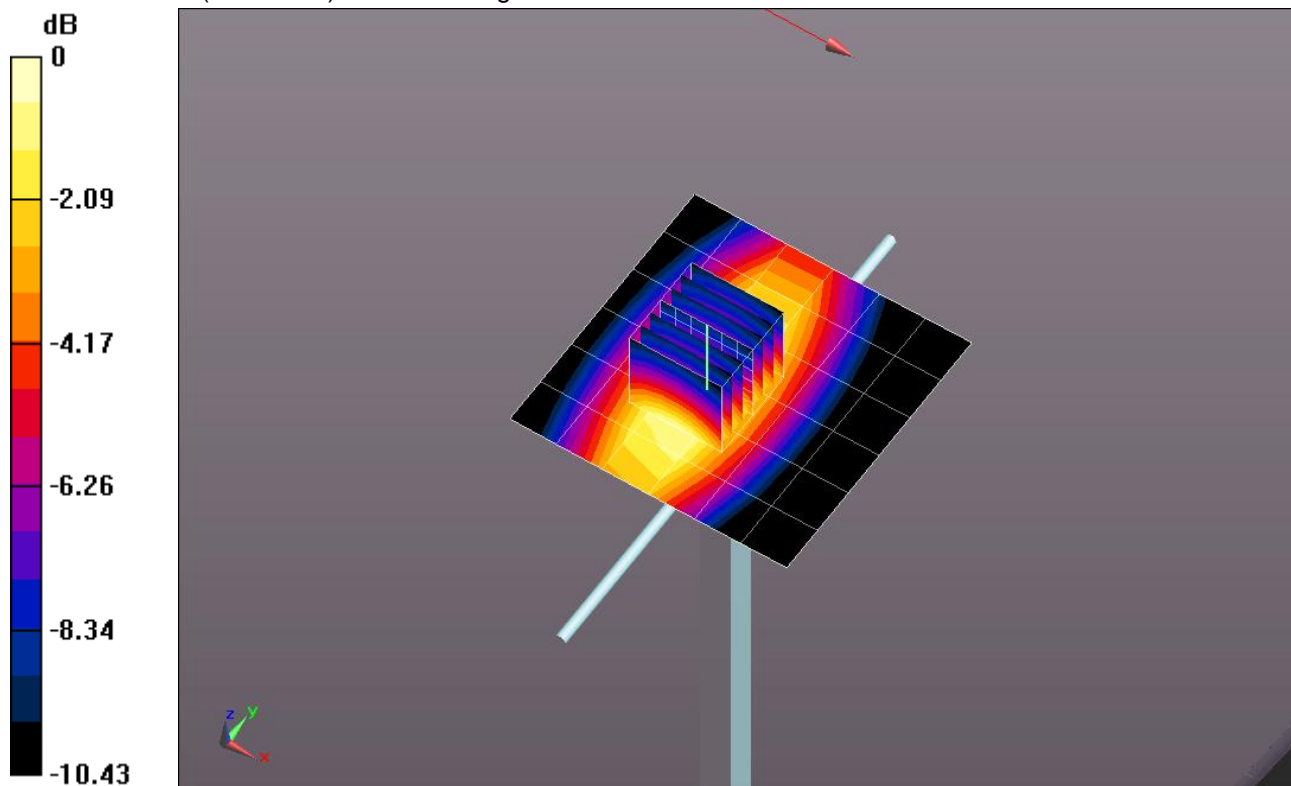

0 dB = 1.140mW/g = 1.14 dB mW/g

20120901_SystemPerformanceCheck-D835V2 SN 4d002

Frequency: 835 MHz; Duty Cycle: 1:1

Body/Pin=100 mW/Z Scan (1x1x21): Measurement grid: dx=20mm, dy=20mm, dz=5mm
Maximum value of SAR (measured) = 0.756 mW/g

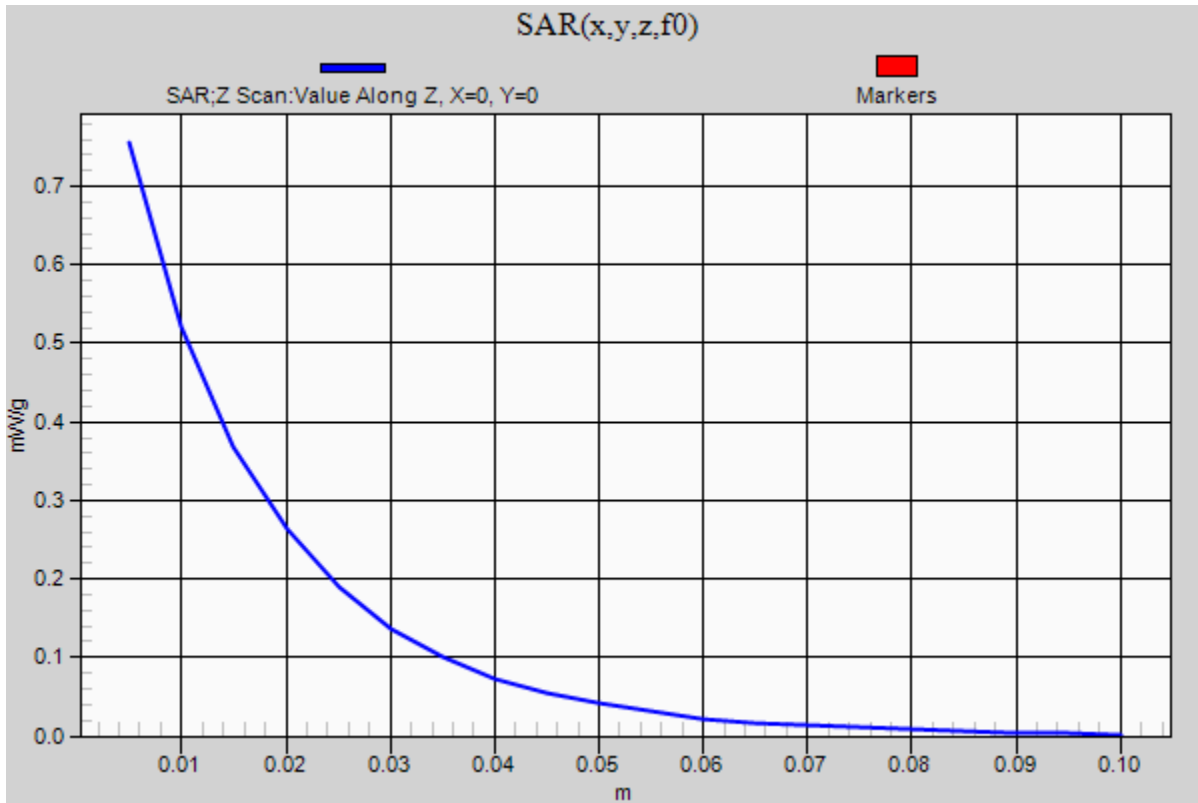

20120901_SystemPerformanceCheck-D1900V2 SN 5d140

Frequency: 1900 MHz; Duty Cycle: 1:1; Room Ambient Temperature: 24.0°C; Liquid Temperature: 23.0°C

Medium parameters used: $f = 1900$ MHz; $\sigma = 1.518$ mho/m; $\epsilon_r = 53.517$; $\rho = 1000$ kg/m³

DASY5 Configuration:

- Area Scan setting - Find Secondary Maximum Within: 2.0 dB and with a peak SAR value greater than 0.0012W/kg
- Electronics: DAE4 Sn1239; Calibrated: 6/6/2012
- Probe: EX3DV4 - SN3773; ConvF(7.11, 7.11, 7.11); Calibrated: 3/14/2012
- Sensor-Surface: 2.5mm (Mechanical Surface Detection)
- Phantom: ELI v5.0 (B); Type: QDOVA001BB; Serial: 1099

Body/Pin=100 mW/Area Scan (7x7x1): Measurement grid: dx=15mm, dy=15mm

Maximum value of SAR (measured) = 4.852 mW/g

Body/Pin=100 mW/Zoom Scan (7x7x7)/Cube 0: Measurement grid: dx=5mm, dy=5mm, dz=5mm

Reference Value = 56.959 V/m; Power Drift = 0.04 dB

Peak SAR (extrapolated) = 7.1630

SAR(1 g) = 3.94 mW/g; SAR(10 g) = 2.07 mW/g

Maximum value of SAR (measured) = 5.319 mW/g

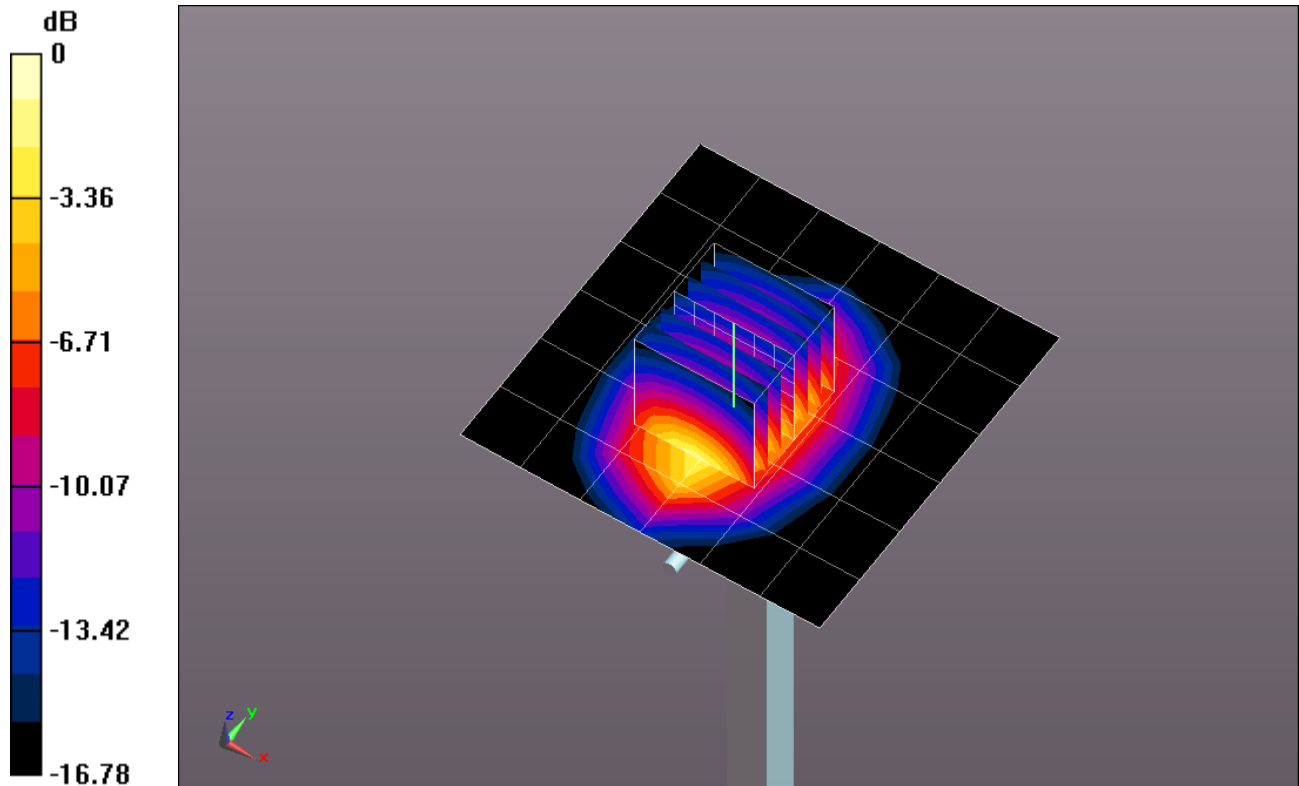

0 dB = 5.320mW/g = 14.52 dB mW/g

20120901_SystemPerformanceCheck-D1900V2 SN 5d140

Frequency: 1900 MHz; Duty Cycle: 1:1

Body/Pin=100 mW/Z Scan (1x1x21): Measurement grid: dx=20mm, dy=20mm, dz=5mm

Maximum value of SAR (measured) = 4.847 mW/g

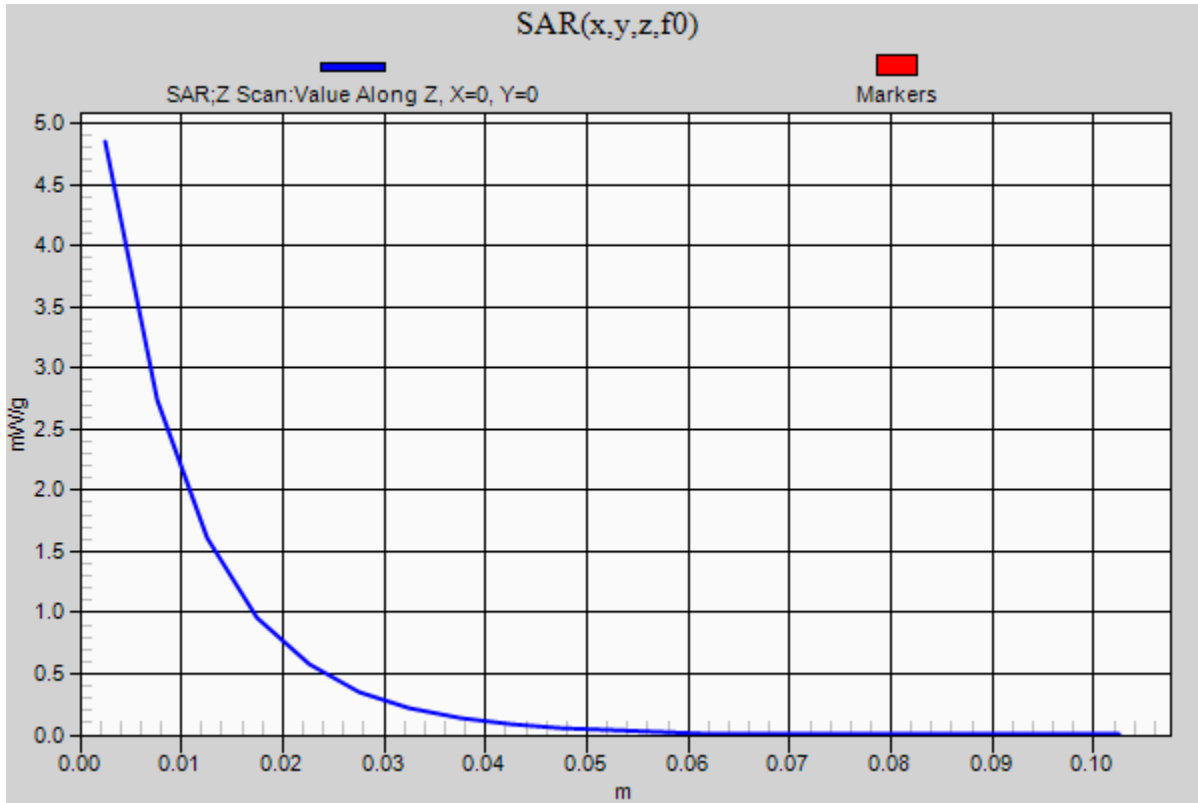

20120902_SystemPerformanceCheck-D1750V2 SN 1050

Frequency: 1750 MHz; Duty Cycle: 1:1; Room Ambient Temperature: 24.0°C; Liquid Temperature: 23.0°C

Medium parameters used: $f = 1750$ MHz; $\sigma = 1.331$ mho/m; $\epsilon_r = 38.708$; $\rho = 1000$ kg/m³

DASY5 Configuration:

- Area Scan setting - Find Secondary Maximum Within: 2.0 dB and with a peak SAR value greater than 0.0012W/kg
- Electronics: DAE4 Sn1239; Calibrated: 6/6/2012
- Probe: EX3DV4 - SN3772; ConvF(7.79, 7.79); Calibrated: 2/16/2012
- Sensor-Surface: 2.5mm (Mechanical Surface Detection)
- Phantom: SAM v5.0 (A); Type: QD000P40CC; Serial: 1602

Head/Pin=100 mW/Area Scan (7x7x1): Measurement grid: dx=15mm, dy=15mm

Maximum value of SAR (measured) = 3.888 mW/g

Head/Pin=100 mW/Zoom Scan (7x7x7)/Cube 0: Measurement grid: dx=5mm, dy=5mm, dz=5mm

Reference Value = 54.463 V/m; Power Drift = 0.15 dB

Peak SAR (extrapolated) = 6.4880

SAR(1 g) = 3.49 mW/g; SAR(10 g) = 1.84 mW/g

Maximum value of SAR (measured) = 4.729 mW/g

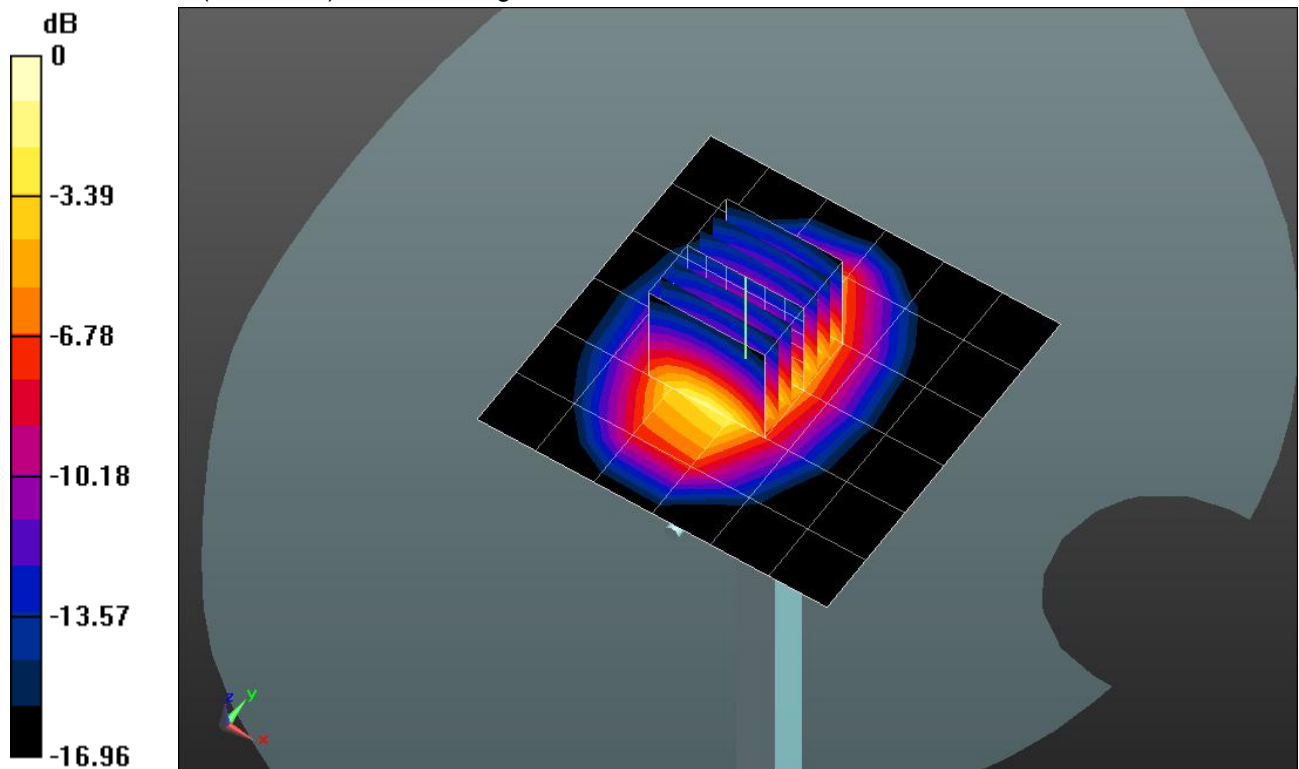

0 dB = 4.730mW/g = 13.50 dB mW/g

20120902_SystemPerformanceCheck-D1750V2 SN 1050

Frequency: 1750 MHz; Duty Cycle: 1:1

Head/Pin=100 mW/Z Scan (1x1x21): Measurement grid: dx=20mm, dy=20mm, dz=5mm
Maximum value of SAR (measured) = 3.877 mW/g

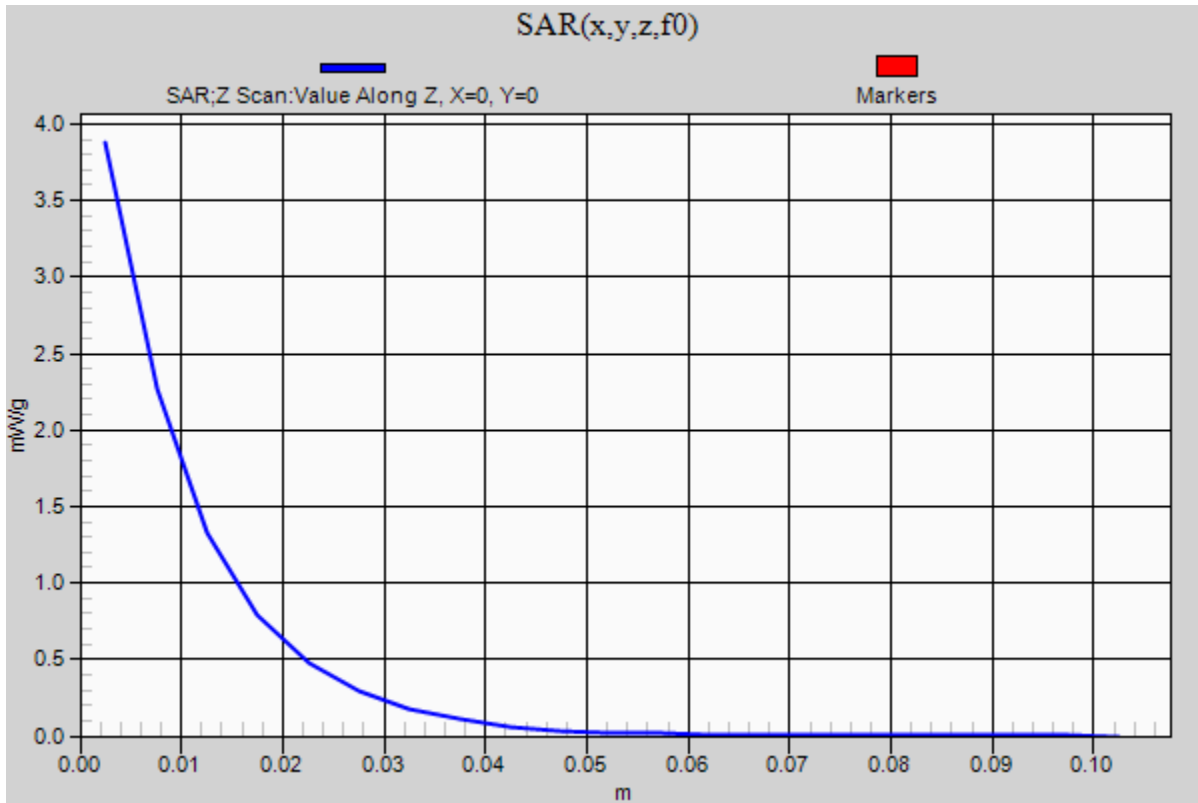

20120902_SystemPerformanceCheck-D835V2 SN 4d002

Frequency: 835 MHz; Duty Cycle: 1:1; Room Ambient Temperature: 25.0°C; Liquid Temperature: 24.0°C
Medium parameters used: $f = 835$ MHz; $\sigma = 0.984$ mho/m; $\epsilon_r = 56.405$; $\rho = 1000$ kg/m³

DASY5 Configuration:

- Area Scan setting - Find Secondary Maximum Within: 2.0 dB and with a peak SAR value greater than 0.0012W/kg
- Electronics: DAE4 Sn1259; Calibrated: 2/13/2012
- Probe: EX3DV4 - SN3686; ConvF(8.73, 8.73, 8.73); Calibrated: 2/16/2012
- Sensor-Surface: 2.5mm (Mechanical Surface Detection)
- Phantom: ELI v5.0 (B); Type: QDOVA001BB; Serial: 1118

Body/Pin=100 mW/Area Scan (7x7x1): Measurement grid: dx=15mm, dy=15mm

Maximum value of SAR (measured) = 1.002 mW/g

Body/Pin=100 mW/Zoom Scan (7x7x7)/Cube 0: Measurement grid: dx=5mm, dy=5mm, dz=5mm

Reference Value = 34.699 V/m; Power Drift = -0.02 dB

Peak SAR (extrapolated) = 1.3880

SAR(1 g) = 0.937 mW/g; SAR(10 g) = 0.619 mW/g

Maximum value of SAR (measured) = 1.138 mW/g

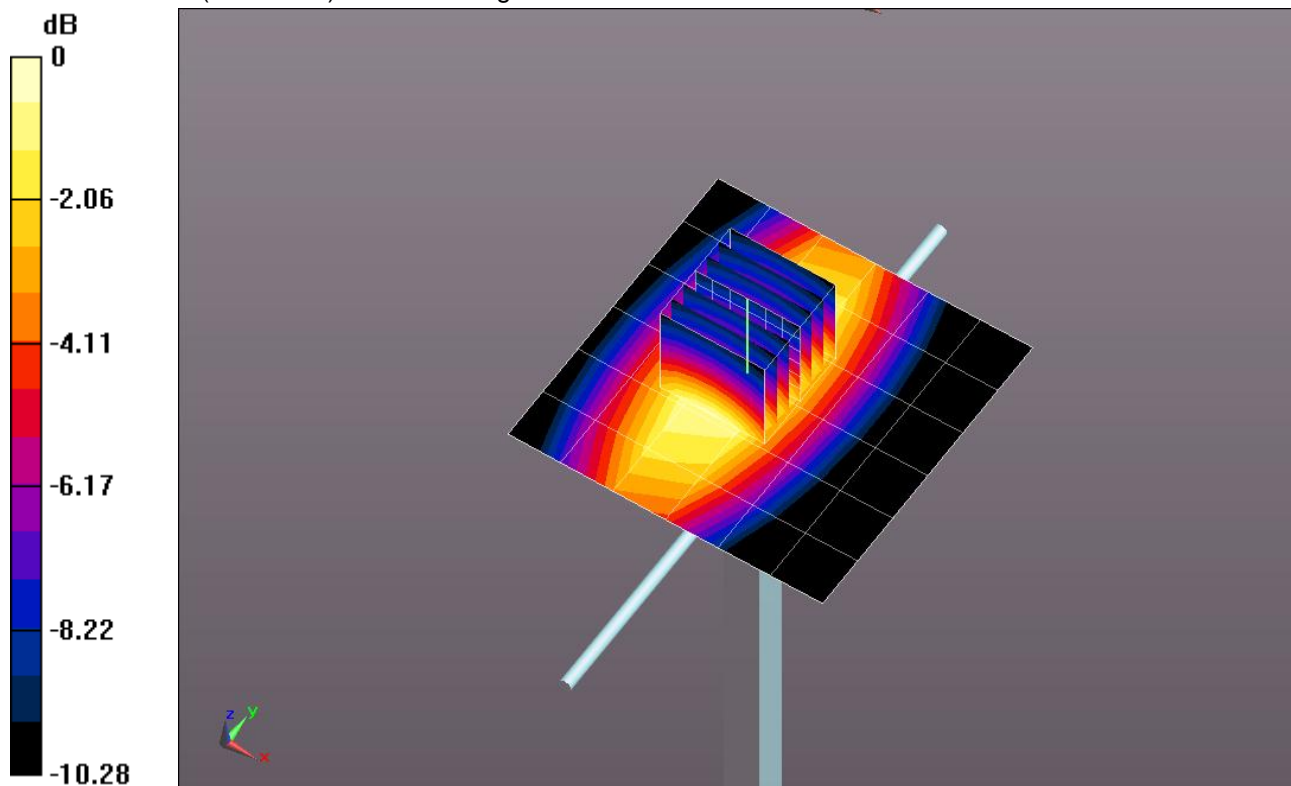

0 dB = 1.140mW/g = 1.14 dB mW/g

20120902_SystemPerformanceCheck-D835V2 SN 4d002

Frequency: 835 MHz; Duty Cycle: 1:1

Body/Pin=100 mW/Z Scan (1x1x21): Measurement grid: dx=20mm, dy=20mm, dz=5mm
Maximum value of SAR (measured) = 0.809 mW/g

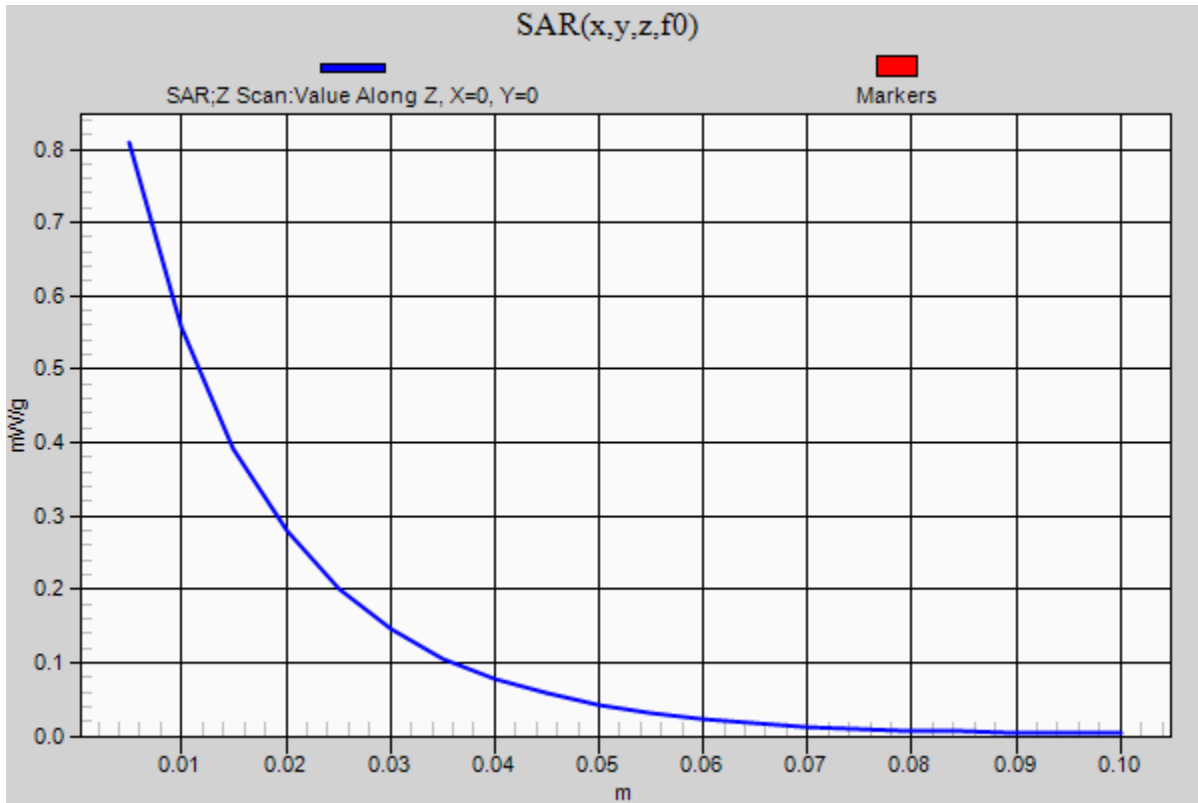

20120902_SystemPerformanceCheck-D1900V2 SN 5d140

Frequency: 1900 MHz; Duty Cycle: 1:1; Room Ambient Temperature: 24.0°C; Liquid Temperature: 23.0°C
 Medium parameters used: $f = 1900 \text{ MHz}$; $\sigma = 1.488 \text{ mho/m}$; $\epsilon_r = 52.002$; $\rho = 1000 \text{ kg/m}^3$

DASY5 Configuration:

- Area Scan setting - Find Secondary Maximum Within: 2.0 dB and with a peak SAR value greater than 0.0012W/kg
- Electronics: DAE4 Sn1239; Calibrated: 6/6/2012
- Probe: EX3DV4 - SN3773; ConvF(7.11, 7.11, 7.11); Calibrated: 3/14/2012
- Sensor-Surface: 2.5mm (Mechanical Surface Detection (Locations From Previous Scan Used)), Sensor-Surface: 2.5mm (Mechanical Surface Detection)
- Phantom: ELI v5.0 (B); Type: QDOVA001BB; Serial: 1099

Body/Pin=100 mW/Area Scan (7x7x1): Measurement grid: dx=15mm, dy=15mm

Maximum value of SAR (measured) = 5.082 mW/g

Body/Pin=100 mW/Zoom Scan (7x7x7)/Cube 0: Measurement grid: dx=5mm, dy=5mm, dz=5mm

Reference Value = 58.274 V/m; Power Drift = 0.09 dB

Peak SAR (extrapolated) = 7.1890

SAR(1 g) = 3.96 mW/g; SAR(10 g) = 2.08 mW/g

Maximum value of SAR (measured) = 5.304 mW/g

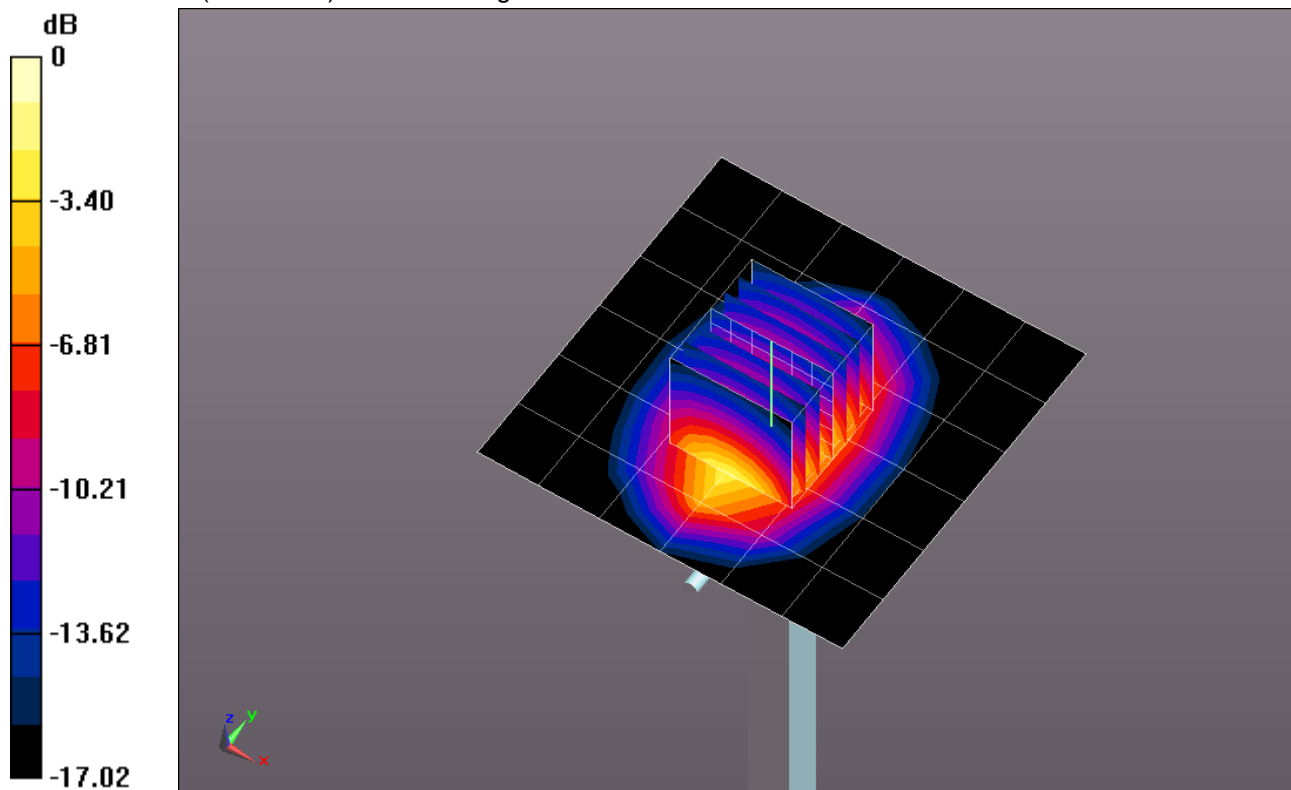

0 dB = 5.300mW/g = 14.49 dB mW/g

20120902_SystemPerformanceCheck-D1900V2 SN 5d140

Frequency: 1900 MHz; Duty Cycle: 1:1

Body/Pin=100 mW/Z Scan (1x1x21): Measurement grid: dx=20mm, dy=20mm, dz=5mm
Maximum value of SAR (measured) = 5.113 mW/g

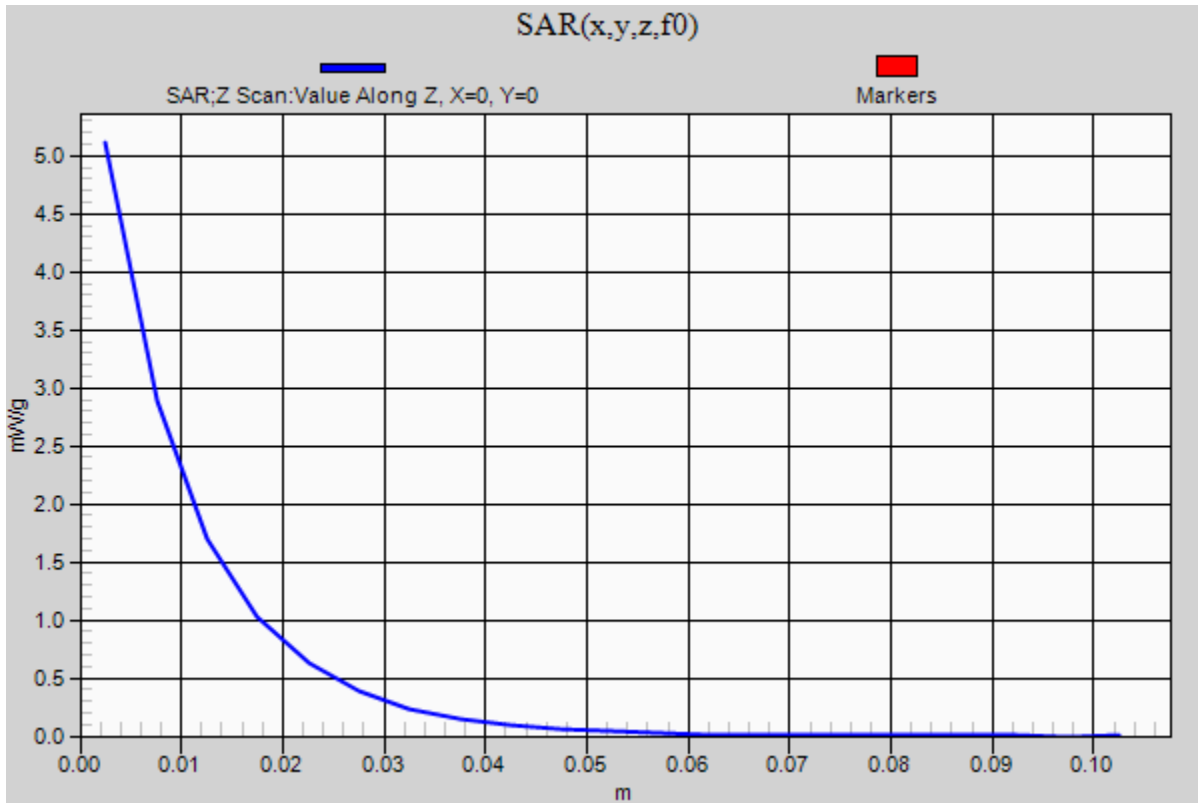

20120903_SystemPerformanceCheck-D1750V2 SN 1050

Frequency: 1750 MHz; Duty Cycle: 1:1; Room Ambient Temperature: 24.0°C; Liquid Temperature: 23.0°C
 Medium parameters used: $f = 1750$ MHz; $\sigma = 1.376$ mho/m; $\epsilon_r = 39.151$; $\rho = 1000$ kg/m³

DASY5 Configuration:

- Area Scan setting - Find Secondary Maximum Within: 2.0 dB and with a peak SAR value greater than 0.0012W/kg
- Electronics: DAE4 Sn1258; Calibrated: 3/8/2012
- Probe: EX3DV4 - SN3772; ConvF(7.79, 7.79, 7.79); Calibrated: 2/16/2012
- Sensor-Surface: 2.5mm (Mechanical Surface Detection)
- Phantom: SAM v5.0 (A); Type: QD000P40CC; Serial: 1602

Head/Pin=100 mW/Area Scan (7x7x1): Measurement grid: dx=15mm, dy=15mm

Maximum value of SAR (measured) = 4.166 mW/g

Head/Pin=100 mW/Zoom Scan (7x7x7)/Cube 0: Measurement grid: dx=5mm, dy=5mm, dz=5mm

Reference Value = 55.377 V/m; Power Drift = 0.11 dB

Peak SAR (extrapolated) = 6.4570

SAR(1 g) = 3.5 mW/g; SAR(10 g) = 1.85 mW/g

Maximum value of SAR (measured) = 4.735 mW/g

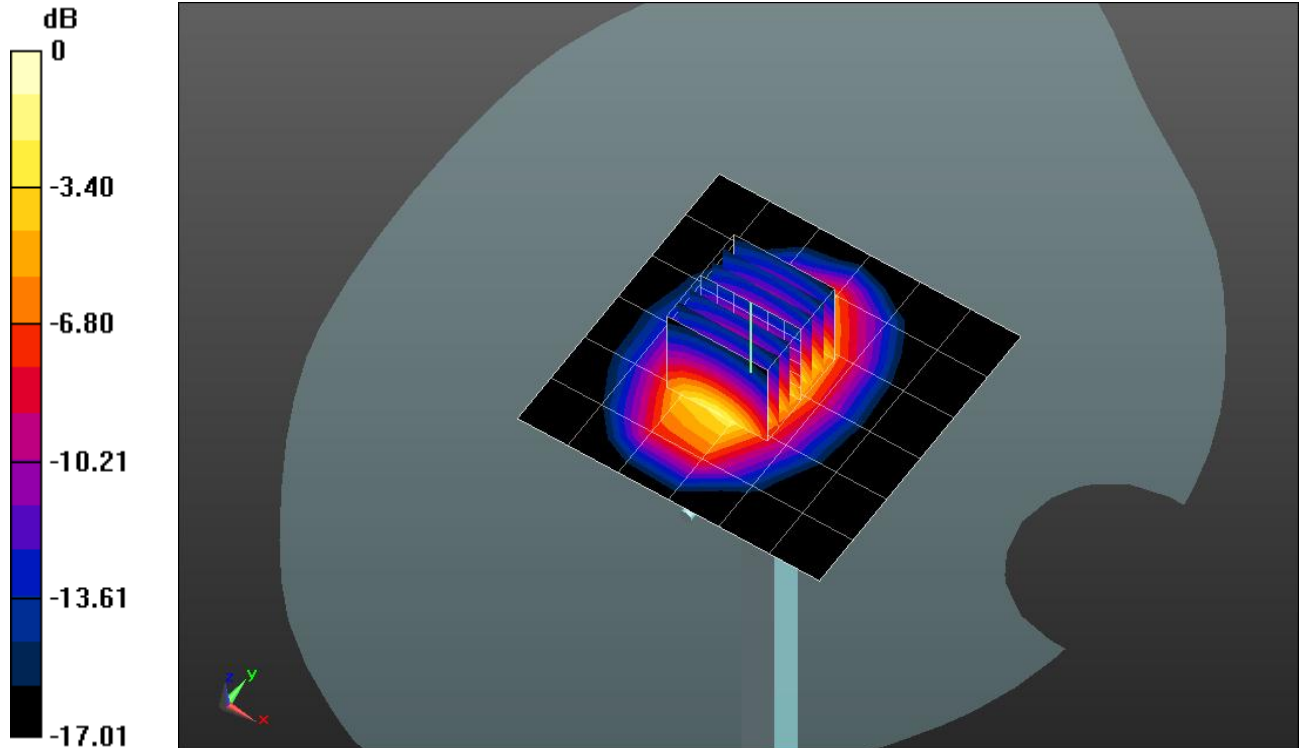

0 dB = 4.730mW/g = 13.50 dB mW/g

20120903_SystemPerformanceCheck-D1750V2 SN 1050

Frequency: 1750 MHz; Duty Cycle: 1:1

Head/Pin=100 mW/Z Scan (1x1x21): Measurement grid: dx=20mm, dy=20mm, dz=5mm
Maximum value of SAR (measured) = 4.142 mW/g

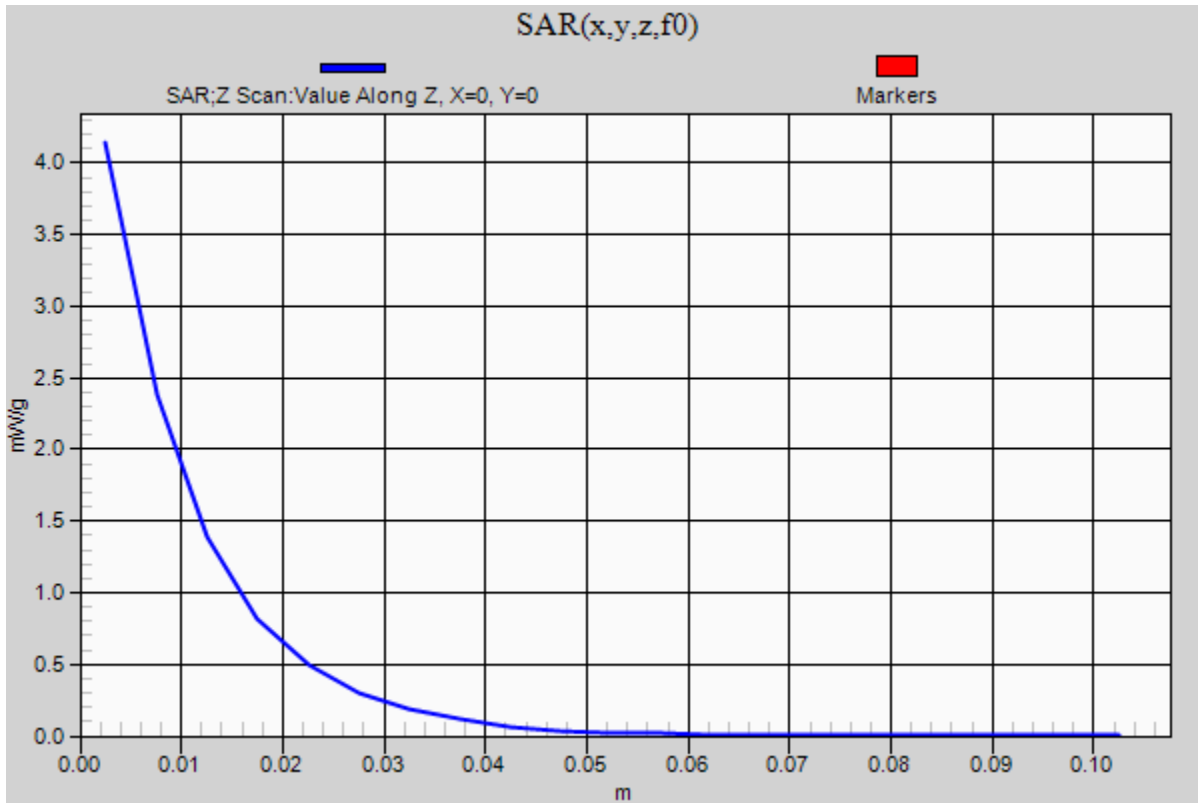

20120903 SystemPerformanceCheck-D2450V2 SN 748

Frequency: 2450 MHz; Duty Cycle: 1:1; Room Ambient Temperature: 24.0°C; Liquid Temperature: 23.0°C
 Medium parameters used: $f = 2450$ MHz; $\sigma = 1.845$ mho/m; $\epsilon_r = 38.173$; $\rho = 1000$ kg/m³

DASY5 Configuration:

- Area Scan setting - Find Secondary Maximum Within: 2.0 dB and with a peak SAR value greater than 0.0012W/kg
- Electronics: DAE4 Sn1258; Calibrated: 3/8/2012
- Probe: EX3DV4 - SN3772; ConvF(6.64, 6.64, 6.64); Calibrated: 2/16/2012
- Sensor-Surface: 2.5mm (Mechanical Surface Detection)
- Phantom: SAM v5.0 (B); Type: QD000P40CD; Serial: 1628

Head/Pin=100 mW/Area Scan (7x7x1): Measurement grid: dx=15mm, dy=15mm

Maximum value of SAR (measured) = 5.827 mW/g

Head/Pin=100 mW/Zoom Scan (7x7x7)/Cube 0: Measurement grid: dx=5mm, dy=5mm, dz=5mm

Reference Value = 58.952 V/m; Power Drift = 0.06 dB

Peak SAR (extrapolated) = 11.2120

SAR(1 g) = 5.2 mW/g; SAR(10 g) = 2.37 mW/g

Maximum value of SAR (measured) = 7.449 mW/g

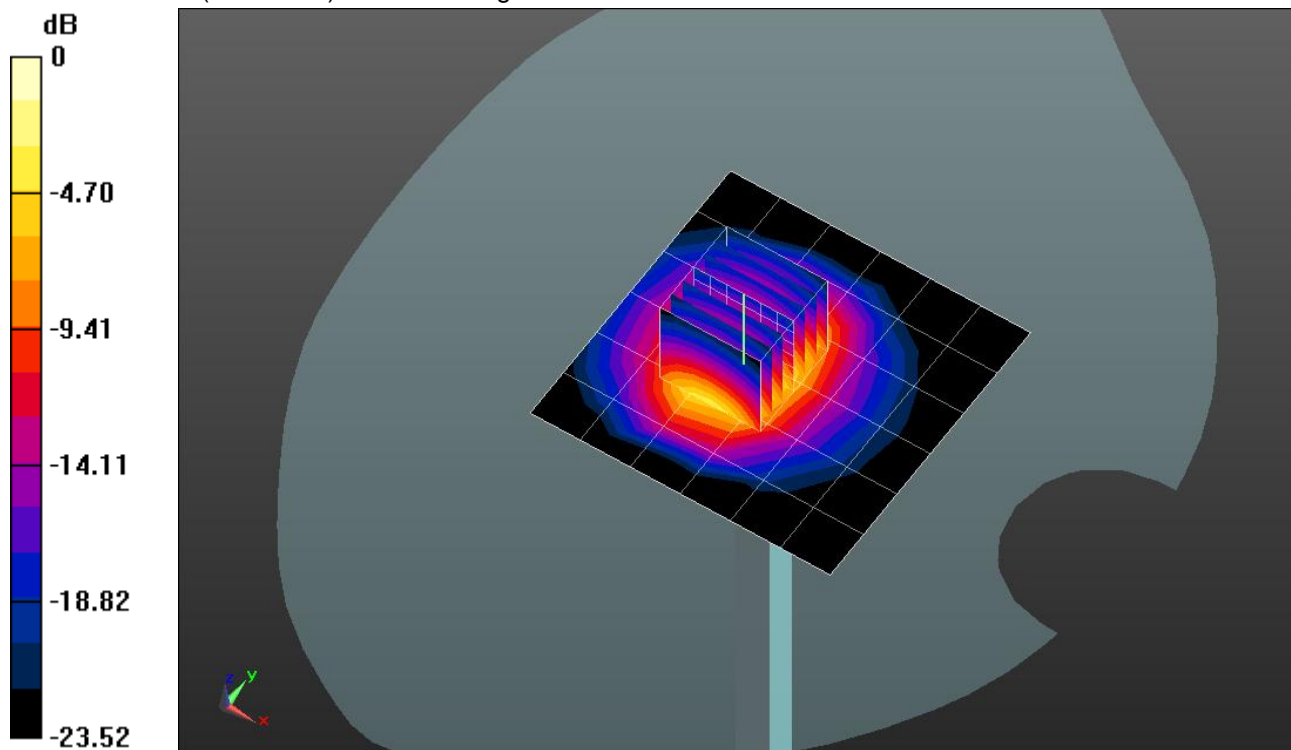

0 dB = 7.450mW/g = 17.44 dB mW/g

20120903 SystemPerformanceCheck-D2450V2 SN 748

Frequency: 2450 MHz; Duty Cycle: 1:1

Head/Pin=100 mW/Z Scan (1x1x21): Measurement grid: dx=20mm, dy=20mm, dz=5mm
Maximum value of SAR (measured) = 3.462 mW/g

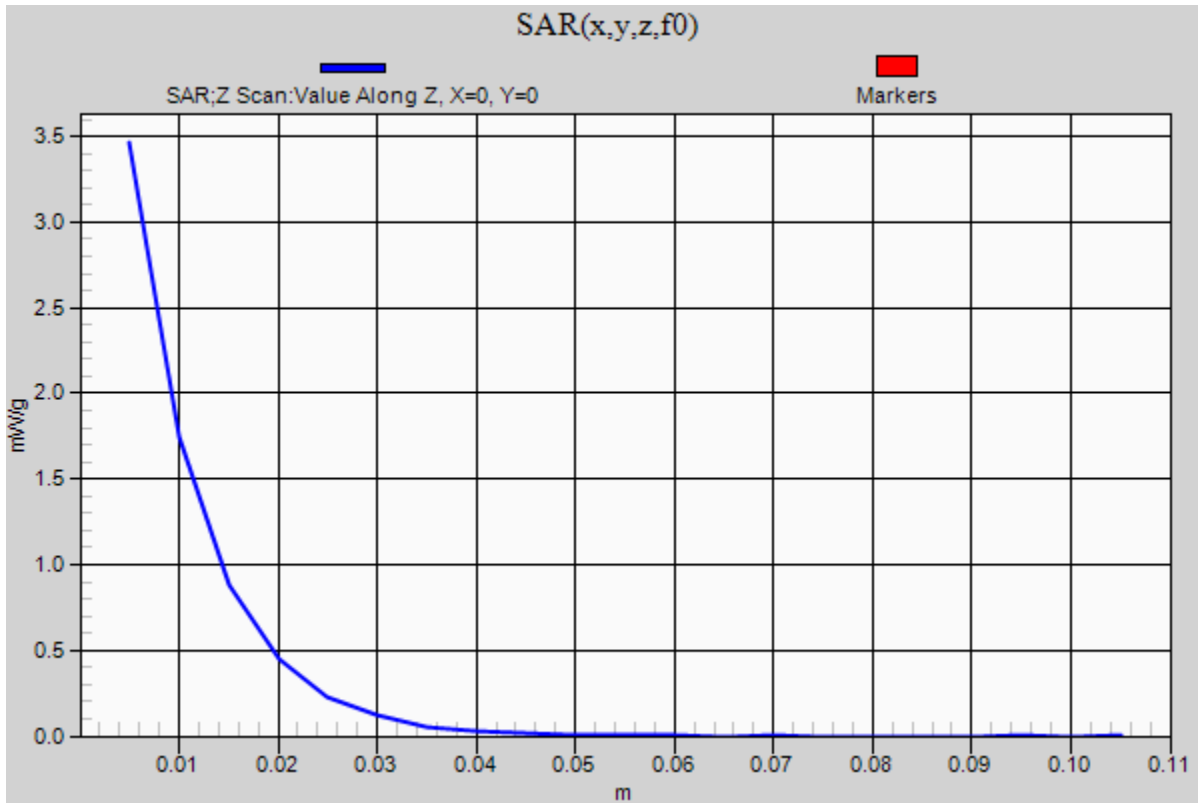

20120903_SystemPerformanceCheck-D750V3 SN 1019

Frequency: 750 MHz; Duty Cycle: 1:1; Room Ambient Temperature: 25.0°C; Liquid Temperature: 24.0°C
Medium parameters used: $f = 750$ MHz; $\sigma = 0.951$ mho/m; $\epsilon_r = 54.402$; $\rho = 1000$ kg/m³

DASY5 Configuration:

- Area Scan setting - Find Secondary Maximum Within: 2.0 dB and with a peak SAR value greater than 0.0012W/kg
- Electronics: DAE4 Sn1259; Calibrated: 2/13/2012
- Probe: EX3DV4 - SN3686; ConvF(8.87, 8.87, 8.87); Calibrated: 2/16/2012
- Sensor-Surface: 2.5mm (Mechanical Surface Detection)
- Phantom: ELI v5.0 (A); Type: QDOVA001BB; Serial: 1120

Body/Pin=100 mW/Area Scan (7x7x1): Measurement grid: dx=15mm, dy=15mm

Maximum value of SAR (measured) = 1.050 mW/g

Body/Pin=100 mW/Zoom Scan (7x7x7)/Cube 0: Measurement grid: dx=5mm, dy=5mm, dz=5mm

Reference Value = 33.280 V/m; Power Drift = 0.08 dB

Peak SAR (extrapolated) = 1.4220

SAR(1 g) = 0.910 mW/g; SAR(10 g) = 0.578 mW/g

Maximum value of SAR (measured) = 1.136 mW/g

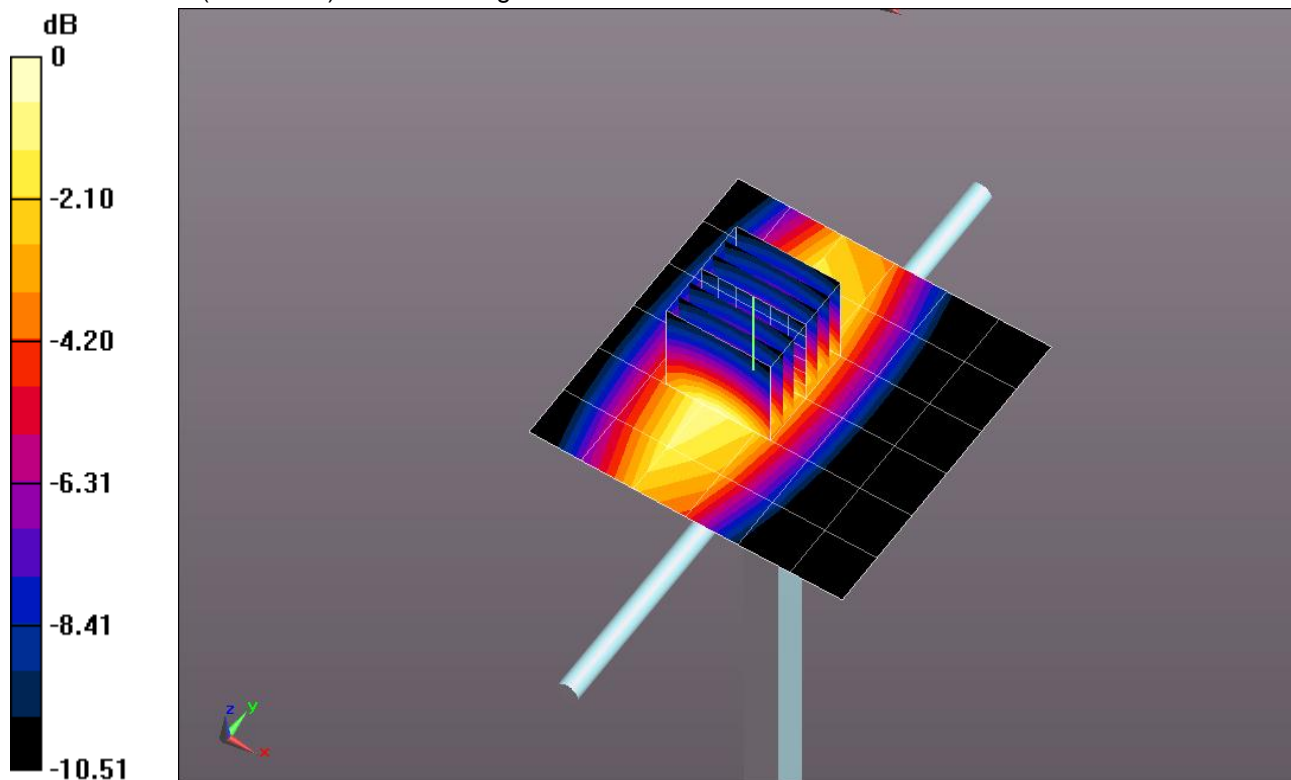

0 dB = 1.140mW/g = 1.14 dB mW/g

20120903_SystemPerformanceCheck-D750V3 SN 1019

Frequency: 750 MHz; Duty Cycle: 1:1

Body/Pin=100 mW/Z Scan (1x1x21): Measurement grid: dx=20mm, dy=20mm, dz=5mm
Maximum value of SAR (measured) = 0.640 mW/g

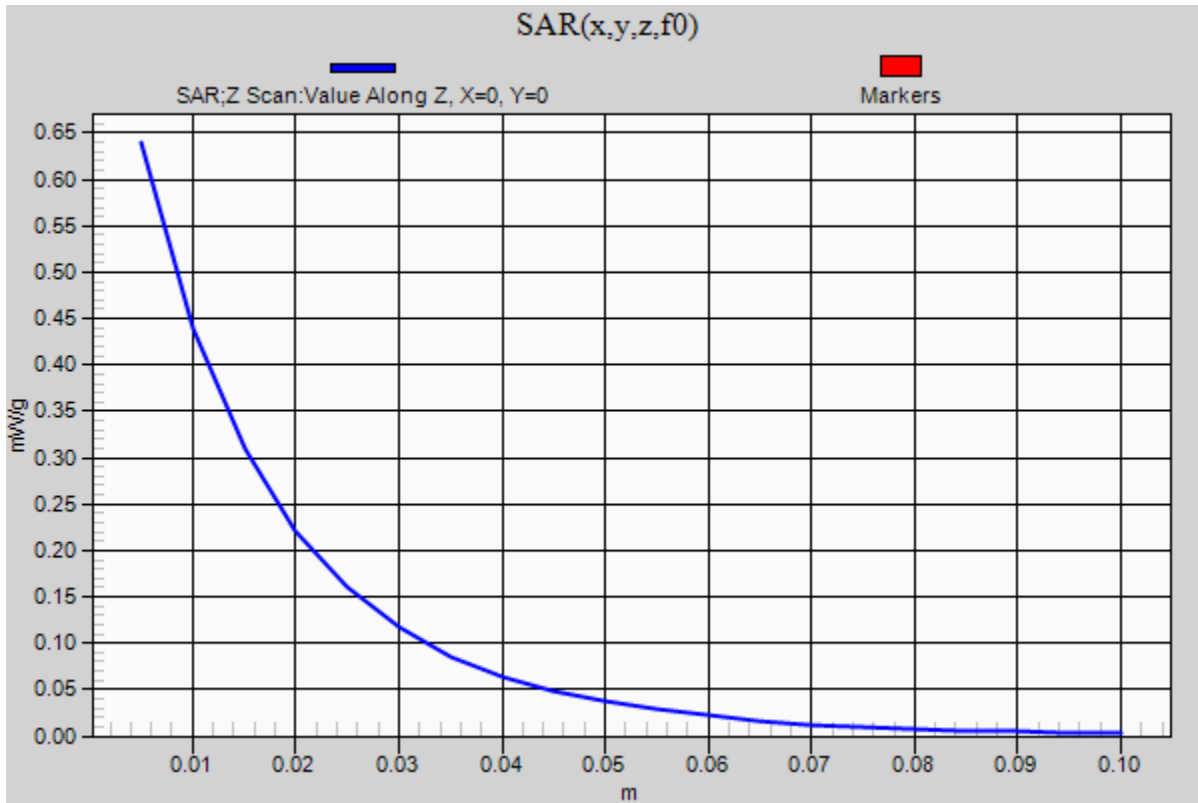

20120903_SystemPerformanceCheck-D1900V2 SN 5d140

Frequency: 1900 MHz; Duty Cycle: 1:1; Room Ambient Temperature: 24.0°C; Liquid Temperature: 23.0°C
 Medium parameters used: $f = 1900 \text{ MHz}$; $\sigma = 1.519 \text{ mho/m}$; $\epsilon_r = 52.153$; $\rho = 1000 \text{ kg/m}^3$

DASY5 Configuration:

- Area Scan setting - Find Secondary Maximum Within: 2.0 dB and with a peak SAR value greater than 0.0012W/kg
- Electronics: DAE4 Sn1239; Calibrated: 6/6/2012
- Probe: EX3DV4 - SN3773; ConvF(7.11, 7.11, 7.11); Calibrated: 3/14/2012
- Sensor-Surface: 2.5mm (Mechanical Surface Detection)
- Phantom: ELI v5.0 (B); Type: QDOVA001BB; Serial: 1099

Body/Pin=100 mW/Area Scan (7x7x1): Measurement grid: dx=15mm, dy=15mm

Maximum value of SAR (measured) = 5.232 mW/g

Body/Pin=100 mW/Zoom Scan (7x7x7)/Cube 0: Measurement grid: dx=5mm, dy=5mm, dz=5mm

Reference Value = 59.312 V/m; Power Drift = -0.12 dB

Peak SAR (extrapolated) = 7.4500

SAR(1 g) = 4.08 mW/g; SAR(10 g) = 2.14 mW/g

Maximum value of SAR (measured) = 5.510 mW/g

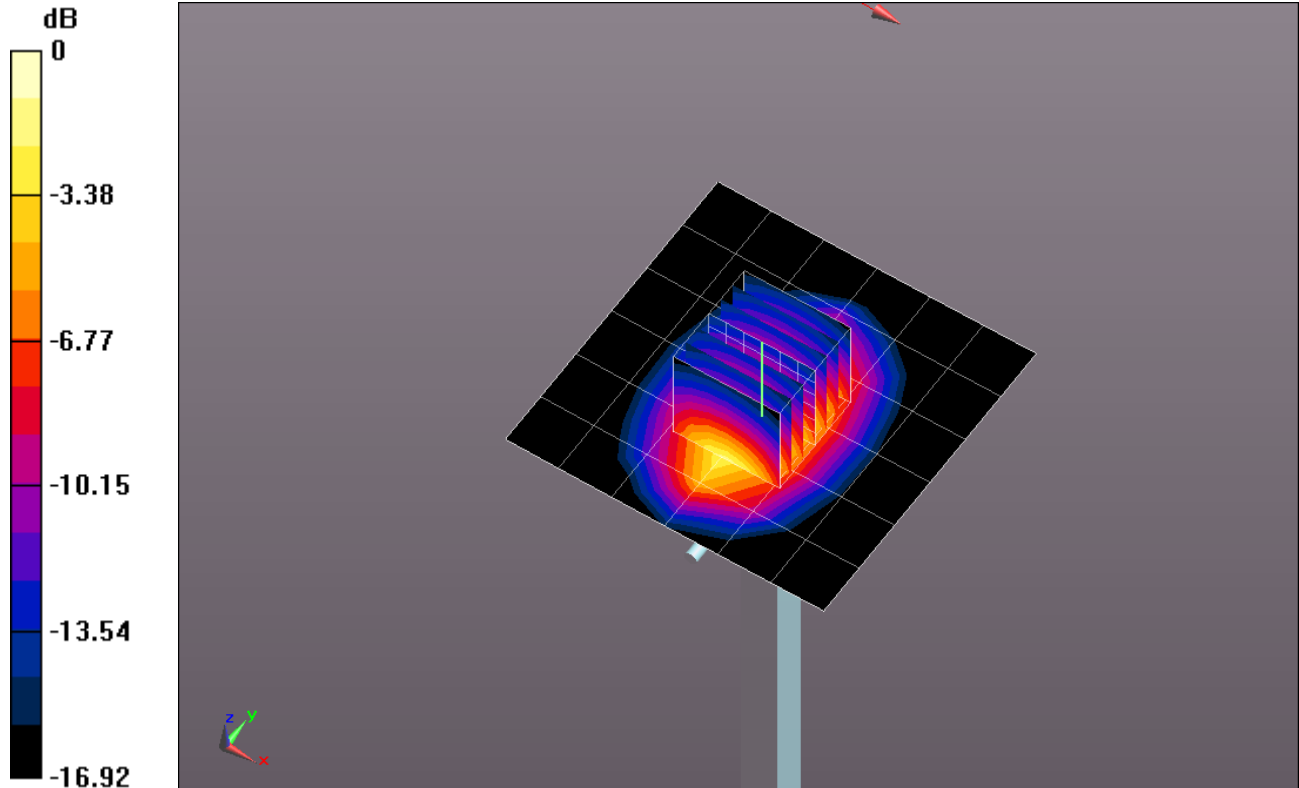

0 dB = 5.510mW/g = 14.82 dB mW/g

20120903_SystemPerformanceCheck-D1900V2 SN 5d140

Frequency: 1900 MHz; Duty Cycle: 1:1

Body/Pin=100 mW/Z Scan (1x1x21): Measurement grid: dx=20mm, dy=20mm, dz=5mm
Maximum value of SAR (measured) = 5.170 mW/g

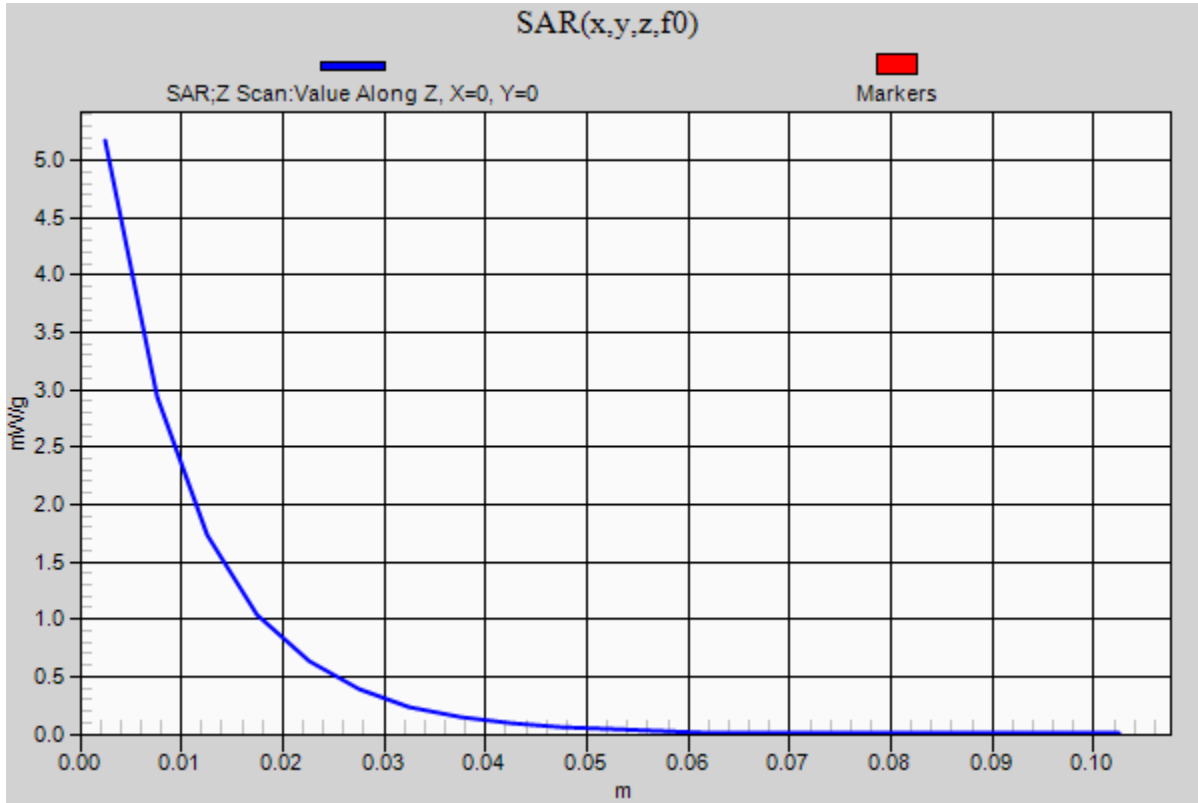

20120904_SystemPerformanceCheck-D1750V2 SN 1050

Frequency: 1750 MHz; Duty Cycle: 1:1; Room Ambient Temperature: 24.0°C; Liquid Temperature: 23.0°C
 Medium parameters used: $f = 1750 \text{ MHz}$; $\sigma = 1.344 \text{ mho/m}$; $\epsilon_r = 39.706$; $\rho = 1000 \text{ kg/m}^3$

DASY5 Configuration:

- Area Scan setting - Find Secondary Maximum Within: 2.0 dB and with a peak SAR value greater than 0.0012W/kg
- Electronics: DAE4 Sn1258; Calibrated: 3/8/2012
- Probe: EX3DV4 - SN3772; ConvF(7.79, 7.79, 7.79); Calibrated: 2/16/2012
- Sensor-Surface: 2.5mm (Mechanical Surface Detection)
- Phantom: SAM v5.0 (A); Type: QD000P40CC; Serial: 1602

Head/Pin=100 mW/Area Scan (7x7x1): Measurement grid: dx=15mm, dy=15mm

Maximum value of SAR (measured) = 4.125 mW/g

Head/Pin=100 mW/Zoom Scan (7x7x7)/Cube 0: Measurement grid: dx=5mm, dy=5mm, dz=5mm

Reference Value = 55.885 V/m; Power Drift = 0.14 dB

Peak SAR (extrapolated) = 6.7320

SAR(1 g) = 3.62 mW/g; SAR(10 g) = 1.9 mW/g

Maximum value of SAR (measured) = 4.902 mW/g

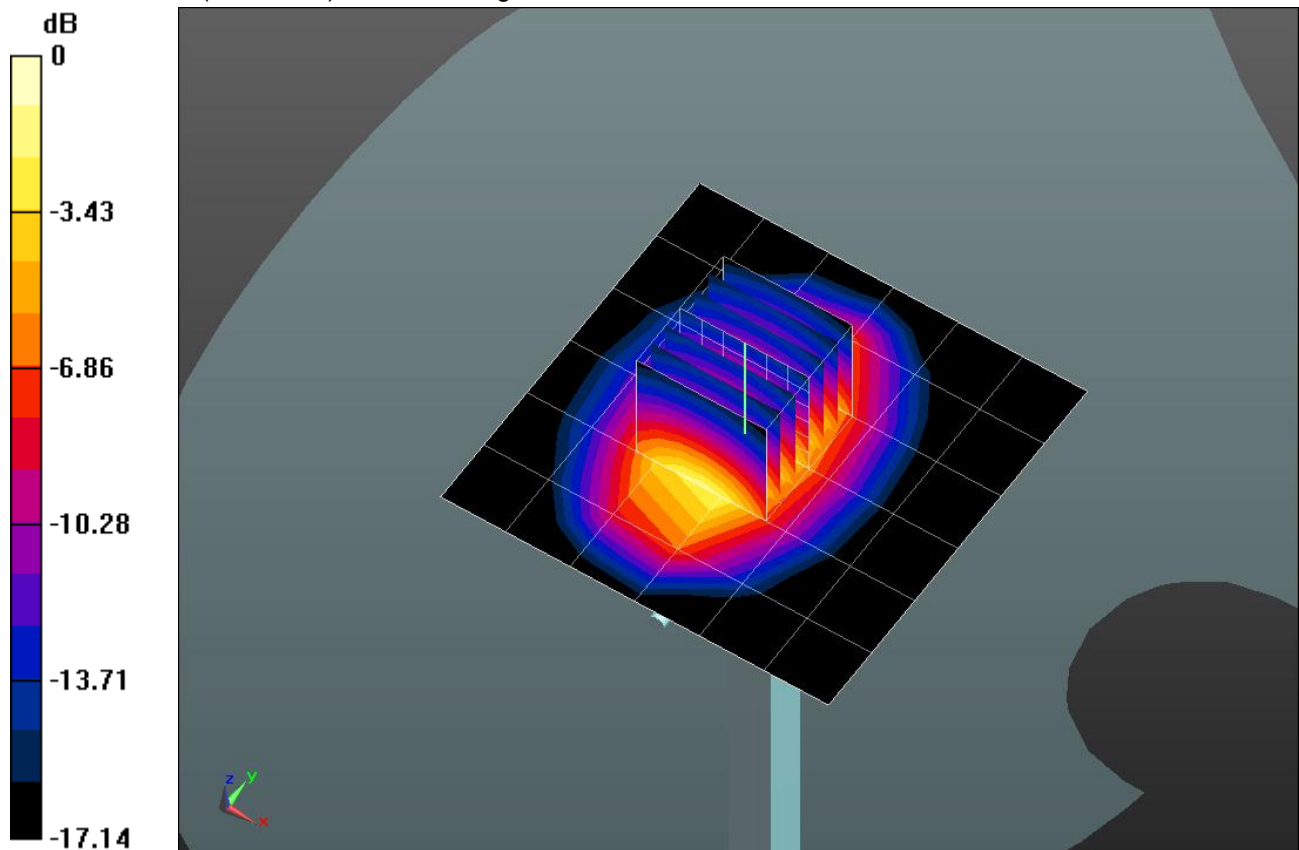

0 dB = 4.900mW/g = 13.80 dB mW/g

20120904_SystemPerformanceCheck-D1750V2 SN 1050

Frequency: 1750 MHz; Duty Cycle: 1:1

Head/Pin=100 mW/Z Scan (1x1x21): Measurement grid: dx=20mm, dy=20mm, dz=5mm
Maximum value of SAR (measured) = 4.142 mW/g

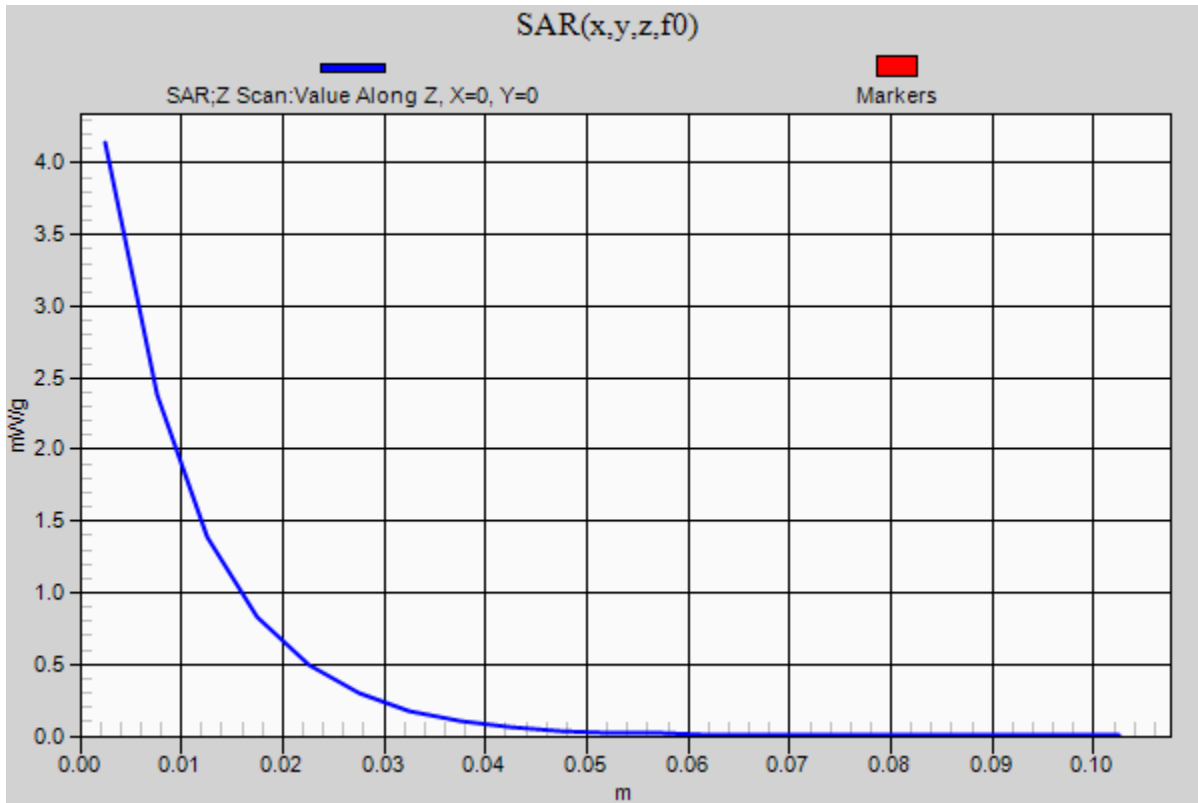

20120904_SystemPerformanceCheck-D750V3 SN 1019

Frequency: 750 MHz; Duty Cycle: 1:1; Room Ambient Temperature: 24.0°C; Liquid Temperature: 23.0°C
Medium parameters used: $f = 750$ MHz; $\sigma = 0.949$ mho/m; $\epsilon_r = 55.233$; $\rho = 1000$ kg/m³

DASY5 Configuration:

- Area Scan setting - Find Secondary Maximum Within: 2.0 dB and with a peak SAR value greater than 0.0012W/kg
- Electronics: DAE4 Sn1259; Calibrated: 2/13/2012
- Probe: EX3DV4 - SN3686; ConvF(8.87, 8.87, 8.87); Calibrated: 2/16/2012
- Sensor-Surface: 2.5mm (Mechanical Surface Detection)
- Phantom: ELI v5.0 (A); Type: QDOVA001BB; Serial: 1120

Body/Pin=100 mW/Area Scan (7x7x1): Measurement grid: dx=15mm, dy=15mm

Maximum value of SAR (measured) = 1.075 mW/g

Body/Pin=100 mW/Zoom Scan (7x7x7)/Cube 0: Measurement grid: dx=5mm, dy=5mm, dz=5mm

Reference Value = 30.384 V/m; Power Drift = 0.13 dB

Peak SAR (extrapolated) = 1.3770

SAR(1 g) = 0.881 mW/g; SAR(10 g) = 0.560 mW/g

Maximum value of SAR (measured) = 1.097 mW/g

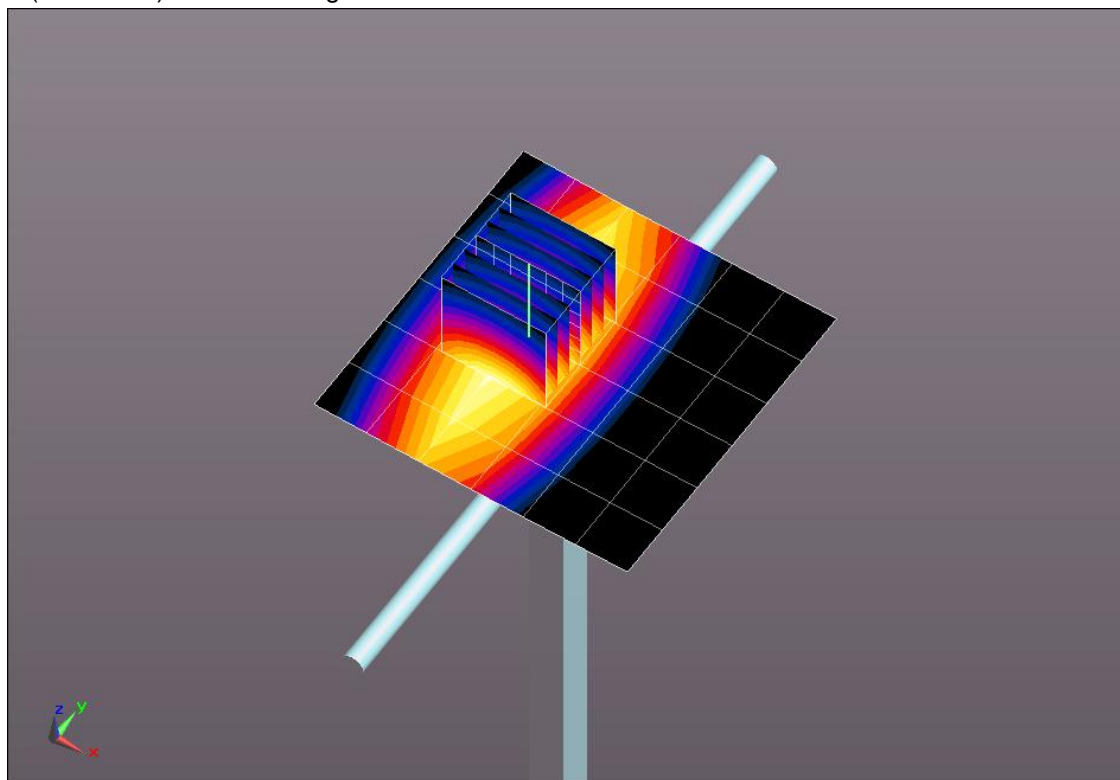
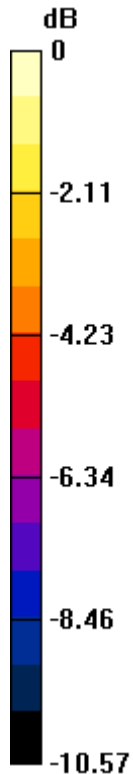

0 dB = 1.100mW/g = 0.83 dB mW/g

20120904_SystemPerformanceCheck-D750V3 SN 1019

Frequency: 750 MHz; Duty Cycle: 1:1

Body/Pin=100 mW/Z Scan (1x1x21): Measurement grid: dx=20mm, dy=20mm, dz=5mm
Maximum value of SAR (measured) = 0.546 mW/g

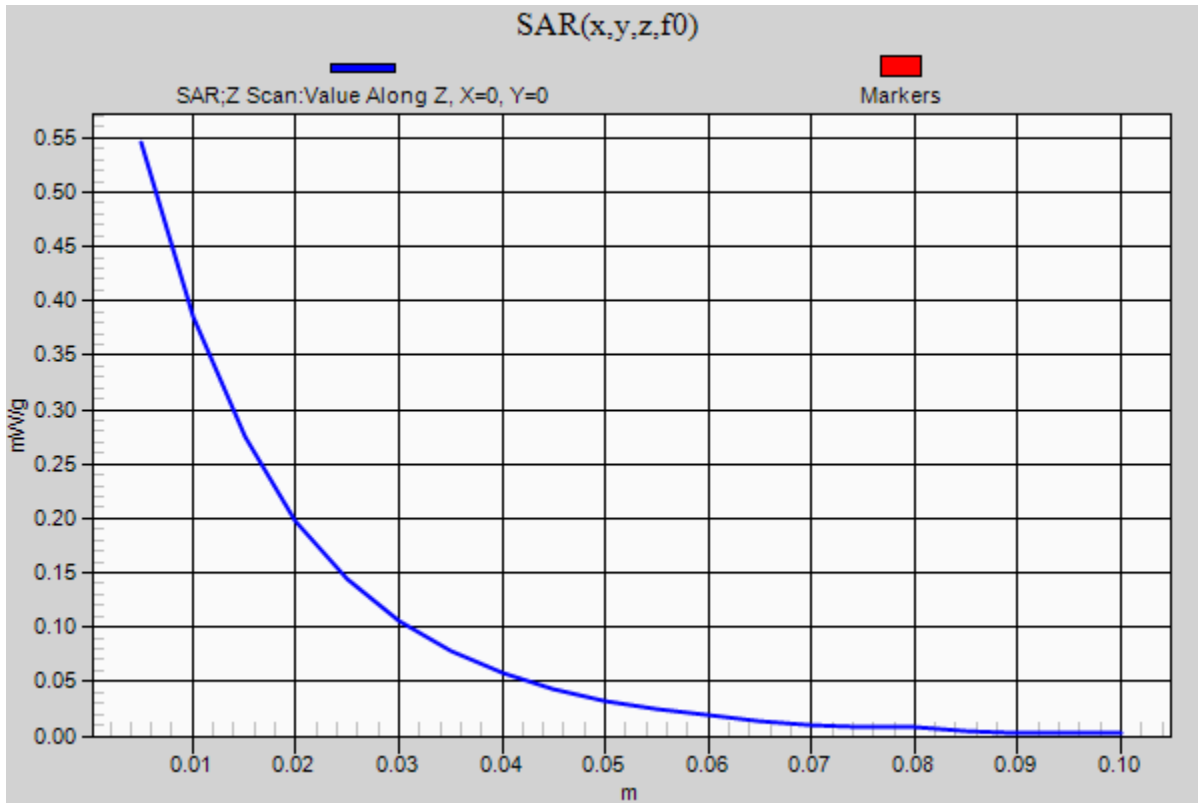

20120904_SystemPerformanceCheck-D835V2 SN 4d002

Frequency: 835 MHz; Duty Cycle: 1:1; Room Ambient Temperature: 24.0°C; Liquid Temperature: 23.0°C

Medium parameters used: $f = 835$ MHz; $\sigma = 0.974$ mho/m; $\epsilon_r = 53.514$; $\rho = 1000$ kg/m³

DASY5 Configuration:

- Area Scan setting - Find Secondary Maximum Within: 2.0 dB and with a peak SAR value greater than 0.0012W/kg
- Electronics: DAE4 Sn1259; Calibrated: 2/13/2012
- Probe: EX3DV4 - SN3686; ConvF(8.73, 8.73, 8.73); Calibrated: 2/16/2012
- Sensor-Surface: 2.5mm (Mechanical Surface Detection)
- Phantom: ELI v5.0 (B); Type: QDOVA001BB; Serial: 1118

Body/Pin=100 mW/Area Scan (7x7x1): Measurement grid: dx=15mm, dy=15mm

Maximum value of SAR (measured) = 1.046 mW/g

Body/Pin=100 mW/Zoom Scan (7x7x7)/Cube 0: Measurement grid: dx=5mm, dy=5mm, dz=5mm

Reference Value = 34.508 V/m; Power Drift = 0.03 dB

Peak SAR (extrapolated) = 1.4450

SAR(1 g) = 0.973 mW/g; SAR(10 g) = 0.640 mW/g

Maximum value of SAR (measured) = 1.182 mW/g

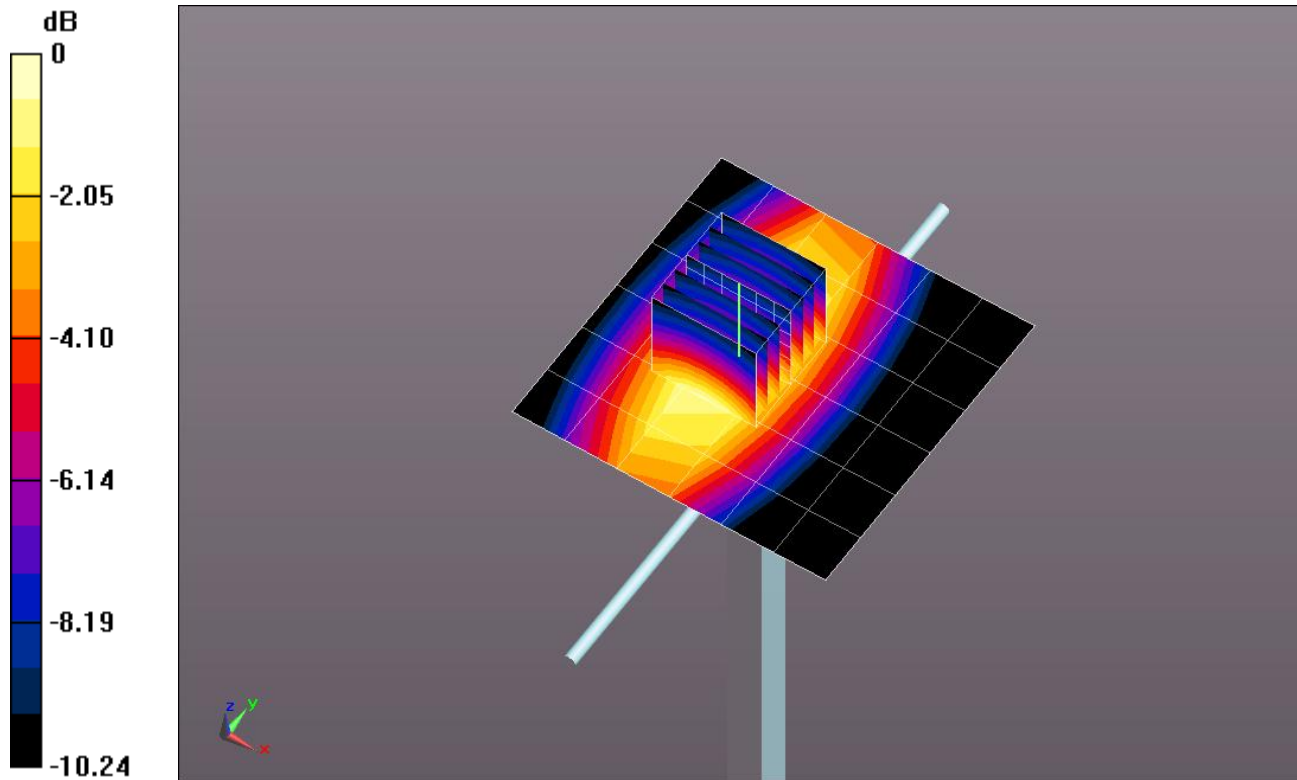

0 dB = 1.180mW/g = 1.44 dB mW/g

20120904_SystemPerformanceCheck-D835V2 SN 4d002

Frequency: 835 MHz; Duty Cycle: 1:1

Body/Pin=100 mW/Z Scan (1x1x21): Measurement grid: dx=20mm, dy=20mm, dz=5mm
Maximum value of SAR (measured) = 0.833 mW/g

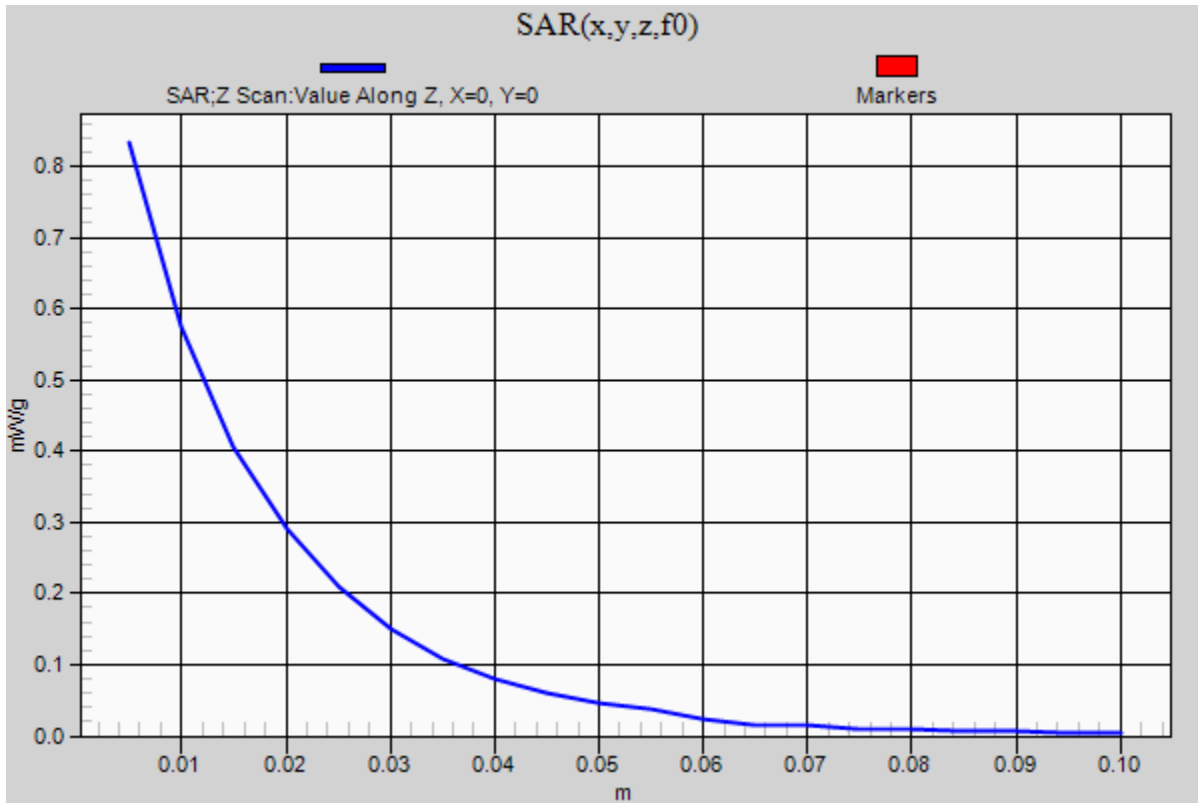

20120904_SystemPerformanceCheck-D1750V2 SN 1050

Frequency: 1750 MHz; Duty Cycle: 1:1; Room Ambient Temperature: 24.0°C; Liquid Temperature: 23.0°C
 Medium parameters used: $f = 1750 \text{ MHz}$; $\sigma = 1.454 \text{ mho/m}$; $\epsilon_r = 51.471$; $\rho = 1000 \text{ kg/m}^3$

DASY5 Configuration:

- Area Scan setting - Find Secondary Maximum Within: 2.0 dB and with a peak SAR value greater than 0.0012W/kg
- Electronics: DAE4 Sn1239; Calibrated: 6/6/2012
- Probe: EX3DV4 - SN3773; ConvF(7.37, 7.37, 7.37); Calibrated: 3/14/2012
- Sensor-Surface: 2.5mm (Mechanical Surface Detection)
- Phantom: ELI v5.0 (A); Type: QDOVA001BB; Serial: 1117

Body/Pin=100 mW/Area Scan (7x7x1): Measurement grid: dx=15mm, dy=15mm

Maximum value of SAR (measured) = 5.072 mW/g

Body/Pin=100 mW/Zoom Scan (7x7x7)/Cube 0: Measurement grid: dx=5mm, dy=5mm, dz=5mm

Reference Value = 59.748 V/m; Power Drift = -0.03 dB

Peak SAR (extrapolated) = 6.7990

SAR(1 g) = 3.79 mW/g; SAR(10 g) = 2.02 mW/g

Maximum value of SAR (measured) = 5.059 mW/g

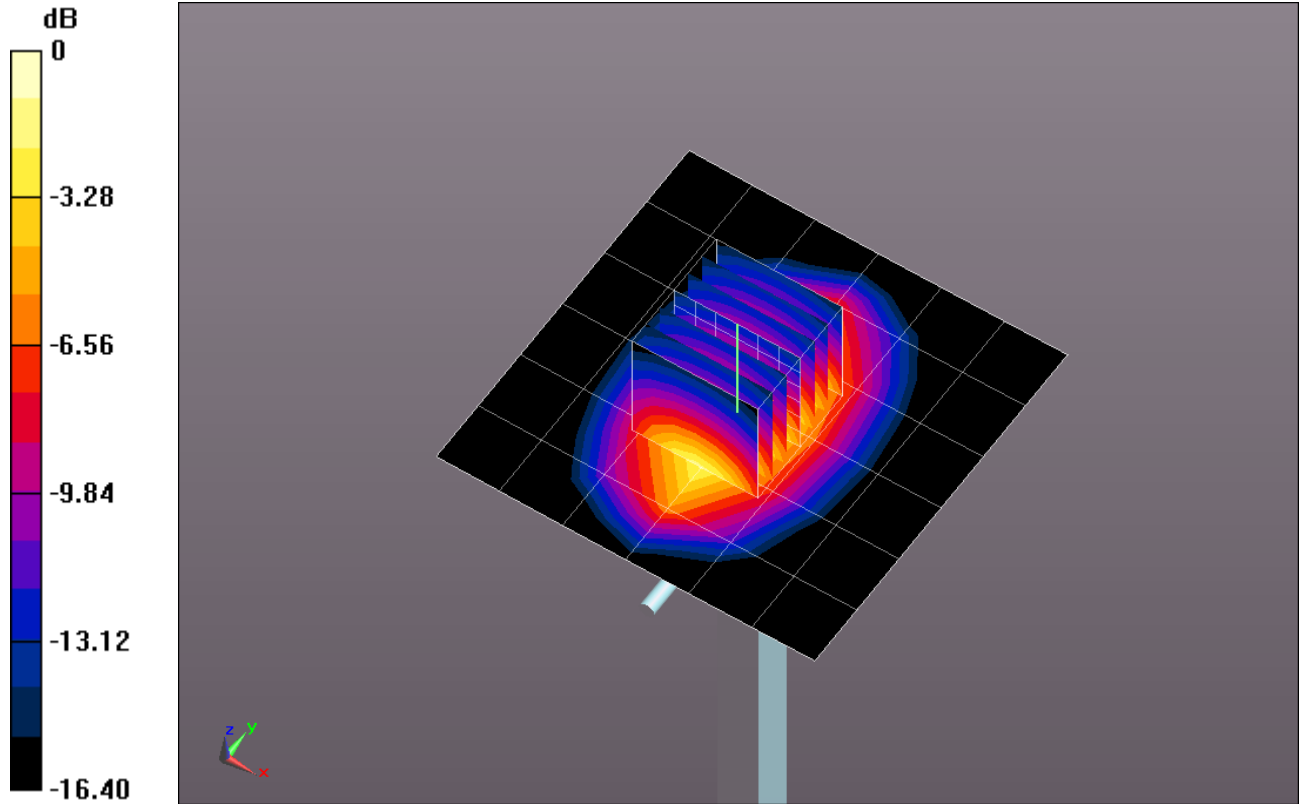

0 dB = 5.060mW/g = 14.08 dB mW/g

20120904_SystemPerformanceCheck-D1750V2 SN 1050

Frequency: 1750 MHz; Duty Cycle: 1:1

Body/Pin=100 mW/Z Scan (1x1x21): Measurement grid: dx=20mm, dy=20mm, dz=5mm
Maximum value of SAR (measured) = 5.035 mW/g

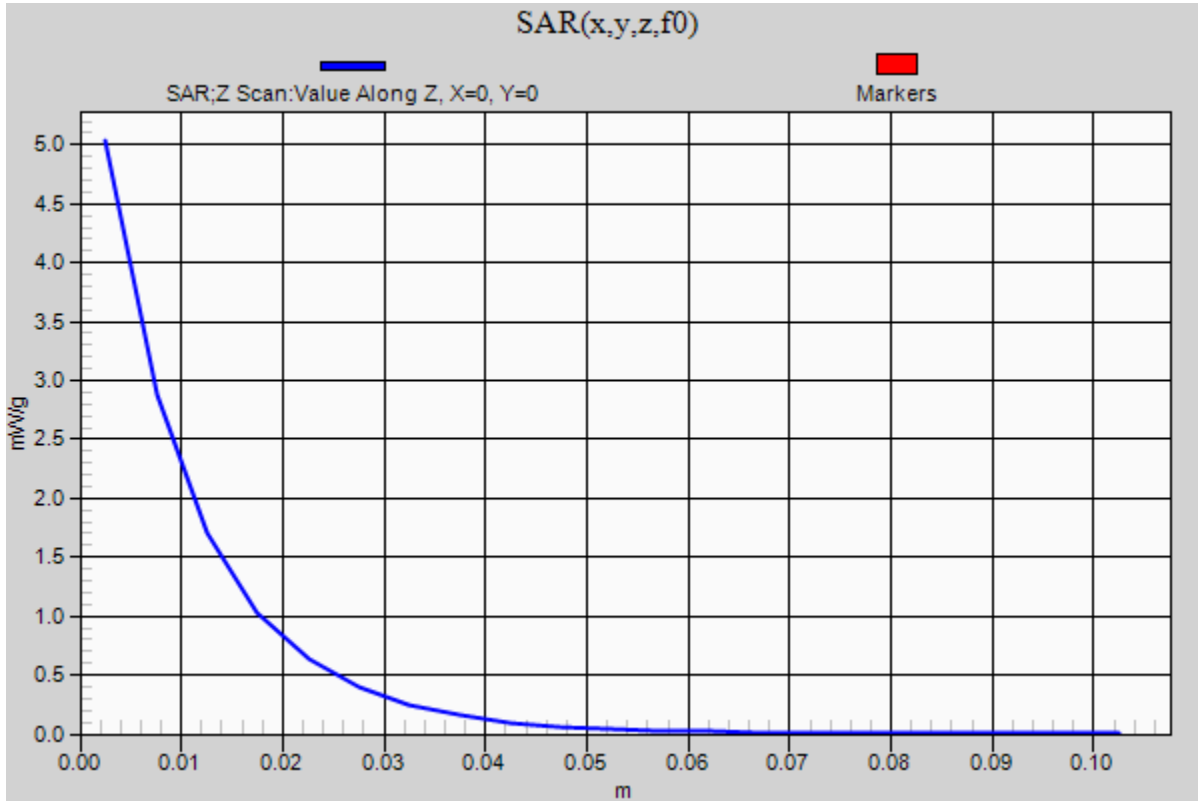

20120904_SystemPerformanceCheck-D750V3 SN 1019

Frequency: 750 MHz; Duty Cycle: 1:1; Room Ambient Temperature: 24.0°C; Liquid Temperature: 23.0°C

Medium parameters used: $f = 750$ MHz; $\sigma = 0.859$ mho/m; $\epsilon_r = 40.411$; $\rho = 1000$ kg/m³

DASY5 Configuration:

- Area Scan setting - Find Secondary Maximum Within: 2.0 dB and with a peak SAR value greater than 0.0012W/kg
- Electronics: DAE4 Sn1258; Calibrated: 3/8/2012
- Probe: EX3DV4 - SN3772; ConvF(9.01, 9.01, 9.01); Calibrated: 2/16/2012
- Sensor-Surface: 2.5mm (Mechanical Surface Detection (Locations From Previous Scan Used)), Sensor-Surface: 2.5mm (Mechanical Surface Detection)
- Phantom: SAM v5.0 (B); Type: QD000P40CD; Serial: 1628

Head/Pin=100 mW 2/Area Scan (7x7x1): Measurement grid: dx=15mm, dy=15mm

Maximum value of SAR (measured) = 0.914 mW/g

Head/Pin=100 mW 2/Zoom Scan (7x7x7)/Cube 0: Measurement grid: dx=5mm, dy=5mm, dz=5mm

Reference Value = 36.119 V/m; Power Drift = 0.04 dB

Peak SAR (extrapolated) = 1.4460

SAR(1 g) = 0.892 mW/g; SAR(10 g) = 0.557 mW/g

Maximum value of SAR (measured) = 1.129 mW/g

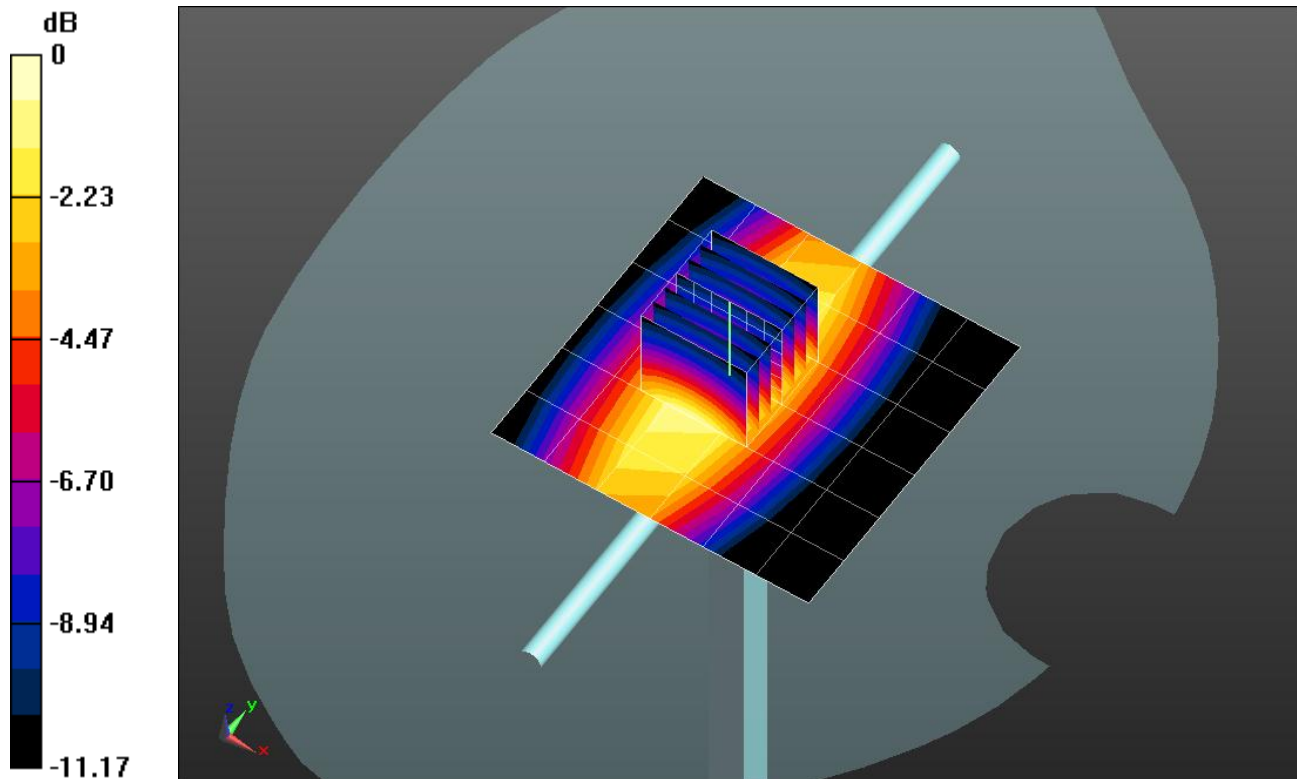

0 dB = 1.130mW/g = 1.06 dB mW/g

20120904_SystemPerformanceCheck-D750V3 SN 1019

Frequency: 750 MHz; Duty Cycle: 1:1

Head/Pin=100 mW 2/Z Scan (1x1x21): Measurement grid: dx=20mm, dy=20mm, dz=5mm
Maximum value of SAR (measured) = 0.659 mW/g

