



**ANSI C63.19-2007
HAC T-COIL SIGNAL TEST REPORT**

FOR
iPhone
(w/ Semco WiFi Module)
MODEL: A1349
FCC ID: BCG-E2422B

REPORT NUMBER: 10U13577-2

ISSUE DATE: January 9, 2011

Prepared for
APPLE INC.
1 INFINITE LOOP,
CUPERTINO, CA 95014

Prepared by
COMPLIANCE CERTIFICATION SERVICES (UL CCS)
47173 BENICIA STREET
FREMONT, CA 94538, U.S.A.
TEL: (510) 771-1000
FAX: (510) 661-0888



NVLAP LAB CODE 200065-0

Revision History

Rev.	Issue Date	Revisions	Revised By
--	January 9, 2011	Initial Issue	--

TABLE OF CONTENTS

1. ATTESTATION OF TEST RESULTS4

2. TEST METHODOLOGY 5

3. FACILITIES AND ACCREDITATION 5

4. CALIBRATION AND UNCERTAINTY 6

 4.1. *MEASURING INSTRUMENT CALIBRATION* 6

 4.2. *MEASUREMENT UNCERTAINTY* 7

5. EQUIPMENT UNDER TEST 8

6. LIST OF AIR INTERFACES/BANDS & OPERATING MODES 8

7. TEST PROCEDURE 9

8. ESTABLISH WD REFERENCE LEVEL 11

9. SUMMARY OF TEST RESULTS 14

 9.1. *Cell Band* 14

 9.2. *PCS Band* 19

10. T-COIL MEASUREMENT CRITERA 24

 10.1. *FREQUENCY RESPONSE* 24

 10.2. *SIGNAL QUALITY* 25

11. ATTACHMENTS 26

12. TEST SETUP PHOTO 27

1. ATTESTATION OF TEST RESULTS

Applicant:	APPLE INC. 1 INFINITE LOOP, MS-26A CUPERTINO, CA 95014
EUT Description:	iPhone
Model number:	A1349 S/N: C8QDR04HDDP7
Device category:	Portable
Exposure category:	General Population/Uncontrolled Exposure
Date tested:	January 8, 2011

T-Coil Signal Quality Category: T4 (Cell Band)
T4 (PCS Band)

Applicable Standards	Test Results
ANSI C63.19-2007	Pass

Compliance Certification Services, Inc. (UL CCS) tested the above equipment in accordance with the requirements set forth in the above standards. All indications of Pass/Fail in this report are opinions expressed by UL CCS based on interpretations and/or observations of test results. Measurement Uncertainties were not taken into account and are published for informational purposes only. The test results show that the equipment tested is capable of demonstrating compliance with the requirements as documented in this report.

Note: The results documented in this report apply only to the tested sample, under the conditions and modes of operation as described herein. This document may not be altered or revised in any way unless done so by UL CCS and all revisions are duly noted in the revisions section. Any alteration of this document not carried out by UL CCS will constitute fraud and shall nullify the document. This report must not be used by the client to claim product certification, approval, or endorsement by NVLAP, NIST, any agency of the Federal Government, or any agency of any government (NIST Handbook 150, Annex A). This report is written to support regulatory compliance of the applicable standards stated above.

Approved & Released For CCS By:

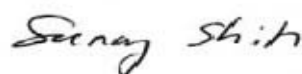

Sunny Shih
Engineering Team Leader
Compliance Certification Services (UL CCS)

Tested By:



Devin Chang
EMC Engineer
Compliance Certification Services (UL CCS)

2. TEST METHODOLOGY

The tests documented in this report were performed in accordance with ANSI C63.19-2007 Methods of Measurement of Compatibility between Wireless Communications Devices and FCC KDB 285076 D01 HAC Guidance v02.

3. FACILITIES AND ACCREDITATION

The test sites and measurement facilities used to collect data are located at 47173 Benicia Street, Fremont, California, USA.

UL CCS is accredited by NVLAP, Laboratory Code 200065-0. The full scope of accreditation can be viewed at <http://www.ccsemc.com>.

4. CALIBRATION AND UNCERTAINTY

4.1. MEASURING INSTRUMENT CALIBRATION

The measuring equipment utilized to perform the tests documented in this report has been calibrated in accordance with the manufacturer's recommendations, and is traceable to recognized national standards.

Name of Equipment	Manufacturer	Type/Model	Serial Number	Cal. Due date		
				MM	DD	Year
Robot - Six Axes	Stäubli	RX90BL	N/A			N/A
Robot Remote Control	Stäubli	CS7MB	3403-91535			N/A
DASY4 Measurement Server	SPEAG	SEUMS001BA	1041			N/A
Probe Alignment Unit	SPEAG	LB (V2)	261			N/A
Audio Magnetic Measuring Ins.l	SPEAG	AMMI	1016			N/A
Coordinating Systeml	SPEAG	AMCC	N/A			N/A
ABM Probe	SPEAG	AM1DV3	3083	11	29	2011
Data Acquisition Electronics	SPEAG	DAE4	1239	11	17	2011
Radio Communication Tester	R & S	CMU 200	116177	9	20	2011

4.2. MEASUREMENT UNCERTAINTY

Measurement Uncertainty for Audio Band Magnetic Measurement

Error Description	Uncertainty values (%)	Probe Dist.	Div.	c		Std. Unc.	
				AMB1	AMB2	AMB1 (%)	AMB2 (%)
Probe Sensitivity							
Reference level	3.0	N	1	1.00	1.00	3.00	3.00
AMCC geometry	0.4	R	1.73	1.00	1.00	0.23	0.23
AMCC current	0.6	R	1.73	1.00	1.00	0.35	0.35
Probe positioning during calibration	0.1	R	1.73	1.00	1.00	0.06	0.06
Noise contribution	0.7	R	1.73	0.01	1.00	0.01	0.40
Frequency slope	5.9	R	1.73	0.10	1.00	0.34	3.41
Probe System							
Repeatability / drift	1.0	R	1.73	1.00	1.00	0.58	0.58
Linearity / Dynamic range	0.6	R	1.73	1.00	1.00	0.35	0.35
Acoustic noise	1.0	R	1.73	0.10	1.00	0.06	0.58
Probe angle	2.3	R	1.73	1.00	1.00	1.33	1.33
Spectral processing	0.9	R	1.73	1.00	1.00	0.52	0.52
Integration time	0.6	N	1.00	1.00	5.00	0.60	3.00
Field disturbance	0.2	R	1.73	1.00	1.00	0.12	0.12
Test Signal							
Reference signal spectral response	0.6	R	1.73	0.00	1.00	0.00	0.35
Positioning							
Probe positioning	1.9	R	1.73	1.00	1.00	1.10	1.10
Phantom positioning	0.9	R	1.73	1.00	1.00	0.52	0.52
EUT positioning	1.9	R	1.73	1.00	1.00	1.10	1.10
External Contributions							
RF interference	0.0	R	1.73	1.00	1.00	0.00	0.00
Test signal variation	2.0	R	1.73	1.00	1.00	1.15	1.15
Combined Std. Uncertainty (ABM field)						4.02	6.08
Expanded Std. Uncertainty (%)						8.04	12.15
Notes for table							
1. N - Nomal							
2. R - Rectangular							
3. Div. - Divisor used to obtain standard uncertainty							

5. EQUIPMENT UNDER TEST

iPhone with 802.11bgn and Bluetooth radio modules. Model number A1349 WiFi module: Semco	
Normal operation:	Held to head, Worn on body (LCD facing-up and LCD facing-down) with 15 mm separation distance.
Body Worn Accessory	Headset
Antenna tested:	<u>Antenna</u> <u>Apple part number</u> WWAN 632-1296-02 WiFi/BT 632-1429-01 (shared with BT)
Antenna-to-antenna separation distances:	8.7 cm from WWAN main antenna-to-WiFi/BT main antenna
Simultaneous transmission:	- 3G can transmit simultaneously with WiFi - 3G can transmit simultaneously with Bluetooth - WiFi can not transmit simultaneously with Bluetooth

6. LIST OF AIR INTERFACES/BANDS & OPERATING MODES

Air-interface	Bands (MHz)	Type	C63.19/ Tested	Simultaneous Transmissions	Concurrent Single Transmission	Reduced power 20.19 (c) (1)	Voice Over Digital Transport (Data)
CDMA	850	VO	Yes	Yes WiFi or Bluetooth	No: Ev-Do, WiFi	No	N/A
	1900	VO	Yes			No	N/A
	EV-Do	DT	N/A	N/A	No	No	Yes
WiFi	2400	DT	NA	CDMA	NA	NA	Yes
	5000	DT	NA	CDMA	NA	NA	Yes
Bluetooth	2400	DT	NA	CDMA	NA	NA	Yes
VO Voice CMRS/PSTN Service Only V/D Voice CMRS/PSTN and Data Service DT Digital Transport				*HAC rating was not based on concurrent voice and data modes, Non current mode was found to represent worst case rating for both M and T rating.			

7. TEST PROCEDURE

ANSI C63.19-2007, Section 6

This document describes the procedures used to measure the ABM (T-Coil) performance of the WD. In addition to measuring the absolute signal levels, the A-weighted magnitude of the unintended signal shall also be determined. In order to assure that the required signal quality is measured, the measurement of the intended signal and the measurement of the unintended signal must be made at the same location for all measurement positions. In addition, the RF field strength at each measurement location must be at or below that required for the assigned category.

Measurements shall not include undesired properties from the WD's RF field; therefore, use of a coaxial connection to a base station simulator or non-radiating load may be necessary. However, even then with a coaxial connection to a base station simulator or non-radiating load there may still be RF leakage from the WD, which may interfere with the desired measurement. Pre-measurement checks should be made to avoid this possibility. All measurements shall be done with the WD operating on battery power with an appropriate normal speech audio signal input level given in Table 6.1. If the device display can be turned off during a phone call then that may be done during the measurement as well.

Measurements shall be performed at all three locations, with the correct probe orientation for a particular location, in a multi-stage sequence by first measuring the field intensity of the desired T-Coil signal (ABM1) that is useful to a hearing aid T-Coil. The undesired magnetic components (ABM2) shall be examined for each probe orientation to determine possible effects from the WD display and battery current paths that may disrupt the desired T-Coil signal. The undesired magnetic signal (ABM2) must be measured at the same location as the measurement of the desired ABM or T-Coil signal (ABM1) and the ratio of desired to undesired ABM signals calculated. For the axial field location only the ABM1 frequency response shall be determined in a third measurement stage. The flowchart in Figure 6.3 illustrates this three-stage, three-orientation process.

The following steps summarize the basic test flow for determining ABM1¹ and ABM2². These steps assume that a sine wave or narrowband 1/3 octave signal can be used for the measurement of ABM1.

- 1) A reference check of the test setup and instrumentation may be performed using a TMFS. Position the TMFS into the test setup at the position to be occupied by the WD. Measure the emissions from the TMFS and confirm that they are within tolerance of the expected values.
- 2) Position the WD in the test setup and connect the WD RF connector to a base station simulator or a non-radiating load as shown in Figure 6.1 or Figure 6.2. Confirm that equipment that requires calibration has been calibrated, and that the noise level meets the requirements given in 6.2.1.
- 3) The drive level to the WD is set such that the reference input level defined in 6.3.2.1, Table 6.1 is input to the base station simulator (or manufacturer's test mode equivalent) in the 1 kHz, 1/3 octave band. This drive level shall be used for the T-Coil signal test (ABM1) at $f = 1$ kHz. Either a sine wave at 1025 Hz or a voice-like signal, band-limited to the 1 kHz 1/3 octave, as defined in 6.3.2, shall be used for the reference audio signal. If interference is found at 1025 Hz an alternate nearby reference audio signal frequency may be used.⁴⁶ The same drive level will be used for the ABM1 frequency response measurements at each 1/3 octave band center frequency. The WD volume control may be set at any level up to maximum, provided that a signal at any frequency at maximum modulation would not result in clipping or signal overload.
- 4) Determine the magnetic measurement locations for the WD device (see A.3), if not already specified by the manufacturer, as described in 6.3.4.1.1 and 6.3.4.4.

¹ **Audio Band Magnetic signal - desired (ABM1):** Measured quantity of the desired magnetic signal

² **audio band magnetic signal - undesired (ABM2):** Measured quantity of the undesired magnetic signal, such as interference from battery current and similar non-signal elements.

- 5) At each measurement location, measure and record the desired T-Coil magnetic signals (ABM1 at f_i) as described in 6.3.4.2 in each individual ISO 266-1975 R10 standard 1/3 octave band. The desired audio band input frequency (f_i) shall be centered in each 1/3 octave band maintaining the same drive level as determined in Step 2) and the reading taken for that band.

Equivalent methods of determining the frequency response may also be employed, such as fast Fourier transform (FFT) analysis using noise excitation or input–output comparison using simulated speech. The full-band integrated or half-band integrated probe output, as described in D.18, may be used, as long as the appropriate calibration curve is applied to the measured result, so as to yield an accurate measurement of the field magnitude. (The resulting measurement shall be an accurate measurement in dB A/m.)

All measurements of the desired signal shall be shown to be of the desired signal and not of an undesired signal. This may be shown by turning the desired signal on and off with the probe measuring the same location. If the scanning method is used the scans shall show that all measurement points selected for the ABM1 measurement meet the ambient and test system noise criterion in 6.2.1.

- 6) At each measurement location measure and record the undesired broadband audio magnetic signal (ABM2) as described in 6.3.4.3 with no audio signal applied (or digital zero applied, if appropriate) using A-weighting, and the half-band integrator. Calculate the ratio of the desired to undesired signal strength (i.e., signal quality).
- 7) Change the probe orientation to one of the two remaining orientations. At both measurement orientations, measure and record ABM1 using either a sine wave at 1025 Hz or a voice-like signal as defined in 9) for the reference audio input signal.
- 8) Obtain the data from the postprocessor, SEMCAD, and determine the category that properly classifies the signal quality based on Table 7.7.

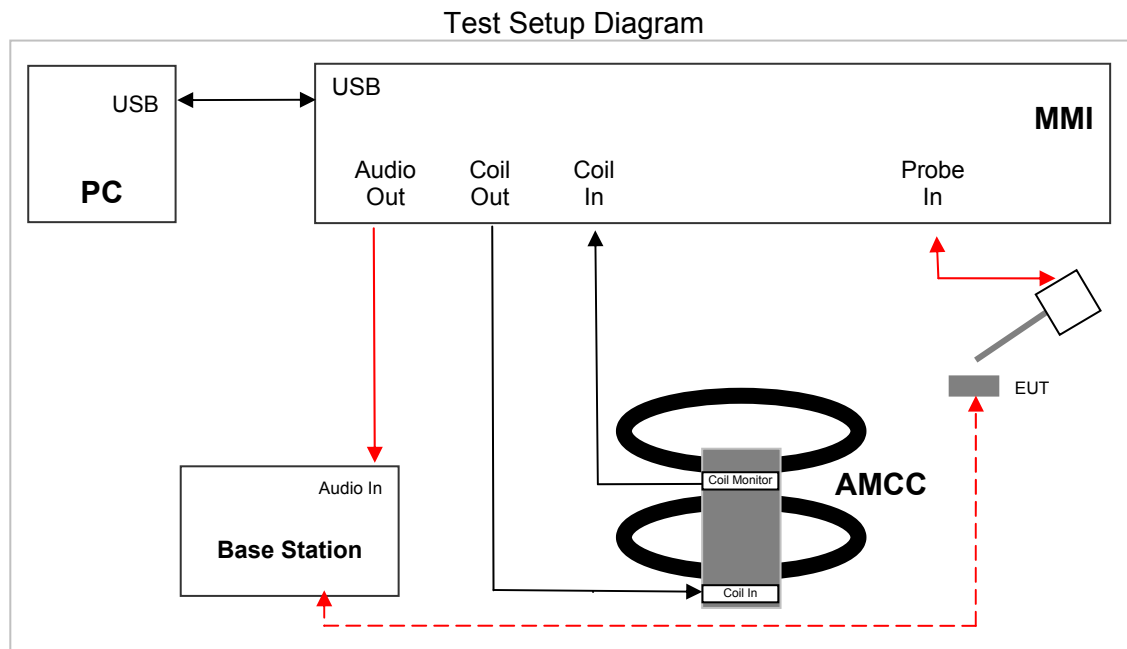

8. ESTABLISH WD REFERENCE LEVEL

First step is to find the Uref, which is 1 kHz signal output of the CMU200. The following figures show the setup for the measurements. The first step is to measure Uref and the following step is to measure U, which is the signal from AMMI to the CMU200 during testing.

The setup shown below is used to measure Uref. To measure the reference input level, first connect the Coil In of the AMMI to the Audio Out of the CMU200 (as indicated by the figure below). Then establish a conducted link between the EUT and the CMU200. Once the link is established, select the network tab of the CMU200 and change the bitstream setting to decoder cal in order for the CMU to produce the necessary calibration 1 kHz signal. Record the value from the Dasy4 file and use this value as Uref.

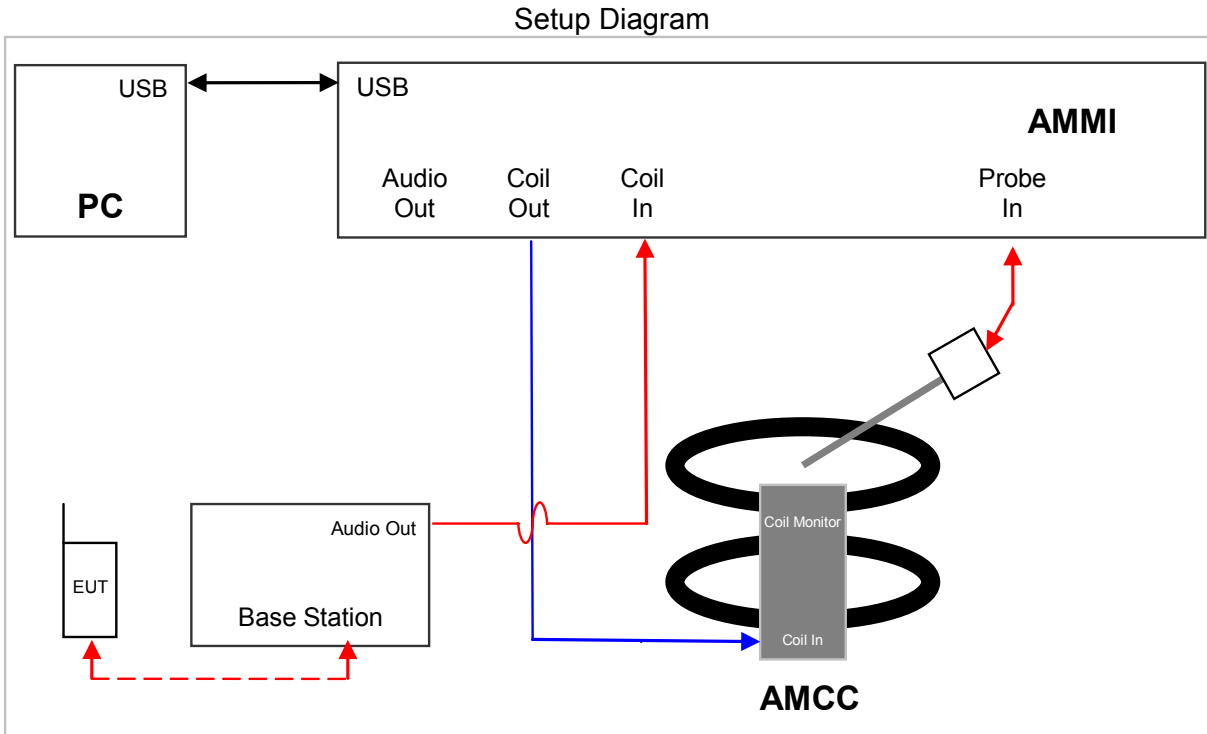

Next step is to measure U, which is the signal from AMMI to the CMU200 during testing. The following setup is used to measure U for narrow band (Voice 1.025 kHz) and broad band (300 Hz – 300 kHz) signals:

To determine the DASY gain setting necessary to achieve the proper EUT signal level, connect the Coil In of AMMI to the Audio Out of AMMI. Run the narrow band job (Voice 1.025kHz signal setting) from DASY4 and record the RMS coil signal. Adjust the gain of the signal by changing the gain value within the particular DASY job until the coil signal reading is that of the desired output signal level. Repeat this step for the broad band job (Voice 300 – 3kHz signal).

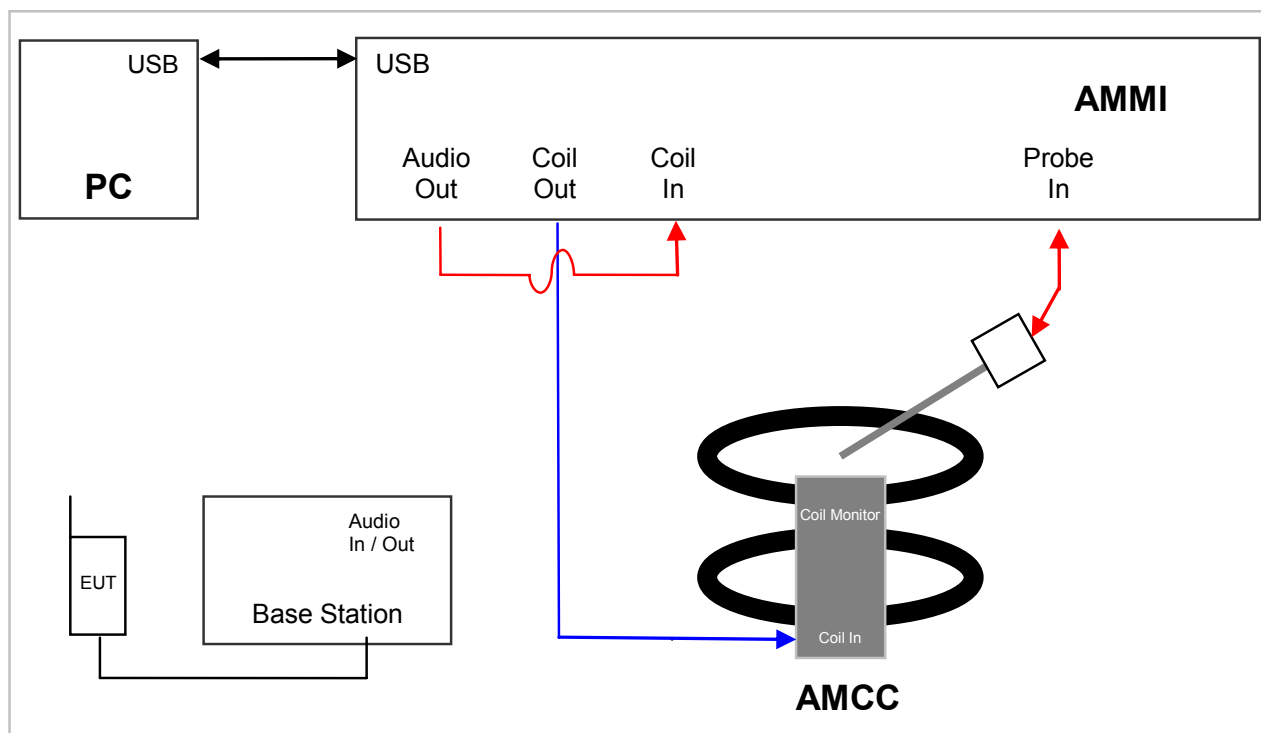

Measured Input Level is calculated: $Measured_Input_Level = 20 * \text{Log} \left(\frac{U}{U_{ref}} \right)$

RESULTS

CDMA2000

1 kHz Voice Signal

Applied Signal	RMS V	Result Input Level (dBm0)	Reference Input Level (dBm0)	
U	0.095	-18.0	CDMA	-18.0
U _{ref}	0.750		GSM	-16.0

Adjusted Gain Setting	RMS dB V
38.5	-20.46
N/A	-2.50

300 Hz-3 kHz Voice Signal

Applied Signal	RMS V	Measured Input Level (dBm0)	Reference Input Level (dBm0)	
U	0.095	-18.0	CDMA	-18.0
U _{ref}	0.750		GSM	-16.0

Gain Setting	RMS dB V
75.5	-20.45
N/A	-2.50

9. SUMMARY OF TEST RESULTS

9.1. Cell Band

Test Mode	Ch. No/Freq.	Probe orientation	ABM1 \geq -18 dB (A/m)	BWC Factor (dB)	ABM SNR (dB)	T-Rating
RC1/SO68 Voice Coder: 8k EVRC-B (Low)	384/ 836.52 MHz	z (Axial):	-2.01	0.16	33.22	T4
		x (Radial):	-11.39	0.16	32.47	T4
		y (Radial):	-11.24	0.16	34.20	T4

Note:

1. The Radio Configuration / Service Option was set to RC1/SO68
2. The Wi-Fi and Bluetooth were off during testing.

Freq. Resp.

Date/Time: 1/8/2011 3:44:40 PM

Test Laboratory: UL CCS

Cell Band

DUT: Apple; Type: n/a; Serial: n/a

Communication System: CDMA Cell Band; Frequency: 836.52 MHz; Duty Cycle: 1:1

T-Coil scan/General Scans/z (axial) wideband at best S/N/ABM [HAC-2007] Freq Resp(x,y,z,f) (1x1x1):

Measurement grid: dx=10mm, dy=10mm
Signal Type: Audio File (.wav) 48k_voice_300-3000_2s.wav
Output Gain: 75.5
Measure Window Start: 300ms
Measure Window Length: 2000ms
BWC applied: 10.80 dB
Device Reference Point: 0, 0, -6.3 mm

Cursor:

Diff = 0.69 dB
BWC Factor = 10.80 dB
Location: 25, -25, 3.7 mm

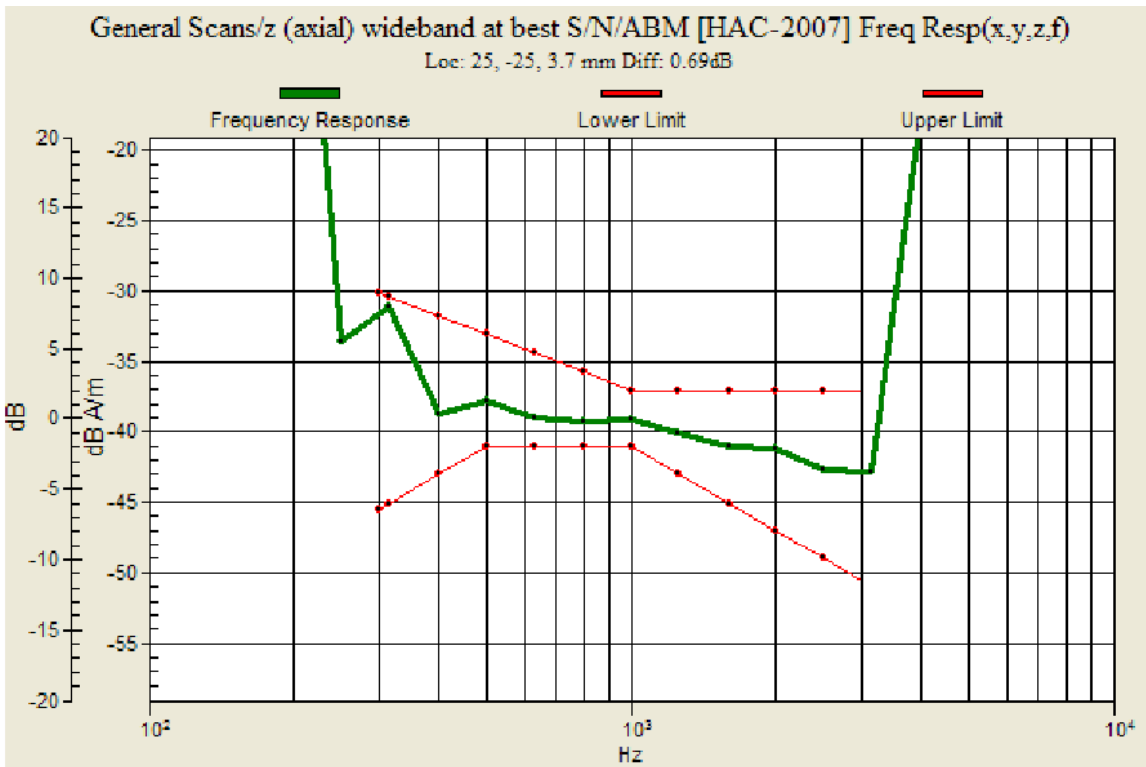

Z (Axial)

Date/Time: 1/8/2011 2:35:10 PM

Test Laboratory: UL CCS

Cell Band

Communication System: CDMA Cell Band; Frequency: 836.52 MHz; Duty Cycle: 1:1

Medium parameters used: $\sigma = 0$ mho/m, $\epsilon_r = 1$; $\rho = 1$ kg/m³

Phantom section: TCoil Section

DASY4 Configuration:

- Probe: AM1DV3 - 3083; ; Calibrated: 11/29/2010
- Sensor-Surface: 0mm (Fix Surface)
- Electronics: DAE4 Sn1239; Calibrated: 11/17/2010
- Phantom: HAC Test Arch with AMCC; Type: SD HAC P01 BB; Serial: 1146
- SEMCAD X Version 14.4.2 (2595)

T-Coil scan/General Scans/z (axial) 4.2mm 50 x 50/ABM [HAC-2007] SNR(x,y,z) (13x13x1):

Measurement grid: dx=10mm, dy=10mm

Signal Type: Audio File (.wav) 48k_voice_1kHz_1s.wav

Output Gain: 38.5

Measure Window Start: 300ms

Measure Window Length: 1000ms

BWC applied: 0.16 dB

Device Reference Point: 0, 0, -6.3 mm

Category	Telephone parameters WD signal quality [(signal+noise)-to-noise ratio in decibels]
Category T1	0 dB to 10 dB
Category T2	10 dB to 20 dB
Category T3	20 dB to 30 dB
Category T4	> 30 dB

Cursor:

ABM1/ABM2 = 33.22 dB

ABM1 comp = -2.01 dB A/m

BWC Factor = 0.16 dB

Location: 0, -4.2, 3.7 mm

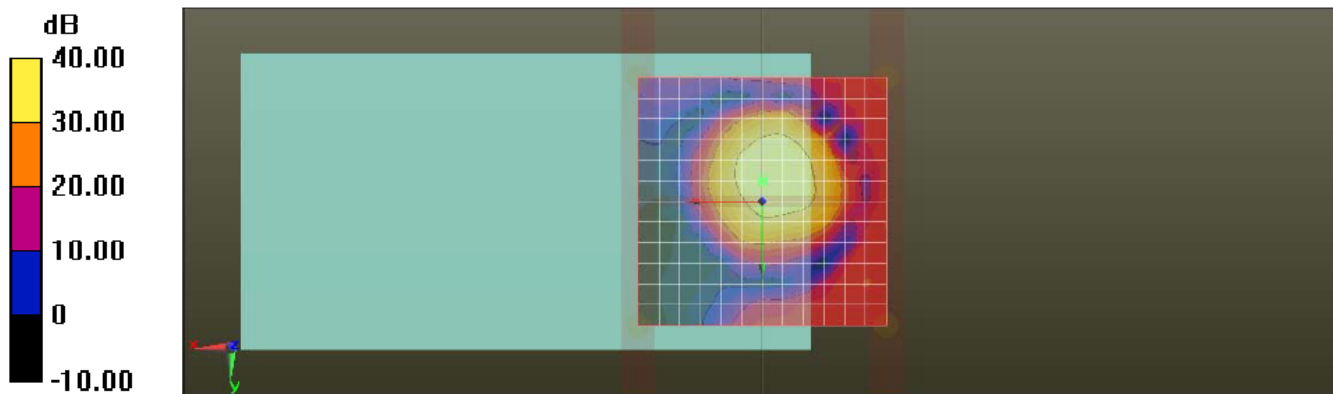

0 dB = 1.000

X (Radial)

Date/Time: 1/8/2011 2:55:45 PM

Test Laboratory: UL CCS

Cell Band

Communication System: CDMA Cell Band; Frequency: 836.52 MHz; Duty Cycle: 1:1

Medium parameters used: $\sigma = 0$ mho/m, $\epsilon_r = 1$; $\rho = 1$ kg/m³

Phantom section: TCoil Section

DASY4 Configuration:

- Probe: AM1DV3 - 3083; ; Calibrated: 11/29/2010
- Sensor-Surface: 0mm (Fix Surface)
- Electronics: DAE4 Sn1239; Calibrated: 11/17/2010
- Phantom: HAC Test Arch with AMCC; Type: SD HAC P01 BB; Serial: 1146
- SEMCAD X Version 14.4.2 (2595)

T-Coil scan/General Scans/x (longitudinal) 4.2mm 50 x 50/ABM [HAC-2007]

SNR(x,y,z) (13x13x1):

Measurement grid: dx=10mm, dy=10mm

Signal Type: Audio File (.wav) 48k_voice_1kHz_1s.wav

Output Gain: 38.5

Measure Window Start: 300ms

Measure Window Length: 1000ms

BWC applied: 0.16 dB

Device Reference Point: 0, 0, -6.3 mm

Category	Telephone parameters WD signal quality [(signal+noise)-to-noise ratio in decibels]
Category T1	0 dB to 10 dB
Category T2	10 dB to 20 dB
Category T3	20 dB to 30 dB
Category T4	> 30 dB

Cursor:

ABM1/ABM2 = 32.47 dB

ABM1 comp = -11.39 dB A/m

BWC Factor = 0.16 dB

Location: -12.5, -4.2, 3.7 mm

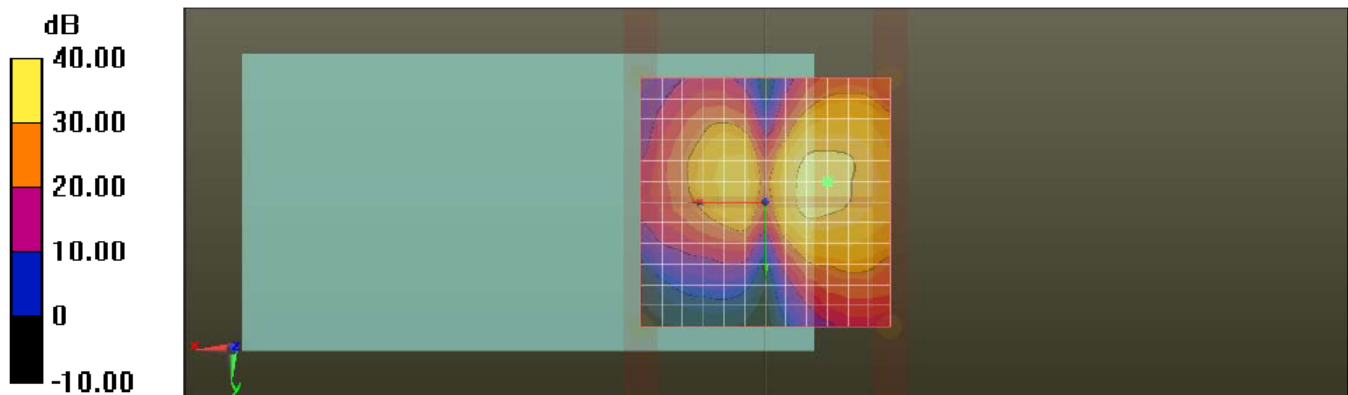

0 dB = 1.000

Y (Radial)

Date/Time: 1/8/2011 3:21:05 PM

Test Laboratory: UL CCS

Cell Band

Communication System: CDMA Cell Band; Frequency: 836.52 MHz; Duty Cycle: 1:1

Medium parameters used: $\sigma = 0$ mho/m, $\epsilon_r = 1$; $\rho = 1$ kg/m³

Phantom section: TCoil Section

DASY4 Configuration:

- Probe: AM1DV3 - 3083; ; Calibrated: 11/29/2010
- Sensor-Surface: 0mm (Fix Surface)
- Electronics: DAE4 Sn1239; Calibrated: 11/17/2010
- Phantom: HAC Test Arch with AMCC; Type: SD HAC P01 BB; Serial: 1146
- SEMCAD X Version 14.4.2 (2595)

T-Coil scan/General Scans/y (transversal) 4.2mm 50 x 50/ABM [HAC-2007] SNR (x,y,z) (13x13x1):

Measurement grid: dx=10mm, dy=10mm

Signal Type: Audio File (.wav) 48k_voice_1kHz_1s.wav

Output Gain: 38.5

Measure Window Start: 300ms

Measure Window Length: 1000ms

BWC applied: 0.16 dB

Device Reference Point: 0, 0, -6.3 mm

Category	Telephone parameters WD signal quality [(signal+noise)-to-noise ratio in decibels]
Category T1	0 dB to 10 dB
Category T2	10 dB to 20 dB
Category T3	20 dB to 30 dB
Category T4	> 30 dB

Cursor:

ABM1/ABM2 = 34.20 dB

ABM1 comp = -11.24 dB A/m

BWC Factor = 0.16 dB

Location: 0, -12.5, 3.7 mm

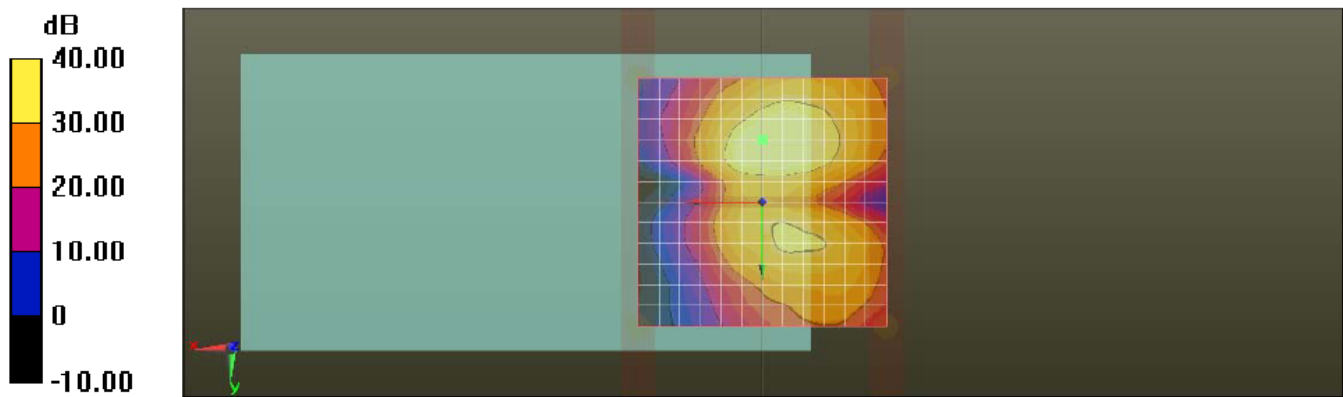

9.2. PCS Band

Test Mode	Ch. No/Freq.	Probe orientation	ABM1 \geq -18 dB (A/m)	BWC Factor (dB)	ABM SNR (dB)	T-Rating
RC1/SO68 Voice Coder: 8k EVRC-B (Low)	600/ 1880 MHz	z (Axial):	-7.18	0.16	33.34	T4
		x (Radial):	-11.71	0.16	32.19	T4
		y (Radial):	-11.34	0.16	34.36	T4

Note:

1. The Radio Configuration / Service Option was set to RC1/SO68
2. The Wi-Fi and Bluetooth were off during testing.

Freq. Resp.

Date/Time: 1/8/2011 5:06:01 PM

Test Laboratory: UL CCS

PCS Band

DUT: Apple; Type: n/a; Serial: n/a

Communication System: CDMA PCS Band; Frequency: 1880 MHz;Duty Cycle: 1:1

T-Coil scan/General Scans/z (axial) wideband at best S/N/ABM [HAC-2007] Freq Resp(x,y,z,f) (1x1x1):

Measurement grid: dx=10mm, dy=10mm
Signal Type: Audio File (.wav) 48k_voice_300-3000_2s.wav
Output Gain: 75.5
Measure Window Start: 300ms
Measure Window Length: 2000ms
BWC applied: 10.80 dB
Device Reference Point: 0, 0, -6.3 mm

Cursor:

Diff = 2.00 dB
BWC Factor = 10.80 dB
Location: 25, -25, 3.7 mm

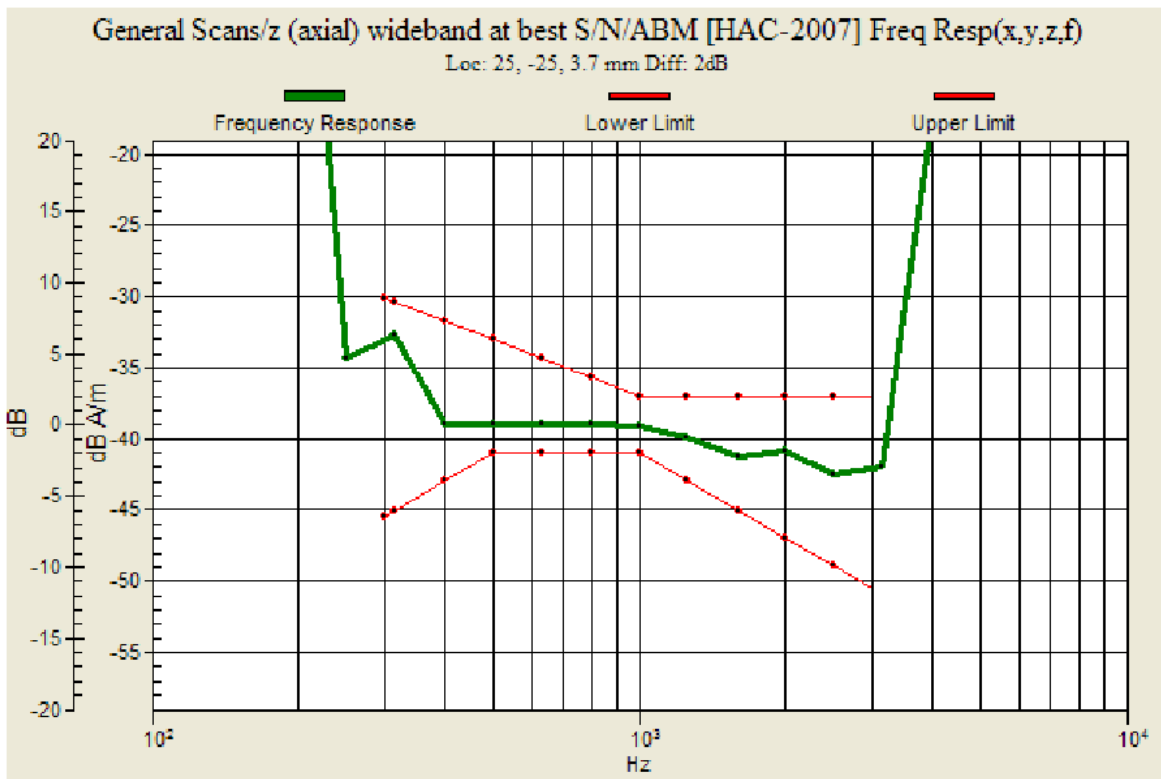

Z (Axial)

Date/Time: 1/8/2011 4:03:38 PM

Test Laboratory: UL CCS

PCS Band

Communication System: CDMA PCS Band; Frequency: 1880 MHz; Duty Cycle: 1:1

Medium parameters used: $\sigma = 0$ mho/m, $\epsilon_r = 1$; $\rho = 1$ kg/m³

Phantom section: TCoil Section

DASY4 Configuration:

- Probe: AM1DV3 - 3083; ; Calibrated: 11/29/2010
- Sensor-Surface: 0mm (Fix Surface)
- Electronics: DAE4 Sn1239; Calibrated: 11/17/2010
- Phantom: HAC Test Arch with AMCC; Type: SD HAC P01 BB; Serial: 1146
- SEMCAD X Version 14.4.2 (2595)

T-Coil scan/General Scans/z (axial) 4.2mm 50 x 50/ABM [HAC-2007] SNR(x,y,z) (13x13x1):

Measurement grid: dx=10mm, dy=10mm

Signal Type: Audio File (.wav) 48k_voice_1kHz_1s.wav

Output Gain: 38.5

Measure Window Start: 300ms

Measure Window Length: 1000ms

BWC applied: 0.16 dB

Device Reference Point: 0, 0, -6.3 mm

Category	Telephone parameters WD signal quality [(signal+noise)-to-noise ratio in decibels]
Category T1	0 dB to 10 dB
Category T2	10 dB to 20 dB
Category T3	20 dB to 30 dB
Category T4	> 30 dB

Cursor:

ABM1/ABM2 = 33.34 dB

ABM1 comp = -7.18 dB A/m

BWC Factor = 0.16 dB

Location: -4.2, -8.3, 3.7 mm

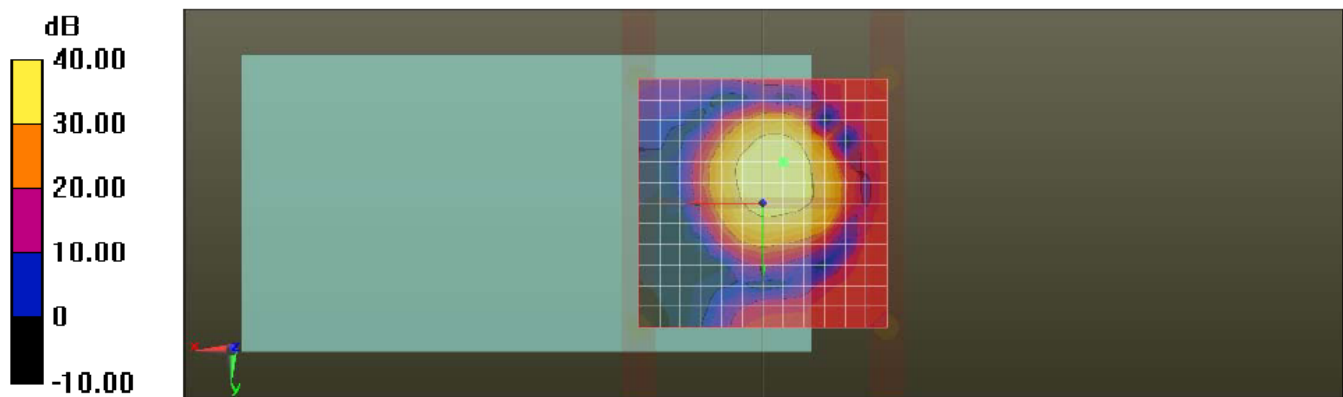

0 dB = 1.000

X (Radial)

Date/Time: 1/8/2011 4:24:13 PM

Test Laboratory: UL CCS

PCS Band

Communication System: CDMA PCS Band; Frequency: 1880 MHz; Duty Cycle: 1:1
 Medium parameters used: $\sigma = 0$ mho/m, $\epsilon_r = 1$; $\rho = 1$ kg/m³

Phantom section: TCoil Section

DASY4 Configuration:

- Probe: AM1DV3 - 3083; ; Calibrated: 11/29/2010
- Sensor-Surface: 0mm (Fix Surface)
- Electronics: DAE4 Sn1239; Calibrated: 11/17/2010
- Phantom: HAC Test Arch with AMCC; Type: SD HAC P01 BB; Serial: 1146
- SEMCAD X Version 14.4.2 (2595)

T-Coil scan/General Scans/x (longitudinal) 4.2mm 50 x 50/ABM [HAC-2007]

SNR(x,y,z) (13x13x1):

Measurement grid: dx=10mm, dy=10mm
 Signal Type: Audio File (.wav) 48k_voice_1kHz_1s.wav
 Output Gain: 38.5
 Measure Window Start: 300ms
 Measure Window Length: 1000ms
 BWC applied: 0.16 dB
 Device Reference Point: 0, 0, -6.3 mm

Category	Telephone parameters WD signal quality [(signal+noise)-to-noise ratio in decibels]
Category T1	0 dB to 10 dB
Category T2	10 dB to 20 dB
Category T3	20 dB to 30 dB
Category T4	> 30 dB

Cursor:

ABM1/ABM2 = 32.19 dB
 ABM1 comp = -11.71 dB A/m
 BWC Factor = 0.16 dB
 Location: -12.5, -4.2, 3.7 mm

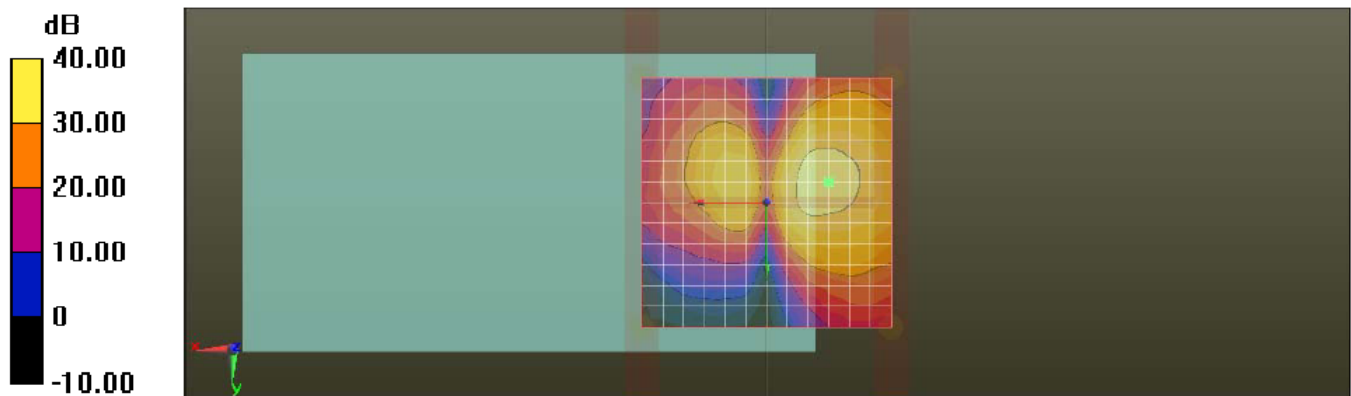

0 dB = 1.000

Y (Radial)

Date/Time: 1/8/2011 4:44:45 PM

Test Laboratory: UL CCS

PCS Band

Communication System: CDMA PCS Band; Frequency: 1880 MHz; Duty Cycle: 1:1

Medium parameters used: $\sigma = 0$ mho/m, $\epsilon_r = 1$; $\rho = 1$ kg/m³

Phantom section: TCoil Section

DASY4 Configuration:

- Probe: AM1DV3 - 3083; ; Calibrated: 11/29/2010
- Sensor-Surface: 0mm (Fix Surface)
- Electronics: DAE4 Sn1239; Calibrated: 11/17/2010
- Phantom: HAC Test Arch with AMCC; Type: SD HAC P01 BB; Serial: 1146
- SEMCAD X Version 14.4.2 (2595)

T-Coil scan/General Scans/y (transversal) 4.2mm 50 x 50/ABM [HAC-2007] SNR (x,y,z) (13x13x1):

Measurement grid: dx=10mm, dy=10mm

Signal Type: Audio File (.wav) 48k_voice_1kHz_1s.wav

Output Gain: 38.5

Measure Window Start: 300ms

Measure Window Length: 1000ms

BWC applied: 0.16 dB

Device Reference Point: 0, 0, -6.3 mm

Category	Telephone parameters WD signal quality [(signal+noise)-to-noise ratio in decibels]
Category T1	0 dB to 10 dB
Category T2	10 dB to 20 dB
Category T3	20 dB to 30 dB
Category T4	> 30 dB

Cursor:

ABM1/ABM2 = 34.36 dB

ABM1 comp = -11.34 dB A/m

BWC Factor = 0.16 dB

Location: 0, -12.5, 3.7 mm

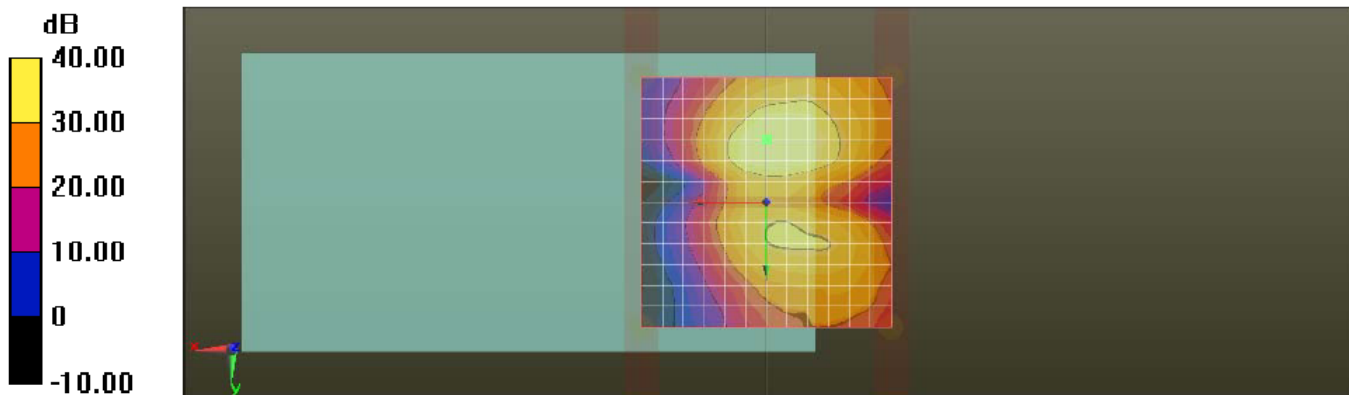

0 dB = 1.000

10. T-COIL MEASUREMENT CRITERA

10.1. FREQUENCY RESPONSE

The frequency response of the axial component of the magnetic field, measured in 1/3 octave bands, shall follow the response curve, over the frequency range 300 Hz to 3000 Hz.

Figure 7.1 and Figure 7.2 provide the boundaries for the specified frequency. These response curves are for true field strength measurements of the T-Coil signal. Thus the 6 dB/octave probe response has been corrected from the raw readings.

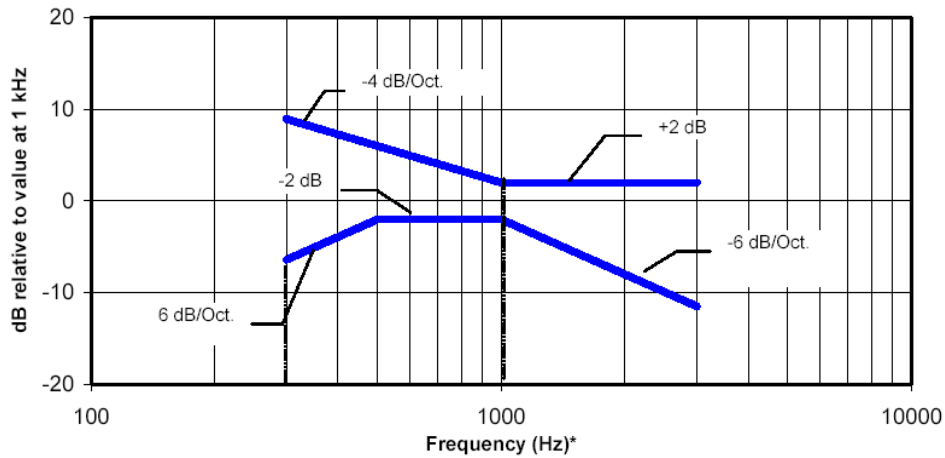

NOTE—Frequency response is between 300 Hz and 3000 Hz.

Figure 7.1—Magnetic field frequency response for WDs with a field ≤ -15 dB (A/m) at 1 kHz

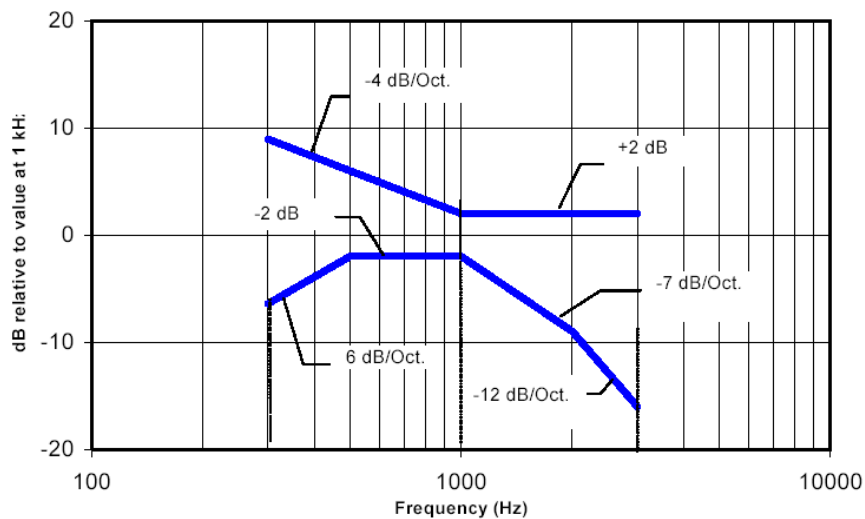

NOTE—Frequency response is between 300 Hz and 3000 Hz.

Figure 7.2—Magnetic field frequency response for WDs with a field that exceeds -15 dB(A/m) at 1 kHz

10.2. SIGNAL QUALITY

This provides the signal quality requirement for the intended T-Coil signal from a WD. Only the RF immunity of the hearing aid is measured in T-Coil mode. It is assumed that a hearing aid can have no immunity to an interference signal in the audio band, which is the intended reception band for this mode. So, the only criteria that can be measured is the RF immunity in T-Coil mode. This is measured using the same procedure as for the audio coupling mode and at the same levels.

The worst signal quality of the three T-Coil signal measurements, as determined in Clause 6, shall be used to determine the T-Coil mode category per Table 7.7.

Table 7.7—T-Coil signal quality categories

Category	Telephone parameters WD signal quality [(signal + noise)-to-noise ratio in decibels]
Category T1	0 dB to 10 dB
Category T2	10 dB to 20 dB
Category T3	20 dB to 30 dB
Category T4	> 30 dB

11. ATTACHMENTS

<u>No.</u>	<u>Contents</u>	<u>No. of page (s)</u>
1	Calibration Certificate of AM1DV3 SN:3083	3