

MEASUREMENT REPORT FCC PART 15.247 Bluetooth

Applicant Name:
Apple Inc.
1 Infinite Loop
Cupertino, CA 95014
United States

Date of Testing:
6/9-8/9/2017
Test Site/Location:
PCTEST Lab., Morgan Hill, CA, USA
Test Report Serial No.:
1C1706160002-58-04-R3.BCG

FCC ID: BCG-A1858

APPLICANT: Apple Inc.

Application Type: Certification
Model: A1858, A1959
EUT Type: Watch
Max. RF Output Power: 90.157 mW (19.55 dBm) Peak Conducted
Frequency Range: 2402 – 2480MHz (Bluetooth for US)
Type of Modulation: GFSK, $\pi/4$ -DQPSK, 8DPSK
FCC Classification: FCC Part 15 Spread Spectrum Transmitter (DSS)
FCC Rule Part(s): Part 15 Subpart C (15.247)
Test Procedure(s): ANSI C63.10-2013, KDB 648474 D03 v01r04,
KDB 414788 D01 Radiated Test Site v01

This equipment has been shown to be capable of compliance with the applicable technical standards as indicated in the measurement report and was tested in accordance with the measurement procedures specified in ANSI C63.10-2013. Test results reported herein relate only to the item(s) tested.

This revised Test Report (S/N: 1C1706160002-58-04-R3.BCG) supersedes and replaces the previously issued test report (S/N: 1C1706160002-58-04-R2.BCG) on the same subject device for the same type of testing as indicated. Please discard or destroy the previously issued test report(s) and dispose of it accordingly.

I attest to the accuracy of data. All measurements reported herein were performed by me or were made under my supervision and are correct to the best of my knowledge and belief. I assume full responsibility for the completeness of these measurements and vouch for the qualifications of all persons taking them.

Randy Ortanez
President





FCC ID: BCG-A1858		FCC Pt. 15.247 BLUETOOTH TEST REPORT (CERTIFICATION)	Approved by: Quality Manager
Test Report S/N: 1C1706160002-58-04-R3.BCG	Test Dates: 6/9-8/9/2017	EUT Type: Watch	Page 1 of 80

TABLE OF CONTENTS

	FCC PART 15.247 MEASUREMENT REPORT	3
1.0	INTRODUCTION.....	4
1.1	Scope	4
1.2	PCTEST Test Location.....	4
2.0	PRODUCT INFORMATION	5
2.1	Equipment Description	5
2.2	Device Capabilities.....	5
2.3	Antenna Description	5
2.4	Test Support Equipment.....	6
2.5	Test Configuration	6
2.6	Software and Firmware	7
2.7	EMI Suppression Device(s)/Modifications	7
3.0	DESCRIPTION OF TESTS.....	8
3.1	Evaluation Procedure	8
3.2	AC Line Conducted Emissions.....	8
3.3	Radiated Emissions.....	9
3.4	Environmental Conditions	9
4.0	ANTENNA REQUIREMENTS.....	10
5.0	MEASUREMENT UNCERTAINTY	11
6.0	TEST EQUIPMENT CALIBRATION DATA.....	12
7.0	TEST RESULTS	13
7.1	Summary.....	13
7.2	20dB Bandwidth Measurement	14
7.3	Output Power Measurement	22
7.3.1	Peak Output Power Measurement	24
7.3.2	Average Output Power Measurement	25
7.4	Band Edge Compliance.....	32
7.5	Carrier Frequency Separation	41
7.6	Time of Occupancy	44
7.7	Number of Hopping Channels	47
7.8	Conducted Spurious Emissions.....	50
7.9	Radiated Spurious Emission Measurements – Above 1GHz	57
7.10	Radiated Restricted Band Edge Measurements.....	64
7.11	Radiated Spurious Emissions Measurements – Below 1GHz	72
7.12	Line Conducted Measurement Data.....	76
8.0	CONCLUSION	80

FCC ID: BCG-A1858	 <small>ENGINEERING LABORATORY, INC.</small>	FCC Pt. 15.247 BLUETOOTH TEST REPORT (CERTIFICATION)	Approved by: Quality Manager
Test Report S/N: 1C1706160002-58-04-R3.BCG	Test Dates: 6/9-8/9/2017	EUT Type: Watch	Page 2 of 80

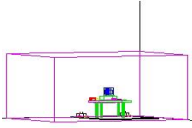

MEASUREMENT REPORT

FCC Part 15.247

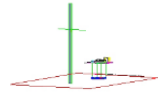

§ 2.1033 General Information

APPLICANT: Apple Inc.
APPLICANT ADDRESS: 1 Infinite Loop
 Cupertino, CA 95014, United States
TEST SITE: PCTEST ENGINEERING LABORATORY, INC.
TEST SITE ADDRESS: 7185 Oakland Mills Road, Columbia, MD 21046 USA
FCC RULE PART(S): Part 15 Subpart C (15.247)
BASE MODEL: A1858, A1959
FCC ID: BCG-A1858
FCC CLASSIFICATION: FCC Part 15 Spread Spectrum Transmitter (DSS)
Test Device Serial No.: FH7TX0HAJ880, Production Pre-Production Engineering
 FH7V100FJ87X
Method/System: Frequency Hopping Spread Spectrum (FHSS)
DATE(S) OF TEST: 6/9-8/9/2017
TEST REPORT S/N: 1C1706160002-58-04-R3.BCG

Test Facility / Accreditations

Measurements were performed at PCTEST Engineering Lab located in Morgan Hill, CA 95037, U.S.A.

- PCTEST is an ISO 17025-2005 accredited test facility under the American Association for Laboratory Accreditation (A2LA) with Certificate number 2041.02 for Specific Absorption Rate (SAR), Hearing Aid Compatibility (HAC) testing, where applicable, and Electromagnetic Compatibility (EMC) testing for FCC and Innovation, Science, and Economic Development Canada rules.
- PCTEST TCB is a Telecommunication Certification Body (TCB) accredited to ISO/IEC 17065-2012 by A2LA (Certificate number 2041.03) in all scopes of FCC Rules and ISED Standards (RSS).
- PCTEST facility is a registered (22831) test laboratory with the site description on file with ISED.

FCC ID: BCG-A1858		FCC Pt. 15.247 BLUETOOTH TEST REPORT (CERTIFICATION)	Approved by: Quality Manager
Test Report S/N: 1C1706160002-58-04-R3.BCG	Test Dates: 6/9-8/9/2017	EUT Type: Watch	Page 3 of 80

1.0 INTRODUCTION

1.1 Scope

Measurement and determination of electromagnetic emissions (EMC) of radio frequency devices including intentional and/or unintentional radiators for compliance with the technical rules and regulations of the Federal Communications Commission and the Innovation, Science, and Economic Development Canada.

1.2 PCTEST Test Location

These measurement tests were conducted at the PCTEST Engineering Laboratory, Inc. facility located at 18855 Adams Court, Morgan Hill, CA 95037.

FCC ID: BCG-A1858		FCC Pt. 15.247 BLUETOOTH TEST REPORT (CERTIFICATION)	Approved by: Quality Manager
Test Report S/N: 1C1706160002-58-04-R3.BCG	Test Dates: 6/9-8/9/2017	EUT Type: Watch	Page 4 of 80

2.0 PRODUCT INFORMATION

2.1 Equipment Description

The Equipment Under Test (EUT) is the **Apple Watch FCC ID: BCG-A1858**. The test data contained in this report pertains only to the emissions due to the EUT's Bluetooth transmitter.

- This Bluetooth module has been tested by a Bluetooth Qualification Lab, and we confirm the following:
 - A) The hopping sequence is pseudorandom
 - B) All channels are used equally on average
 - C) The receiver input bandwidth equals the transmit bandwidth
 - D) The receiver hops in sequence with the transmit signal
- 15.247(g): In accordance with the Bluetooth Industry Standard, the system is designed to comply with all of the regulations in Section 15.247 when the transmitter is presented with a continuous data (or information) system.
- 15.247(h): In accordance with the Bluetooth Industry Standard, the system does not coordinate its channels selection/hopping sequence with other frequency hopping systems for the express purpose of avoiding the simultaneous occupancy of individual hopping frequencies by multiple transmitters.
- 15.247(h): The EUT employs Adaptive Frequency Hopping (AFH) which identifies sources of interference namely devices operating in 802.11 WLAN and excludes them from the list of available channels. The process of re-mapping reduces the number of test channels from 79 channels to a minimum number of 20 channels.
- The EUT operates in two power schemes per modulation. The power schemes are Internal Pre Amplifier(iPA) and External Pre Amplifier (ePA).
- According to the manufacturer, models A1858 and A1959 are electrically identical. Model A1858 was used for final testing.

2.2 Device Capabilities

This device contains the following capabilities:

802.11b/g/n WLAN, Bluetooth (1x, EDR, LE), NFC

Note: This device is capable of operating in hopping and non-hopping mode. The EUT can hop between 79 different channels in the 2400 – 2483.5MHz band.

2.3 Antenna Description

Following antenna was used for the testing.

Frequency (GHz)	Antenna Gain (dBi)
2.4	-13.39

Table 2-1. Antenna Peak Gain

FCC ID: BCG-A1858		FCC Pt. 15.247 BLUETOOTH TEST REPORT (CERTIFICATION)	Approved by: Quality Manager
Test Report S/N: 1C1706160002-58-04-R3.BCG	Test Dates: 6/9-8/9/2017	EUT Type: Watch	Page 5 of 80

2.4 Test Support Equipment

1	Apple MacBook	Model:	A1502	S/N:	C02NQ01YG465
	w/ AC/DC Adapter	Model:	A1435	S/N:	C04325505K1F288BG
2	Apple USB Cable	Model:	Kanzi	S/N:	20153D
	w/ Charging Dock	Model:	FAPS61	S/N:	6304000736
	w/ Dock	Model:	X241	S/N:	SJH3002AP2AS
3	USB Cable	Model:	N/A	S/N:	N/A
			Shielded USB Cable		
4	w/ AC Adapter	Model:	B353	S/N:	N/A
5	Test Pathfinder Board	Model:	X988	S/N:	FGH7648700BDHMV323
6	Wireless Charging Pad (WCP)	Model:	A1598	FCC ID:	BCGA1598

Table 2-2. Test Support Equipment Used

2.5 Test Configuration

The EUT was tested per the guidance of KDB 558074 D01 v04. ANSI C63.10-2013 was used to reference the appropriate EUT setup for radiated spurious emissions testing and AC line conducted testing. See Sections 3.2 for AC line conducted emissions test setups, 7.9 for radiated emissions test setups, and 7.2, 7.3, 7.4, 7.5, and 7.6 for antenna port conducted emissions test setups. Additional radiated spurious emissions measurements were performed with the EUT on a certified wireless charging pad (WCP) while operating under normal conditions in a simulated call or data transmission configuration. The worst case radiated emissions data is shown in this report.

The worst case configuration was investigated for all combinations of the three materials, aluminum, ceramic, and stainless steel, and various types of wristbands, metal and non-metal wristbands. The store display sample was investigated with the three types of EUTs. The EUT was also investigated with and without wireless charger.

The worst case configuration found was used for all testing. The worst case material was aluminum and the worst case accessory was metal wristband. But no significant difference was found between various types of wrist bands.

The emissions below 1GHz and above 18GHz were tested with the highest transmitting power channel and the worst case configuration.

The EUT was manipulated through three orthogonal planes of X-orientation (flatbed), Y-orientation (landscape), and Z-orientation (portrait) during the testing. Only the worst case emissions were reported in this test report. The worst orientation was found to be X-orientation (flatbed).

For AC line conducted and radiated test below 1GHz, following configuration were investigated and EUT powered by AC/DC was the worst case.

- EUT powered by AC/DC adaptor via USB cable with wireless charger
- EUT powered by host PC via USB cable with wireless charger

$\pi/4$ -DQPSK has been investigated and confirmed as not the worst case.

FCC ID: BCG-A1858		FCC Pt. 15.247 BLUETOOTH TEST REPORT (CERTIFICATION)	Approved by: Quality Manager
Test Report S/N: 1C1706160002-58-04-R3.BCG	Test Dates: 6/9-8/9/2017	EUT Type: Watch	Page 6 of 80

2.6 Software and Firmware

The test was conducted with firmware version 15R328 installed on the EUT.

For conducted spurious emissions, automated test software was used to measure emissions and capture the corresponding plots necessary to show compliance. The measurement software utilized is PCTEST "BT Auto," Version 3.3.

2.7 EMI Suppression Device(s)/Modifications

No EMI suppression device(s) were added and no modifications were made during testing.

FCC ID: BCG-A1858		FCC Pt. 15.247 BLUETOOTH TEST REPORT (CERTIFICATION)	Approved by: Quality Manager
Test Report S/N: 1C1706160002-58-04-R3.BCG	Test Dates: 6/9-8/9/2017	EUT Type: Watch	Page 7 of 80

3.0 DESCRIPTION OF TESTS

3.1 Evaluation Procedure

The measurement procedure described in the American National Standard of Procedures for Compliance Testing of Unlicensed Wireless Devices (ANSI C63.10-2013) was used in the measurement of the EUT.

Deviation from measurement procedure.....None

3.2 AC Line Conducted Emissions

The line-conducted facility is located inside a 7m x 3.66m x 2.7m shielded enclosure. The shielded enclosure is manufactured by AP Americas. The shielding effectiveness of the shielded room is in accordance with MIL-Std-285 or NSA 65-6. A 1m x 1.5m wooden table 80cm high is placed 40cm away from the vertical wall and 80cm away from the sidewall of the shielded room. Two 10kHz-30MHz, 50Ω/50μH Line-Impedance Stabilization Networks (LISNs) are bonded to the shielded room floor. Power to the LISNs is filtered by external high-current high-insertion loss power line filters. The external power line filter is EPCOS 2X60A Power Line Filter (100dB Attenuation, 14kHz-18GHz) and the two EPCOs 2X48A filters (100dB Minimum Insertion Loss, 14kHz – 10GHz). These filters attenuate ambient signal noise from entering the measurement lines. These filters are also bonded to the shielded enclosure.

The EUT is powered from one LISN and the support equipment is powered from the second LISN. If the EUT is a DC-powered device, power will be derived from the source power supply it normally will be powered from and this supply line(s) will be connected to the second LISN. All interconnecting cables more than 1 meter were shortened to a 1 meter length by non-inductive bundling (serpentine fashion) and draped over the back edge of the test table. All cables were at least 40cm above the horizontal reference groundplane. Power cables for support equipment were routed down to the second LISN while ensuring that that cables were not draped over the second LISN.

Sufficient time for the EUT, support equipment, and test equipment was allowed in order for them to warm up to their normal operating condition. The RF output of the LISN was connected to the spectrum analyzer and exploratory measurements were made to determine the frequencies producing the maximum emission from the EUT. The spectrum was scanned from 150kHz to 30MHz with a spectrum analyzer. The detector function was set to peak mode for exploratory measurements while the bandwidth of the analyzer was set to 10kHz. The EUT, support equipment, and interconnecting cables were arranged and manipulated to maximize each emission. Once the worst case emissions have been identified, the one EUT cable configuration/arrangement and mode of operation that produced these emissions is used for final measurements on the same test site. The analyzer is set to CISPR quasi-peak and average detectors with a 9kHz resolution bandwidth for final measurements.

Line conducted emissions test results are shown in Section 7.12. Automated test software was used to perform the AC line conducted emissions testing. Automated measurement software utilized is Rohde & Schwarz EMC32, Version 10.20.01.

FCC ID: BCG-A1858		FCC Pt. 15.247 BLUETOOTH TEST REPORT (CERTIFICATION)	Approved by: Quality Manager
Test Report S/N: 1C1706160002-58-04-R3.BCG	Test Dates: 6/9-8/9/2017	EUT Type: Watch	Page 8 of 80

3.3 Radiated Emissions

The radiated test facilities consisted of an indoor 3 meter semi-anechoic chamber used for final measurements and exploratory measurements, when necessary. The measurement area is contained within the semi-anechoic chamber which is shielded from any ambient interference. The test site inside the chamber is a 6m x 5.2m elliptical, obstruction-free area in accordance with Figure 5.7 of Clause 5 in ANSI C63.4-2014. Absorbers are arranged on the floor between the turn table and the antenna mast in such a way so as to maximize the reduction of reflections for measurements above 1GHz. An 80cm high Styrodur Plastic Test Table is placed on top of the turntable. For measurements above 1GHz, another Styrodur Plastic Test Table of 70cm height is placed on top of the test table to bring the total table height to 1.5m.

For all measurements, the spectrum was scanned through all EUT azimuths and from 1 to 4 meter receive antenna height using a broadband antenna from 30MHz up to the upper frequency shown in 15.33(b)(1) depending on the highest frequency generated or used in the device or on which the device operates or tunes. For frequencies above 1GHz, linearly polarized double ridge horn antennas were used. For frequencies below 30MHz, a calibrated loop antenna was used. When exploratory measurements were necessary, they were performed at 1 meter test distance inside the semi-anechoic chamber using broadband antennas, broadband amplifiers, and spectrum analyzers to determine the frequencies and modes producing the maximum emissions. Sufficient time for the EUT, support equipment, and test equipment was allowed in order for them to warm up to their normal operating condition. The test set-up was placed on top of the 1 x 1.5 meter table. The EUT, support equipment, and interconnecting cables were arranged and manipulated to maximize each emission. Appropriate precaution was taken to ensure that all emissions from the EUT were maximized and investigated. The system configuration, mode of operation, turntable azimuth, and receive antenna height was noted for each frequency found.

Final measurements were made in the semi-anechoic chamber using calibrated, linearly polarized broadband and horn antennas. The test setup was configured to the setup that produced the worst case emissions. The spectrum analyzer was set to investigate all frequencies required for testing to compare the highest radiated disturbances with respect to the specified limits. The turntable containing the EUT was rotated through 360 degrees and the height of the receive antenna was varied 1 to 4 meters and stopped at the azimuth and height producing the maximum emission. Each emission was maximized by changing the orientation of the EUT through three orthogonal planes and changing the polarity of the receive antenna, whichever produced the worst-case emissions.

3.4 Environmental Conditions

The temperature is controlled within range of 15°C to 35°C. The relative humidity is controlled within range of 10% to 75%. The atmospheric pressure is monitored within the range 86-106kPa (860-1060mbar).

FCC ID: BCG-A1858		FCC Pt. 15.247 BLUETOOTH TEST REPORT (CERTIFICATION)	Approved by: Quality Manager
Test Report S/N: 1C1706160002-58-04-R3.BCG	Test Dates: 6/9-8/9/2017	EUT Type: Watch	Page 9 of 80

4.0 ANTENNA REQUIREMENTS

Excerpt from §15.203 of the FCC Rules/Regulations:

“An intentional radiator antenna shall be designed to ensure that no antenna other than that furnished by the responsible party can be used with the device. The use of a permanently attached antenna or of an antenna that uses a unique coupling to the intentional radiator shall be considered sufficient to comply with the provisions of this section.”

- The antennas of the EUT are **permanently attached**.
- There are no provisions for connection to an external antenna.

Conclusion:

The EUT complies with the requirement of §15.203.

FCC ID: BCG-A1858		FCC Pt. 15.247 BLUETOOTH TEST REPORT (CERTIFICATION)	Approved by: Quality Manager
Test Report S/N: 1C1706160002-58-04-R3.BCG	Test Dates: 6/9-8/9/2017	EUT Type: Watch	Page 10 of 80

5.0 MEASUREMENT UNCERTAINTY

The measurement uncertainties shown below were calculated in accordance with the requirements of ANSI C63.10-2013. All measurement uncertainty values are shown with a coverage factor of $k = 2$ to indicate a 95% level of confidence. The measurement uncertainty shown below meets or exceeds the U_{CISPR} measurement uncertainty values specified in CISPR 16-4-2 and, thus, can be compared directly to specified limits to determine compliance.

Contribution	Expanded Uncertainty (\pm dB)
Conducted Bench Top Measurements	1.13
Conducted Disturbance	3.09
Radiated Disturbance (<1GHz)	4.98
Radiated Disturbance (>1GHz)	5.07
Radiated Disturbance (>18GHz)	5.09

FCC ID: BCG-A1858		FCC Pt. 15.247 BLUETOOTH TEST REPORT (CERTIFICATION)	Approved by: Quality Manager
Test Report S/N: 1C1706160002-58-04-R3.BCG	Test Dates: 6/9-8/9/2017	EUT Type: Watch	Page 11 of 80

6.0 TEST EQUIPMENT CALIBRATION DATA

Test Equipment Calibration is traceable to the National Institute of Standards and Technology (NIST). Measurements antennas used during testing were calibrated in accordance to the requirements of ANSI C63.5-2006.

Manufacturer	Model	Description	Cal Date	Cal Interval	Cal Due	Serial Number
-	ACL C Conducted	ACL C Emissions Cable Set	3/17/2017	Biennial	10/1/2017	CAACL C1
-	AM WN25	WLAN Cable Set	3/17/2017	Annual	3/17/2018	AM WN25
-	EMI 3117-ESW1	Radiated Cable Set	3/1/2017	Biennial	3/1/2018	N/A
-	EMI HL562E-ESW1	Radiated Cable Set	2/28/2017	Biennial	2/28/2018	N/A
Anritsu	MA2411B	Pulse Power Sensor	10/14/2015	Biennial	10/14/2017	1027293
Anritsu	ML2495A	Power Meter	10/16/2015	Biennial	10/16/2017	1039008
Rohde & Schwarz	180-442AKF	20dB Nominal Gain Horn Antenna	2/24/2017	Annual	2/24/2018	T058701-03
COM-POWER	LIN-120A	LISN	2/22/2017	Annual	2/22/2018	241296
Keysight Technologies	N9030A	3Hz-44Ghz PXA Signal Analyzer	3/13/2017	Annual	3/13/2018	MY49430244
Rohde & Schwarz	ERTS.2	Loop Antenna Cable Set	3/17/2017	Biennial	3/17/2018	AM Loop1
Rohde & Schwarz	ESW26	ESW26 EMI Test Receiver	1/20/2017	Annual	1/20/2018	101299
Rohde & Schwarz	FSV40	Signal Analyzer	12/23/2016	Annual	12/23/2017	101619
Rohde & Schwarz	HL562E	Bi-Log Antenna	1/19/2017	Annual	1/19/2018	100610
Rohde & Schwarz	OSP130	Open Switch and Control Unit	1/18/2017	Annual	1/18/2018	100970
Rohde & Schwarz	SFUNIT-RX	TS-SFUNIT SHIELDED FILTER UNIT	2/3/2017	Annual	2/3/2018	102131
Rohde & Schwarz	TS-PR18	Pre-Amplifier (1GHz - 18GHz)	2/3/2017	Annual	2/3/2018	101639
Rohde & Schwarz	TS-PR1840	Pre-Amplifier (18GHz - 40GHz)	2/3/2017	Annual	2/3/2018	100052
Rohde & Schwarz	TS-PR8	Pre-amplifier (30MHz - 8GHz)	2/3/2017	Annual	2/3/2018	102325
Rohde & Schwarz	TC-TA18	CROSS POL. VIVALDI ANT	11/8/2016	Annual	11/8/2017	101056-AE
UTIFlex	TS9975/FSC40	40GHz Micro Coax Cable	4/1/2017	Biennial	10/1/2017	200200

Table 6-1. Annual Test Equipment Calibration Schedule

FCC ID: BCG-A1858		FCC Pt. 15.247 BLUETOOTH TEST REPORT (CERTIFICATION)	Approved by: Quality Manager
Test Report S/N: 1C1706160002-58-04-R3.BCG	Test Dates: 6/9-8/9/2017	EUT Type: Watch	Page 12 of 80

7.0 TEST RESULTS

7.1 Summary

Company Name: Apple Inc.
 FCC ID: BCG-A1858
 Method/System: Frequency Hopping Spread Spectrum (FHSS)
 Number of Channels: 79

FCC Part Section(s)	Test Description	Test Limit	Test Condition	Test Result	Reference
15.247(a)(1)(iii)	20dB Bandwidth	N/A	CONDUCTED	PASS	Section 7.2
15.247(b)(1)	Peak Transmitter Output Power	< 1 Watt if ≥ 75 non-overlapping channels used		PASS	Section 7.3
15.247(a)(1)	Channel Separation	> 2/3 of 20 dB BW for systems with Output Power < 125mW		PASS	Section 7.5
15.247(a)(1)(iii)	Number of Channels	> 15 Channels		PASS	Section 7.7
15.247(a)(1)(iii)	Time of Occupancy	< 0.4 sec in 31.6 sec period		PASS	Section 7.6
15.247(d)	Band Edge / Out-of-Band Emissions	Conducted > 20dBc		PASS	Section 7.4, Section 7.8
15.205 15.209	General Field Strength Limits (Restricted Bands and Radiated Emission Limits)	Emissions in restricted bands must meet the radiated limits detailed in 15.209	RADIATED	PASS	Section 7.9, Section 7.10, Section 7.11
15.207	AC Conducted Emissions 150kHz – 30MHz	< FCC 15.207 limits	LINE CONDUCTED	PASS	Section 7.12

Table 7-1. Summary of Test Results

Notes:

- 1) All modes of operation and data rates were investigated. The test results shown in the following sections represent the worst case emissions.
- 2) The analyzer plots shown in this section were all taken with a correction table loaded into the analyzer. The correction table was used to account for the losses of the cables, directional couplers, and attenuators used as part of the system to maintain a link between the call box and the EUT at all frequencies of interest.
- 3) All antenna port conducted emissions testing was performed on a test bench with the antenna port of the EUT connected to the spectrum analyzer through calibrated cables, attenuators, and couplers.
- 4) For conducted spurious emissions, automated test software was used to measure emissions and capture the corresponding plots necessary to show compliance. The measurement software utilized is PCTEST "BT Auto," Version 3.3.

FCC ID: BCG-A1858		FCC Pt. 15.247 BLUETOOTH TEST REPORT (CERTIFICATION)		Approved by: Quality Manager
Test Report S/N: 1C1706160002-58-04-R3.BCG	Test Dates: 6/9-8/9/2017	EUT Type: Watch		Page 13 of 80

7.2 20dB Bandwidth Measurement

§15.247 (a.1.iii)

Test Overview and Limit

The bandwidth at 20dB down from the highest in-band spectral density is measured with a spectrum analyzer connected to the receive antenna while the EUT is operating in transmission mode at the appropriate frequencies.

Test Procedure Used

ANSI C63.10-2013 – Section 6.9.2

Test Settings

1. The signal analyzers' automatic bandwidth measurement capability of the spectrum analyzer was used to perform the 20dB bandwidth measurement. The "X" dB bandwidth parameter was set to $X = 20$. The bandwidth measurement was not influenced by any intermediate power nulls in the fundamental emission.
2. $RBW = 1 - 5\% OBW$
3. $VBW \geq 3 \times RBW$
4. Reference level set to keep signal from exceeding maximum input mixer level for linear operation.
5. Detector = Peak
6. Trace mode = max hold
7. Sweep = auto couple
8. The trace was allowed to stabilize

Test Setup

The EUT and measurement equipment were set up as shown in the diagram below.



Figure 7-1. Test Instrument & Measurement Setup

Test Notes

None

FCC ID: BCG-A1858		FCC Pt. 15.247 BLUETOOTH TEST REPORT (CERTIFICATION)	Approved by: Quality Manager
Test Report S/N: 1C1706160002-58-04-R3.BCG	Test Dates: 6/9-8/9/2017	EUT Type: Watch	Page 14 of 80

Frequency [MHz]	Modulation	Power Scheme	Channel No.	20dB Bandwidth Test Results	
				Measured Bandwidth [kHz]	Pass/Fail
2402	GFSK	ePA	0	947.30	Pass
2441	GFSK	ePA	39	946.30	Pass
2480	GFSK	ePA	78	947.00	Pass
2402	GFSK	iPA	0	947.10	Pass
2441	GFSK	iPA	39	946.40	Pass
2480	GFSK	iPA	78	946.30	Pass
2402	8DPSK	ePA	0	1355.00	Pass
2441	8DPSK	ePA	39	1351.00	Pass
2480	8DPSK	ePA	78	1351.00	Pass
2402	8DPSK	iPA	0	1356.00	Pass
2441	8DPSK	iPA	39	1357.00	Pass
2480	8DPSK	iPA	78	1356.00	Pass

Table 7-2. Conducted 20dB Bandwidth Measurements

FCC ID: BCG-A1858		FCC Pt. 15.247 BLUETOOTH TEST REPORT (CERTIFICATION)		Approved by: Quality Manager
Test Report S/N: 1C1706160002-58-04-R3.BCG	Test Dates: 6/9-8/9/2017	EUT Type: Watch		Page 15 of 80

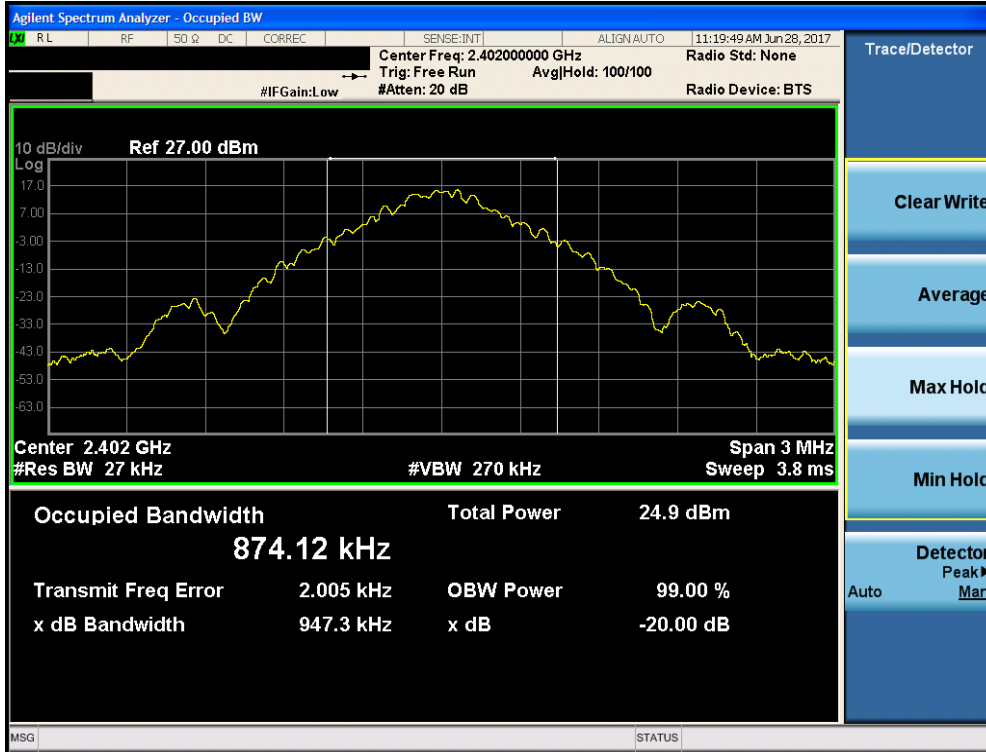

Plot 7-1. 20dB Bandwidth Plot (Bluetooth, GFSK, ePA – Ch. 0)

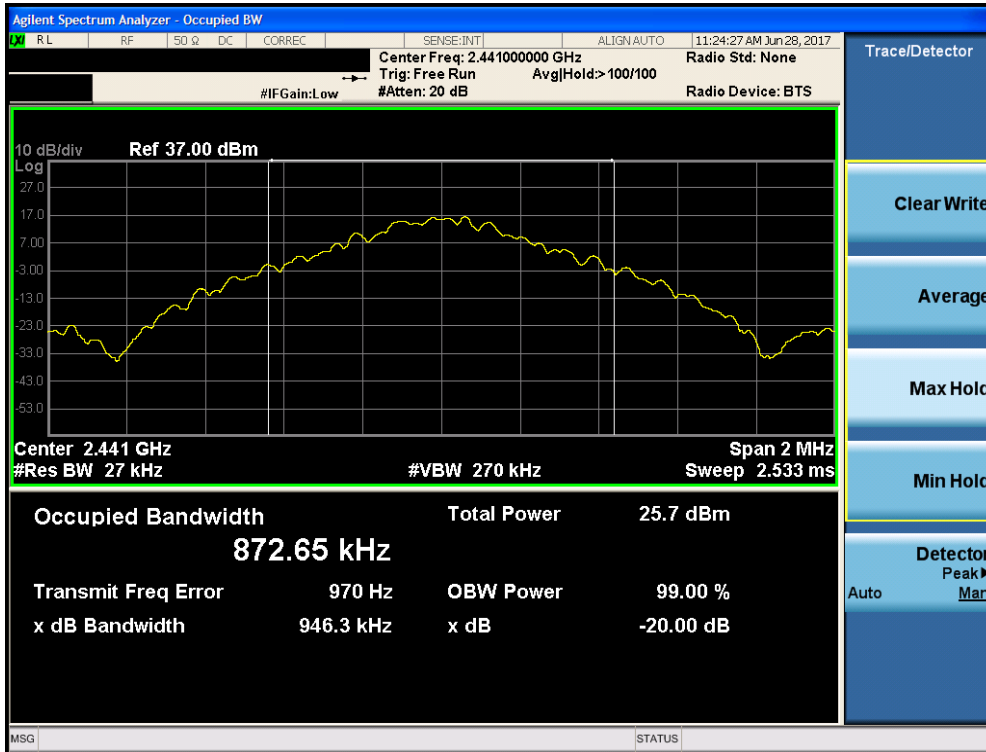

Plot 7-2. 20dB Bandwidth Plot (Bluetooth, GFSK, ePA – Ch. 39)

FCC ID: BCG-A1858		FCC Pt. 15.247 BLUETOOTH TEST REPORT (CERTIFICATION)	Approved by: Quality Manager
Test Report S/N: 1C1706160002-58-04-R3.BCG	Test Dates: 6/9-8/9/2017	EUT Type: Watch	Page 16 of 80

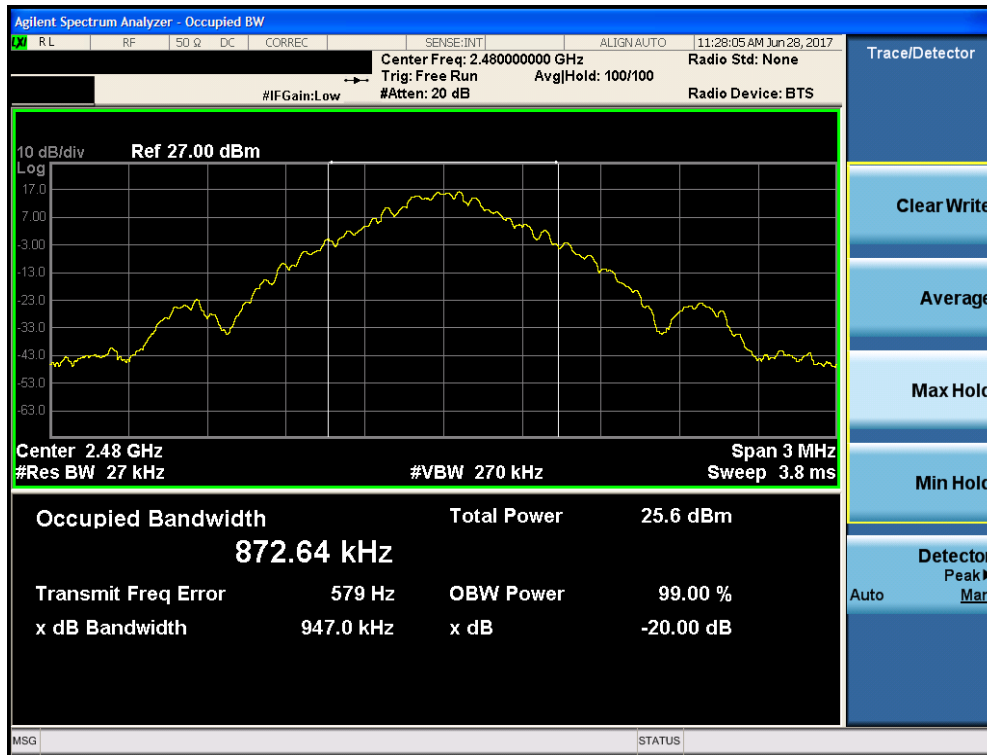

Plot 7-3. 20dB Bandwidth Plot (Bluetooth, GFSK, ePA – Ch. 78)

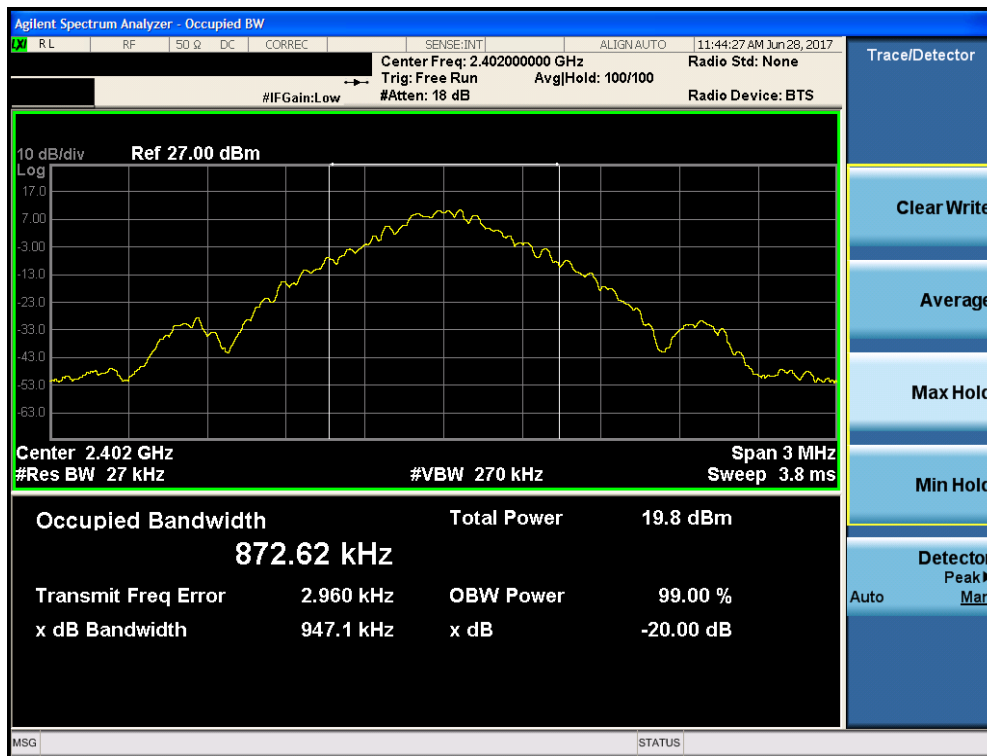

Plot 7-4. 20dB Bandwidth Plot (Bluetooth, GFSK, iPA – Ch. 0)

FCC ID: BCG-A1858		FCC Pt. 15.247 BLUETOOTH TEST REPORT (CERTIFICATION)	Approved by: Quality Manager
Test Report S/N: 1C1706160002-58-04-R3.BCG	Test Dates: 6/9-8/9/2017	EUT Type: Watch	Page 17 of 80

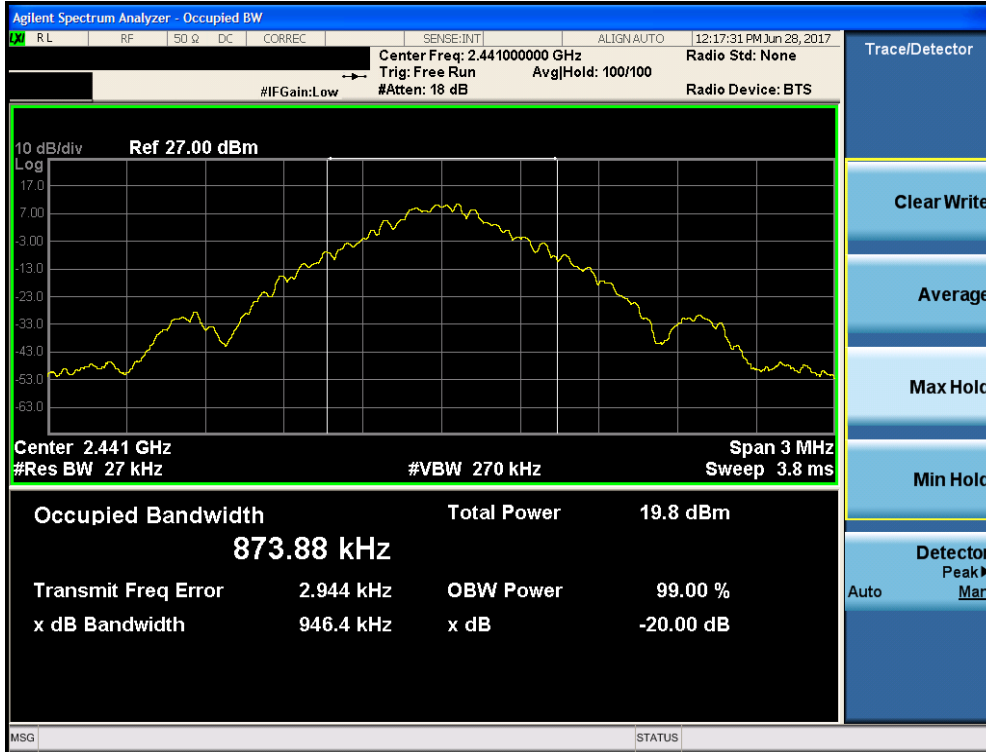

Plot 7-5. 20dB Bandwidth Plot (Bluetooth, GFSK, iPA – Ch. 39)

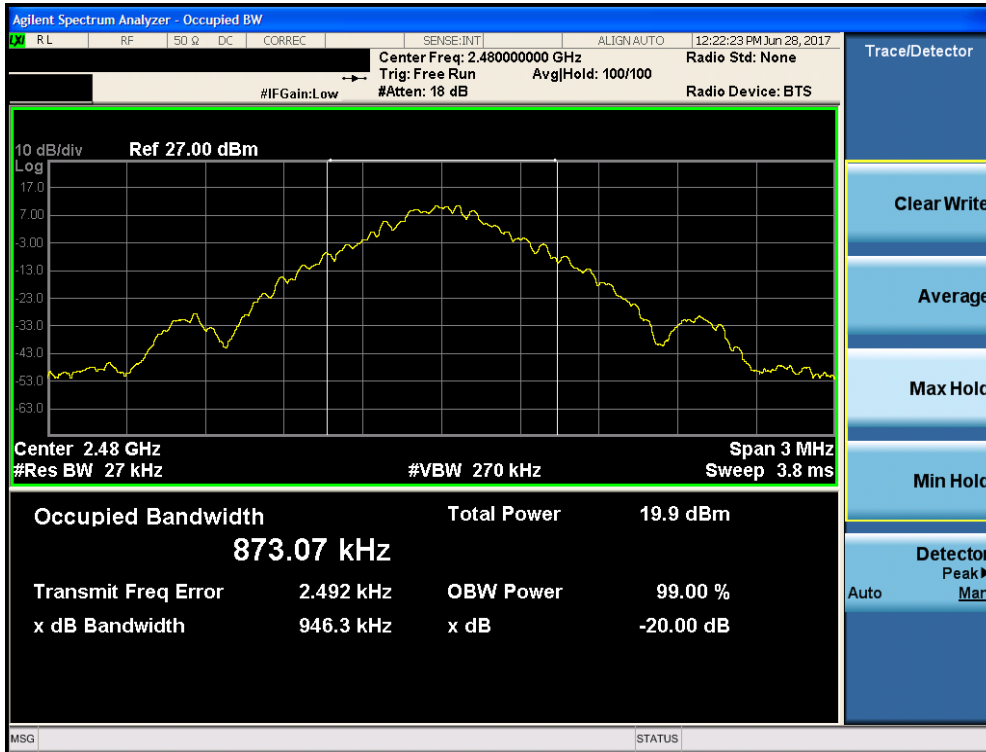

Plot 7-6. 20dB Bandwidth Plot (Bluetooth, GFSK, iPA – Ch. 78)

FCC ID: BCG-A1858		FCC Pt. 15.247 BLUETOOTH TEST REPORT (CERTIFICATION)	Approved by: Quality Manager
Test Report S/N: 1C1706160002-58-04-R3.BCG	Test Dates: 6/9-8/9/2017	EUT Type: Watch	Page 18 of 80

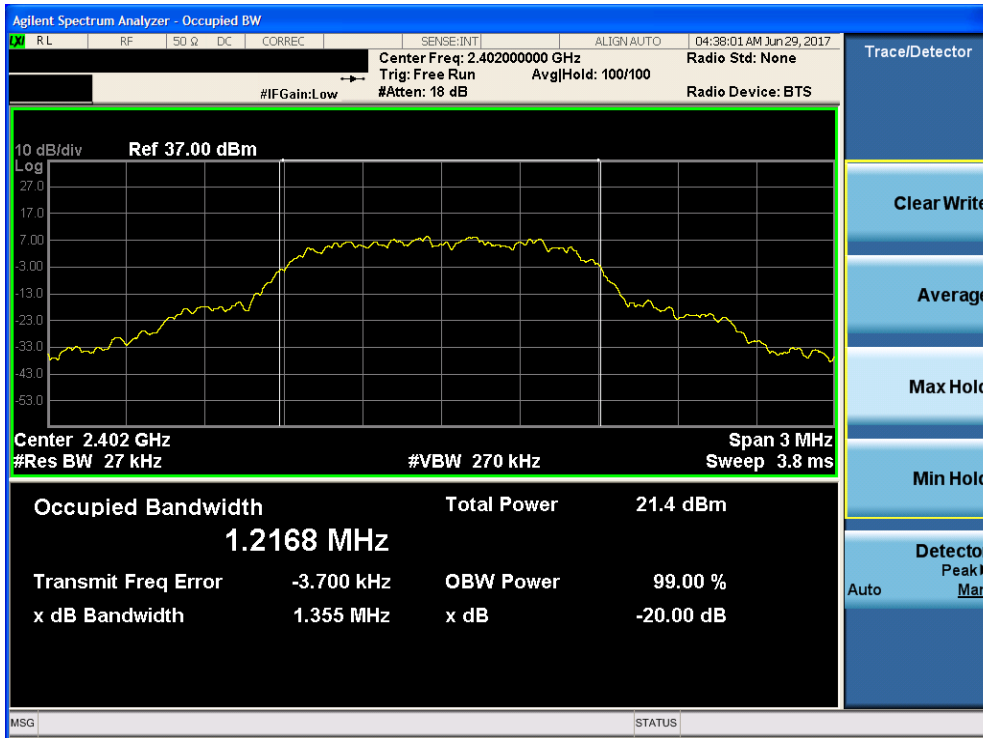

Plot 7-7. 20dB Bandwidth Plot (Bluetooth, 8DPSK, ePA – Ch. 0)

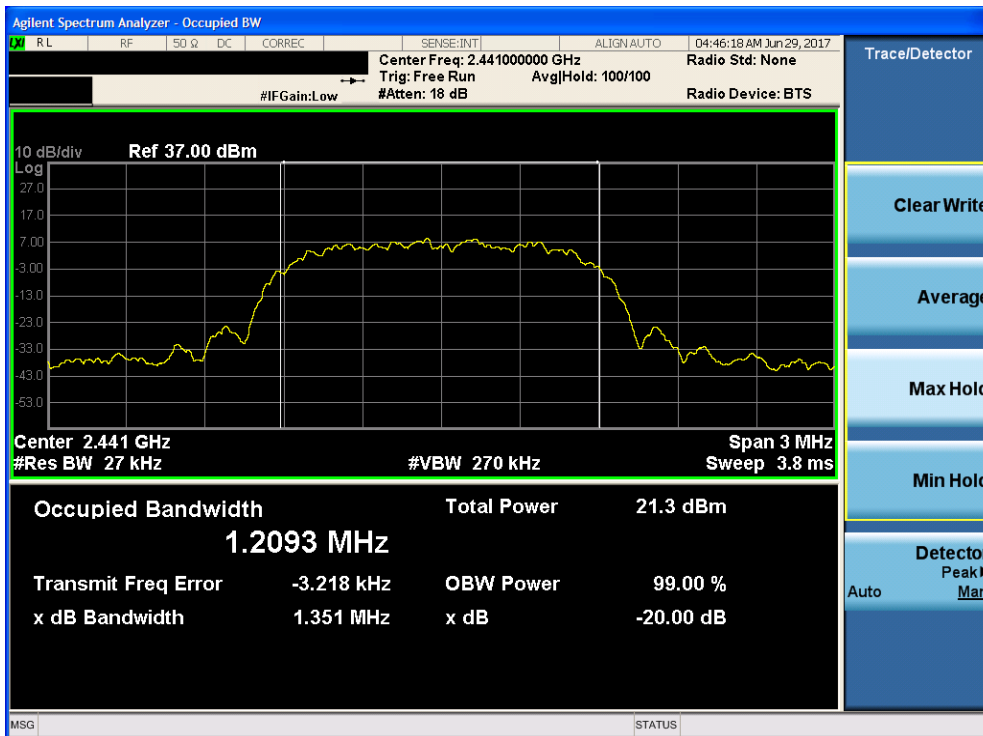

Plot 7-8. 20dB Bandwidth Plot (Bluetooth, 8DPSK, ePA – Ch. 39)

FCC ID: BCG-A1858		FCC Pt. 15.247 BLUETOOTH TEST REPORT (CERTIFICATION)	Approved by: Quality Manager
Test Report S/N: 1C1706160002-58-04-R3.BCG	Test Dates: 6/9-8/9/2017	EUT Type: Watch	Page 19 of 80

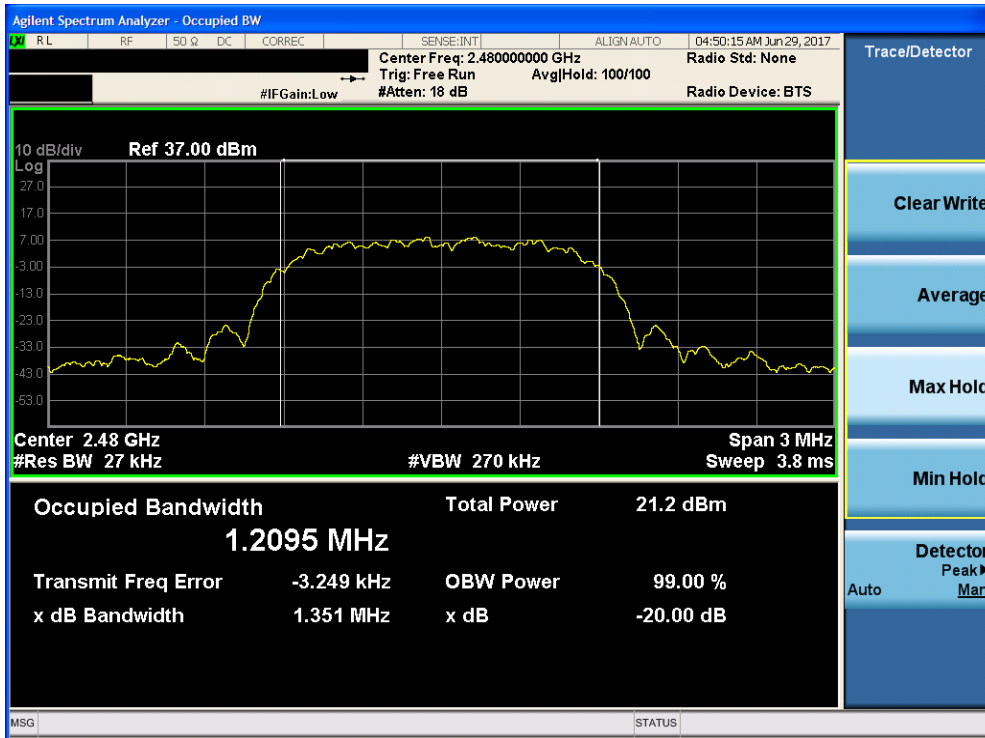

Plot 7-9. 20dB Bandwidth Plot (Bluetooth, 8DPSK, ePA – Ch. 78)

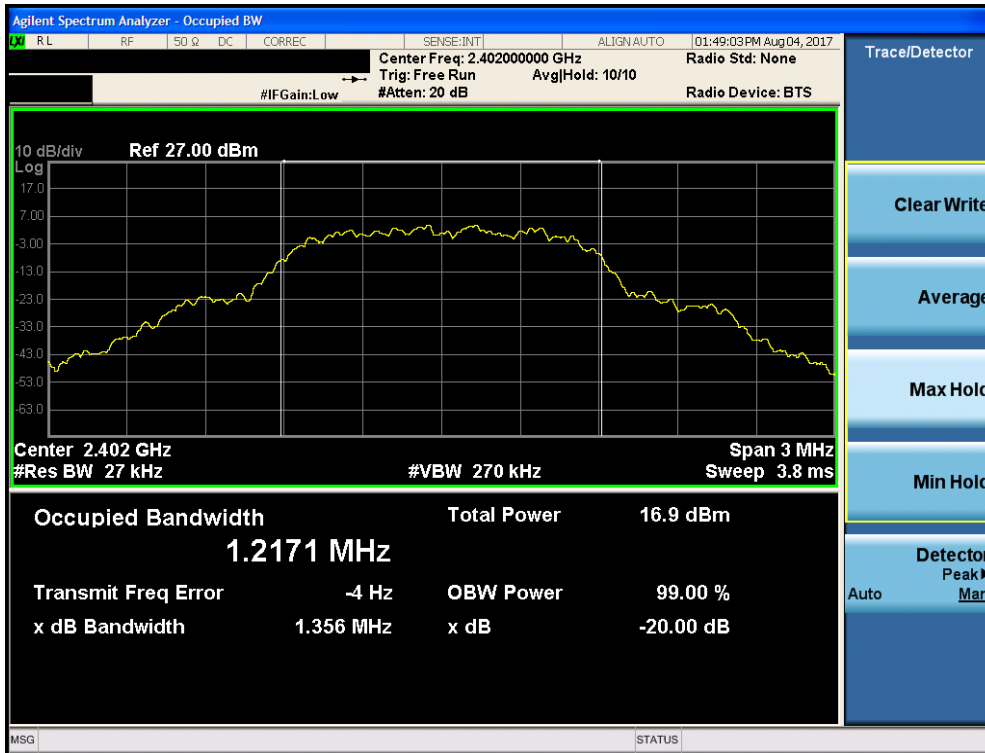

Plot 7-10. 20dB Bandwidth Plot (Bluetooth, 8DPSK, iPA – Ch. 0)

FCC ID: BCG-A1858		FCC Pt. 15.247 BLUETOOTH TEST REPORT (CERTIFICATION)	Approved by: Quality Manager
Test Report S/N: 1C1706160002-58-04-R3.BCG	Test Dates: 6/9-8/9/2017	EUT Type: Watch	Page 20 of 80

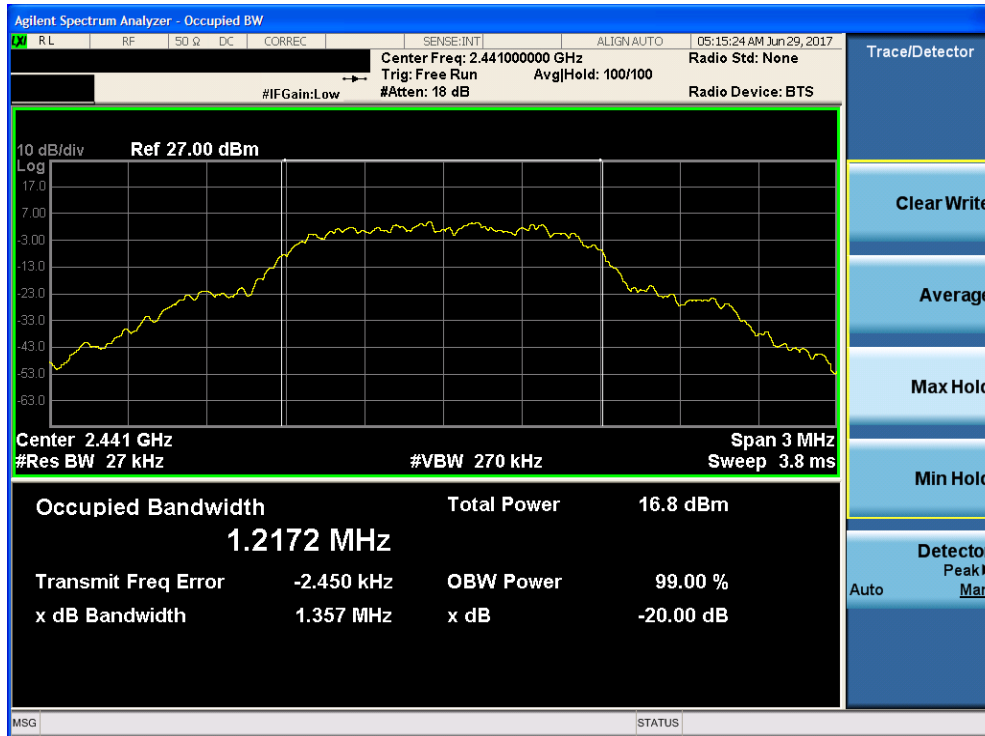

Plot 7-11. 20dB Bandwidth Plot (Bluetooth, 8DPSK, iPA – Ch. 39)



Plot 7-12. 20dB Bandwidth Plot (Bluetooth, 8DPSK, iPA – Ch. 78)

FCC ID: BCG-A1858		FCC Pt. 15.247 BLUETOOTH TEST REPORT (CERTIFICATION)	Approved by: Quality Manager
Test Report S/N: 1C1706160002-58-04-R3.BCG	Test Dates: 6/9-8/9/2017	EUT Type: Watch	Page 21 of 80

7.3 Output Power Measurement

§15.247 (b.1)

Test Overview and Limits

Measurement is made while the EUT is operating in non-hopping transmission mode. The powers shown below were measured using a spectrum analyzer with a Bluetooth signaling test set (Agilent Model: N4010A) used only to maintain a Bluetooth link with the EUT. Average power data is provided to determine the need for Bluetooth SAR testing according to KDB 447498 D01 v06. Average power measurements are performed using the analyzer's "burst power" function with RBW = 3MHz. The burst power function triggers on a single set burst set to maximum power and measures the maximum average power on the on-time.

The maximum permissible output power is 1 Watt.

Test Procedure Used

ANSI C63.10-2013 – Section 7.8.5

Test Settings

Peak Power Measurement

1. Span = approximately 5x 20dB bandwidth, centered on hopping channel
2. RBW > 20dB bandwidth of emission being measured
3. VBW ≥ RBW
4. Sweep = auto
5. Detector = peak
6. Trace mode = max hold
7. The trace was allowed to stabilize

Method AVGPM-G (Average Power Measurement)

Average power measurements were performed only when the EUT was transmitting at its maximum power control level using a broadband power meter with a pulse sensor. The power meter implemented triggering and gating capabilities which were set up such that power measurements were recorded only during the ON time of the transmitter. The trace was averaged over 100 traces to obtain the final measured average power.

FCC ID: BCG-A1858		FCC Pt. 15.247 BLUETOOTH TEST REPORT (CERTIFICATION)	Approved by: Quality Manager
Test Report S/N: 1C1706160002-58-04-R3.BCG	Test Dates: 6/9-8/9/2017	EUT Type: Watch	Page 22 of 80

Test Setup

The EUT and measurement equipment were set up as shown in the diagram below.



Figure 7-2. Test Instrument & Measurement Setup for Peak Power Measurement



Figure 7-3. Test Instrument & Measurement Setup for Average Power Measurement

Note

1. This unit was tested with all possible data rates and the highest peak power is reported with the unit transmitting at GFSK and 8DPSK.
2. The EUT was tested for the average power with a broadband power meter for reporting purposes only.

FCC ID: BCG-A1858	 FCC Pt. 15.247 BLUETOOTH TEST REPORT (CERTIFICATION)		Approved by: Quality Manager
Test Report S/N: 1C1706160002-58-04-R3.BCG	Test Dates: 6/9-8/9/2017	EUT Type: Watch	Page 23 of 80

7.3.1 Peak Output Power Measurement §15.247 (b.1)

Frequency [MHz]	Modulation	Power Scheme	Channel No.	Peak Conducted Power	
				[dBm]	[mW]
2402	GFSK	ePA	0	18.26	66.988
2441	GFSK	ePA	39	19.55	90.157
2480	GFSK	ePA	78	18.53	71.285
2402	GFSK	iPA	0	12.74	18.793
2441	GFSK	iPA	39	12.81	19.099
2480	GFSK	iPA	78	12.72	18.685
2402	8DPSK	ePA	0	17.00	50.119
2441	8DPSK	ePA	39	16.37	43.351
2480	8DPSK	ePA	78	16.20	41.687
2402	8DPSK	iPA	0	12.10	16.218
2441	8DPSK	iPA	39	12.32	17.061
2480	8DPSK	iPA	78	12.19	16.558

Table 7-3. Peak Conducted Output Power Measurements

FCC ID: BCG-A1858			FCC Pt. 15.247 BLUETOOTH TEST REPORT (CERTIFICATION)	Approved by: Quality Manager
Test Report S/N: 1C1706160002-58-04-R3.BCG	Test Dates: 6/9-8/9/2017	EUT Type: Watch		Page 24 of 80

7.3.2 Average Output Power Measurement §15.247 (b.1)

Frequency [MHz]	Modulation	Power Scheme	Channel No.	Ave Conducted Power	
				[dBm]	[mW]
2402	GFSK	ePA	0	18.22	66.374
2441	GFSK	ePA	39	18.87	77.090
2480	GFSK	ePA	78	18.61	72.611
2402	GFSK	iPA	0	12.46	17.620
2441	GFSK	iPA	39	12.74	18.793
2480	GFSK	iPA	78	12.64	18.365
2402	8DPSK	ePA	0	13.31	21.429
2441	8DPSK	ePA	39	13.50	22.387
2480	8DPSK	ePA	78	13.24	21.086
2402	8DPSK	iPA	0	8.71	7.430
2441	8DPSK	iPA	39	9.00	7.943
2480	8DPSK	iPA	78	8.67	7.362

Table 7-4. Average Conducted Output Power Measurements

FCC ID: BCG-A1858		FCC Pt. 15.247 BLUETOOTH TEST REPORT (CERTIFICATION)		Approved by: Quality Manager
Test Report S/N: 1C1706160002-58-04-R3.BCG	Test Dates: 6/9-8/9/2017	EUT Type: Watch		Page 25 of 80

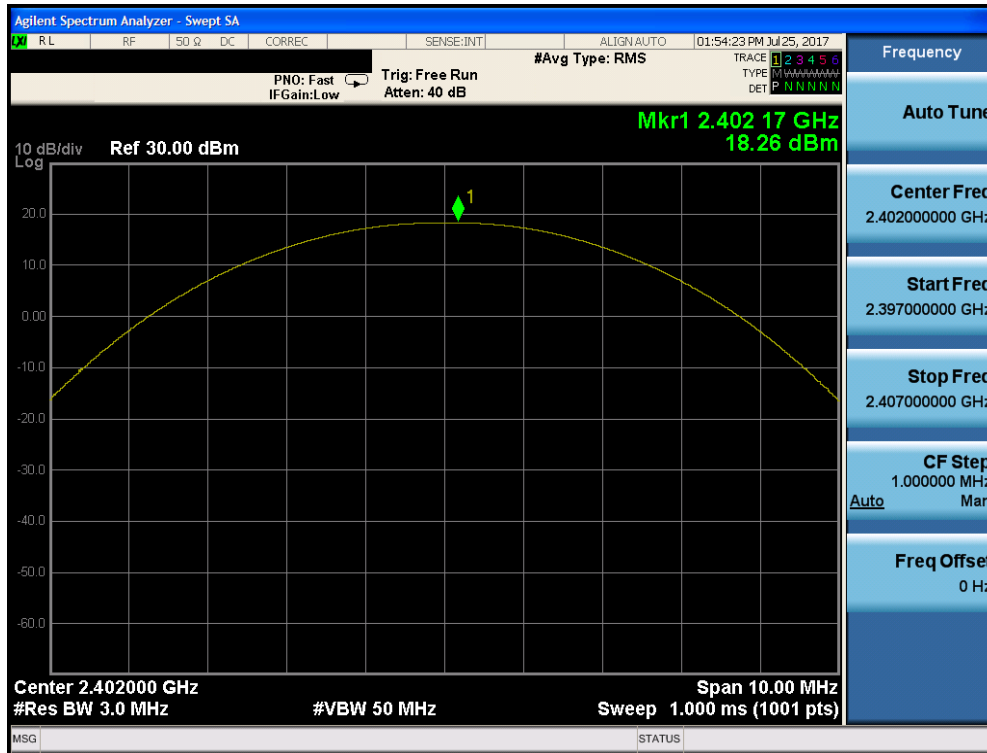

Plot 7-13. Peak Conducted Power (GFSK, ePA - Ch. 0)

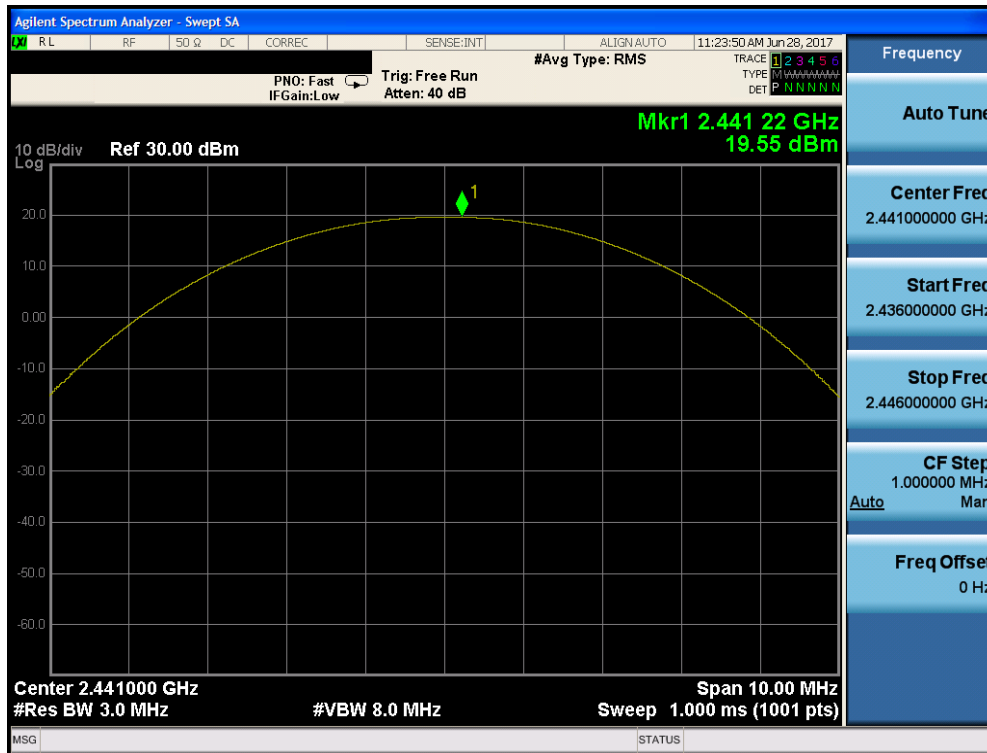

Plot 7-14. Peak Conducted Power (GFSK, ePA - Ch. 39)

FCC ID: BCG-A1858	PCTEST ENGINEERING LABORATORY, INC.	FCC Pt. 15.247 BLUETOOTH TEST REPORT (CERTIFICATION)	Approved by: Quality Manager
Test Report S/N: 1C1706160002-58-04-R3.BCG	Test Dates: 6/9-8/9/2017	EUT Type: Watch	Page 26 of 80

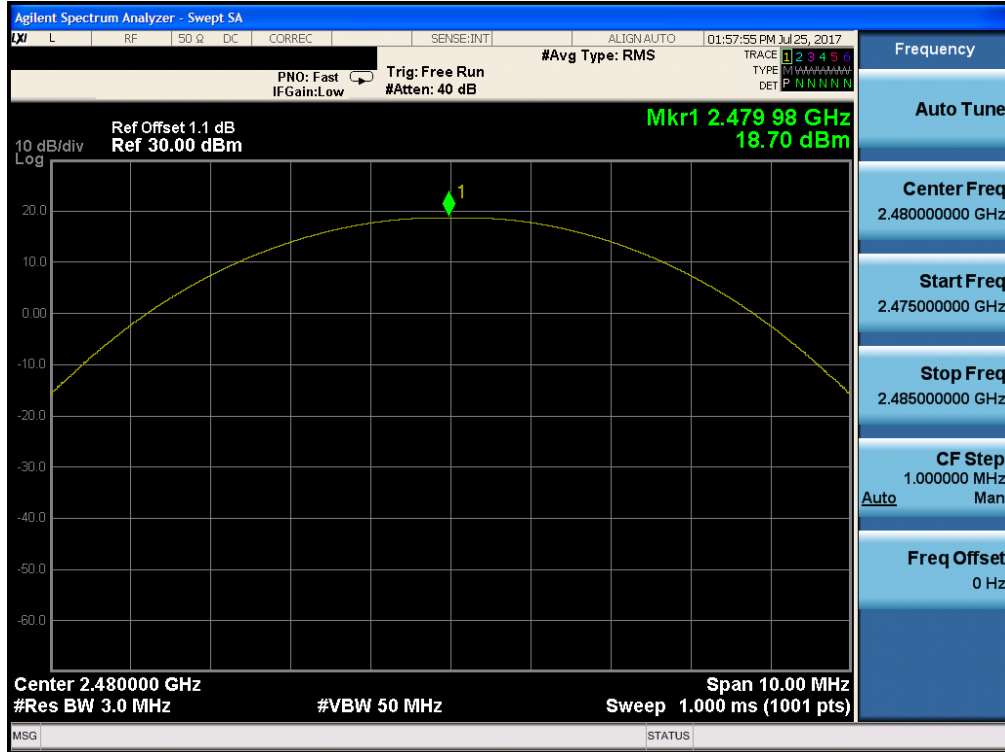

Plot 7-15. Peak Conducted Power (GFSK, ePA – Ch. 78)

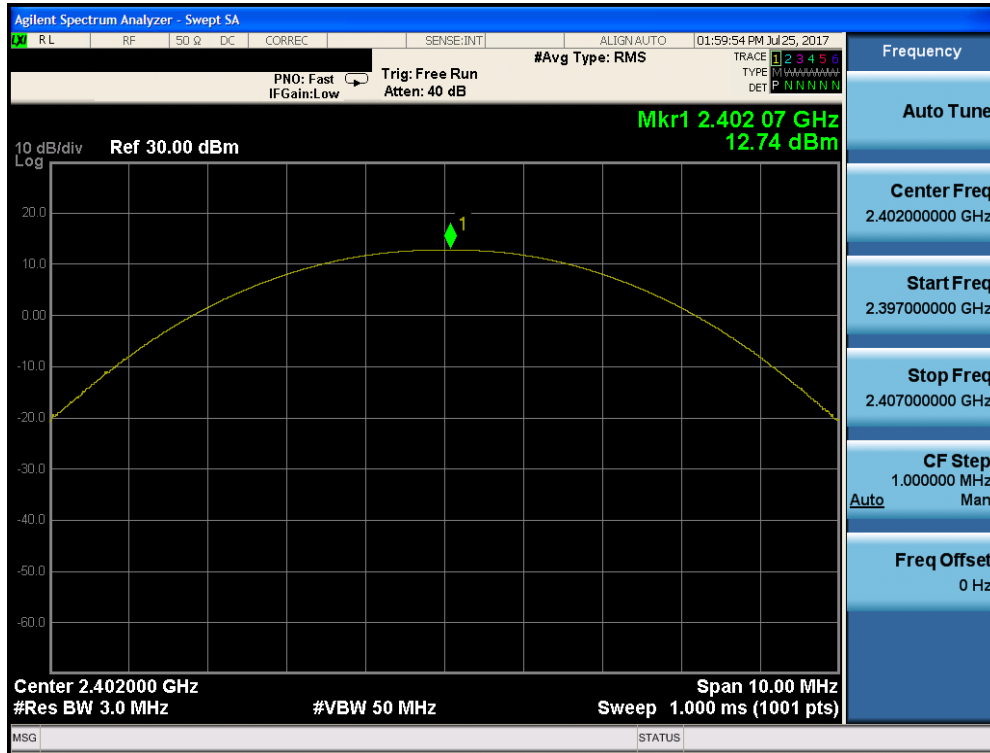

Plot 7-16. Peak Conducted Power (GFSK, iPA – Ch. 0)

FCC ID: BCG-A1858		FCC Pt. 15.247 BLUETOOTH TEST REPORT (CERTIFICATION)	Approved by: Quality Manager
Test Report S/N: 1C1706160002-58-04-R3.BCG	Test Dates: 6/9-8/9/2017	EUT Type: Watch	Page 27 of 80

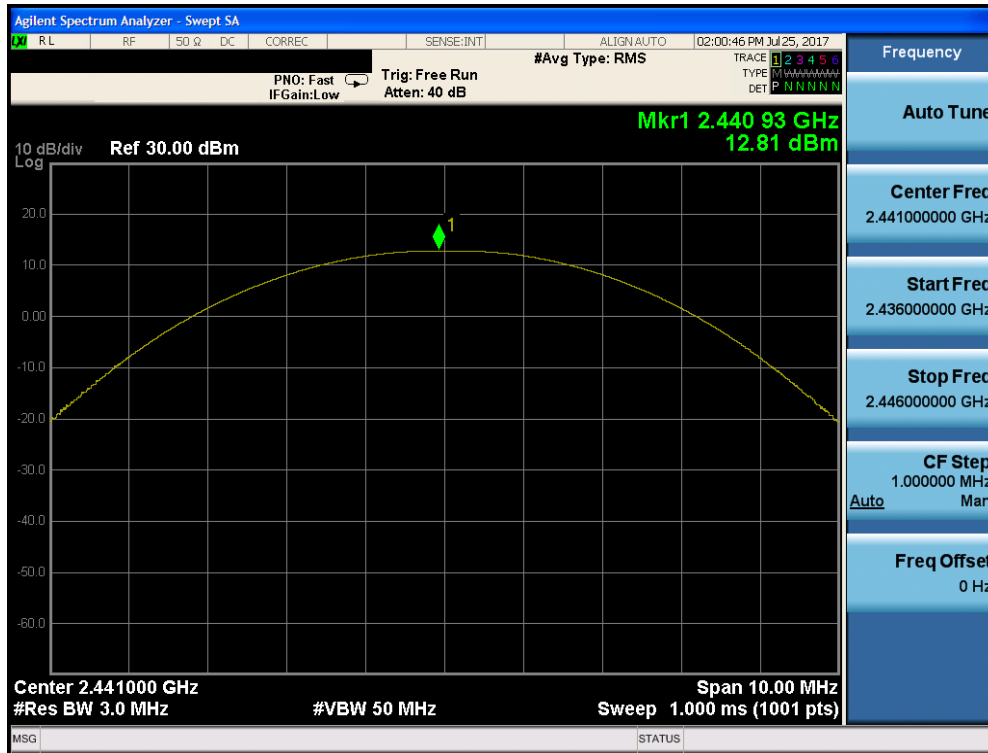

Plot 7-17. Peak Conducted Power (GFSK, iPA – Ch. 39)

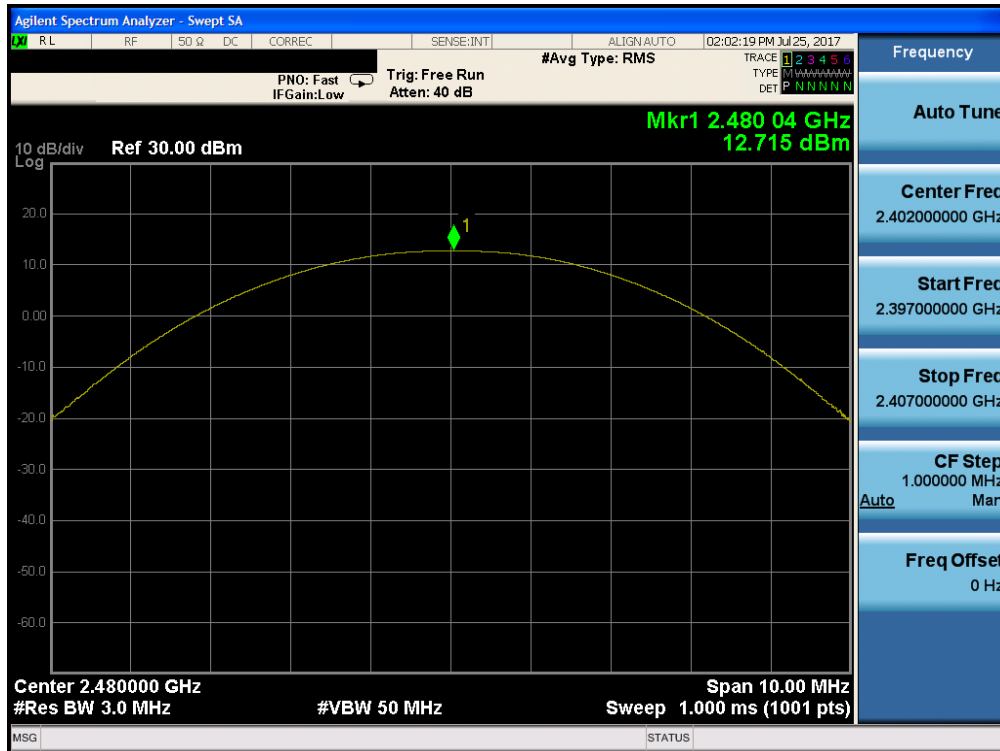

Plot 7-18. Peak Conducted Power (GFSK, iPA – Ch. 78)

FCC ID: BCG-A1858	PCTEST ENGINEERING LABORATORY, INC.	FCC Pt. 15.247 BLUETOOTH TEST REPORT (CERTIFICATION)	Approved by: Quality Manager
Test Report S/N: 1C1706160002-58-04-R3.BCG	Test Dates: 6/9-8/9/2017	EUT Type: Watch	Page 28 of 80

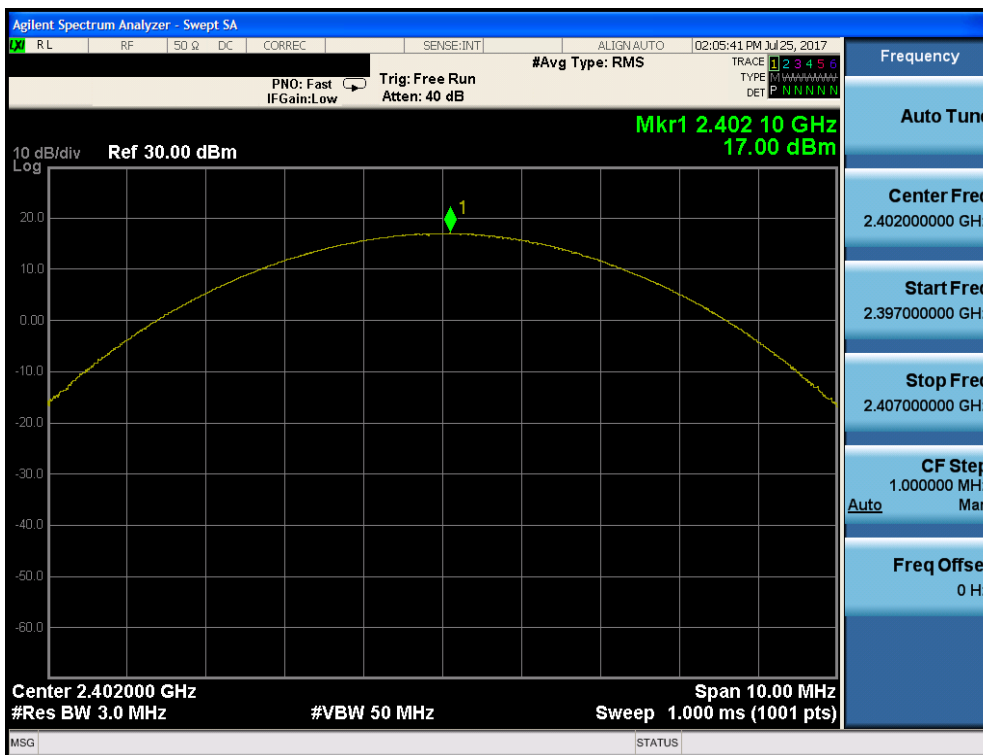

Plot 7-19. Peak Conducted Power (8DPSK, ePA – Ch. 0)

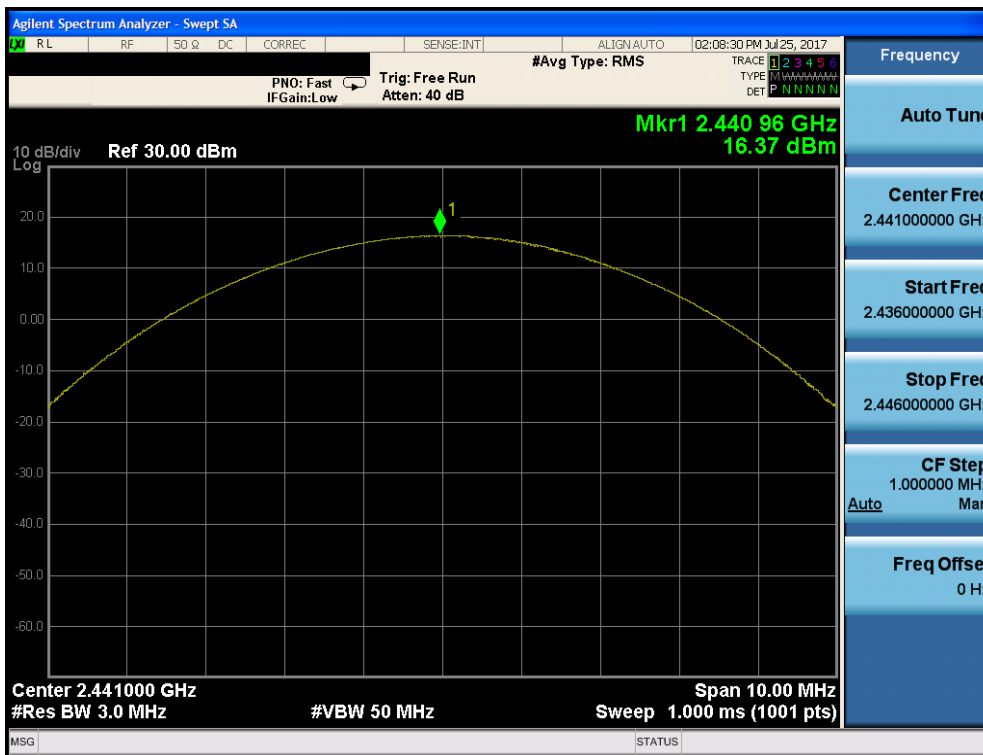

Plot 7-20. Peak Conducted Power (8DPSK, ePA – Ch. 39)

FCC ID: BCG-A1858		FCC Pt. 15.247 BLUETOOTH TEST REPORT (CERTIFICATION)	Approved by: Quality Manager
Test Report S/N: 1C1706160002-58-04-R3.BCG	Test Dates: 6/9-8/9/2017	EUT Type: Watch	Page 29 of 80

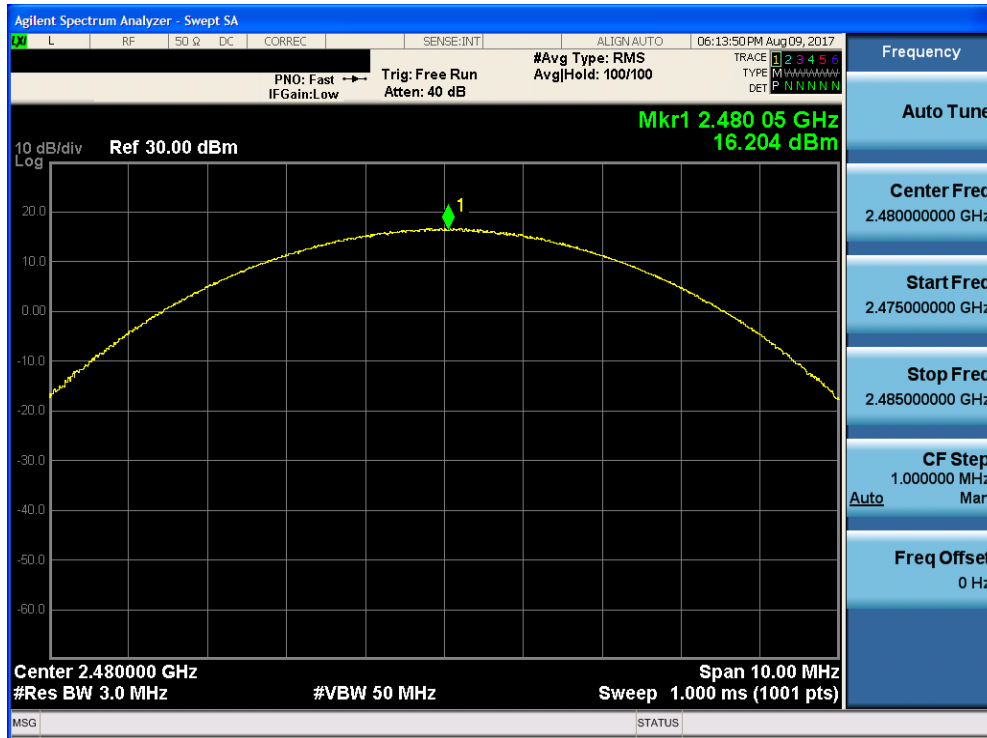

Plot 7-21. Peak Conducted Power (8DPSK, ePA – Ch. 78)

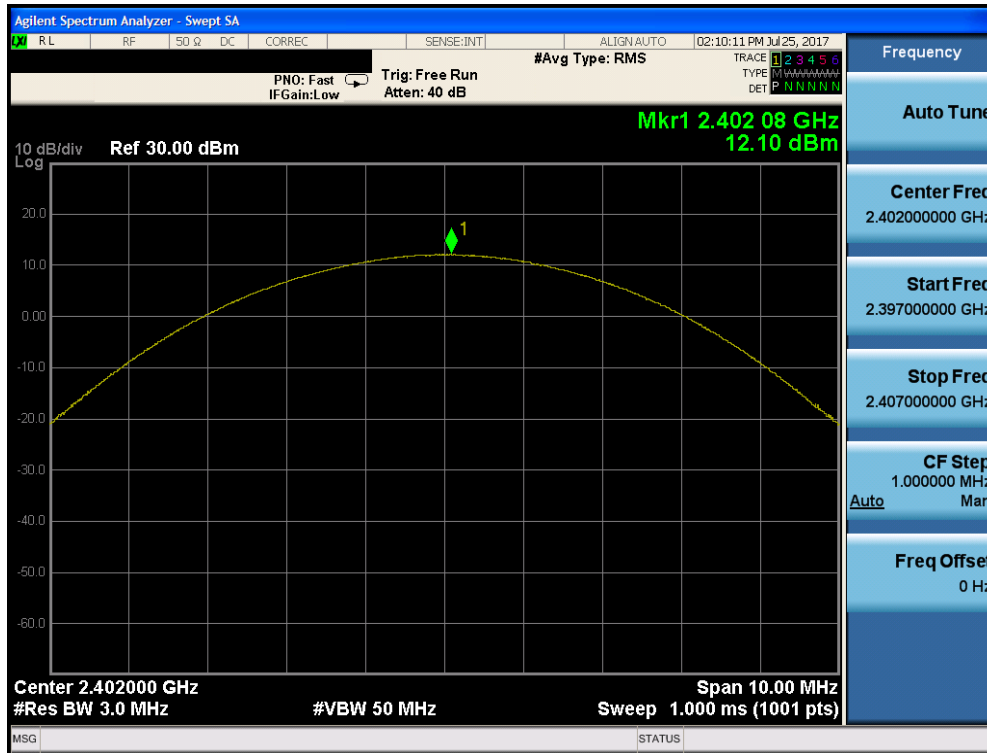

Plot 7-22. Peak Conducted Power (8DPSK, iPA – Ch. 0)

FCC ID: BCG-A1858		FCC Pt. 15.247 BLUETOOTH TEST REPORT (CERTIFICATION)	Approved by: Quality Manager
Test Report S/N: 1C1706160002-58-04-R3.BCG	Test Dates: 6/9-8/9/2017	EUT Type: Watch	Page 30 of 80

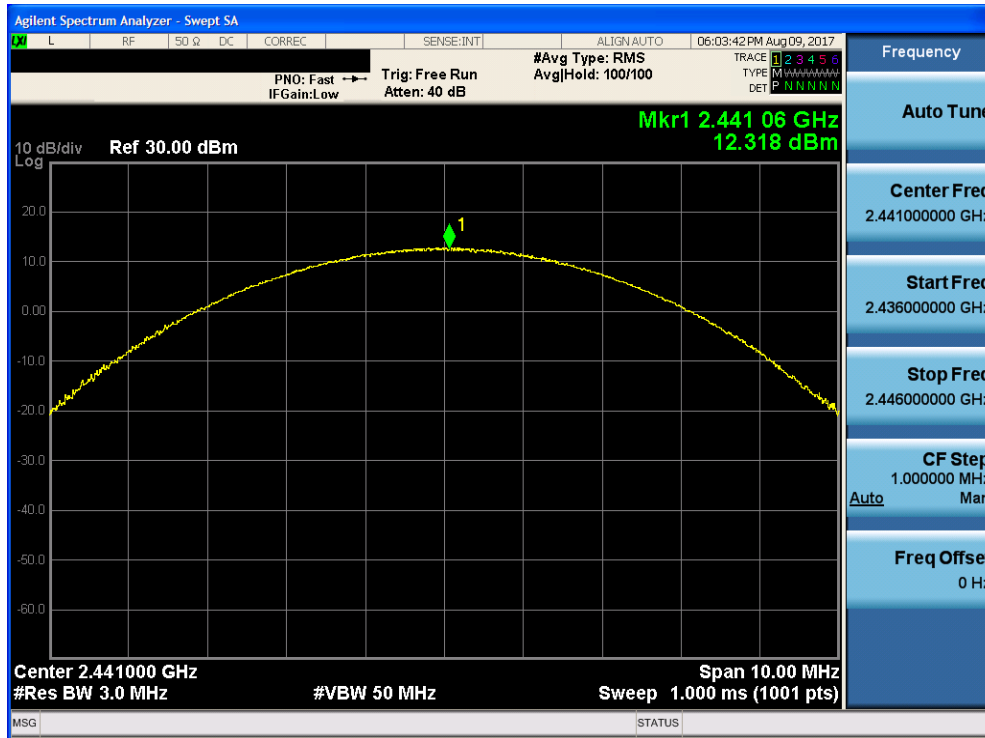

Plot 7-23. Peak Conducted Power (8DPSK, iPA – Ch. 39)

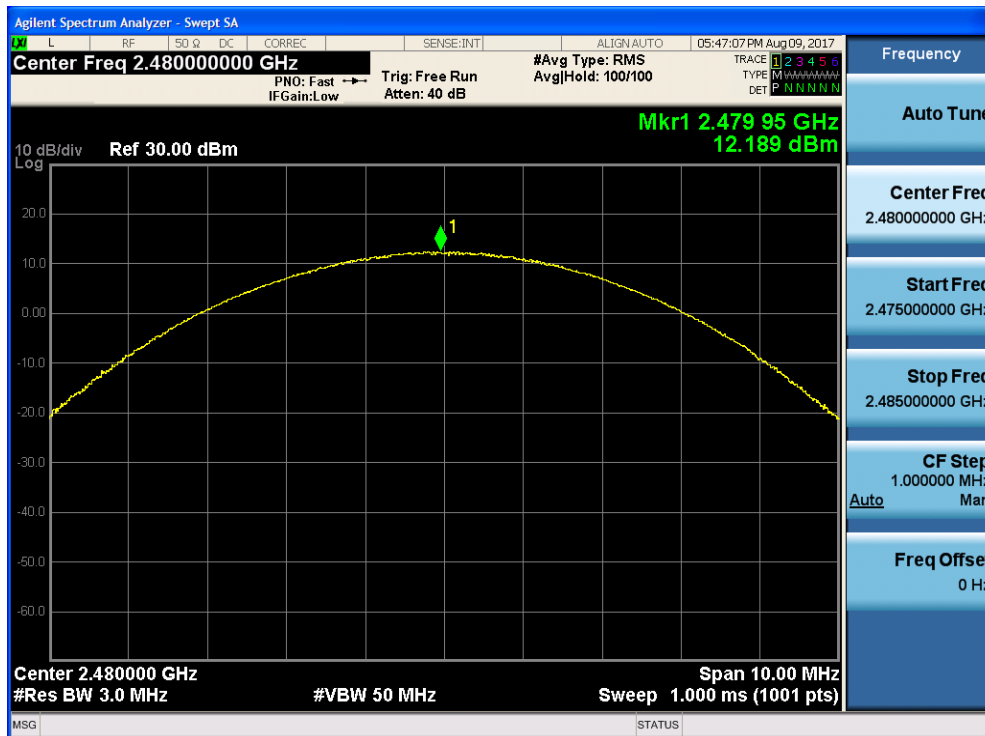

Plot 7-24. Peak Conducted Power (8DPSK, iPA – Ch. 78)

FCC ID: BCG-A1858	PCTEST ENGINEERING LABORATORY, INC.	FCC Pt. 15.247 BLUETOOTH TEST REPORT (CERTIFICATION)	Approved by: Quality Manager
Test Report S/N: 1C1706160002-58-04-R3.BCG	Test Dates: 6/9-8/9/2017	EUT Type: Watch	Page 31 of 80

7.4 Band Edge Compliance

§15.247 (d)

Test Overview and Limits

EUT operates in hopping and non-hopping transmission mode. Measurement is taken at the highest point located outside of the emission bandwidth. The maximum permissible out-of-band emission level is 20 dBc.

Test Procedure Used

ANSI C63.10-2013 – Section 6.10.4

Test Settings

1. Start and stop frequency were set such that the band edge would be placed in the center of the plot
2. Span was set large enough so as to capture all out of band emissions near the band edge
3. RBW = 100kHz
4. VBW = 300kHz
5. Detector = Peak
6. Number of sweep points $\geq 2 \times \text{Span/RBW}$
7. Trace mode = max hold
8. Sweep time = auto couple
9. The trace was allowed to stabilize

Test Setup

The EUT and measurement equipment were set up as shown in the diagram below.

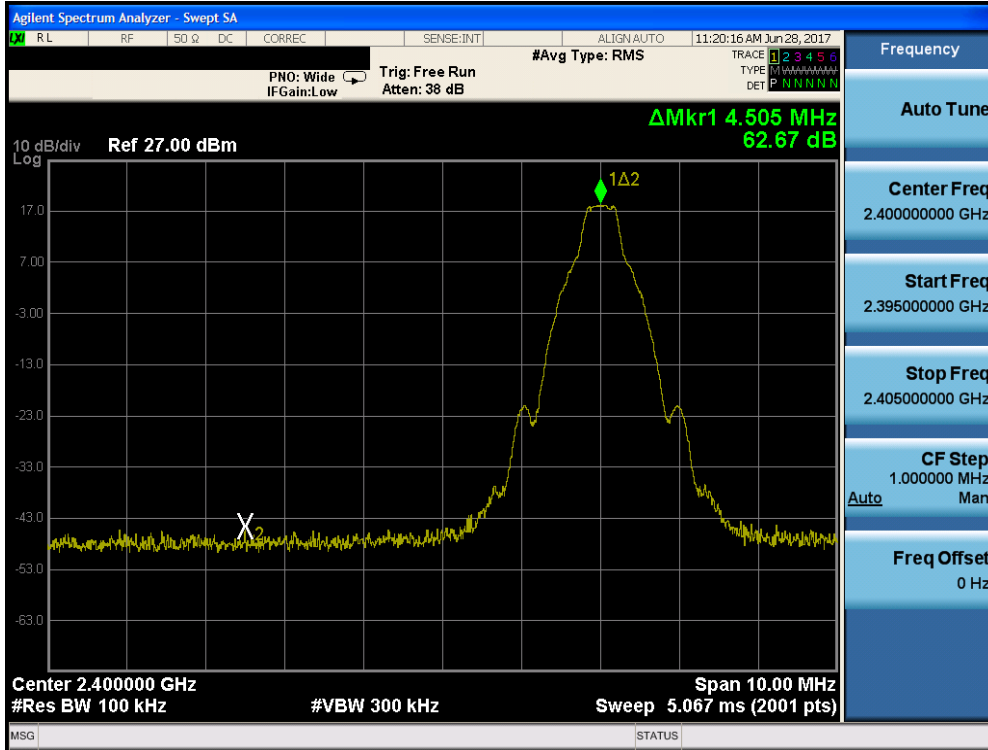

Figure 7-4. Test Instrument & Measurement Setup

Test Notes

Out of band conducted spurious emissions at the band edge were investigated for all data rates in hopping and non-hopping modes. The worst case emissions were found with the EUT transmitting at 3 Mbps. Band edge emissions were also investigated with the EUT transmitting in all data rates. Plots of the worst case emissions are shown below.

FCC ID: BCG-A1858		FCC Pt. 15.247 BLUETOOTH TEST REPORT (CERTIFICATION)	Approved by: Quality Manager
Test Report S/N: 1C1706160002-58-04-R3.BCG	Test Dates: 6/9-8/9/2017	EUT Type: Watch	Page 32 of 80



Plot 7-25. Band Edge Plot (Bluetooth with Hopping Disabled, GFSK, ePA – Ch. 0)

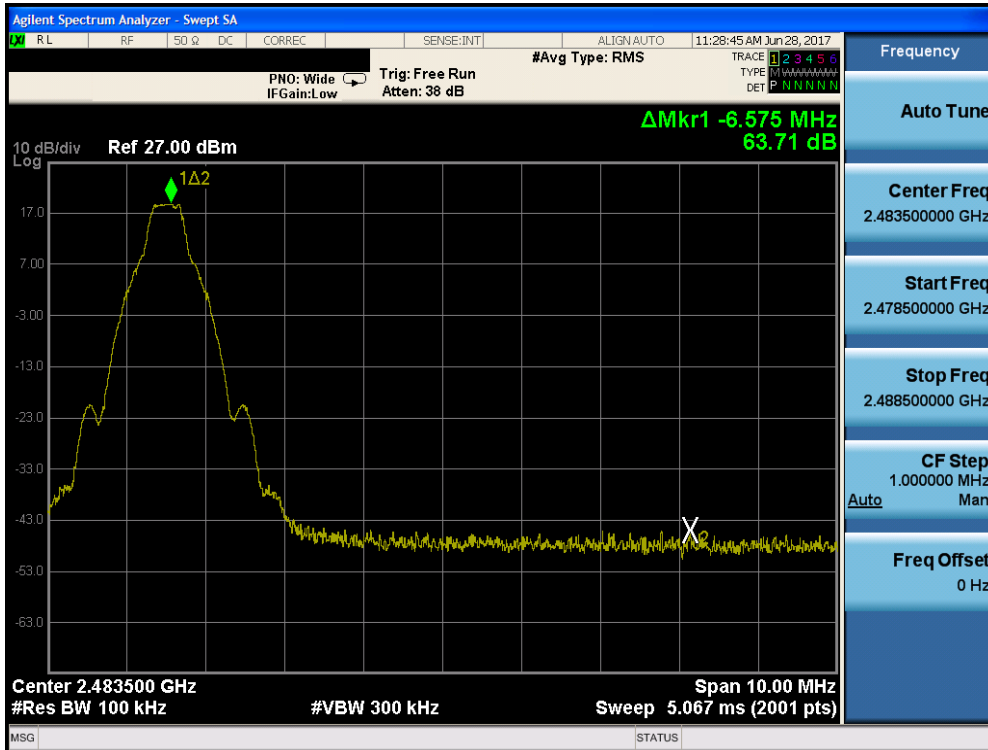

Plot 7-26. Band Edge Plot (Bluetooth with Hopping Disabled, GFSK, ePA – Ch. 78)

FCC ID: BCG-A1858	PCTEST ENGINEERING LABORATORY, INC.	FCC Pt. 15.247 BLUETOOTH TEST REPORT (CERTIFICATION)	Approved by: Quality Manager
Test Report S/N: 1C1706160002-58-04-R3.BCG	Test Dates: 6/9-8/9/2017	EUT Type: Watch	Page 33 of 80

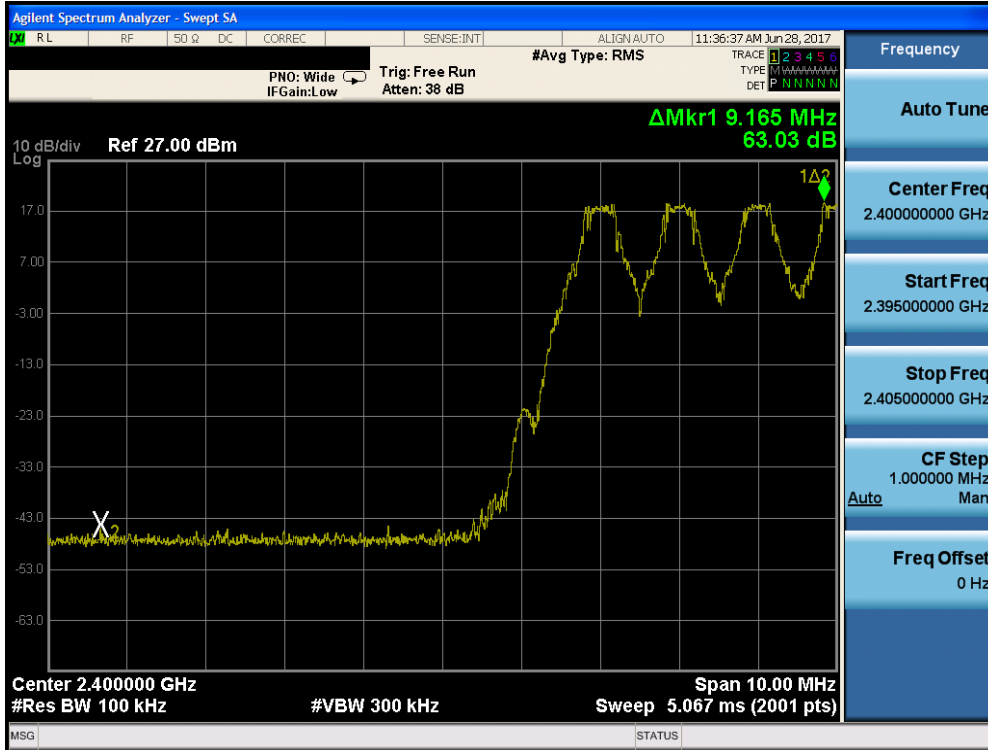

Plot 7-27. Band Edge Plot (Bluetooth with Hopping Enabled, GFSK, ePA - Ch.0)

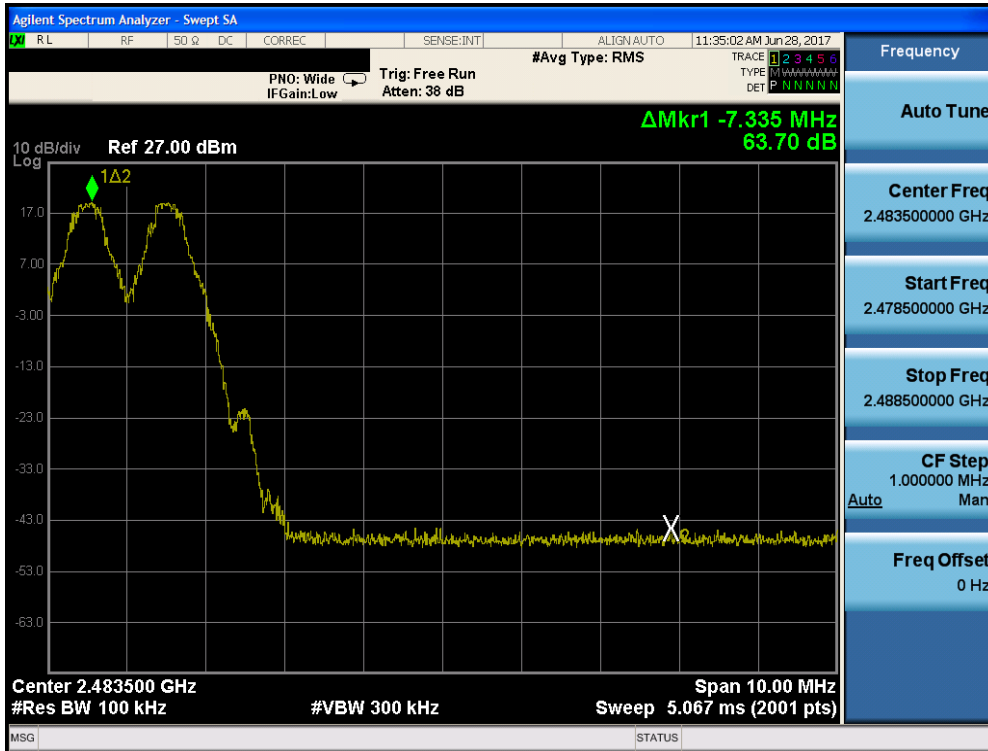

Plot 7-28. Band Edge Plot (Bluetooth with Hopping Enabled, GFSK, ePA - Ch.78)

FCC ID: BCG-A1858	PCTEST ENGINEERING LABORATORY, INC.	FCC Pt. 15.247 BLUETOOTH TEST REPORT (CERTIFICATION)	Approved by: Quality Manager
Test Report S/N: 1C1706160002-58-04-R3.BCG	Test Dates: 6/9-8/9/2017	EUT Type: Watch	Page 34 of 80

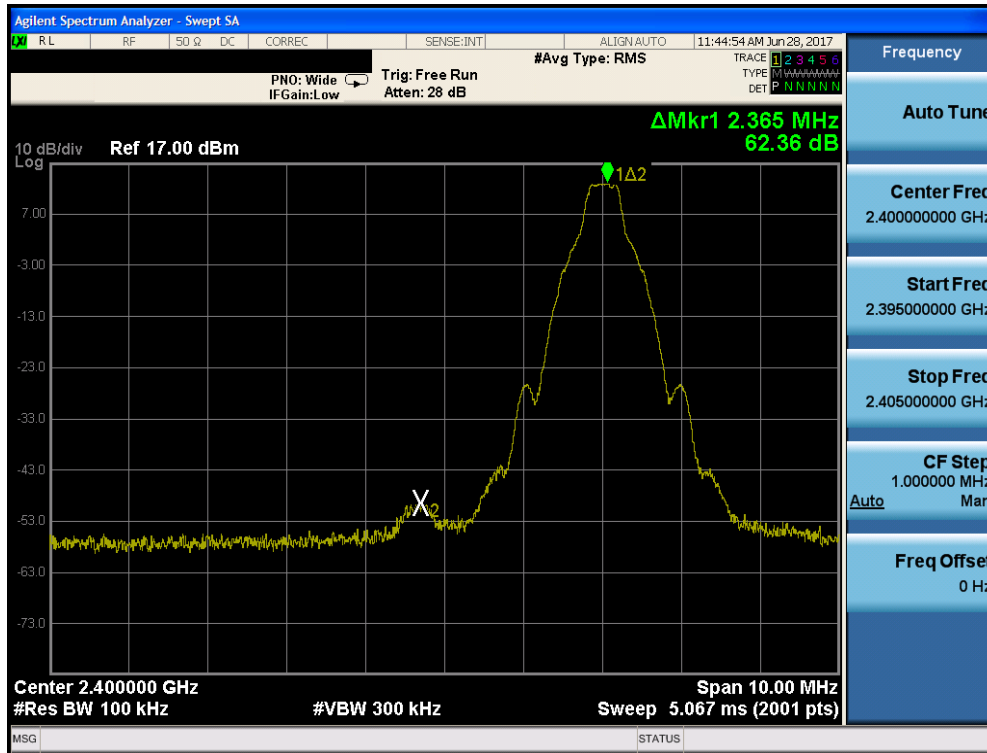

Plot 7-29. Band Edge Plot (Bluetooth with Hopping Disabled, GFSK, iPA – Ch. 0)

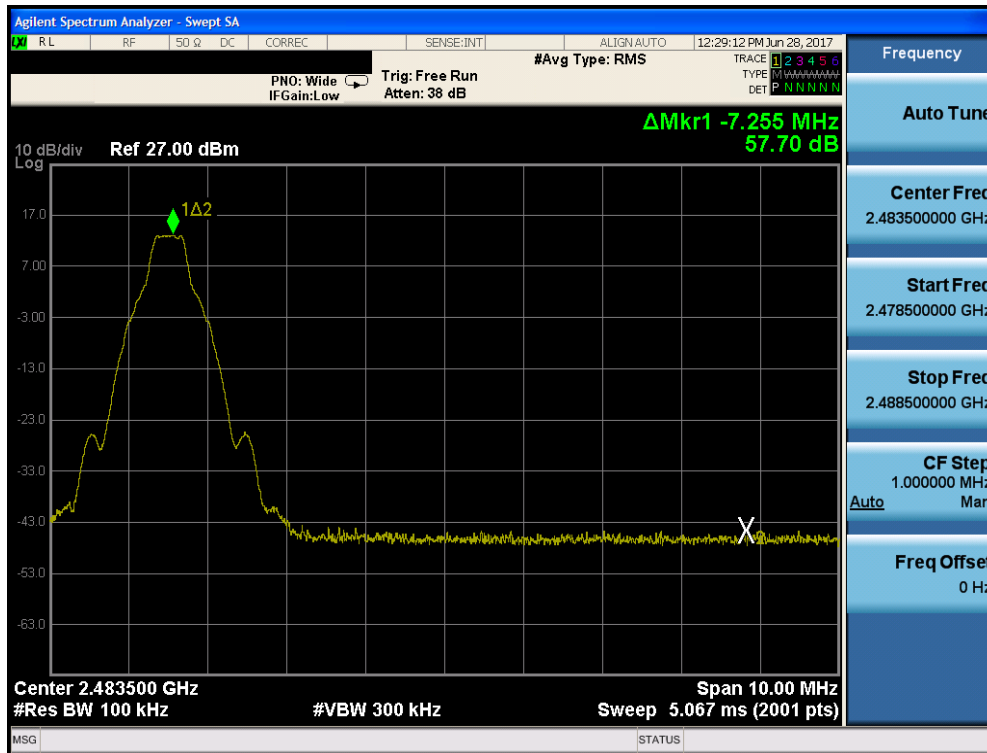

Plot 7-30. Band Edge Plot (Bluetooth with Hopping Disabled, GFSK, iPA – Ch.78)

FCC ID: BCG-A1858	PCTEST ENGINEERING LABORATORY, INC.	FCC Pt. 15.247 BLUETOOTH TEST REPORT (CERTIFICATION)	Approved by: Quality Manager
Test Report S/N: 1C1706160002-58-04-R3.BCG	Test Dates: 6/9-8/9/2017	EUT Type: Watch	Page 35 of 80

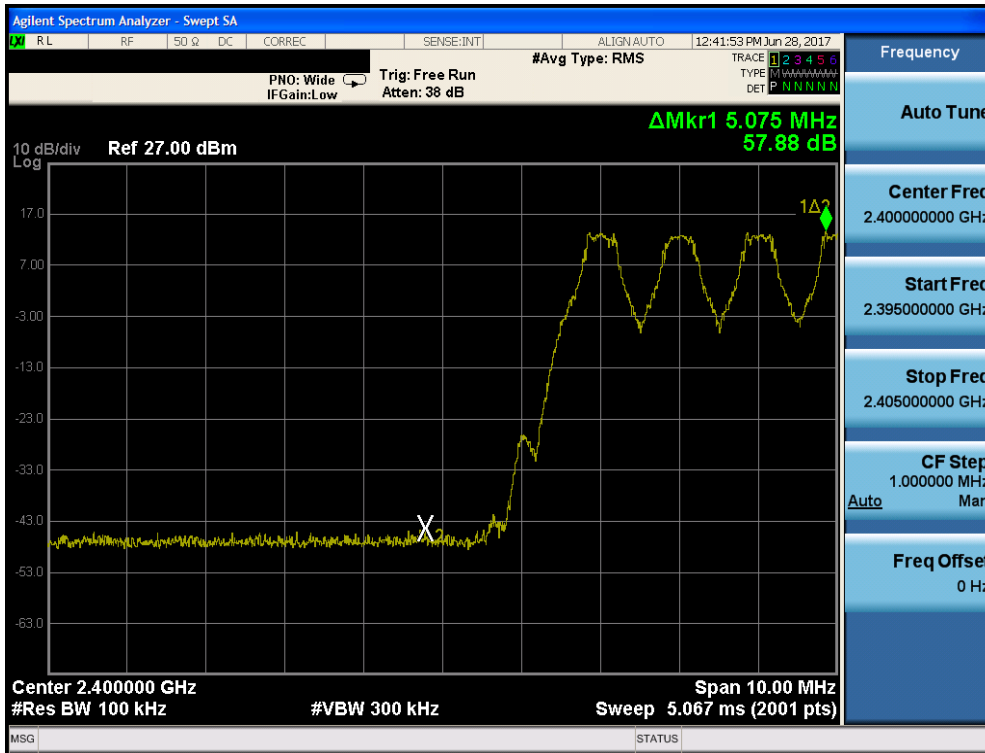

Plot 7-31. Band Edge Plot (Bluetooth with Hopping Enabled, GFSK, iPA - Ch.0)

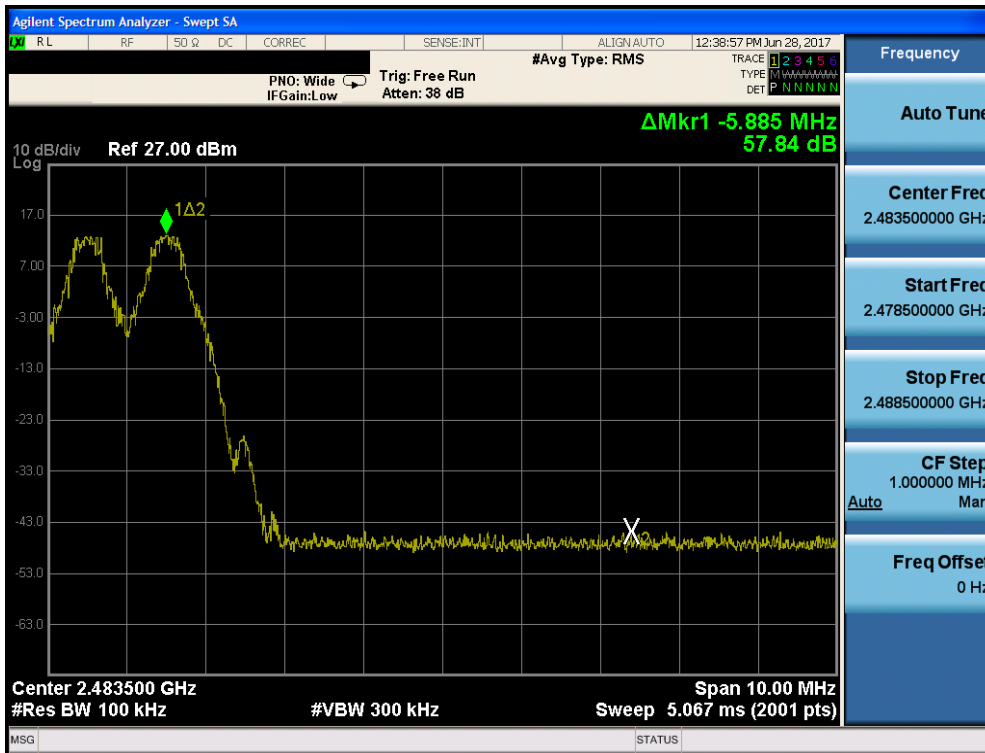

Plot 7-32. Band Edge Plot (Bluetooth with Hopping Enabled, GFSK, iPA - Ch.78)

FCC ID: BCG-A1858	PCTEST ENGINEERING LABORATORY, INC.	FCC Pt. 15.247 BLUETOOTH TEST REPORT (CERTIFICATION)	Approved by: Quality Manager
Test Report S/N: 1C1706160002-58-04-R3.BCG	Test Dates: 6/9-8/9/2017	EUT Type: Watch	Page 36 of 80

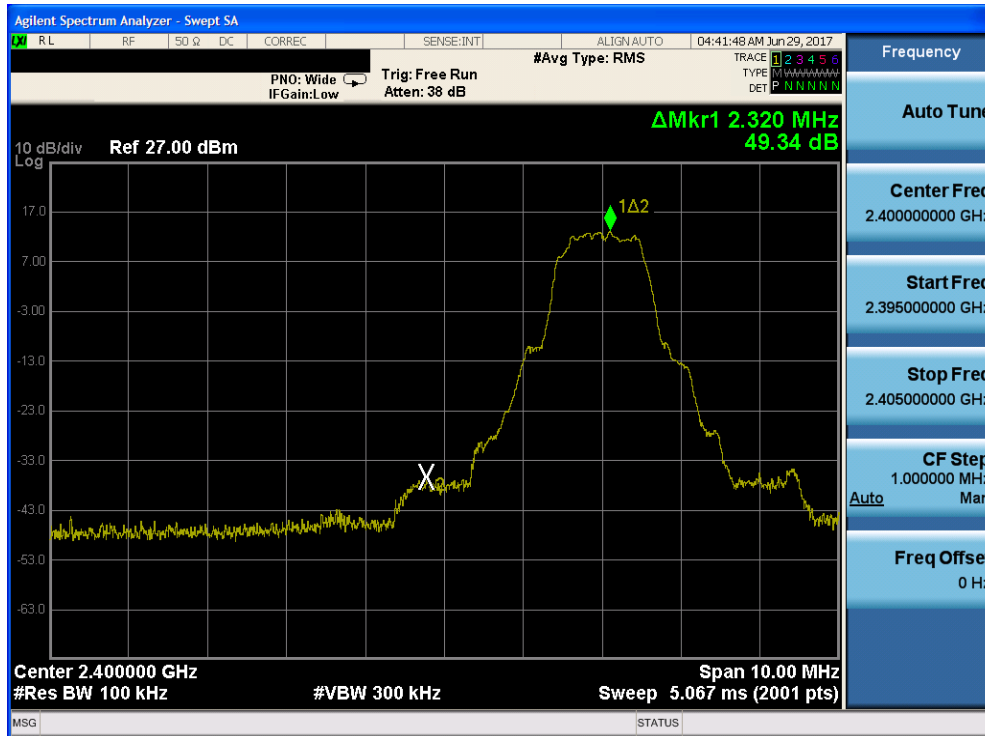

Plot 7-33. Band Edge Plot (Bluetooth with Hopping Disabled, 8DPSK, ePA – Ch. 0)

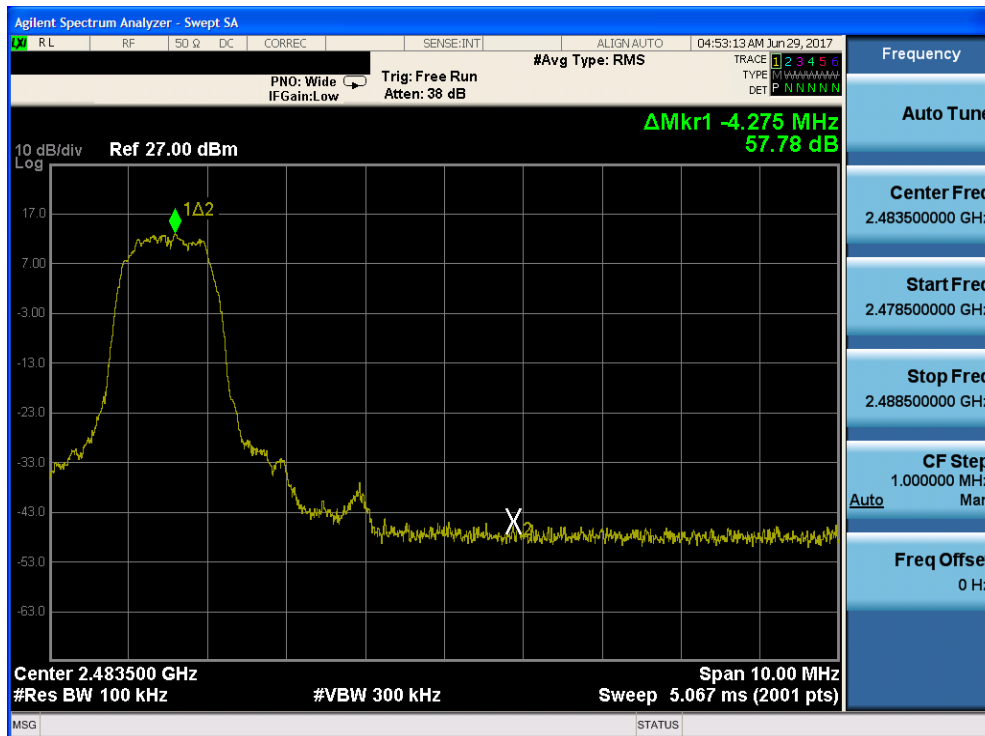

Plot 7-34. Band Edge Plot (Bluetooth with Hopping Disabled, 8DPSK, ePA – Ch. 78)

FCC ID: BCG-A1858	PCTEST ENGINEERING LABORATORY, INC.	FCC Pt. 15.247 BLUETOOTH TEST REPORT (CERTIFICATION)	Approved by: Quality Manager
Test Report S/N: 1C1706160002-58-04-R3.BCG	Test Dates: 6/9-8/9/2017	EUT Type: Watch	Page 37 of 80

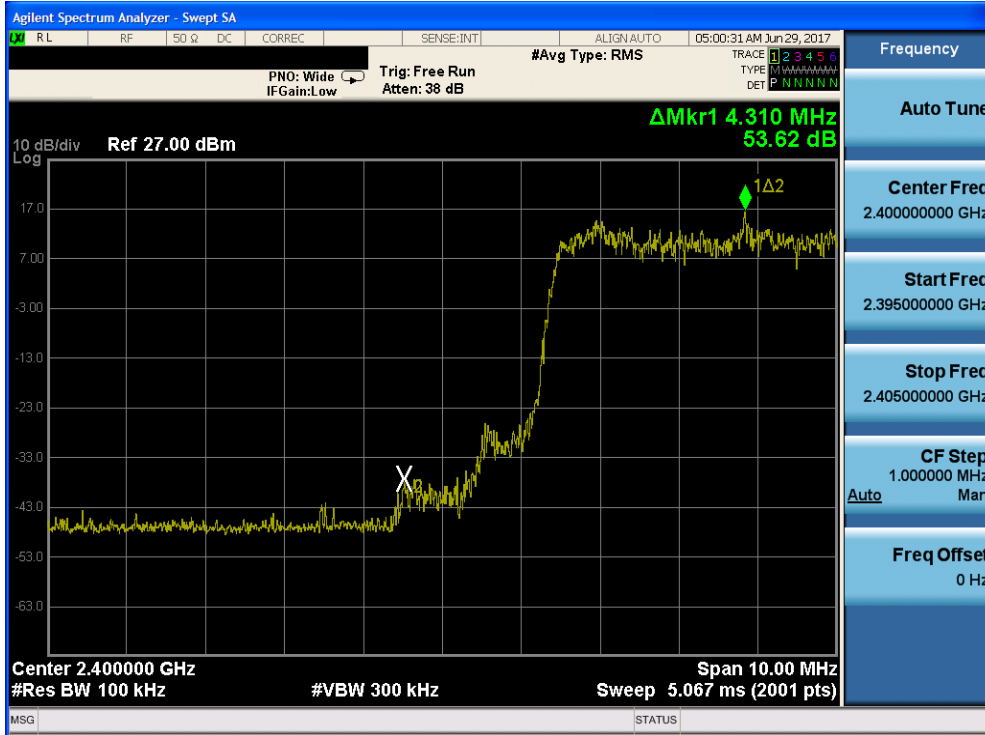

Plot 7-35. Band Edge Plot (Bluetooth with Hopping Enabled, 8DPSK, ePA - Ch.0)

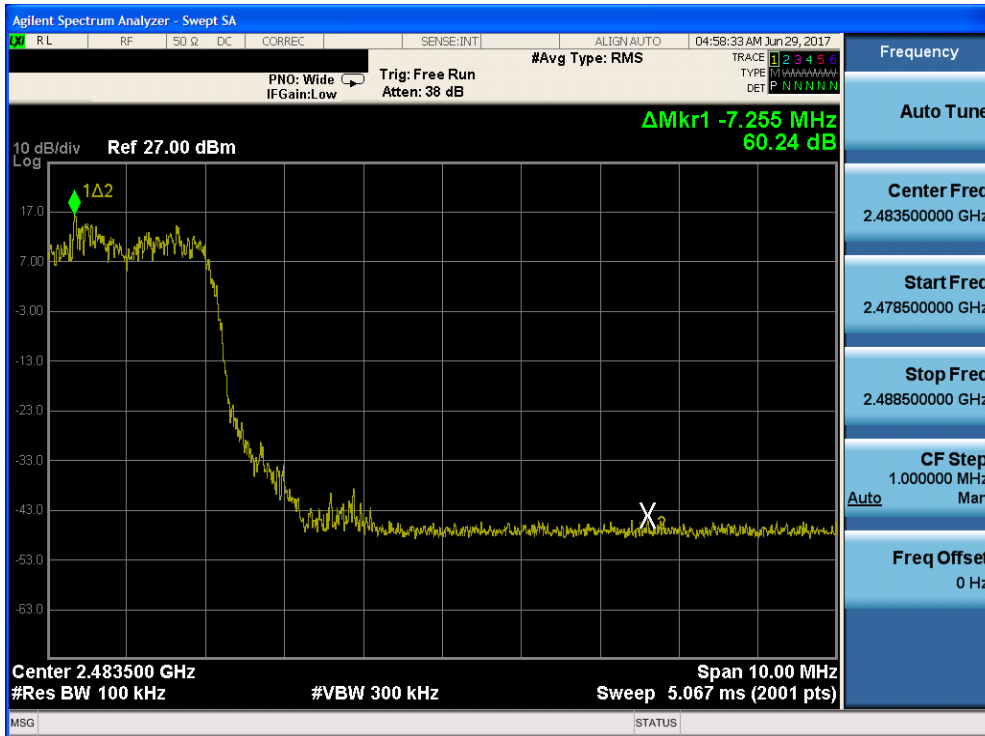

Plot 7-36. Band Edge Plot (Bluetooth with Hopping Enabled, 8DPSK, ePA - Ch.78)

FCC ID: BCG-A1858	PCTEST ENGINEERING LABORATORY, INC.	FCC Pt. 15.247 BLUETOOTH TEST REPORT (CERTIFICATION)	Approved by: Quality Manager
Test Report S/N: 1C1706160002-58-04-R3.BCG	Test Dates: 6/9-8/9/2017	EUT Type: Watch	Page 38 of 80

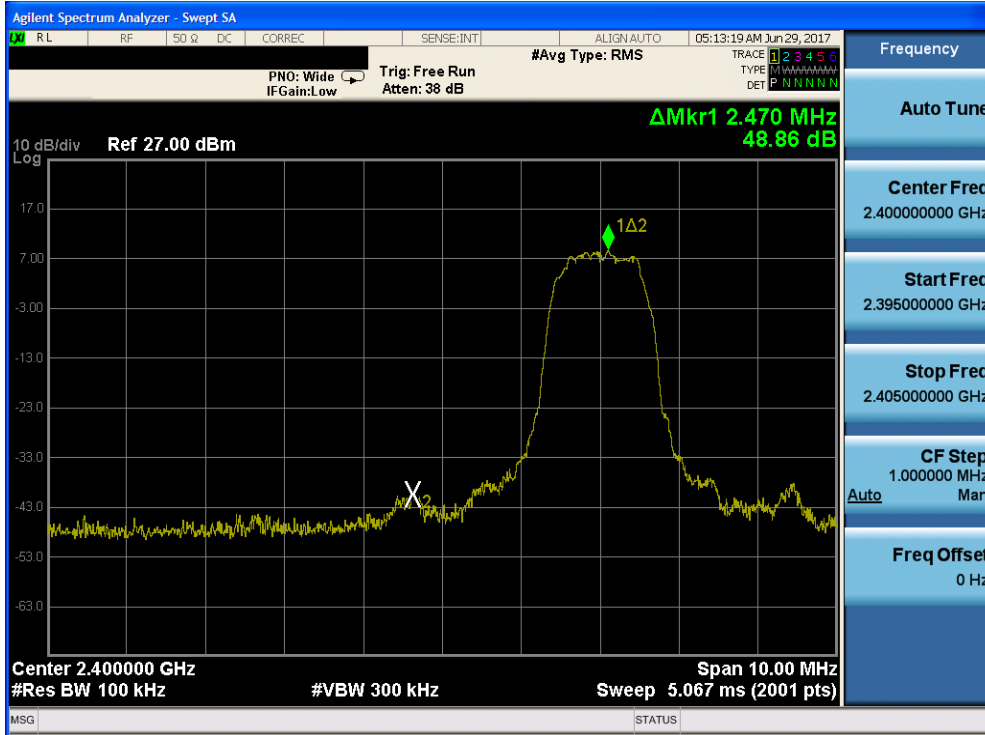

Plot 7-37. Band Edge Plot (Bluetooth with Hopping Disabled, 8DPSK, iPA – Ch. 0)

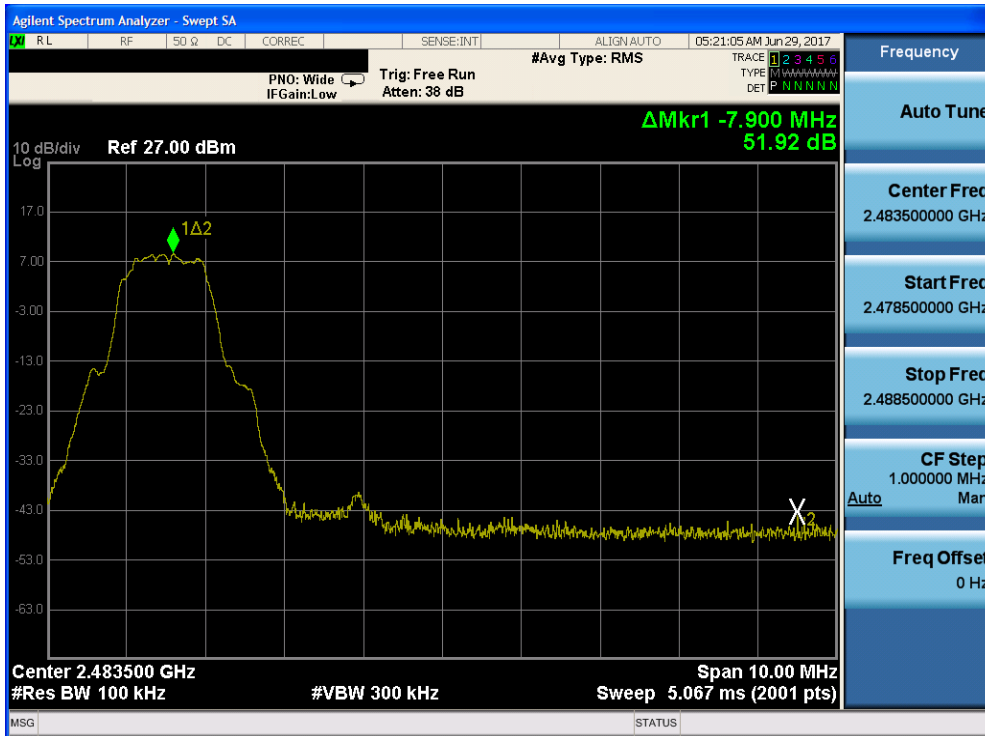

Plot 7-38. Band Edge Plot (Bluetooth with Hopping Disabled, 8DPSK, iPA – Ch. 78)

FCC ID: BCG-A1858	PCTEST ENGINEERING LABORATORY, INC.	FCC Pt. 15.247 BLUETOOTH TEST REPORT (CERTIFICATION)	Approved by: Quality Manager
Test Report S/N: 1C1706160002-58-04-R3.BCG	Test Dates: 6/9-8/9/2017	EUT Type: Watch	Page 39 of 80

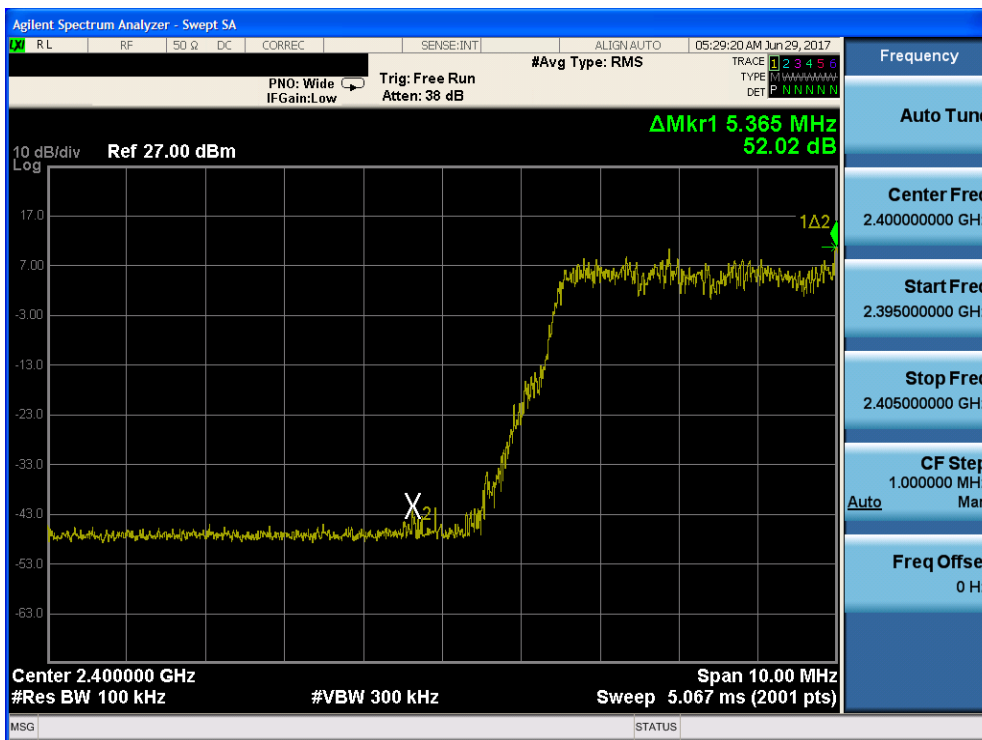

Plot 7-39. Band Edge Plot (Bluetooth with Hopping Enabled, 8DPSK, iPA - Ch.0)

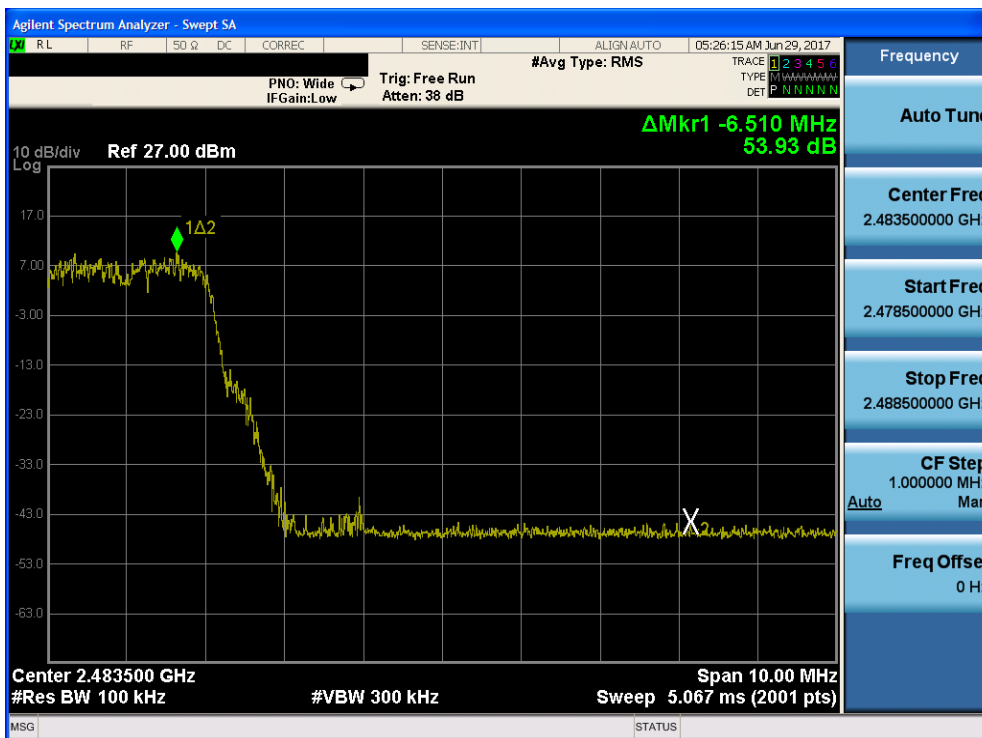

Plot 7-40. Band Edge Plot (Bluetooth with Hopping Enabled, 8DPSK, iPA - Ch.78)

FCC ID: BCG-A1858		FCC Pt. 15.247 BLUETOOTH TEST REPORT (CERTIFICATION)	Approved by: Quality Manager
Test Report S/N: 1C1706160002-58-04-R3.BCG	Test Dates: 6/9-8/9/2017	EUT Type: Watch	Page 40 of 80

7.5 Carrier Frequency Separation

§15.247 (a.1)

Test Overview and Limit

Measurement is made with EUT operating in hopping mode. The minimum permissible channel separation for this system is 2/3 the value of the 20dB BW.

Test Procedure Used

ANSI C63.10-2013 – Section 7.8.2

Test Settings

1. Span = Wide enough to capture peaks of two adjacent channels
2. RBW = 30% of channel spacing. Adjust as necessary to best identify center of each individual channel
3. VBW \geq RBW
4. Sweep = Auto
5. Detector = Peak
6. Trace mode = max hold
7. The trace was allowed to stabilize.
8. Marker-delta function used to determine separation between peaks of the adjacent channels

Test Setup

The EUT and measurement equipment were set up as shown in the diagram below.



Figure 7-5. Test Instrument & Measurement Setup

Test Notes

The EUT complies with the minimum channel separation requirement when it is operating in 1x/EDR mode using 79 channels and when operating in AFH mode using 20 channels.

FCC ID: BCG-A1858		FCC Pt. 15.247 BLUETOOTH TEST REPORT (CERTIFICATION)	Approved by: Quality Manager
Test Report S/N: 1C1706160002-58-04-R3.BCG	Test Dates: 6/9-8/9/2017	EUT Type: Watch	Page 41 of 80

Frequency [MHz]	Modulation	Power Scheme	Channel No.	Min. Channel Separation [MHz]	Pass/Fail
2402	GFSK	ePA	0	0.632	Pass
2441	GFSK	ePA	39	0.631	Pass
2480	GFSK	ePA	78	0.631	Pass
2402	GFSK	iPA	0	0.631	Pass
2441	GFSK	iPA	39	0.631	Pass
2480	GFSK	iPA	78	0.631	Pass
2402	8DPSK	ePA	0	0.903	Pass
2441	8DPSK	ePA	39	0.901	Pass
2480	8DPSK	ePA	78	0.901	Pass
2402	8DPSK	iPA	0	0.904	Pass
2441	8DPSK	iPA	39	0.905	Pass
2480	8DPSK	iPA	78	0.904	Pass

Table 7-5. Minimum Channel Separation

FCC ID: BCG-A1858		FCC Pt. 15.247 BLUETOOTH TEST REPORT (CERTIFICATION)		Approved by: Quality Manager
Test Report S/N: 1C1706160002-58-04-R3.BCG	Test Dates: 6/9-8/9/2017	EUT Type: Watch		Page 42 of 80

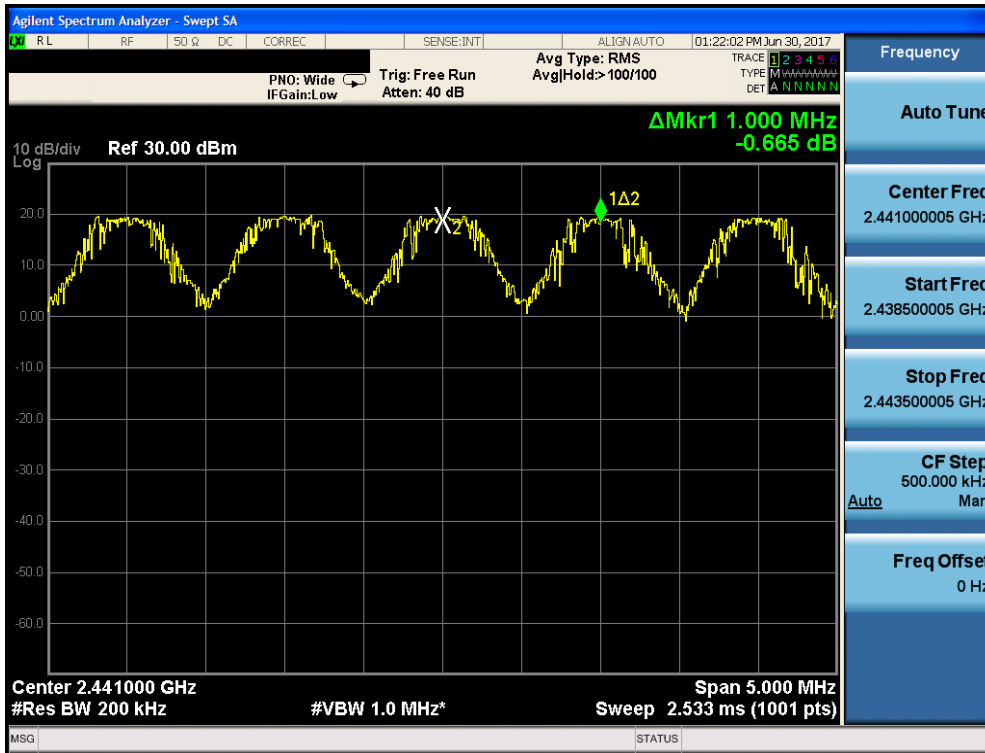

Plot 7-41. Channel Spacing Plot (Bluetooth, GFSK, ePA)



Plot 7-42. Channel Spacing Plot (Bluetooth, 8DPSK, ePA)

FCC ID: BCG-A1858		FCC Pt. 15.247 BLUETOOTH TEST REPORT (CERTIFICATION)	Approved by: Quality Manager
Test Report S/N: 1C1706160002-58-04-R3.BCG	Test Dates: 6/9-8/9/2017	EUT Type: Watch	Page 43 of 80

7.6 Time of Occupancy

§15.247 (a.1.iii)

Test Overview and Limit

Measurement is made while EUT is operating in hopping mode with the spectrum analyzer set to zero span. The maximum permissible time of occupancy is 400 ms within a period of 400ms multiplied by the number of hopping channels employed.

Test Procedure Used

ANSI C63.10-2013 – Section 7.8.4

Test Settings

1. Span = zero span, centered on a hopping channel
2. RBW \leq channel spacing and $\gg 1/T$, where T is expected dwell time per channel
3. Sweep = as necessary to capture entire dwell time. Second plot may be required to demonstrate two successive hops on a channel
4. Trigger is set with appropriate trigger delay to place pulse near the center of the plot
5. Detector = peak
6. Trace mode = max hold
7. Marker-delta function used to determine transmit time per hop

Test Setup

The EUT and measurement equipment were set up as shown in the diagram below.

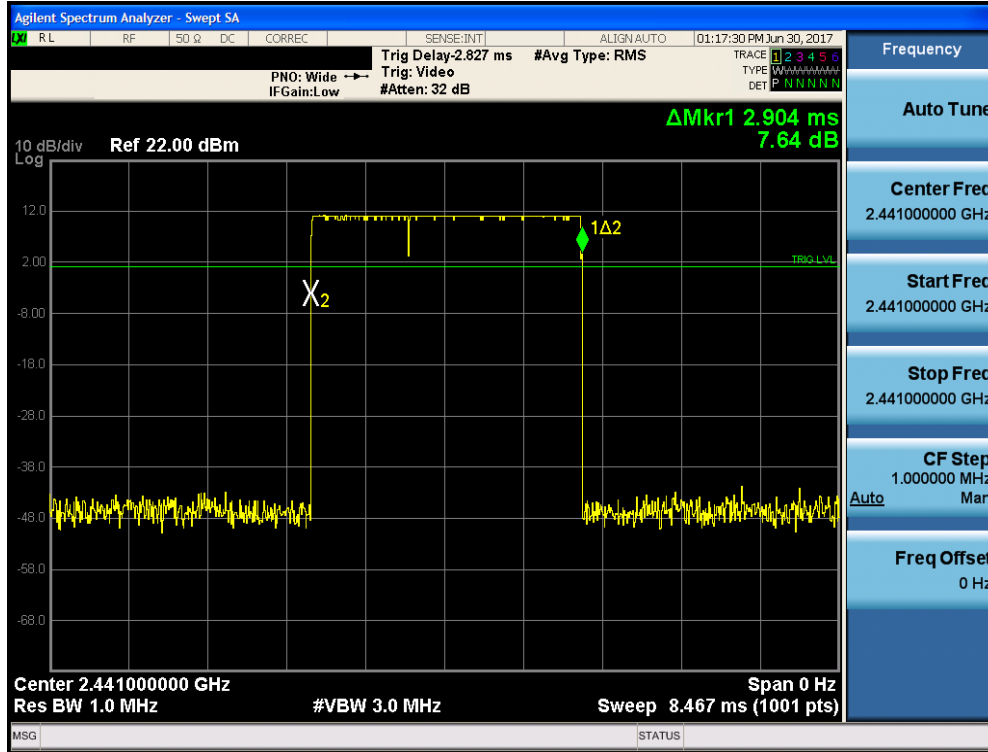

Figure 7-6. Test Instrument & Measurement Setup

Test Notes

None

FCC ID: BCG-A1858		FCC Pt. 15.247 BLUETOOTH TEST REPORT (CERTIFICATION)	Approved by: Quality Manager
Test Report S/N: 1C1706160002-58-04-R3.BCG	Test Dates: 6/9-8/9/2017	EUT Type: Watch	Page 44 of 80



Plot 7-43. Time of Occupancy Plot (Bluetooth, GFSK, ePA)

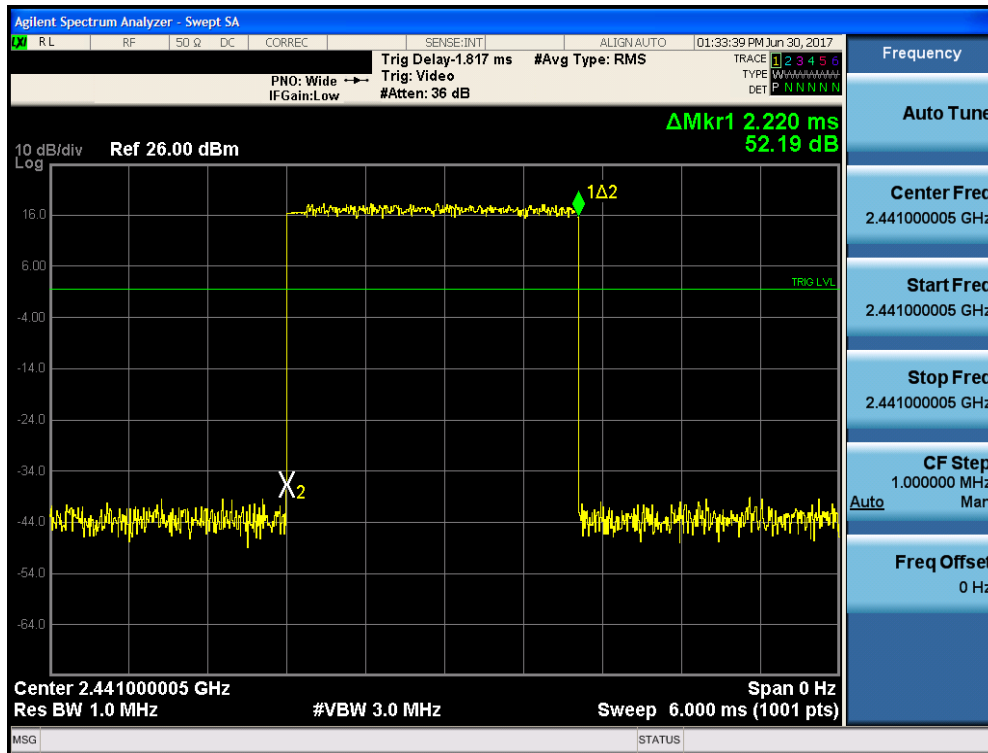

Plot 7-44. Time of Occupancy Plot (Bluetooth, 8DPSK, ePA)

Bluetooth Time of Occupancy Calculation

FCC ID: BCG-A1858	PCTEST ENGINEERING LABORATORY, INC.	FCC Pt. 15.247 BLUETOOTH TEST REPORT (CERTIFICATION)	Approved by: Quality Manager
Test Report S/N: 1C1706160002-58-04-R3.BCG	Test Dates: 6/9-8/9/2017	EUT Type: Watch	Page 45 of 80

Typically, Bluetooth 1x/EDR mode has a channel hopping rate of 1600 hops/s. Since 1x/EDR modes use 5 transmit and 1 receive slot, for a total of 6 slots, the Bluetooth transmitter is actually hopping at a rate of $1600 / 6 = 266.67$ hops/s/slot

- $400\text{ms} \times 79$ hopping channels = 31.6 sec (Time of Occupancy Limit)
- Worst case BT has 266.67 hops/second (for 1x/EDR modes with DH5 operation)
- $266.67 \text{ hops/second} / 79$ channels = 3.38 hops/second (# of hops/second on one channel)
- $3.38 \text{ hops/second/channel} \times 31.6$ seconds = 106.67 hops (# hops over a 31.6 second period)
- $106.67 \text{ hops} \times 2.904 \text{ ms/channel}$ = 309.77 ms (worst case dwell time for one channel in 1x/EDR modes)

With AFH, the number of channels is reduced to a minimum of 20 channels and the channel hopping rate is reduced by 50% to 800 hops/s. AFH mode also uses 6 total slots so the Bluetooth transmitter hops at a rate of $800 / 6 = 133.3$ hops/s/slot

- $400\text{ms} \times 20$ hopping channels = 8 sec (Time of Occupancy Limit)
- Worst case BT has 133.3 hops/second/slot (for AFH mode with DH5 operation)
- $133.3 \text{ hops/s} / 20$ channels = 6.67 hops/second (# of hops/second on one channel)
- $6.67 \text{ hops/s} / \text{channel} \times 8$ seconds = 53.34 hops (# hops over a 8 second period)
- $53.34 \text{ hops} \times 2.220 \text{ ms/channel}$ = 118.41 ms (worst case dwell time for one channel in AFH mode)

FCC ID: BCG-A1858	 FCC Pt. 15.247 BLUETOOTH TEST REPORT (CERTIFICATION)		Approved by: Quality Manager
Test Report S/N: 1C1706160002-58-04-R3.BCG	Test Dates: 6/9-8/9/2017	EUT Type: Watch	Page 46 of 80

7.7 Number of Hopping Channels

§15.247 (a.1.iii)

Test Overview and Limit

Measurement is made while EUT is operating in hopping mode. This frequency hopping system must employ a minimum of 15 hopping channels.

Test Procedure Used

ANSI C63.10-2013 – Section 7.8.3

Test Settings

1. Span = frequency of band of operation (divided into two plots)
2. RBW < 30% of channel spacing or 20dB bandwidth, whichever is smaller.
3. VBW ≥ RBW
4. Sweep = auto
5. Detector = peak
6. Trace mode = max hold
7. Trace was allowed to stabilize

Test Setup

The EUT and measurement equipment were set up as shown in the diagram below.

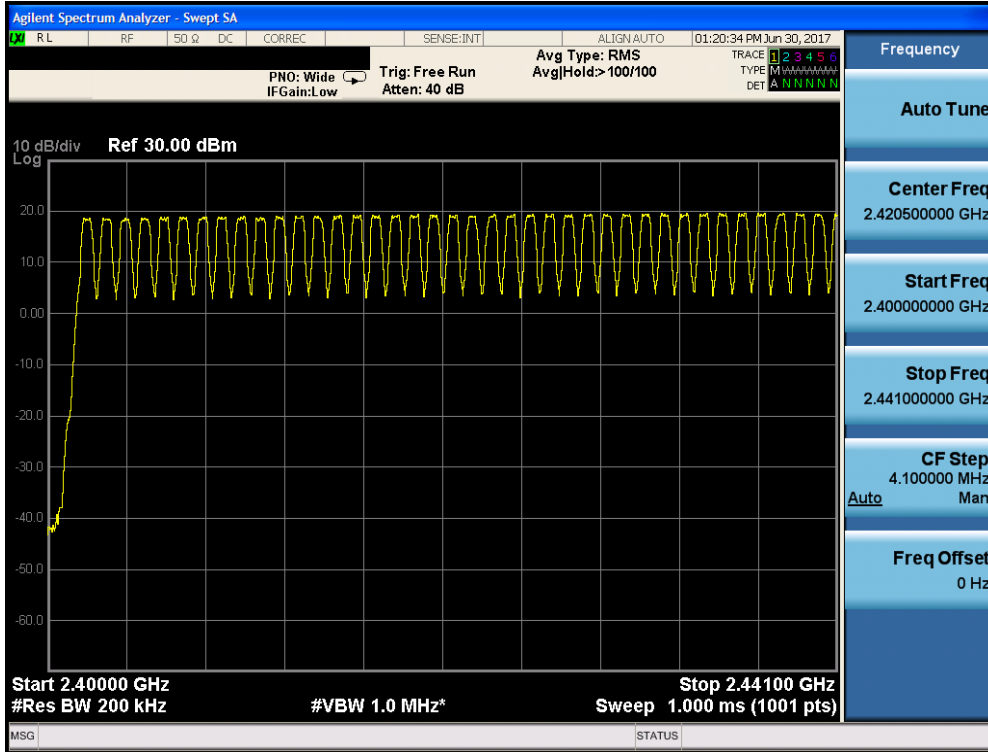

Figure 7-7. Test Instrument & Measurement Setup

Test Notes

The frequency spectrum was broken up into two sub-ranges to clearly show all of the hopping frequencies. In AFH mode, this device operates using 20 channels so the requirement for minimum number of hopping channels is satisfied.

FCC ID: BCG-A1858		FCC Pt. 15.247 BLUETOOTH TEST REPORT (CERTIFICATION)	Approved by: Quality Manager
Test Report S/N: 1C1706160002-58-04-R3.BCG	Test Dates: 6/9-8/9/2017	EUT Type: Watch	Page 47 of 80



Plot 7-45. Low End Spectrum Channel Hopping Plot (Bluetooth, GFSK, ePA)

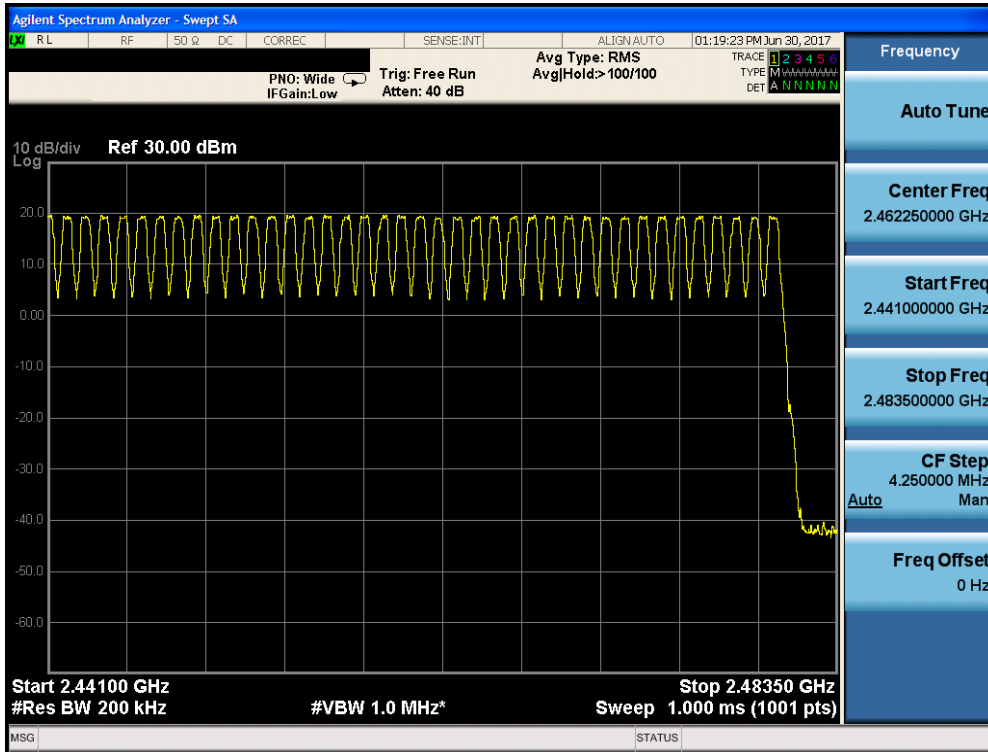

Plot 7-46. High End Spectrum Channel Hopping Plot (Bluetooth, GFSK, ePA)

FCC ID: BCG-A1858	 PCTEST ENGINEERING LABORATORY, INC.	FCC Pt. 15.247 BLUETOOTH TEST REPORT (CERTIFICATION)	Approved by: Quality Manager
Test Report S/N: 1C1706160002-58-04-R3.BCG	Test Dates: 6/9-8/9/2017	EUT Type: Watch	Page 48 of 80

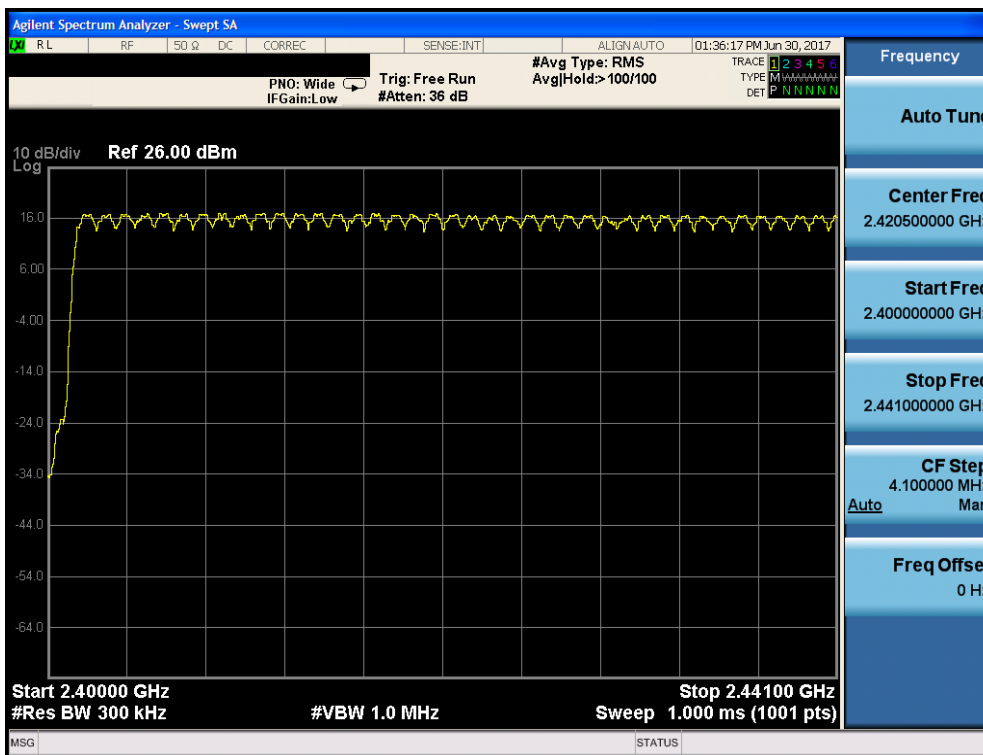

Plot 7-47. Low End Spectrum Channel Hopping Plot (Bluetooth, 8DPSK, ePA)

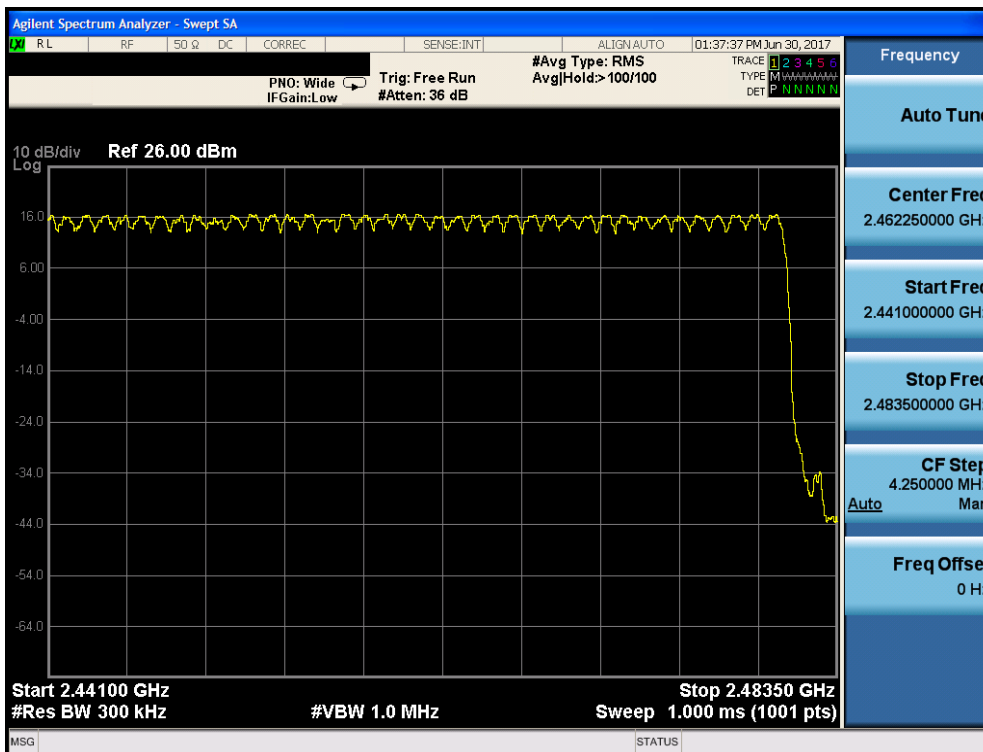

Plot 7-48. High End Spectrum Channel Hopping Plot (Bluetooth, 8DPSK, ePA)

FCC ID: BCG-A1858	PCTEST ENGINEERING LABORATORY, INC.	FCC Pt. 15.247 BLUETOOTH TEST REPORT (CERTIFICATION)	Approved by: Quality Manager
Test Report S/N: 1C1706160002-58-04-R3.BCG	Test Dates: 6/9-8/9/2017	EUT Type: Watch	Page 49 of 80

7.8 Conducted Spurious Emissions §15.247 (d)

Test Overview and Limit

Conducted out-of-band spurious emissions were investigated from 30MHz up to 25GHz to include the 10th harmonic of the fundamental transmit frequency. The maximum permissible out-of-band emission level is 20 dBc.

Test Procedure Used

ANSI C63.10-2013 – Section 7.8.8

Test Settings

1. Start frequency was set to 30MHz and stop frequency was set to 25GHz (separated into two plots per channel)
2. RBW = 1MHz* (See note below)
3. VBW = 3MHz
4. Detector = Peak
5. Trace mode = max hold
6. Sweep time = auto couple
7. The trace was allowed to stabilize

Test Setup

The EUT and measurement equipment were set up as shown in the diagram below.

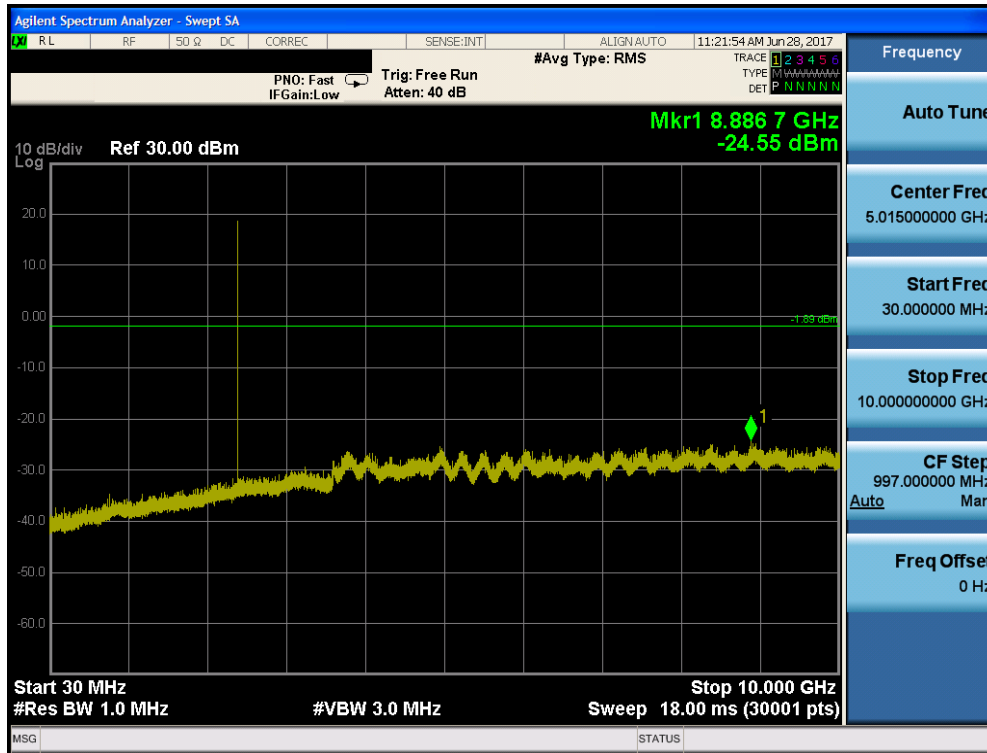

Figure 7-8. Test Instrument & Measurement Setup

Test Notes

Out-of-band conducted spurious emissions were investigated for all data rates and the worst case emissions were found with the EUT transmitting at 1Mbps. The display line shown in the following plots is the limit at 20dB below the fundamental emission level measured in a 100kHz bandwidth. However, the traces in the following plots are measured with a 1MHz RBW to reduce test time, so the display line may not necessarily appear to be 20dB below the level of the fundamental in a 1MHz bandwidth.

FCC ID: BCG-A1858		FCC Pt. 15.247 BLUETOOTH TEST REPORT (CERTIFICATION)	Approved by: Quality Manager
Test Report S/N: 1C1706160002-58-04-R3.BCG	Test Dates: 6/9-8/9/2017	EUT Type: Watch	Page 50 of 80



Plot 7-49. Conducted Spurious Plot (Bluetooth, GFSK, ePA – Ch. 0)

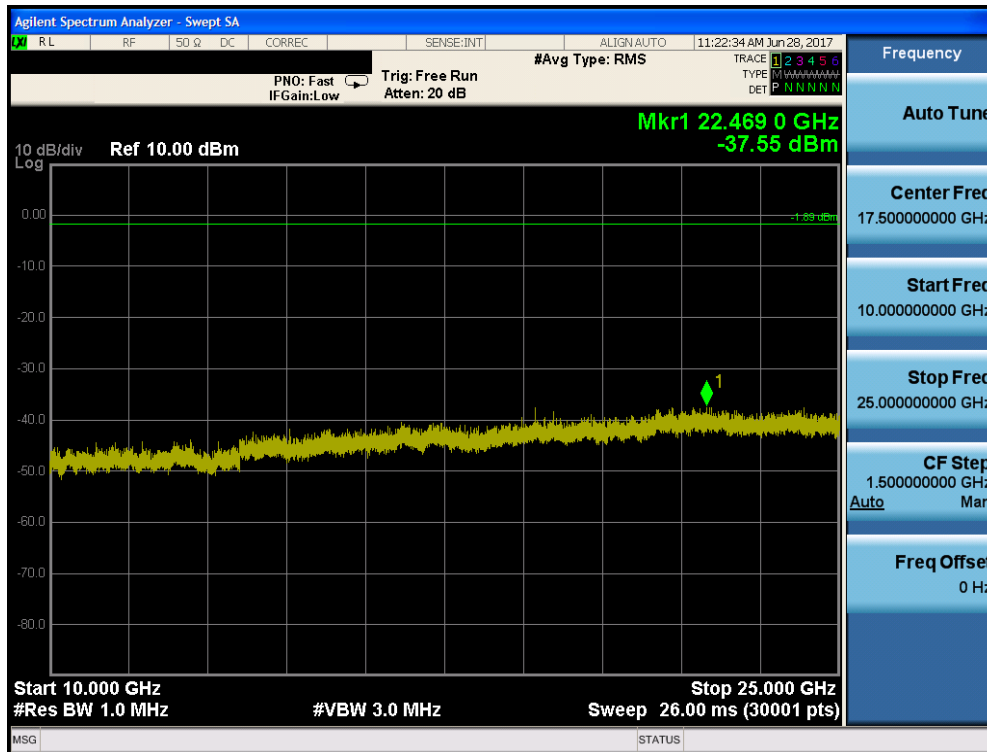

Plot 7-50. Conducted Spurious Plot (Bluetooth, GFSK, ePA – Ch. 0)

FCC ID: BCG-A1858	PCTEST ENGINEERING LABORATORY, INC.	FCC Pt. 15.247 BLUETOOTH TEST REPORT (CERTIFICATION)	Approved by: Quality Manager
Test Report S/N: 1C1706160002-58-04-R3.BCG	Test Dates: 6/9-8/9/2017	EUT Type: Watch	Page 51 of 80

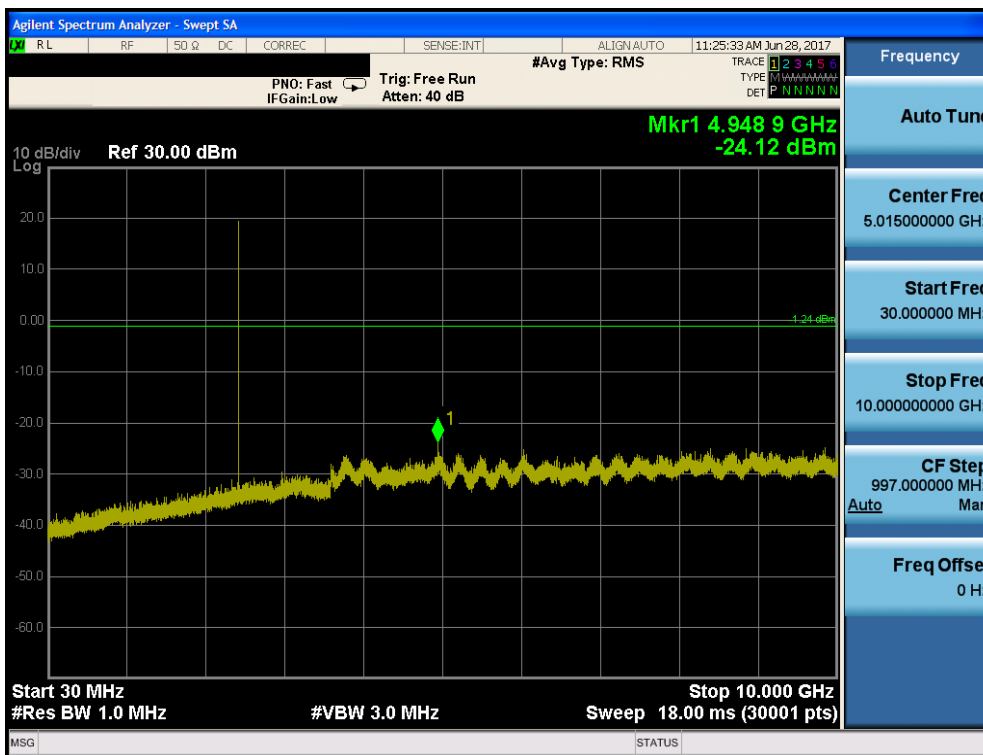

Plot 7-51. Conducted Spurious Plot (Bluetooth, GFSK, ePA – Ch. 39)

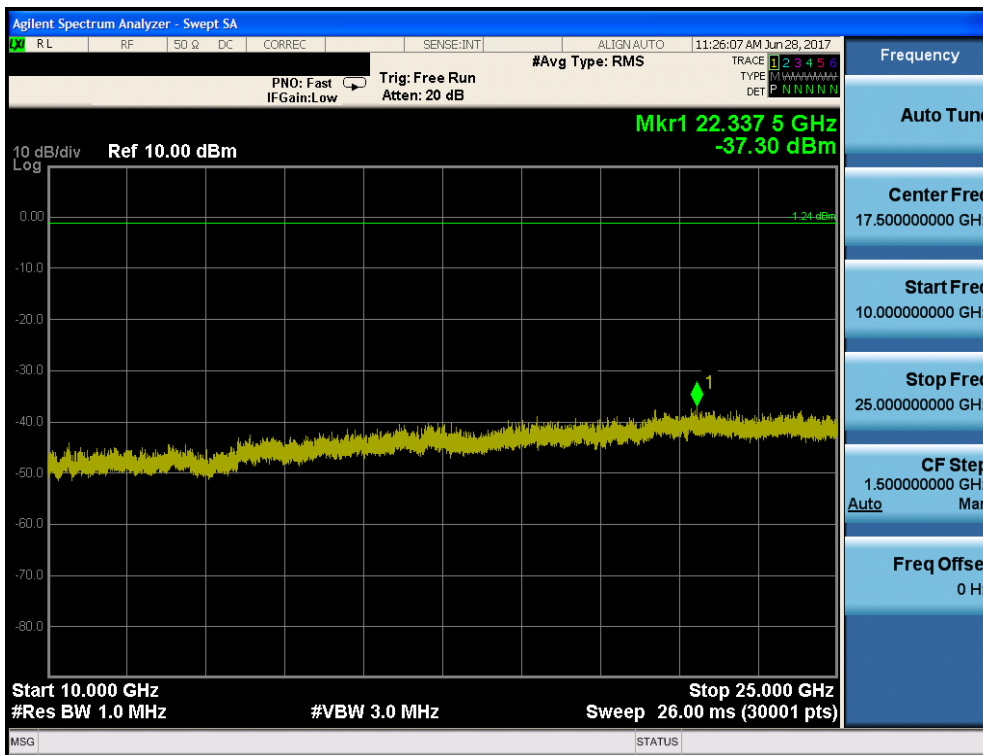

Plot 7-52. Conducted Spurious Plot (Bluetooth, GFSK, ePA – Ch. 39)

FCC ID: BCG-A1858		FCC Pt. 15.247 BLUETOOTH TEST REPORT (CERTIFICATION)	Approved by: Quality Manager
Test Report S/N: 1C1706160002-58-04-R3.BCG	Test Dates: 6/9-8/9/2017	EUT Type: Watch	Page 52 of 80

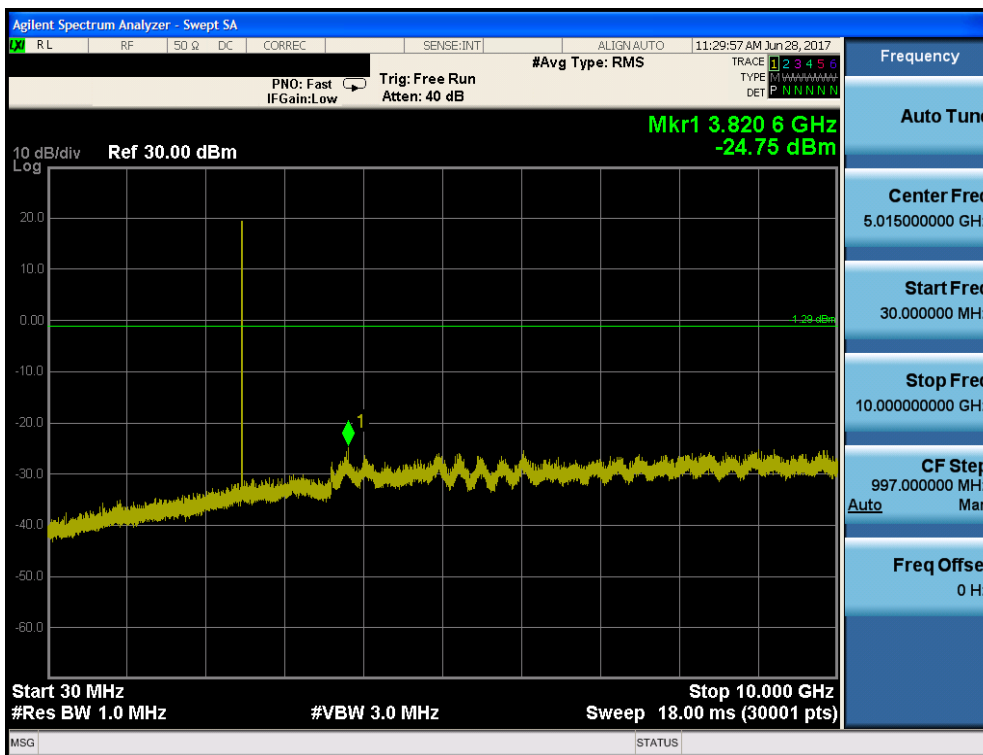

Plot 7-53. Conducted Spurious Plot (Bluetooth, GFSK, ePA – Ch. 78)

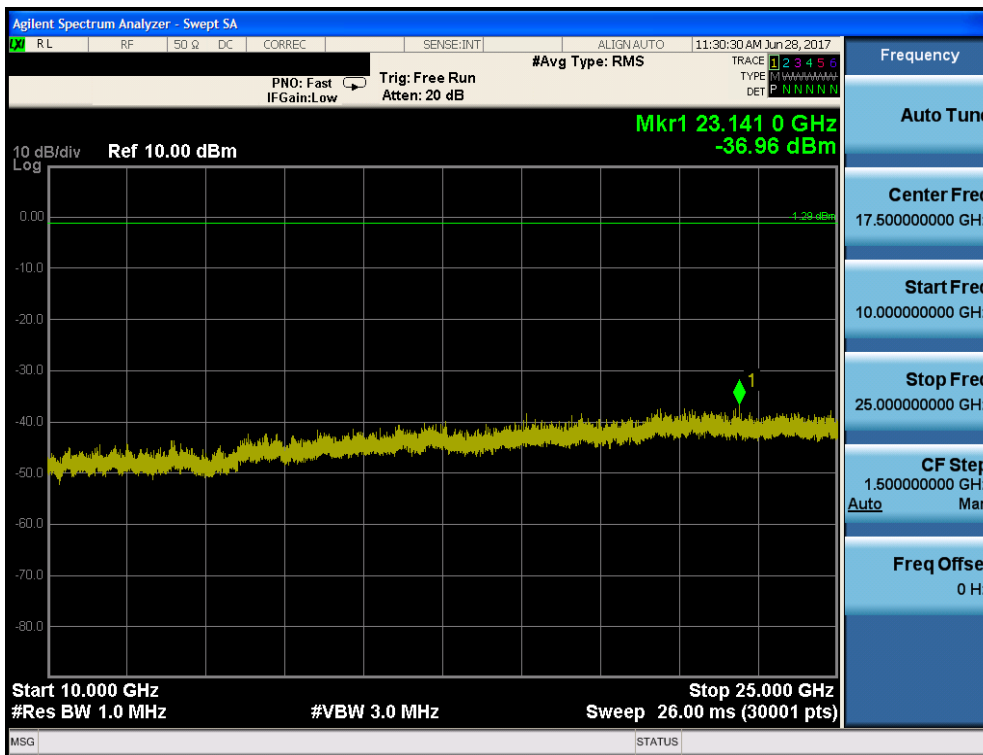

Plot 7-54. Conducted Spurious Plot (Bluetooth, GFSK, ePA – Ch. 78)

FCC ID: BCG-A1858	PCTEST ENGINEERING LABORATORY, INC.	FCC Pt. 15.247 BLUETOOTH TEST REPORT (CERTIFICATION)	Approved by: Quality Manager
Test Report S/N: 1C1706160002-58-04-R3.BCG	Test Dates: 6/9-8/9/2017	EUT Type: Watch	Page 53 of 80

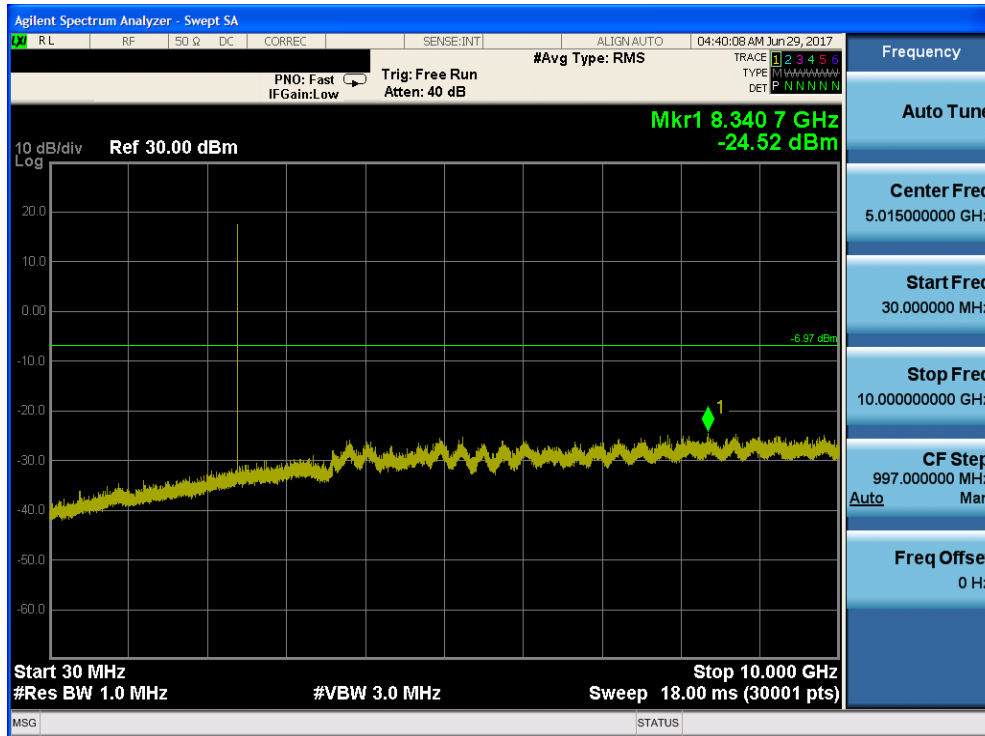

Plot 7-55. Conducted Spurious Plot (Bluetooth, 8DPSK, ePA – Ch. 0)

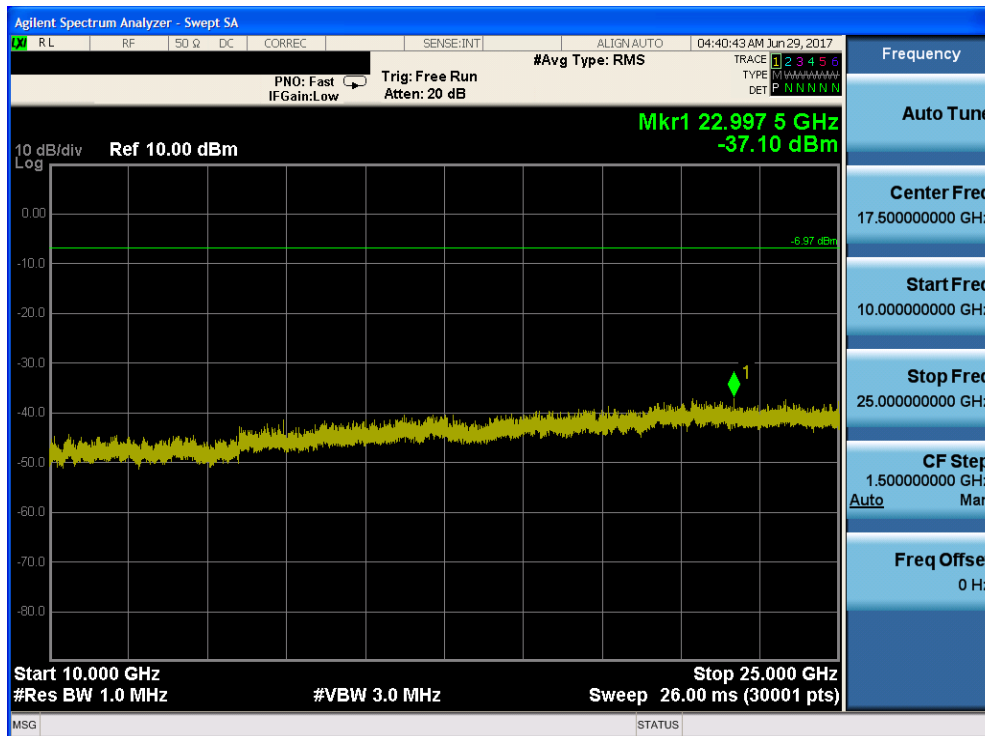

Plot 7-56. Conducted Spurious Plot (Bluetooth, 8DPSK, ePA – Ch. 0)

FCC ID: BCG-A1858		FCC Pt. 15.247 BLUETOOTH TEST REPORT (CERTIFICATION)	Approved by: Quality Manager
Test Report S/N: 1C1706160002-58-04-R3.BCG	Test Dates: 6/9-8/9/2017	EUT Type: Watch	Page 54 of 80

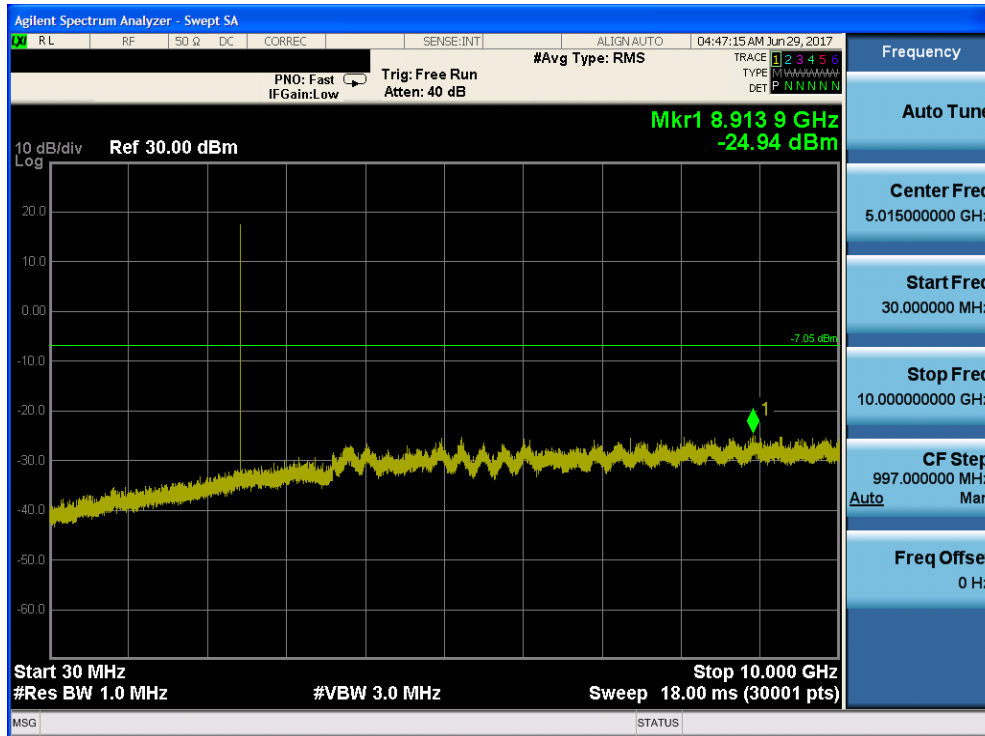

Plot 7-57. Conducted Spurious Plot (Bluetooth, 8DPSK, ePA – Ch. 39)

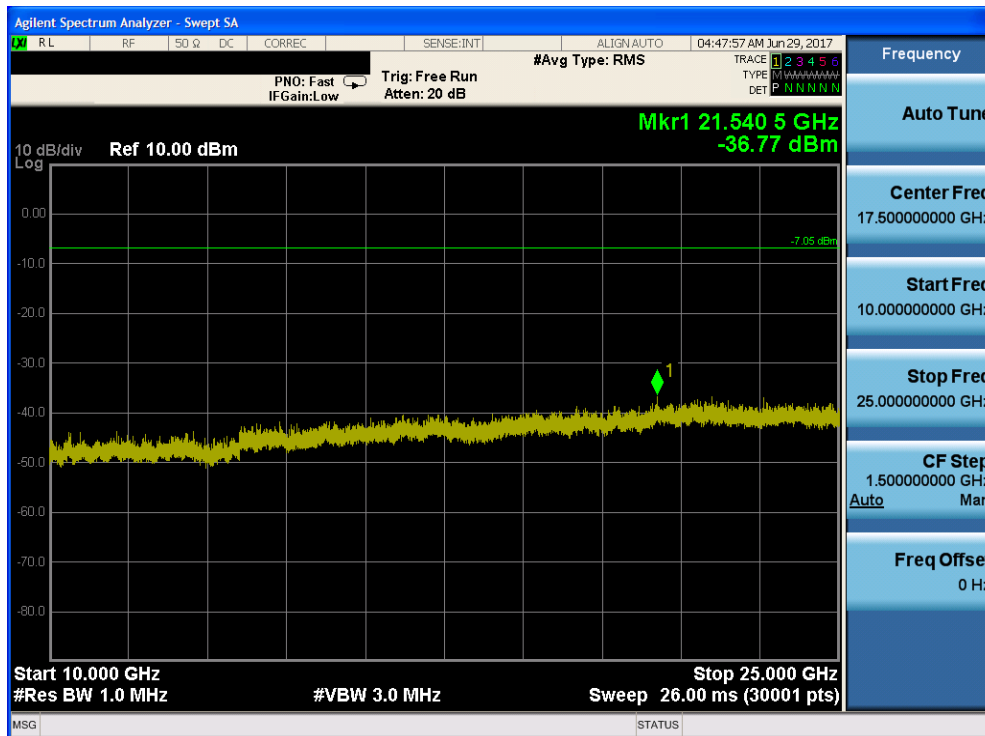

Plot 7-58. Conducted Spurious Plot (Bluetooth, 8DPSK, ePA – Ch. 39)

FCC ID: BCG-A1858	PCTEST ENGINEERING LABORATORY, INC.	FCC Pt. 15.247 BLUETOOTH TEST REPORT (CERTIFICATION)	Approved by: Quality Manager
Test Report S/N: 1C1706160002-58-04-R3.BCG	Test Dates: 6/9-8/9/2017	EUT Type: Watch	Page 55 of 80

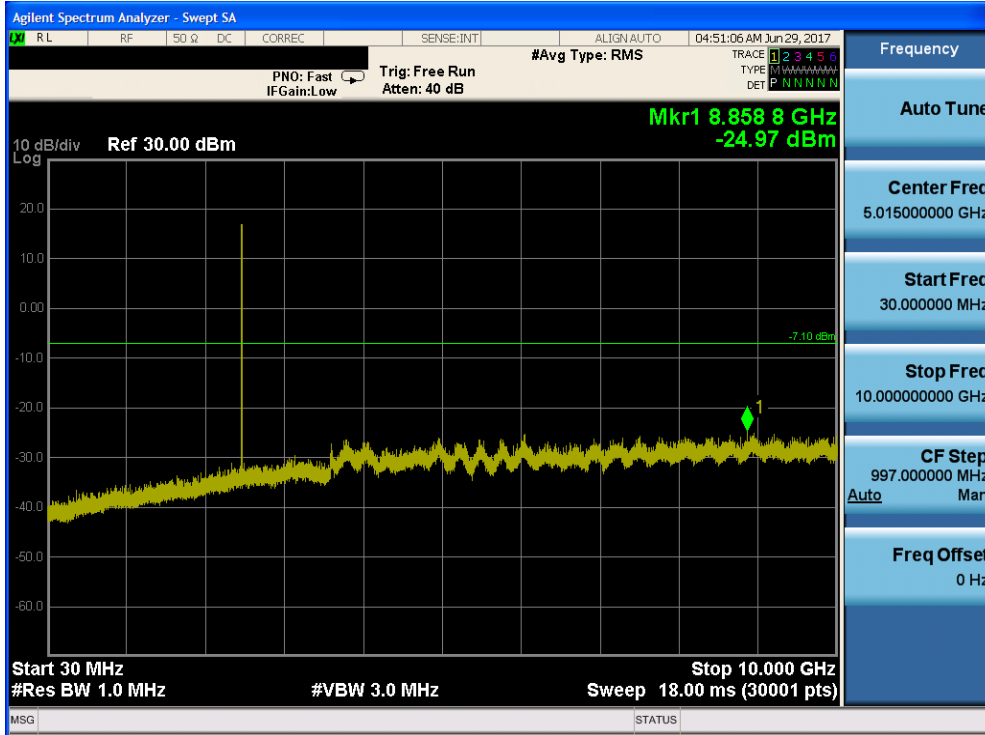

Plot 7-59. Conducted Spurious Plot (Bluetooth, 8DPSK, ePA – Ch. 78)

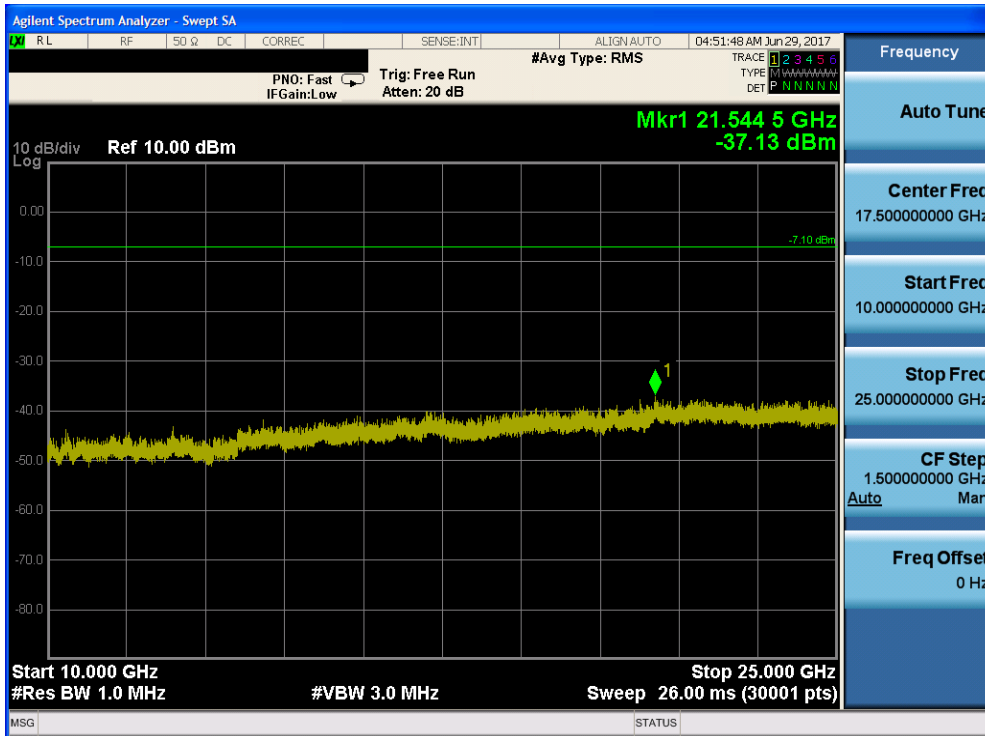

Plot 7-60. Conducted Spurious Plot (Bluetooth, 8DPSK, ePA – Ch. 78)

FCC ID: BCG-A1858		FCC Pt. 15.247 BLUETOOTH TEST REPORT (CERTIFICATION)	Approved by: Quality Manager
Test Report S/N: 1C1706160002-58-04-R3.BCG	Test Dates: 6/9-8/9/2017	EUT Type: Watch	Page 56 of 80

7.9 Radiated Spurious Emission Measurements – Above 1GHz

§15.205 §15.209 §15.247 (d)

Test Overview and Limit

All out of band radiated spurious emissions are measured with a spectrum analyzer connected to a receive antenna while the EUT is operating at maximum power and at the appropriate frequencies. Only the radiated emissions of the configuration that produced the worst case emissions are reported in this section.

All out of band emissions appearing in a restricted band as specified in Section 15.205 of the Title 47 CFR must not exceed the limits shown in Table 7-6 per Section 15.209.

Frequency	Field Strength [$\mu\text{V/m}$]	Measured Distance [Meters]
Above 960.0 MHz	500	3

Table 7-6. Radiated Limits

Test Procedure Used

ANSI C63.10-2013 – Section 6.6.4.3

Test Settings

Average Field Strength Measurements per Section 4.1.4.2.3 of ANSI C63.10-2013

1. Analyzer center frequency was set to the frequency of the radiated spurious emission of interest
2. RBW = 1MHz
3. VBW = 1kHz $\geq 1/\tau$ Hz, where τ = pulse width in seconds
4. Averaging type was set to RMS to ensure that video filtering was applied in the power domain
5. Detector = peak
6. Sweep time = auto
7. Trace mode = max hold
8. Trace was allowed to stabilize

Peak Field Strength Measurements per Section 4.1.4.2.2 of ANSI C63.10-2013

1. Analyzer center frequency was set to the frequency of the radiated spurious emission of interest
2. RBW is set depending on measurement frequency, as specified in Table 7-7 below
3. VBW = 3MHz
4. Detector = peak
5. Sweep time = auto couple
6. Trace mode = max hold
7. Trace was allowed to stabilize

FCC ID: BCG-A1858		FCC Pt. 15.247 BLUETOOTH TEST REPORT (CERTIFICATION)	Approved by: Quality Manager
Test Report S/N: 1C1706160002-58-04-R3.BCG	Test Dates: 6/9-8/9/2017	EUT Type: Watch	Page 57 of 80

Frequency	RBW
9 – 150kHz	200 – 300Hz
0.15 – 30MHz	9 – 10kHz
30 – 1000MHz	100 – 120kHz
> 1000MHz	1MHz

Table 7-7. RBW as a Function of Frequency

Test Setup

The EUT and measurement equipment were set up as shown in the diagram below.

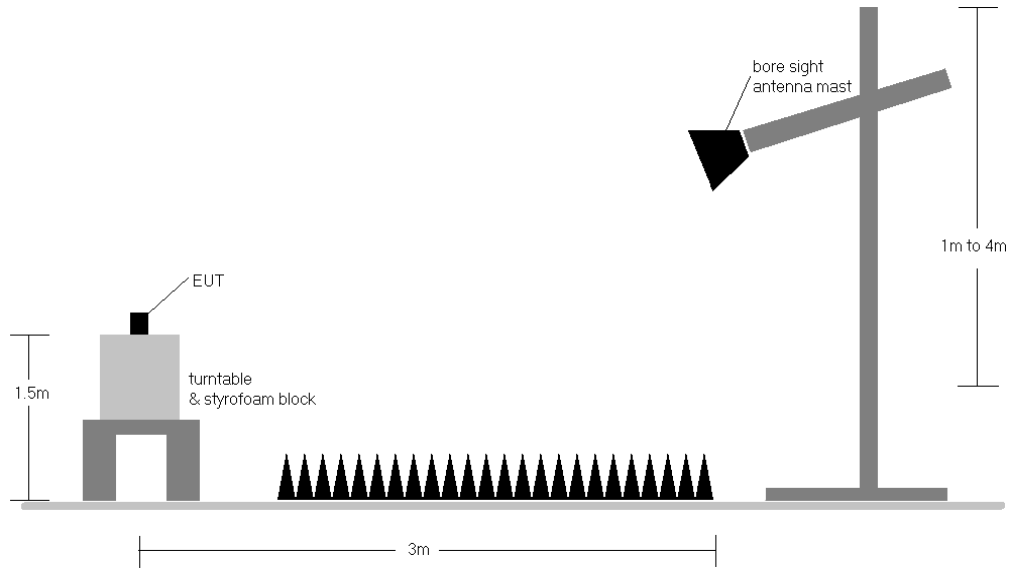



Figure 7-9. Radiated Test Setup >1GHz

Test Notes

3. All emissions lying in restricted bands specified in §15.205 are below the limit shown in Table 7-6.
4. No significant radiated emissions were found in the 2310 - 2390MHz restricted band.
5. The antenna is manipulated through typical positions, polarity and length during the tests. The EUT is manipulated through three orthogonal planes.
6. This unit was tested with its standard battery.
7. The spectrum is measured from 9kHz to the 10th harmonic and the worst-case emissions are reported.
8. The duty cycle correction factor was not applied to noise floor measurements.
9. The wide spectrum spurious emissions plots shown on the following pages are used only for the purpose of emission identification. Any emissions found to be within 20dB of the limit are fully investigated and the results are shown in this section.
10. The "-" shown in the following RSE tables are used to denote a noise floor measurement.
11. All modes and power schemes were investigated but highest radiated spurious emissions are provided.

FCC ID: BCG-A1858		FCC Pt. 15.247 BLUETOOTH TEST REPORT (CERTIFICATION)	Approved by: Quality Manager
Test Report S/N: 1C1706160002-58-04-R3.BCG	Test Dates: 6/9-8/9/2017	EUT Type: Watch	Page 58 of 80

Sample Calculation

- Field Strength Level $_{[dB\mu V/m]} = \text{Analyzer Level }_{[dBm]} + 107 + \text{AFCL }_{[dB/m]} + \text{Duty Cycle Correction }_{[dB]}$
- $\text{AFCL }_{[dB/m]} = \text{Antenna Factor }_{[dB/m]} + \text{Cable Loss }_{[dB]}$
- $\text{Margin }_{[dB]} = \text{Field Strength Level }_{[dB\mu V/m]} - \text{Limit }_{[dB\mu V/m]}$

Duty Cycle Correction Factor Calculation

- Channel hop rate = 800 hops/second (AFH Mode)
- Adjusted channel hop rate for DH5 mode = 133.33 hops/second
- Time per channel hop = $1 / 133.33 \text{ hops/second} = 7.50 \text{ ms}$
- Time to cycle through all channels = $7.50 \times 20 \text{ channels} = 150 \text{ ms}$
- Number of times transmitter hits on one channel = $100 \text{ ms} / 150 \text{ ms} = 1 \text{ time(s)}$
- Worst case dwell time = 7.5 ms
- Duty cycle correction factor = $20\log_{10}(7.5\text{ms}/100\text{ms}) = -22.5 \text{ dB}$

FCC ID: BCG-A1858	 FCC Pt. 15.247 BLUETOOTH TEST REPORT (CERTIFICATION)		Approved by: Quality Manager
Test Report S/N: 1C1706160002-58-04-R3.BCG	Test Dates: 6/9-8/9/2017	EUT Type: Watch	Page 59 of 80

Radiated Spurious Emission Measurements

§15.205 §15.209 §15.247 (d)

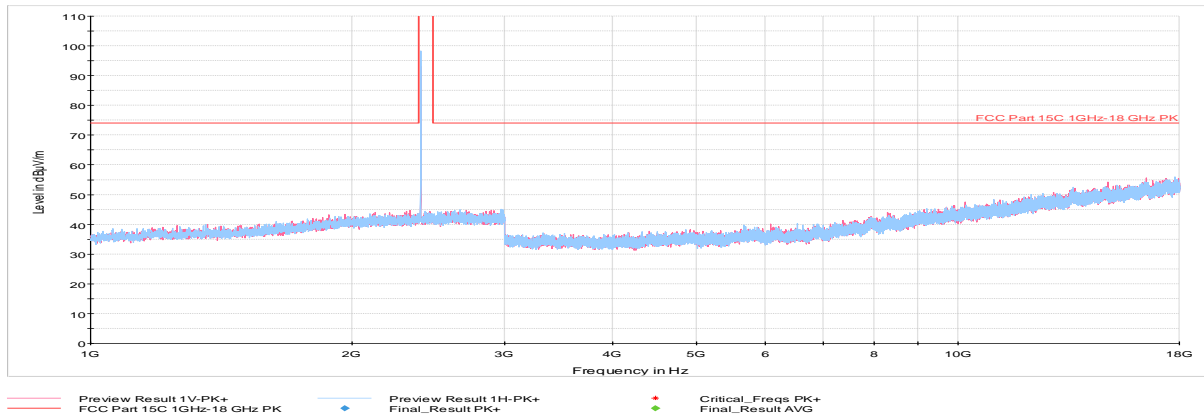

Plot 7-61. Radiated Spurious Plot above 1GHz (BT ePA – Ch. 0, Ant. Pol. H & V)

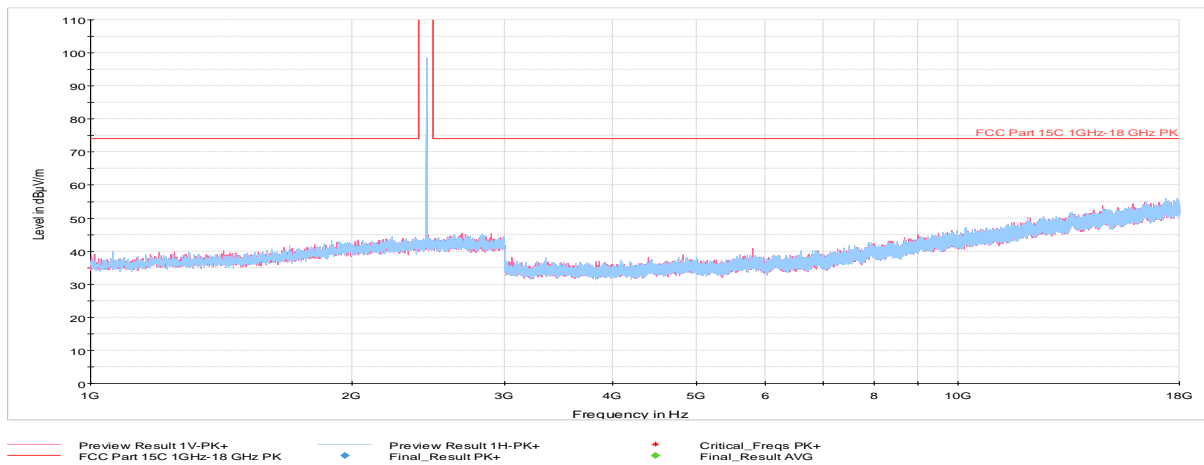

Plot 7-62. Radiated Spurious Plot above 1GHz (BT ePA – Ch. 39, Ant. Pol. H & V)

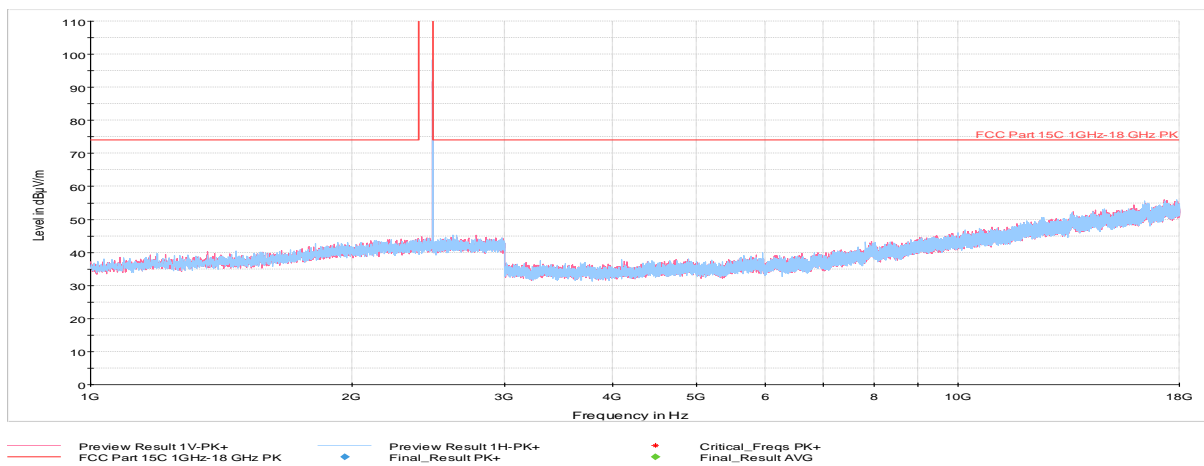

Plot 7-63. Radiated Spurious Plot above 1GHz (BT ePA – Ch. 78, Ant. Pol. H & V)

FCC ID: BCG-A1858		FCC Pt. 15.247 BLUETOOTH TEST REPORT (CERTIFICATION)	Approved by: Quality Manager
Test Report S/N: 1C1706160002-58-04-R3.BCG	Test Dates: 6/9-8/9/2017	EUT Type: Watch	Page 60 of 80

Radiated Spurious Emissions Measurements (Above 18GHz)

§15.209

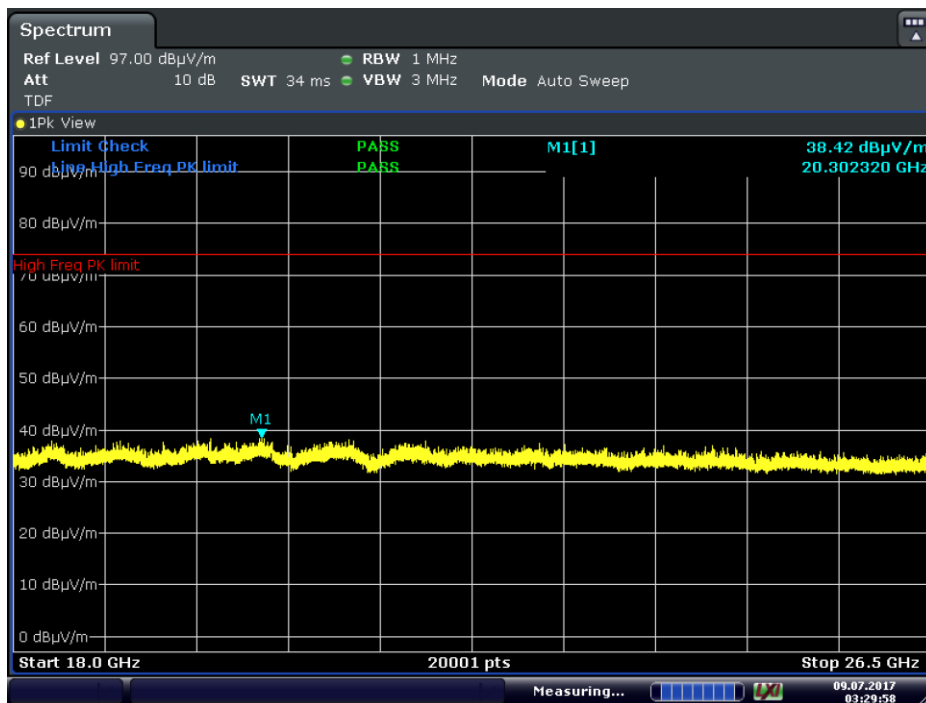

Date: 9.JUL.2017 03:29:59

Plot 7-64. Radiated Spurious Plot above 18GHz (GFSK ePA, Pol. H)

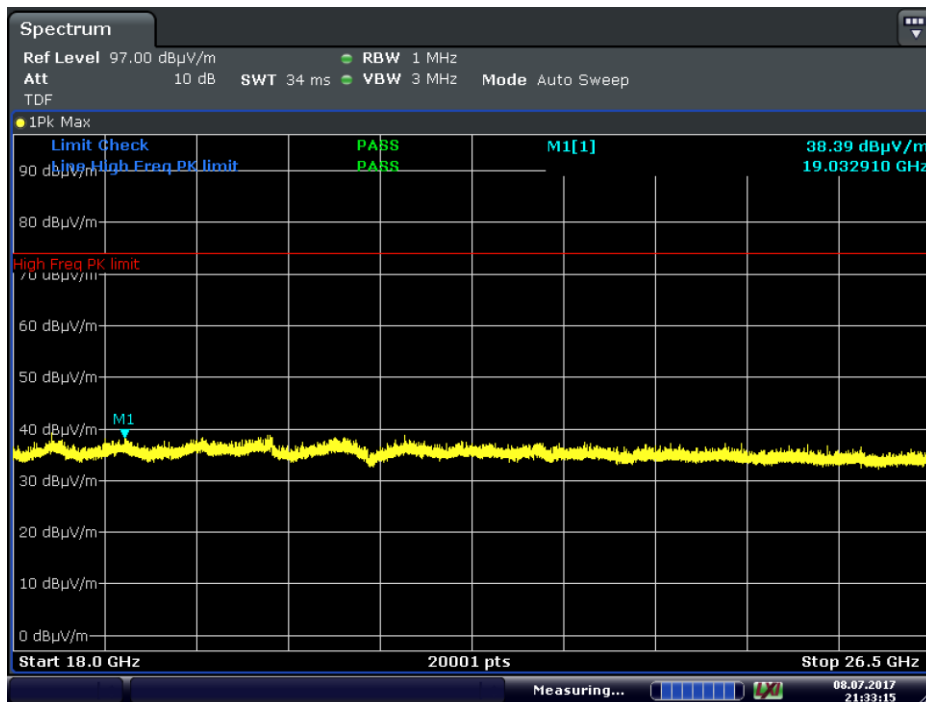

Date: 8.JUL.2017 21:33:14

Plot 7-65. Radiated Spurious Plot above 18GHz (GFSK ePA, Pol. V)

FCC ID: BCG-A1858		FCC Pt. 15.247 BLUETOOTH TEST REPORT (CERTIFICATION)	Approved by: Quality Manager
Test Report S/N: 1C1706160002-58-04-R3.BCG	Test Dates: 6/9-8/9/2017	EUT Type: Watch	Page 61 of 80

Radiated Spurious Emission Measurements

§15.205 §15.209 §15.247 (d)

Worst Case Mode: Bluetooth
 Worst Case Modulation: GFSK
 Worst Case Power Scheme: ePA
 Measurement Distance: 3 Meters
 Operating Frequency: 2402MHz
 Channel: 0

Frequency [MHz]	Detector	Ant. Pol. [H/V]	Antenna Height [cm]	Turntable Azimuth [degree]	Analyzer Level [dBm]	AFCL [dB/m]	Field Strength [dBµV/m]	Limit [dBµV/m]	Margin [dB]
4804.00	Avg	V	-	-	-78.46	0.08	28.62	53.98	-25.35
4804.00	Peak	V	-	-	-64.85	0.08	42.23	73.98	-31.74
12010.00	Avg	V	-	-	-79.86	14.07	41.21	53.98	-12.77
12010.00	Peak	V	-	-	-66.55	14.07	54.52	73.98	-19.46

Table 7-8. Radiated Measurements

Worst Case Mode: Bluetooth
 Worst Case Modulation: GFSK
 Worst Case Power Scheme: ePA
 Measurement Distance: 3 Meters
 Operating Frequency: 2441MHz
 Channel: 39

Frequency [MHz]	Detector	Ant. Pol. [H/V]	Antenna Height [cm]	Turntable Azimuth [degree]	Analyzer Level [dBm]	AFCL [dB/m]	Field Strength [dBµV/m]	Limit [dBµV/m]	Margin [dB]
4882.00	Avg	V	-	-	-78.61	0.73	29.12	53.98	-24.86
4882.00	Peak	V	-	-	-65.08	0.73	42.65	73.98	-31.33
7323.00	Avg	V	-	-	-79.75	5.54	32.79	53.98	-21.19
7323.00	Peak	V	-	-	-66.35	5.54	46.19	73.98	-27.79
12205.00	Avg	V	-	-	-80.01	14.29	41.28	53.98	-12.70
12205.00	Peak	V	-	-	-66.67	14.29	54.62	73.98	-19.36

Table 7-9. Radiated Measurements

FCC ID: BCG-A1858			FCC Pt. 15.247 BLUETOOTH TEST REPORT (CERTIFICATION)	Approved by: Quality Manager
Test Report S/N: 1C1706160002-58-04-R3.BCG	Test Dates: 6/9-8/9/2017	EUT Type: Watch	Page 62 of 80	

Radiated Spurious Emission Measurements

§15.205 §15.209 §15.247 (d)

Worst Case Mode: Bluetooth
 Worst Case Modulation: GFSK
 Worst Case Power Scheme: ePA
 Measurement Distance: 3 Meters
 Operating Frequency: 2480MHz
 Channel: 78

Frequency [MHz]	Detector	Ant. Pol. [H/V]	Antenna Height [cm]	Turntable Azimuth [degree]	Analyzer Level [dBm]	AFCL [dB/m]	Field Strength [dBµV/m]	Limit [dBµV/m]	Margin [dB]
4960.00	Avg	V	-	-	-78.19	0.39	29.20	53.98	-24.78
4960.00	Peak	V	-	-	-64.79	0.39	42.60	73.98	-31.38
7440.00	Avg	V	-	-	-79.81	5.67	32.86	53.98	-21.12
7440.00	Peak	V	-	-	-66.31	5.67	46.36	73.98	-27.62
12400.00	Avg	V	-	-	-80.07	14.85	41.78	53.98	-12.20
12400.00	Peak	V	-	-	-66.66	14.85	55.19	73.98	-18.79

Table 7-10. Radiated Measurements

FCC ID: BCG-A1858		FCC Pt. 15.247 BLUETOOTH TEST REPORT (CERTIFICATION)		Approved by: Quality Manager
Test Report S/N: 1C1706160002-58-04-R3.BCG	Test Dates: 6/9-8/9/2017	EUT Type: Watch		Page 63 of 80

7.10 Radiated Restricted Band Edge Measurements

§15.205 §15.209 §15.247 (d)

The radiated restricted band edge measurements are measured with an EMI test receiver connected to the receive antenna while the EUT is transmitting. Two different amplitude offsets were used depending on whether peak or average measurements were measured. The average measurements use a duty cycle correction factor (DCCF).

The amplitude offset shown in the following plots for average measurements was calculated using the formula:

$$\text{Offset (dB)} = (\text{Antenna Factor} + \text{Cable Loss} + \text{Attenuator}) - \text{Preamplifier Gain} + \text{DCCF}$$

Worst Case Mode:	Bluetooth
Worst Case Modulation:	GFSK
Worst Case Power Scheme:	ePA
Measurement Distance:	3 Meters
Operating Frequency:	2402MHz
Channel:	0

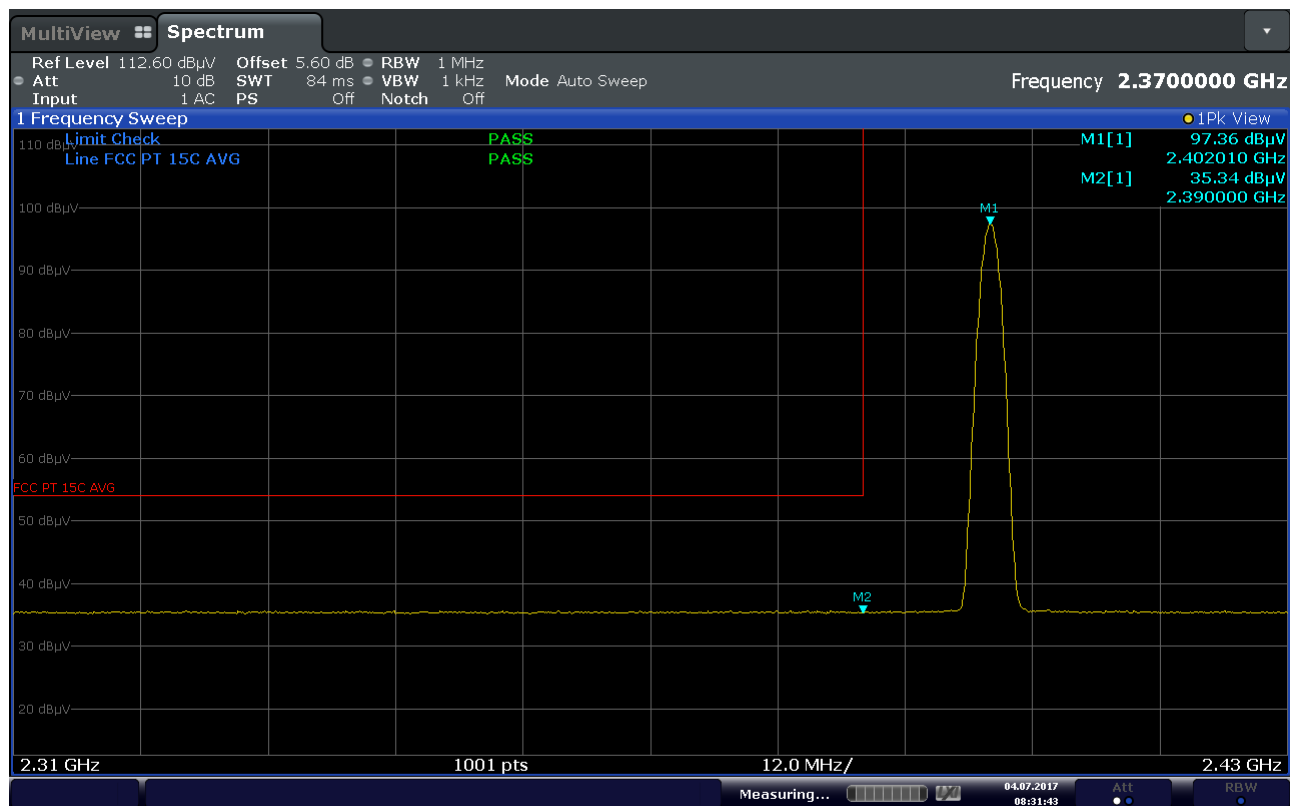

Date: 4 JUL 2017 08:31:42

Plot 7-66. Radiated Restricted Lower Band Edge Measurement (Average)

FCC ID: BCG-A1858	PCTEST ENGINEERING LABORATORY, INC.	FCC Pt. 15.247 BLUETOOTH TEST REPORT (CERTIFICATION)	Approved by: Quality Manager
Test Report S/N: 1C1706160002-58-04-R3.BCG	Test Dates: 6/9-8/9/2017	EUT Type: Watch	Page 64 of 80

Radiated Restricted Band Edge Measurements §15.205 §15.209 §15.247 (d)

The amplitude offset shown in the following plots for peak measurements was calculated using the formula:

$$\text{Offset (dB)} = (\text{Antenna Factor} + \text{Cable Loss} + \text{Attenuator}) - \text{Preamplifier Gain}$$

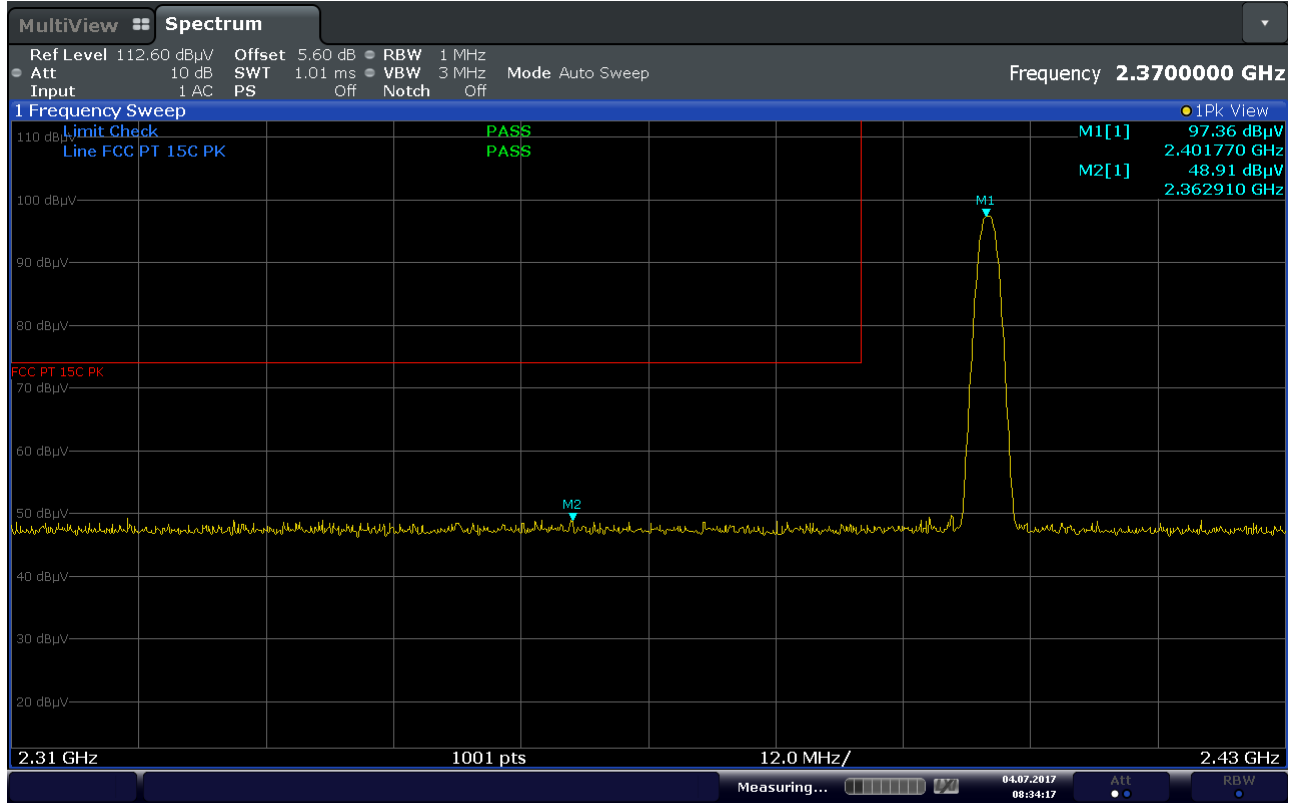

Date: 4.JUL.2017 08:34:16

Plot 7-67. Radiated Restricted Lower Band Edge Measurement (Peak)

FCC ID: BCG-A1858	PCTEST ENGINEERING LABORATORY, INC.	FCC Pt. 15.247 BLUETOOTH TEST REPORT (CERTIFICATION)	Approved by: Quality Manager
Test Report S/N: 1C1706160002-58-04-R3.BCG	Test Dates: 6/9-8/9/2017	EUT Type: Watch	Page 65 of 80

Radiated Restricted Band Edge Measurements

§15.205 §15.209 §15.247 (d)

The amplitude offset shown in the following plots for peak measurements was calculated using the formula:

$$\text{Offset (dB)} = (\text{Antenna Factor} + \text{Cable Loss} + \text{Attenuator}) - \text{Preamplifier Gain}$$

Worst Case Mode:	Bluetooth
Worst Case Modulation:	8DPSK
Worst Case Power Scheme:	ePA
Measurement Distance:	3 Meters
Operating Frequency:	2402MHz
Channel:	0

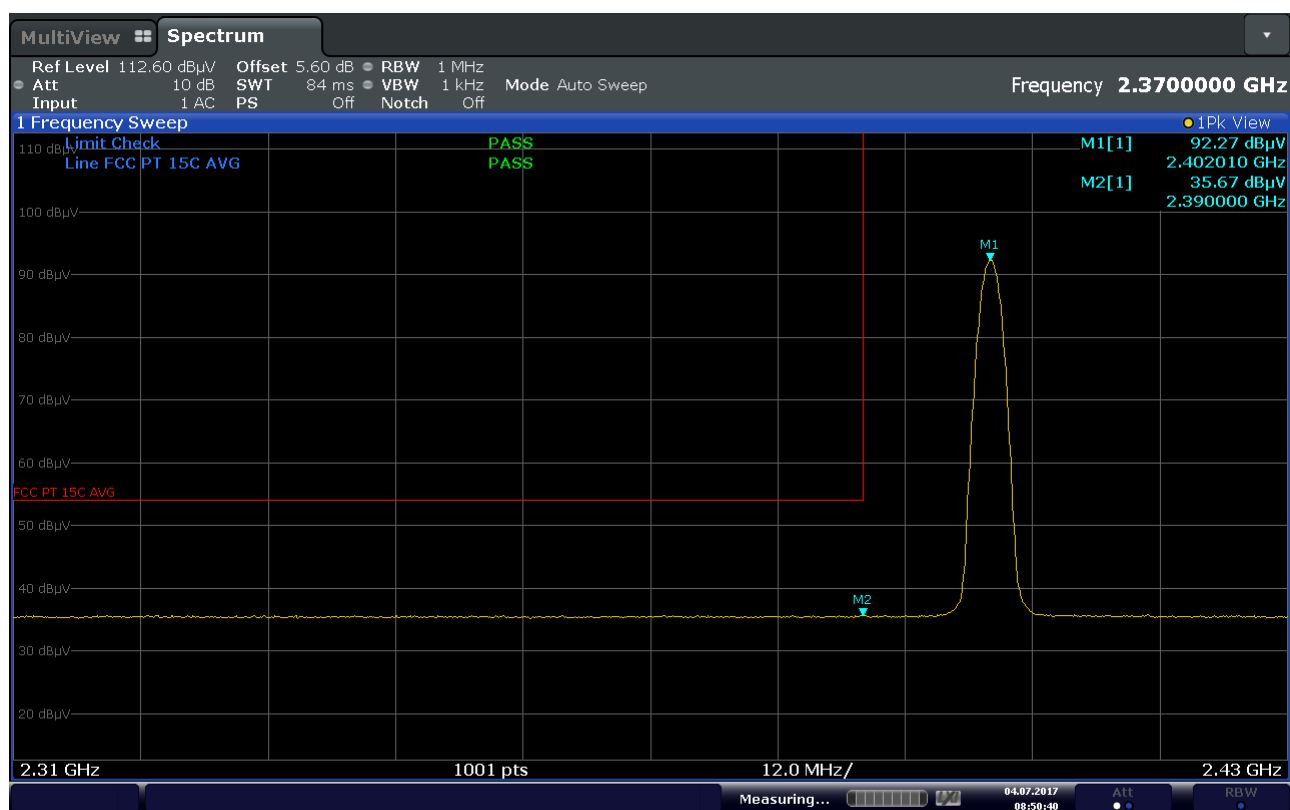

Date: 4.JUL.2017 08:50:40

Plot 7-68. Radiated Restricted Lower Band Edge Measurement (Average)

FCC ID: BCG-A1858	FCC Pt. 15.247 BLUETOOTH TEST REPORT (CERTIFICATION)	Approved by: Quality Manager
Test Report S/N: 1C1706160002-58-04-R3.BCG	Test Dates: 6/9-8/9/2017	EUT Type: Watch
© 2017 PCTEST Engineering Laboratory, Inc.		Page 66 of 80

Radiated Restricted Band Edge Measurements

§15.205 §15.209 §15.247 (d)

The amplitude offset shown in the following plots for peak measurements was calculated using the formula:

$$\text{Offset (dB)} = (\text{Antenna Factor} + \text{Cable Loss} + \text{Attenuator}) - \text{Preamplifier Gain}$$

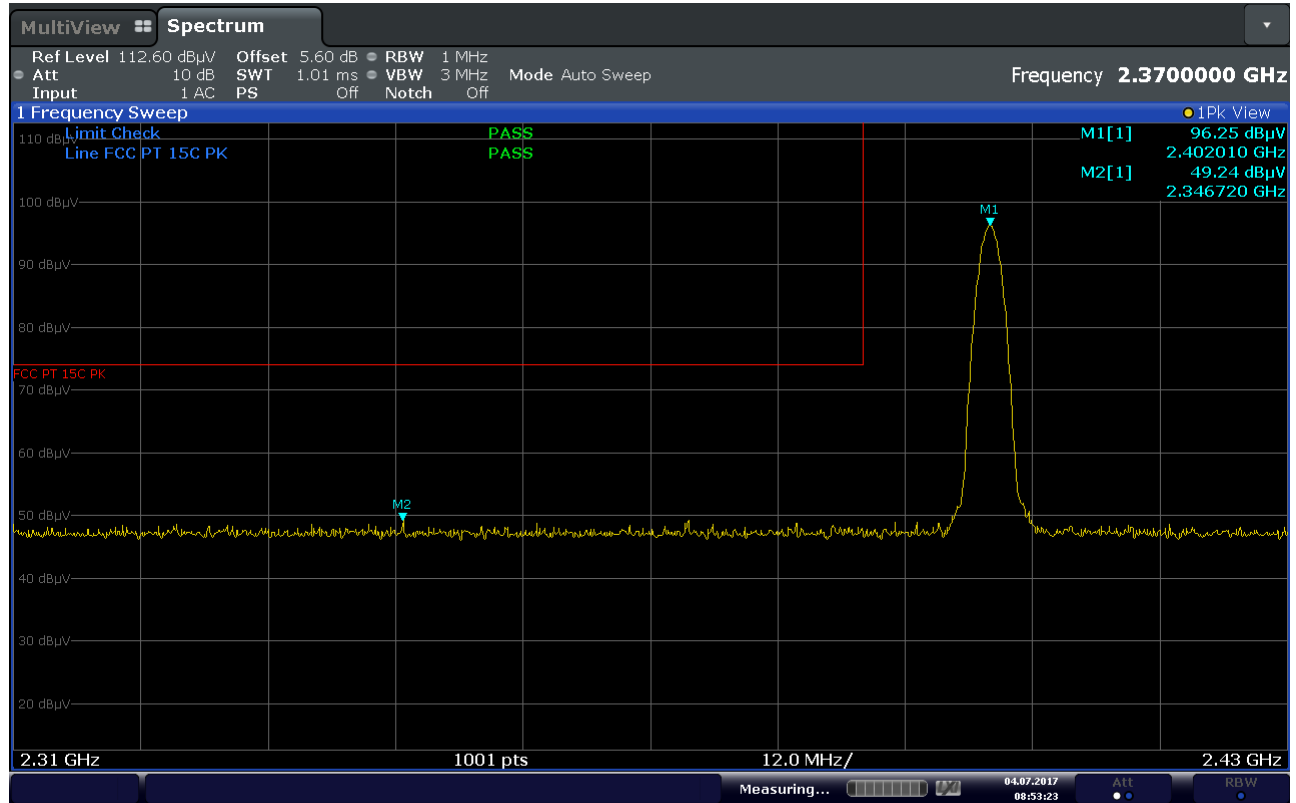

Date: 4.JUL.2017 08:53:22

Plot 7-69. Radiated Restricted Lower Band Edge Measurement (Peak)

FCC ID: BCG-A1858	PCTEST ENGINEERING LABORATORY, INC.	FCC Pt. 15.247 BLUETOOTH TEST REPORT (CERTIFICATION)	Approved by: Quality Manager
Test Report S/N: 1C1706160002-58-04-R3.BCG	Test Dates: 6/9-8/9/2017	EUT Type: Watch	Page 67 of 80

Radiated Restricted Band Edge Measurements §15.205 §15.209 §15.247 (d)

Worst Case Mode: Bluetooth
 Worst Case Modulation: GFSK
 Worst Case Power Scheme: ePA
 Measurement Distance: 3 Meters
 Operating Frequency: 2480MHz
 Channel: 78

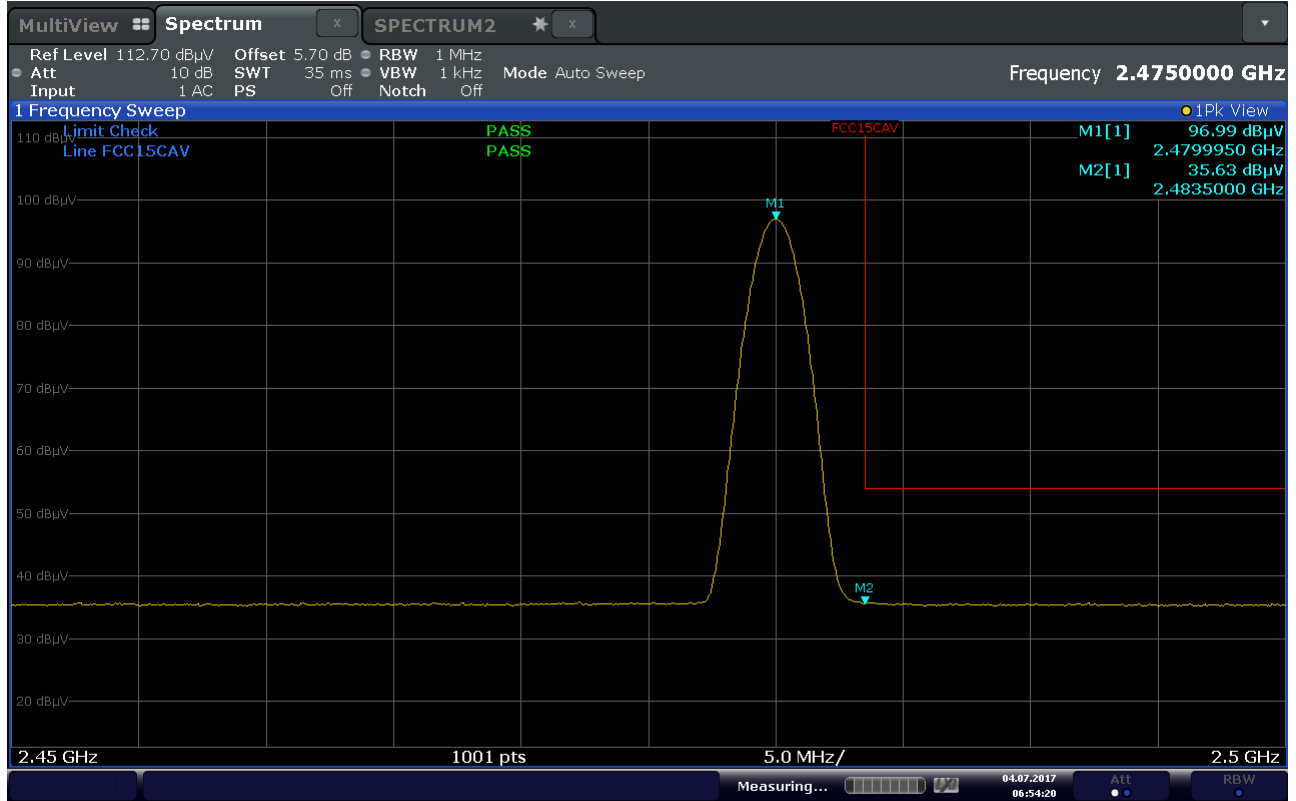

Date: 4 JUL 2017 06:54:20

Plot 7-70. Radiated Restricted Upper Band Edge Measurement (Average)

FCC ID: BCG-A1858	PCTEST ENGINEERING LABORATORY, INC.	FCC Pt. 15.247 BLUETOOTH TEST REPORT (CERTIFICATION)	Approved by: Quality Manager
Test Report S/N: 1C1706160002-58-04-R3.BCG	Test Dates: 6/9-8/9/2017	EUT Type: Watch	Page 68 of 80

Radiated Restricted Band Edge Measurements

§15.205 §15.209 §15.247 (d)

The amplitude offset shown in the following plots for peak measurements was calculated using the formula:

$$\text{Offset (dB)} = (\text{Antenna Factor} + \text{Cable Loss} + \text{Attenuator}) - \text{Preamplifier Gain}$$

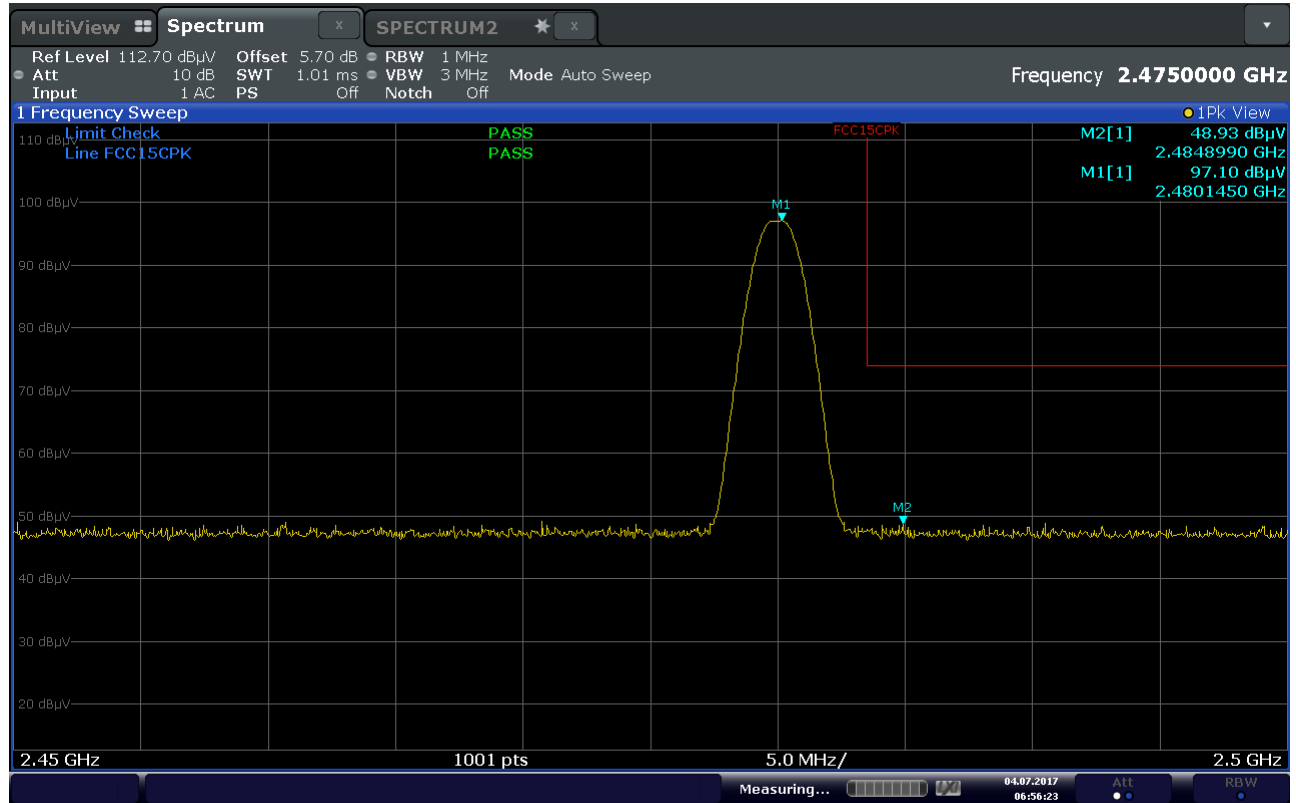

Date: 4.JUL.2017 06:56:23

Plot 7-71. Radiated Restricted Upper Band Edge Measurement (Peak)

FCC ID: BCG-A1858		FCC Pt. 15.247 BLUETOOTH TEST REPORT (CERTIFICATION)	Approved by: Quality Manager
Test Report S/N: 1C1706160002-58-04-R3.BCG	Test Dates: 6/9-8/9/2017	EUT Type: Watch	Page 69 of 80

Radiated Restricted Band Edge Measurements

§15.205 §15.209 §15.247 (d)

The amplitude offset shown in the following plots for peak measurements was calculated using the formula:

$$\text{Offset (dB)} = (\text{Antenna Factor} + \text{Cable Loss} + \text{Attenuator}) - \text{Preamplifier Gain}$$

Worst Case Mode:	Bluetooth
Worst Case Modulation:	8DPSK
Worst Case Power Scheme:	ePA
Measurement Distance:	3 Meters
Operating Frequency:	2480MHz
Channel:	78

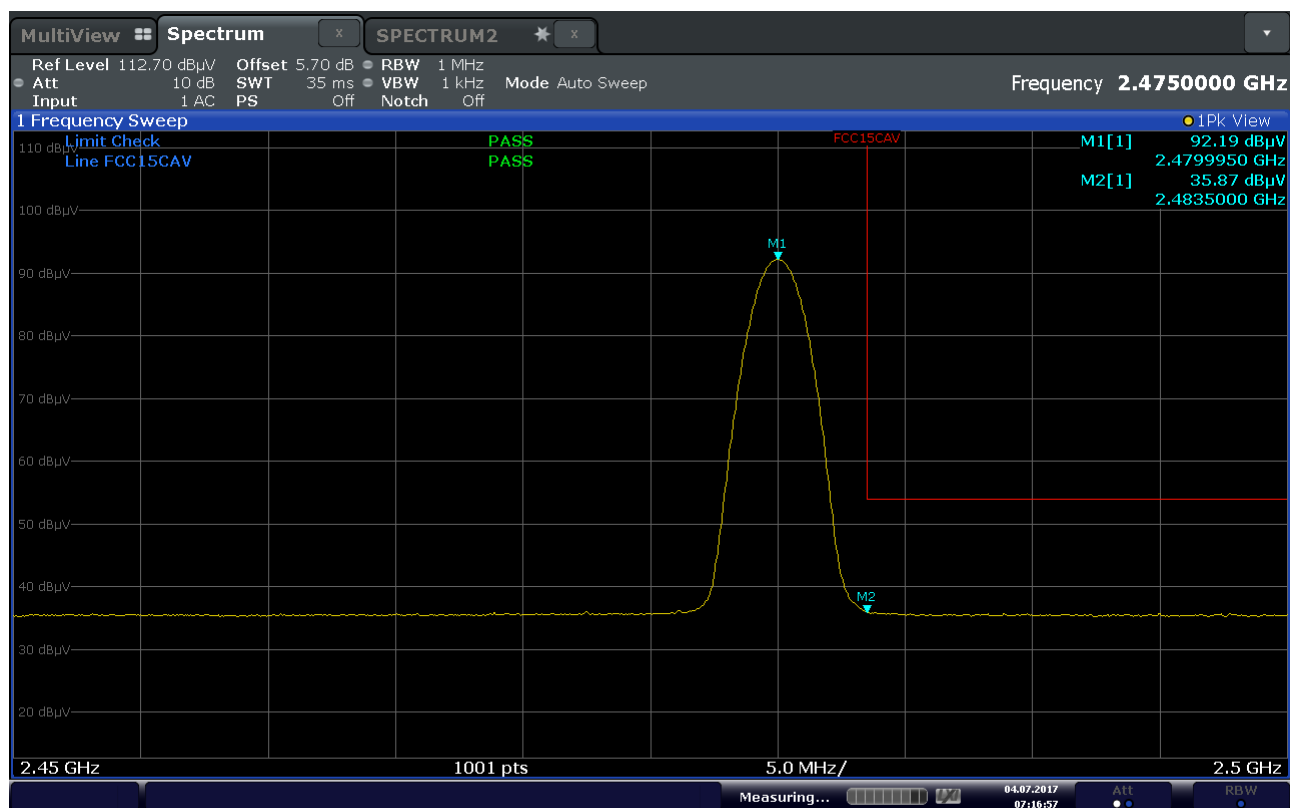

Date: 4.JUL.2017 07:16:57

Plot 7-72. Radiated Restricted Upper Band Edge Measurement (Average)

FCC ID: BCG-A1858		FCC Pt. 15.247 BLUETOOTH TEST REPORT (CERTIFICATION)	Approved by: Quality Manager
Test Report S/N: 1C1706160002-58-04-R3.BCG	Test Dates: 6/9-8/9/2017	EUT Type: Watch	Page 70 of 80

Radiated Restricted Band Edge Measurements

§15.205 §15.209 §15.247 (d)

The amplitude offset shown in the following plots for peak measurements was calculated using the formula:

$$\text{Offset (dB)} = (\text{Antenna Factor} + \text{Cable Loss} + \text{Attenuator}) - \text{Preamplifier Gain}$$

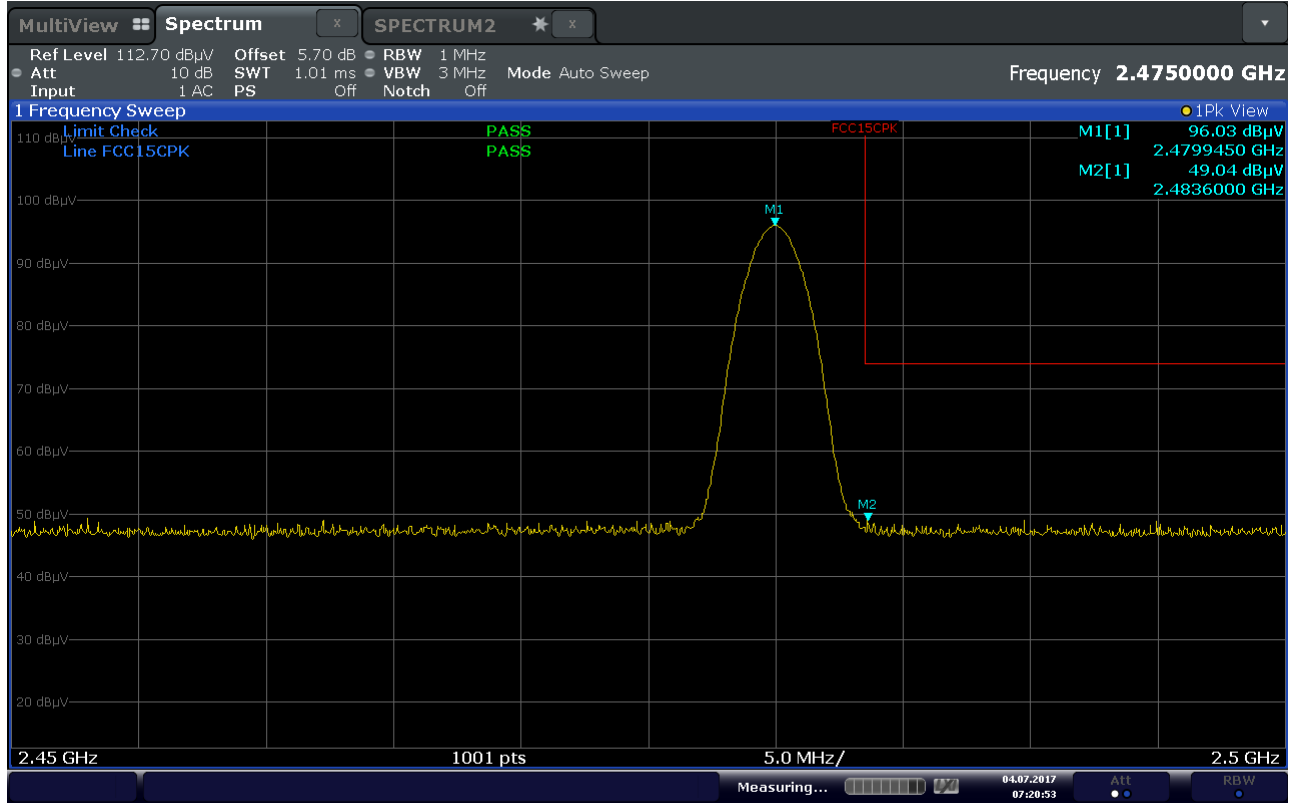

Date: 4.JUL.2017 07:20:53

Plot 7-73. Radiated Restricted Upper Band Edge Measurement (Peak)

FCC ID: BCG-A1858	PCTEST ENGINEERING LABORATORY, INC.	FCC Pt. 15.247 BLUETOOTH TEST REPORT (CERTIFICATION)	Approved by: Quality Manager
Test Report S/N: 1C1706160002-58-04-R3.BCG	Test Dates: 6/9-8/9/2017	EUT Type: Watch	Page 71 of 80

7.11 Radiated Spurious Emissions Measurements – Below 1GHz

§15.209

Test Overview and Limit

All out of band radiated spurious emissions are measured with a spectrum analyzer connected to a receive antenna while the EUT is operating at its maximum duty cycle, at maximum power, and at the appropriate frequencies. All data rates and modes were investigated for radiated spurious emissions. Only the radiated emissions of the configuration that produced the worst case emissions are reported in this section.

All out of band emissions appearing in a restricted band as specified in Section 15.205 of the Title 47 CFR must not exceed the limits shown in Table 7-11 per Section 15.209.

Frequency	Field Strength [$\mu\text{V/m}$]	Measured Distance [Meters]
0.009 – 0.490 MHz	2400/F (kHz)	300
0.490 – 1.705 MHz	24000/F (kHz)	30
1.705 – 30.00 MHz	30	30
30.00 – 88.00 MHz	100	3
88.00 – 216.0 MHz	150	3
216.0 – 960.0 MHz	200	3
Above 960.0 MHz	500	3

Table 7-11. Radiated Limits

Test Procedures Used

ANSI C63.10-2013

Test Settings

Quasi-Peak Field Strength Measurements

1. Analyzer center frequency was set to the frequency of the radiated spurious emission of interest
2. RBW = 120kHz (for emissions from 30MHz – 1GHz)
3. Detector = quasi-peak
4. Sweep time = auto couple
5. Trace mode = max hold
6. Trace was allowed to stabilize

FCC ID: BCG-A1858		FCC Pt. 15.247 BLUETOOTH TEST REPORT (CERTIFICATION)	Approved by: Quality Manager
Test Report S/N: 1C1706160002-58-04-R3.BCG	Test Dates: 6/9-8/9/2017	EUT Type: Watch	Page 72 of 80

Test Setup

The EUT and measurement equipment were set up as shown in the diagrams below.

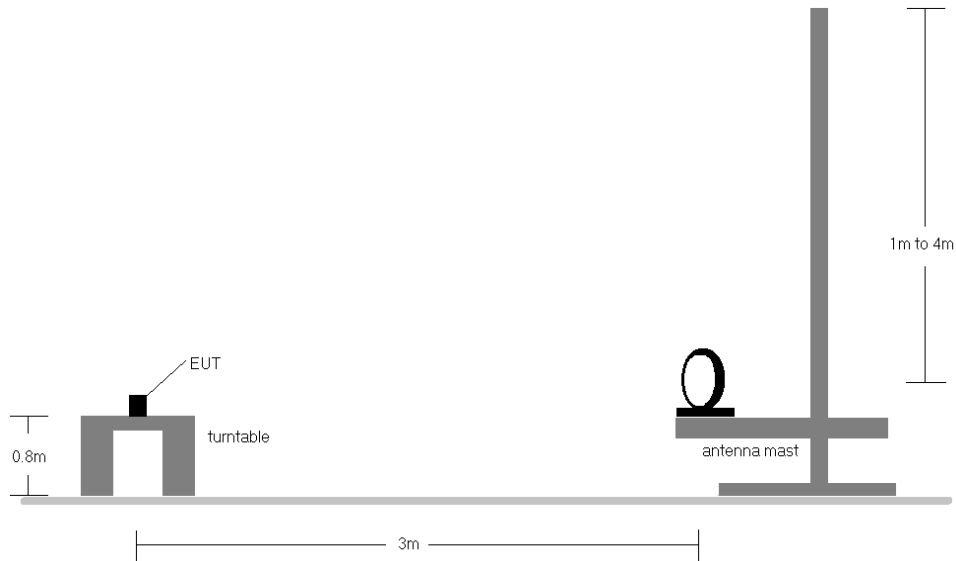

Figure 7-10. Radiated Test Setup < 30Mhz

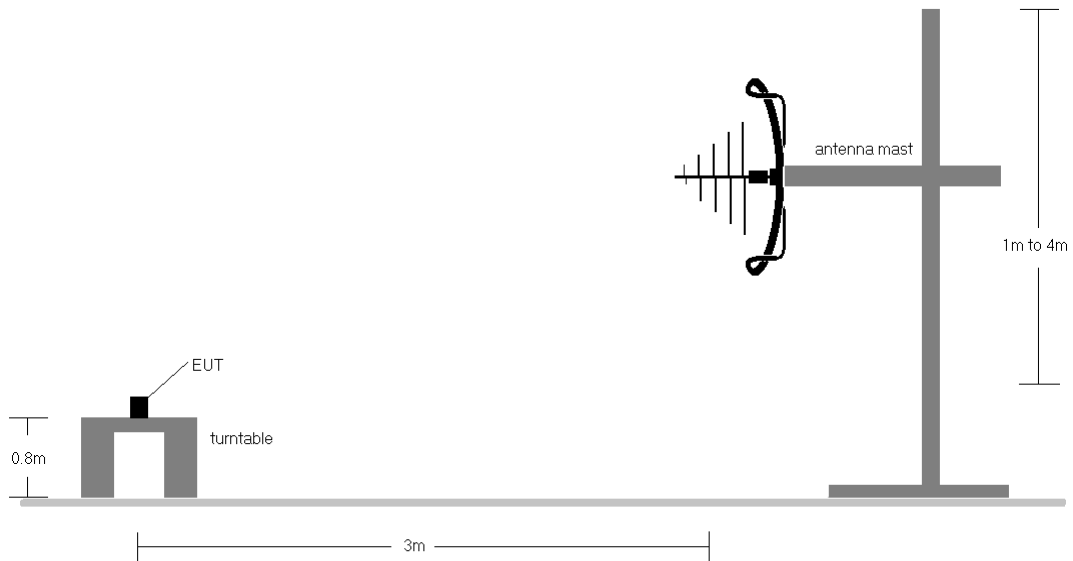



Figure 7-11. Radiated Test Setup < 1GHz

FCC ID: BCG-A1858		FCC Pt. 15.247 BLUETOOTH TEST REPORT (CERTIFICATION)	Approved by: Quality Manager
Test Report S/N: 1C1706160002-58-04-R3.BCG	Test Dates: 6/9-8/9/2017	EUT Type: Watch	Page 73 of 80

Test Notes

1. All emissions lying in restricted bands specified in §15.205 are below the limit shown in Table 7-11.
2. The broadband receive antenna is manipulated through vertical and horizontal polarizations during the tests. The EUT is manipulated through three orthogonal planes.
3. This unit was tested with its standard battery.
4. The spectrum is investigated using a peak detector and final measurements are recorded using CISPR quasi peak detector. The worst-case emissions are reported however emissions whose levels were not within 20dB of the respective limits were not reported.
5. Emissions were measured at a 3 meter test distance.
6. Emissions are investigated while operating on the center channel of the mode, band, and modulation that produced the worst case results during the transmitter spurious emissions testing.
7. No spurious emissions were detected within 20dB of the limit below 30MHz.
8. The results recorded using the broadband antenna is known to correlate with the results obtained by using a tuned dipole with an acceptable degree of accuracy. The VSWR for the measurement antenna was found to be less than 2:1.
9. The wide spectrum spurious emissions plots shown on the following pages are used only for the purpose of emission identification. There were no emissions detected in the 30MHz – 1GHz frequency range, as shown in the subsequent plots.

FCC ID: BCG-A1858	 FCC Pt. 15.247 BLUETOOTH TEST REPORT (CERTIFICATION)		Approved by: Quality Manager
Test Report S/N: 1C1706160002-58-04-R3.BCG	Test Dates: 6/9-8/9/2017	EUT Type: Watch	Page 74 of 80

Radiated Spurious Emissions Measurements (Below 1GHz)

§15.209

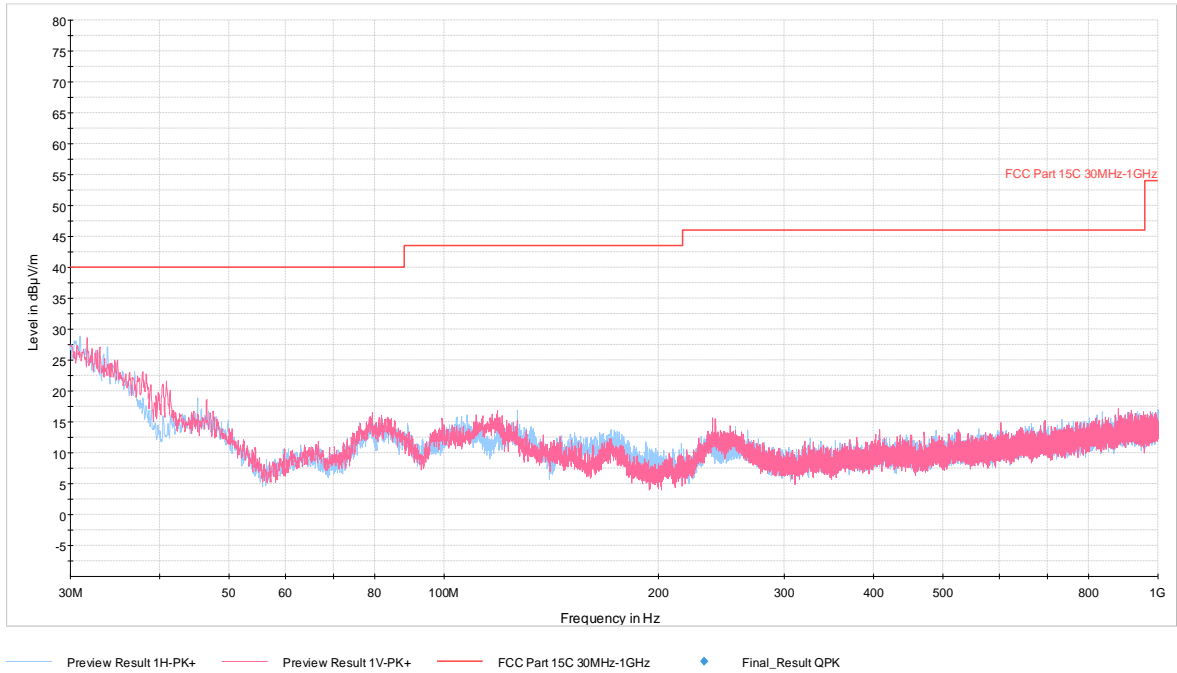

Plot 7-74. Radiated Spurious Plot below 1GHz (GFSK ePA, Pol. H & V)

Frequency [MHz]	Detector	Ant. Pol. [H/V]	Antenna Height [cm]	Turntable Azimuth [degree]	Analyzer Level [dBm]	AFCL [dB/m]	Field Strength [dBµV/m]	Limit [dBµV/m]	Margin [dB]
38.24	Quasi-Peak	V	-	-	-60.82	-19.97	26.21	40.00	-13.79
46.96	Quasi-Peak	V	-	-	-62.05	-25.58	19.37	40.00	-20.63
78.94	Quasi-Peak	V	-	-	-62.98	-24.97	19.05	40.00	-20.95
110.91	Quasi-Peak	V	-	-	-64.17	-24.14	18.69	43.52	-24.83
168.09	Quasi-Peak	H	-	-	-66.29	-24.41	16.30	43.52	-27.22
233.01	Quasi-Peak	H	-	-	-66.08	-24.84	16.08	43.52	-27.44

Table 7-12. Radiated Spurious Emissions Below 1GHz

FCC ID: BCG-A1858			FCC Pt. 15.247 BLUETOOTH TEST REPORT (CERTIFICATION)	Approved by: Quality Manager
Test Report S/N: 1C1706160002-58-04-R3.BCG	Test Dates: 6/9-8/9/2017	EUT Type: Watch	Page 75 of 80	

7.12 Line Conducted Measurement Data

§15.207

Test Overview and Limit

All AC line conducted spurious emissions are measured with a receiver connected to a grounded LISN while the EUT is operating at its maximum duty cycle, at maximum power, and at the appropriate frequencies. All data rates and modes were investigated for conducted spurious emissions. Only the conducted emissions of the configuration that produced the worst case emissions are reported in this section.

All conducted emissions must not exceed the limits shown in the table below, per Section 15.207.

Frequency of emission (MHz)	Conducted Limit (dB μ V)	
	Quasi-peak	Average
0.15 – 0.5	66 to 56*	56 to 46*
0.5 – 5	56	46
5 – 30	60	50

Table 7-13. Conducted Limits

*Decreases with the logarithm of the frequency.

Test Procedures Used

ANSI C63.10-2013, Section 6.2

Test Settings

Quasi-Peak Field Strength Measurements

1. Analyzer center frequency was set to the frequency of the spurious emission of interest
2. RBW = 9kHz (for emissions from 150kHz – 30MHz)
3. Detector = quasi-peak
4. Sweep time = auto couple
5. Trace mode = max hold
6. Trace was allowed to stabilize

Average Field Strength Measurements

1. Analyzer center frequency was set to the frequency of the spurious emission of interest
2. RBW = 9kHz (for emissions from 150kHz – 30MHz)
3. Detector = RMS
4. Sweep time = auto couple
5. Trace mode = max hold
6. Trace was allowed to stabilize

FCC ID: BCG-A1858		FCC Pt. 15.247 BLUETOOTH TEST REPORT (CERTIFICATION)	Approved by: Quality Manager
Test Report S/N: 1C1706160002-58-04-R3.BCG	Test Dates: 6/9-8/9/2017	EUT Type: Watch	Page 76 of 80

Test Setup

The EUT and measurement equipment were set up as shown in the diagram below.

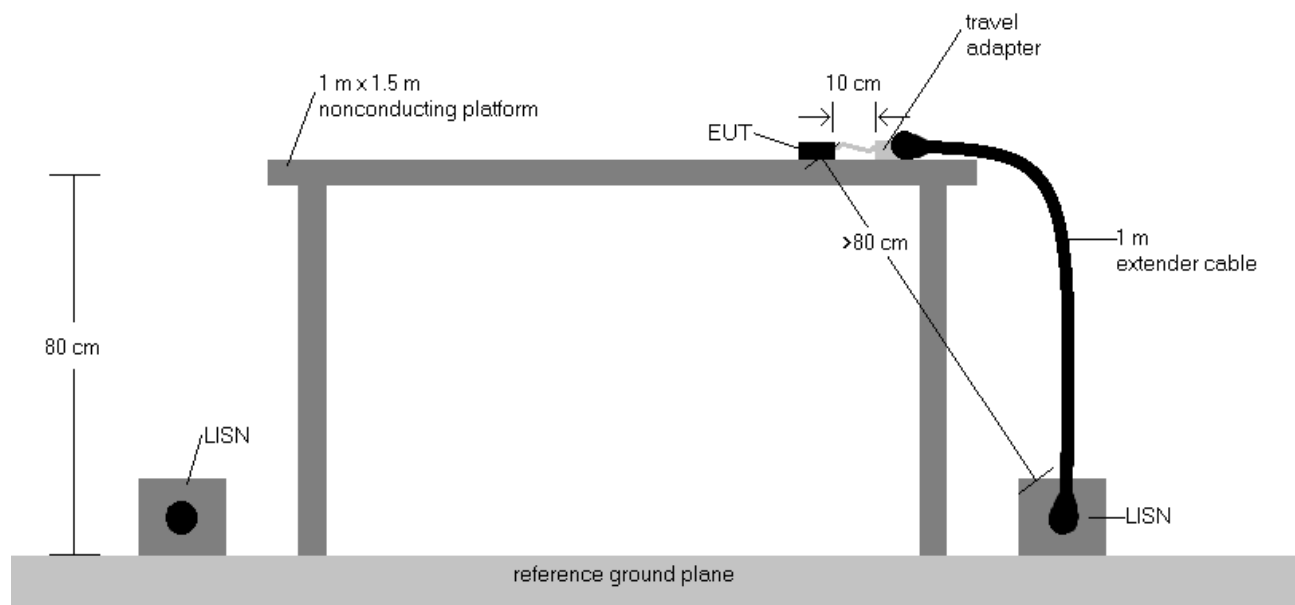

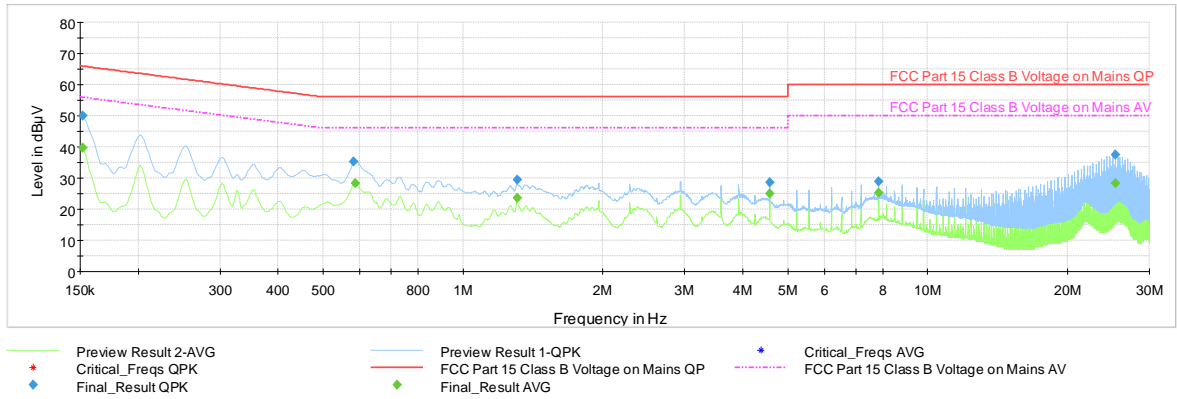

Figure 7-12. Test Instrument & Measurement Setup

Test Notes

1. All modes of operation were investigated and the worst-case emissions are reported using mid channel. The emissions found were not affected by the choice of channel used during testing.
2. The limit for an intentional radiator from 150kHz to 30MHz are specified in 15.207.
3. $\text{Corr. (dB)} = \text{Cable loss (dB)} + \text{LISN insertion factor (dB)}$
4. $\text{QP/AV Level (dB}\mu\text{V)} = \text{QP/AV Analyzer/Receiver Level (dB}\mu\text{V)} + \text{Corr. (dB)}$
5. $\text{Margin (dB)} = \text{QP/AV Limit (dB}\mu\text{V)} - \text{QP/AV Level (dB}\mu\text{V)}$
6. Traces shown in plot are made using a peak detector.
7. Deviations to the Specifications: None.

FCC ID: BCG-A1858		FCC Pt. 15.247 BLUETOOTH TEST REPORT (CERTIFICATION)	Approved by: Quality Manager
Test Report S/N: 1C1706160002-58-04-R3.BCG	Test Dates: 6/9-8/9/2017	EUT Type: Watch	Page 77 of 80



Plot 7-75. Line-Conducted Test Plot (L1)

Frequency MHz	Process State	QuasiPeak dBµV	Average dBµV	Limit dBµV	Margin dB	Bandwidth kHz	Line	PE
0.152250	FINAL	50.00	—	65.88	15.88	9.000	L1	GND
0.152250	FINAL	—	39.64	55.88	16.24	9.000	L1	GND
0.582000	FINAL	35.21	—	56.00	20.79	9.000	L1	GND
0.586500	FINAL	—	28.30	46.00	17.70	9.000	L1	GND
1.306500	FINAL	29.45	—	56.00	26.55	9.000	L1	GND
1.306500	FINAL	—	23.57	46.00	22.43	9.000	L1	GND
4.571250	FINAL	—	25.03	46.00	20.97	9.000	L1	GND
4.571250	FINAL	28.48	—	56.00	27.52	9.000	L1	GND
7.836000	FINAL	—	25.26	50.00	24.74	9.000	L1	GND
7.836000	FINAL	28.87	—	60.00	31.13	9.000	L1	GND
25.305000	FINAL	37.52	—	60.00	22.48	9.000	L1	GND
25.305000	FINAL	—	28.35	50.00	21.65	9.000	L1	GND

Table 7-14. Line-Conducted Test Table (L1)

FCC ID: BCG-A1858	FCC Pt. 15.247 BLUETOOTH TEST REPORT (CERTIFICATION)		Approved by: Quality Manager
Test Report S/N: 1C1706160002-58-04-R3.BCG	Test Dates: 6/9-8/9/2017	EUT Type: Watch	Page 78 of 80

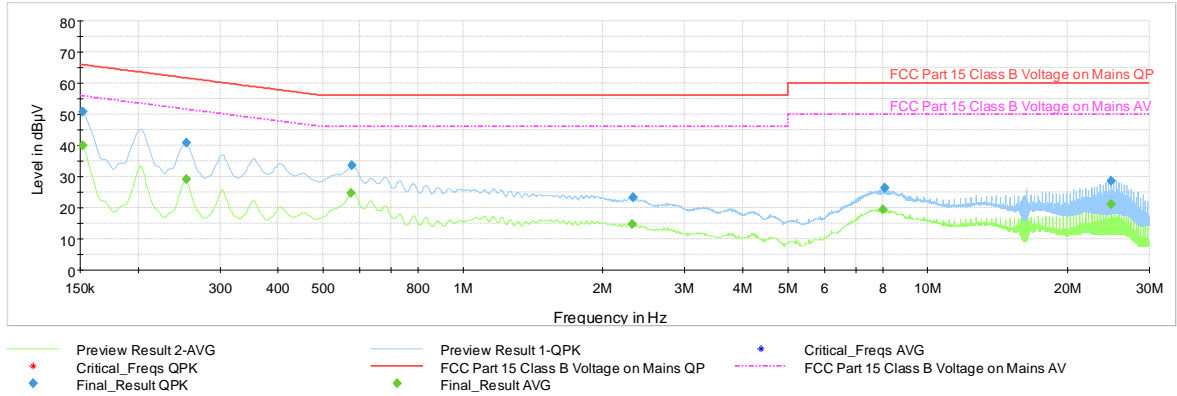

Plot 7-76. Line-Conducted Test Plot (N)

Frequency MHz	Process State	QuasiPeak dBµV	Average dBµV	Limit dBµV	Margin dB	Bandwidth kHz	Line	PE
0.152250	FINAL	50.73	—	65.88	15.14	9.000	N	GND
0.152250	FINAL	—	39.97	55.88	15.91	9.000	N	GND
0.253500	FINAL	40.94	—	61.64	20.70	9.000	N	GND
0.253500	FINAL	—	29.15	51.64	22.49	9.000	N	GND
0.573000	FINAL	—	24.76	46.00	21.24	9.000	N	GND
0.575250	FINAL	33.53	—	56.00	22.47	9.000	N	GND
2.312250	FINAL	—	14.81	46.00	31.19	9.000	N	GND
2.321250	FINAL	23.28	—	56.00	32.72	9.000	N	GND
8.002500	FINAL	—	19.41	50.00	30.59	9.000	N	GND
8.088000	FINAL	26.42	—	60.00	33.58	9.000	N	GND
24.816750	FINAL	28.68	—	60.00	31.32	9.000	N	GND
24.816750	FINAL	—	20.98	50.00	29.02	9.000	N	GND

Table 7-15. Line-Conducted Test Table (N)

FCC ID: BCG-A1858	FCC Pt. 15.247 BLUETOOTH TEST REPORT (CERTIFICATION)		Approved by: Quality Manager
Test Report S/N: 1C1706160002-58-04-R3.BCG	Test Dates: 6/9-8/9/2017	EUT Type: Watch	Page 79 of 80

8.0 CONCLUSION

The data collected relate only to the item(s) tested and show that the **Apple Watch FCC ID: BCG-A1858** is in compliance with Part 15 Subpart C (15.247) of the FCC Rules.

FCC ID: BCG-A1858		FCC Pt. 15.247 BLUETOOTH TEST REPORT (CERTIFICATION)	Approved by: Quality Manager
Test Report S/N: 1C1706160002-58-04-R3.BCG	Test Dates: 6/9-8/9/2017	EUT Type: Watch	Page 80 of 80