



**FCC 47 CFR PART 15 SUBPART C
INDUSTRY CANADA RSS-247 ISSUE 1**

CERTIFICATION TEST REPORT

FOR

WIRELESS EARPHONE

MODEL NUMBER: A1763

FCC ID: BCG-A1763

IC: 579C-A1763

REPORT NUMBER: 16U23788-E2V4

ISSUE DATE: DECEMBER 19, 2016

Prepared for

APPLE, INC.

1 INFINITE LOOP

CUPERTINO, CA 95014, U.S.A.

Prepared by

UL VERIFICATION SERVICES INC.

47173 BENICIA STREET

FREMONT, CA 94538, U.S.A.

TEL: (510) 771-1000

FAX: (510) 661-0888

NVLAP[®]

NVLAP LAB CODE 200065-0

Revision History

<u>Rev.</u>	<u>Issue Date</u>	<u>Revisions</u>	<u>Revised By</u>
V1	12/14/2016	Initial Issue	Mengistu Mekuria
V2	12/15/2016	Address TCB's Questions	Chin Pang
V3	12/16/2016	Address TCB's Questions	Chin Pang
V4	12/19/2016	EUT not capable of 3-DH5. Remove 3-DH5 and replace with 2-DH5	Joe Vang

TABLE OF CONTENTS

1. ATTESTATION OF TEST RESULTS	5
2. TEST METHODOLOGY	6
3. FACILITIES AND ACCREDITATION	6
4. CALIBRATION AND UNCERTAINTY	7
4.1. <i>MEASURING INSTRUMENT CALIBRATION</i>	<i>7</i>
4.2. <i>SAMPLE CALCULATION</i>	<i>7</i>
4.3. <i>MEASUREMENT UNCERTAINTY.....</i>	<i>7</i>
5. EQUIPMENT UNDER TEST	8
5.1. <i>DESCRIPTION OF EUT</i>	<i>8</i>
5.2. <i>MAXIMUM OUTPUT POWER.....</i>	<i>8</i>
5.3. <i>DESCRIPTION OF AVAILABLE ANTENNAS</i>	<i>8</i>
5.4. <i>SOFTWARE AND FIRMWARE.....</i>	<i>8</i>
5.5. <i>WORST-CASE CONFIGURATION AND MODE.....</i>	<i>9</i>
5.6. <i>DESCRIPTION OF TEST SETUP.....</i>	<i>10</i>
6. TEST AND MEASUREMENT EQUIPMENT	17
7. ANTENNA PORT TEST RESULTS	18
7.1. <i>ON TIME AND DUTY CYCLE.....</i>	<i>18</i>
7.2. <i>BASIC DATA RATE GFSK MODULATION.....</i>	<i>20</i>
7.2.1. <i>20 dB AND 99% BANDWIDTH</i>	<i>20</i>
7.2.2. <i>HOPPING FREQUENCY SEPARATION</i>	<i>23</i>
7.2.3. <i>NUMBER OF HOPPING CHANNELS.....</i>	<i>24</i>
7.2.4. <i>AVERAGE TIME OF OCCUPANCY</i>	<i>27</i>
7.2.5. <i>OUTPUT POWER</i>	<i>31</i>
7.2.6. <i>AVERAGE POWER.....</i>	<i>32</i>
7.2.7. <i>CONDUCTED SPURIOUS EMISSIONS.....</i>	<i>33</i>
7.3. <i>ENHANCED DATA RATE QPSK MODULATION.....</i>	<i>38</i>
7.3.1. <i>20 dB AND 99% BANDWIDTH</i>	<i>38</i>
7.3.2. <i>HOPPING FREQUENCY SEPARATION</i>	<i>41</i>
7.3.3. <i>NUMBER OF HOPPING CHANNELS.....</i>	<i>42</i>
7.3.4. <i>AVERAGE TIME OF OCCUPANCY</i>	<i>45</i>
7.3.5. <i>OUTPUT POWER</i>	<i>49</i>
7.3.6. <i>AVERAGE POWER.....</i>	<i>50</i>
7.3.7. <i>CONDUCTED SPURIOUS EMISSIONS.....</i>	<i>51</i>
8. RADIATED TEST RESULTS.....	56
8.1. <i>LIMITS AND PROCEDURE.....</i>	<i>56</i>
8.2. <i>TRANSMITTER ABOVE 1 GHz.....</i>	<i>57</i>
8.2.1. <i>BASIC DATA RATE GFSK MODULATION.....</i>	<i>57</i>
8.2.2. <i>ENHANCED DATA RATE QPSK MODULATION</i>	<i>67</i>

8.3.	<i>WORST-CASE BELOW 1 GHz</i>	77
8.4.	<i>WORST-CASE ABOVE 18 GHz</i>	79
9.	AC POWER LINE CONDUCTED EMISSIONS	81
9.1.	<i>EUT POWERED BY AC/DC ADAPTER VIA USB CABLE</i>	82
9.2.	<i>EUT POWERED BY HOST PC VIA USB CABLE</i>	84
10.	SETUP PHOTOS	86

1. ATTESTATION OF TEST RESULTS

COMPANY NAME: APPLE, INC.
1 INFINITE LOOP
CUPERTINO, CA 95014, U.S.A.

EUT DESCRIPTION: WIRELESS EARPHONE

MODEL: A1763

SERIAL NUMBER: (Radiated) FTRSQ01YH18V, FTRSQ01ZH18V, FTRSQ01SH18V,
FTRSQ01TH18V, (Conducted) FTRSQ00GH18V, FTRSQ009H18V,
FTRSQ003H18V

DATE TESTED: DECEMBER 01-02, 2016

APPLICABLE STANDARDS	
STANDARD	TEST RESULTS
CFR 47 Part 15 Subpart C	Pass
INDUSTRY CANADA RSS-247 Issue 1	Pass
INDUSTRY CANADA RSS-GEN Issue 4	Pass

UL Verification Services Inc. tested the above equipment in accordance with the requirements set forth in the above standards. All indications of Pass/Fail in this report are opinions expressed by UL Verification Services Inc. based on interpretations and/or observations of test results. Measurement Uncertainties were not taken into account and are published for informational purposes only. The test results show that the equipment tested is capable of demonstrating compliance with the requirements as documented in this report.

Note: The results documented in this report apply only to the tested sample, under the conditions and modes of operation as described herein. This document may not be altered or revised in any way unless done so by UL Verification Services Inc. and all revisions are duly noted in the revisions section. Any alteration of this document not carried out by UL Verification Services Inc. will constitute fraud and shall nullify the document. This report must not be used by the client to claim product certification, approval, or endorsement by NVLAP, NIST, any agency of the Federal Government, or any agency of any government.

Approved & Released For
UL Verification Services Inc. By:

Prepared By:

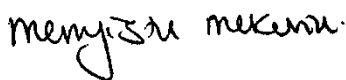

MENGISTU MEKURIA
SENIOR ENGINEER
UL VERIFICATION SERVICES INC.

ERIC YU
EMC ENGINEER
UL VERIFICATION SERVICES INC.

2. TEST METHODOLOGY

The tests documented in this report were performed in accordance with FCC CFR 47 Part 2, FCC CFR 47 Part 15, ANSI C63.10-2013, RSS-GEN Issue 4, and RSS-247 Issue 1.

3. FACILITIES AND ACCREDITATION

The test sites and measurement facilities used to collect data are located at 47173 and 47266 Benicia Street, Fremont, California, USA. Line conducted emissions are measured only at the 47173 address. The following table identifies which facilities were utilized for radiated emission measurements documented in this report. Specific facilities are also identified in the test results sections.

47173 Benicia Street	47266 Benicia Street
<input type="checkbox"/> Chamber A	<input type="checkbox"/> Chamber D
<input type="checkbox"/> Chamber B	<input type="checkbox"/> Chamber E
<input type="checkbox"/> Chamber C	<input type="checkbox"/> Chamber F
	<input type="checkbox"/> Chamber G
	<input checked="" type="checkbox"/> Chamber H

The above test sites and facilities are covered under FCC Test Firm Registration # 208313. Chambers A through H are covered under Industry Canada company address code 2324B with site numbers 2324B -1 through 2324B-8, respectively.

UL Verification Services Inc. is accredited by NVLAP, Laboratory Code 200065-0. The full scope of accreditation can be viewed at <http://ts.nist.gov/standards/scopes/2000650.htm>.

4. CALIBRATION AND UNCERTAINTY

4.1. MEASURING INSTRUMENT CALIBRATION

The measuring equipment utilized to perform the tests documented in this report has been calibrated in accordance with the manufacturer's recommendations, and is traceable to recognized national standards.

4.2. SAMPLE CALCULATION

Where relevant, the following sample calculation is provided:

$$\begin{aligned} \text{Field Strength (dBuV/m)} &= \text{Measured Voltage (dBuV)} + \text{Antenna Factor (dB/m)} + \\ &\text{Cable Loss (dB)} - \text{Preamp Gain (dB)} \\ 36.5 \text{ dBuV} + 18.7 \text{ dB/m} + 0.6 \text{ dB} - 26.9 \text{ dB} &= 28.9 \text{ dBuV/m} \end{aligned}$$

4.3. MEASUREMENT UNCERTAINTY

Where relevant, the following measurement uncertainty levels have been estimated for tests performed on the apparatus:

PARAMETER	UNCERTAINTY
Conducted Disturbance, 9KHz to 0.15 MHz	3.84 dB
Conducted Disturbance, 0.15 to 30 MHz	3.65 dB
Radiated Disturbance, 9KHz to 30 MHz	3.15 dB
Radiated Disturbance, 30 to 1000 MHz	5.36 dB
Radiated Disturbance, 1000 to 18000 MHz	4.32 dB
Radiated Disturbance, 18000 to 26000 MHz	4.45 dB
Radiated Disturbance, 26000 to 40000 MHz	5.24 dB

Uncertainty figures are valid to a confidence level of 95%.

5. EQUIPMENT UNDER TEST

5.1. DESCRIPTION OF EUT

The EUT is a wireless earphone. It has an integral battery, microphone and antenna. It can play music from a Bluetooth audio source. It has a Lightning port for charging. It has 4 buttons, power, vol up, vol down, and play/pause.

5.2. MAXIMUM OUTPUT POWER

The transmitter has a maximum peak conducted output power as follows:

Frequency Range (MHz)	Mode	Output Power (dBm)	Output Power (mW)
2402 - 2480	Basic GFSK	11.76	15.00
2402 - 2480	DQPSK	12.63	18.32

5.3. DESCRIPTION OF AVAILABLE ANTENNAS

Frequency Band (GHz)	Antenna Gain (dBi)
2.4	-2.50

5.4. SOFTWARE AND FIRMWARE

The software installed in the EUT during testing was Version 6.5.6.

5.5. WORST-CASE CONFIGURATION AND MODE

The worst-case mode and channel used for 30-1000 MHz radiated was including AC/DC charger, mode and channel with the highest output power. EUT is transmitting while in charging mode.

For AC line conducted emission test, two configuration of powered by AC/DC charger and by host PC via USB cable were investigated with the mode and channel that comes with the highest output power.

Above 1G radiated emission were performed with low, middle and high channels. And above 18GHz radiated emission were performed with the EUT only set to transmit at the channel with highest output power as worst-case scenario.

The fundamental of the EUT was investigated in three orthogonal orientations X (Flatbed), Y (Landscape) and Z (Portrait), it was determined that Z orientation was worst-case orientation. Therefore, all final radiated testing was performed with the EUT in Z orientation.

Data Rate tested:

GFSK mode: DH5

DQPSK mode: 2-DH5

5.6. DESCRIPTION OF TEST SETUP

SUPPORT EQUIPMENT

Support Equipment List				
Description	Manufacturer	Model	Serial Number	FCC ID
Laptop AC/DC adapter	Apple	A1424	NSW25679	N/A
Laptop	Apple	MacBook AIR	C02P41R2G086	N/A
USB	Apple	N/A	N/A	N/A
AC/DC Adapter	Apple	A1385	D292365A20FDHLHCW	N/A

I/O CABLES (CONDUCTED TEST)

I/O Cable List						
Cable No	Port	# of identical ports	Connector Type	Cable Type	Cable Length (m)	Remarks
1	Antenna	1	SMA	Un-Shielded	0.2	To spectrum Analyzer
2	USB	1	USB	Shielded	1	N/A
3	AC	1	AC	Un-shielded	2	N/A

I/O CABLES (RADIATED ABOVE 1 GHZ)

I/O Cable List						
Cable No	Port	# of identical ports	Connector Type	Cable Type	Cable Length (m)	Remarks
None Used						

I/O CABLES (RADAITED BELOW 1 GHZ)

I/O Cable List						
Cable No	Port	# of identical ports	Connector Type	Cable Type	Cable Length (m)	Remarks
1	AC	1	AC	Un-shielded	2	N/A

I/O CABLES (AC LINE CONDUCTED: AC/DC ADAPTER)

I/O Cable List						
Cable No	Port	# of identical ports	Connector Type	Cable Type	Cable Length (m)	Remarks
1	AC	1	AC/DC Adapter	Un-shielded	2	N/A

I/O CABLES (AC LINE CONDUCTED: LAPTOP CONFIGUARTION)

I/O Cable List						
Cable No	Port	# of identical ports	Connector Type	Cable Type	Cable Length (m)	Remarks
1	USB	1	AC/DC adapter	Un-shielded	1	
2	USB	1	AC	Un-shielded	2	N/A

TEST SETUP- CONDUCTED PORT

The EUT was tested connected to a host Laptop via USB cable adapter and spectrum analyzer to antenna port. Test software exercised the EUT.

SETUP DIAGRAM

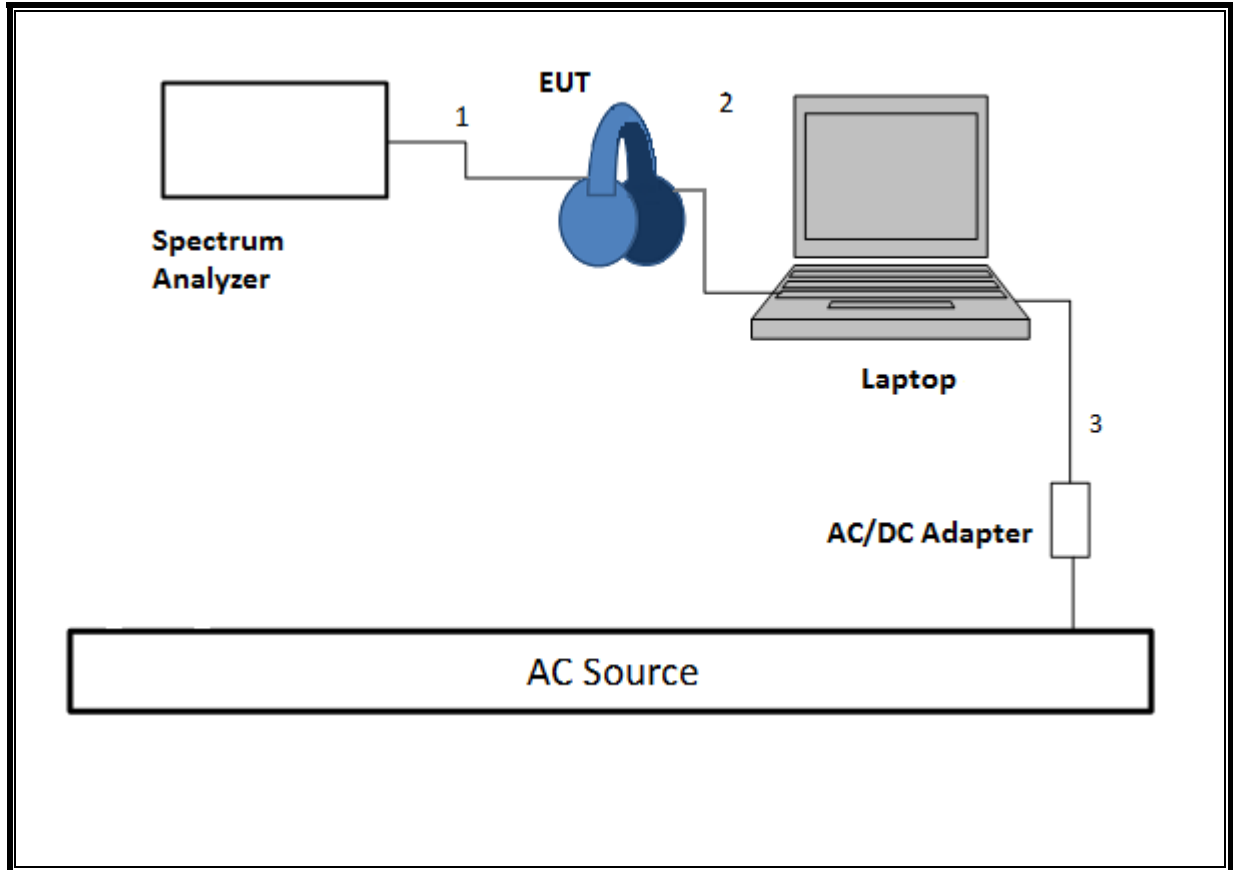

TEST SETUP- RADIATED-ABOVE 1 GHZ

The EUT was powered by battery. Test software exercised the EUT.

SETUP DIAGRAM

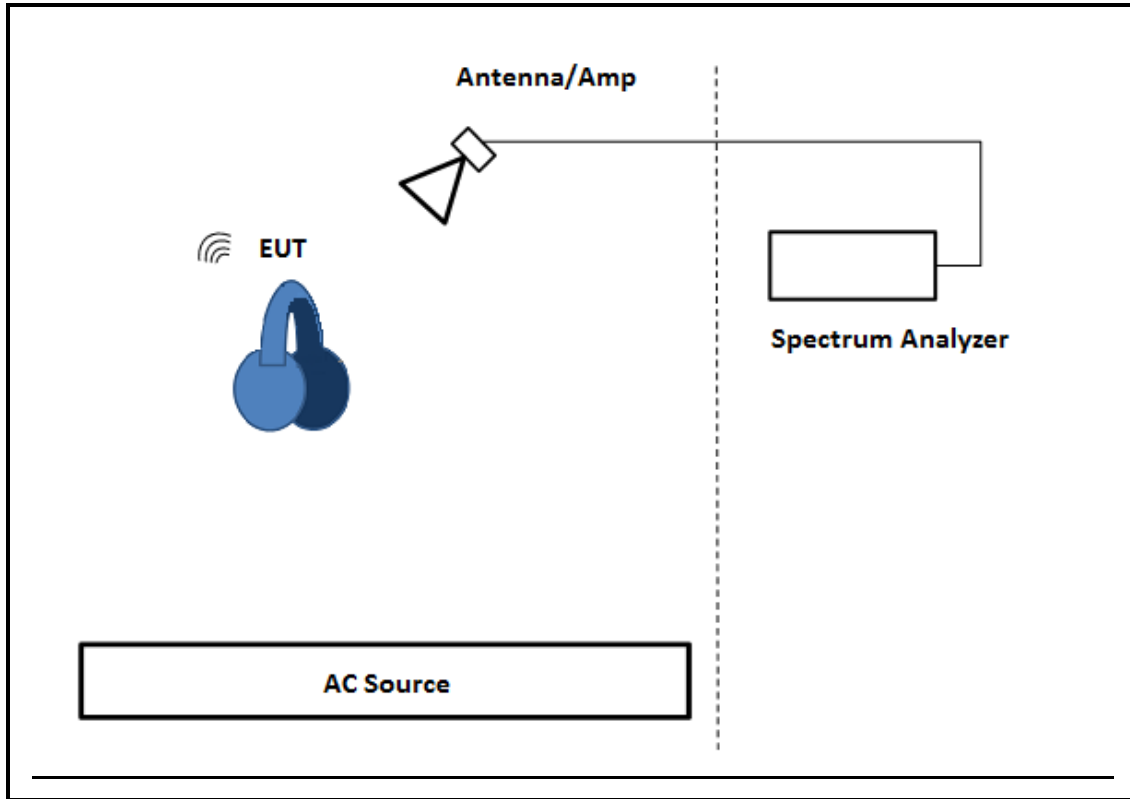

TEST SETUP- BELOW 1GHz

The EUT was tested powered by AC adapter. Test software exercised the EUT.

SETUP DIAGRAM

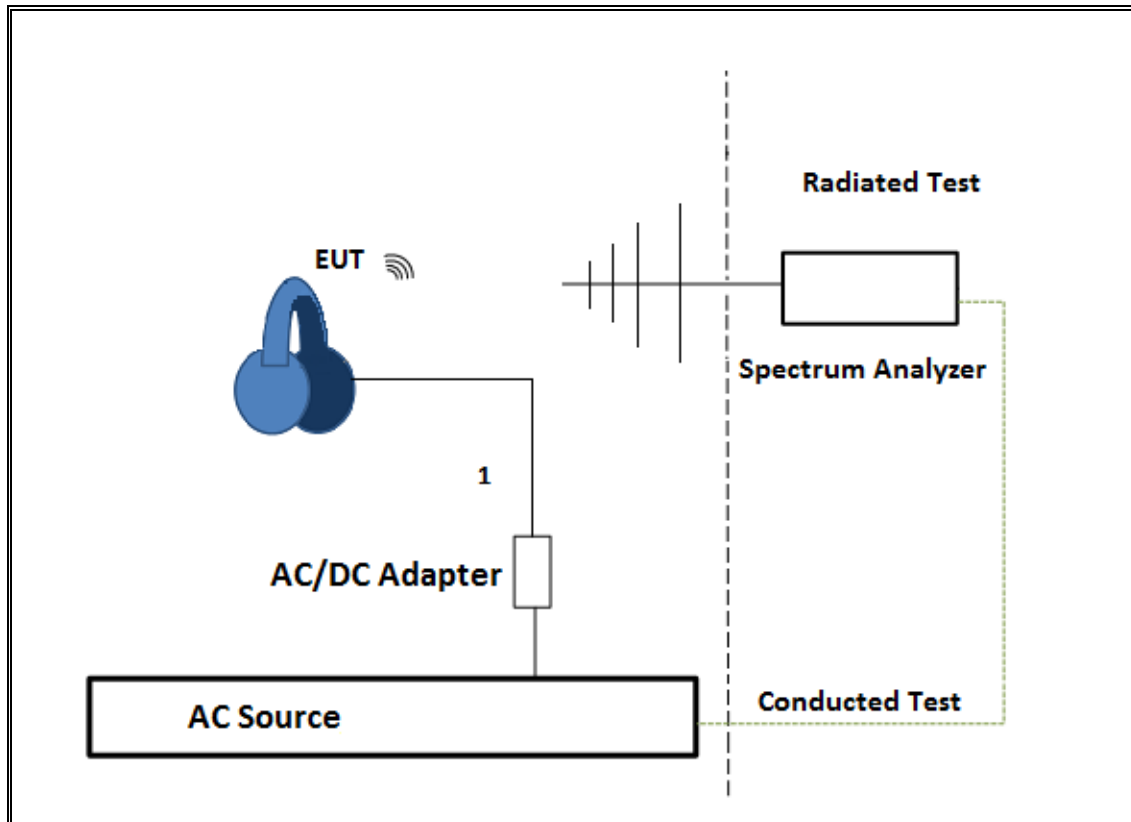

TEST SETUP- AC LINE CONDUCTED: AC/DC ADAPTER

The EUT was tested powered by AC/DC adapter via USB cable. Test software exercised the EUT.

SETUP DIAGRAM

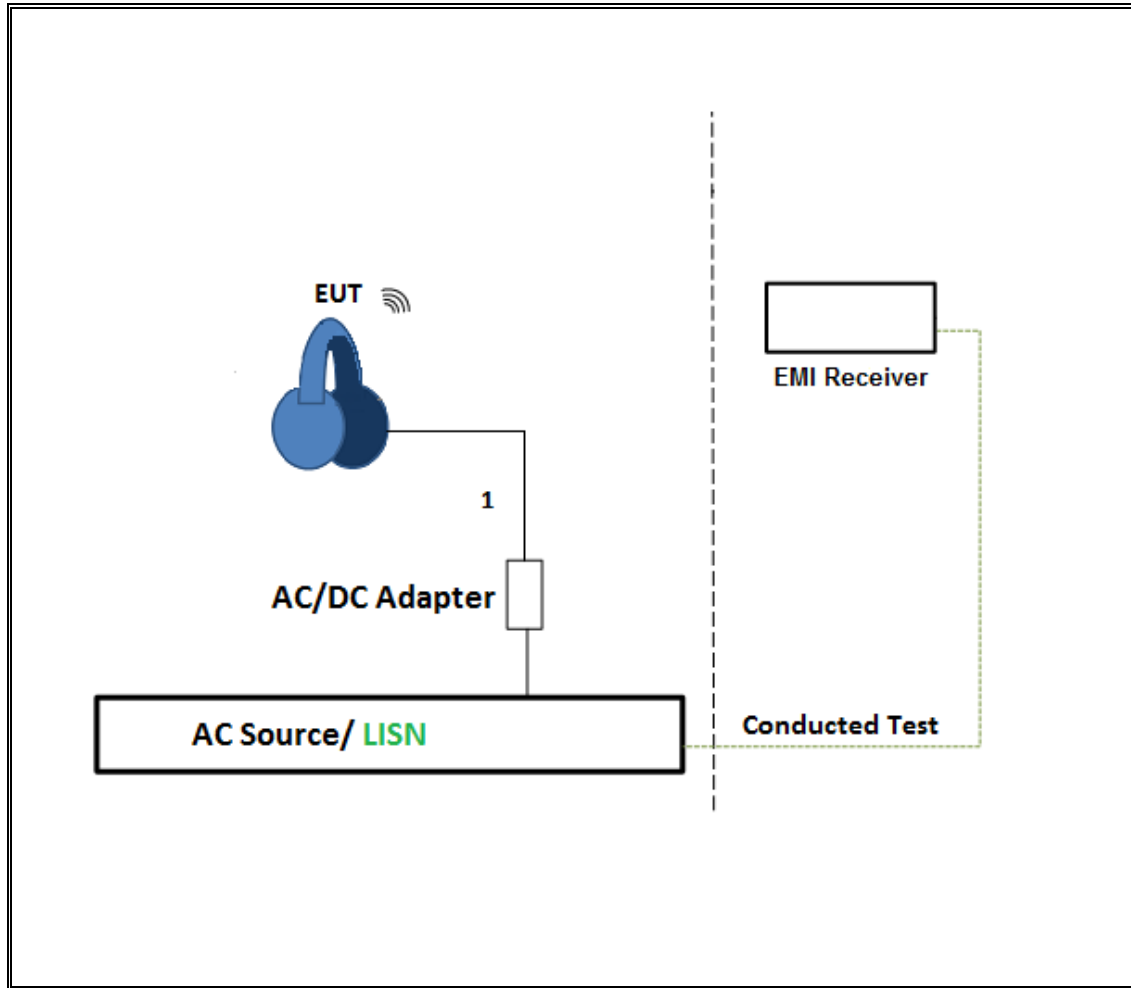

TEST SETUP- AC LINE CONDUCTED: LAPTOP CONFIGURATION

The EUT was tested powered by host PC via USB cable. Test software exercised the EUT.

SETUP DIAGRAM

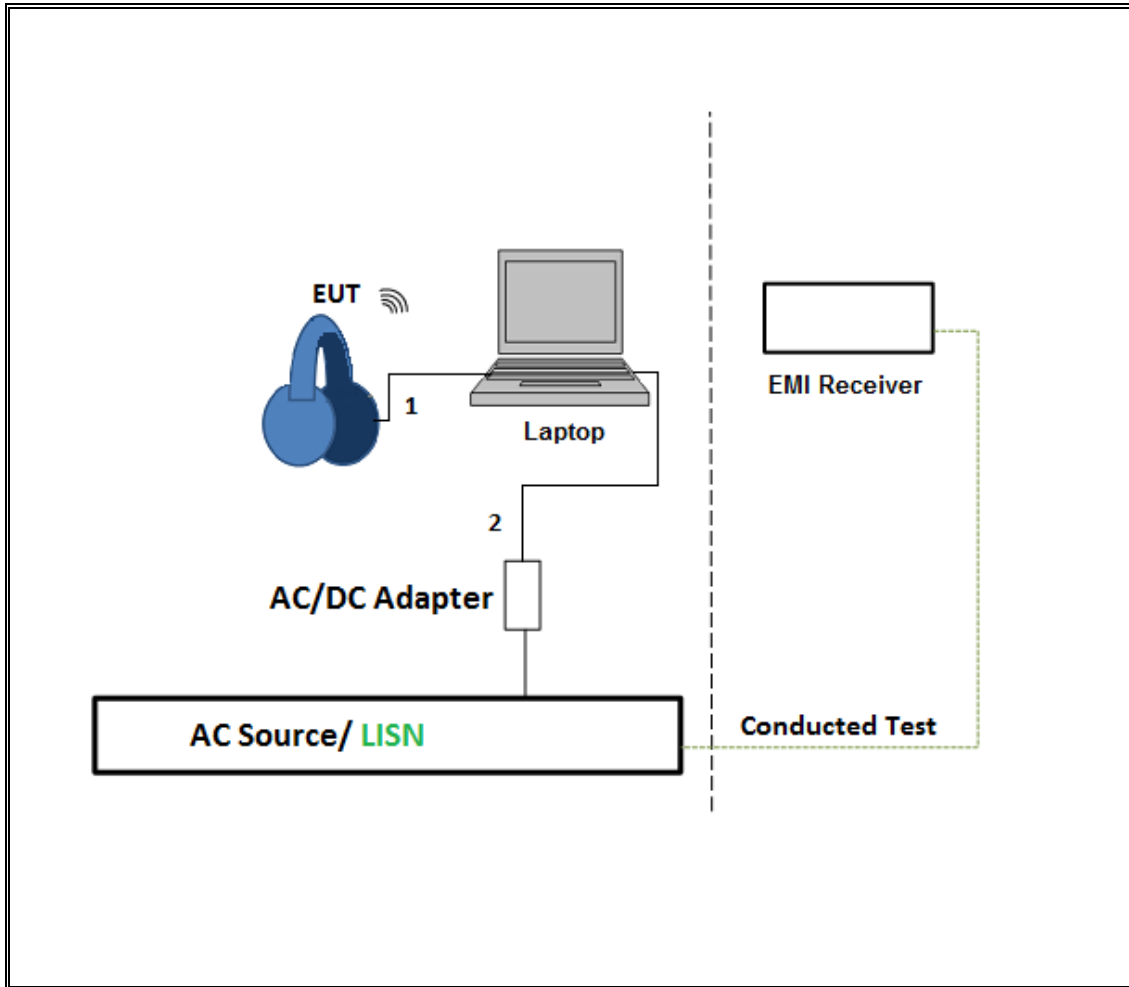

6. TEST AND MEASUREMENT EQUIPMENT

The following test and measurement equipment was utilized for the tests documented in this report:

Test Equipment List				
Description	Manufacturer	Model	T Number	Cal Due
Spectrum Analyzer, PXA, 3Hz to 44GHz	Agilent	N9030A	T339	9/22/2017
Spectrum Analyzer, PXA, 3Hz to 44GHz	Agilent	N9030A	T341	10/25/2017
Antenna, Horn 1-18GHz	ETS Lindgren	3117	T344	2/22/2017
Antenna, Broadband Hybrid, 30MHz to 2000MHz	Sunol Sciences	JB3	T900	5/3/2017
Amplifier, 1 - 18GHz	Miteq	AFS42-00101800-25-S-42	T863	4/26/2017
Amplifier, 10KHz to 1GHz, 32dB	Sonoma	310N	T835	6/18/2017
EMI Reciever	Rohde & Schwarz	ESR-EMI	1436	12/19/16
LISN	FISCHER	LISN-50/250-25-	1310	06/08/17
Power Meter, P-series single channel	Agilent	N1911A	T1271	7/8/2017
Power Sensor, P - series, 50MHz to 18GHz, Wideband	Agilent	N1921A	T1228	6/20/2017
Antenna, Horn 18 to 26.5GHz	ARA	MWH-1826	T447	6/16/2017
Spectrum Analyzer, 40 GHz	Agilent	8564E	T106	9/7/2017
Amplifier, 1 to 26.5GHz, 23.5dB Gain minimum	Keysight	8449B	T402	7/5/2017
AC Line Conducted				
EMI Test Receiver 9Khz-7GHz	Rohde & Schwarz	ESCI7	100935	9/13/2017
LISN for Conducted Emissions CISPR-16	Fischer	50/250-25-2	161124	9/16/2017
Power Cable, Line Conducted Emissions	U L	PG1	T861	9/1/2017
UL SOFTWARE				
* Radiated Software	UL	UL EMC	Ver 9.5, June 24, 2015	
* Conducted Software	UL	UL EMC	Ver 4.0, January 11, 2016	
* AC Line Conducted Software	UL	UL EMC	Ver 9.5, May 26, 2015	

Note: * indicates automation software version used in the compliance certification testing

7. ANTENNA PORT TEST RESULTS

7.1. ON TIME AND DUTY CYCLE

LIMITS

None; for reporting purposes only.

PROCEDURE

KDB 558074 Zero-Span Spectrum Analyzer Method.

RESULTS

ON TIME AND DUTY CYCLE

Mode	ON Time B (msec)	Period (msec)	Duty Cycle x (linear)	Duty Cycle (%)	Duty Cycle Correction Factor (dB)	1/B Minimum VBW (kHz)
Bluetooth GFSK	1.000	1.000	1.000	100.00%	0.00	0.010
Bluetooth QPSK	1.000	1.000	1.000	100.00%	0.00	0.010

DUTY CYCLE PLOTS

HOPPING OFF

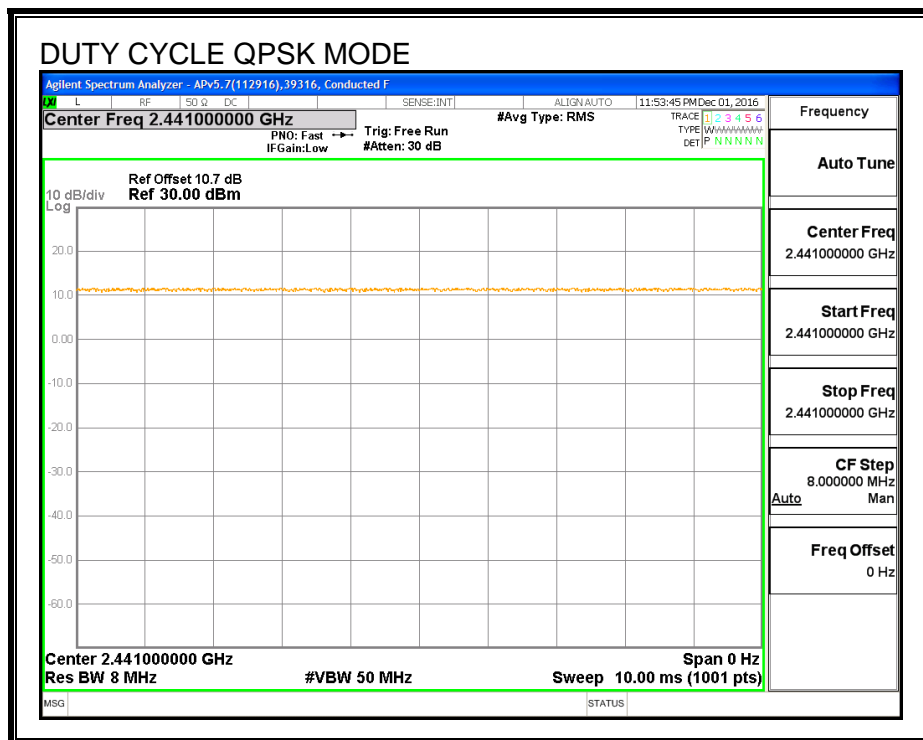
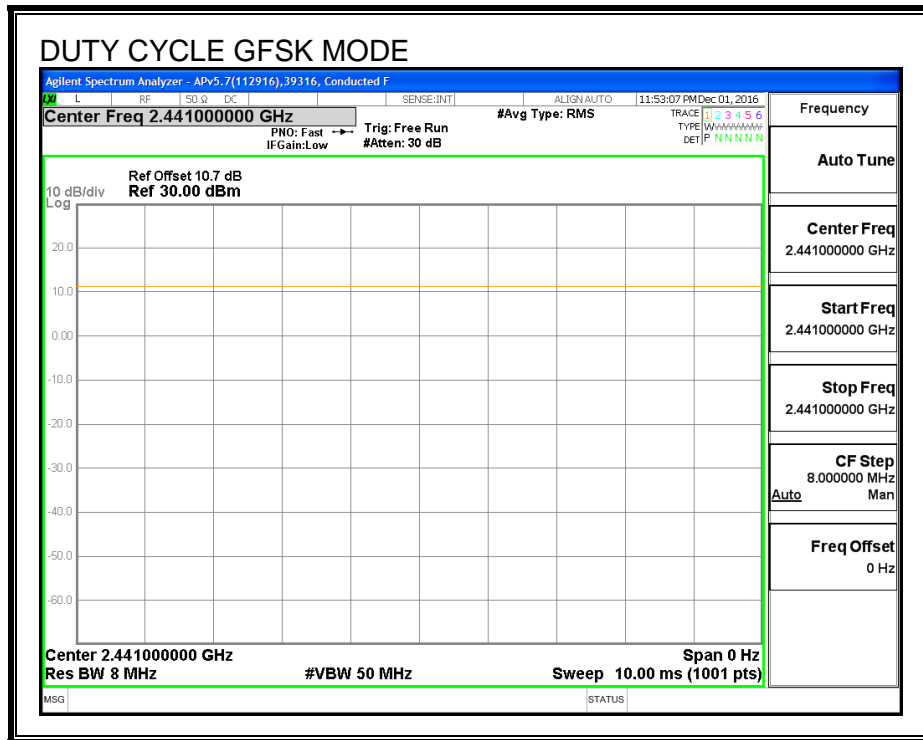

7.2. BASIC DATA RATE GFSK MODULATION

7.2.1. 20 dB AND 99% BANDWIDTH

LIMIT

None; for reporting purposes only.

TEST PROCEDURE

The transmitter output is connected to a spectrum analyzer. The RBW is set to $\geq 1\%$ of the 20 dB bandwidth. The VBW is set to \geq RBW. The sweep time is coupled.

RESULTS

Channel	Frequency (MHz)	20 dB Bandwidth (KHz)	99% Bandwidth (KHz)
Low	2402	998.5	901.09
Middle	2441	952.3	904.13
High	2480	955.0	911.05

20 dB AND 99% BANDWIDTH

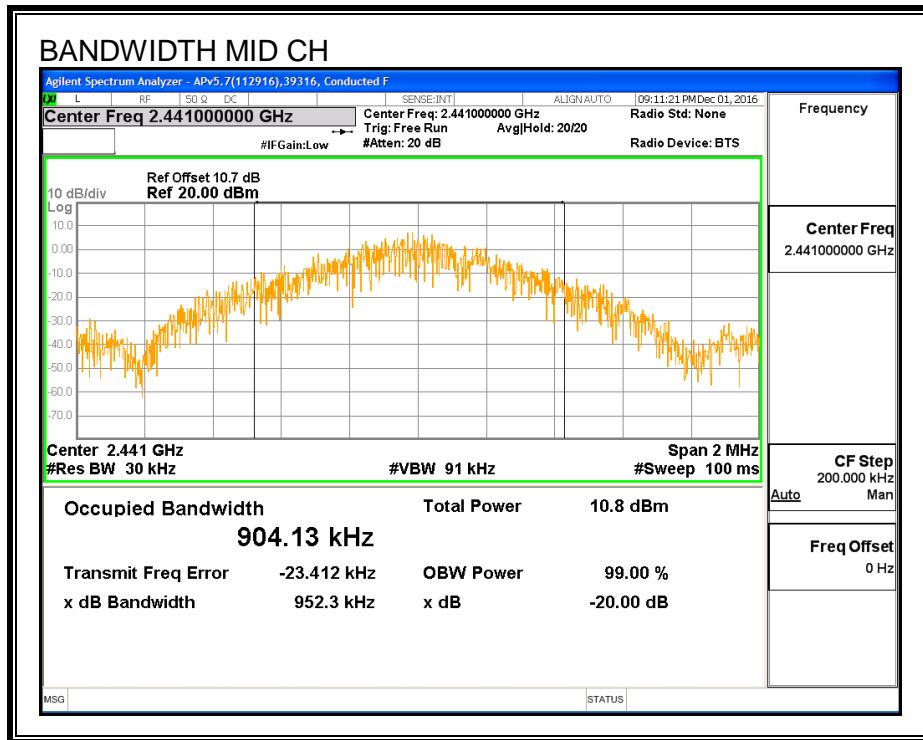
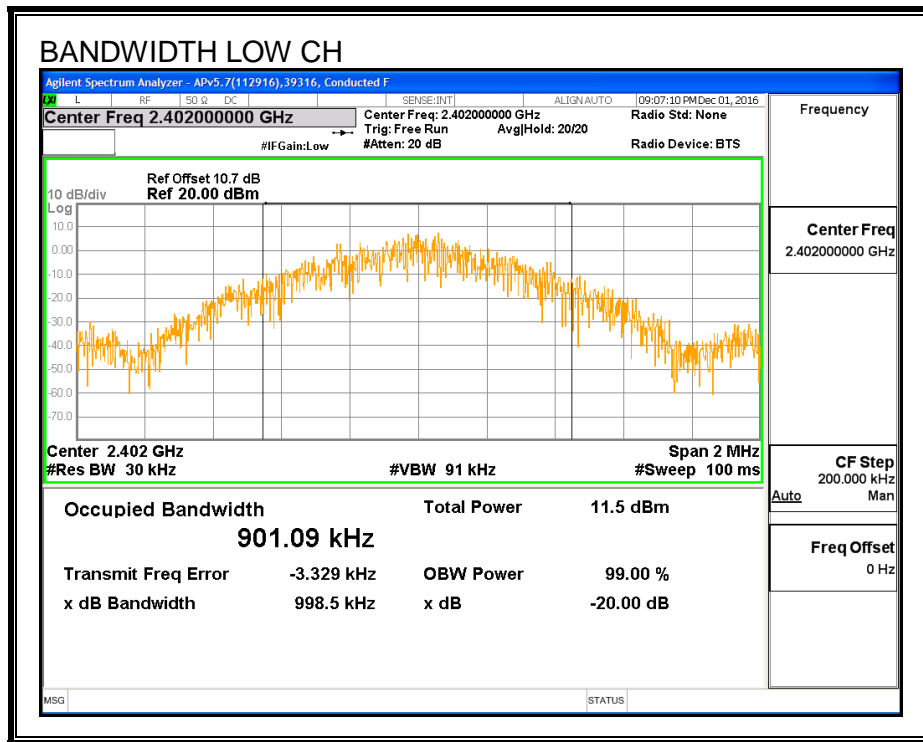

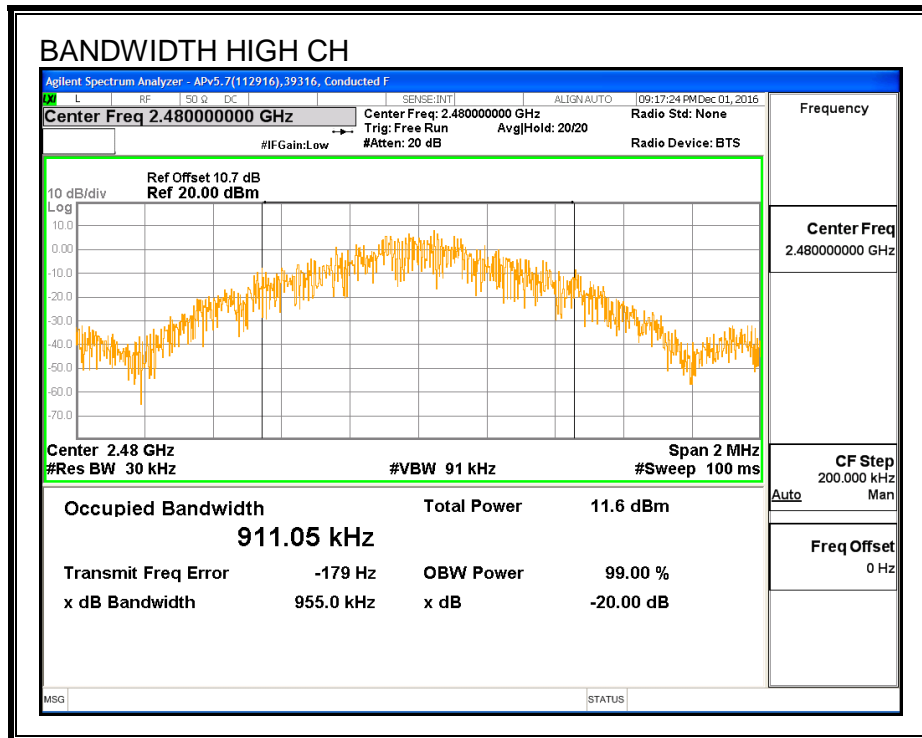

7.2.2. HOPPING FREQUENCY SEPARATION

LIMIT

FCC §15.247 (a) (1)

IC RSS-247 (5.1) (2)

Frequency hopping systems shall have hopping channel carrier frequencies separated by a minimum of 25 kHz or the 20 dB bandwidth of the hopping channel, whichever is greater.

Alternatively, frequency hopping systems operating in the 2400-2483.5 MHz band may have hopping channel carrier frequencies that are separated by 25 kHz or two-thirds of the 20 dB bandwidth of the hopping channel, whichever is greater, provided the systems operate with an output power no greater than 125 mW.

TEST PROCEDURE

The transmitter output is connected to a spectrum analyzer. The RBW is set to 300 kHz and the VBW is set to 910 kHz. The sweep time is coupled.

RESULTS

HOPPING FREQUENCY SEPARATION

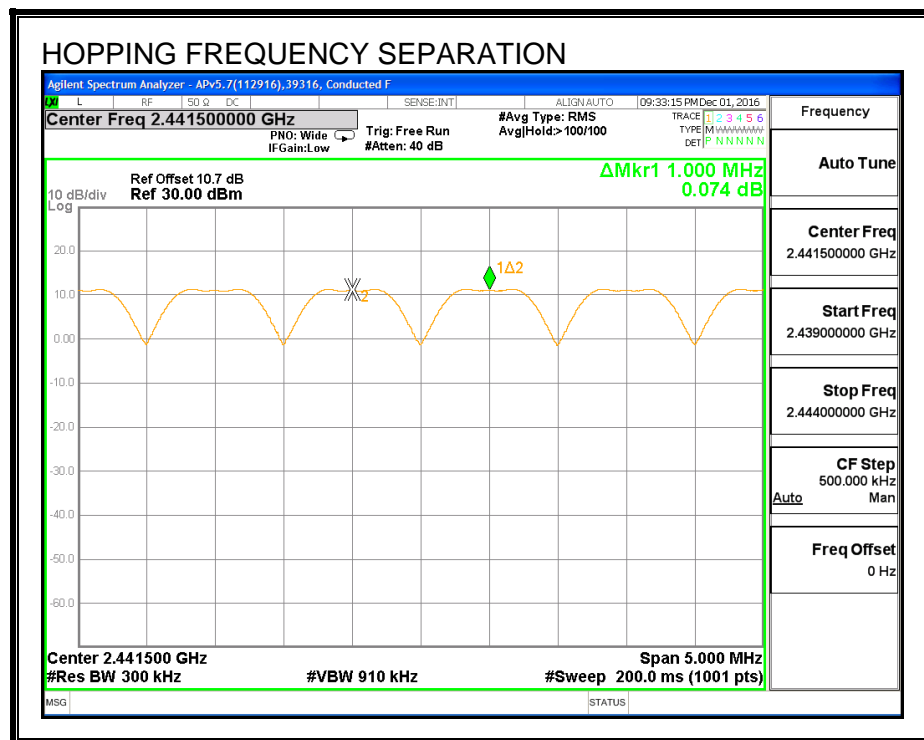

7.2.3. NUMBER OF HOPPING CHANNELS

LIMIT

FCC §15.247 (a) (1) (iii)

IC RSS-247 (5.1) (4)

Frequency hopping systems in the 2400 – 2483.5 MHz band shall use at least 15 non-overlapping channels.

TEST PROCEDURE

The transmitter output is connected to a spectrum analyzer. The span is set to cover the entire authorized band, in either a single sweep or in multiple contiguous sweeps. The RBW is set to a maximum of 1 % of the span. The analyzer is set to Max Hold.

RESULTS

Normal Mode: 79 Channels observed.

NUMBER OF HOPPING CHANNELS

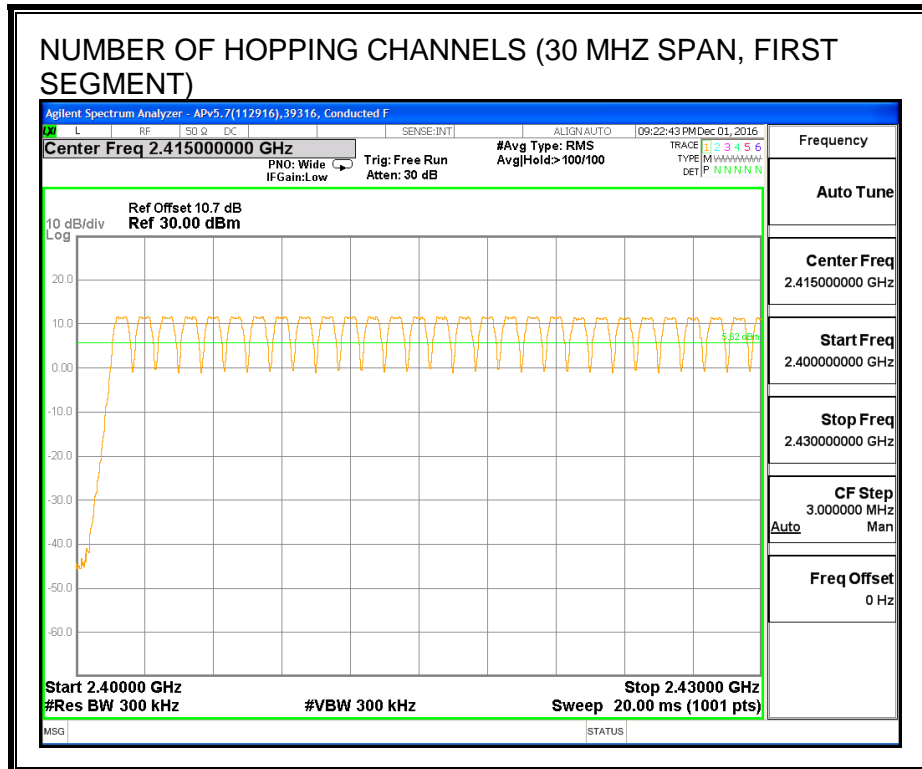
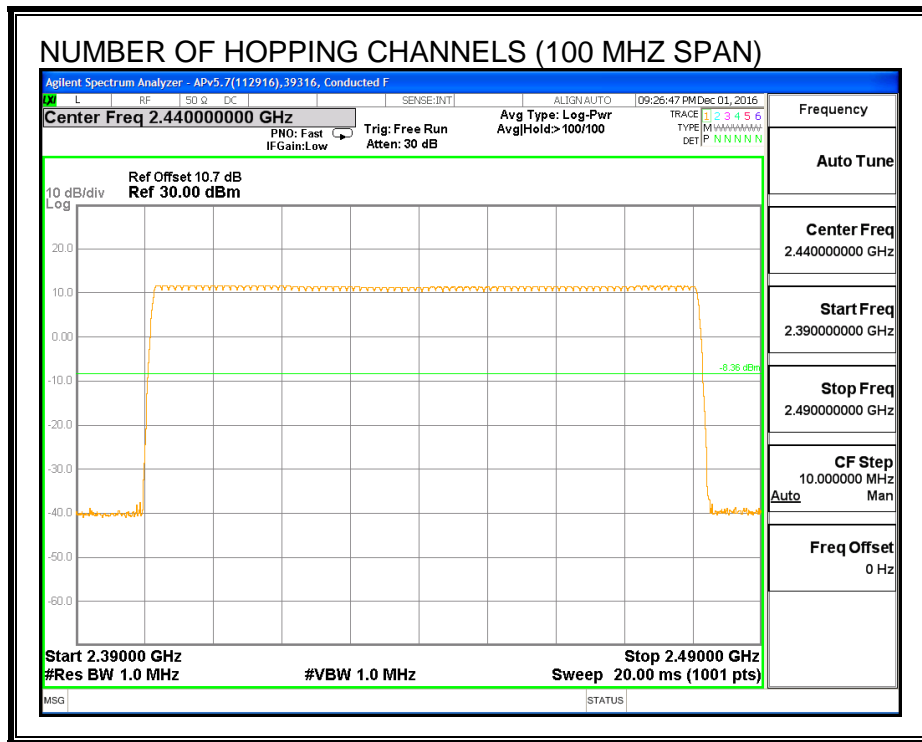

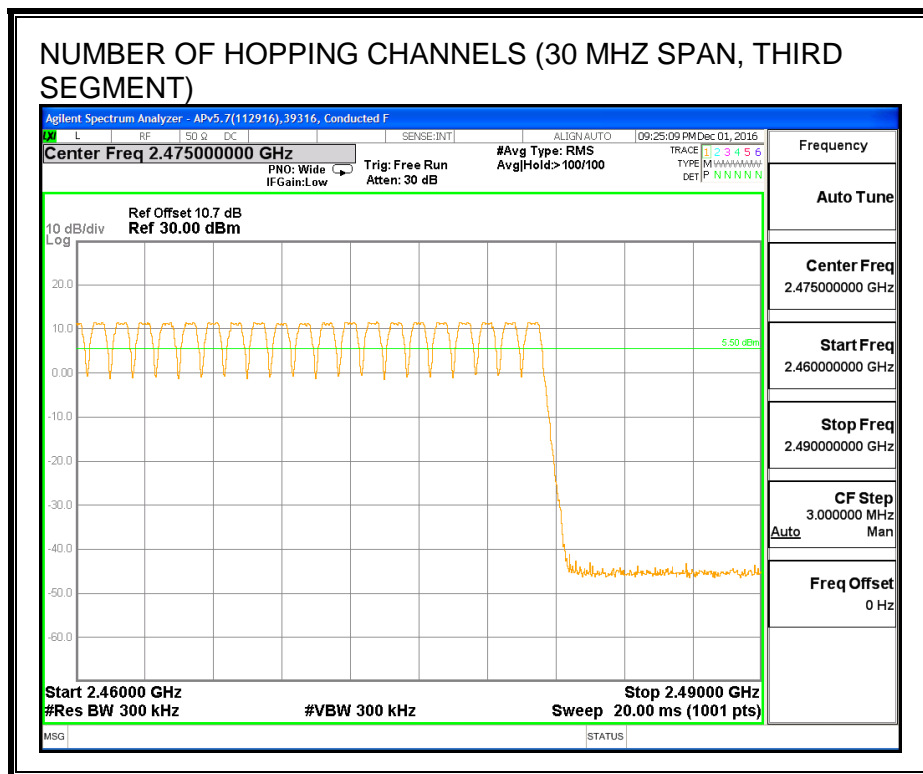
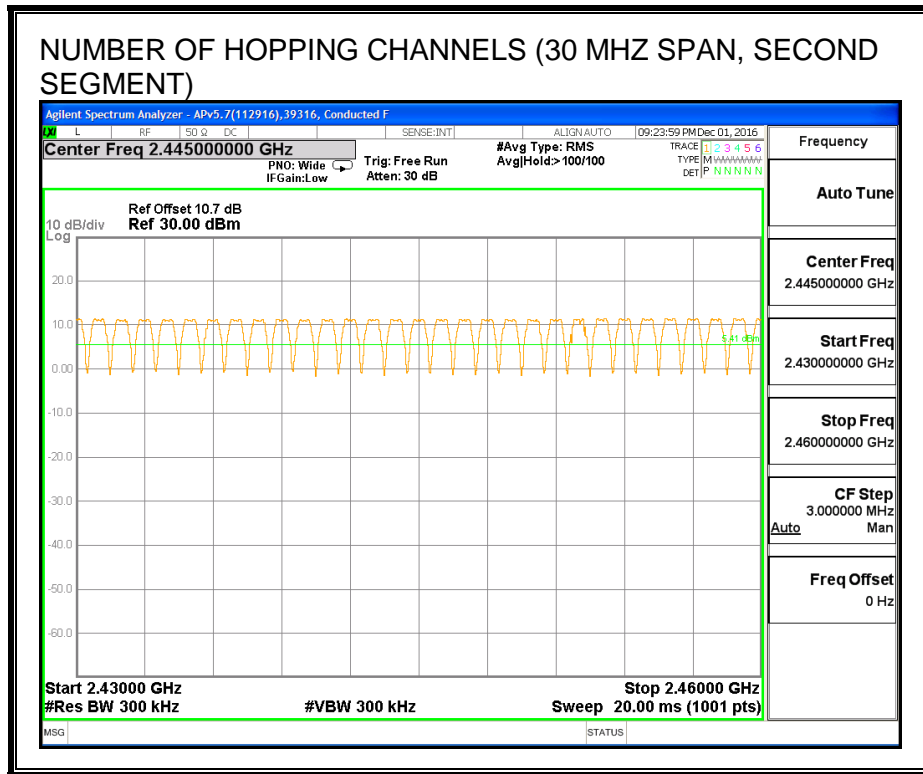

7.2.4. AVERAGE TIME OF OCCUPANCY

LIMIT

FCC §15.247 (a) (1) (iii)

IC RSS-247 (5.1) (4)

The average time of occupancy on any channel shall not be greater than 0.4 seconds within a period of 0.4 seconds multiplied by the number of hopping channels employed.

TEST PROCEDURE

The transmitter output is connected to a spectrum analyzer. The span is set to 0 Hz, centered on a single, selected hopping channel. The width of a single pulse is measured in a fast scan. The number of pulses is measured in a 3.16 second scan, to enable resolution of each occurrence.

The average time of occupancy in the specified 31.6 second period (79 channels * 0.4 s) is equal to $10 * (\# \text{ of pulses in } 3.16 \text{ s}) * \text{ pulse width}$.

For AFH mode, the average time of occupancy in the specified 8 second period (20 channels * 0.4 seconds) is equal to $10 * (\# \text{ of pulses in } 0.8 \text{ s}) * \text{ pulse width}$.

RESULTS

DH Packet	Pulse Width (msec)	Number of Pulses in 3.16 seconds	Average Time of Occupancy (sec)	Limit (sec)	Margin (sec)
GFSK Normal Mode					
DH1	0.384	5	0.019	0.4	-0.381
DH3	1.628	5	0.081	0.4	-0.319
DH5	2.876	5	0.144	0.4	-0.256
DH Packet	Pulse Width (msec)	Number of Pulses in 0.8 seconds	Average Time of Occupancy (sec)	Limit (sec)	Margin (sec)
GFSK AFH Mode					
DH1	0.384	1.25	0.005	0.4	-0.395
DH3	1.628	1.25	0.020	0.4	-0.380
DH5	2.876	1.25	0.036	0.4	-0.364

PULSE WIDTH - DH1

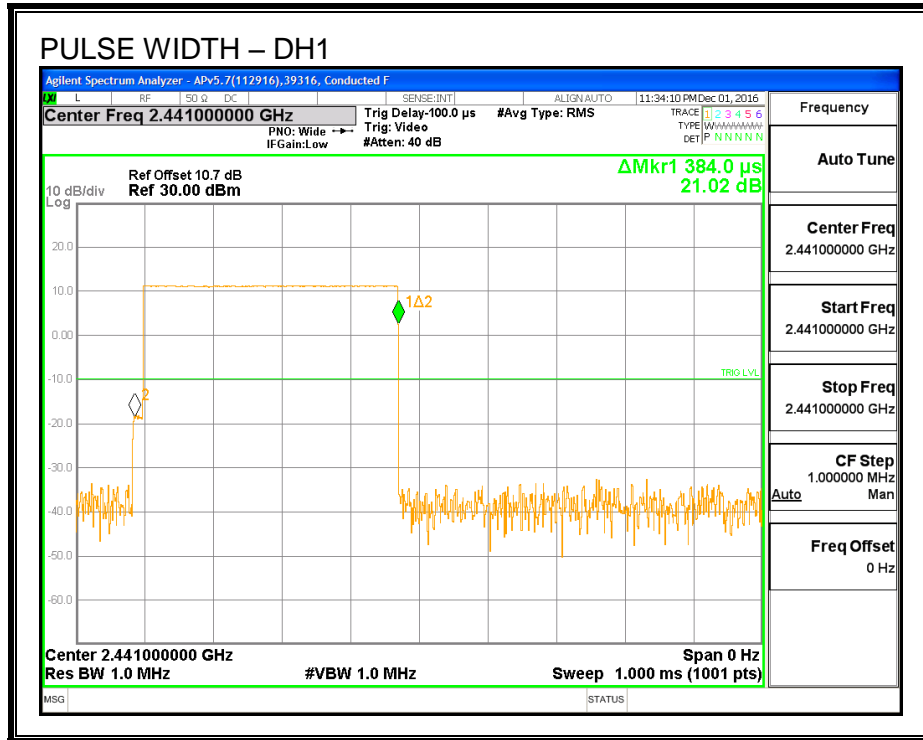

NUMBER OF PULSES IN 3.16 SECOND OBSERVATION PERIOD – DH1

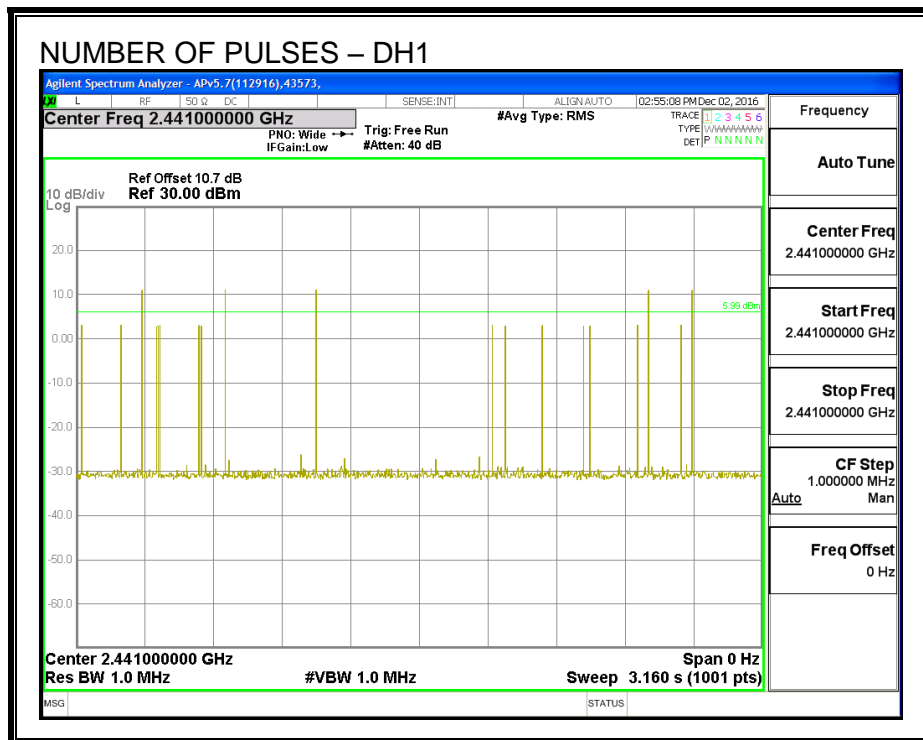

PULSE WIDTH – DH3

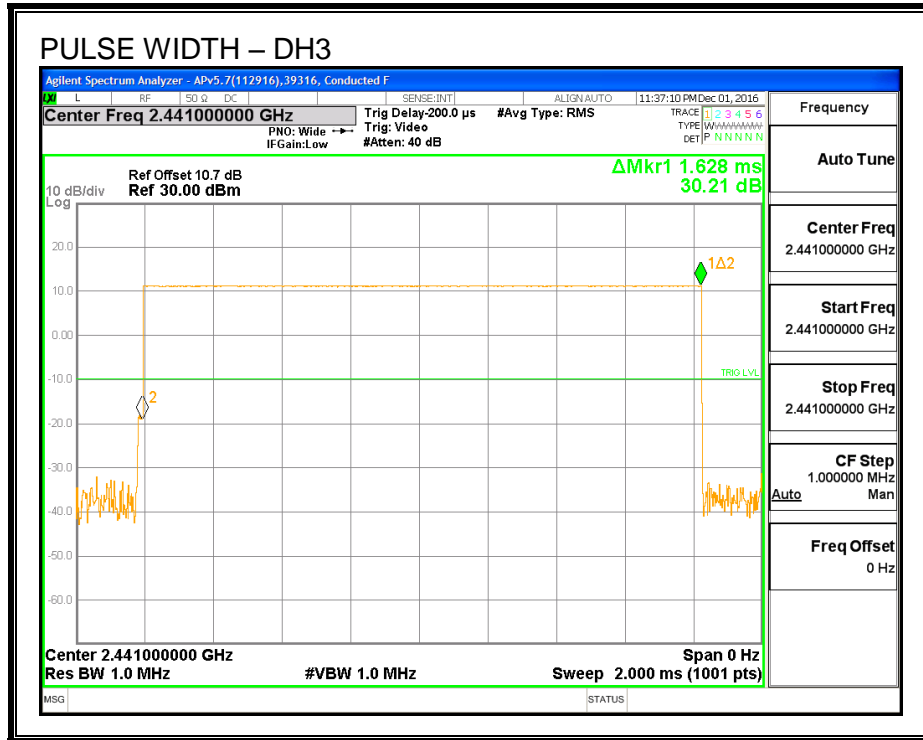

NUMBER OF PULSES IN 3.16 SECOND OBSERVATION PERIOD – DH3

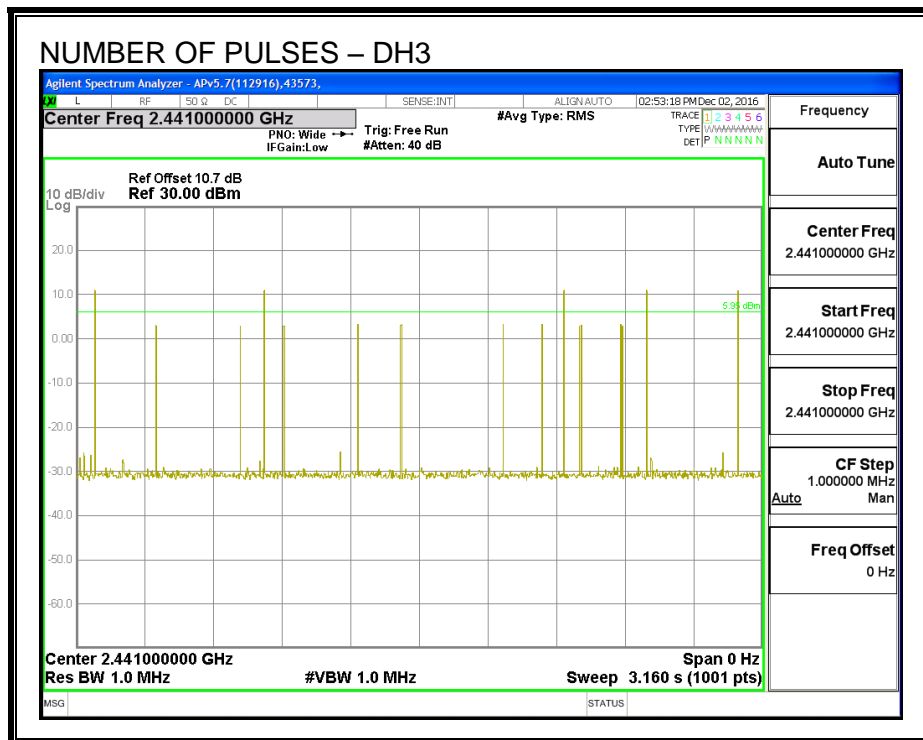

PULSE WIDTH – DH5

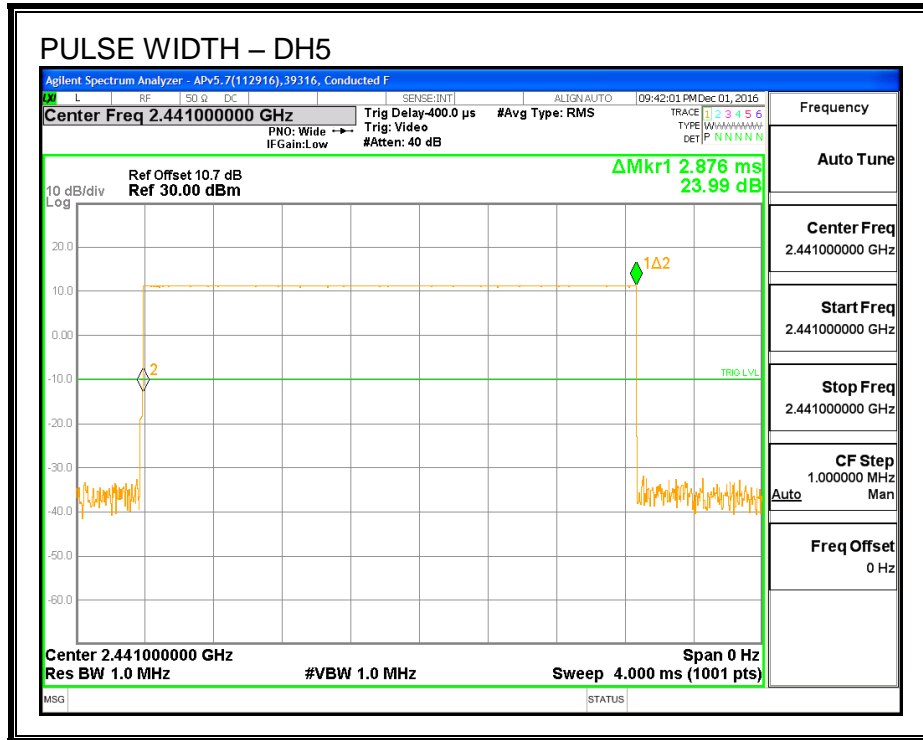

NUMBER OF PULSES IN 3.16 SECOND OBSERVATION PERIOD – DH5

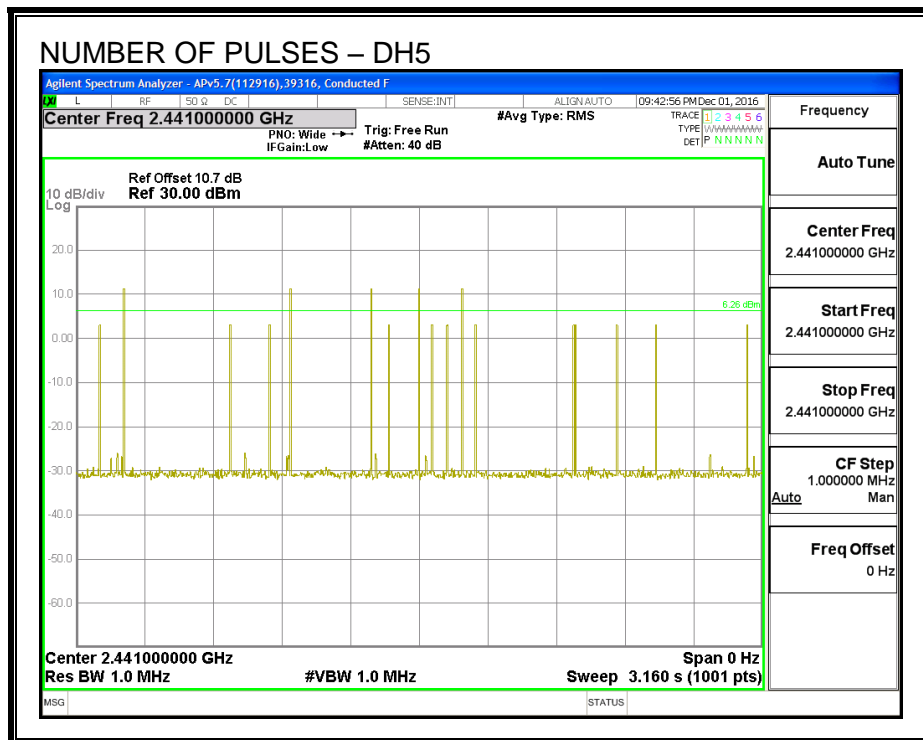

7.2.5. OUTPUT POWER

LIMIT

§15.247 (b) (1)

RSS-247 (5.4) (2)

The maximum antenna gain is less than 6 dBi, therefore the limit is 30 dBm.

TEST PROCEDURE

The transmitter output is connected to a power meter.

RESULTS

ID:	43573	Date:	12/2/16
------------	-------	--------------	---------

Channel	Frequency (MHz)	Output Power (dBm)	Limit (dBm)	Margin (dB)
Low	2402	11.76	30	-18.24
Middle	2441	11.48	30	-18.52
High	2480	11.61	30	-18.39

7.2.6. AVERAGE POWER

LIMIT

None; for reporting purposes only.

TEST PROCEDURE

The transmitter output is connected to a power meter.

RESULTS

The cable assembly insertion loss of 11 dB (including 10 dB pad and 1 dB cable) was entered as an offset in the power meter to allow for direct reading of power.

ID:	43573	Date:	12/2/16
------------	-------	--------------	---------

Channel	Frequency (MHz)	Average Power (dBm)
Low	2402	11.41
Middle	2441	11.18
High	2480	11.33

7.2.7. CONDUCTED SPURIOUS EMISSIONS

LIMITS

FCC §15.247 (d)

IC RSS-247 (5.5)

Limit = -20 dBc

TEST PROCEDURE

The transmitter output is connected to a spectrum analyzer. The resolution bandwidth is set to 100 kHz. The video bandwidth is set to 300 kHz.

The spectrum from 30 MHz to 26 GHz is investigated with the transmitter set to the lowest, middle, and highest channels.

The bandedges at 2.4 and 2.4835 GHz are investigated with the transmitter set to the normal hopping mode.

RESULTS

SPURIOUS EMISSIONS, LOW CHANNEL

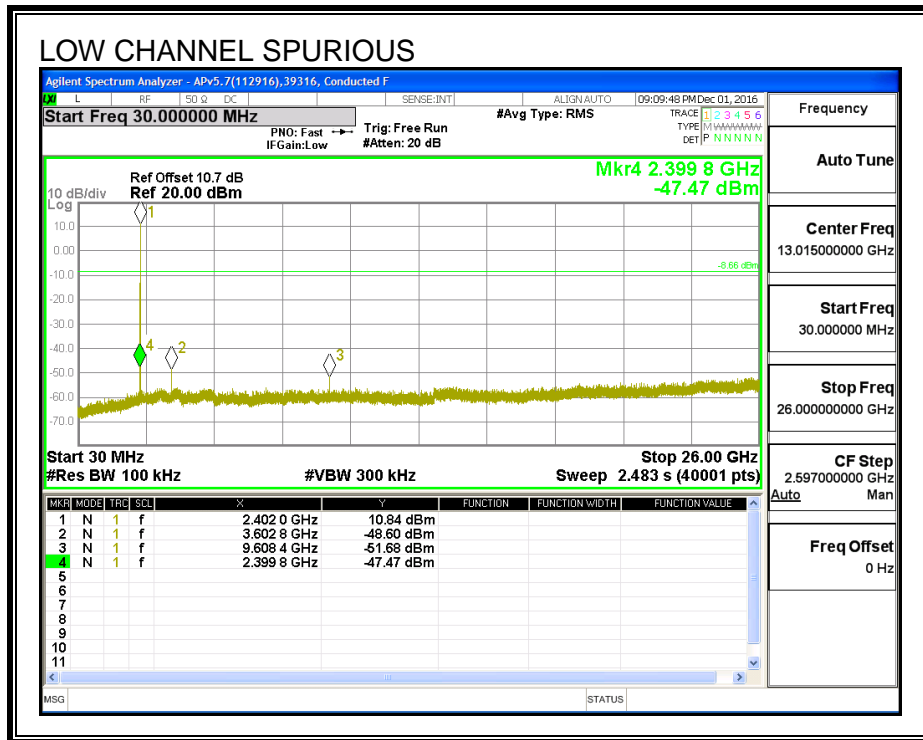
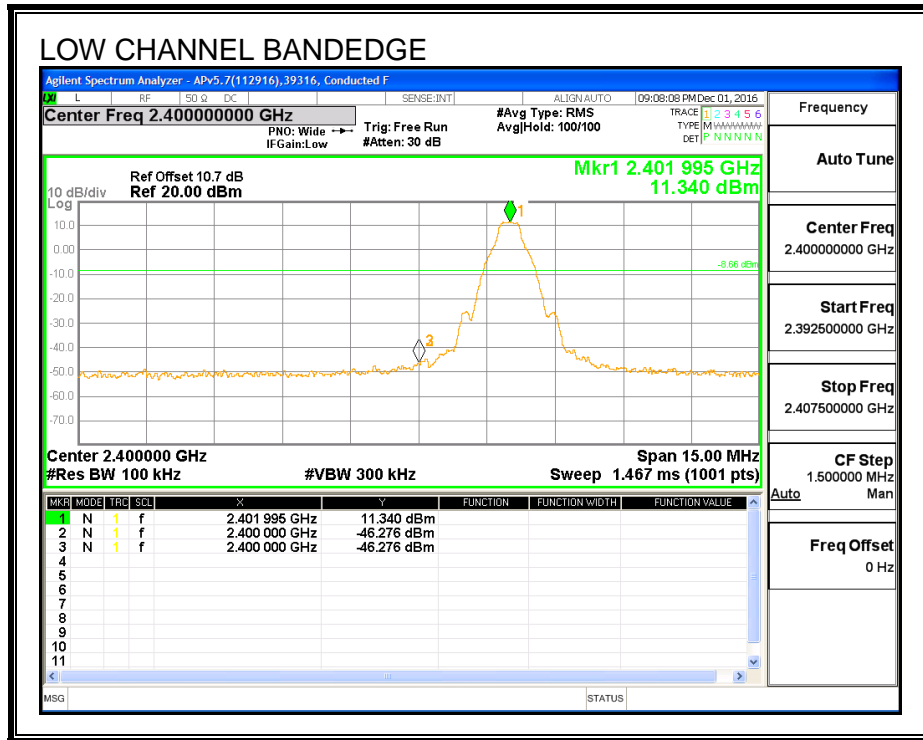

SPURIOUS EMISSIONS, MID CHANNEL

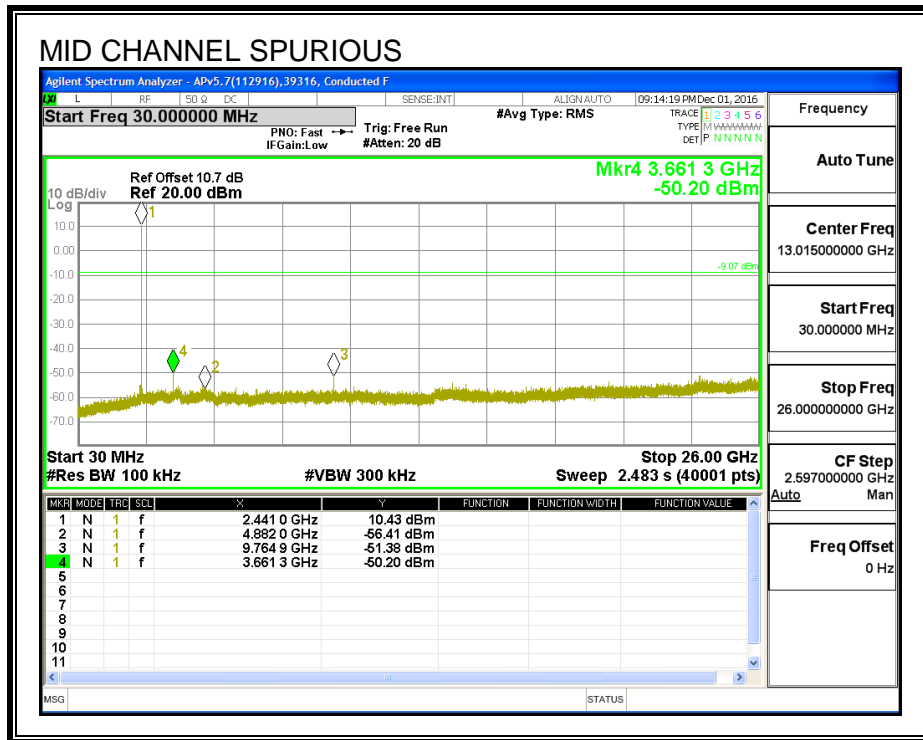
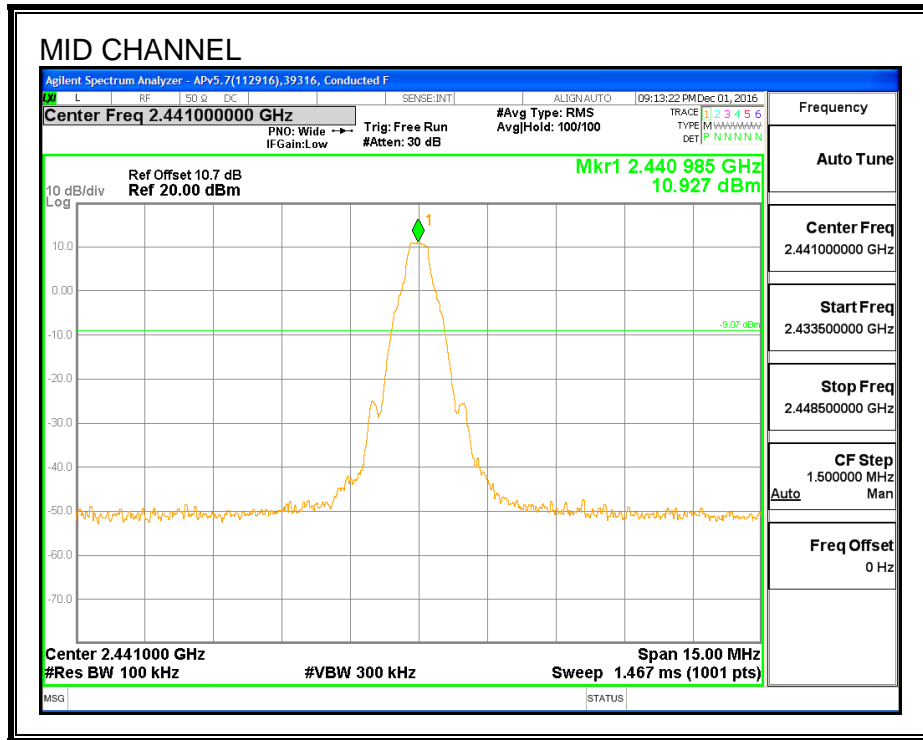

SPURIOUS EMISSIONS, HIGH CHANNEL

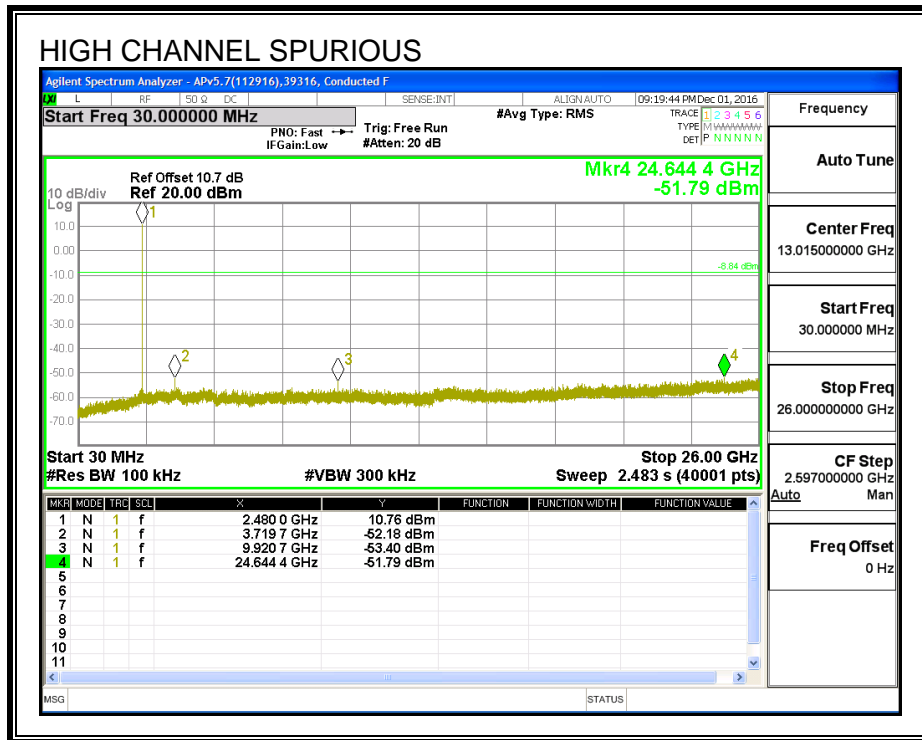
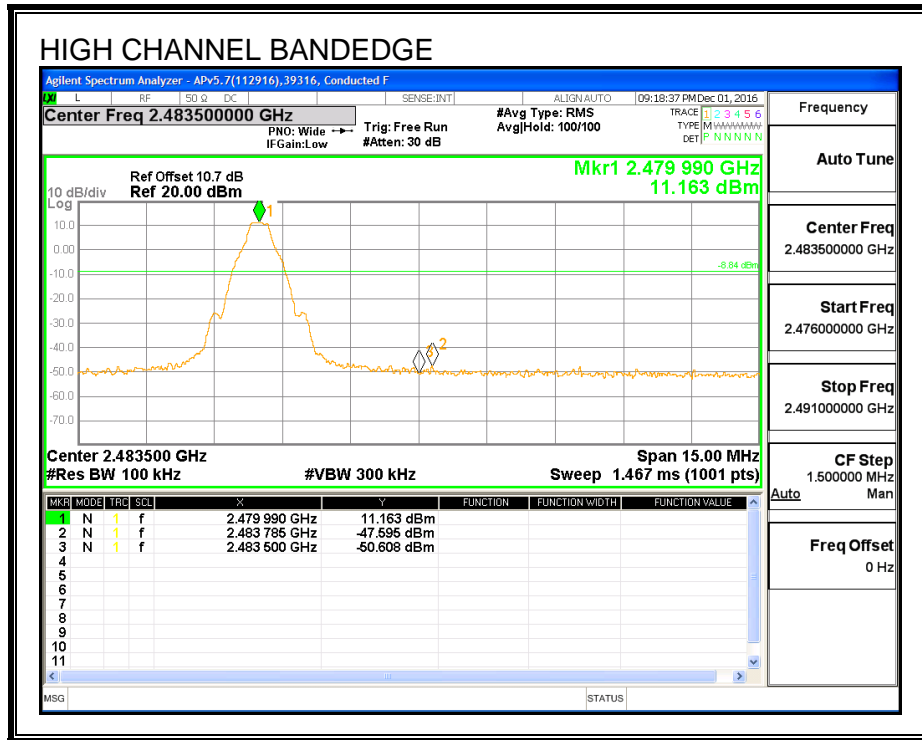

SPURIOUS BANDEGE EMISSIONS WITH HOPPING ON

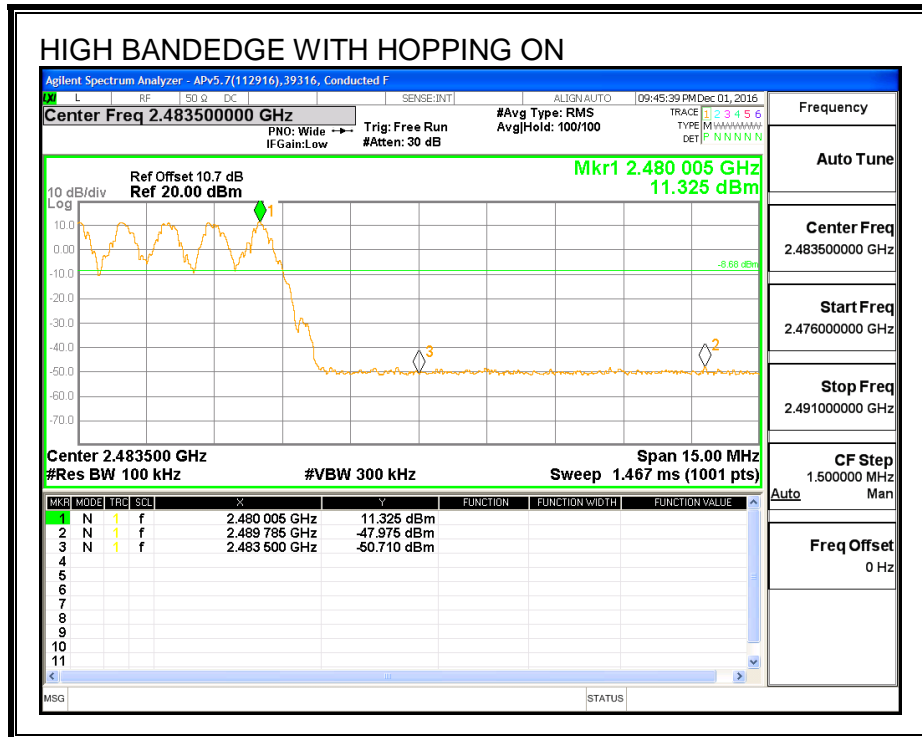
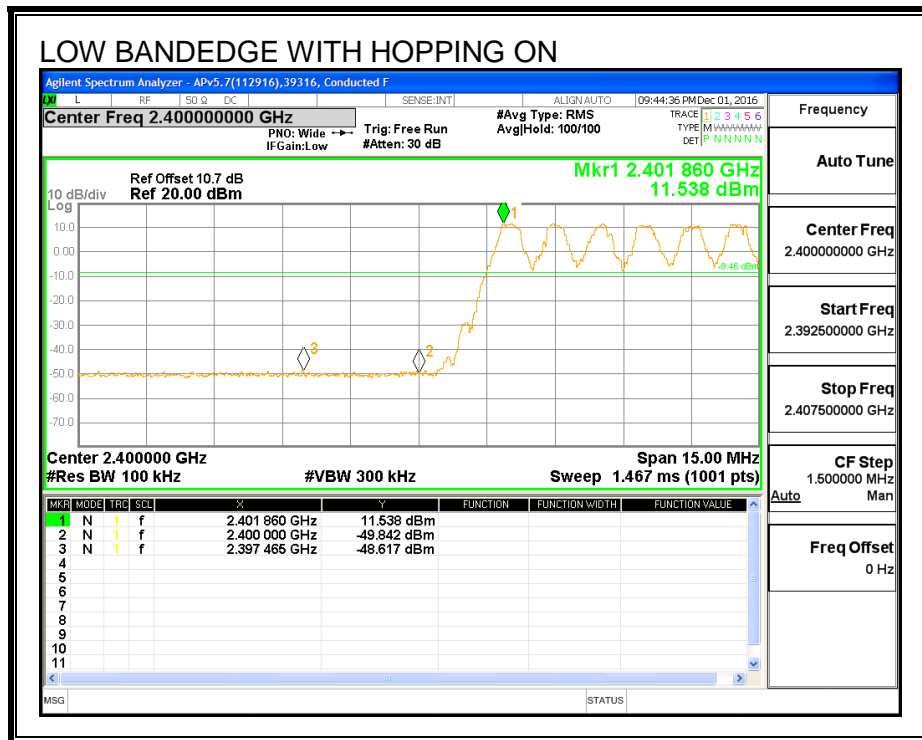

7.3. ENHANCED DATA RATE QPSK MODULATION

7.3.1. 20 dB AND 99% BANDWIDTH

LIMIT

None; for reporting purposes only.

TEST PROCEDURE

The transmitter output is connected to a spectrum analyzer. The RBW is set to $\geq 1\%$ of the 20 dB bandwidth. The VBW is set to \geq RBW. The sweep time is coupled.

RESULTS

Channel	Frequency (MHz)	20 dB Bandwidth (KHz)	99% Bandwidth (KHz)
Low	2402	1320.0	1202.4
Middle	2441	1343.0	1203.5
High	2480	1358.0	1243.1

20 dB AND 99% BANDWIDTH

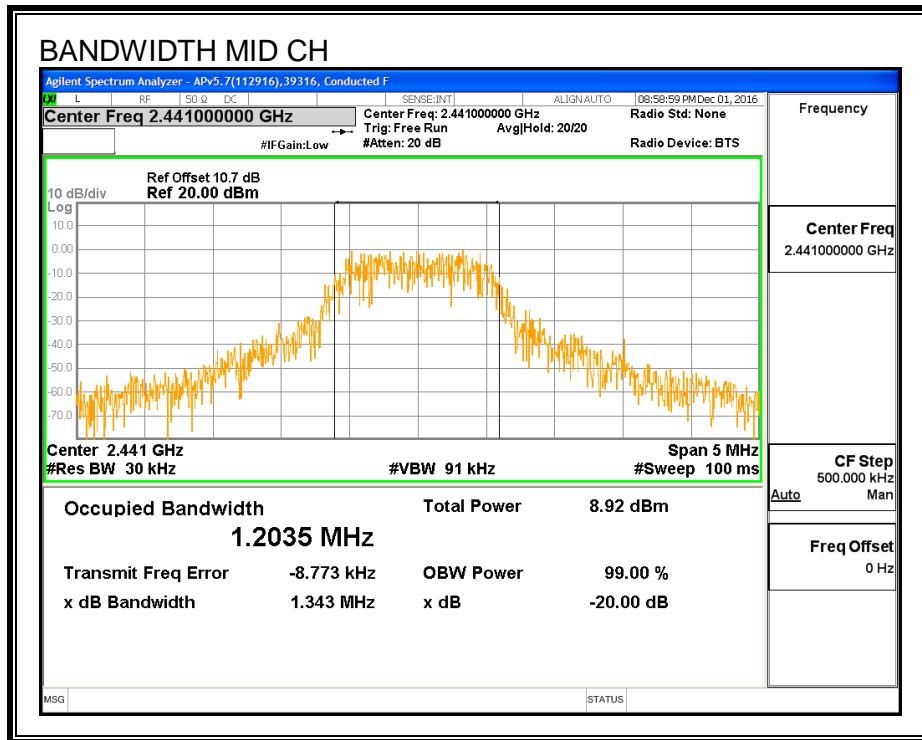
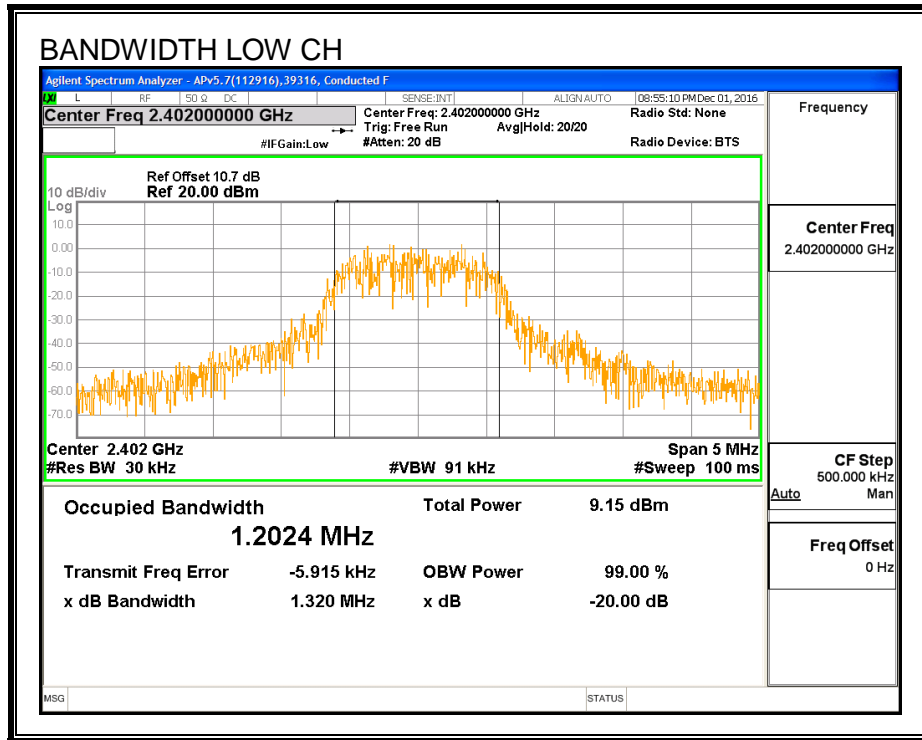

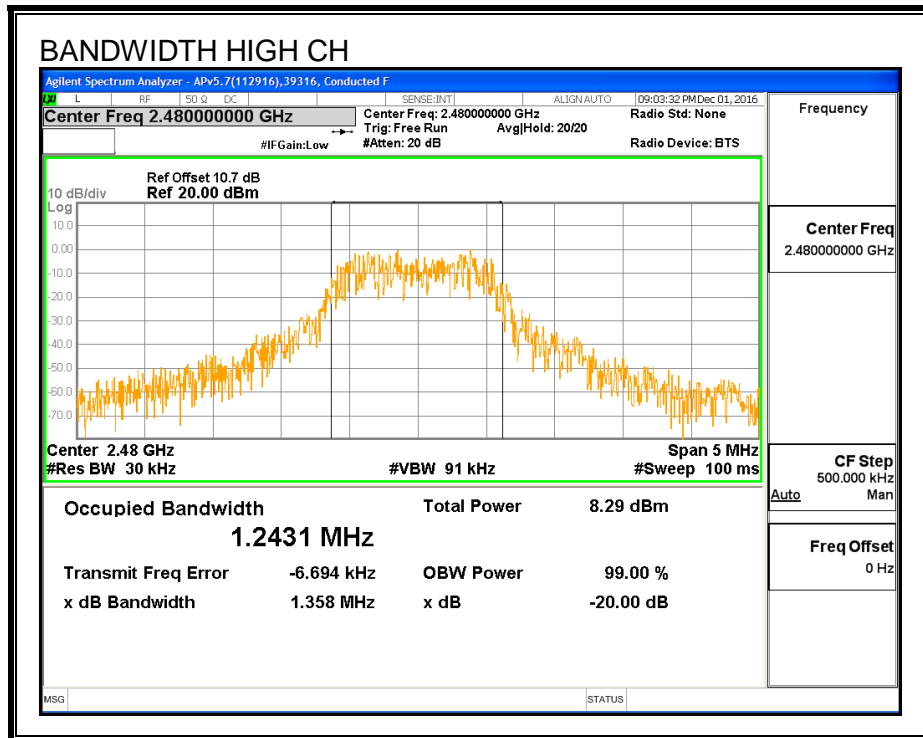

7.3.3. NUMBER OF HOPPING CHANNELS

LIMIT

FCC §15.247 (a) (1) (iii)

IC RSS-247 (5.1) (4)

Frequency hopping systems in the 2400 – 2483.5 MHz band shall use at least 15 non-overlapping channels.

TEST PROCEDURE

The transmitter output is connected to a spectrum analyzer. The span is set to cover the entire authorized band, in either a single sweep or in multiple contiguous sweeps. The RBW is set to a maximum of 1 % of the span. The analyzer is set to Max Hold.

RESULTS

Normal Mode: 79 Channels observed.

NUMBER OF HOPPING CHANNELS

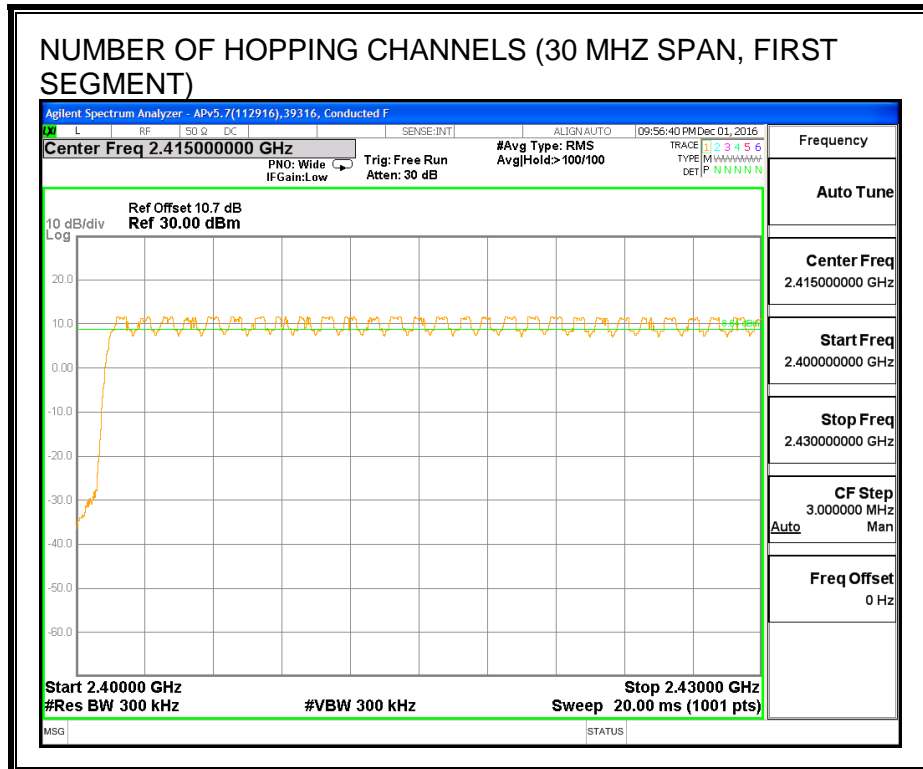
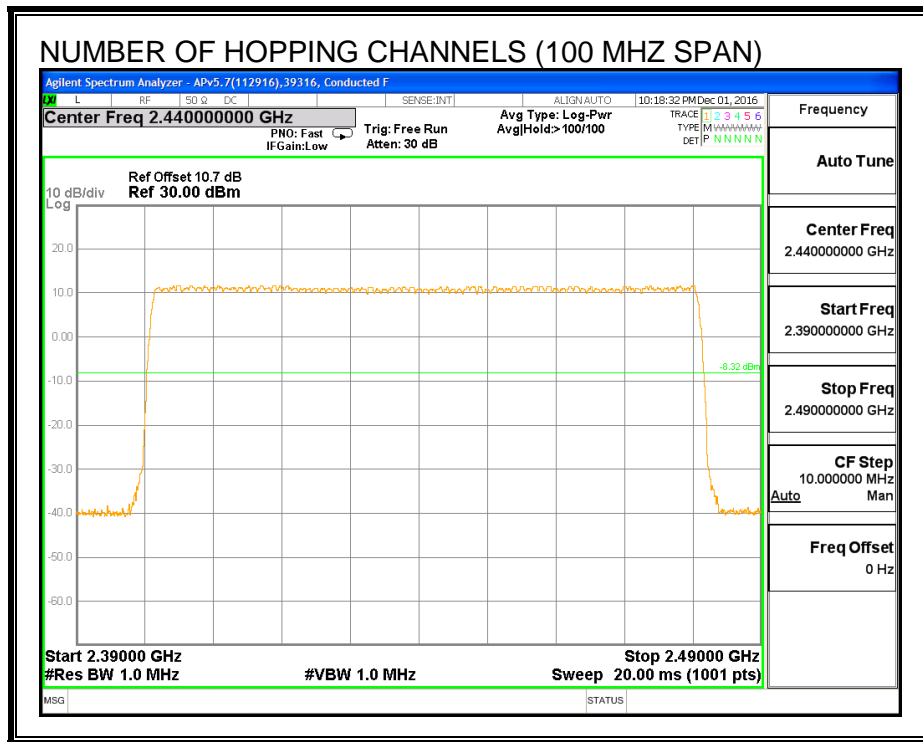

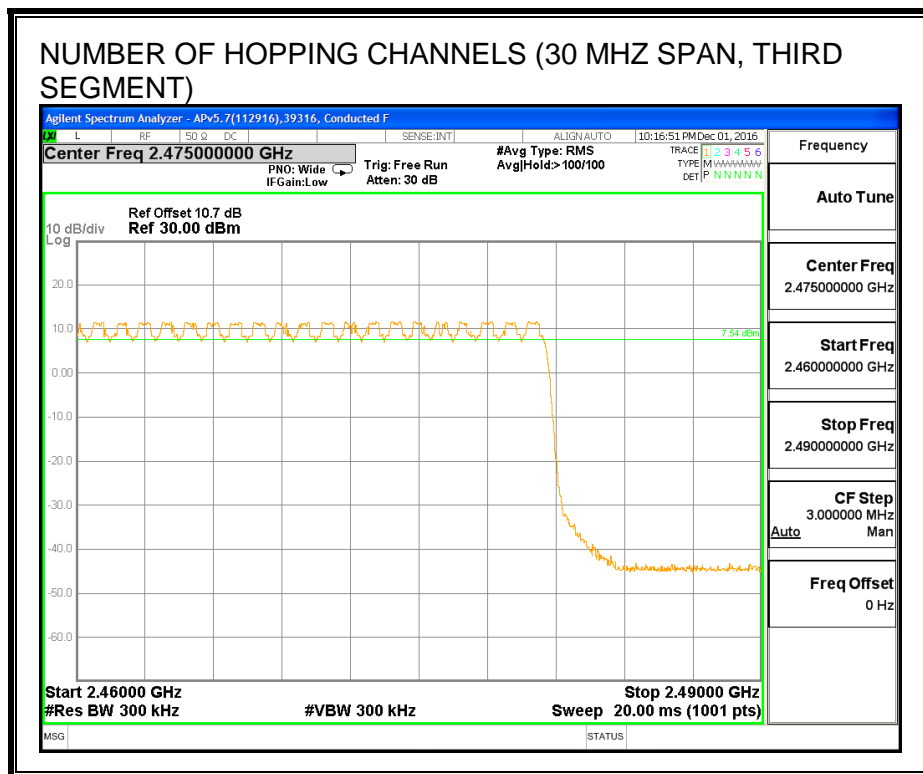
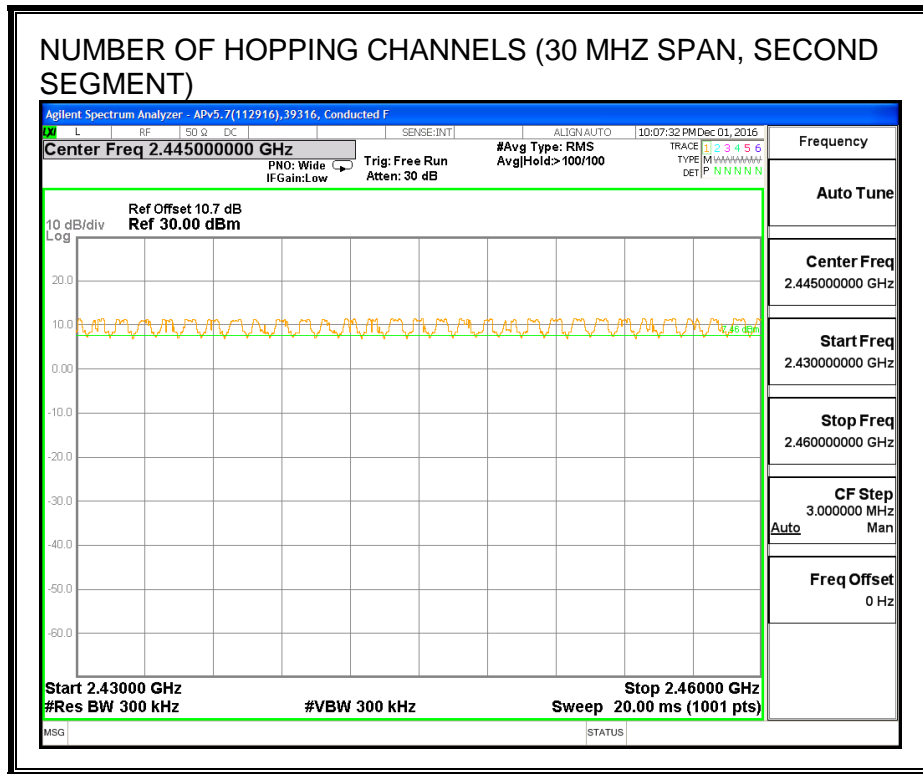

7.3.4. AVERAGE TIME OF OCCUPANCY

LIMIT

FCC §15.247 (a) (1) (iii)

IC RSS-247 (5.1) (4)

The average time of occupancy on any channel shall not be greater than 0.4 seconds within a period of 0.4 seconds multiplied by the number of hopping channels employed.

TEST PROCEDURE

The transmitter output is connected to a spectrum analyzer. The span is set to 0 Hz, centered on a single, selected hopping channel. The width of a single pulse is measured in a fast scan. The number of pulses is measured in a 3.16 second scan, to enable resolution of each occurrence.

The average time of occupancy in the specified 31.6 second period (79 channels * 0.4 s) is equal to $10 * (\# \text{ of pulses in } 3.16 \text{ s}) * \text{ pulse width}$.

For AFH mode, the average time of occupancy in the specified 8 second period (20 channels * 0.4 seconds) is equal to $10 * (\# \text{ of pulses in } 0.8 \text{ s}) * \text{ pulse width}$.

RESULTS

DH Packet	Pulse Width (msec)	Number of Pulses in 3.16 seconds	Average Time of Occupancy (sec)	Limit (sec)	Margin (sec)
GFSK Normal Mode					
2DH1	0.398	6	0.024	0.4	-0.376
2DH3	1.638	6	0.098	0.4	-0.302
2DH5	2.884	5	0.144	0.4	-0.256
DH Packet	Pulse Width (msec)	Number of Pulses in 0.8 seconds	Average Time of Occupancy (sec)	Limit (sec)	Margin (sec)
GFSK AFH Mode					
2DH1	0.398	1.5	0.006	0.4	-0.394
2DH3	1.638	1.5	0.025	0.4	-0.375
2DH5	2.884	1.25	0.036	0.4	-0.364

PULSE WIDTH - 2DH1

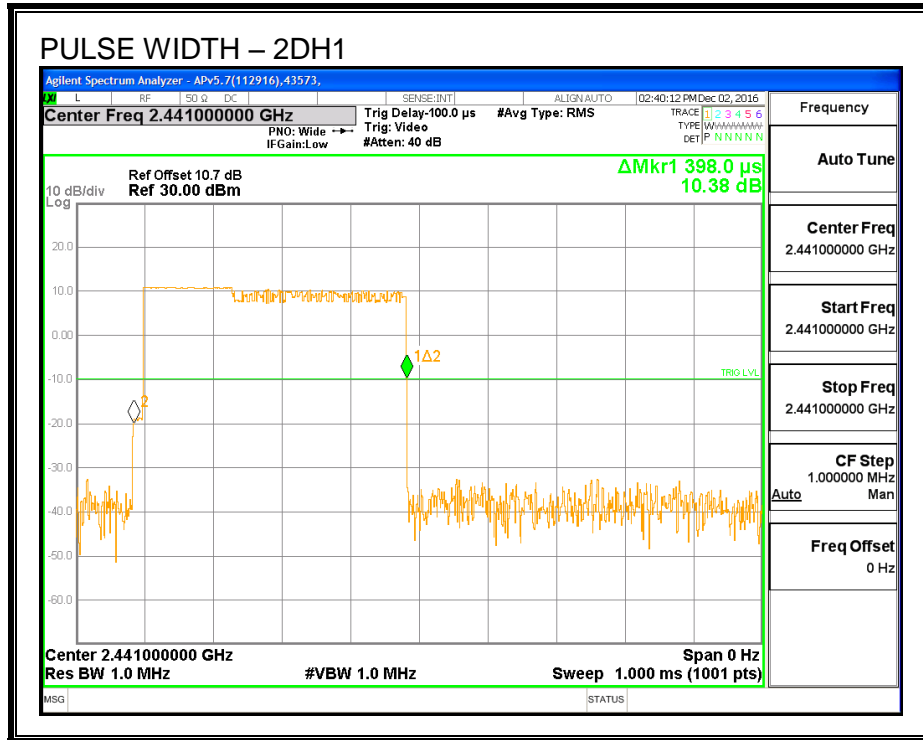

NUMBER OF PULSES IN 3.16 SECOND OBSERVATION PERIOD – 2DH1

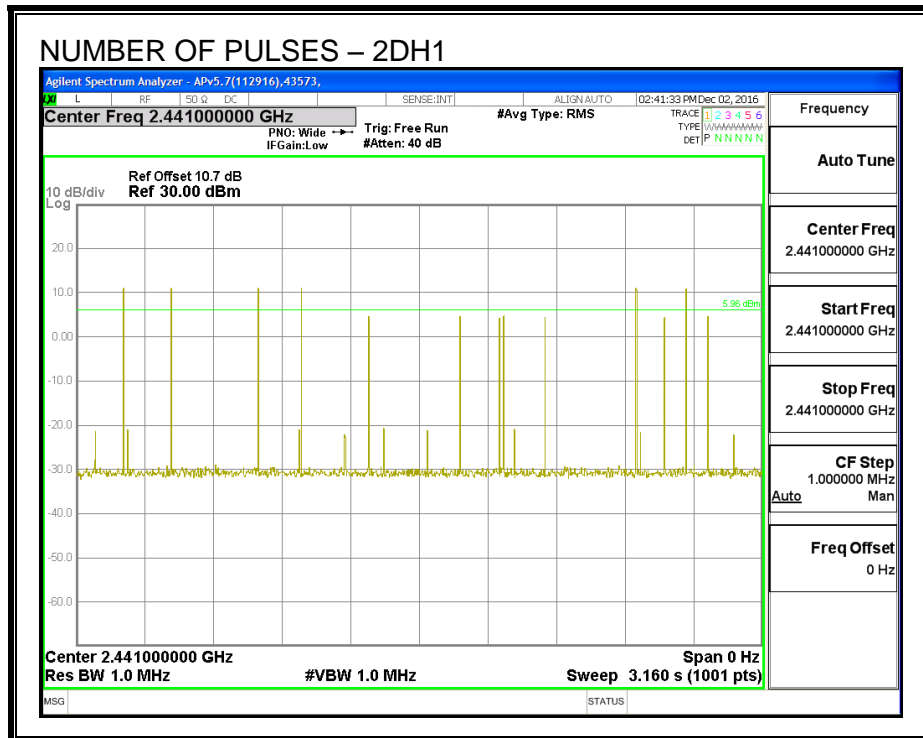

PULSE WIDTH – 2DH3

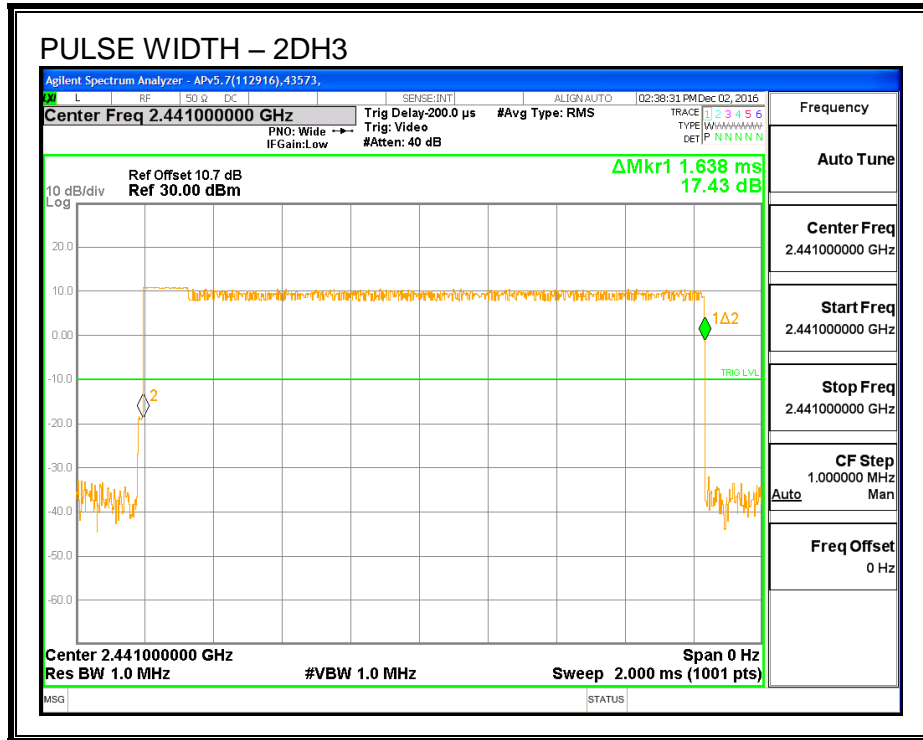

NUMBER OF PULSES IN 3.16 SECOND OBSERVATION PERIOD – 2DH3

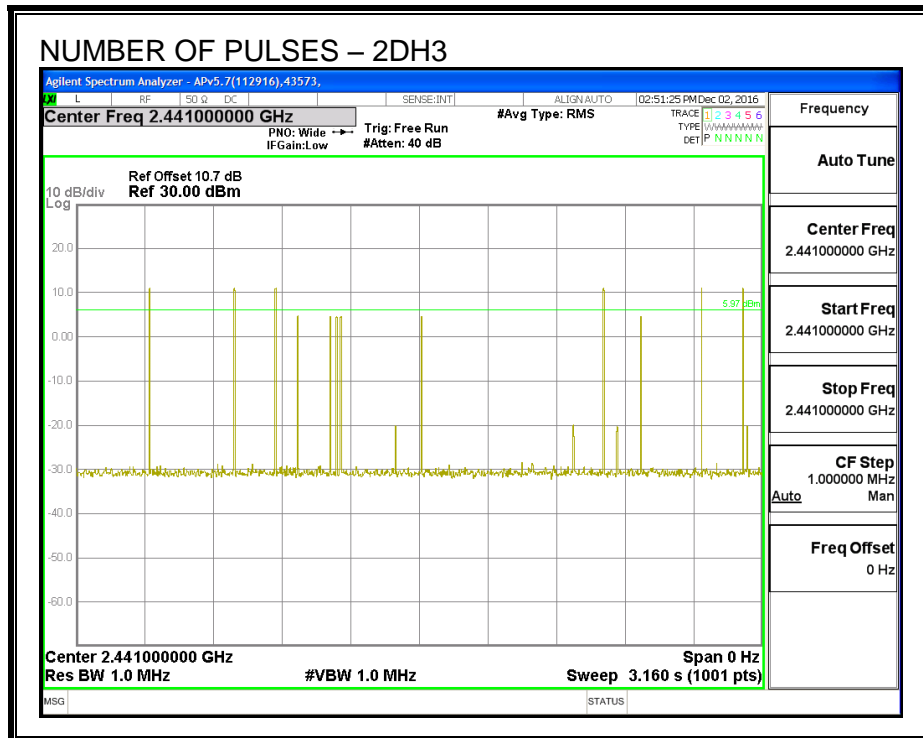

PULSE WIDTH – 2DH5

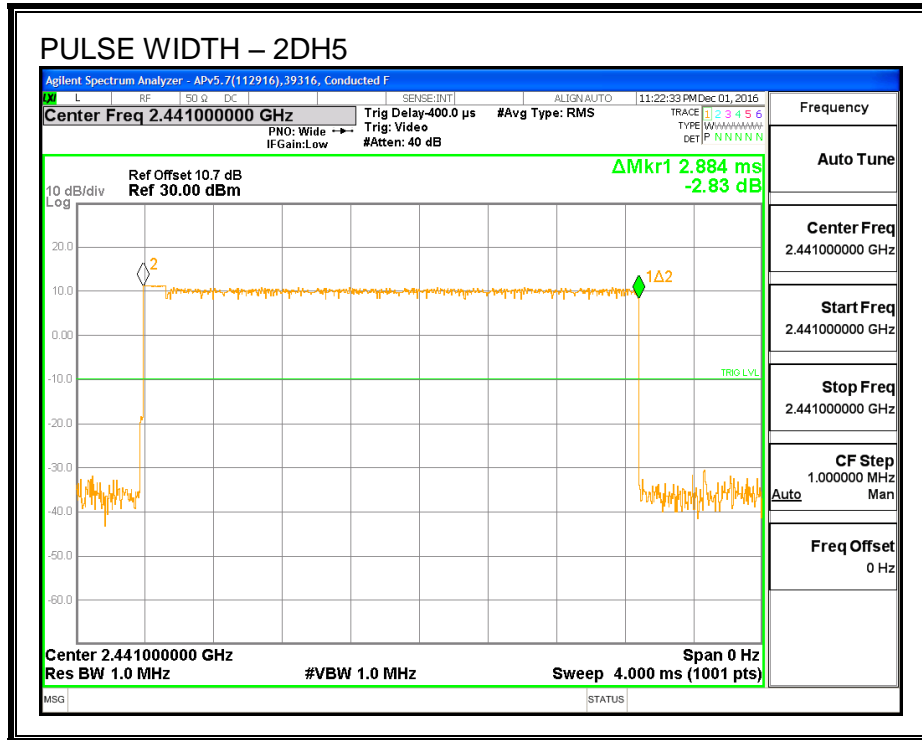

NUMBER OF PULSES IN 3.16 SECOND OBSERVATION PERIOD – 2DH5

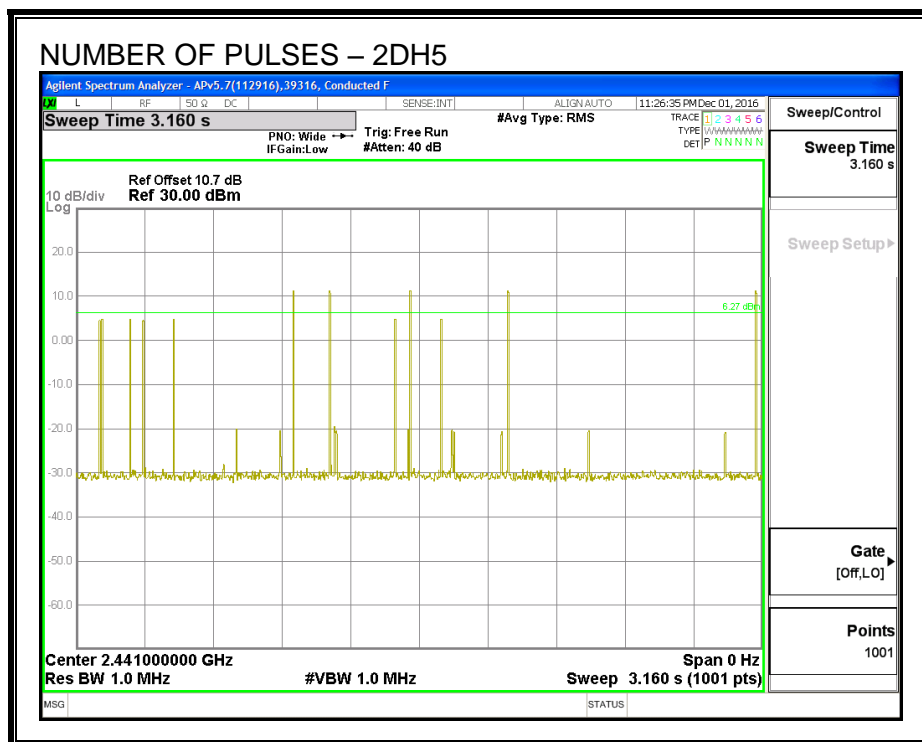

7.3.5. OUTPUT POWER

LIMIT

§15.247 (b) (1)

RSS-247 (5.4) (2)

The maximum antenna gain is less than 6 dBi, therefore the limit is 30 dBm.

Alternatively, frequency hopping systems operating in the 2400-2483.5 MHz band may have hopping channel carrier frequencies that are separated by 25 kHz or two-thirds of the 20 dB bandwidth of the hopping channel, whichever is greater, provided the systems operate with an output power no greater than 125 mW.

TEST PROCEDURE

The transmitter output is connected to a power meter.

RESULTS

ID:	43573	Date:	12/2/16
------------	-------	--------------	---------

Channel	Frequency (MHz)	Output Power (dBm)	Limit (dBm)	Margin (dB)
Low	2402	12.63	21	-8.34
Middle	2441	12.44	21	-8.53
High	2480	12.56	21	-8.41

7.3.6. AVERAGE POWER

LIMIT

None; for reporting purposes only.

TEST PROCEDURE

The transmitter output is connected to a power meter.

RESULTS

ID:	43573	Date:	12/2/16
------------	-------	--------------	---------

The cable assembly insertion loss of 11 dB (including 10 dB pad and 1 dB cable) was entered as an offset in the power meter to allow for direct reading of power.

Channel	Frequency (MHz)	Average Power (dBm)
Low	2402	9.87
Middle	2441	9.65
High	2480	9.77

7.3.7. CONDUCTED SPURIOUS EMISSIONS

LIMITS

FCC §15.247 (d)

IC RSS-247 (5.5)

Limit = -20 dBc

TEST PROCEDURE

The transmitter output is connected to a spectrum analyzer. The resolution bandwidth is set to 100 kHz. The video bandwidth is set to 300 kHz.

The spectrum from 30 MHz to 26 GHz is investigated with the transmitter set to the lowest, middle, and highest channels.

The bandedges at 2.4 and 2.4835 GHz are investigated with the transmitter set to the normal hopping mode.

RESULTS

SPURIOUS EMISSIONS, LOW CHANNEL

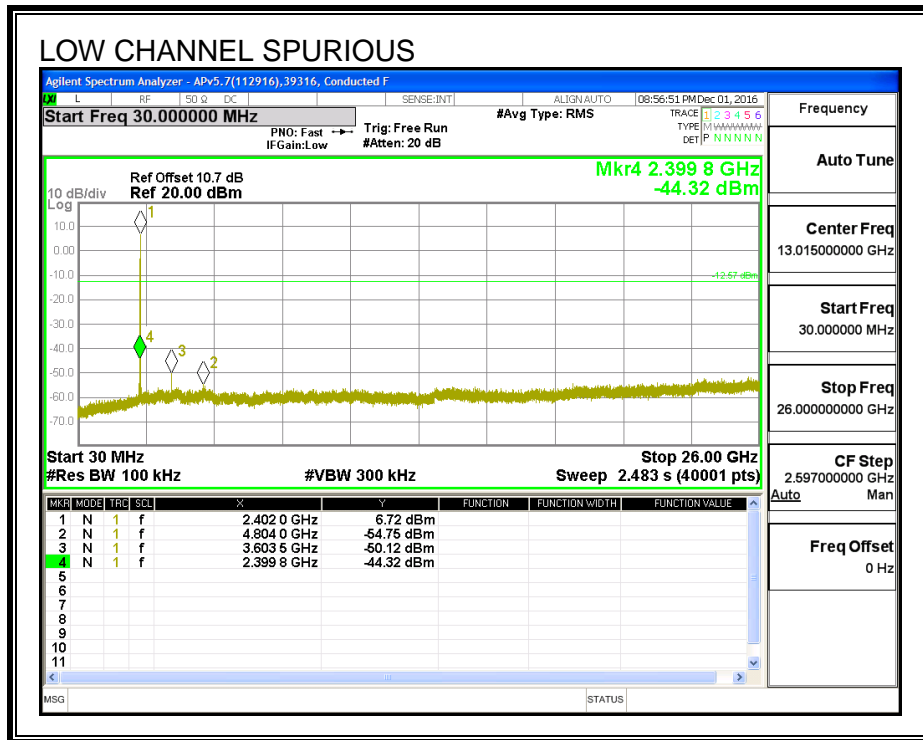
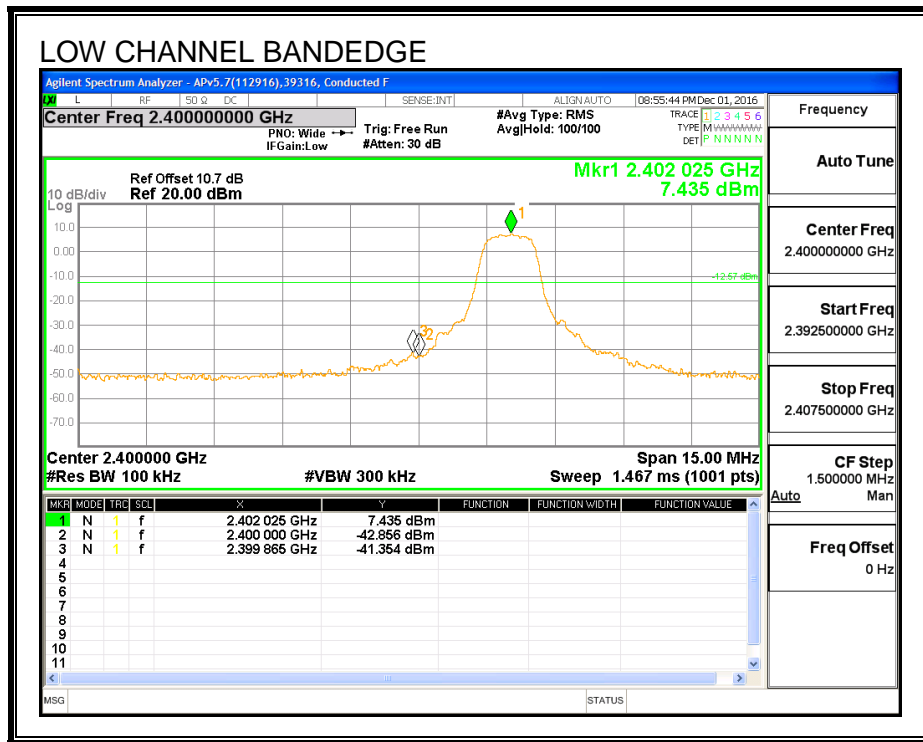

SPURIOUS EMISSIONS, MID CHANNEL

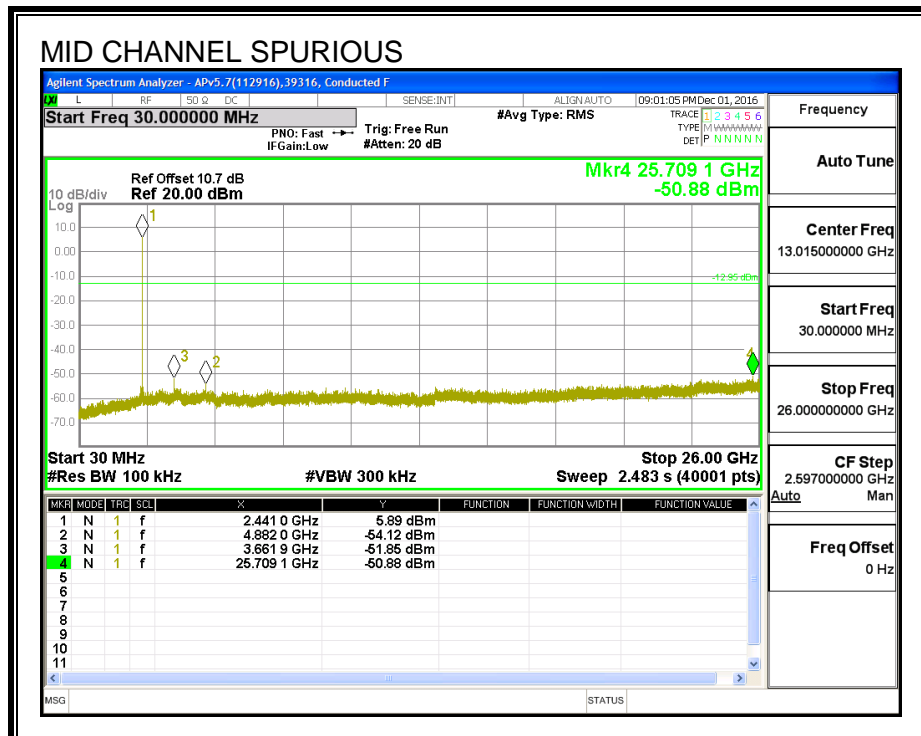
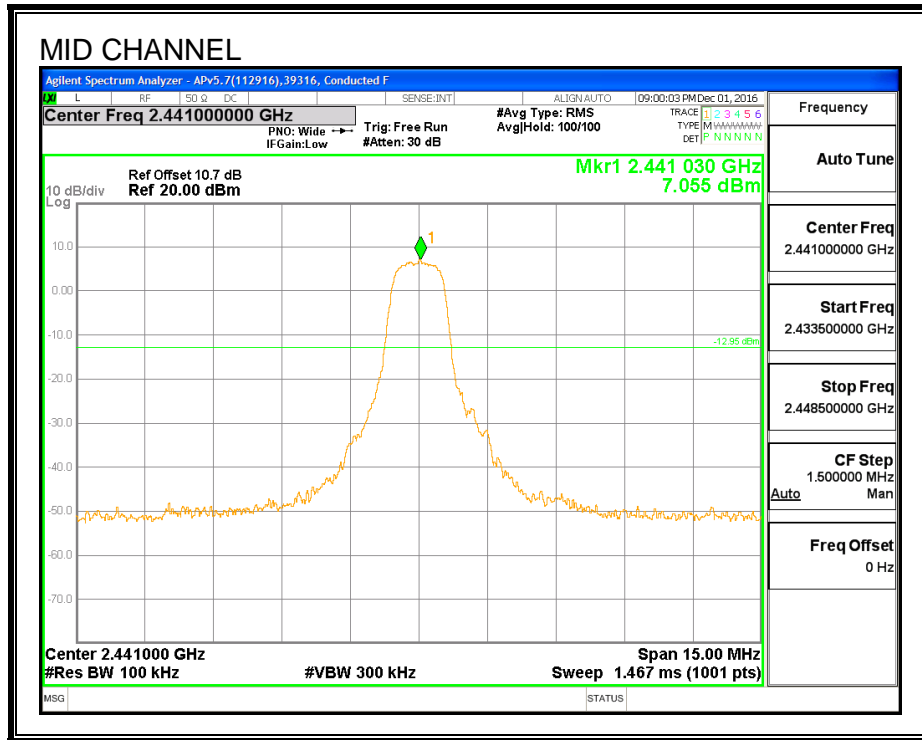

SPURIOUS EMISSIONS, HIGH CHANNEL

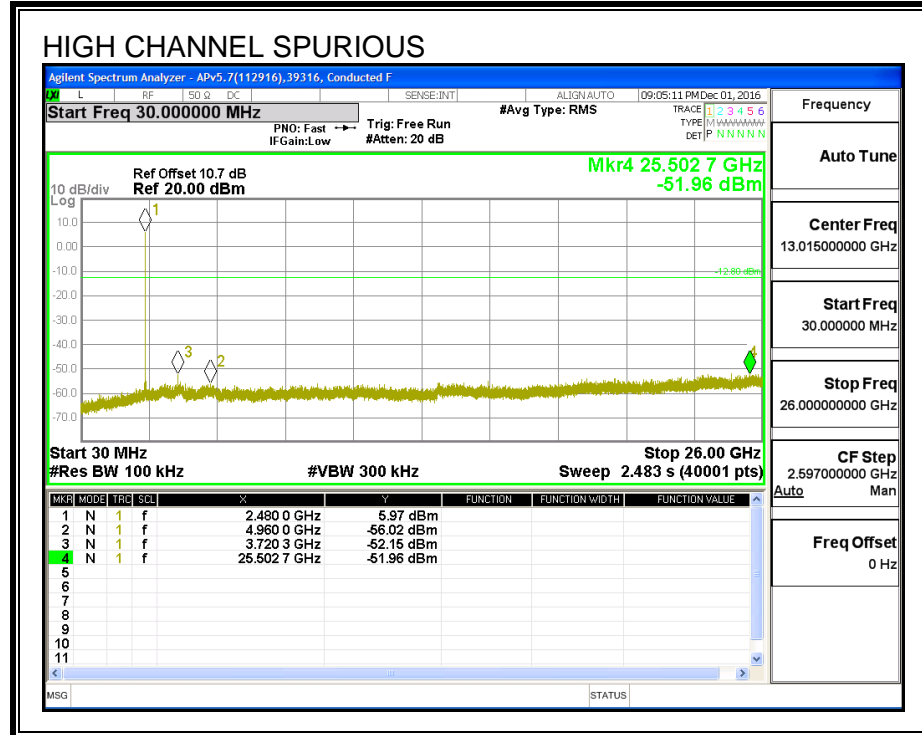
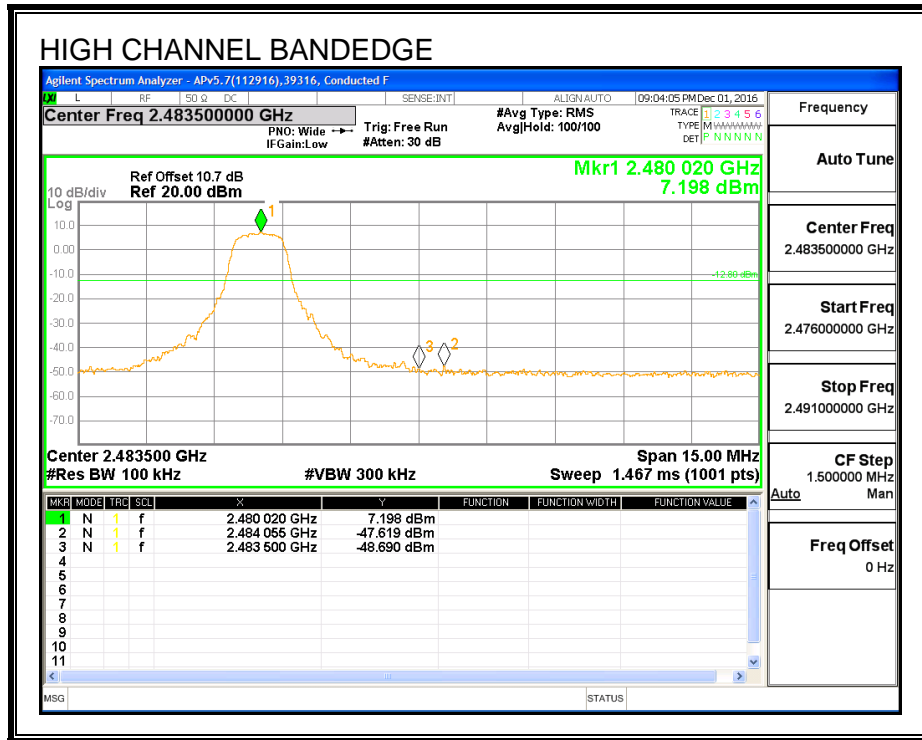

SPURIOUS BANDEGE EMISSIONS WITH HOPPING ON

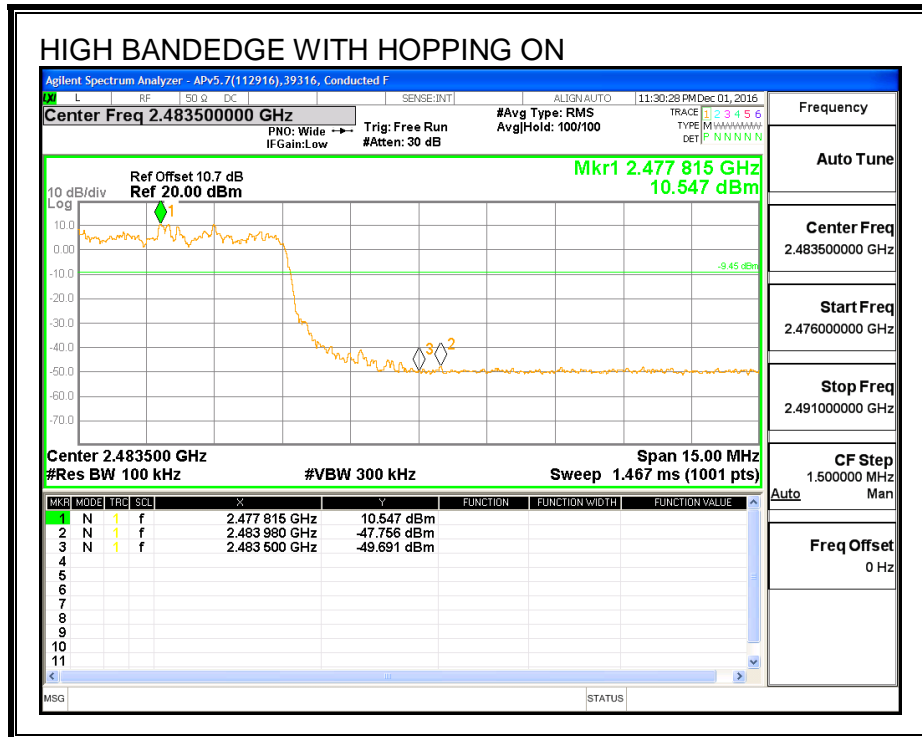
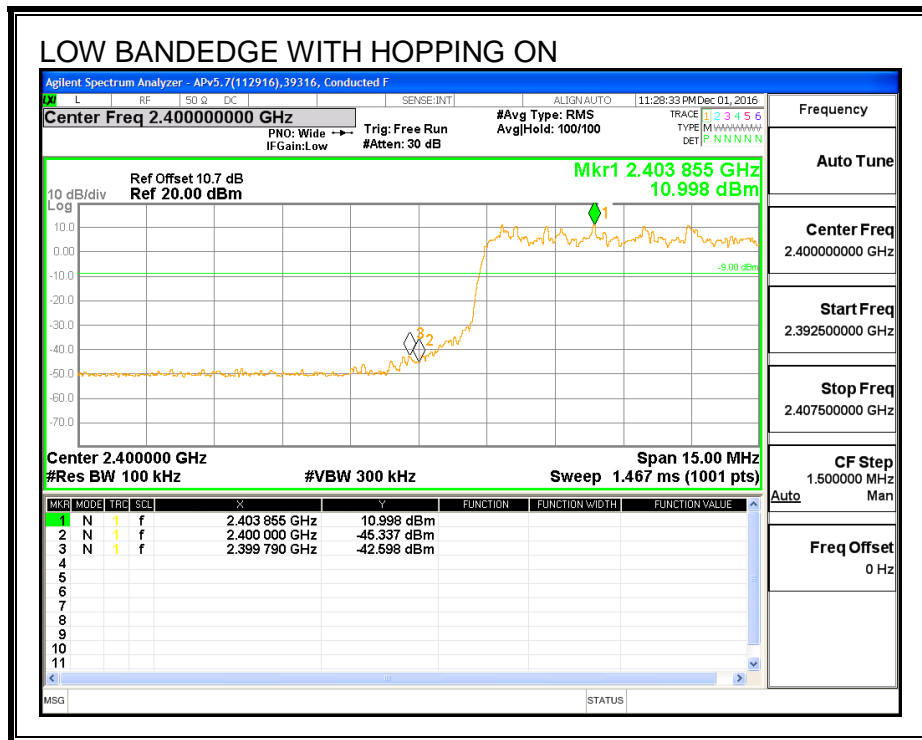

8. RADIATED TEST RESULTS

8.1. LIMITS AND PROCEDURE

LIMITS

FCC §15.205 and §15.209

IC RSS-GEN, Section 8.9 and 8.10.

Frequency Range (MHz)	Field Strength Limit (uV/m) at 3 m	Field Strength Limit (dBuV/m) at 3 m
30 - 88	100	40
88 - 216	150	43.5
216 - 960	200	46
Above 960	500	54

TEST PROCEDURE

The EUT is placed on a non-conducting table 80 cm above the ground plane for measurement below 1GHz; 1.5 m above the ground plane for measurement above 1GHz. The antenna to EUT distance is 3 meters. The EUT is configured in accordance with ANSI C63.10. The EUT is set to transmit in a continuous mode.

For measurements below 1 GHz the resolution bandwidth is set to 100 kHz for peak detection measurements or 120 kHz for quasi-peak detection measurements. Peak detection is used unless otherwise noted as quasi-peak.

For pre-scans above 1 GHz the resolution bandwidth is set to 1 MHz; the video bandwidth is set to 30 KHz for peak measurements

For measurements above 1 GHz the resolution bandwidth is set to 1 MHz, then the video bandwidth is set to 3 MHz for peak measurements and 1 MHz resolution bandwidth with 1/T (10 Hz) video bandwidth with peak detector for average measurements.

The spectrum from 30 MHz to 26 GHz is investigated with the transmitter set to the lowest, middle, and highest channels in the 2.4 GHz band.

The frequency range of interest is monitored at a fixed antenna height and EUT azimuth. The EUT is rotated through 360 degrees to maximize emissions received. The antenna is scanned from 1 to 4 meters above the ground plane to further maximize the emission. Measurements are made with the antenna polarized in both the vertical and the horizontal positions.

RESULTS

8.2. TRANSMITTER ABOVE 1 GHz

8.2.1. BASIC DATA RATE GFSK MODULATION

RESTRICTED BANDEDGE (LOW CHANNEL, HORIZONTAL)

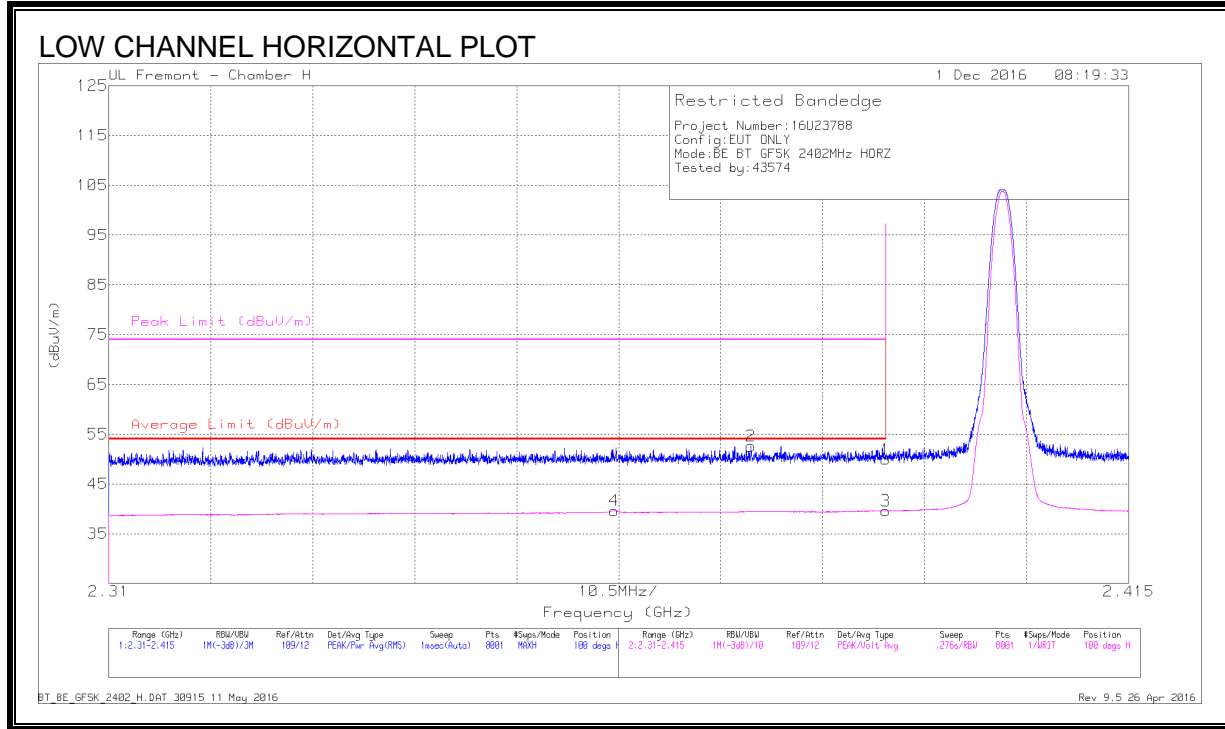

DATA

Marker	Frequency (GHz)	Meter Reading (dBuV)	Det	AF T120 (dB/m)	Amp/Cb/Ftr/Pad (dB)	Corrected Reading (dBuV/m)	Average Limit (dBuV/m)	Margin (dB)	Peak Limit (dBuV/m)	PK Margin (dB)	Azimuth (Degs)	Height (cm)	Polarity
1	* 2.39	37.64	Pk	31.9	-19.6	49.94	-	-	74	-24.06	100	340	H
2	* 2.376	40.3	Pk	31.9	-19.6	52.6	-	-	74	-21.4	100	340	H
3	* 2.39	27.29	VA1T	31.9	-19.6	39.59	54	-14.41	-	-	100	340	H
4	* 2.362	27.53	VA1T	31.8	-19.7	39.63	54	-14.37	-	-	100	340	H

* - indicates frequency in CFR47 Pt 15 / IC RSS-Restricted Band

Pk - Peak detector

VA1T - FHSS: Linear Voltage Average $V_B=1/T_{on}$ where: T_{on} is transmit duration

RESTRICTED BANDEDGE (LOW CHANNEL, VERTICAL)

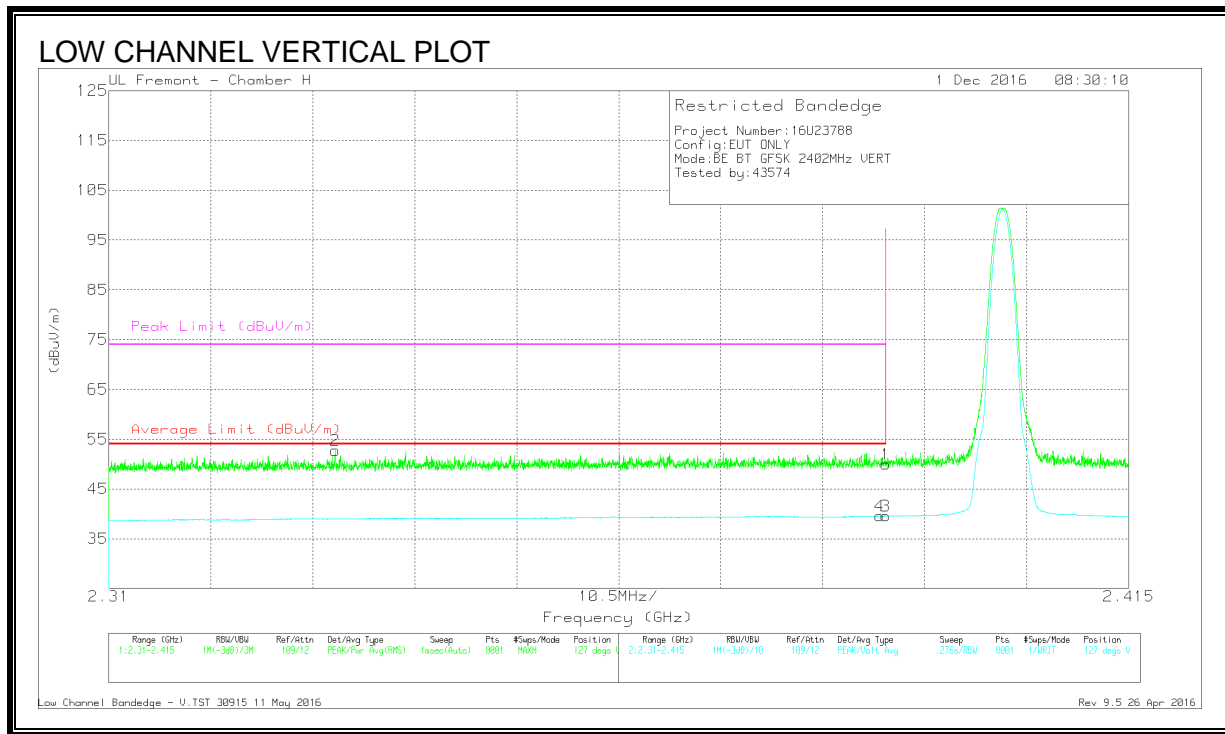

DATA

Marker	Frequency (GHz)	Meter Reading (dBuV)	Det	AF T120 (dB/m)	Amp/Cb/Ftr/Pad (dB)	Corrected Reading (dBuV/m)	Average Limit (dBuV/m)	Margin (dB)	Peak Limit (dBuV/m)	PK Margin (dB)	Azimuth (Degs)	Height (cm)	Polarity
2	* 2.333	40.82	Pk	31.7	-19.8	52.72	-	-	74	-21.28	127	331	V
4	* 2.389	27.27	VA1T	31.9	-19.6	39.57	54	-14.43	-	-	127	331	V
1	* 2.39	37.67	Pk	31.9	-19.6	49.97	-	-	74	-24.03	127	331	V
3	* 2.39	27.25	VA1T	31.9	-19.6	39.55	54	-14.45	-	-	127	331	V

* - indicates frequency in CFR47 Pt 15 / IC RSS-Restricted Band

Pk - Peak detector

VA1T - FHSS: Linear Voltage Average VB=1/Ton where: Ton is transmit duration

RESTRICTED BANDEDGE (HIGH CHANNEL, HORIZONTAL)

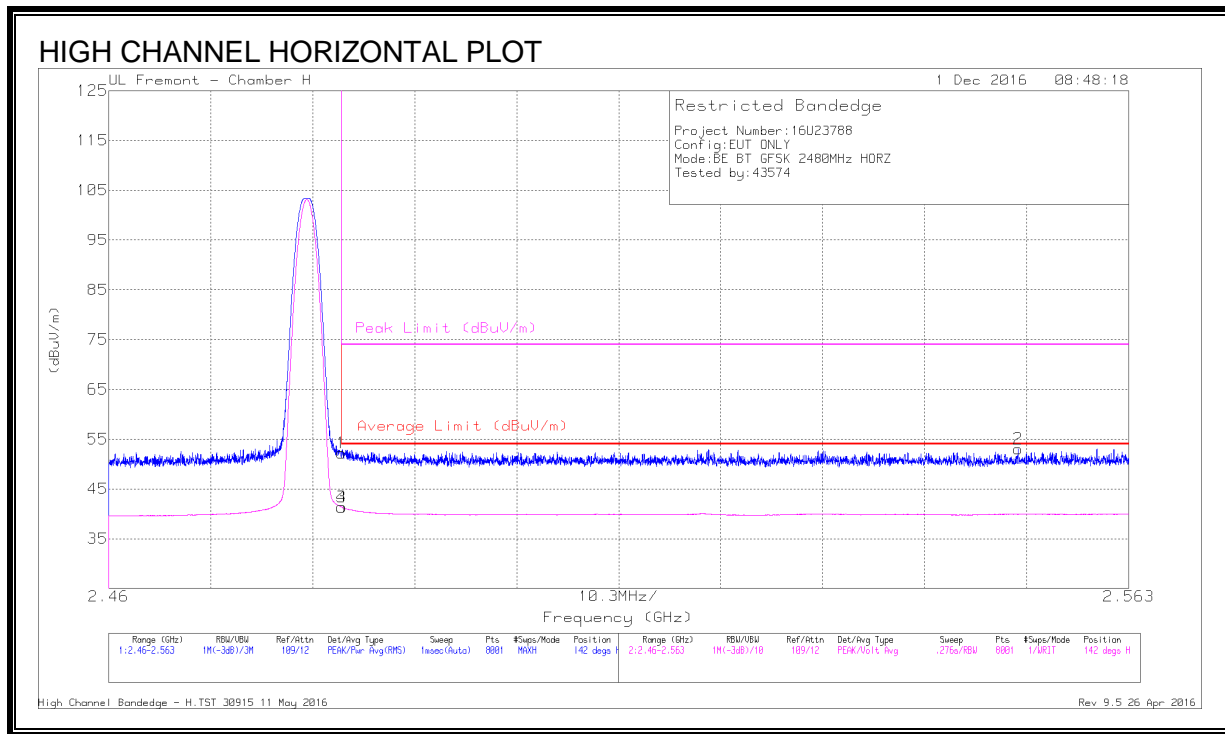

DATA

Marker	Frequency (GHz)	Meter Reading (dBuV)	Det	AF T120 (dB/m)	Amp/Cb/Ftr/Pad (dB)	Corrected Reading (dBuV/m)	Average Limit (dBuV/m)	Margin (dB)	Peak Limit (dBuV/m)	PK Margin (dB)	Azimuth (Degs)	Height (cm)	Polarity
1	* 2.484	39.53	Pk	32.2	-19.5	52.23	-	-	74	-21.77	142	399	H
3	* 2.484	28.67	VA1T	32.2	-19.5	41.37	54	-12.63	-	-	142	399	H
4	* 2.484	28.66	VA1T	32.2	-19.5	41.36	54	-12.64	-	-	142	399	H
2	2.552	40.15	Pk	32.2	-19.3	53.05	-	-	74	-20.95	142	399	H

* - indicates frequency in CFR47 Pt 15 / IC RSS-Restricted Band

Pk - Peak detector

VA1T - FHSS: Linear Voltage Average VB=1/Ton where: Ton is transmit duration

RESTRICTED BANDEDGE (HIGH CHANNEL, VERTICAL)

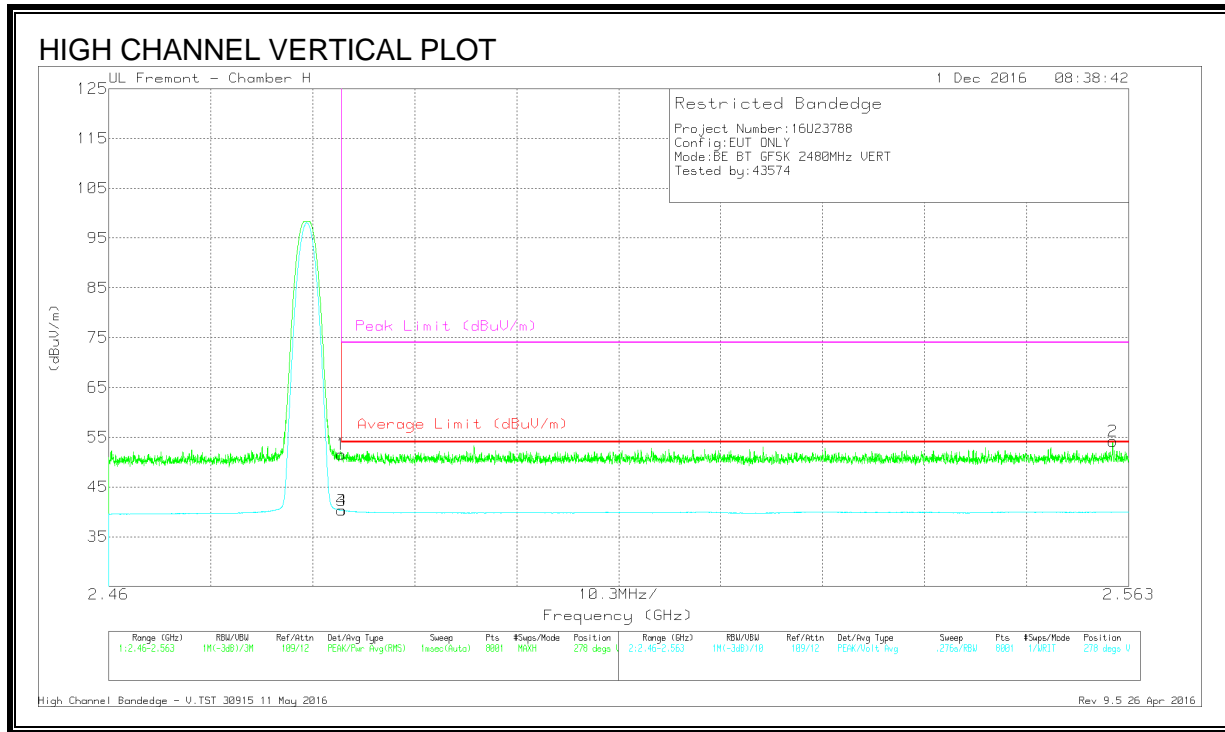

DATA

Marker	Frequency (GHz)	Meter Reading (dBuV)	Det	AF T120 (dB/m)	Amp/Cb/Fltr/Pad (dB)	Corrected Reading (dBuV/m)	Average Limit (dBuV/m)	Margin (dB)	Peak Limit (dBuV/m)	PK Margin (dB)	Azimuth (Degs)	Height (cm)	Polarity
1	* 2.484	38.89	Pk	32.2	-19.5	51.59	-	-	74	-22.41	278	341	V
3	* 2.484	27.59	VA1T	32.2	-19.5	40.29	54	-13.71	-	-	278	341	V
4	* 2.484	27.61	VA1T	32.2	-19.5	40.31	54	-13.69	-	-	278	341	V
2	2.561	41.4	Pk	32.2	-19.4	54.2	-	-	74	-19.8	278	341	V

* - indicates frequency in CFR47 Pt 15 / IC RSS-Restricted Band

Pk - Peak detector

VA1T - FHSS: Linear Voltage Average VB=1/Ton where: Ton is transmit duration

HARMONICS AND SPURIOUS EMISSIONS

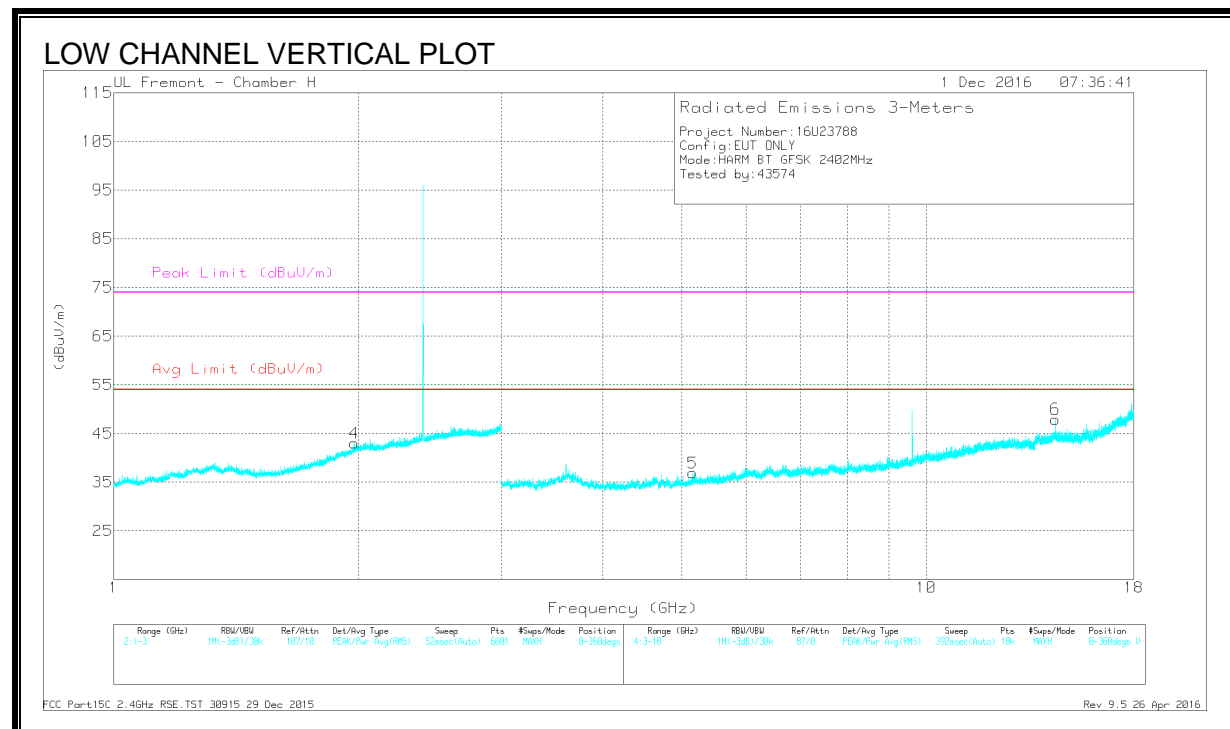
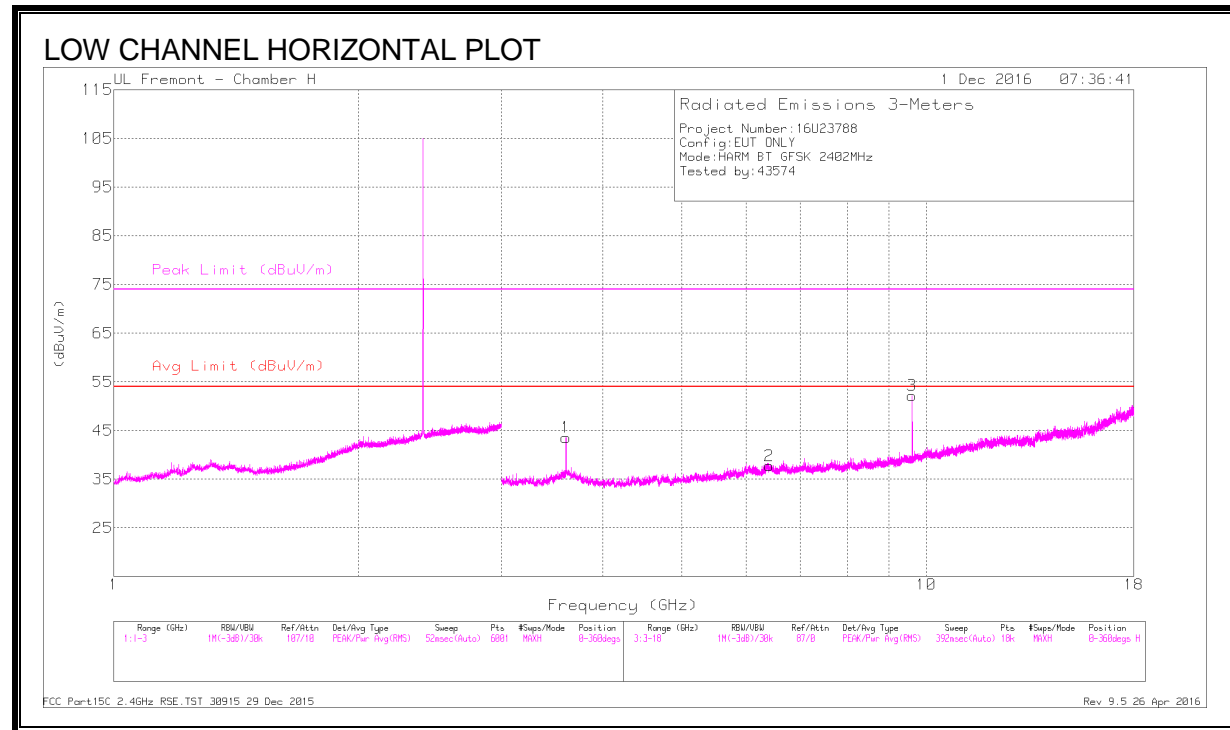

DATA

Markers	Frequency (GHz)	Meter Reading (dBuV)	Det	AF T120 (dB/m)	Amp/Cb/Fitr/Pad (dB)	Corrected Reading (dBuV/m)	Avg Limit (dBuV/m)	Margin (dB)	Peak Limit (dBuV/m)	PK Margin (dB)	Azimuth (Degs)	Height (cm)	Polarity
1	* 3.603	43.98	PKFH	34.9	-35.6	43.28	-	-	74	-30.72	265	175	H
	* 3.603	32.58	VA1T	34.9	-35.6	31.88	54	-22.12	-	-	265	175	H
2	1.977	37.06	PKFH	31.7	-20.7	48.06	-	-	-	-	168	154	V
	1.979	25.52	VA1T	31.7	-20.7	36.52	-	-	-	-	168	154	V
	5.162	30.64	VA1T	34.3	-34.2	30.74	-	-	-	-	103	277	V
3	5.163	42.31	PKFH	34.3	-34.3	42.31	-	-	-	-	103	277	V
	6.404	39.99	PKFH	35.7	-31.5	44.19	-	-	-	-	176	172	H
4	6.404	28.63	VA1T	35.7	-31.5	32.83	-	-	-	-	176	172	H
	9.608	47.77	PKFH	37	-29.1	55.67	-	-	-	-	175	100	H
5	9.608	42.28	VA1T	37	-29.1	50.18	-	-	-	-	175	100	H
	14.413	36.24	PKFH	39.8	-24.5	51.54	-	-	-	-	280	232	V
6	14.413	25.8	VA1T	39.8	-24.5	41.1	-	-	-	-	280	232	V

* - indicates frequency in CFR47 Pt 15 / IC RSS-Restricted Band

PKFH - FHSS: RB=100k/1MHz VB=3 x RB, Peak

VA1T - FHSS: Linear Voltage Average VB=1/Ton where: Ton is transmit duration

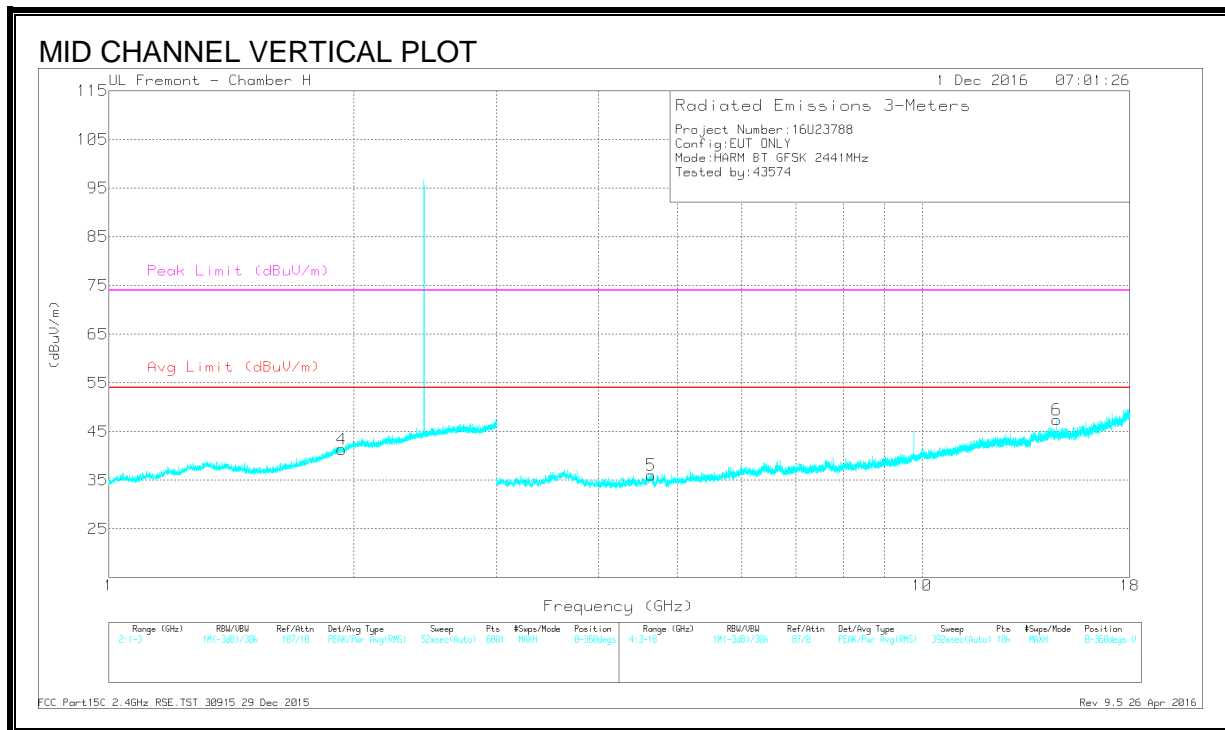
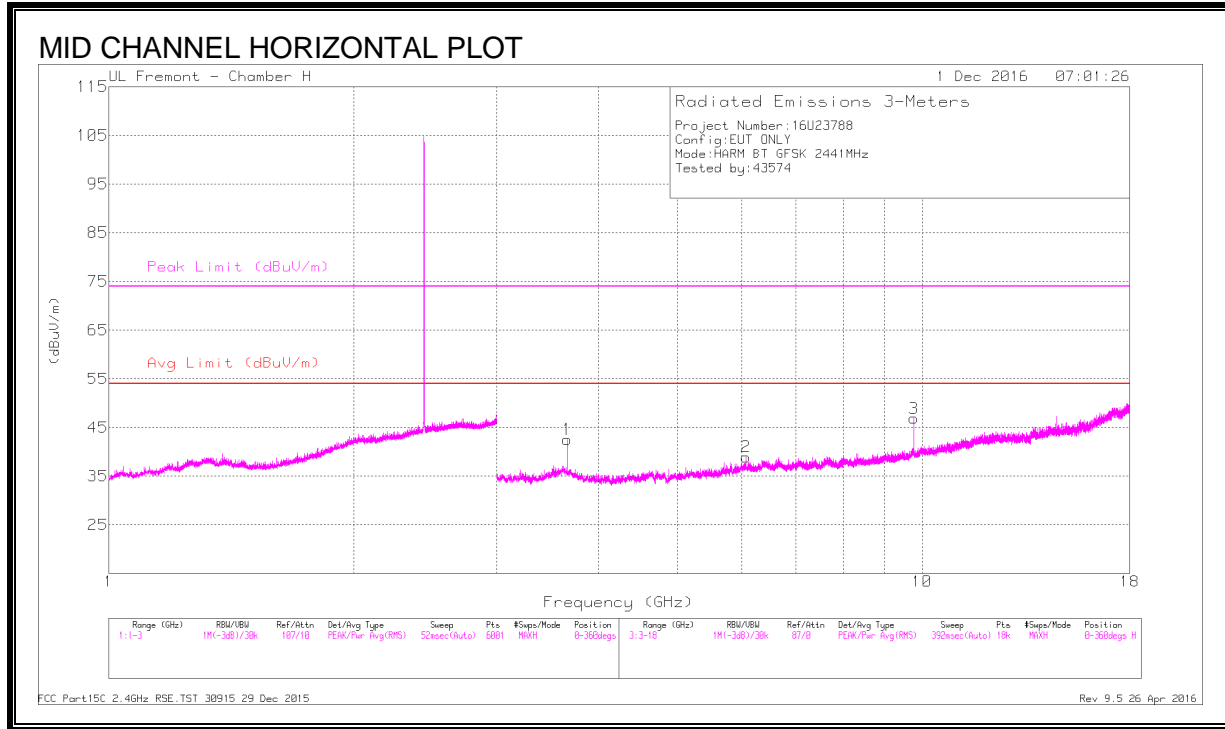

DATA

Markers	Frequency (GHz)	Meter Reading (dBuV)	Det	AF T120 (dB/m)	Amp/Cbl/Ftr/P ad (dB)	Corrected Reading (dBuV/m)	Avg Limit (dBuV/m)	Margin (dB)	Peak Limit (dBuV/m)	PK Margin (dB)	Azimuth (Degs)	Height (cm)	Polarity
1	* 3.661	47.43	PKFH	34.9	-35.8	46.53	-	-	74	-27.47	262	112	H
	* 3.662	41.49	VA1T	34.9	-35.8	40.59	54	-13.41	-	-	262	112	H
2	* 4.642	42.06	PKFH	34	-34.5	41.56	-	-	74	-32.44	360	182	V
	* 4.642	30.52	VA1T	34	-34.5	30.02	54	-23.98	-	-	360	182	V
3	1.931	37.04	PKFH	31.3	-20.9	47.44	-	-	-	-	271	301	V
	1.931	25.17	VA1T	31.3	-20.9	35.57	-	-	-	-	271	301	V
	6.07	28.59	VA1T	35.4	-31.9	32.09	-	-	-	-	64	137	H
4	6.071	40.06	PKFH	35.4	-31.9	43.56	-	-	-	-	70	137	H
	9.764	43.53	PKFH	37.3	-29.2	51.63	-	-	-	-	195	101	H
5	9.764	36.19	VA1T	37.3	-29.2	44.29	-	-	-	-	195	101	H
	14.646	35.38	PKFH	40	-24.7	50.68	-	-	-	-	236	204	V
6	14.647	24.29	VA1T	40	-24.7	39.59	-	-	-	-	236	204	V

* - indicates frequency in CFR47 Pt 15 / IC RSS-Restricted Band

PKFH - FHSS: RB=100k/1MHz VB=3 x RB, Peak

VA1T - FHSS: Linear Voltage Average VB=1/Ton where: Ton is transmit duration

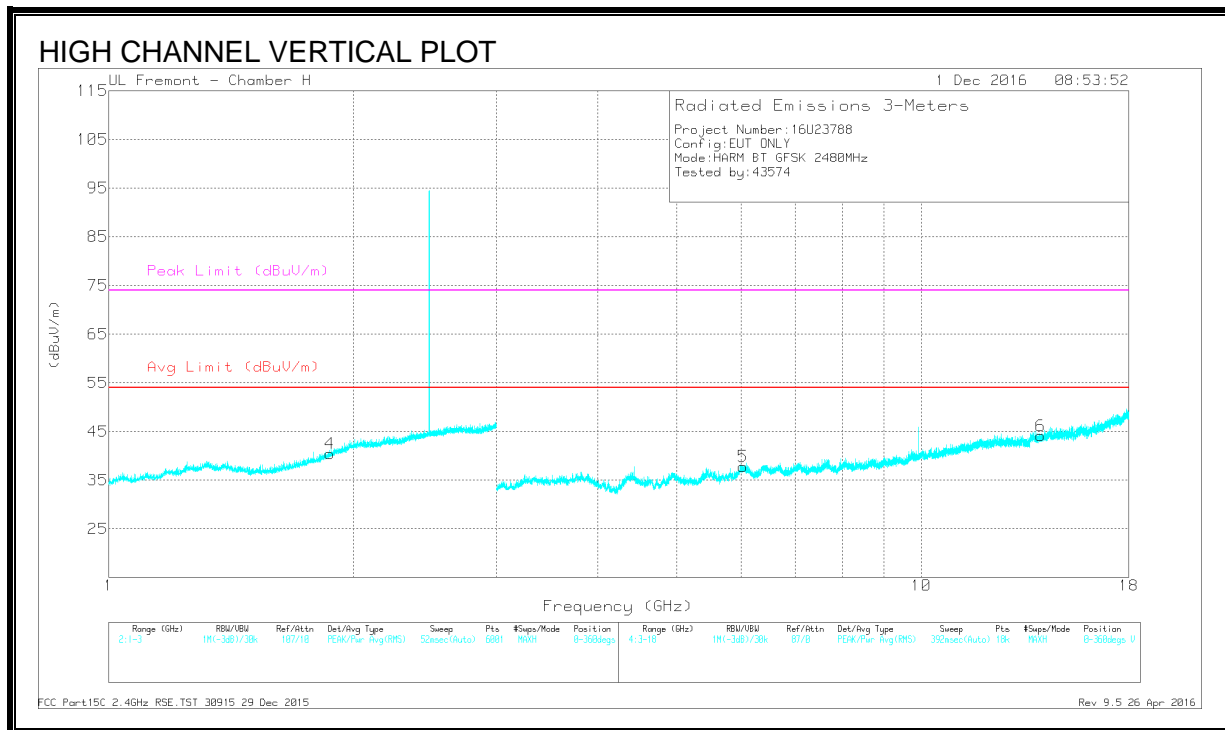
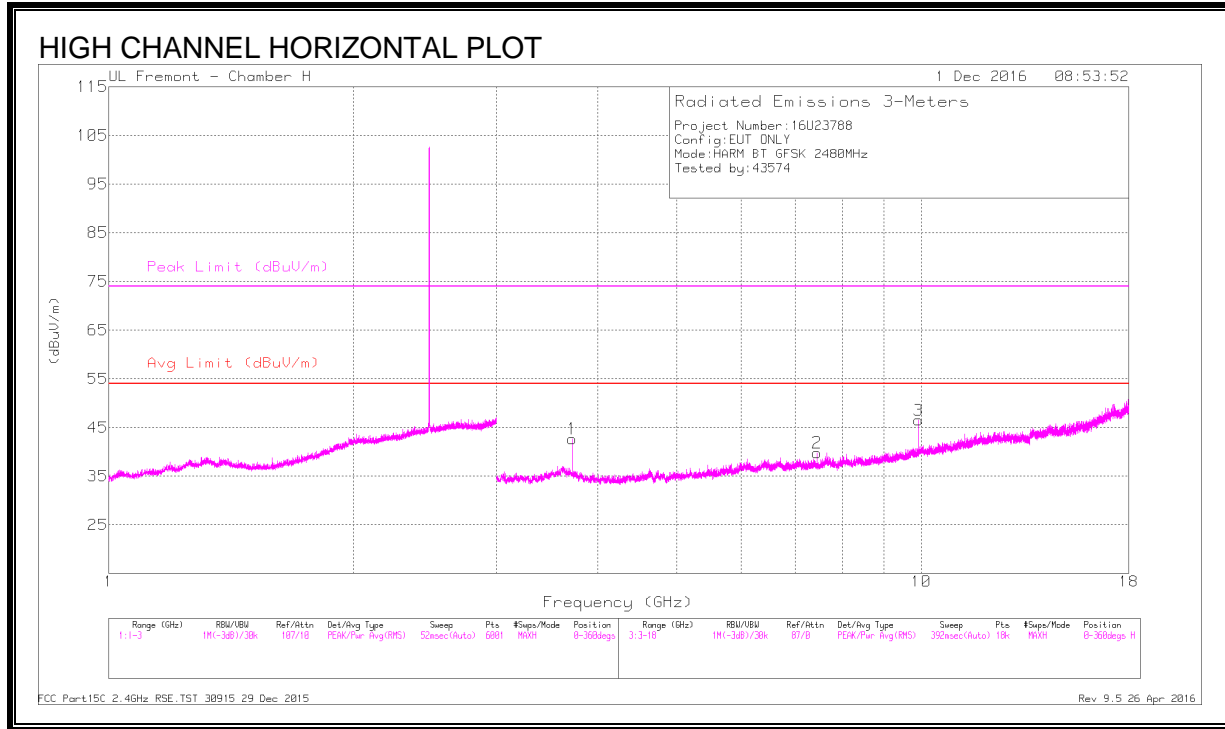

DATA

Markers	Frequency (GHz)	Meter Reading (dBuV)	Det	AF T120 (dB/m)	Amp/Cb/Fitr/Pad (dB)	Corrected Reading (dBuV/m)	Avg Limit (dBuV/m)	Margin (dB)	Peak Limit (dBuV/m)	PK Margin (dB)	Azimuth (Degs)	Height (cm)	Polarity
1	* 3.72	48.85	PKFH	34.7	-35.9	47.65	-	-	74	-26.35	202	108	H
	* 3.72	43.91	VA1T	34.7	-35.9	42.71	54	-11.29	-	-	202	108	H
2	* 7.439	41.13	PKFH	35.7	-31.3	45.53	-	-	74	-28.47	185	272	H
	* 7.44	31.19	VA1T	35.7	-31.3	35.59	54	-18.41	-	-	185	272	H
3	1.87	25.02	VA1T	30.7	-21.1	34.62	-	-	-	-	284	261	V
	1.872	36.1	PKFH	30.7	-21.1	45.7	-	-	-	-	278	261	V
	6.037	29.19	VA1T	35.4	-32.6	31.99	-	-	-	-	42	100	V
	6.038	41.72	PKFH	35.4	-32.5	44.62	-	-	-	-	47	100	V
5	9.92	42.15	PKFH	37.5	-29	50.65	-	-	-	-	81	106	H
	9.92	34.13	VA1T	37.5	-29	42.63	-	-	-	-	81	106	H
6	14.025	36.2	PKFH	39.3	-24.9	50.6	-	-	-	-	360	272	V
	14.026	24.44	VA1T	39.3	-24.8	38.94	-	-	-	-	360	272	V

* - indicates frequency in CFR47 Pt 15 / IC RSS-Restricted Band

PKFH - FHSS: RB=100k/1MHz VB=3 x RB, Peak

VA1T - FHSS: Linear Voltage Average VB=1/Ton where: Ton is transmit duration

8.2.2. ENHANCED DATA RATE QPSK MODULATION

RESTRICTED BANDEDGE (LOW CHANNEL, HORIZONTAL)

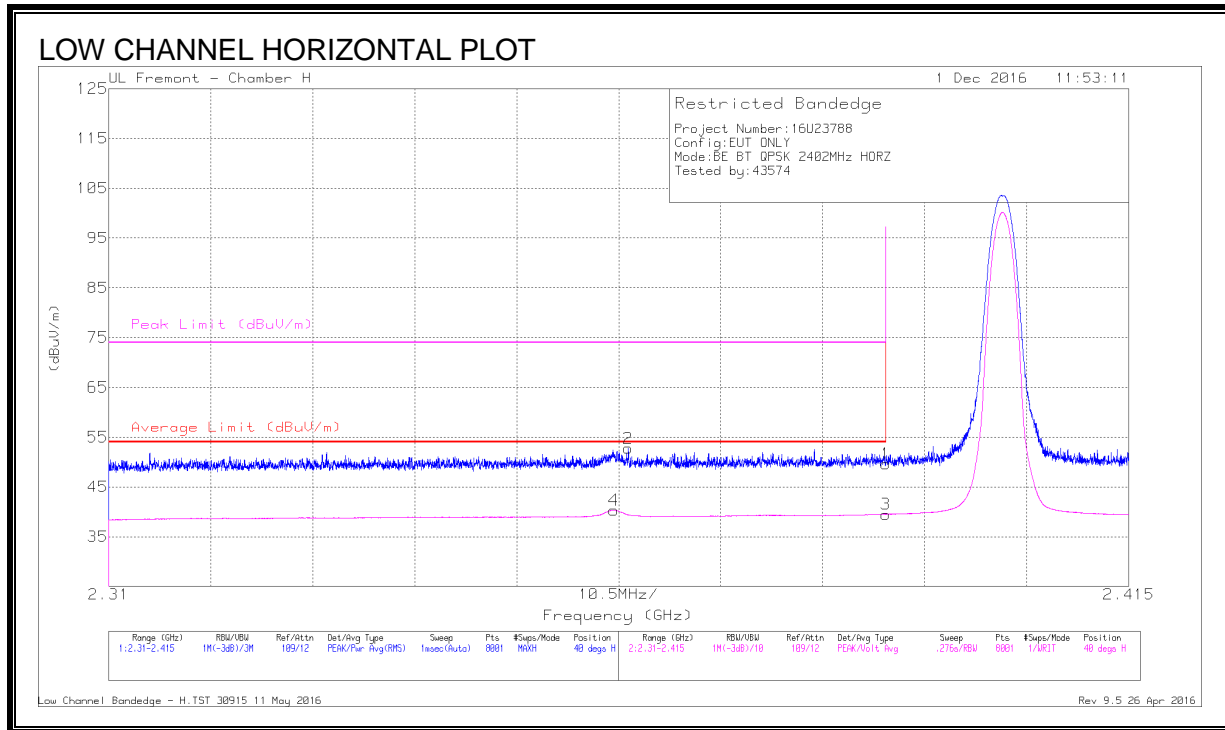

DATA

Marker	Frequency (GHz)	Meter Reading (dBuV)	Det	AF T120 (dB/m)	Amp/Cb/Ftr/Pad (dB)	Corrected Reading (dBuV/m)	Average Limit (dBuV/m)	Margin (dB)	Peak Limit (dBuV/m)	PK Margin (dB)	Azimuth (Degs)	Height (cm)	Polarity
1	* 2.39	37.35	Pk	31.9	-19.6	49.65	-	-	74	-24.35	40	100	H
2	* 2.363	40.66	Pk	31.8	-19.7	52.76	-	-	74	-21.24	40	100	H
3	* 2.39	27.21	VA1T	31.9	-19.6	39.51	54	-14.49	-	-	40	100	H
4	* 2.362	28.24	VA1T	31.8	-19.7	40.34	54	-13.66	-	-	40	100	H

* - indicates frequency in CFR47 Pt 15 / IC RSS-Restricted Band

Pk - Peak detector

VA1T - FHSS: Linear Voltage Average VB=1/Ton where: Ton is transmit duration

RESTRICTED BANDEDGE (LOW CHANNEL, VERTICAL)

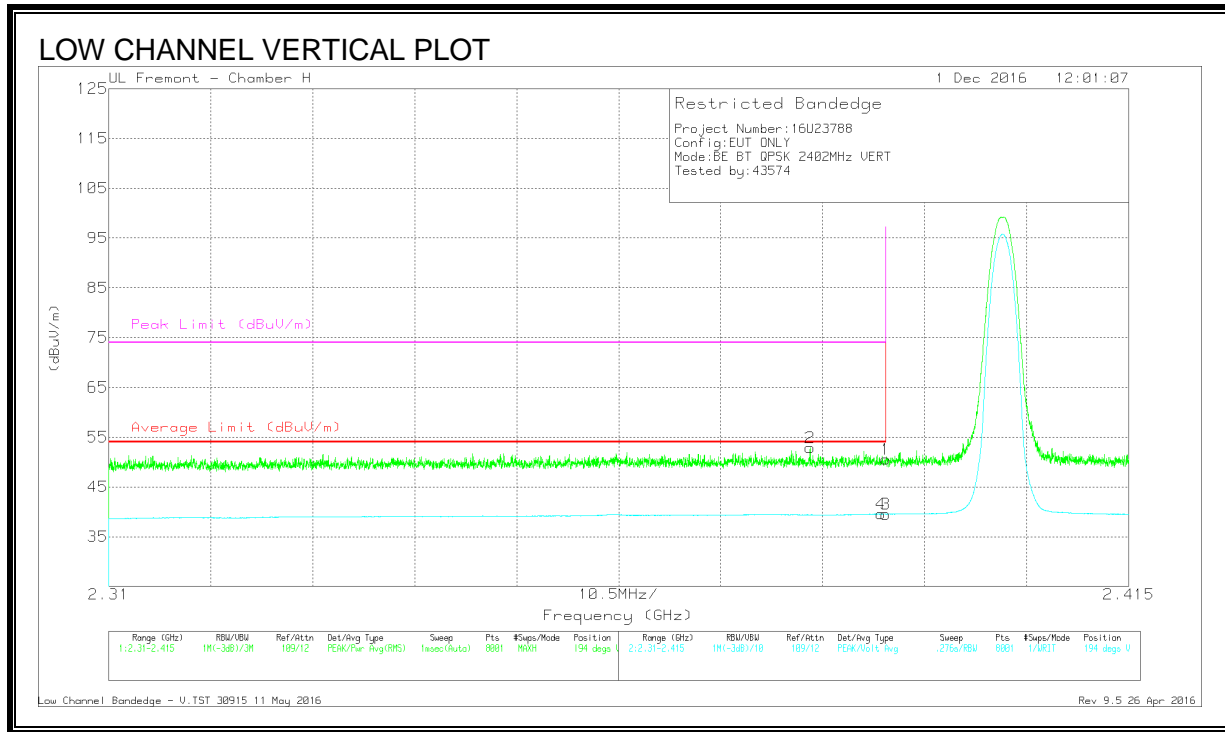

DATA

Marker	Frequency (GHz)	Meter Reading (dBuV)	Det	AF T120 (dB/m)	Amp/Cb/Ftr/Pad (dB)	Corrected Reading (dBuV/m)	Average Limit (dBuV/m)	Margin (dB)	Peak Limit (dBuV/m)	PK Margin (dB)	Azimuth (Degs)	Height (cm)	Polarity
2	* 2.382	40.7	Pk	31.9	-19.7	52.9	-	-	74	-21.1	194	373	V
4	* 2.389	27.27	VA1T	31.9	-19.6	39.57	54	-14.43	-	-	194	373	V
1	* 2.39	38.25	Pk	31.9	-19.6	50.55	-	-	74	-23.45	194	373	V
3	* 2.39	27.23	VA1T	31.9	-19.6	39.53	54	-14.47	-	-	194	373	V

* - indicates frequency in CFR47 Pt 15 / IC RSS-Restricted Band

Pk - Peak detector

VA1T - FHSS: Linear Voltage Average VB=1/Ton where: Ton is transmit duration

RESTRICTED BANDEDGE (HIGH CHANNEL, HORIZONTAL)

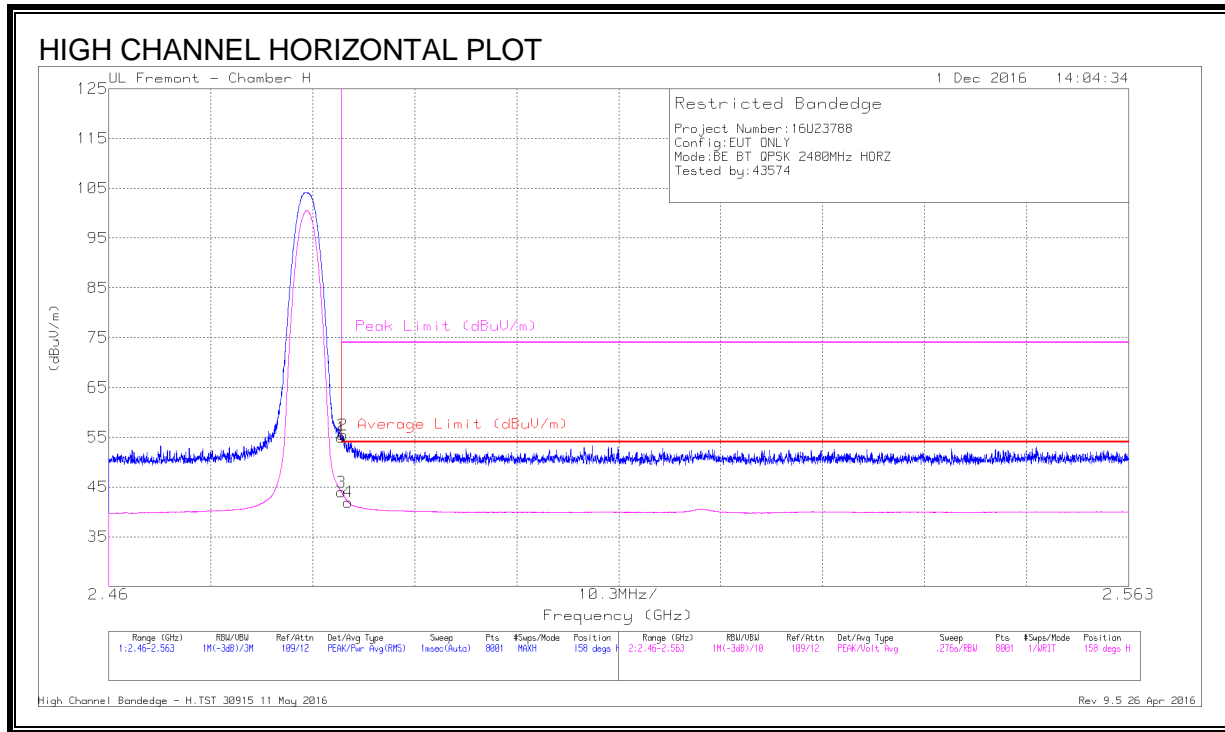

DATA

Marker	Frequency (GHz)	Meter Reading (dBuV)	Det	AF T120 (dB/m)	Amp/Cb/Ftr/Pad (dB)	Corrected Reading (dBuV/m)	Average Limit (dBuV/m)	Margin (dB)	Peak Limit (dBuV/m)	PK Margin (dB)	Azimuth (Degs)	Height (cm)	Polarity
1	* 2.484	42.27	Pk	32.2	-19.5	54.97	-	-	74	-19.03	158	316	H
2	* 2.484	42.87	Pk	32.2	-19.6	55.47	-	-	74	-18.53	158	316	H
3	* 2.484	31.25	VA1T	32.2	-19.5	43.95	54	-10.05	-	-	158	316	H
4	* 2.484	29.36	VA1T	32.2	-19.6	41.96	54	-12.04	-	-	158	316	H

* - indicates frequency in CFR47 Pt 15 / IC RSS-Restricted Band

Pk - Peak detector

VA1T - FHSS: Linear Voltage Average VB=1/Ton where: Ton is transmit duration

RESTRICTED BANDEDGE (HIGH CHANNEL, VERTICAL)

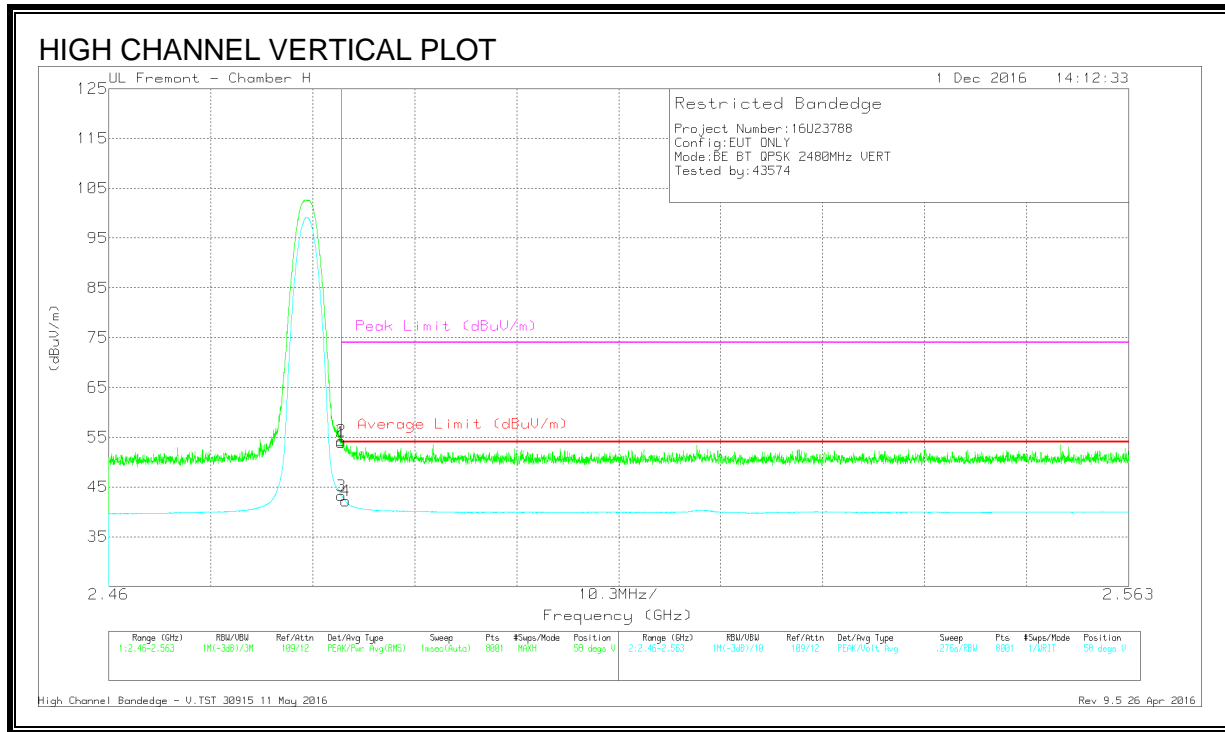

DATA

Marker	Frequency (GHz)	Meter Reading (dBuV)	Det	AF T120 (dB/m)	Amp/Cb/Ftr/Pad (dB)	Corrected Reading (dBuV/m)	Average Limit (dBuV/m)	Margin (dB)	Peak Limit (dBuV/m)	PK Margin (dB)	Azimuth (Degs)	Height (cm)	Polarity
1	* 2.484	41.25	Pk	32.2	-19.5	53.95	-	-	74	-20.05	58	395	V
2	* 2.484	41.58	Pk	32.2	-19.5	54.28	-	-	74	-19.72	58	395	V
3	* 2.484	30.53	VA1T	32.2	-19.5	43.23	54	-10.77	-	-	58	395	V
4	* 2.484	29.62	VA1T	32.2	-19.6	42.22	54	-11.78	-	-	58	395	V

* - indicates frequency in CFR47 Pt 15 / IC RSS-Restricted Band

Pk - Peak detector

VA1T - FHSS: Linear Voltage Average VB=1/Ton where: Ton is transmit duration

HARMONICS AND SPURIOUS EMISSIONS

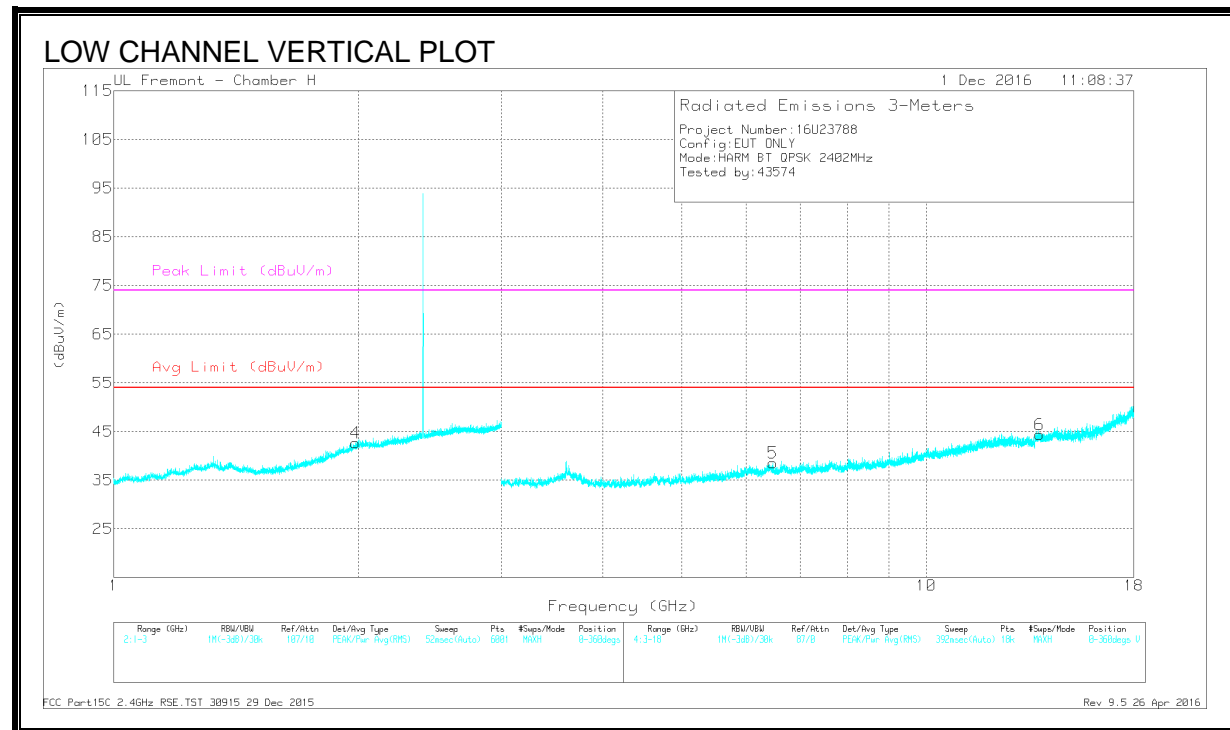
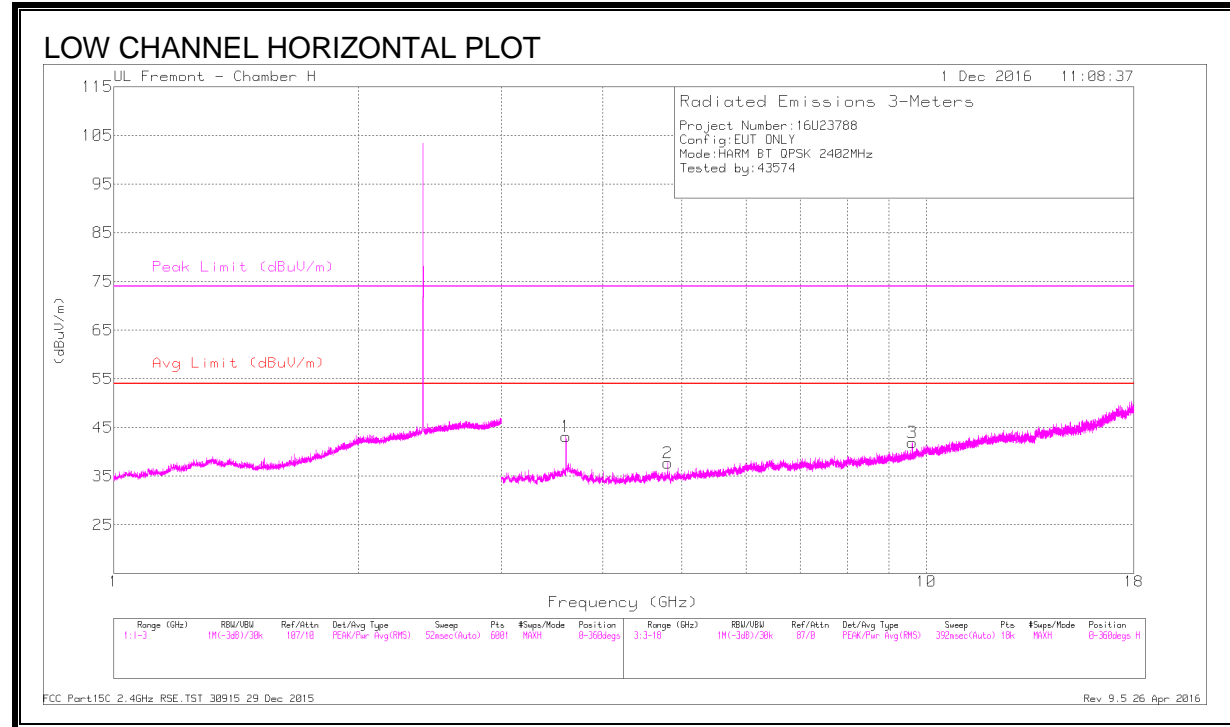

DATA

Markers	Frequency (GHz)	Meter Reading (dBuV)	Det	AF T120 (dB/m)	Amp/Cb/Fitr/Pad (dB)	Corrected Reading (dBuV/m)	Avg Limit (dBuV/m)	Margin (dB)	Peak Limit (dBuV/m)	PK Margin (dB)	Azimuth (Degs)	Height (cm)	Polarity
1	* 3.603	47.84	PKFH	34.9	-35.6	47.14	-	-	74	-26.86	142	127	H
	* 3.603	40.86	VA1T	34.9	-35.6	40.16	54	-13.84	-	-	142	127	H
2	* 4.803	42.48	PKFH	34	-35.1	41.38	-	-	74	-32.62	9	106	H
	* 4.806	31.09	VA1T	34	-35.1	29.99	54	-24.01	-	-	9	106	H
3	1.982	37.33	PKFH	31.8	-20.8	48.33	-	-	-	-	155	258	V
	1.983	25.51	VA1T	31.8	-20.8	36.51	-	-	-	-	155	258	V
4	6.478	40.38	PKFH	35.7	-31.8	44.28	-	-	-	-	360	207	V
	6.478	28.79	VA1T	35.7	-31.8	32.69	-	-	-	-	360	207	V
5	9.61	38.05	PKFH	37	-29.1	45.95	-	-	-	-	45	297	H
	9.61	26.44	VA1T	37	-29.1	34.34	-	-	-	-	45	297	H
6	13.784	36.03	PKFH	39.1	-25.1	50.03	-	-	-	-	89	214	V
	13.785	25	VA1T	39.1	-25.1	39	-	-	-	-	89	214	V

* - indicates frequency in CFR47 Pt 15 / IC RSS-Restricted Band

PKFH - FHSS: RB=100k/1MHz VB=3 x RB, Peak

VA1T - FHSS: Linear Voltage Average VB=1/Ton where: Ton is transmit duration

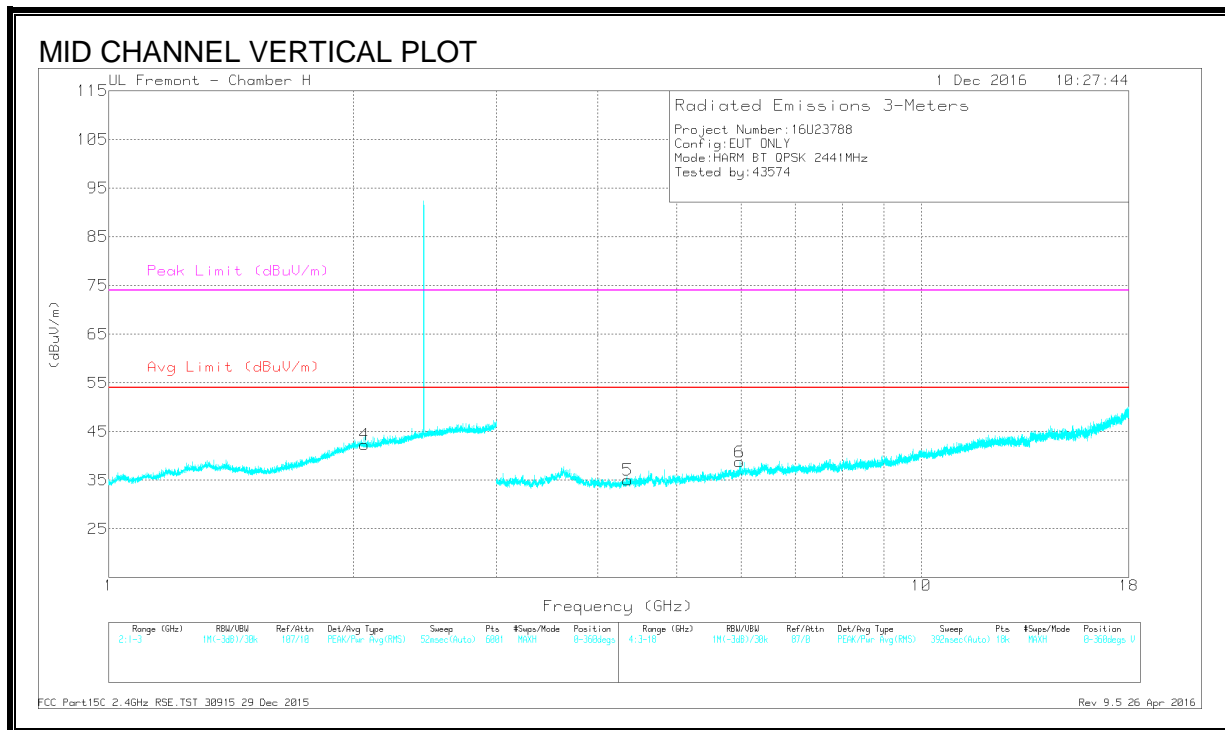
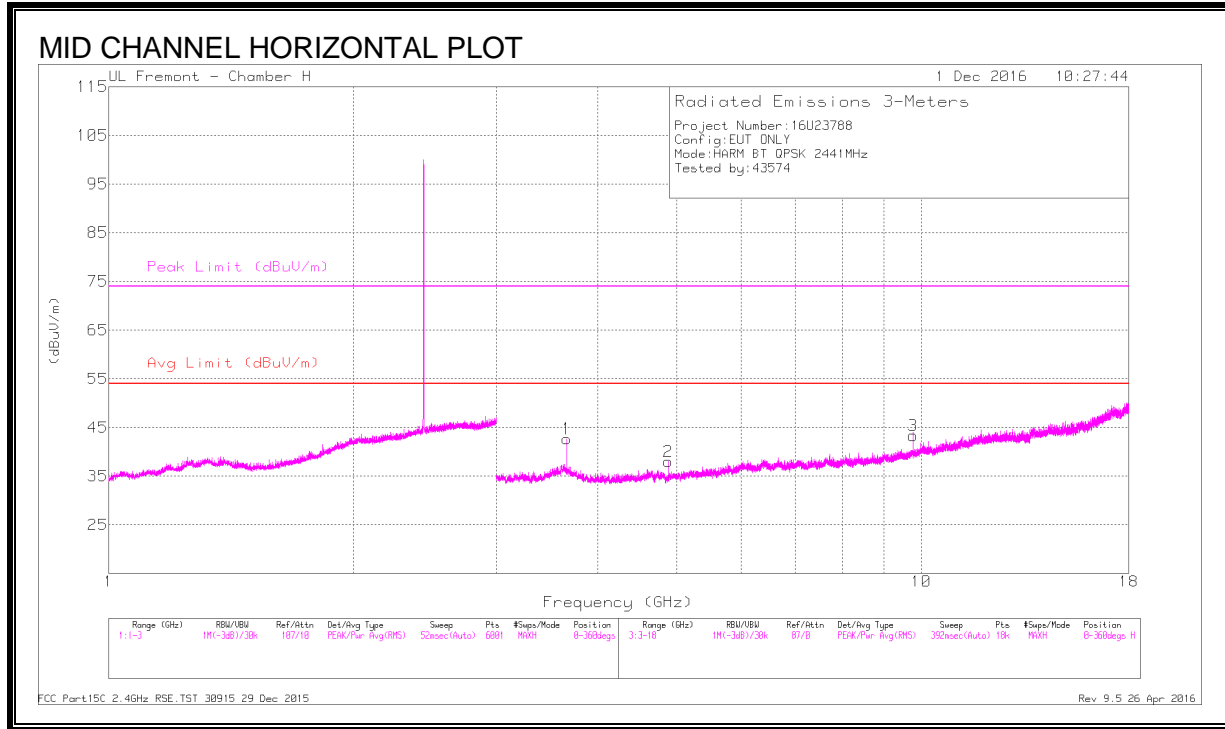

DATA

Markers	Frequency (GHz)	Meter Reading (dBuV)	Det	AF T120 (dB/m)	Amp/Cb/Fitr/Pad (dB)	Corrected Reading (dBuV/m)	Avg Limit (dBuV/m)	Margin (dB)	Peak Limit (dBuV/m)	PK Margin (dB)	Azimuth (Degs)	Height (cm)	Polarity
1	* 3.661	47.46	PKFH	34.9	-35.8	46.56	-	-	74	-27.44	18	140	H
	* 3.662	40.09	VA1T	34.9	-35.8	39.19	54	-14.81	-	-	18	140	H
2	* 4.881	45.03	PKFH	34	-34.9	44.13	-	-	74	-29.87	64	102	H
	* 4.882	36	VA1T	34	-34.9	35.1	54	-18.9	-	-	64	102	H
3	* 4.352	42.41	PKFH	33.6	-34.9	41.11	-	-	74	-32.89	360	166	V
	* 4.355	31.35	VA1T	33.6	-34.7	30.25	54	-23.75	-	-	360	166	V
4	2.064	36.57	PKFH	31.6	-20.6	47.57	-	-	-	-	216	168	V
	2.065	25.53	VA1T	31.6	-20.5	36.63	-	-	-	-	221	168	V
5	5.974	41.21	PKFH	35.3	-33.1	43.41	-	-	-	-	77	171	V
	5.978	29.79	VA1T	35.3	-33	32.09	-	-	-	-	71	171	V
	9.764	31.19	VA1T	37.3	-29.2	39.29	-	-	-	-	46	103	H
6	9.766	42.87	PKFH	37.3	-29.2	50.97	-	-	-	-	46	103	H

* - indicates frequency in CFR47 Pt 15 / IC RSS-Restricted Band

PKFH - FHSS: RB=100k/1MHz VB=3 x RB, Peak

VA1T - FHSS: Linear Voltage Average VB=1/Ton where: Ton is transmit duration

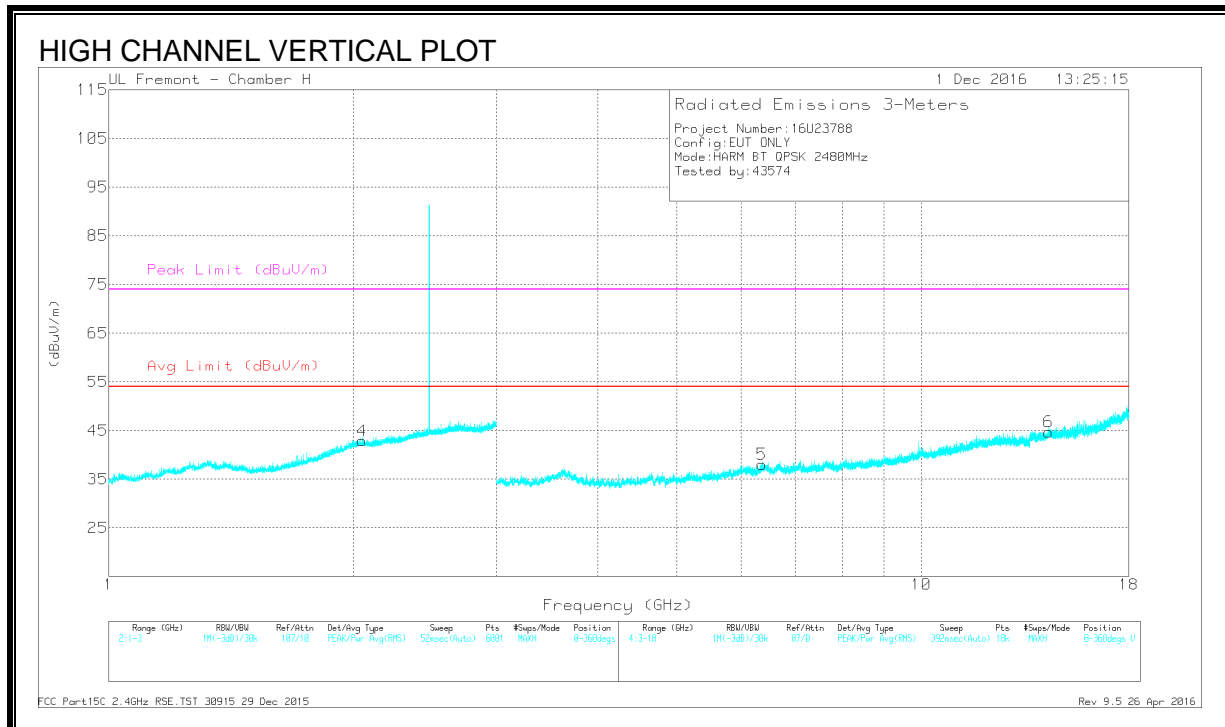
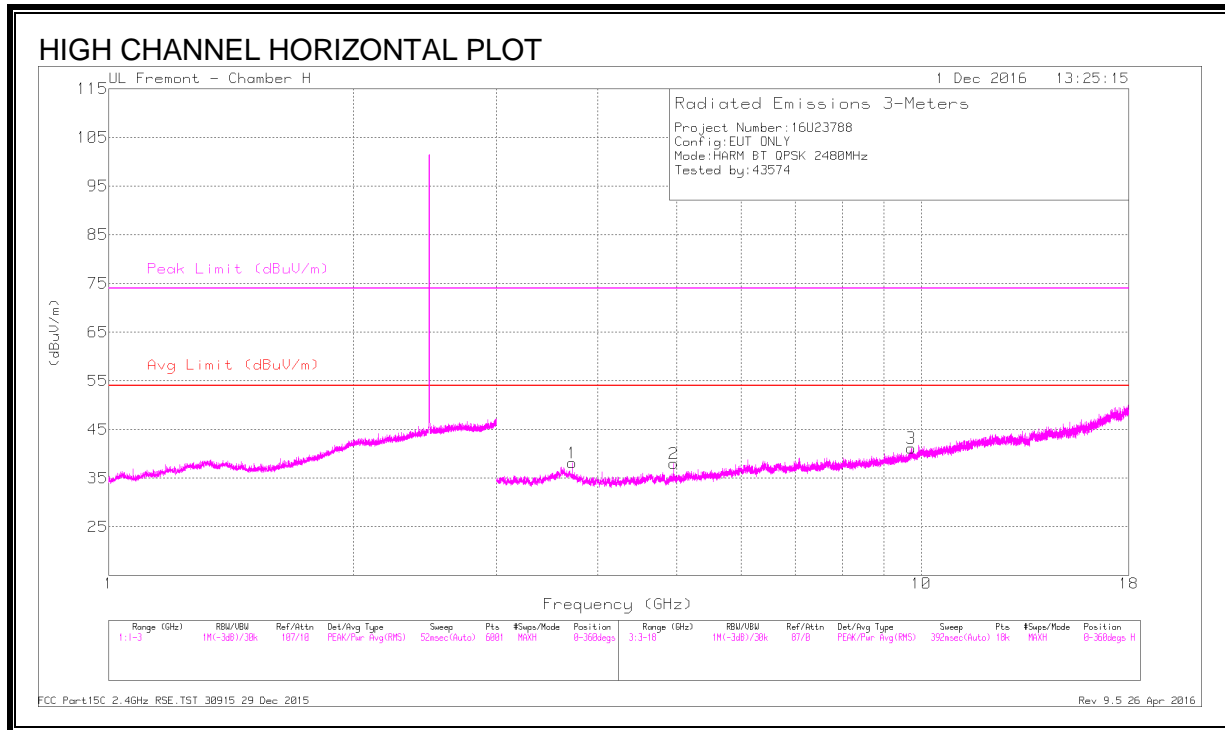

DATA

Markers	Frequency (GHz)	Meter Reading (dBuV)	Det	AF T120 (dB/m)	Amp/Cb/Fitr/Pad (dB)	Corrected Reading (dBuV/m)	Avg Limit (dBuV/m)	Margin (dB)	Peak Limit (dBuV/m)	PK Margin (dB)	Azimuth (Degs)	Height (cm)	Polarity
1	* 3.721	46.53	PKFH	34.7	-35.9	45.33	-	-	74	-28.67	5	118	H
	* 3.72	36.02	VA1T	34.7	-35.9	34.82	54	-19.18	-	-	5	118	H
3	* 4.961	44.67	PKFH	34	-34.2	44.47	-	-	74	-29.53	76	104	H
	* 4.96	35.06	VA1T	34	-34.3	34.76	54	-19.24	-	-	76	104	H
	2.049	25.63	VA1T	31.7	-20.6	36.73	-	-	-	-	200	138	V
3	2.051	36.86	PKFH	31.7	-20.6	47.96	-	-	-	-	200	138	V
	6.366	28.81	VA1T	35.6	-31.7	32.71	-	-	-	-	293	263	V
4	6.368	40.11	PKFH	35.6	-31.6	44.11	-	-	-	-	293	263	V
5	9.712	38.41	PKFH	37.1	-28.6	46.91	-	-	-	-	213	222	H
	9.716	26.58	VA1T	37.1	-28.7	34.98	-	-	-	-	213	222	H
6	14.341	35.11	PKFH	39.7	-24.4	50.41	-	-	-	-	94	243	V
	14.341	24.11	VA1T	39.7	-24.4	39.41	-	-	-	-	94	243	V

* - indicates frequency in CFR47 Pt 15 / IC RSS-Restricted Band

PKFH - FHSS: RB=100k/1MHz VB=3 x RB, Peak

VA1T - FHSS: Linear Voltage Average VB=1/Ton where: Ton is transmit duration

8.3. WORST-CASE BELOW 1 GHz

SPURIOUS EMISSIONS 30 TO 1000 MHz (WORST-CASE CONFIGURATION)

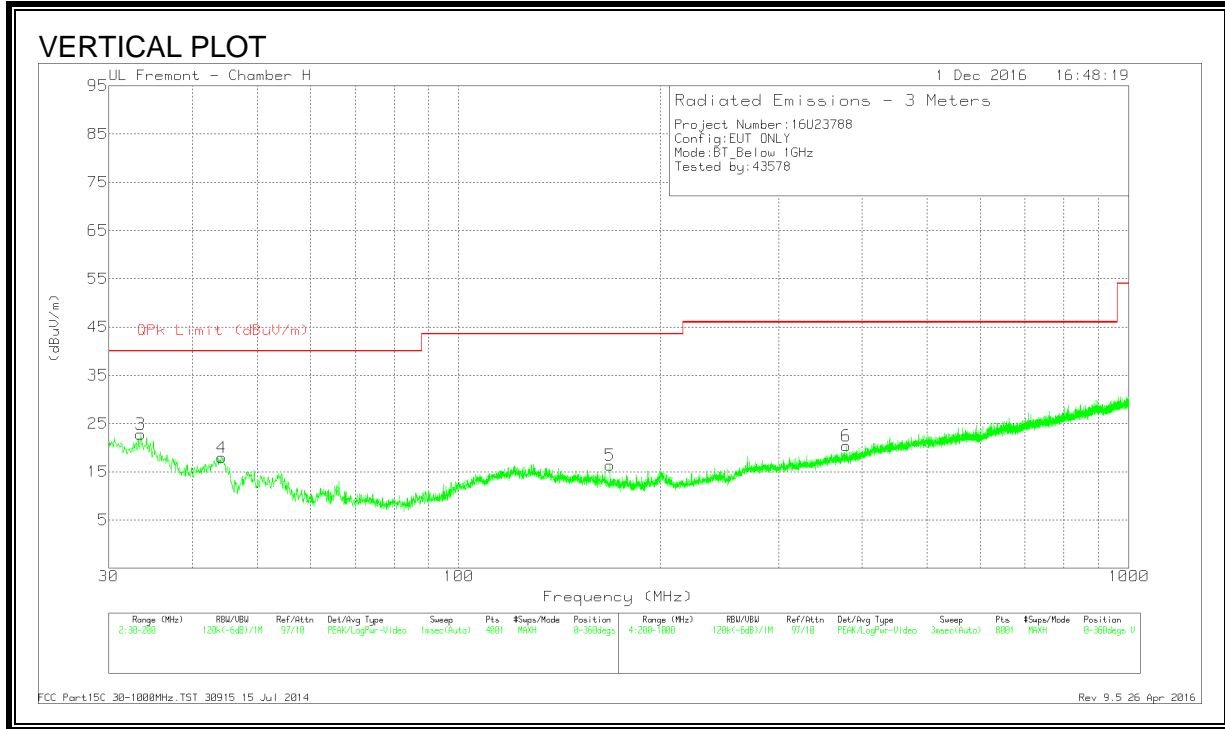
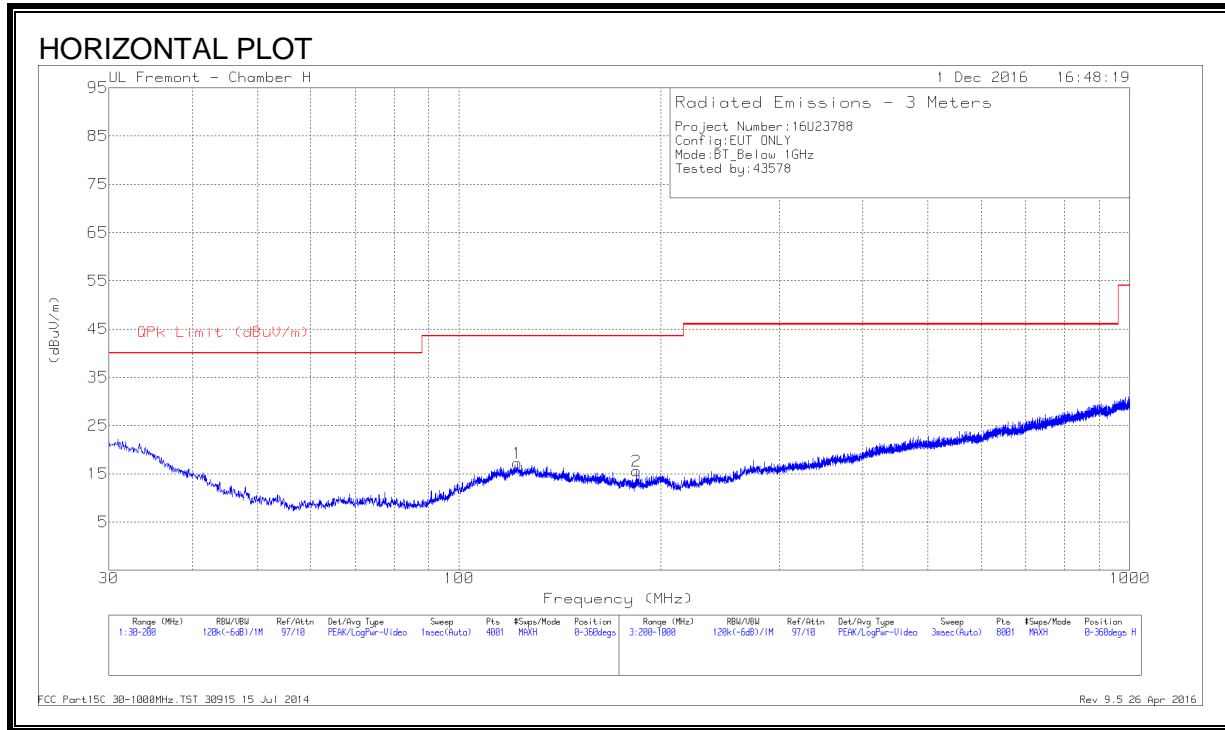

DATA

Marker	Frequency (MHz)	Meter Reading (dBuV)	Det	AF T407 (dB/m)	Amp/Cbl (dB)	Corrected Reading (dBuV/m)	QPk Limit (dBuV/m)	Margin (dB)	Azimuth (Degs)	Height (cm)	Polarity
1	* 122.055	29.7	Pk	17.8	-30.3	17.20	43.52	-26.32	0-360	101	H
5	* 167.9975	30.68	Pk	15.6	-29.9	16.38	43.52	-27.14	0-360	100	V
3	33.485	31.42	Pk	22.7	-31.3	22.82	40.00	-17.18	0-360	100	V
4	44.28	34.38	Pk	14.7	-31.1	17.98	40.00	-22.02	0-360	100	V
2	183.8075	30.37	Pk	15.0	-29.8	15.57	43.52	-27.95	0-360	101	H
6	378.4	30.2	Pk	18.9	-28.7	20.40	46.02	-25.62	0-360	399	V

* - indicates frequency in CFR47 Pt 15 / IC RSS-Restricted Band

Pk - Peak detector

8.4. WORST-CASE ABOVE 18 GHz

SPURIOUS EMISSIONS 18 TO 26 GHz (WORST-CASE CONFIGURATION, HORIZONTAL & VERTICAL)

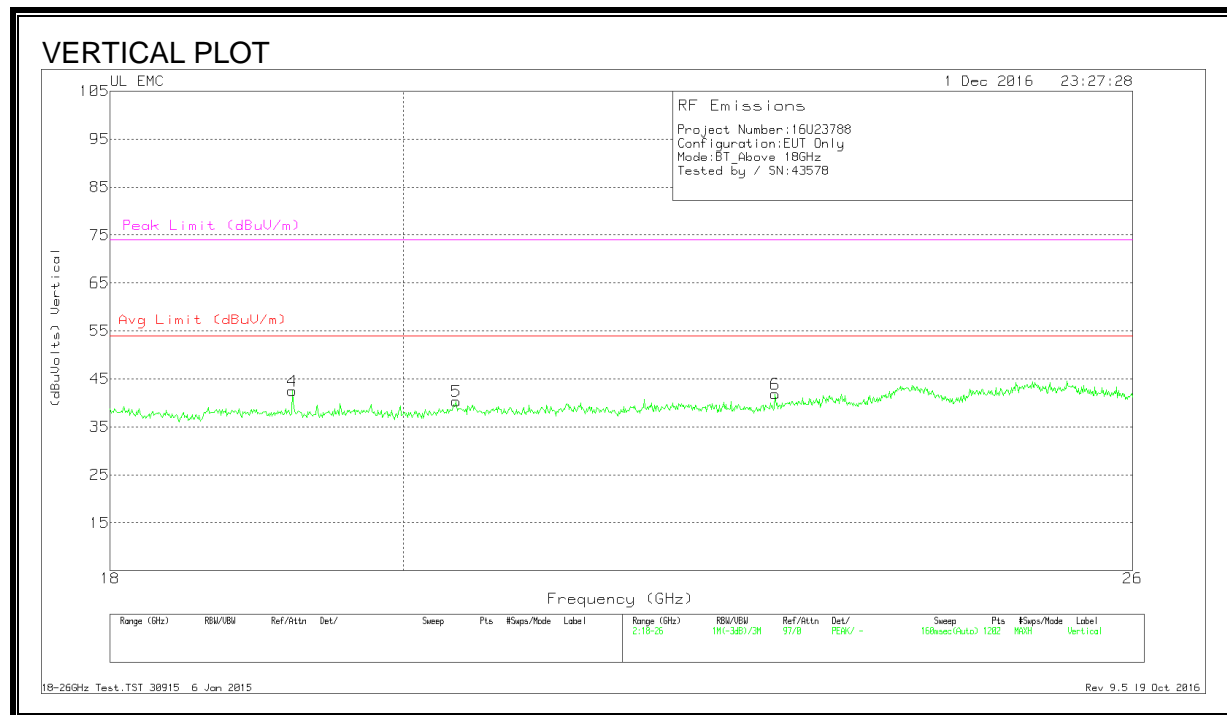
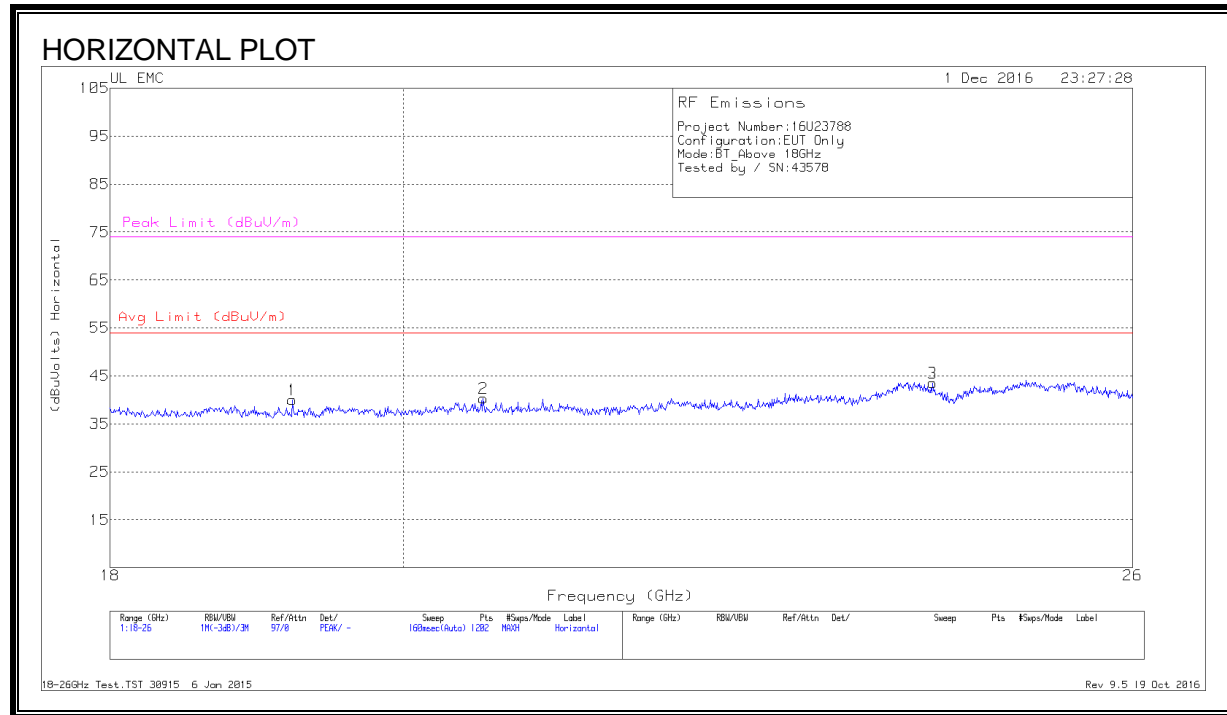

Data

Marker	Frequency (GHz)	Meter Reading (dBuV)	Det	AF T449 (dB/m)	Amp/Cbl (dB)	Dist Corr (dB)	Corrected Reading (dBuVolts)	Avg Limit (dBuV/m)	Margin (dB)	Peak Limit (dBuV/m)	PK Margin (dB)
1	19.219	41.6	Pk	32.7	-24.8	-9.5	40	54	-14	74	-34
2	20.585	42.43	Pk	32.9	-25.5	-9.5	40.33	54	-13.67	74	-33.67
3	24.195	43.2	Pk	33.9	-24.1	-9.5	43.5	54	-10.5	74	-30.5
4	19.219	44.1	Pk	32.7	-24.8	-9.5	42.5	54	-11.5	74	-31.5
5	20.385	42.03	Pk	32.9	-25.1	-9.5	40.33	54	-13.67	74	-33.67
6	22.863	42.83	Pk	33.4	-24.9	-9.5	41.83	54	-12.17	74	-32.17

Pk - Peak detector

9. AC POWER LINE CONDUCTED EMISSIONS

LIMITS

FCC §15.207 (a)

RSS-Gen 8.8

Frequency of Emission (MHz)	Conducted Limit (dB μ V)	
	Quasi-peak	Average
0.15-0.5	66 to 56 *	56 to 46 *
0.5-5	56	46
5-30	60	50

*Decreases with the logarithm of the frequency.

TEST PROCEDURE

The EUT is placed on a non-conducting table 40 cm from the vertical ground plane and 80 cm above the horizontal ground plane. The EUT is configured in accordance with ANSI C63.10.

The receiver is set to a resolution bandwidth of 9 kHz. Peak detection is used unless otherwise noted as quasi-peak or average.

Line conducted data is recorded for both NEUTRAL and HOT lines.

RESULTS

9.1. EUT POWERED BY AC/DC ADAPTER VIA USB CABLE

LINE 1 RESULTS

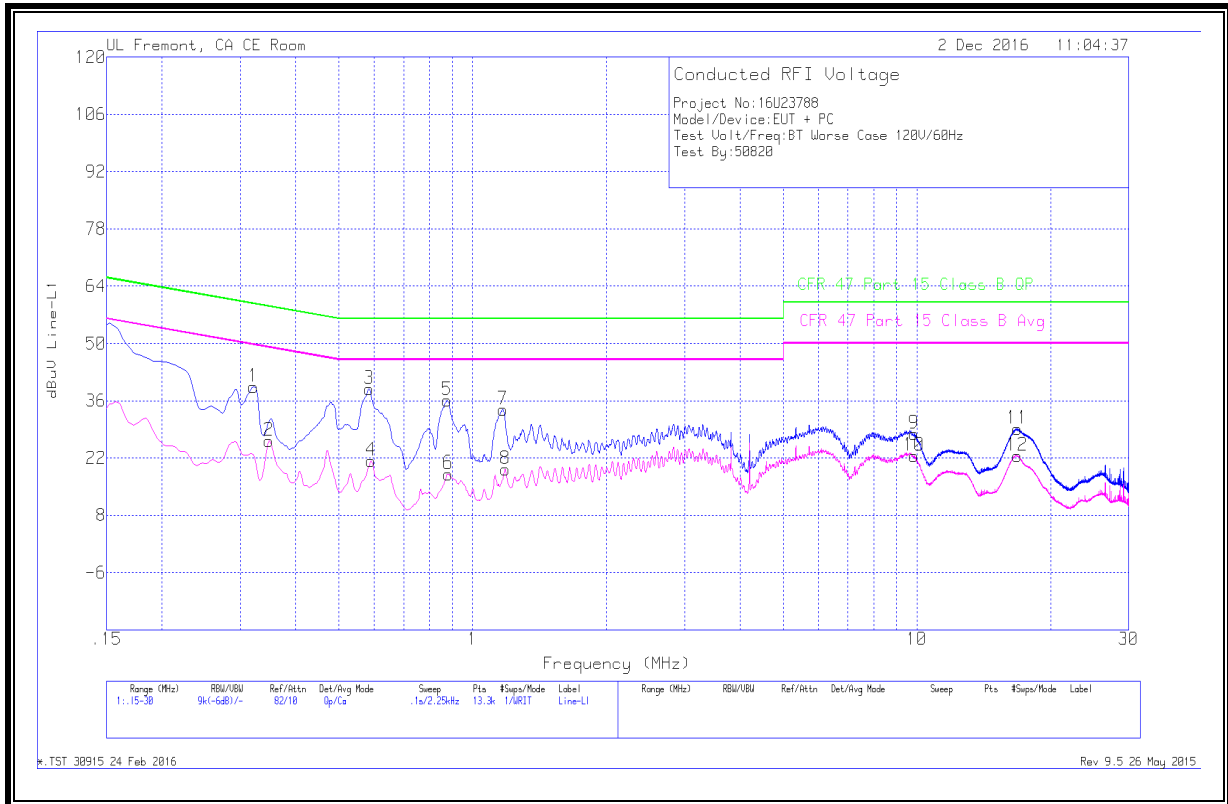

WORST EMISSIONS

Range 1: Line-L1 .15 - 30MHz

Marker	Frequency (MHz)	Meter Reading (dBuV)	Det	LISN L1	LC Cables 1&3	Limiter (dB)	Corrected Reading dBuV	CFR 47 Part 15 Class B QP	QP Margin (dB)	CFR 47 Part 15 Class B Avg	Av(CISPR) Margin (dB)
1	.168	33.49	Qp	0	0	10.1	43.59	65.06	-21.47	-	-
2	.168	16.98	Ca	0	0	10.1	27.08	-	-	55.06	-27.98
3	.25125	29.29	Qp	0	0	10.1	39.39	61.72	-22.33	-	-
4	.2535	12.77	Ca	0	0	10.1	22.87	-	-	51.64	-28.77
5	.339	26.26	Qp	0	0	10.1	36.36	59.23	-22.87	-	-
6	.33675	10.14	Ca	0	0	10.1	20.24	-	-	49.28	-29.04
7	.41775	19.39	Qp	0	0	10.1	29.49	57.49	-28	-	-
8	.42225	6.22	Ca	0	0	10.1	16.32	-	-	47.4	-31.08
9	.5955	18.82	Qp	0	0	10.1	28.92	56	-27.08	-	-
10	.5955	9.49	Ca	0	0	10.1	19.59	-	-	46	-26.41
11	.7665	29	Qp	0	0	10.1	39.1	56	-16.9	-	-
12	.771	17.92	Ca	0	0	10.1	28.02	-	-	46	-17.98

Qp - Quasi-Peak detector

Ca - CISPR average detection

LINE 2 RESULTS

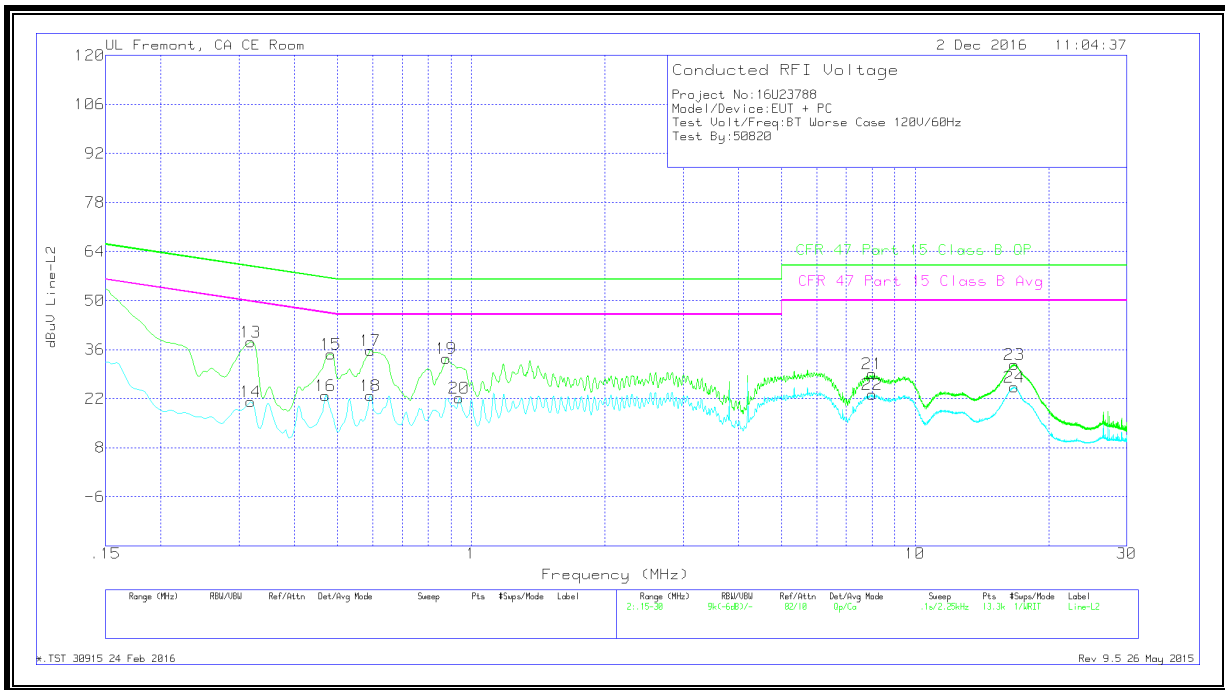

WORST EMISSIONS

Range 2: Line-L2 .15 - 30MHz

Marker	Frequency (MHz)	Meter Reading (dBuV)	Det	LISN L2	LC Cables 2&3	Limiter (dB)	Corrected Reading dBuV	CFR 47 Part 15 Class B QP	QP Margin (dB)	CFR 47 Part 15 Class B Avg	Av(CISPR) Margin (dB)
13	.168	34.33	Qp	0	0	10.1	44.43	65.06	-20.63	-	-
14	.168	18.44	Ca	0	0	10.1	28.54	-	-	55.06	-26.52
15	.2535	29.75	Qp	0	0	10.1	39.85	61.64	-21.79	-	-
16	.2535	15.49	Ca	0	0	10.1	25.59	-	-	51.64	-26.05
17	.339	25.69	Qp	0	0	10.1	35.79	59.23	-23.44	-	-
18	.33675	12.51	Ca	0	0	10.1	22.61	-	-	49.28	-26.67
19	.4245	20.27	Qp	0	0	10.1	30.37	57.36	-26.99	-	-
20	.42225	7.89	Ca	0	0	10.1	17.99	-	-	47.4	-29.41
21	.5955	19.49	Qp	0	0	10.1	29.59	56	-26.41	-	-
22	.5955	12.62	Ca	0	0	10.1	22.72	-	-	46	-23.28
23	.77325	29.16	Qp	0	0	10.1	39.26	56	-16.74	-	-
24	.7755	20.12	Ca	0	0	10.1	30.22	-	-	46	-15.78

Qp - Quasi-Peak detector
 Ca - CISPR average detection

9.2. EUT POWERED BY HOST PC VIA USB CABLE

LINE 1 RESULTS

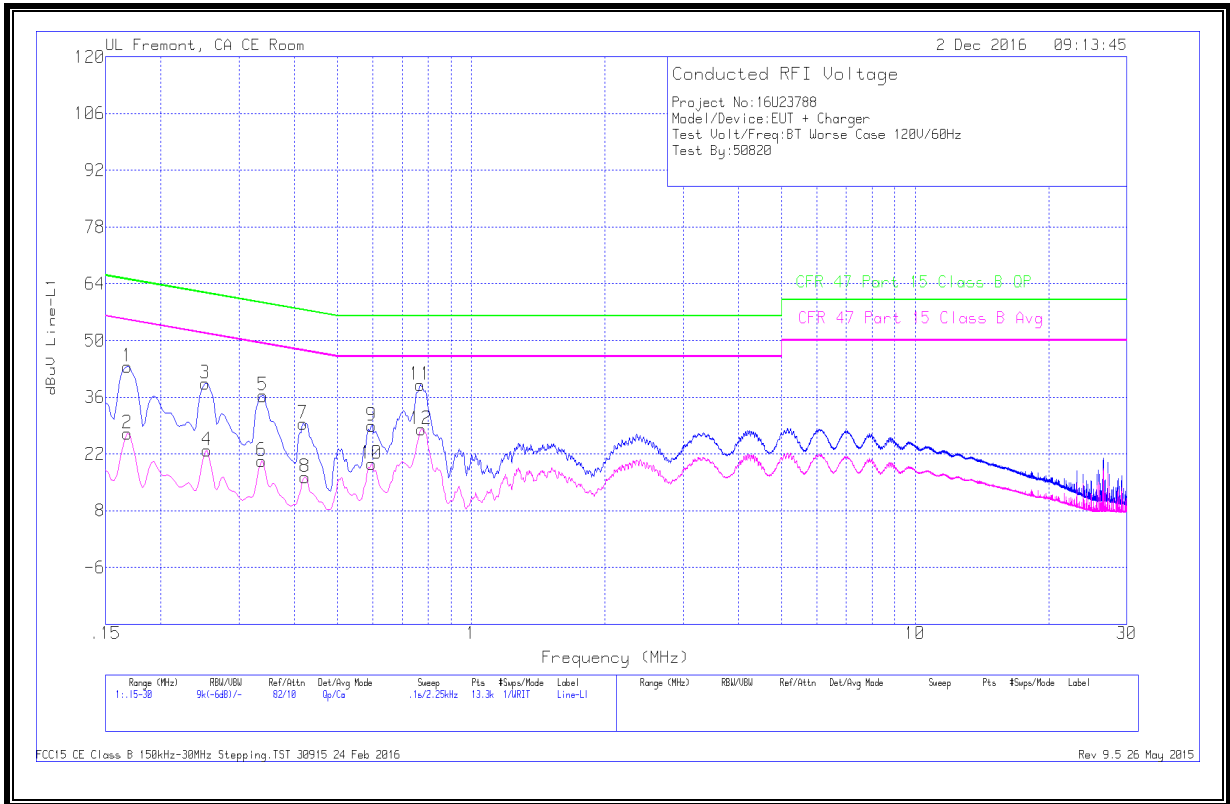

WORST EMISSIONS

Range 1: Line-L1 .15 - 30MHz

Marker	Frequency (MHz)	Meter Reading (dBuV)	Det	LISN L1	LC Cables 1&3	Limiter (dB)	Corrected Reading dBuV	CFR 47 Part 15 Class B QP	QP Margin (dB)	CFR 47 Part 15 Class B Avg	Av(CISPR) Margin (dB)
1	.321	29.22	Qp	0	0	10.1	39.32	59.68	-20.36	-	-
2	.348	16.06	Ca	0	0	10.1	26.16	-	-	49.01	-22.85
3	.58425	28.75	Qp	0	0	10.1	38.85	56	-17.15	-	-
4	.591	11.29	Ca	0	0	10.1	21.39	-	-	46	-24.61
5	.87675	25.96	Qp	0	0	10.1	36.06	56	-19.94	-	-
6	.88237	8	Ca	0	0	10.1	18.1	-	-	46	-27.9
7	1.16925	23.71	Qp	0	.1	10.1	33.91	56	-22.09	-	-
8	1.18388	9.06	Ca	0	.1	10.1	19.26	-	-	46	-26.74
9	9.87	17.6	Qp	0	.2	10.2	28	60	-32	-	-
10	9.87	12.14	Ca	0	.2	10.2	22.54	-	-	50	-27.46
11	16.818	18.61	Qp	0	.2	10.3	29.11	60	-30.89	-	-
12	16.8225	12.11	Ca	0	.2	10.3	22.61	-	-	50	-27.39

LINE 2 RESULTS

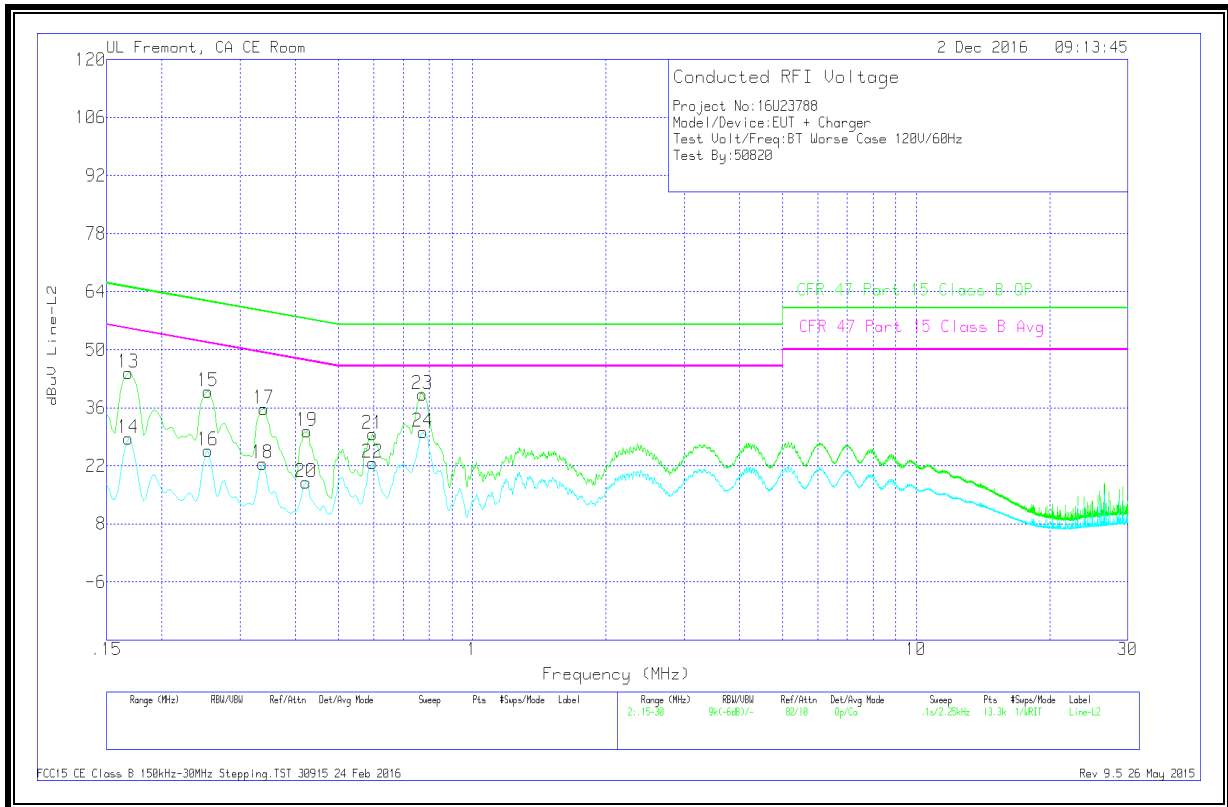

WORST EMISSIONS

Range 2: Line-L2 .15 - 30MHz

Marker	Frequency (MHz)	Meter Reading (dBuV)	Det	LISN L2	LC Cables 2&3	Limiter (dB)	Corrected Reading dBuV	CFR 47 Part 15 Class B QP	QP Margin (dB)	CFR 47 Part 15 Class B Avg	Av(CISPR) Margin (dB)
13	.31875	28.02	Qp	0	0	10.1	38.12	59.74	-21.62	-	-
14	.31875	11.01	Ca	0	0	10.1	21.11	-	-	49.74	-28.63
15	.483	24.56	Qp	0	0	10.1	34.66	56.29	-21.63	-	-
16	.4695	12.77	Ca	0	0	10.1	22.87	-	-	46.52	-23.65
17	.59212	25.61	Qp	0	0	10.1	35.71	56	-20.29	-	-
18	.59325	12.79	Ca	0	0	10.1	22.89	-	-	46	-23.11
19	.879	23.31	Qp	0	.1	10.1	33.51	56	-22.49	-	-
20	.93975	12.08	Ca	0	0	10.1	22.18	-	-	46	-23.82
21	8.00925	18.77	Qp	0	.1	10.2	29.07	60	-30.93	-	-
22	8.00925	13	Ca	0	.1	10.2	23.3	-	-	50	-26.7
23	16.7415	21.24	Qp	0	.2	10.3	31.74	60	-28.26	-	-
24	16.737	14.76	Ca	0	.2	10.3	25.26	-	-	50	-24.74