



EUROFINS PRODUCT SERVICE GMBH



# TEST - REPORT

FCC PART 15 D for Isochronous UPCS devices  
RSS-213 for LE-PCS devices

DECT Basestation  
WHB003BS

FCC ID: BCE-WHB003BS  
IC: 2386C-WHB003BS

Test report no.:G0M-1104-1092-C-2



Eurofins Product Service GmbH  
Storkower Str. 38c, D-15526 Reichenwalde,  
Germany

Phone +49-33631-888 00  
Fax +49-33631-888 660

## TABLE OF CONTENTS

<b>1.</b>	<b>General Information</b>	<b>4</b>
1.1	Notes	4
1.2	Testing laboratory	5
1.2.1	Location	5
1.2.2	Details of accreditation status	5
1.3	Details of approval holder	5
1.4	Application details	6
1.5	Test item	6
1.6	Test standards	8
<b>2.</b>	<b>Technical test</b>	<b>9</b>
2.1	Summary of test results	9
2.2	Test environment	9
2.3	Test equipment utilized	10
<b>3.</b>	<b>Results of Examinations and tests (enclosure)</b>	<b>11</b>
3.1	Examinations and Test Procedures	12
3.1.1	Coordination with fixed microwave service	12
3.1.2	Reference to Subpart B	12
3.1.3	Conducted limits AC Power line	13
3.1.4	Antenna requirement	14
3.1.5	Modulation techniques	14
3.1.6	Emission bandwidth	15
3.1.7	Peak transmit power	17
3.1.8	Power spectral density	18
3.1.9	Directional gain of antenna	19
3.1.10	Automatic discontinuation of transmission	20
3.1.11	Radio frequency radiation exposure	21
3.1.12	Monitoring threshold; Least interfered channel	22
3.1.13	Monitoring of intended transmit window and maximum reaction time	25
3.1.14	Monitoring bandwidth, Monitoring reaction time	27
3.1.15	Random waiting interval	28
3.1.16	Connection acknowledgements, Unacknowledged transmissions	29
3.1.17	Selected channel confirmation, segment occupancy	30
3.1.18	Monitoring antenna	31
3.1.19	Alternative monitoring interval for co-located devices	32
3.1.20	Fair access to spectrum	32
3.1.21	Radiated spurious emissions, generally requirements	33
3.1.22	Emissions inside and outside the sub-bands	36
3.1.23	Frame period	38
3.1.24	Frequency stability	40
3.1.25	Receiver spurious emissions, RSS-213 6.8	41

<b>Annex A</b>	<b>Photos</b>	<b>42</b>
<b>Annex A</b>	<b>Conducted limits AC Power line</b>	<b>45</b>
<b>Annex B</b>	<b>Emission bandwidth</b>	<b>47</b>
<b>Annex C</b>	<b>Occupied Bandwidth</b>	<b>51</b>
<b>Annex D</b>	<b>Peak Transmit Power</b>	<b>54</b>
<b>Annex E</b>	<b>Power spectral density</b>	<b>60</b>
<b>Annex F</b>	<b>Monitoring threshold</b>	<b>62</b>
<b>Annex G</b>	<b>Monitoring of intended transmit window and maximum reaction time</b>	<b>67</b>
<b>Annex H</b>	<b>Monitoring bandwidth</b>	<b>69</b>
<b>Annex I</b>	<b>Connection acknowledgement</b>	<b>73</b>
<b>Annex J</b>	<b>Emission inside and outside the sub-band; Spurious Emission</b>	<b>77</b>
<b>Annex K</b>	<b>Frame period</b>	<b>82</b>
<b>Annex L</b>	<b>Frequency Stability</b>	<b>84</b>
<b>Annex M</b>	<b>Transmitter radiated spurious emissions</b>	<b>89</b>
<b>Annex N</b>	<b>Receiver radiated spurious emissions</b>	<b>125</b>

**1. General Information**
**1.1 Notes**

The results of this test report relate exclusively to the item tested as specified in chapter "Description of test item" and are not transferable to any other test items.

Eurofins Product Service GmbH is not responsible for any generalisations and conclusions drawn from this report. Any modification of the test item can lead to invalidity of test results and this test report may therefore be not applicable to the modified test item.

The test report may only be reproduced or published in full. Reproducing or publishing extracts of the report requires the prior written approval of the Eurofins Product Service GmbH.

This document is subject to the General Terms and Conditions and the Testing and Certification System of Eurofins Product Service GmbH, available on request or accessible at [www.pt.eurofins.com](http://www.pt.eurofins.com)

**Specific Conditions.**

Usage of the hereunder tested device in combination with other integrated or external antennas requires at least additional output power measurements, spurious emission measurements, conducted emission measurements (AC supply lines) and radio frequency exposure evaluations are performed for each individual configuration.

This report relates to FCC-Part15B applied on UPCS devices with the technology which is derived from the DECT standard.

Additionally this report covers the requirements of RSS-213 (2GHz Licence-exempt Personal Communications Services Devices (LE-PCS)), released by Industry Canada (IC). In the following the term UPCS covers therefore also LE-PCS.

**Operator:**

14.09.2011		W. Treffke	
Date	Eurofins Lab.	Name	Signature

**Technical responsibility for area of testing:**

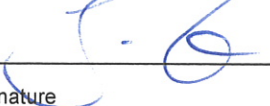
14.09.2011		J. Zimmermann	
Date	Eurofins	Name	Signature

**1.2 Testing laboratory****1.2.1 Location**

EUROFINS PRODUCT SERVICE GMBH  
Storkower Straße 38c  
D-15526 Reichenwalde b. Berlin  
Germany  
Telefon : +49 33631 888 00  
Telefax : +49 33631 888 66

**1.2.2 Details of accreditation status****DAR ACCREDITED TESTING LABORATORY**

DAR-REGISTRATION NUMBER: DAT-P-268/08

**RECOGNIZED NOTIFIED BODY EMC**

REGISTRATION NUMBER: BNetzA-bS EMV-07/61

**RECOGNIZED NOTIFIED BODY R&TTE**

REGISTRATION NUMBER: BNetzA-bS-02/51-53

**FCC FILED TEST LABORATORY**

REG.-No. 96970

**A2LA ACCREDITED TESTING LABORATORY**

CERTIFICATE No. 1983.01

**BLUETOOTH QUALIFICATION TEST FACILITY (BQTF)**

ACCREDITED BY BLUETOOTH QUALIFICATION REVIEW BOARD

**INDUSTRY CANADA FILED TEST LABORATORY**

REG. No. IC 3470

**1.3 Details of approval holder**

Name : GN Netcom A/S  
Street : Lautrupbjerg 7  
Town : DK-2750 Ballerup  
Country : Denmark  
Telephone : +45 4575 8888  
  
Contact : Mr. Steen Kaiser  
Telephone : +45 4575 8888  
E-mail : skaiser@jabra.com

**1.4 Application details**

Date of receipt of application : 18.04.2011  
 Date of receipt of test item : 18.04.2011  
 Date of test : 18.04.2011 – 26.05.2011

**1.5 Test item**

Description of test item : Isochronous UPCS device, cordless phone based on DECT modified technology.

Function	
Portable part	
Base station	<input checked="" type="checkbox"/>
Repeater	

Description of test item : DECT Basestation

Type identification : WHB003BS

Serial number : without

Photos : See annex

**Technical data**

Frequency bands : 1920 – 1930 MHz

Operating Channel numbers	Test Frequencies	Channel center frequency (MHz)
4	$F_L$	1921.536
3		1923.264
2	$F_M$ *)	1924.992
1		1926.720
0	$F_H$	1928.448

\*) for frequency stability test and spurious emission test in RX mode only

Number of channels : 60 (in time and spectrum window, declared by manufacturer)

Operating modes : MC/TDMA/TDD

Type of modulation : GFSK

Max. slot type:

single slot	<input checked="" type="checkbox"/>
double slot	<input type="checkbox"/>

 Fixed point-to-point operation: Yes/No

Antenna	Type	Gain [dBi]	internal	external
1	pcb antenna	3.3	<input checked="" type="checkbox"/>	<input type="checkbox"/>

Antenna diversity :

Antenna	Diversity supported	
	Tx	Rx
1	<input checked="" type="checkbox"/>	<input type="checkbox"/>

Host device : none

Classification : related to radio frequency radiation exposure

Fixed Device	<input type="checkbox"/>
Mobile Device (Human Body distance > 20cm)	<input checked="" type="checkbox"/>
Portable Device (Human Body distance < 20cm)	<input type="checkbox"/>

Power supply : 7.5VDC                      120VAC Adapter

Data connection :

Connection	used
None	<input type="checkbox"/>
PSTN	<input type="checkbox"/>
Data Networks	<input type="checkbox"/>
others	<input checked="" type="checkbox"/>

Remark: Devices intended to be connected to PSTN have to be applied for FCC PART 68 registration, in USA and for Industry Canada standard CS-03.

**Manufacturer:**  
(if applicable)

Name : GN Netcom A/S  
Street : Lautrupbjerg 7  
Town : DK-2750 Ballerup  
Country : Denmark

**1.6 Test standards**

Technical standard : FCC PART 15, Subpart D; RSS-213

Test method and procedure: Following requirements of FCC Part 15 D, RSS-213 and ANSI C63.17-2006

Additional information: The row scheme for frequency generation, radio channels, receiver parameters, synchronization procedure, and other parameters are determined by the DECT standard. Details are content of operational description provided by manufacturer.



## 2. Technical test

### 2.1 Summary of test results

No deviations from the technical specification(s) were ascertained in the course of the tests performed.

or

The deviations as specified in 3.0 were ascertained in the course of the tests performed.

### 2.2 Test environment

Temperature : 23°C

Relative humidity content : 20 ... 75 %

Air pressure : 86 ... 103 kPa

Details of power supply : 7.5VDC 120VAC Adapter

Extreme conditions parameters: : test voltage - extreme min : 7VDC  
(manufacturer declaration) max: 8VDC

temperatures – extreme min: 0°C <sup>1)</sup>  
max: 50°C <sup>1)</sup>

Remarks: <sup>1)</sup> declared by manufacturer

**2.3 Test equipment utilized**

No.	Test equipment	Type	Manufacturer
ETS 0012	Biconical Antenna	HK 116	R & S
ETS 0013	LPD Antenna	HL 223	R & S
ETS 0014	Log Periodical Antenna	HL 025	R & S
ETS 0031	Turn table	DS 412	Heinrich Deisel
ETS 0064	CDN IEC 61000-4-6		Keytek/ EMC
ETS 0066	EM Injection Clamp		FCC/ EMC
ETS 0067	Calibration Fixture	IEC 801-2031 CF	FCC/ EMC
ETS 0105	RF Signal Generator (High power synthesizer/ sweeper)	SMP 02 (SMP 22 / 02)	R & S
ETS 0125	Reference dipole	0003126-1880	ETS Lindgren
ETS 0224C	Programmable high resolution timer counter	PM6654G	Philips
ETS 0253	Spectrum Analyzer	FSIQ 26	R & S
ETS 0267	RF Signal Generator	SMT 03	R & S
ETS 0273	Signal Generator	SME 03	R & S
ETS 0288	Artificial mains	ESH2-Z5	R & S
ETS 0310	Anechoic chamber	AC 3	Frankonia
ETS 0474	EMI Test Receiver	ESCS 30	R&S
ETS 0492	Industrial Controller	PSM12	R & S
ETS 0494	Switching unit	SSCU	R & S
ETS 0495	RF Step Attenuator	RSP	R & S
ETS 0496	Spectrum Analyzer	FSP	R & S
ETS 0497	Power Meter	NRVD	R & S
ETS 0498	Diode Power Sensor	NRV-Z1	R & S
ETS 0500	Signal Generator	SMIQ03	R & S
ETS 0501	Signal Generator	SMIQ03	R & S
ETS 0502	Power Splitter	DS-808-4	Macom

**3. Results of Examinations and tests (enclosure)**

TEST CASE	FCC Rules	RSS-213	Required	Customer Declaration	Test passed	Test failed
Coordination with fixed microwave service	15.307 (b)		<input checked="" type="checkbox"/>	<input checked="" type="checkbox"/>	<input type="checkbox"/>	<input type="checkbox"/>
Reference to Subpart B	15.309 (b)		<input type="checkbox"/>	<input type="checkbox"/>	<input type="checkbox"/>	<input type="checkbox"/>
Conducted limits AC Power line	15.315 , 15.207	4.2;6.3	<input checked="" type="checkbox"/>	<input type="checkbox"/>	<input checked="" type="checkbox"/>	<input type="checkbox"/>
Antenna requirement	15.317, 15.203		<input checked="" type="checkbox"/>	<input type="checkbox"/>	<input checked="" type="checkbox"/>	<input type="checkbox"/>
Modulation techniques	15.319 (b)	6.1	<input checked="" type="checkbox"/>	<input checked="" type="checkbox"/>	<input type="checkbox"/>	<input type="checkbox"/>
Emission bandwidth	15.323 (a)	6.4	<input checked="" type="checkbox"/>	<input type="checkbox"/>	<input checked="" type="checkbox"/>	<input type="checkbox"/>
Peak Transmit Power	15.319 (c)	4.3.1;6.5	<input checked="" type="checkbox"/>	<input type="checkbox"/>	<input checked="" type="checkbox"/>	<input type="checkbox"/>
Power spectral density	15.319 (d)	4.3.1;6.6	<input checked="" type="checkbox"/>	<input type="checkbox"/>	<input checked="" type="checkbox"/>	<input type="checkbox"/>
Directional gain of the antenna	15.319 (e)	4.1 (e)	<input checked="" type="checkbox"/>	<input checked="" type="checkbox"/>	<input type="checkbox"/>	<input type="checkbox"/>
Automatic discontinuation of transmission	15.319 (f)	4.3.4 (a)	<input checked="" type="checkbox"/>	<input type="checkbox"/>	<input checked="" type="checkbox"/>	<input type="checkbox"/>
Radio frequency radiation exposure	15.319 (i)	RSS – 102 Gen 5.5	<input checked="" type="checkbox"/>	<input type="checkbox"/>	<input checked="" type="checkbox"/>	<input type="checkbox"/>
Monitoring threshold	15.323(c)(2); (c)(9)	4.3.4 (b)(2)	<input checked="" type="checkbox"/>	<input type="checkbox"/>	<input checked="" type="checkbox"/>	<input type="checkbox"/>
Monitoring of intended transmit window and maximum reaction time	15.323(c)(1)	4.3.4 (b)(1)	<input checked="" type="checkbox"/>	<input type="checkbox"/>	<input checked="" type="checkbox"/>	<input type="checkbox"/>
Monitoring bandwidth	15.323 (c)(7)	4.3.4 (b)(7)	<input checked="" type="checkbox"/>	<input type="checkbox"/>	<input checked="" type="checkbox"/>	<input type="checkbox"/>
Random waiting interval	15.323 (c)(6)	4.3.4 (b)(6)	<input type="checkbox"/>	<input type="checkbox"/>	<input type="checkbox"/>	<input type="checkbox"/>
Duration of transmission	15.323 (c)(3)	4.3.4 (b)(3)	<input type="checkbox"/>	<input type="checkbox"/>	<input type="checkbox"/>	<input type="checkbox"/>
Connection acknowledgement	15.323 (c)(4)	4.3.4 (b)(4)	<input checked="" type="checkbox"/>	<input type="checkbox"/>	<input checked="" type="checkbox"/>	<input type="checkbox"/>
Selected channel confirmation, power accuracy, segment occupancy	15.323 (c)(5)	4.3.4 (b)(5)	<input checked="" type="checkbox"/>	<input type="checkbox"/>	<input checked="" type="checkbox"/>	<input type="checkbox"/>
Monitoring antenna	15.323 (c)(8)	4.3.4 (b)(8)	<input checked="" type="checkbox"/>	<input checked="" type="checkbox"/>	<input type="checkbox"/>	<input type="checkbox"/>
Duplex connections	15,323 (c)(10)	4.3.4 (b)(10)	<input type="checkbox"/>	<input type="checkbox"/>	<input type="checkbox"/>	<input type="checkbox"/>
Alternative monitoring interval for co-located devices	15.323 (c)(11)	4.3.4 (b)(11)	<input checked="" type="checkbox"/>	<input checked="" type="checkbox"/>	<input type="checkbox"/>	<input type="checkbox"/>
Fair access to spectrum related to (c)(10) and (c)(11)	15.323 (c)(12)	4.3.4 (b)(12)	<input checked="" type="checkbox"/>	<input checked="" type="checkbox"/>	<input type="checkbox"/>	<input type="checkbox"/>
Emissions inside and outside the sub-band	15.323 (d)	6.7	<input checked="" type="checkbox"/>	<input type="checkbox"/>	<input checked="" type="checkbox"/>	<input type="checkbox"/>
Frame period	15.323 (e)	4.3.4 (c)	<input checked="" type="checkbox"/>	<input type="checkbox"/>	<input checked="" type="checkbox"/>	<input type="checkbox"/>
Frequency stability	15.323 (f)	6.2	<input checked="" type="checkbox"/>	<input type="checkbox"/>	<input checked="" type="checkbox"/>	<input type="checkbox"/>
Receiver spurious emissions		6.8	<input checked="" type="checkbox"/>	<input type="checkbox"/>	<input checked="" type="checkbox"/>	<input type="checkbox"/>

### 3.1 Examinations and Test Procedures

The test procedures are performed following the requirements of FCC Part 15, RSS-213 and test standard ANSI C63.17-2006 [American National Standard for Methods of Measurement of the Electromagnetic and Operational Compatibility of Unlicensed Personal Communications Services (UPCS) Devices].

#### 3.1.1 Coordination with fixed microwave service

Related Rules and Regulations: FCC 15.307 (b)

For USA UTAM, Inc., is designated to coordinate and manage the transition of the 1910 – 1930 MHz band from Private Operational-Fixed Microwave Service (OFS) operating under Part 94 of this Chapter to unlicensed PCS operations.

Therefore each applicant for certification operating under the provisions of this Subpart must be accompanied by an affidavit from UTAM, Inc. certifying that the applicant is a participating member of UTAM, Inc.

The affidavit from UTAM Inc. is attached in Annex	<input type="checkbox"/>
The applicant will provide the affidavit from UTAM Inc. later in the course of certification by TCB or FCC	<input checked="" type="checkbox"/>

#### 3.1.2 Reference to Subpart B

Related Rules and Regulations: FCC 15.309 (b)

For USA the requirements of Subpart D apply only to the radio transmitter contained in the PCS device. Other aspects of the operation of a PCS device may be subject to requirements contained elsewhere in this Chapter. In particular, a PCS device that includes digital circuitry not direct associated with the radio transmitter also is subject to the requirements for unintentional radiators in Subpart B,

For Canada unintentional radiators, other than radio receivers, are regulated by the Departments Interference Causing Equipment Standards.

Test procedures: FCC Part 15B, ICES - 003

This requirement is not applicable because the test sample does not include digital circuitry which is not direct associated with the radio transmitter	<input checked="" type="checkbox"/>
For test results according to FCC 15B and / or ICES – 003 see Annex	<input type="checkbox"/>
This requirement is covered by results of radiated emission test according to FCC 15.323(d) and / or RSS – 213 6.7	<input type="checkbox"/>

### 3.1.3 Conducted limits AC Power line

Related Rules and Regulations: FCC 15.315, 15.207; RSS-213 4.2, 6.3 / RSS – Gen 7.2.2

For an intentional radiator which is designed to be connected to the public utility (AC) power line, the radio frequency voltage that is conducted back onto the AC line on any frequency or frequencies within the band 150 kHz to 30 MHz shall not exceed the limits in the table below. Compliance with this provision shall be based on the measurement of the radio frequency voltage between each power line and ground at the power terminals.

This measurement was transact first with instrumentation using an average and peak detector and a 10 kHz bandwidth. If the peak detector achieves a calculated level, the measurement is repeated by an instrumentation using a quasi-peak detector.

Frequency	Level	
	quasi-peak	average
150 kHz	Lower limit line	Lower limit line

#### Limits:

Frequency of Emission (MHz)	Conducted Limit (dBuV)	
	Quasi Peak	Average
0.15-0.5	66 to 56	56 to 46
0.5-5	56	46
5-30	60	50

#### Verdict:

Pass	Fail
<input checked="" type="checkbox"/>	<input type="checkbox"/>

For measurements diagrams see Annex.

### 3.1.4 Antenna requirement

Related Rules and Regulations: FCC 15.317, 15.203

For USA an UPCS device must meet the antenna requirement of Section 15.203.

Outcome of visual inspection:

This unit uses internal antennas. There is no provision for an external antenna.	<input checked="" type="checkbox"/>
This unit uses an unique antenna jack for connection to dedicated external antenna	<input type="checkbox"/>
This unit has external antenna.	<input type="checkbox"/>
This unit with its antenna will be professionally installed as described in manufacturers description.	<input type="checkbox"/>

See Annex A for pictures.

In this arrangement the EUT fulfils the requirements of FCC 15.203.

### 3.1.5 Modulation techniques

Related Rules and Regulations: FCC 15.319 (b); RSS-213 6.1

All transmissions must use only digital modulation.

The test sample is an isochronous digital modulated device that operates in 1920-1930 MHz band. This device bases on DECT technology described in European Standards EN 300 175-2 and EN 300 175-3, now operating in frequency channels mentioned before on sub-clause 1.5.

The operating modes are MC/TDMA/TDD (Multi carrier / Time Division Multiple Access / Time Division Duplex) using Digital GFSK modulation.

For further details see operational description provided by manufacturer.

### 3.1.6 Emission bandwidth

Related Rules and Regulations: FCC 15.323 (a); RSS 213 6.4

Operation will be contained within the 1920 – 1930 MHz band. The emission bandwidth shall be less than 2.5 MHz , but in no event the emission bandwidth shall be less than 50 kHz.

Emission bandwidth is measured according to ANSI 63.17 sub-clause 6.1.3 using test set-up no. 1.

$f_x = 1921.54\text{MHz}$			
$\Delta P$	$f_{(low)}$	$f_{(high)}$	$\Delta f = f_{(high)} - f_{(low)}$
-26	1920.81	1922.26	1.45
-12	1921.012	1922.05	1.03
-6	1921.192	1921.842	0.65

$f_x = 1928.45\text{ MHz}$			
$\Delta P$	$f_{(low)}$	$f_{(high)}$	$\Delta f = f_{(high)} - f_{(low)}$
-26	1927.72	1929.17	1.45
-12	1927.924	1928.994	1.07
-6	1928.09	1928.792	0.70

### Occupied Bandwidth (99%) – RSS Gen

Test conditions	Channel 4 MHz	Channel 2 MHz	Channel 0 MHz
$T_{nom} = 23^\circ\text{C}$ $V_{nom} = 7\text{VDC}$	1.184	1.184	1.184
Measurement uncertainty	< 10 Hz		

Limit:

$\Delta f_{min} (-26\text{dB})$	>	50 KHz
$\Delta f_{max} (-26\text{dB})$	<	2.5 MHz

Verdict:

Pass	Fail
<input checked="" type="checkbox"/>	<input type="checkbox"/>

For measurements diagrams see Annex.

Test set-up 1 – General equipment configuration for conducted RF tests

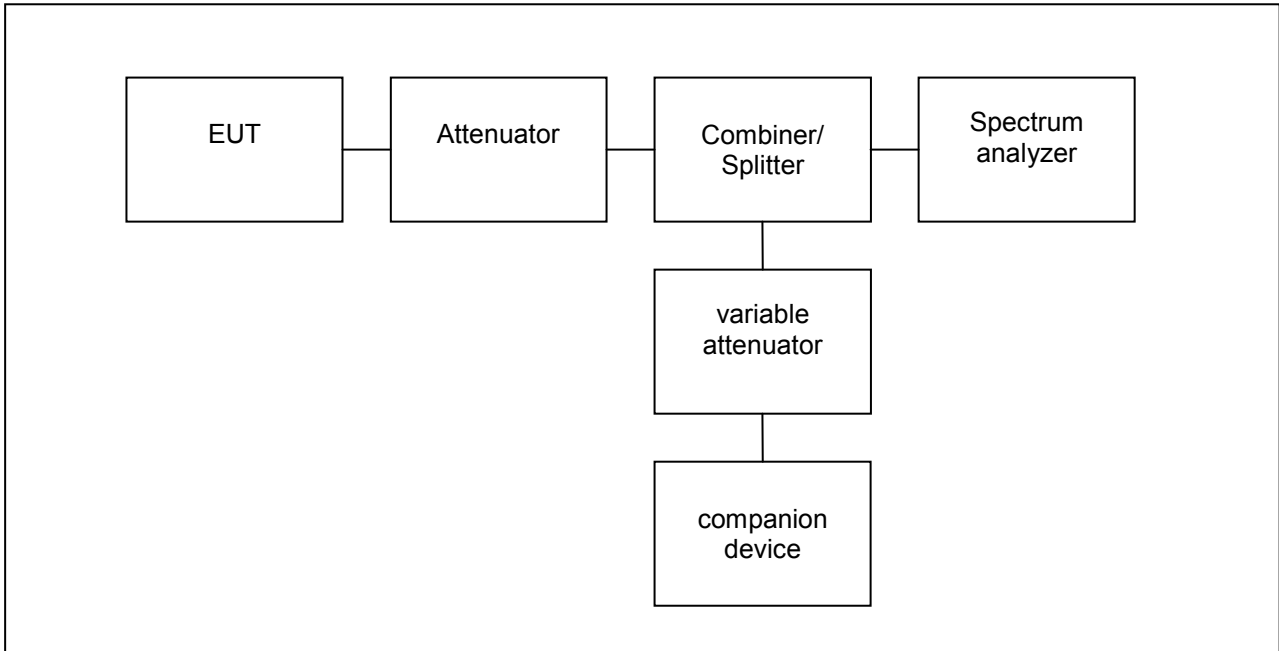



### 3.1.7 Peak transmit power

Related Rules and Regulations: FCC 15.319 (c), FCC 15.31(e); RSS–213 4.3.1, 6.5

Peak transmit power shall not exceed 100 microwatts multiplied by the square root of the emission bandwidth in hertz. Peak transmit power must be measured over any interval of continuous transmission using instrumentation calibrated in terms of an rms-equivalent voltage. The measurement results shall be properly adjusted for any instrument limitations, such as detector response times, limited resolution bandwidth capability when compared to the emission bandwidth, sensitivity, etc., so as to obtain a true peak measurement for the emission in question over the full bandwidth of the channel.

The Peak transmit Power is measured according to ANSI 63.17 sub-clause 6.1.2. using test set-up No. 1. The limit for Peak Transmit Power has to be calculated according to following formula using the emission bandwidth measured before and the directional antenna gain.

$$\begin{aligned} \text{PTP} &= 100\mu\text{W} \times \sqrt{\text{EBW}} \\ \text{when } G_A \leq g & \quad \text{PTP} = 100\mu\text{W} \times \sqrt{\text{EBW} - (G_A - g)} \end{aligned}$$

EBW = emission bandwidth [Hz]

$G_A$  = EUT antenna gain [dBi]

$g$  = Allowable excess gain over that of an isotropic antenna without a transmit power reduction [ $g = 3$  dB, acc. to FCC 15.319 (e)] and / or RSS–213 4.1(e)

The directional gain of used antenna has to be considered.

The test is performed with the variation of supply voltage of +/- 15% for FP. For PP a full battery is used. For devices with transmitter antenna diversity is checked that the feeding way to all antennas is identical. Therefore one conducted PTP measurements is sufficient.

Results:

On the attached diagrams PEAK AVG represents the related measurement value determined by values in time between T1 and T2.

Frequency [MHz]	Power [dBm]		
	for $V_{nom}$	for $V_{max}$	for $V_{min}$
$F_L$	18.40	18.33	18.39
$F_H$	18.20	18.37	18.39

Limit:

EBW [MHz]	Max. power [dBm]	Corrected by antenna gain > 3 dBi
1.45	20.80	--

Verdict:

Pass	Fail
<input checked="" type="checkbox"/>	<input type="checkbox"/>

For measurements diagrams see Annex.

**3.1.8 Power spectral density**

Related Rules and Regulations: FCC 15.319 (d); RSS-213 4.3.2.1, 6.6

Power spectral density shall not exceed 3 mW in any 3 kHz bandwidth as measured with a spectrum analyzer having a resolution bandwidth of 3 kHz.

Power spectral density is measured according to ANSI 63.17 sub-clause 6.1.5 using test set-up No. 1.

Max Hold function is applied to Max Peak detector with used sweep time as long as no changes on the curve are visible.

Results:

Frequency [MHz]	Power density [mW/3kHz]
F <sub>L</sub>	0.2558
F <sub>H</sub>	0.8264

Limit:

Power spectral Density	Test condition
3 mW = 4.77 dBm	3 kHz bandwidth

Verdict:

Pass	Fail
<input checked="" type="checkbox"/>	<input type="checkbox"/>

For measurements diagrams see Annex.

**3.1.9 Directional gain of antenna**

Related Rules and Regulations: FCC 15.319 (e), RSS 213 4.1(e)

The peak transmit power shall be reduced by the amount in decibels that the maximum directional gain of the antenna exceeds 3 dBi.

Procedure: Consideration of antenna gain value provided by manufacturer or additional radiated test of Peak transmit power.

Max antenna gain [dBi]	Exceeds 3 dBi by amount [dB]
3.3dBi	0.3dBi

The antenna gain value is derived from:

Manufacturer declaration	<input checked="" type="checkbox"/>
Antenna diagram	<input type="checkbox"/>
Measured gain of complete system	<input type="checkbox"/>

Comment: Manufacturer declaration documents or Antenna diagrams will be considered in course of certification by responsible authority.

**3.1.10 Automatic discontinuation of transmission**

Related Rules and Regulations: FCC 15.319 (f); RSS-213 4.3.4 (a)

The device shall automatically discontinue transmission in case of either absence of information to transmit or operational failure. These provisions are not intended to preclude transmission of control and signaling information or use of repetitive codes used by certain digital technologies to complete frame or burst intervals.

FP repetitive codes are allowed	<input checked="" type="checkbox"/>
PP	<input type="checkbox"/>

Automatic break off the transmission means break off of connection and break of transmissions which are not control and signaling information or receptive codes of complete frame or burst intervals. In case of devices using basics of DECT technology at least fixed parts and repeaters are using control and signaling information without direct connection to their remote station.

Evaluation		Verdict
Test according to a)	<input checked="" type="checkbox"/>	pass
Assessment of manufacturer declaration	<input type="checkbox"/>	--

a) The tests are done after establishment of a connection to counter part.

	Test case	Reaction of EUT	Verdict
1	Switch – off counterpart	B	Pass
2	Hook-on by counterpart	B	Pass
3	Switch- off by EUT	A	Pass
4	Hook -on on EUT side	B	Pass
5	Remove power from EUT	A	Pass
6	Remove power from counterpart	B	Pass

- A – Connection break down, cease of transmit
- B – Connection break down, EUT transmits signaling information
- C – Connection break down, counter part transmits signaling information

### 3.1.11 Radio frequency radiation exposure

Related Rules and Regulations: FCC 15.319 (i); RSS-102

UPCS devices are subject to the radio frequency radiation exposure requirements specified in FCC parts 1.1307 (b), 2.1091, 2.1093 and RSS-102, as appropriate. All equipment shall be considered to operate in a “general population / uncontrolled environment. For portable devices tests according to IEEE 1528 are requested, if applicable.

Consideration of radio frequency radiation exposure for EUT is done as

SAR test acc. IEEE 1528	<input type="checkbox"/>
MPE calculation as below	<input checked="" type="checkbox"/>

SAR test results: not applicable

MPE calculation:

Please find radiated power test results in Annex.

The EUT is considered as a mobile device according to OET Bulletin 65, Edition – 97 – 01. Therefore distance to human body of min. 20 cm is determined.

The internal / external antennas used for this mobile transmitter must provide a separation distance of at least 20 cm from all persons and must not be co-located or operating in conjunction with any other antenna or transmitter.

A safety statement concerning minimum separation distances from enclosure of the device will be integrated in the user’s manual to provide end-users with transmitter operating conditions for satisfying RFE exposure compliance.

Formula:

$$S = \text{EIRP} / 4\pi R^2$$

Calculation:

EIRP	Radiated Power [dBm]	21.38
EIRP	Radiated Power [mW]	137.404
R	Distance [cm]	20
S	Power Density [mW/cm <sup>2</sup> ]	0.027

Limit:

The limit of Power density for General Population / Uncontrolled Exposure is 1.0 mW/cm<sup>2</sup>. Compliance with the requirements will be considered by calculation of power density derived from radiated power value.

Verdict:

Pass	Fail
<input checked="" type="checkbox"/>	<input type="checkbox"/>

### 3.1.12 Monitoring threshold; Least interfered channel

Related Rules and Regulations: FCC 15.323 (c)(2); (c)(5); (c)(9);RSS–213 4.3.4 (b)(2)

The lower monitoring threshold for EUTs without LIC procedure (least interfered channel) must not be more than 30 dB above the thermal noise power for a bandwidth equivalent to the emission bandwidth of the device.

Devices that have a power output lower than the maximum permitted under the rules can increase their monitoring detection threshold by one decibel for each one decibel that the transmitter power is below the maximum permitted.

For EUTs which support least interfered channel procedure (LIC) there is no need to measure the lower threshold because the rule 15.323(c)(2) is automatically met by the LIC procedure. For EUTs with 40 and more logical channels the upper threshold is applicable.

Monitoring threshold is measured according ANSI 63.17 sub-clause 7.1, 7.2, 7.3 using test set-up No. 2.

This test set-up is used for most tests related to monitoring.

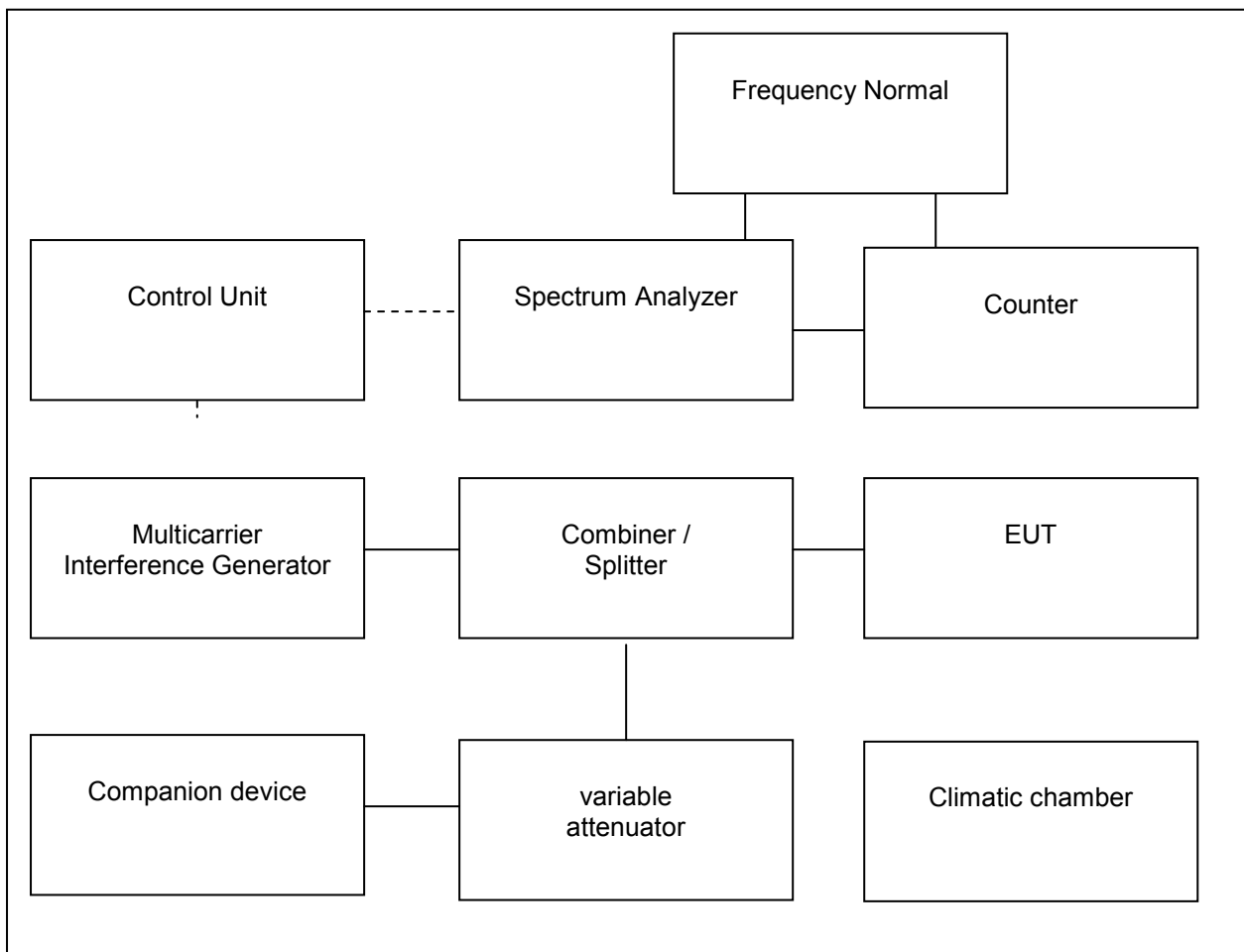

Test set-up 2 General equipment configuration for monitoring tests

Monitoring tests generally determine the lower and upper threshold of the EUT , and verify that if the EUT is operating in the “least-interfered channel” mode, it can properly select the channel with the lowest interference power, within a 6 dB resolution. The “preferred” end of the 1920-1930 MHz band denotes the end at which the search for channels with interference below the lower threshold shall begin. For devices with an emission bandwidth of less than 625 kHz, the search shall begin within 3 MHz , of the lower end of the band (i.e., 1920 MHz). For device with an emission bandwidth of greater than 625 kHz, the search shall begin within 3 MHz of the upper end of the band.

Calculation of monitoring threshold limits for isochronous devices:

Lower threshold:

$$T_L = 15 \log_{10}B - 184 + 30 - P \text{ (dBm)}$$

Upper threshold:

$$T_H = 15 \log_{10}B - 184 + 50 - P \text{ (dBm)}$$

B= emission bandwidth (Hz) }  
 P = transmitted power (dBm) } measured values

calculated thresholds:

lower threshold [dBm]	-78.0
upper threshold [dBm]	-58.0

The upper threshold is applicable for systems which have defined a minimum of 40 duplex system access channels.

Measurement procedure:

For devices without LIC procedure:

For a not or defined interfered band the system will initiate a connection on channel with the lowest level. After that interferer level on this channel will be increased by 1dB steps, until a new connection on an other channel will established. The related interferer level represents the measured lower threshold.

For devices supporting LIC (least interferer channel) procedure:

Except of two channels ( $f_1$ ;  $f_2$ ) all other channels are blocked by interferers at levels of 26 dB above the lower limit. Then interferers apply to  $f_1$  and  $f_2$  with dedicated levels related to calculated lower threshold according to ANSI 63.17 sub-clause 7.3.3, check the behavior and repeat each test case 5 times. If the behavior is correct all times, the test is passed.

Upper threshold (for > 40 channels):

An interferer level of about 16 dB above calculated upper threshold is applicable on all system carriers. The interference level is uniformly decreased on all carriers until the EUT starts to transmit. This level is upper threshold.

Results:

Least interfered channel	pass
Lower threshold [dBm]	n.a.
Upper threshold [dBm]	-61

For measurements diagrams see Annex.

Limits:

Used results	Emission bandwidth [MHz]	1.45
	Peak transmit power [dBm]	18.40
Limits	Lower threshold [dBm] + 6 dB margin	$\leq -78.0 - 72.0$
	Upper threshold [dBm] + 6 dB margin	$\leq -58.0 - 52.0$



### 3.1.13 Monitoring of intended transmit window and maximum reaction time

Related Rules and Regulations: FCC 15.323 (c)(1); RSS-213 4.3.4 (b)(1)

Immediately prior to initiating transmission, devices must monitor the combined time and spectrum window in which they intend to transmit. For a period of at least 10 milliseconds for systems designed to use a 10 millisecond or shorter frame period or at least 20 milliseconds for systems designed to use a 20 millisecond frame period.

Monitoring of intended transmit window is tested according to ANSI 63.7 sub-clause 7.5 using test set-up No. 2.

These tests are related to isochronous reaction time and monitoring interval.

The reaction time is the duration of the RF power, during the monitoring interval, that shall be detected by the device to determine that the monitored time and spectrum window is occupied.

The objective of the test is to demonstrate that the device defers use of a region of spectrum when the interfering signals are of a time duration that exceeds the allowed limit.

If the sample fulfills the requirements of reaction time it shows that it has monitored the intended transmit window.

Test c:

With the channel interferer level at the calculated threshold limit, plus a 6 dB margin verify that the EUT does not establish a connection when the width of the interference pulse exceeds the largest of 50  $\mu$ s and  $50 \sqrt{1.25/B}$   $\mu$ s.

B-Emission bandwidth of EUT in MHz

Test d:

With the channel interferer set to a level that is 6 dB above the calculated threshold limit, plus a 6 dB margin, verify that no connection occurs with a interference pulse width which exceeds the largest of 35  $\mu$ s and  $35 \sqrt{1.25/B}$   $\mu$ s.

Results:

Pulse width	Connection	
	F <sub>L</sub>	F <sub>U</sub>
50 $\mu$ s or $50 \sqrt{1.25/B}$ $\mu$ s	no	no
35 $\mu$ s or $35 \sqrt{1.25/B}$ $\mu$ s	no	no

Verdict:

Pass	Fail
<input checked="" type="checkbox"/>	<input type="checkbox"/>

For measurements diagrams see Annex.

Calculation of applied pulse width and maximum reaction time:

For Emission bandwidth > 1,25 MHz the pulse width is always 35  $\mu$ s and 50  $\mu$ s

Used results	Emission bandwidth [MHz]	e.g. 1.434
Max. reaction time and Pulse width	$50 \sqrt{1.25/B} \mu\text{s}$	46.68
	$35 \sqrt{1.25/B} \mu\text{s}$	32.67

**3.1.14 Monitoring bandwidth, Monitoring reaction time**

Related Rules and Regulations: FCC 15.323 (c)(7); RSS-213, 4.3.4 (b)(7)

Monitoring bandwidth is measured according to ANSI 63.17 sub-clause 7.4.1. using test set-up No. 2.

Test procedure:

Center the interfering signal at a frequency above the center of the emission of the EUT, separated by 30% of the emission bandwidth of the EUT, at a level that is 10 dB +  $U_M$  above the appropriate threshold limit. The bandwidth of the interfering signal shall be equal to or greater than the minimum emission bandwidth allowed for the sub-band. It shall be verified that the EUT does not establish a connection. The procedure is repeated with the interference centered at a frequency below the center of the emission of the EUT, separated by 30% of the emission bandwidth of the EUT, at a level that is 10 dB +  $U_M$  above the appropriate threshold limit. It shall be verified that the EUT does not establish a connection.

Results:

Interferer level [dBm]		-51
Test frequency	Interferer frequency	Connection
F <sub>L</sub>	F <sub>L</sub> - 30 % BW	no
	F <sub>L</sub> + 30 % BW	no
F <sub>U</sub>	F <sub>U</sub> - 30% BW	no
	F <sub>U</sub> + 30 % BW	no

Verdict:

Pass	Fail
<input checked="" type="checkbox"/>	<input type="checkbox"/>

For measurements diagrams see Annex.

### 3.1.15 Random waiting interval

Related Rules and Regulations: FCC 15.323 (c)(6); RSS-213, 4.3.4 (b)(6)

If the selected combined time and spectrum windows are unavailable, the device may either monitor and select different windows or seek to use the same window after waiting an amount of time, randomly chosen from a uniform random distribution between 10 and 150 milliseconds, commencing when the channel becomes available.

Random waiting interval is considered according ANSI 63.17 sub-clause 8.1.3.  
This test applies to an EUT capable of transmitting control and signaling information on its own without companion device.

It is measured the time interval between the end of the EUT transmission and the beginning of transmission by the EUT in the same time and spectrum window..

Test set-up No. 1 is used.

Comment: This test is not applicable for this EUT.

Test procedure: ANSI 63.17 Sub-clause 8.1

**3.1.16 Connection acknowledgements, Unacknowledged transmissions**

Related Rules and Regulations: FCC 15.323(c)(4);RSS-213 4.3.4 (b)(4)

Once access to specific combined time and spectrum windows is obtained an acknowledgement from a system participant must be received by the initiating transmitter within one second or transmission must cease. Periodic acknowledgements must be received at least every 30 seconds or transmission must cease. Channels used exclusively for control and signaling information may transmit continuously for 30 seconds without receiving an acknowledgement, at which time the access criteria must be repeated.

Connection acknowledgements are tested according to ANSI 63.17 sub-clause 8.2.1, Unacknowledged transmission following sub clause 8.1.1. Access criteria test interval and 8.1.2 Access criteria functional test. subclause 8.1.3 Access criteria functional test is not applicable because option FCC 15.323 (c)(6) /RSS-213 4.3.4 (b)(6) is not implemented.

Unacknowledged transmission:

Results:

Requirement	Time	Verdict
Access criteria test interval (8.1.1)	1.25ms	Pass
Access criteria functional test (8.1.2)	840 µs	Pass

Limits:

Requirement	Value
Access criteria test interval (8.1.1)	≤ 30 s
Access criteria functional test (8.1.2)	mandatory

Connection acknowledgement

Results: For measurements diagrams see Annex.

Requirement	Time	Verdict
Connection acknowledgement [8.2.1 (a)(b)] PP only	--	n.a.
Termination of transmission [8.2.1 (c)]	5.3s	pass

Limits:

Requirement	Value
Connection acknowledgement [8.2.1 (a)(b)] PP only	≤ 1 s
Termination of transmission [8.2.1 (c)]	≤ 30 s

**3.1.17 Selected channel confirmation, segment occupancy**

Related Rules and Regulations: FCC 15.323 (c)(5); RSS–213 4.3.4 (b)(5)

If a minimum of 40 duplex system access channels are defined, the system must have monitored all access channels defined for its system within the last 10 seconds and must verify, within the 20 milliseconds (40 milliseconds for devices designed to use a 20 milliseconds frame period) immediately preceding actual channel access that the detected power of the selected time and spectrum windows is no higher than the previously detected value.

The power measurement resolution for this comparison must be accurate within 6 dB.

No device or group of co-operating devices located within 1 meter of each other shall during any frame period occupy more than 6 MHz of aggregate bandwidth, or alternatively, more than one third of the time and spectrum windows defined by the system.

**Selected channel confirmation:**

This test is done according to ANSI 63.17 sub-clause 7.3.4 using test set-up No. 2.

Results:

Test	Transmit on f <sub>1</sub>	Transmit on f <sub>2</sub>	Verdict
c	yes	no	pass

**Power accuracy**

The power measurement resolution for the previous comparisons must be accurate to within 6 dB.

This requirement was proved automatically by testing of monitoring thresholds according to FCC 15.323 (c)(2); RSS-213 4.3.4 (b)(2), see 2.4.12.

**Segment occupancy**

Document	available	sufficient
Manufacturers declaration	<input checked="" type="checkbox"/>	<input checked="" type="checkbox"/>
Technical description	<input type="checkbox"/>	<input type="checkbox"/>

For measurements diagrams see Annex.

**3.1.18 Monitoring antenna**

Related Rules and Regulations: FCC 15.323 (c)(8); RSS-213 4.3.4 (b)(8)

The monitoring system shall use the same antenna used for transmission, or an antenna that yields equivalent reception at that location.

The monitoring system shall use the same antenna used for transmission or an antenna that yields equivalent reception at that location.

System uses same antenna(s)	<input checked="" type="checkbox"/>
System uses different antenna(s)	<input type="checkbox"/>

If the monitoring antenna is different from the transmitting antenna, it shall be verified that the monitoring antenna provides coverage equivalent to that of the transmitting antenna.

The related tests are to perform according to ANSI 63.17 sub-clause 4.5 using test set-up No. 3.

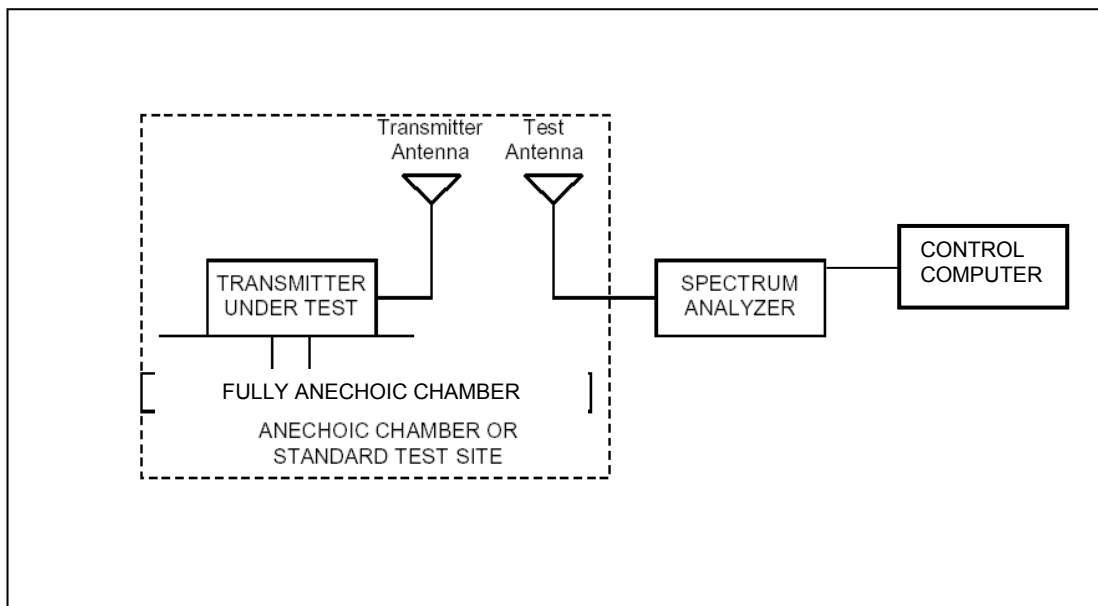

Test set-up 3 Equipment configuration for radiated tests

### 3.1.19 Alternative monitoring interval for co-located devices

Related Rules and Regulations: FCC 15.323 (c)(11);RSS–213 4.3.4 (b)(11)

An initiating device that is prevented from monitoring during its intended transmit window due to monitoring system blocking from the transmissions of a co-located (within one meter) transmitter of the same system, may monitor the portions of the time and spectrum windows in which they intend to receive over a period of at least 10 milliseconds. The monitored time and spectrum window must total at least 50 percent of the 10 millisecond frame interval and the monitored spectrum must be within 1.25 MHz of the center frequency of channel(s) already occupied by that device or co-located co-operating device. If the access criteria is met for the intended receive time and spectrum window under the above conditions, then transmission in the intended transmit window by the initiating device may commence.

Alternative monitoring interval for co-located devices may be tested according to ANSI 63.17 sub-clause 8.4 using test set-up No. 2.

Results.

The manufacturer declares that this provision is not utilized by the EUT.

### 3.1.20 Fair access to spectrum

Related Rules and Regulations: FCC 15.323 (c)(10) and (c)(11), FCC 15.323 (c)(12); RSS–213 4.3.4 (b)(12)

The provisions of FCC 15.323 (c)(10) or (c)(11) and RSS–213 4.3.4 (b)(10) or (11) shall not be used to extend the range of spectrum occupied over space or time for the purpose of denying fair access to spectrum for other devices.

The manufacturer declares that is device does not work in a mode which denies fair access to spectrum for other participants.



**3.1.21 Radiated spurious emissions, generally requirements**
**Reference**

<b>FCC</b>	CFR part 15.247(d), 15.205. 15.209, 15.35
<b>IC</b>	RSS-210 A8.5, RSS-210 2.7

**Method of measurement**

Spurious emission was measured with modulation (declared by manufacturer).

According to 47 CFR 15, Part 15.247 (d): In any 100 kHz bandwidth outside the frequency band in which the spread spectrum or digitally modulated intentional radiator is operating, the radio frequency power that is produced by the intentional radiator shall be at least 20 dB below that in the 100 kHz bandwidth within the band that contains the highest level of the desired power, based on either an RF conducted or a radiated measurement, provided the transmitter demonstrates compliance with the peak conducted power limits. If the transmitter complies with the conducted power limits based on the use of RMS averaging over a time interval, as permitted under paragraph (b)(3) of this section, the attenuation required under this paragraph shall be 30 dB instead of 20 dB. Attenuation below the general limits specified in Section 15.209(a) is not required.

In addition, radiated emissions which fall in the restricted bands, as defined in Section 15.205(a), must also comply with the radiated emission limits specified in Section 15.209(a) (see Section 15.205(c)).

**Calculation of Limit:**

All results are updated by an automatic measuring system in accordance to point 2.3

Limit = max. reading (because peak detector is used)

Limit = Max. reading - 20 dB (because average detector is used)

**Limits for restricted bands**

<b>FCC &amp; IC</b>	20 dB below peak output power, emissions which fall in the restricted bands (15.205(a)) / (RSS-210 2.7) must comply the following limits: Frequencies below 1GHz:		
	Frequency of emission	Field strength	Field strength
	[MHz]	[µV / m]	[dBµV / m]
	30 - 88	100	40.0
	88 - 216	150	43.5
	216 - 960	200	46.0
	Above 960	500	54.0
For frequencies above 1 GHz (Avg measurements): 54.0 dBµV / m For frequencies above 1 GHz (Pk measurements): Limit + 20 dB = 54.0 dBµV / m + 20 dB = 74 dBµV / m			

Calculation of test results:

Such factors like antenna correction, cable loss, external attenuation etc. are already included in the provided measurement results.

The peak and average spurious emission plots was measured with the average limits. In the Table being listed the critical peak and average value an exhibit the compliance with the above calculated Limits.

If in the column's correction factor states a value then the max. Field strength in the same row is corrected by a value gained from the "Marker-Delta-Method" or the „Duty-Cycle Correction Factor“.

#### 15.35 (c) Duty cycle correction average value

When the radiated emission limits are expressed in terms of the average value of the emission, and pulsed operation is employed, the measurement field strength shall be determined by averaging over one complete pulse train, including blanking intervals, as long as the pulse train does not exceed 0.1 seconds.

Duty cycle correction =  $20 \log(\text{dwell time} / 100 \text{ ms or less})$

#### DA 00-705 Duty cycle correction peak value

The analyzer setting was as following:

Frequency range	RES bandwidth		Video bandwidth	
	Pk	Avg	Pk	Avg
f < 1GHz	100 kHz	100 kHz	10 Hz	10 Hz
f > 1GHz	1 MHz	1 MHz	10 Hz	10 Hz

Set the VBW to 10 Hz, while maintaining all of the other instrument settings. This peak level, once corrected, must comply with the limit specified in Section 15.209. If the dwell time per channel of the hopping signal is less than 100 ms, then the reading obtained with the 10 Hz VBW may be further adjusted by a "duty cycle correction factor", derived from  $20 \log(\text{dwell time} / 100 \text{ ms})$ , in an effort to demonstrate compliance with the 15.209 limit. Submit this data.

If the intentional radiator operates below 10 GHz: to the tenth harmonic of the highest fundamental frequency or to 40 GHz, whichever is lower.

**Test results**
**Summary table with radiated data of the test plots**

Freq.	Used Ch.	Frequency Marker [MHz]	Polarization	$\Delta$ corrections dB	Max. Power level [dB $\mu$ V/m]	Compliance Limit [dB $\mu$ V/m]	Detector	BW [kHz]	Margin [dB $\mu$ V/m]
1921	4	3844	v		61.01	74	P	1	-12.99
	4	3843	v		45.44	54	AV	1	-8.56
	4	7687	h		60.73	74	P	1	-13.27
	4	7687	h		42.35	54	AV	1	-11.65
1928	0	3862	v		57.71	74	P	1	-16.29
	0	3857	v		44.63	54	AV	1	-9.37
	0	7719	h		56.59	74	P	1	-17.41
	0	7713	h		41.01	54	AV	1	-12.99
	0	7719	v		60.89	74	P	1	-13.11
	0	7713	v		42.36	54	AV	1	-11.64

**Freq. - Frequency Range:**

1:	30	–	200 MHz
2:	200	–	1000 MHz
3:	1	–	4 GHz
4:	4	–	8 GHz
5:	8	–	12 GHz
6:	12	–	17 GHz
7:	17	–	26,5 GHz

Comment: For measurements diagrams see Annex.

**3.1.22 Emissions inside and outside the sub-bands**

Related Rules and Regulations: FCC 15.323 (d); RSS–213 6.7

Emissions outside the sub-bands shall be attenuated below a reference power of 112 milliwatts as follows: 30 dB between the sub-band and 1.25 MHz above or below the sub-band, (-9.5 dBm); 50 dB between 1.25 and 2.5 MHz above or below the sub-band, (-29,5 dBm); and 60 dB at 2.5 MHz or greater above or below the sub-band, (-39.5 dBm)

Emissions inside the sub-band must comply with the following emission mask: In the bands between 1B and 2B (“B” is defined as the emission bandwidth of the device in hertz) measured from the center of the emission bandwidth the total power emitted by the device shall be at least 50 dB below the transmit power permitted for that radiator; in the bands between 3B and the sub-band edge the total power emitted by an intentional radiator in the measurement bandwidth shall be at least 60 dB below the transmit power permitted for that radiator.

Compliance with the emission limits is based on the use of measurement instrumentation employing peak detector function with an instrument resolution bandwidth approximately equal to 1.0 percent of the emission bandwidth of the device under measurement.

Emission inside and outside the sub-band are tested according to ANSI 63.17 sub-clauses 6.1.6.1 and 6.1.6.2.

Determination of measurement bandwidth:

$$BT_T = \text{approx. } 1\% \text{ of } B$$

Used results	Emission bandwidth [MHz]	1.45
Calculated value	Resolution bandwidth [kHz]	14.50
Determined value	Resolution bandwidth [kHz]	10

**Emissions inside the sub-band**

Testing of emissions inside the sub-band are performed using test set-up No.1. The applied emission mask limit was created using the current emission bandwidth.

For measurements diagrams see Annex.

**Emissions outside the sub-band**

Out of sub band emissions are tested as radiated measurement bandwidth of about 1% of emission bandwidth near the band edges and at critical frequencies where the measurement values come near the limits. For practical reasons other frequencies the more stringent bandwidth of 100 kHz is used.

As test environment serves a fully anechoic chamber providing a free space environment (test set-up No. 3)

All results will be updated by an automatic measuring system in accordance with point 2.3.

Calculation of test results:

Such factors like antenna correction, cable loss, external attenuation etc. are already included in the provided measurement results. This is done by using validated test software and calibrated test system according the accreditation requirements.

The significant peak and average values are listed in the tables below showing the compliance with the above calculated limits. For frequency ranges with measurement value far below the limits no measurement diagrams are shown.

**Summary table with radiated data of the test plots**

Freq.	Used Ch.	Frequency Marker [GHz]	Polarization	$\Delta$ corrections dB	Max. Power level [dBm]	Compliance Limit [dBm]	Detector	BW [kHz]	Margin [dB]
--	--	--	--	--	--	--	--	--	--
--	--	--	--	--	--	--	--	--	--

Freq. – Frequency Range:

- 1: 30 – 200 MHz
- 2: 200 – 1000 MHz
- 3: 1 – 4 GHz
- 4: 4 – 8 GHz
- 5: 8 – 12 GHz
- 6: 12 – 17 GHz
- 7: 17 – 26.5 GHz

For measurements diagrams see Annex.

Limits:

For spectrum mask and limit lines see diagrams.

Verdict:

Pass	Fail
<input checked="" type="checkbox"/>	<input type="checkbox"/>

### 3.1.23 Frame period

Related Rules and Regulations: FCC 15.323 (e); RSS-213 4.3.4 (c)

The frame period (a set of consecutive time slots in which the position of each time slot can be identified by reference to a synchronizing source) of an intentional radiator operating in these subbands shall be 20 milliseconds/X where x is a positive whole number. Each device that implements time division for the purposes of maintaining a duplex connection on a given frequency carrier shall maintain a frame repetition rate with a frequency stability of at least 50 parts per millions (ppm). Each devices which further divides access in time in order to support multiple communication links on a given frequency carrier shall maintain a frame repetition rate with a frequency stability of at least 10 ppm. The jitter (time-related, abrupt, spurious variations in the duration of the frame interval) introduced at the two ends of such a communication link shall not exceed 25 microseconds for any two consecutive transmissions.

Transmissions shall be continuous in every time and spectrum window during the frame period defined for the device.

Frame repetition stability is tested according to ANSI 63.17 sub-clause 6.2.2. Frame period and jitter are tested following sub-clause 6.2.3. For all measurements test set-up No.1 is used.

#### Frame repetition stability:

The spectrum analyzer is used as an envelope detector and provides gating signals to a frequency counter. The obtained frequency values are computed to get mean value, deviation and frame repetition stability. Frame repetition stability is three times of the standard deviation SD.

Results:

Frequency (MHz)	Standard Deviation (Hz)	Mean(Hz)	3 x SD (ppm)
1924.991	1.7E-06	99.999940	0.499944

Limits:

Time division mode	Frame repetition stability	applicable
TDA	50 ppm	<input type="checkbox"/>
TDMA	10 ppm	<input checked="" type="checkbox"/>

Verdict:

Pass	Fail
<input checked="" type="checkbox"/>	<input type="checkbox"/>

**Frame period and jitter:**

Frame period and jitter test the spectrum and modulation is used to obtain the time duration between rising edges. These measurement value are used to compute the difference between any two consecutive frame periods (jitter).

The measured mean time is the frame period.

Results:

Frequency (MHz)	Mean (ms)	Deviation (Hz)	Peak to Peak (µs)
1924.992	9.999851	4.0E-06	0,052154

Limits:

Frame period [ms]	20 or 10/x
Max. jitter [µs]	25
3 times the standard deviation SD [µs] value of jitter <sup>2)</sup>	12.5

<sup>2)</sup> This item is not required by FCC 15.323(e).

Verdict:

Pass	Fail
<input checked="" type="checkbox"/>	<input type="checkbox"/>

**3.1.24 Frequency stability**

Related Rules and Regulations: FCC 15.323 (f); RSS – 213 6.2

The frequency stability of the carrier frequency of the intentional radiator shall be maintained within  $\pm 10$  ppm over 1 hour or the interval between channel access monitoring, whichever is shorter. The frequency stability shall be maintained over a temperature variation of  $-20^{\circ}$  to  $+50^{\circ}$  degrees C at normal supply voltage, and over a variation in the primary supply voltage of 85 percent to 115 percent of the rated supply voltage at a temperature of  $20^{\circ}$ C. For equipment that is capable only of operating from a battery, the frequency stability tests shall be performed using a new battery without any further requirements to vary supply voltage.

Frequency stability is measured by spectrum analyzer in modulation mode according to ANSI 63.17 sub-clause 6.2.1.

The procedure is carried out with conditions shown in result table below, where the first row shows the carrier frequency stability over time.

Results:

Temp °C	Supply Voltage	Frequency of carrier (MHz)	Stability over time (ppm)		Mean (MHz)	Deviation ppm
			f <sub>max</sub>	f <sub>min</sub>		
20	Vnom	1924.991594	0.71	0.77	1924.991594	Reference
20	Vmin	1924.991594	0.71	0.55	1924.990611	0.28
20	Vmax	1924.991594	0.60	0.62	1924.990572	0.30
0	Vnom	1924.991594	0.71	0.77	1925.001017	4.89
50	Vnom	1924.991594	0.85	0.71	1924.986774	-2.50

Limit : 10 ppm

$$Deviation\ ppm = \frac{FR - FM}{FR} * 10^6$$

FR = Reference frequency of carrier at  $20^{\circ}$ C and  $V_{nom}$

FM = Measured frequency of carrier

Limit:

Temperature [°C]	Supply voltage	Frequency deviation [ppm]
20	85-115% or new batteries	Reference
-20	Normal	10
+50	Normal	10
Others <sup>1)</sup> -20	Normal	10
Others <sup>1)</sup> +65	Normal	10

<sup>1)</sup> declared by manufacturer

Verdict:

Pass	Fail
<input checked="" type="checkbox"/>	<input type="checkbox"/>



**3.1.25 Receiver spurious emissions, RSS-213 6.8**

Receiver spurious emissions shall comply with the limits specified in RSS-Gen.  
 For radiated measurements the resolution bandwidth of the spectrum analyzer shall be 100 kHz for spurious emissions below 1 GHz and 1 MHz above 1 GHz. For emissions below 1 GHz a CISPR quasi peak demodulator is used. Above 1 GHz an average detector is used.  
 The receiver operating frequency shall be putted to the middle of the band for this test.

Results:

Device Frequency	Frequency marker indication [MHz]	Antenna polarization	Worst case emission level [ $\mu\text{V/m}$ ]	Compliance limit [ $\mu\text{V/m}$ ]	Results [ $\mu\text{V/m}$ ]
RX	197.956	v	42.51	150	-107.49
	197.615	h	41.50	150	-108.50
	996.794	v	36.35	500	-463.65
	996.794	h	61.66	500	-438.34
	3988.000	v	118.71	500	-381.29
	3856.000	h	108.89	500	-391.11
	7727.000	v	127.94	500	-372.06
	7827.000	h	124.45	500	-375.55

Freq. – Frequency Range:

- 1: 30 – 200 MHz
- 2: 200 – 1000 MHz
- 3: 1 – 4 GHz
- 4: 4 – 8 GHz

For results see diagrams in Annex.  
 Limit:

Spurious Frequency (MHz)	Field Strength (microvolt/m at 3 metres)	dB $\mu\text{V/m}$
30 – 88	100	40
88 – 216	150	43.5
216 – 960	200	46
Above 960	500	54

Verdict:

Pass	Fail
<input checked="" type="checkbox"/>	<input type="checkbox"/>

## Annex A Photos

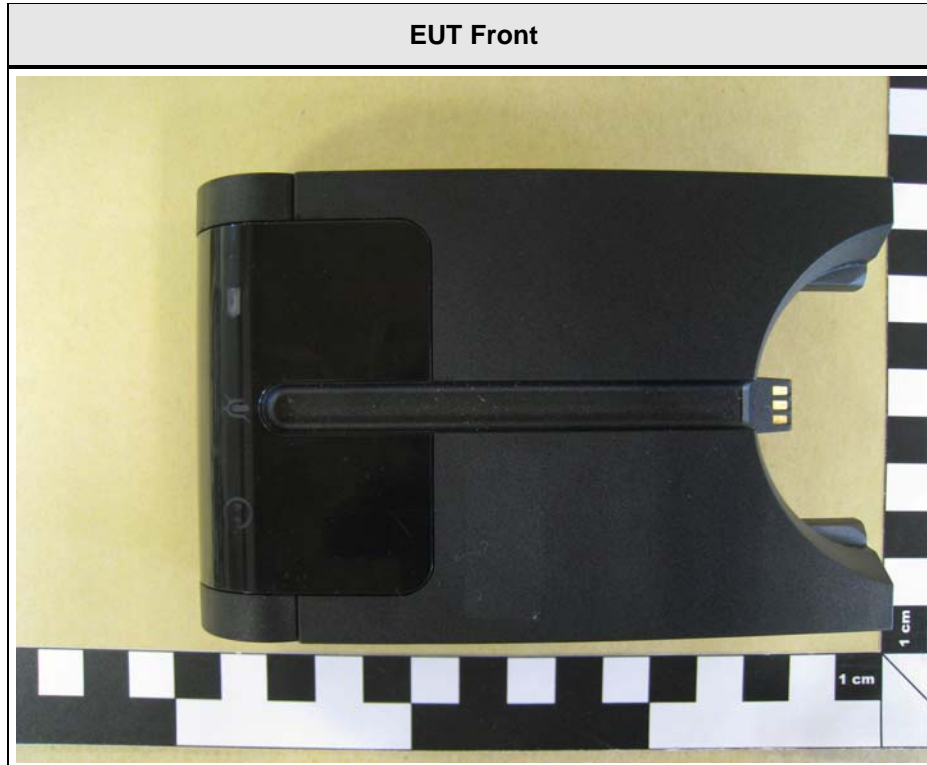

PCB Front

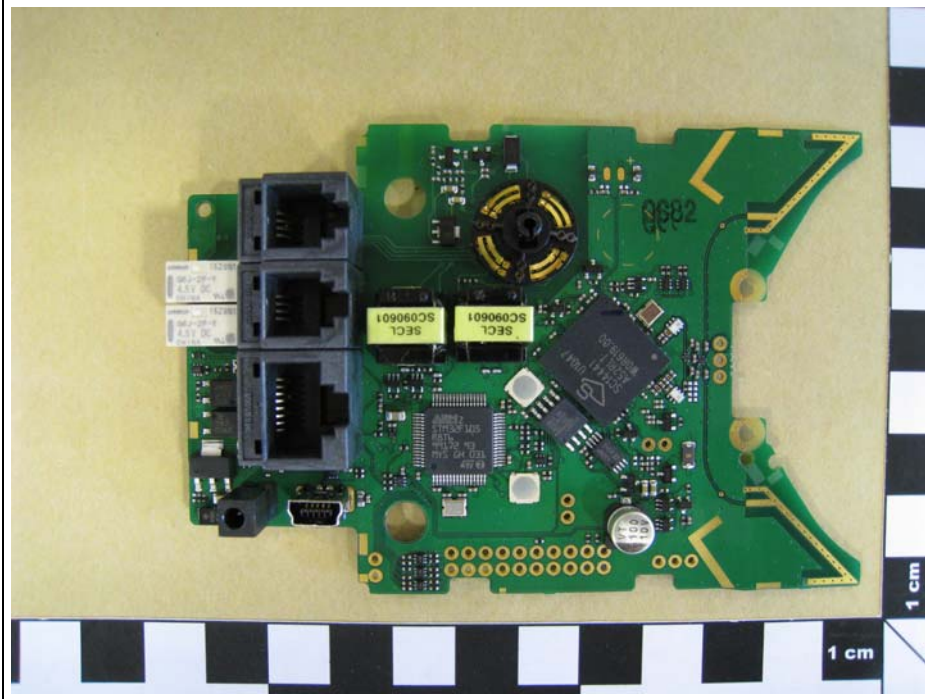

PCB Back

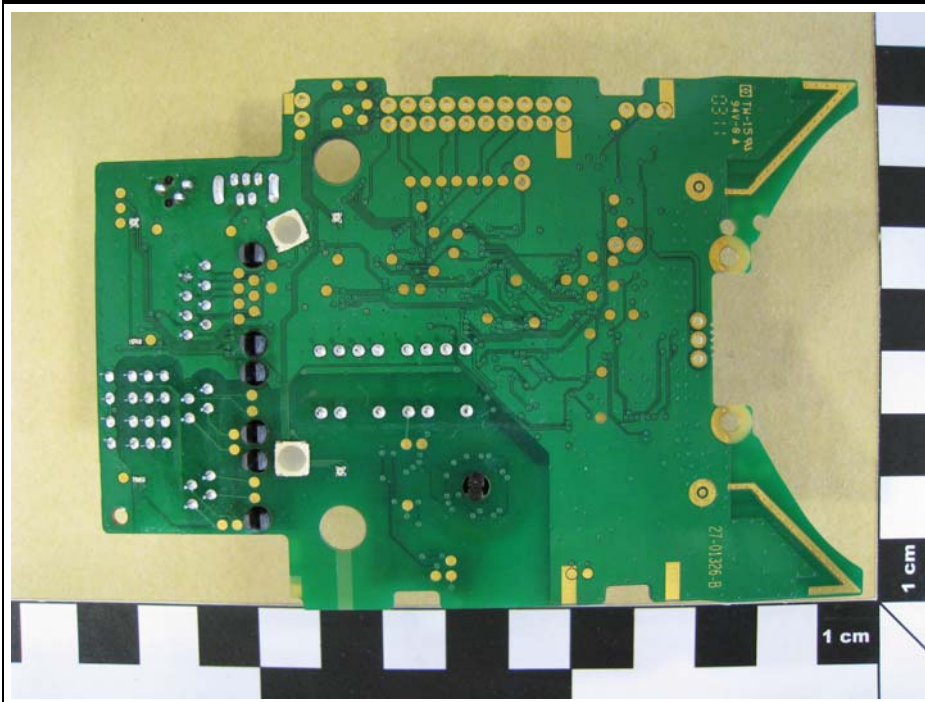

**Test Setup radiated measurements**

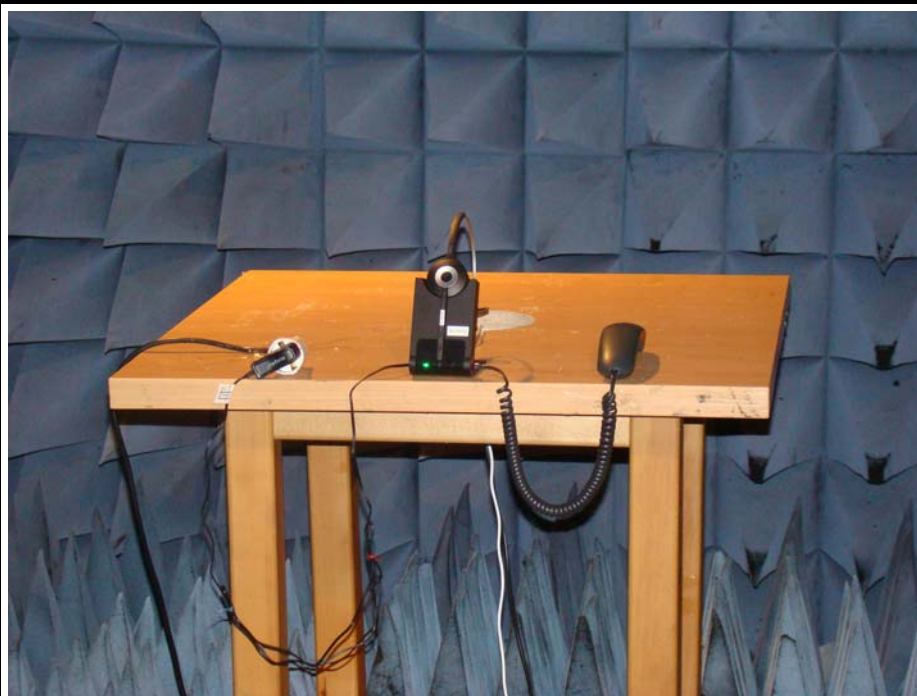

**Test Setup conducted measurements**



## Annex A Conducted limits AC Power line

### EMI voltage test in the ac-mains according to EN 301 489-1

Order number: G0M-1104-1092

Manufacturer: GN Netcom A/S  
 EUT Name: DECT Basestation  
 Model: PRO 9xx; WHB003BS  
 Test Site: Eurofins Product Service GmbH  
 Operator: Mr. Handrik  
 Test Conditions: Tnom: 22°C, Unom: 230 V AC (AC/DC adaptor)  
 LISN: ESH2-Z5 N  
 Mode: charging  
 Test Date: 26.05.2011

Index 1

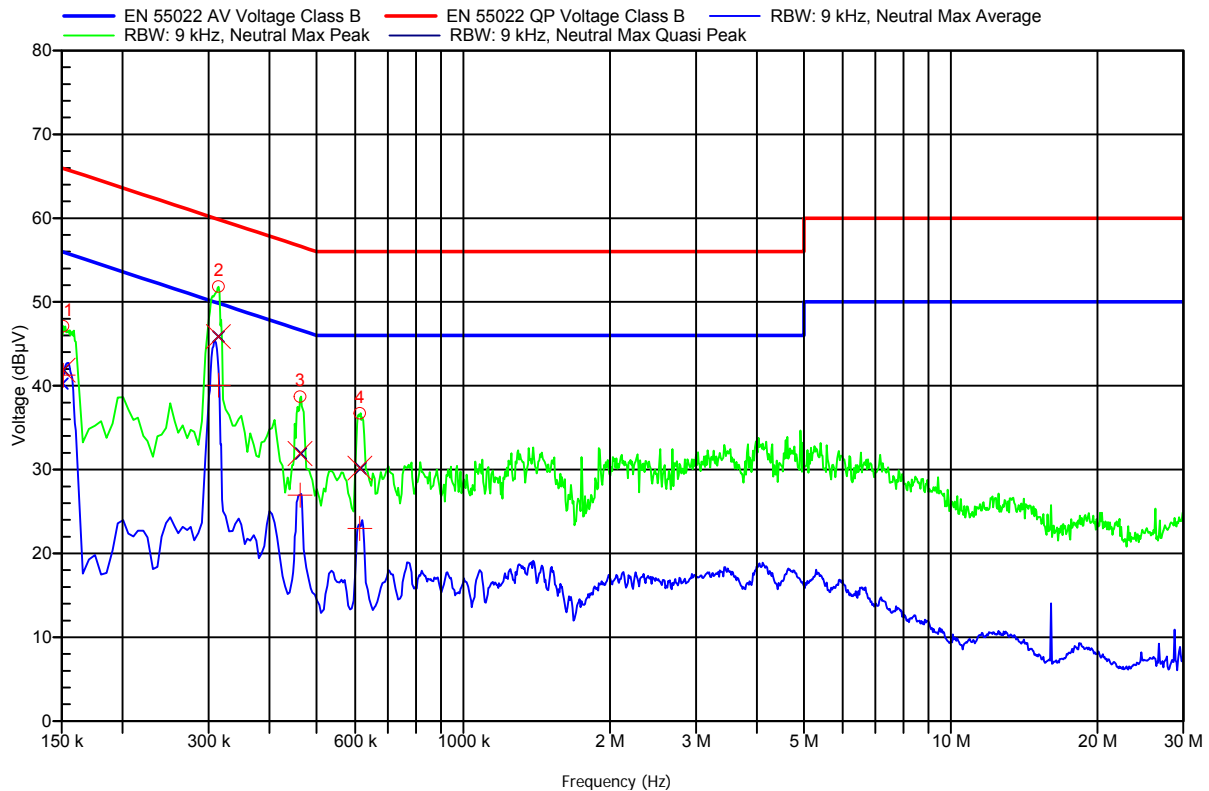

Frequency	Quasi-Peak	Quasi-Peak Limit	Quasi-Peak Difference	Status
151 kHz	41,87 dBµV	65,94 dBµV	-24,07 dB	Pass
314,5 kHz	45,88 dBµV	59,85 dBµV	-13,97 dB	Pass
462,5 kHz	31,92 dBµV	56,65 dBµV	-24,73 dB	Pass
613 kHz	30,17 dBµV	56 dBµV	-25,83 dB	Pass

Frequency	Average	Average Limit	Average Difference	Status
151 kHz	41,25 dBµV	55,94 dBµV	-14,69 dB	Pass
314,5 kHz	40,06 dBµV	49,85 dBµV	-9,79 dB	Pass
462,5 kHz	26,95 dBµV	46,65 dBµV	-19,7 dB	Pass
613 kHz	22,97 dBµV	46 dBµV	-23,03 dB	Pass



**EMI voltage test in the ac-mains according to EN 301 489-1**

Order number: G0M-1104-1092

Manufacturer: GN Netcom A/S  
 EUT Name: DECT Basestation  
 Model: PRO 9xx; WHB003BS  
 Test Site: Eurofins Product Service GmbH  
 Operator: Mr. Handrik  
 Test Conditions: Tnom: 22°C, Unom: 230 V AC (AC/DC adaptor)  
 LISN: ESH2-Z5 L  
 Mode: charging  
 Test Date: 26.05.2011

Index 2

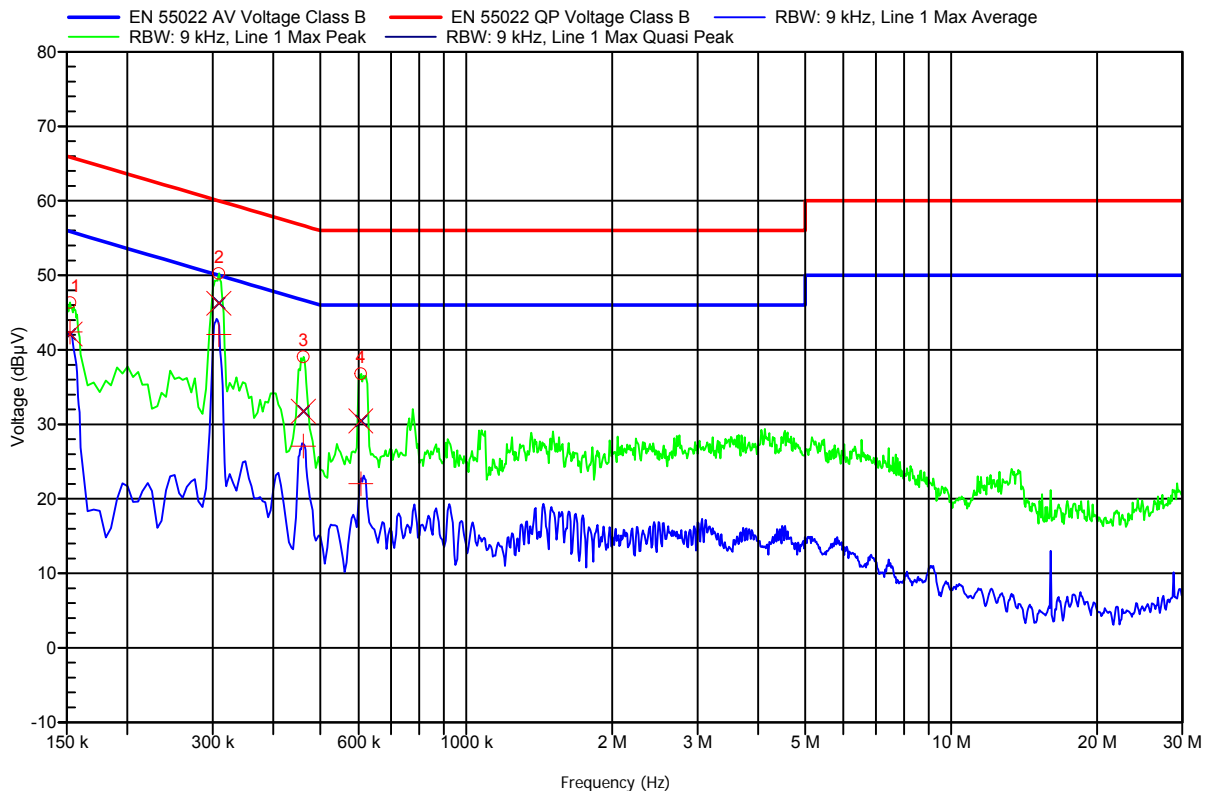

Frequency	Quasi-Peak	Quasi-Peak Limit	Quasi-Peak Difference	Status
152,5 kHz	42,11 dBµV	65,86 dBµV	-23,75 dB	Pass
309 kHz	46,26 dBµV	60 dBµV	-13,73 dB	Pass
461,5 kHz	31,75 dBµV	56,67 dBµV	-24,92 dB	Pass
606,5 kHz	30,46 dBµV	56 dBµV	-25,54 dB	Pass

Frequency	Average	Average Limit	Average Difference	Status
152,5 kHz	42,39 dBµV	55,86 dBµV	-13,47 dB	Pass
309 kHz	42,05 dBµV	50 dBµV	-7,94 dB	Pass
461,5 kHz	27,08 dBµV	46,67 dBµV	-19,59 dB	Pass
606,5 kHz	22,03 dBµV	46 dBµV	-23,97 dB	Pass

## Annex B Emission bandwidth

### FCC Part 15.303 Emission bandwidth

#### Testprocedure ANSI 63.17 UPCS

EUT	DECT base station
Model	Jabra PRO 9x0
Applicant	GN Netcom A/S
Temperature	23°C
Test Site / Operator	Eurofins Product Service GmbH
Test Specification	Emission bandwidth

Measured Bandwidth Emission Bandwidth = 1.45MHz  
 Max. Permitted Power Limit = 2.5 MHz

Test result Verdict = PASS



CENTER FREQUENCY		*RBW 10 kHz	Delta 2 [T1 ]
1.92672 GHz		*VBW 30 kHz	-0.06 dB
Ref 25 dBm	*Att 40 dB	SWT 40 ms	1.44800000 MHz

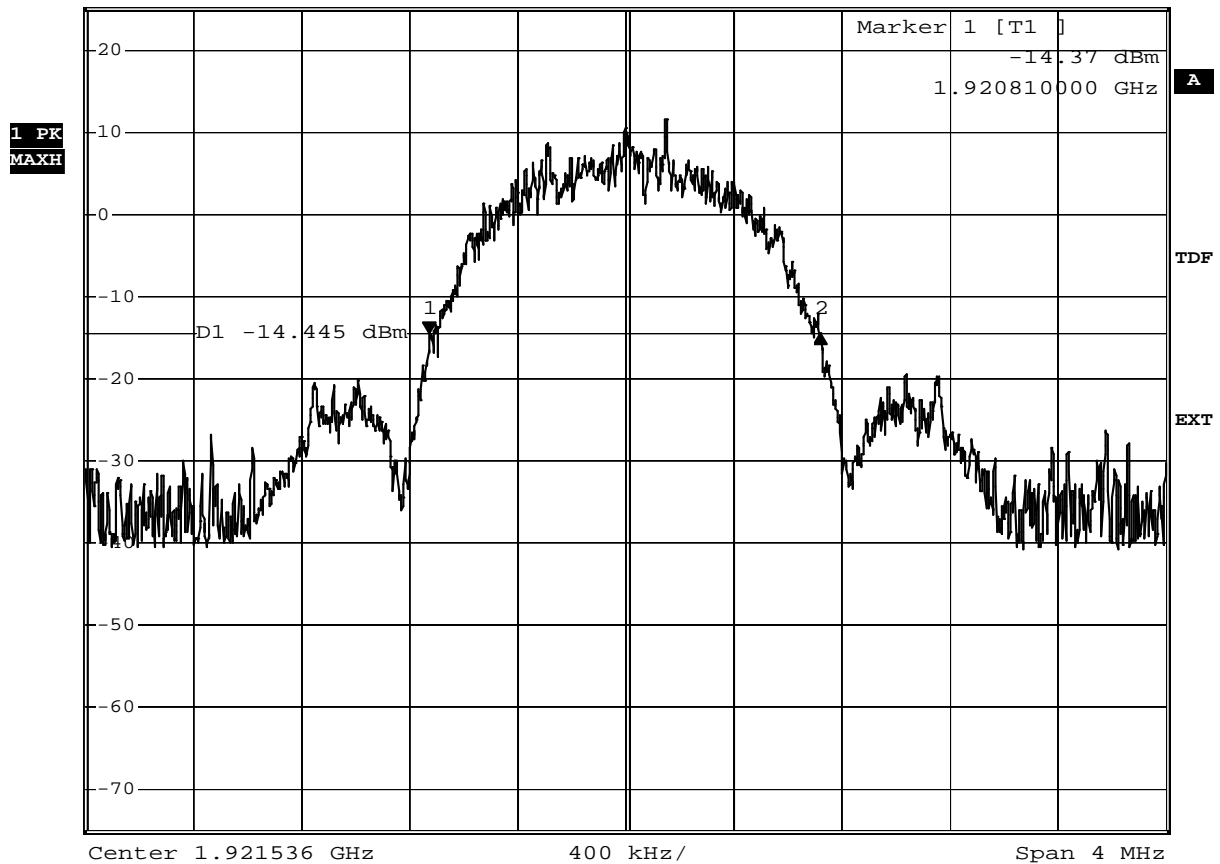

Comment: Ansi C63.17-2006 6.1.3  
 Date: 9.MAY.2011 13:15:09

**Additional values as required for the detailed threshold monitoring bandwidth test  
ANSI C63.17-1988 7.4.2****-6 dB points**

Lower frequency : 1921.192MHz  
Higher frequency : 1921.842MHz

**-12 dB points**

Lower frequency : 1921.012MHz  
Higher frequency : 1922.05MHz



## FCC Part 15.303 Emission bandwidth

### Testprocedure ANSI 63.17 UPCS

EUT                    DECT base station  
 Model                WHB003BS  
 Applicant            GN Netcom A/S  
 Temperature        23°C  
 Test Site / Operator Eurofins Product Service GmbH  
 Test Specification   Emission bandwidth

Measured Bandwidth   Emission Bandwidth = 1.45MHz  
 Max. Permitted Power   Limit = 2.5 MHz

Test result            Verdict = PASS



Emission Bandwidth

\*RBW 10 kHz    Delta 2 [T1 ]

\*VBW 30 kHz                    -0.99 dB

Ref 25 dBm

\*Att 40 dB

SWT 40 ms

1.450000000 MHz

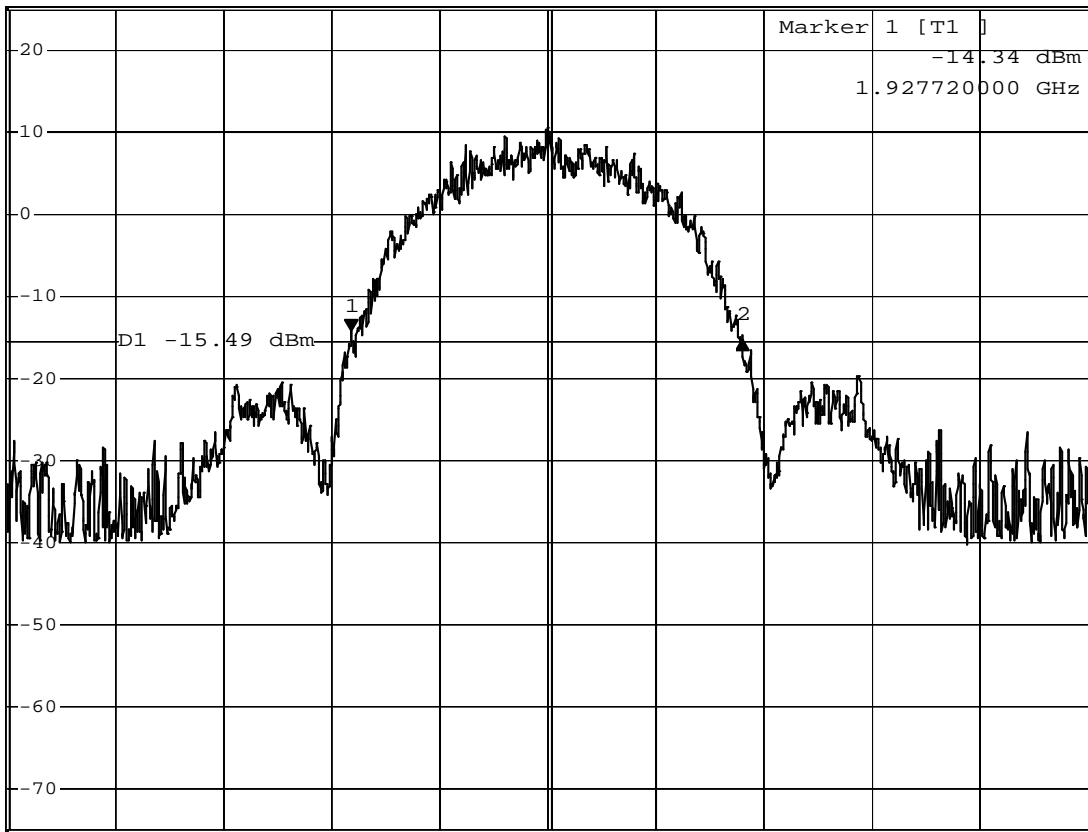

Center 1.928448 GHz                    400 kHz/                    Span 4 MHz

Comment: Ansi C63.17-2006 6.1.3

Date:            9.MAY.2011    13:35:09

**Additional values as required for the detailed threshold monitoring bandwidth test  
ANSI C63.17-1988 7.4.2****-6 dB points**

Lower frequency : 1928.09MHz  
Higher frequency : 1928.792MHz

**-12 dB points**

Lower frequency : 1927.924MHz  
Higher frequency : 1928.994MHz

# Annex C Occupied Bandwidth

## RSS Gen Occupied Bandwidth

EUT	DECT Basstation
Model	WHB003BS
Approval Holder	GN Netcom A/S
Temperature / Voltage	23°C / Vnom
Test Site / Operator	Eurofins Product Service GmbH / Mr. W. Treffke
Test Specification	Occupied Bandwidth
Comment 1	Channel.: 4
Comment 2	A spectrum analyzer with an integrated 99% power BW function is used
Comment 3	OBW: 1.18 MHz



\*RBW 30 kHz    Marker 1 [T1 ]  
 \*VBW 100 kHz                      14.10 dBm  
 Ref 25 dBm                      \*Att 40 dB                      SWT 5 ms                      1.921512000 GHz

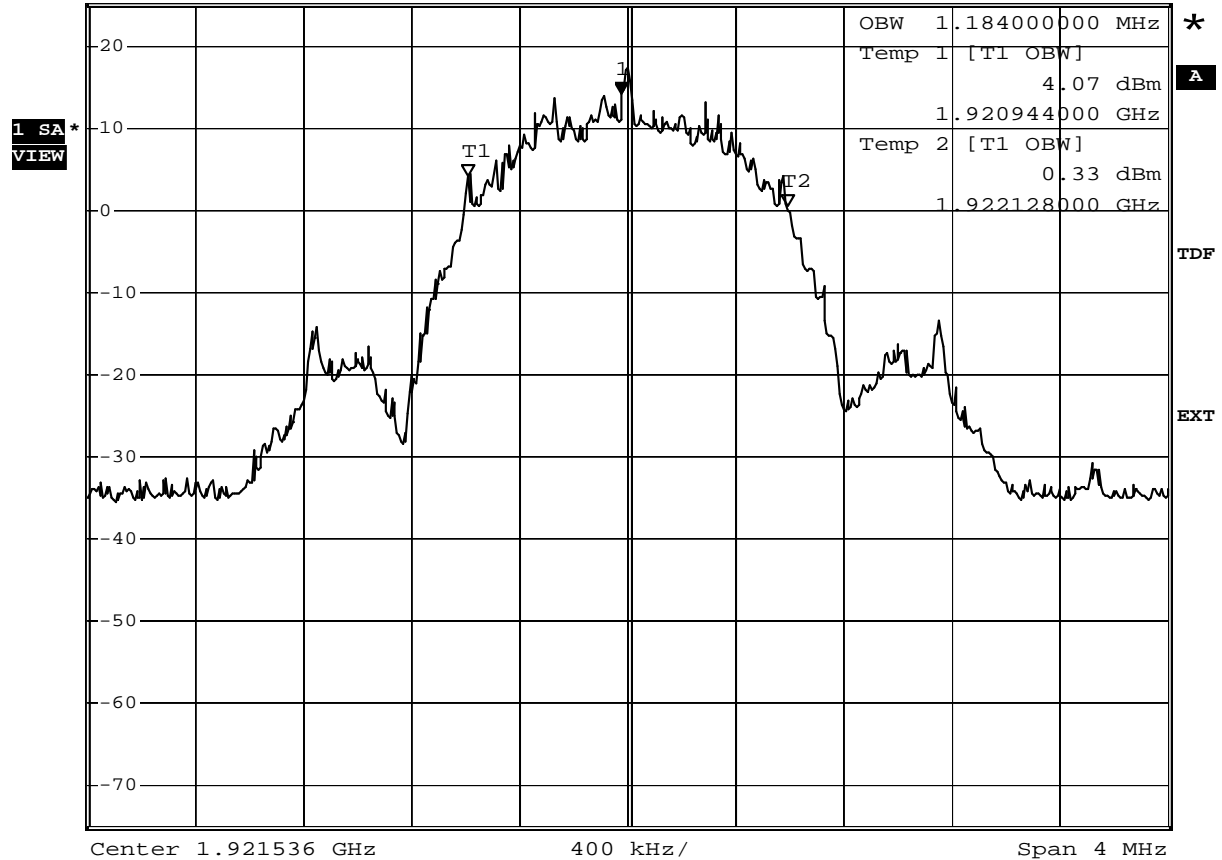

Comment: Ansi C63.17-1998 6.1.6.2  
 Date: 9.MAY.2011 13:57:14

**RSS Gen  
Occupied Bandwidth**

EUT	DECT Basstation
Model	WHB003BS
Approval Holder	GN Netcom A/S
Temperature / Voltage	23°C / Vnom
Test Site / Operator	Eurofins Product Service GmbH / Mr. W. Treffke
Test Specification	Occupied Bandwidth
Comment 1	Channel.: 2
Comment 2	A spectrum analyzer with an integrated 99% power BW function is used
Comment 3	OBW: 1.18 MHz

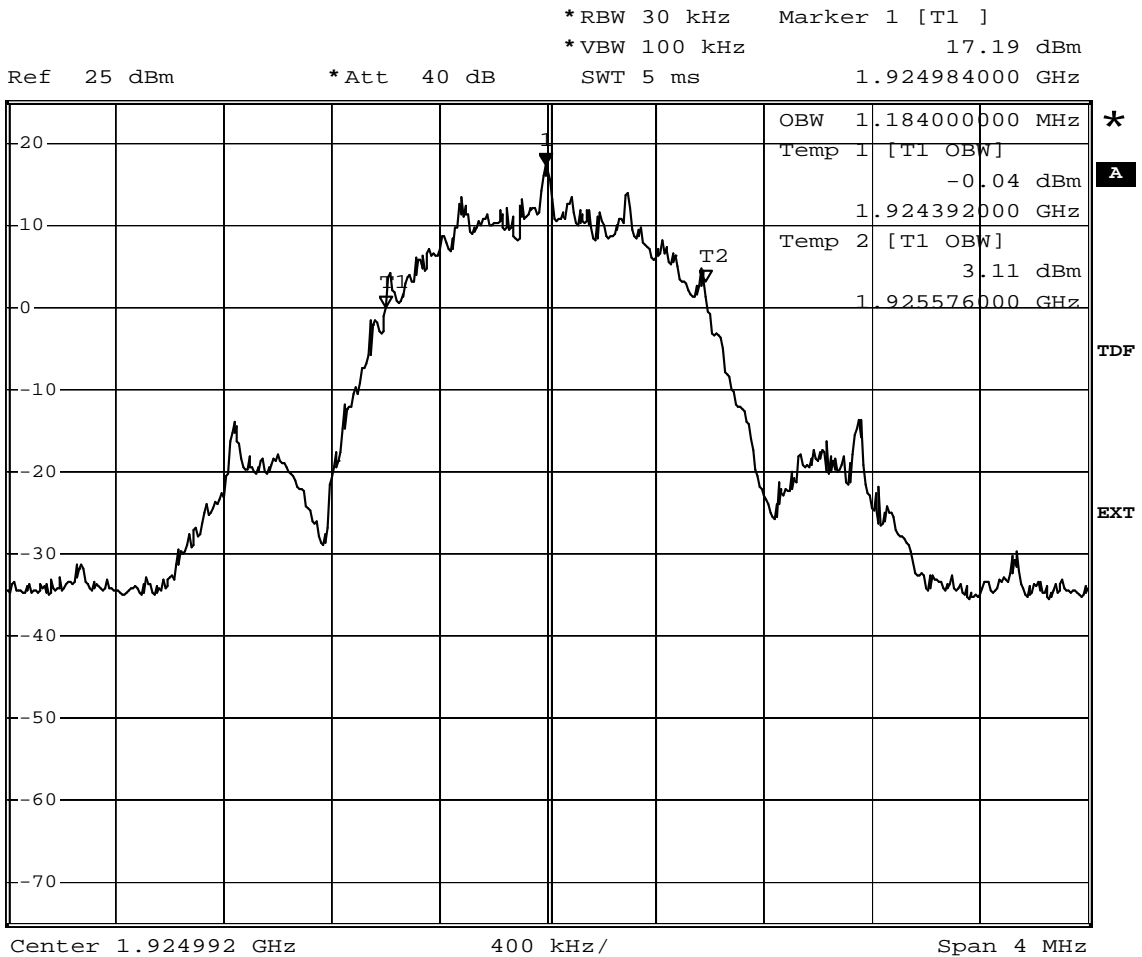

Comment: Ansi C63.17-1998 6.1.6.2  
Date: 9.MAY.2011 13:55:22

**RSS Gen  
Occupied Bandwidth**

EUT	DECT Basstation
Model	WHB003BS
Approval Holder	GN Netcom A/S
Temperature / Voltage	23°C / Vnom
Test Site / Operator	Eurofins Product Service GmbH / Mr. W. Treffke
Test Specification	Occupied Bandwidth
Comment 1	Channel.: 0
Comment 2	A spectrum analyzer with an integrated 99% power BW function is used
Comment 3	OBW: 1.18 MHz



Ref 25 dBm      \*Att 40 dB      SWT 5 ms

\*RBW 30 kHz      Marker 1 [T1 ]      17.06 dBm

\*VBW 100 kHz

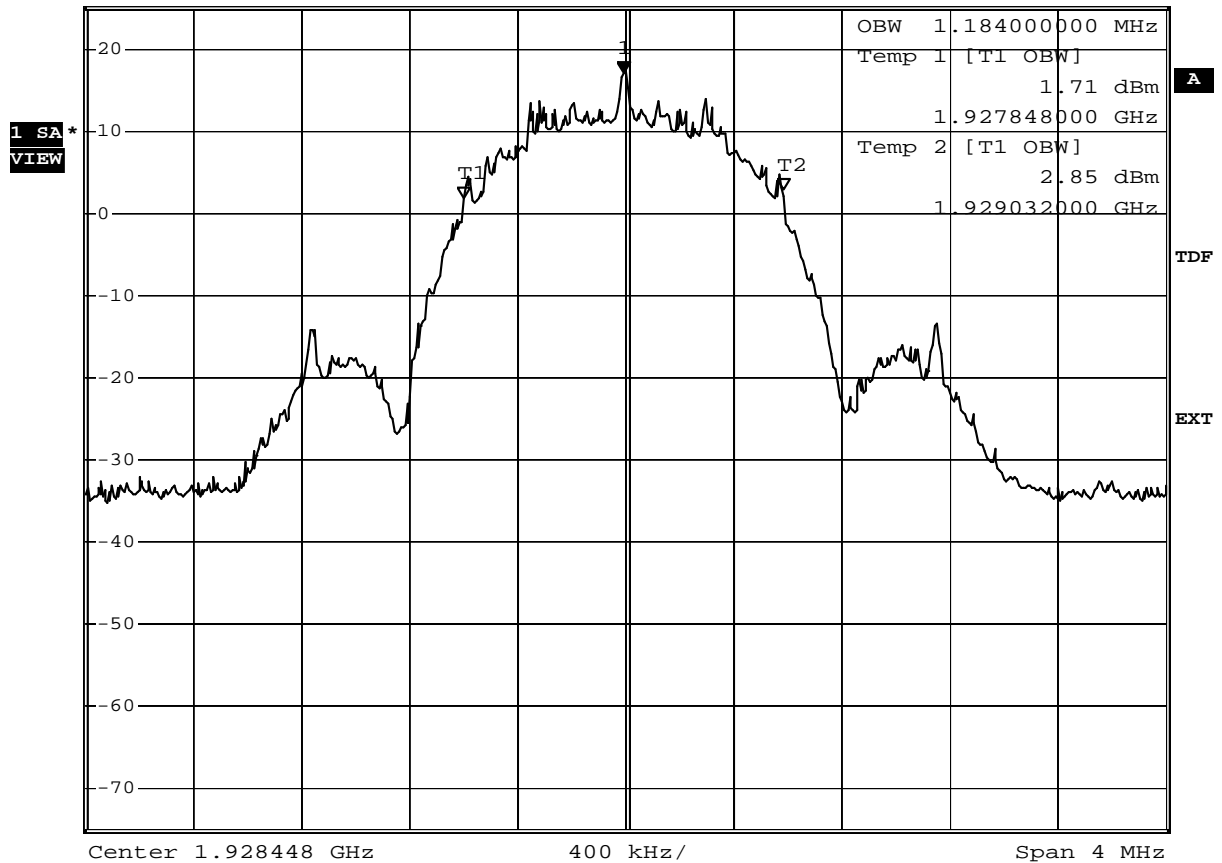

Comment: Ansi C63.17-1998 6.1.6.2  
Date: 9.MAY.2011 13:52:41

## Annex D Peak Transmit Power

### FCC Part 15.319 Peak Transmit Power limit

#### Testprocedure ANSI 63.17 UPCS

EUT	DECT base station
Model	Jabra PRO 9x0
Applicant	GN Netcom A/S
Temperature	23°C
Test Site / Operator	Eurofins Product Service GmbH
Test Specification	Peak transmit power
Supply	Vnom
Measured Bandwidth	1.448MHz
Max. Permitted Power	20,8 dBm
Measured Power	18,4 dBm
Test result	Verdict = PASS



CENTER FREQUENCY		RBW 3 MHz	Marker 1 [T1]
1.92672 GHz		*VBW 10 MHz	18.08 dBm
Ref 25 dBm	*Att 40 dB	SWT 500 µs	75.25000 µs

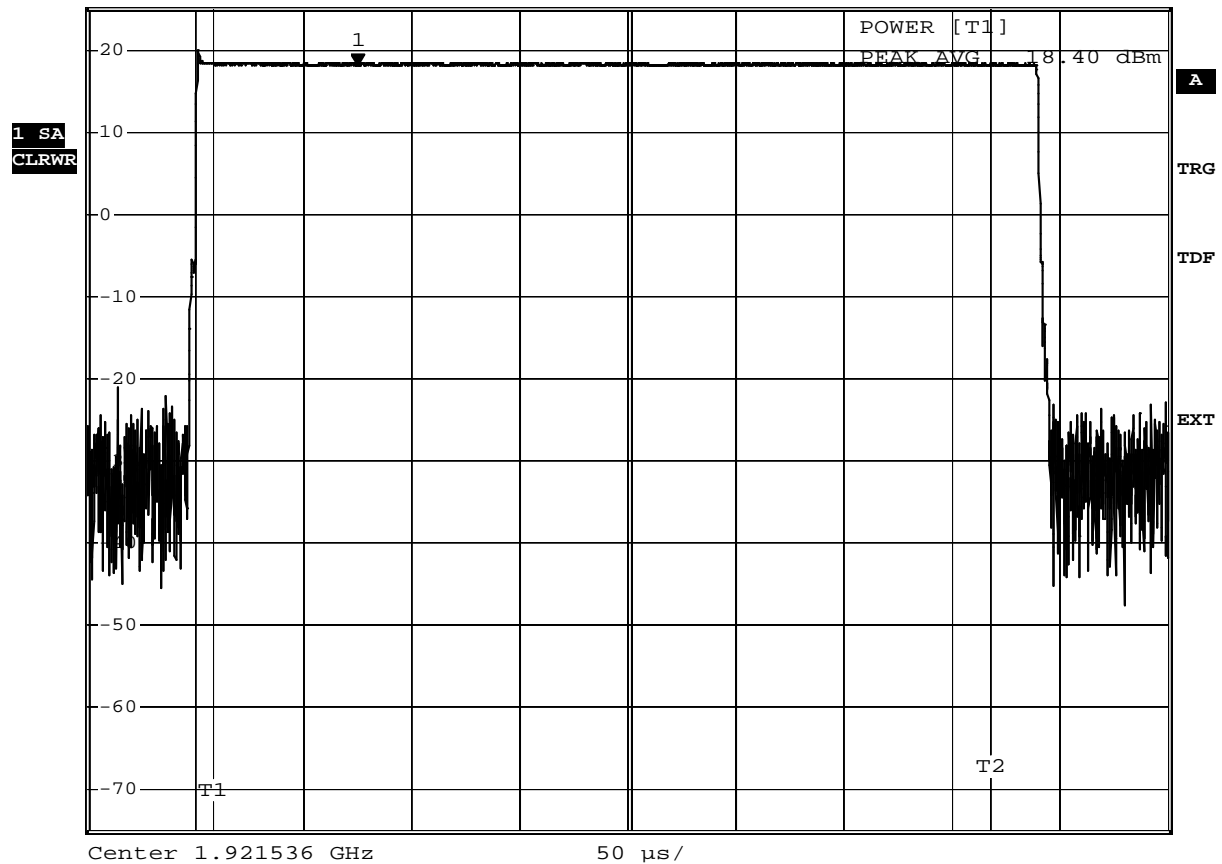

Comment: Ansi C63.17-2006 6.1.2  
Date: 9.MAY.2011 13:21:27

## FCC Part 15.319 Peak Transmit Power limit

### Testprocedure ANSI 63.17 UPCS

EUT	DECT base station
Model	WHB003BS
Applicant	GN Netcom A/S
Temperature	23°C
Test Site / Operator	Eurofins Product Service GmbH
Test Specification	Peak transmit power
Supply	Vmin
Measured Bandwidth	1.452MHz
Max. Permitted Power	20,8 dBm
Measured Power	18,33 dBm
Test result	Verdict = PASS



Peak transmit power

RBW 3 MHz

Marker 1 [T1]

\*VBW 10 MHz

18.06 dBm

Ref 25 dBm

\*Att 40 dB

SWT 500 µs

197.250000 µs

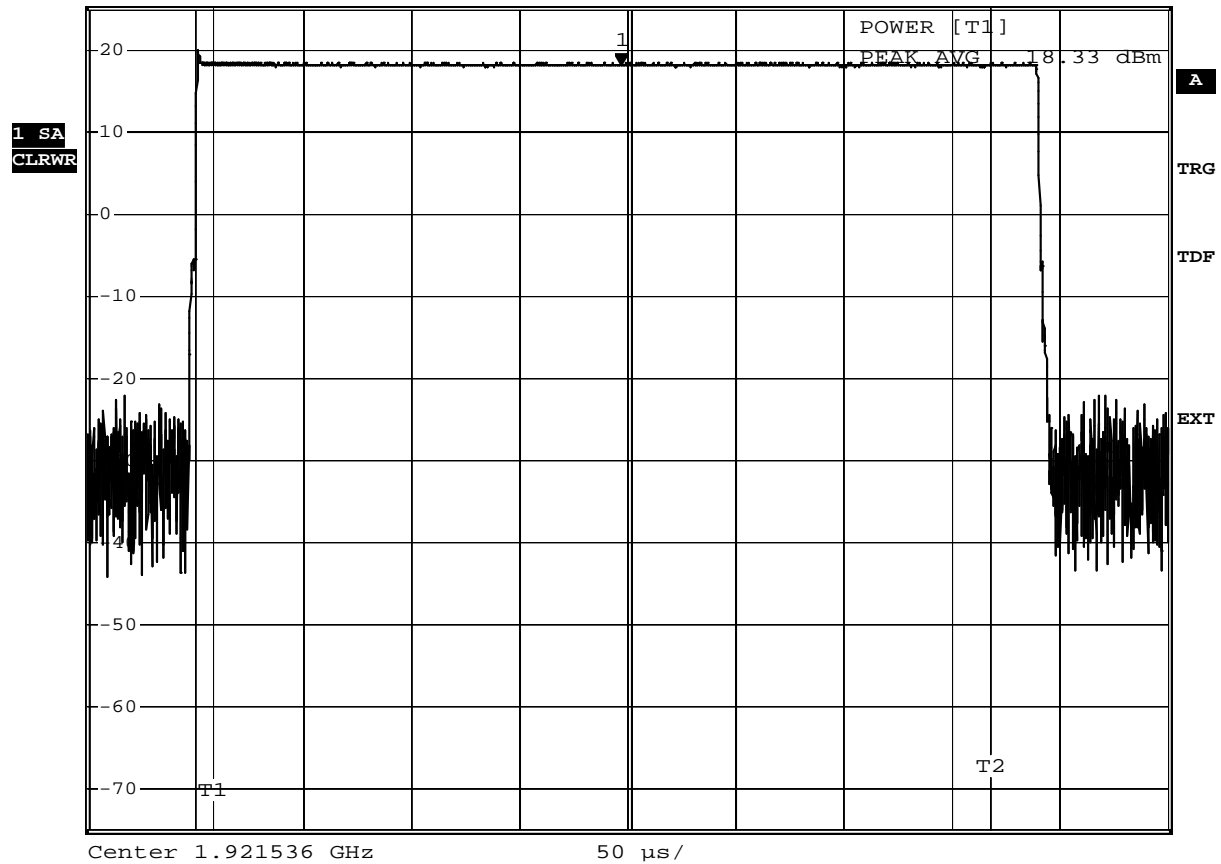

Comment: Ansi C63.17-2006 6.1.2

Date: 12.MAY.2011 09:49:56

## FCC Part 15.319 Peak Transmit Power limit

### Testprocedure ANSI 63.17 UPCS

EUT	DECT base station
Model	WHB003BS
Applicant	GN Netcom A/S
Temperature	23°C
Test Site / Operator	Eurofins Product Service GmbH
Test Specification	Peak transmit power
Supply	Vmax
Measured Bandwidth	1.452MHz
Max. Permitted Power	20,8 dBm
Measured Power	18,39 dBm
Test result	Verdict = PASS



Peak transmit power

RBW 3 MHz

Marker 1 [T1]

\*VBW 10 MHz

18.14 dBm

Ref 25 dBm

\*Att 40 dB

SWT 500 µs

197.250000 µs

1 SA  
CLRWR

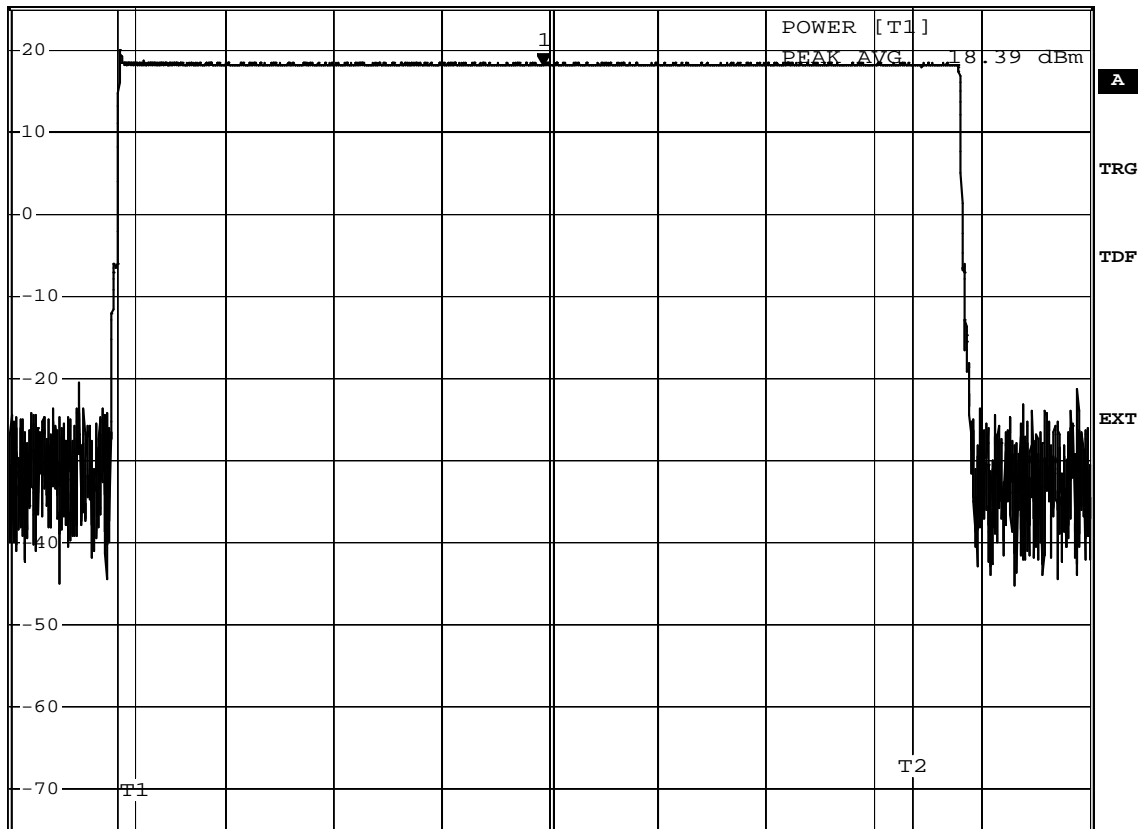

Center 1.921536 GHz

50 µs/

Comment: Ansi C63.17-2006 6.1.2

Date: 12.MAY.2011 09:52:00



## FCC Part 15.319 Peak Transmit Power limit

### Testprocedure ANSI 63.17 UPCS

EUT	DECT base station
Model	WHB003BS
Applicant	GN Netcom A/S
Temperature	23°C
Test Site / Operator	Eurofins Product Service GmbH
Test Specification	Peak transmit power
Supply	Vnom
Measured Bandwidth	1.45MHz
Max. Permitted Power	20,8 dBm
Measured Power	18,39 dBm
Test result	Verdict = PASS



Peak transmit power RBW 3 MHz Marker 1 [T1 ]  
 \*VBW 10 MHz 18.20 dBm  
 Ref 25 dBm \*Att 40 dB SWT 500 µs 220.500000 µs

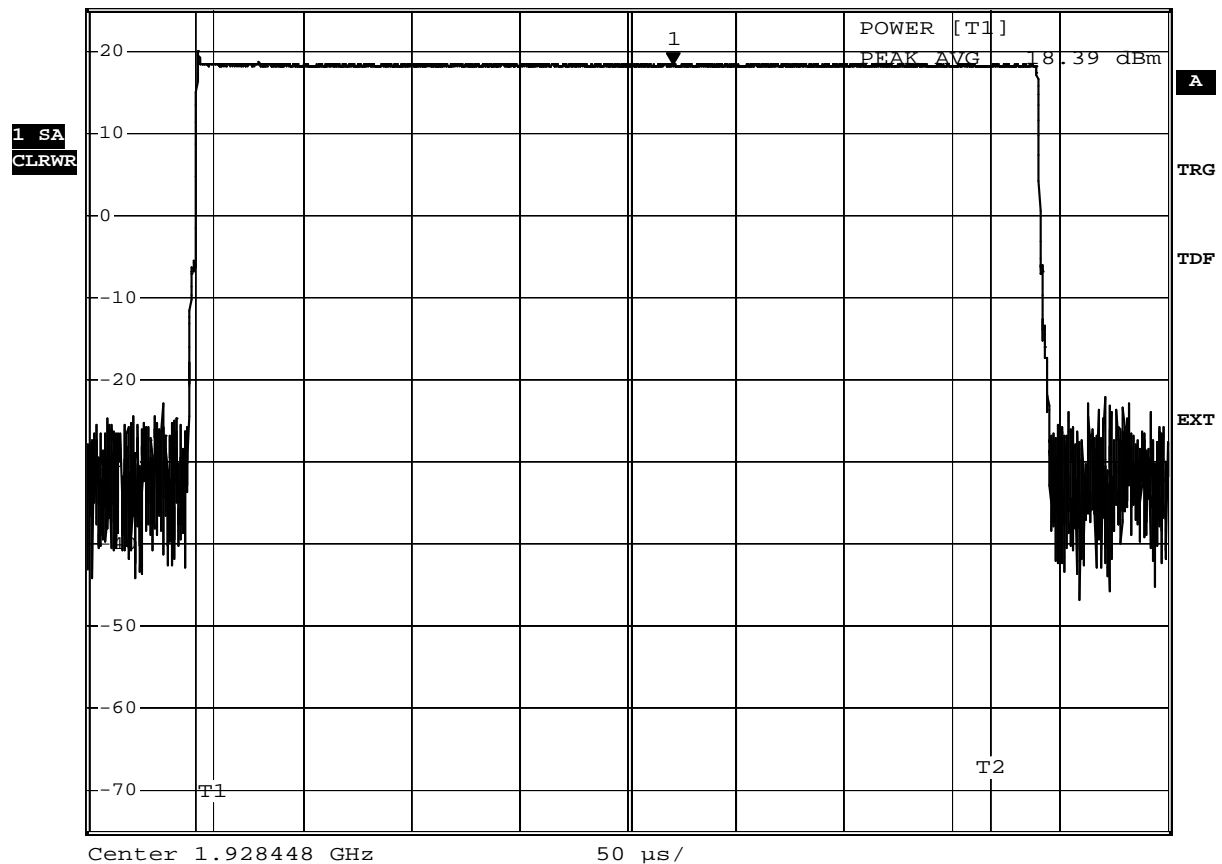

Comment: Ansi C63.17-2006 6.1.2  
 Date: 9.MAY.2011 13:38:14

## FCC Part 15.319 Peak Transmit Power limit

### Testprocedure ANSI 63.17 UPCS

EUT	DECT base station
Model	WHB003BS
Applicant	GN Netcom A/S
Temperature	23°C
Test Site / Operator	Eurofins Product Service GmbH
Test Specification	Peak transmit power
Supply	Vmin
Measured Bandwidth	1.452MHz
Max. Permitted Power	20,8 dBm
Measured Power	18,37 dBm
Test result	Verdict = PASS



Peak transmit power

RBW 3 MHz

Marker 1 [T1]

\*VBW 10 MHz

18.14 dBm

Ref 25 dBm

\*Att 40 dB

SWT 500 µs

197.250000 µs

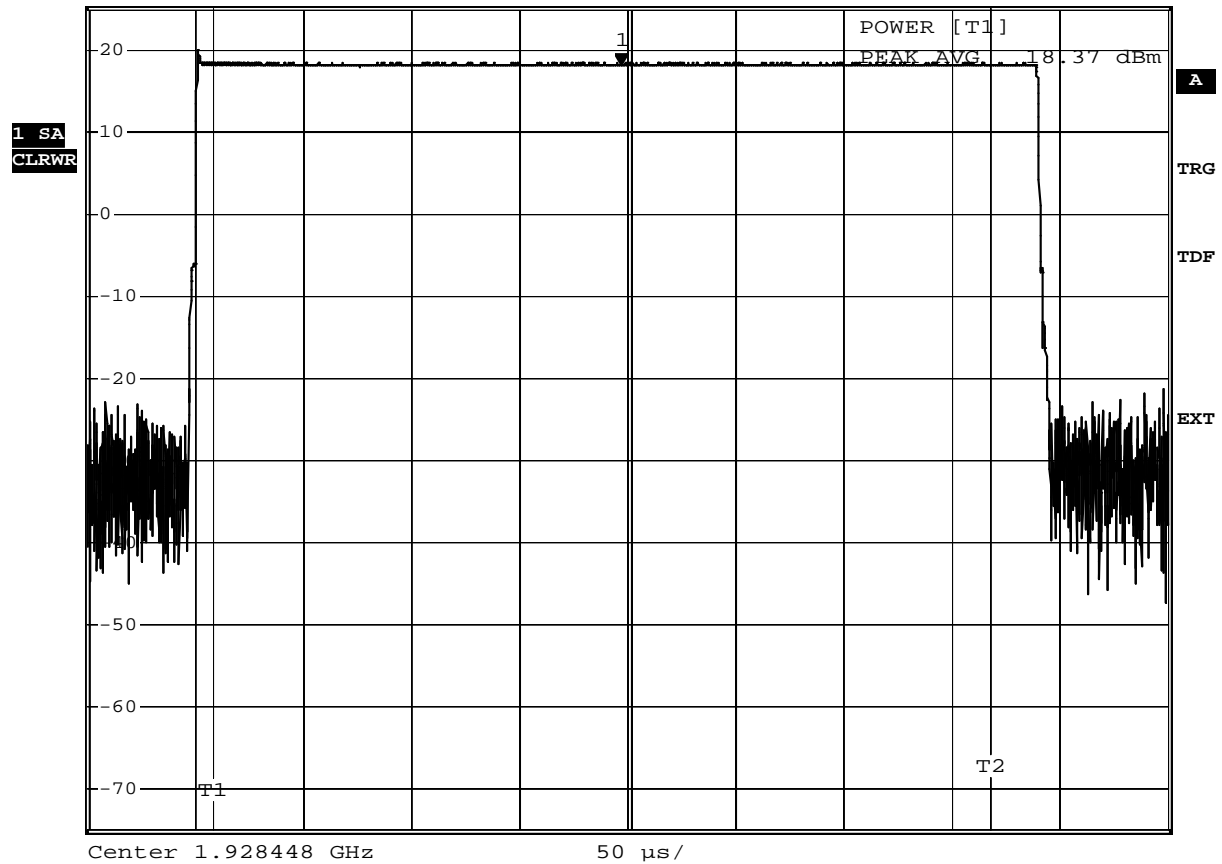

Comment: Ansi C63.17-2006 6.1.2

Date: 12.MAY.2011 09:53:09

## FCC Part 15.319 Peak Transmit Power limit

### Testprocedure ANSI 63.17 UPCS

EUT	DECT base station
Model	WHB003BS
Applicant	GN Netcom A/S
Temperature	23°C
Test Site / Operator	Eurofins Product Service GmbH
Test Specification	Peak transmit power
Supply	Vmax
Measured Bandwidth	1.452MHz
Max. Permitted Power	20,8 dBm
Measured Power	18,39 dBm
Test result	Verdict = PASS



Peak transmit power

RBW 3 MHz

Marker 1 [T1]

\*VBW 10 MHz

18.12 dBm

Ref 25 dBm

\*Att 40 dB

SWT 500 µs

197.250000 µs

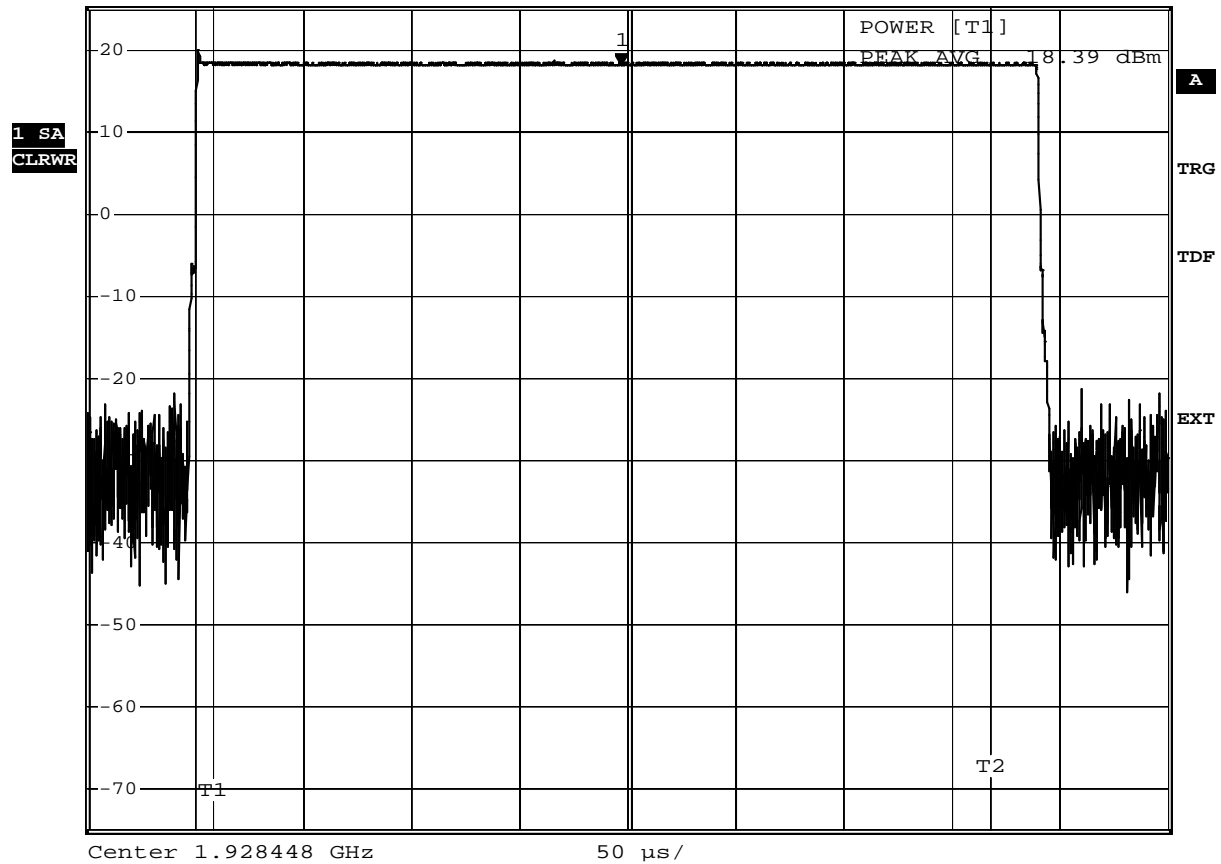

Comment: Ansi C63.17-2006 6.1.2

Date: 12.MAY.2011 09:57:45

## Annex E Power spectral density

### FCC Part 15.319 Power spectral density

#### Testprocedure ANSI 63.17 UPCS

EUT	DECT base station
Model	Jabra PRO 9x0
Applicant	GN Netcom A/S
Temperature	23°C
Test Site / Operator	Eurofins Product Service GmbH
Test Specification	Power spectral density
Peak Frequency in MHz	1921,686000 MHz
Total pulse energy in mW	0,000100 mW
Wideband pulse duration in ms	0,390088 ms
PSD in mW	0,2558 mW
PSD in dBm	-5,9205 dBm

Pass criteria: PSD is less than 3mW Verdict = PASS



CENTER FREQUENCY		RBW 3 kHz	Marker 1 [T1]
1.92672 GHz		*VBW 10 kHz	-7.06 dBm
Ref 10 dBm	*Att 40 dB	SWT 1.561 ms	627.522000 µs

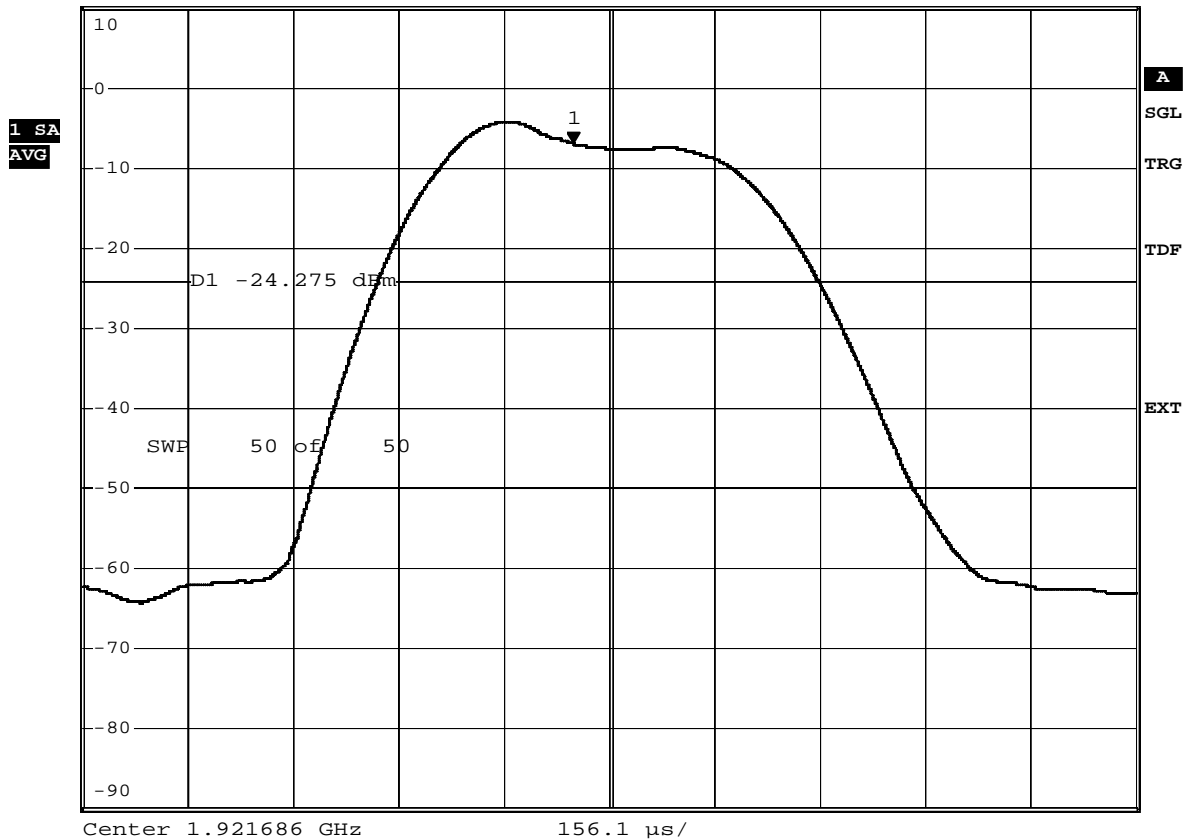

Comment: Ansi C63.17-2006 6.1.5  
Date: 9.MAY.2011 13:18:50

## FCC Part 15.319 Power spectral density

### Testprocedure ANSI 63.17 UPCS

EUT	DECT base station
Model	WHB003BS
Applicant	GN Netcom A/S
Temperature	23°C
Test Site / Operator	Eurofins Product Service GmbH
Test Specification	Power spectral density
Peak Frequency in MHz	1928,448000 MHz
Total pulse energy in mW	0,000311 mW
Wideband pulse duration in ms	0,375788 ms
PSD in mW	0,8264 mW
PSD in dBm	-0,8280 dBm

Pass criteria: PSD is less than 3mW      Verdict = PASS

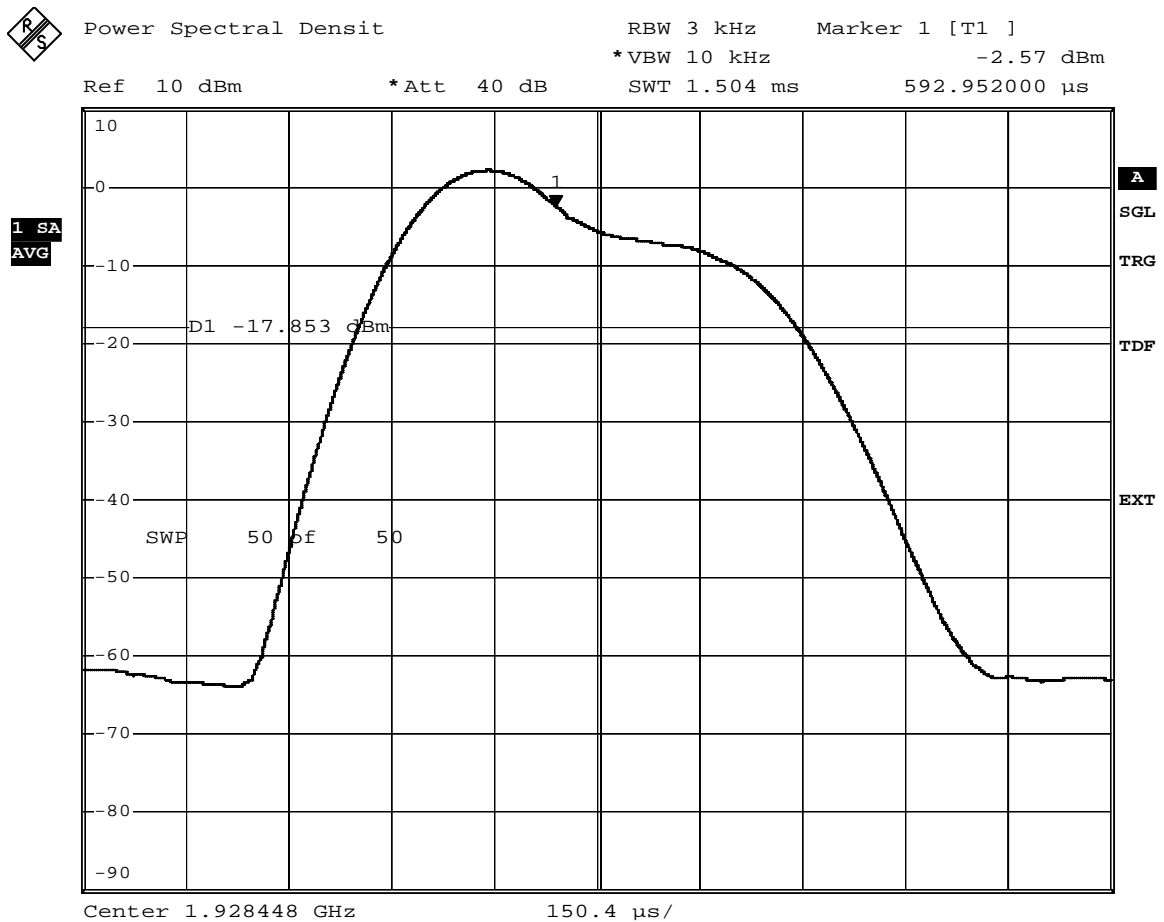

Comment: Ansi C63.17-2006 6.1.5  
Date: 9.MAY.2011 13:36:53

## Annex F Monitoring threshold

Test case ANSI\_7.3.2\_upper\_threshold.xml  
 Date 09.05.2011 13:12:09  
 Reference to the EUT G0M-1104-1090 / Jabra PRO 9x0  
 Comment: initial setup  
 DECT base station  
 GN Netcom A/S

The LOG table shows the level changes on each Channel of the transmission system

Time stamp	1921.536 MHZ	1923.264 MHZ	1924.992 MHZ	1926.720 MHZ	1928.448 MHZ	Comment
	Peak in dBm	Peak in dBm	Peak in dBm	Peak in dBm	Peak in dBm	
	RMS in dBm	RMS in dBm	RMS in dBm	RMS in dBm	RMS in dBm	
00:02:28.9687500	-50,9 -51,1	-50,8 -51	-50,8 -51	-50,8 -51	-50,6 -50,8	-51 dBm
00:02:47.2656250	-51,9 -52,1	-51,8 -52	-51,8 -52	-51,8 -52	-51,7 -51,9	-52 dBm
00:03:03.1406250	-52,9 -53,1	-52,8 -53	-52,8 -53	-52,8 -53	-52,6 -52,8	-53 dBm
00:03:18.4531250	-53,8 -54	-53,7 -54	-53,7 -53,9	-53,7 -54	-53,6 -53,8	-54 dBm
00:07:26.6093750	-54,7 -55	-54,6 -54,9	-54,7 -54,9	-54,7 -54,9	-54,5 -54,8	-55 dBm
00:07:41.7343750	-55,7 -56	-55,6 -55,8	-55,6 -55,9	-55,5 -55,8	-55,5 -55,7	-56 dBm
00:08:01.4218750	-56,7 -57	-56,6 -56,8	-56,5 -56,9	-56,5 -56,8	-56,5 -56,7	-57 dBm
00:08:38.7656250	-57,6 -57,9	-57,5 -57,8	-57,5 -57,8	-57,4 -57,8	-57,4 -57,7	-58 dBm
00:08:55.2968750	-58,6 -59	-58,5 -58,9	-58,5 -58,9	-58,5 -58,8	-58,3 -58,7	-59 dBm
00:09:14.7187500	-59,7 -60	-59,4 -59,8	-59,4 -59,8	-59,4 -59,8	-59,3 -59,7	-60 dBm
00:09:27.7187500	-60,3 -61	-59,6 -60,9	-58 -60,9	-55,1 -60,8	-22,8 -48,7	Upper threshold level:-61 dBm







Test case   ANSI\_7.3.3\_least\_interfered\_channel.xml  
 Date 09.05.2011 14:30:03  
 Reference to the EUT                         G0M-1104-1090 / WHB003BS  
 Comment:   7.3.3\_d  
   DECT base station  
   GN Netcom A/S

The LOG table shows the level changes on each Channel of the transmission system

Time stamp	1921.536 MHZ	1923.264 MHZ	1924.992 MHZ	1926.720 MHZ	1928.448 MHZ	Comment
	Peak in dBm RMS in dBm	Peak in dBm RMS in dBm	Peak in dBm RMS in dBm	Peak in dBm RMS in dBm	Peak in dBm RMS in dBm	
00:13:54.9218750	-87,3 -95,9	-87 -95,8	-86,5 -96	-86,5 -95,8	-86,8 -95,9	Interferer off
00:14:07.4375000	-60,6 -60,9	-60,4 -60,8	-60,4 -60,9	-76,8 -79,7	-81,1 -86	Interferer on
00:14:25.0625000	-60,4 -60,9	-60,2 -60,8	-57,9 -60,8	-60 -78,7	-22,2 -47,6	OK 1
00:14:29.3437500	-60,6 -61	-60,4 -60,9	-60,5 -60,9	-76,7 -79,7	-81 -86,2	
00:14:35.7031250	-60,3 -60,9	-60,2 -60,8	-59,4 -60,8	-57,9 -78,9	-21,6 -46	OK 2
00:14:39.5312500	-60,6 -60,9	-60,5 -60,9	-60,5 -60,9	-77,1 -79,8	-81,1 -86,1	
00:14:45.1562500	-60,1 -60,9	-60,4 -60,8	-57,6 -60,8	-58,5 -78,7	-23,4 -48,1	OK 3
00:14:49.1093750	-60,6 -60,9	-60,4 -60,9	-60,5 -60,9	-77,1 -79,8	-81,4 -86,1	
00:14:55.1250000	-59,9 -60,9	-60 -60,8	-58,1 -60,8	-58,6 -78,9	-21,6 -46,1	OK 4
00:14:59.5312500	-60,6 -60,9	-60,4 -60,9	-60,5 -60,9	-76,8 -79,8	-81,6 -86,1	
00:15:05.1562500	-59,5 -60,9	-60,4 -60,8	-58,4 -60,8	-77 -79,7	-81,1 -86	OK 5

Test case                               ANSI\_7.3.3\_least\_interfered\_channel.xml  
 Date 09.05.2011 14:33:38  
 Reference to the EUT               G0M-1104-1090 / WHB003BS  
 Comment:                               7.3.3\_e  
   DECT base station  
   GN Netcom A/S

The LOG table shows the level changes on each Channel of the transmission system

Time stamp	1921.536	1923.264	1924.992	1926.720	1928.448	Comment
	MHz	MHz	MHz	MHz	MHz	
	Peak in dBm	Peak in dBm	Peak in dBm	Peak in dBm	Peak in dBm	
	RMS in dBm	RMS in dBm	RMS in dBm	RMS in dBm	RMS in dBm	
00:17:51.9687500	-86,2 -95,6	-86,3 -95,9	-85 -95,7	-86,1 -95,8	-86,3 -96	Interferer off
00:17:57.3593750	-60,5 -60,9	-60,5 -60,8	-60,5 -60,9	-81,5 -86,4	-76,1 -79,4	Interferer on
00:18:08.3593750	-58,9 -60,9	-59,7 -60,8	-56 -60,8	-21,7 -46,2	-52,4 -77,7	OK 1
00:18:12	-60,5 -61	-60,5 -60,9	-60,4 -60,9	-80,8 -86,3	-76,5 -79,5	
00:18:17.6406250	-58,6 -60,9	-59,6 -60,8	-57 -60,8	-21,7 -46,4	-52,4 -77,6	OK 2
00:18:21.4218750	-60,6 -61	-60,5 -60,9	-60,5 -60,9	-81 -86,4	-76,6 -79,5	
00:18:27.0625000	-58,5 -60,9	-58,3 -60,8	-56,2 -60,8	-22,3 -47,2	-52,2 -77,7	OK 3
00:18:32.2031250	-60,5 -60,9	-60,5 -60,9	-60,5 -60,9	-80,7 -86,5	-76,5 -79,5	
00:18:39.6406250	-59,3 -60,9	-60,1 -60,8	-56,4 -60,8	-21,4 -46,1	-51,2 -77,6	OK 4
00:18:43.7812500	-60,5 -60,9	-60,4 -60,9	-60,5 -60,9	-80,8 -86,3	-76,6 -79,5	
00:18:50.1718750	-59,3 -60,9	-57,8 -60,8	-56,3 -60,8	-21,8 -46,8	-52,7 -77,7	OK 5

## Annex G Monitoring of intended transmit window and maximum reaction time

Test case ANSI\_7.5\_reaction\_time\_low\_ch.xml  
 Date 09.05.2011 15:24:51  
 Reference to the EUT G0M-1104-1090 / WHB003BS  
 Comment: 7.5\_low\_ch\_50/35us  
 DECT base station  
 GN Netcom A/S

The LOG table shows the level changes on each Channel of the transmission system

Time stamp	1921.536 MHz	1923.264 MHz	1924.992 MHz	1926.720 MHz	1928.448 MHz	Comment
	Peak in dBm	Peak in dBm	Peak in dBm	Peak in dBm	Peak in dBm	
	RMS in dBm	RMS in dBm	RMS in dBm	RMS in dBm	RMS in dBm	
01:07:44.1250000	-75 -84,7	-74,5 -84,6	-75,6 -84,7	-75 -84,7	-74,2 -84,7	Interferer off
01:07:52.5312500	-31,9 -57,5	-33,9 -58,1	-20 -44,7	-28,2 -55,7	-48,7 -77,3	Dummy on channel 2
01:08:27.6093750	-51,6 -61,5	-56,6 -57,9	-56,8 -57,7	-56,8 -57,8	-56,7 -57,8	50 µs interferer on, Dummy release
01:08:34.8125000	-20,1 -44,8	-28,3 -55,3	-50,2 -78	-55,6 -83,6	-68,8 -84,3	Interferer off, dummy on ch. 4
01:09:36.0468750	-45,6 -57,2	-56,4 -57,9	-56,7 -57,7	-56,8 -57,8	-56,8 -57,8	35 µs interferer on, Dummy release

Test case                                   ANSI\_7.5\_reaction\_time\_high\_ch.xml  
 Reference to the EUT                    Date 09.05.2011 15:18:44  
   G0M-1104-1090 / WHB003BS  
 Comment:                                   7.5\_high\_ch\_50/35us  
   DECT base station  
   GN Netcom A/S

The LOG table shows the level changes on each Channel of the transmission system

Time stamp	1921.536 MHZ	1923.264 MHz	1924.992 MHz	1926.720 MHz	1928.448 MHz	Comment
	Peak in dBm RMS in dBm	Peak in dBm RMS in dBm	Peak in dBm RMS in dBm	Peak in dBm RMS in dBm	Peak in dBm RMS in dBm	
01:01:36.5781250	-75,4 -84,8	-75,1 -84,7	-75,3 -84,6	-74,9 -84,9	-75,1 -84,7	Interferer off
01:01:43.7812500	-31,4 -58,1	-33,9 -57,9	-20,6 -44,7	-27,7 -54,6	-50,2 -77,6	Dummy on ch 2
01:02:24.5000000	-57,1 -58	-56,8 -57,9	-57 -57,9	-56,6 -57,8	-51,4 -61,4	50 µs interferer on, Dummy release
01:02:41.2500000	-20,3 -44,7	-29,7 -54,6	-50,6 -76,6	-57,4 -83,8	-57,1 -84,1	Interferer off, Dummy on ch 4
01:03:42.7812500	-57 -58	-57 -57,9	-56,9 -57,9	-55 -57,8	-45,3 -56,9	35 µs interferer on, Dummy release

## Annex H Monitoring bandwidth

Test case ANSI\_7.4.1\_monitoring\_bandwidth.xml  
 Date 09.05.2011 14:48:04  
 Reference to the EUT G0M-1104-1090 / WHB003BS  
 Comment: 7.4.1 simple compliance test\_low\_-30%  
 DECT base station  
 GN Netcom A/S

The LOG table shows the level changes on each Channel of the transmission system

Time stamp	1921.536 MHZ	1923.264 MHz	1924.992 MHz	1926.720 MHz	1928.448 MHz	Comment
	Peak in dBm	Peak in dBm	Peak in dBm	Peak in dBm	Peak in dBm	
	RMS in dBm	RMS in dBm	RMS in dBm	RMS in dBm	RMS in dBm	
00:30:52.4218750	-75 -84,7	-75,7 -84,6	-74,2 -84,7	-75,1 -84,7	-74,8 -84,8	Interferer off
00:31:10.7656250	-19,8 -44,9	-27,7 -54,7	-48 -76,6	-54,2 -83,5	-68,8 -84,3	Dummy on channel 3
00:33:09.5312500	-50 -50,4	-58,5 -59,8	-58,4 -59,7	-58,6 -59,7	-58,5 -59,7	Interferer on, dummy release

Test case ANSI\_7.4.1\_monitoring\_bandwidth.xml  
 Date 09.05.2011 14:52:53  
 Reference to the EUT G0M-1104-1090 / WHB003BS  
 Comment: 7.4.1 simple compliance test\_ low\_+30%  
 DECT base station  
 GN Netcom A/S

The LOG table shows the level changes on each Channel of the transmission system

Time stamp	1921.536 MHz	1923.264 MHz	1924.992 MHz	1926.720 MHz	1928.448 MHz	Comment
	Peak in dBm	Peak in dBm	Peak in dBm	Peak in dBm	Peak in dBm	
	RMS in dBm	RMS in dBm	RMS in dBm	RMS in dBm	RMS in dBm	
00:37:07.6406250	-75,8 -84,8	-75 -84,7	-73,8 -84,7	-74,6 -84,7	-75,3 -84,7	Interferer off
00:37:29.6406250	-32,1 -59	-33,8 -57,6	-20 -44,8	-28,8 -54,8	-49,1 -76,5	Dummy on channel 2
00:38:05.3437500	-48 -48,4	-56,8 -57,9	-56,6 -57,8	-56,9 -57,8	-56,7 -57,8	Interferer on, dummy release

Test case: ANSI\_7.4.1\_monitoring\_bandwidth.xml  
 Date 09.05.2011 14:56:04  
 Reference to the EUT: G0M-1104-1090 / WHB003BS  
 Comment: 7.4.1 simple compliance test\_high\_-30%  
 DECT base station  
 GN Netcom A/S

The LOG table shows the level changes on each Channel of the transmission system

Time stamp	1921.536 MHZ	1923.264 MHz	1924.992 MHz	1926.720 MHz	1928.448 MHz	Comment
	Peak in dBm	Peak in dBm	Peak in dBm	Peak in dBm	Peak in dBm	
	RMS in dBm	RMS in dBm	RMS in dBm	RMS in dBm	RMS in dBm	
00:40:33.2812500	-75,9 -84,7	-75,4 -84,7	-74,2 -84,8	-75,9 -84,6	-74,8 -84,7	Interferer off
00:40:42.7187500	-31,5 -58,2	-34 -57,6	-20,4 -45,2	-27,4 -54,8	-49,2 -77,2	Dummy on channel 2
00:41:18.2656250	-57 -58	-56,8 -57,9	-56,9 -57,9	-56,8 -57,9	-47,8 -48,2	Interferer on, dummy release

Test case                                   ANSI\_7.4.1\_monitoring\_bandwidth.xml  
   Date 09.05.2011 15:05:12  
 Reference to the EUT                   G0M-1104-1090 / WHB003BS  
  
 Comment:                                   7.4.1 simple compliance test\_high\_+30%  
  
   DECT base station  
   GN Netcom A/S

The LOG table shows the level changes on each Channel of the transmission system

Time stamp	1921.536 MHZ	1923.264 MHz	1924.992 MHz	1926.720 MHz	1928.448 MHz	Comment
	Peak in dBm	Peak in dBm	Peak in dBm	Peak in dBm	Peak in dBm	
	RMS in dBm	RMS in dBm	RMS in dBm	RMS in dBm	RMS in dBm	
00:43:38.2031250	-75,8 -84,7	-75,6 -84,6	-74,5 -84,7	-75,1 -84,8	-74,6 -84,7	Interferer off
00:43:48.5781250	-31,4 -57,6	-34,5 -58	-20,8 -45	-29,7 -55	-48,9 -76	Dummy on channel 2
00:50:18.2656250	-56,8 -58	-56,8 -57,9	-57 -57,9	-56,8 -57,9	-47,7 -48,2	Interferer on, dummy release



# Annex I Connection acknowledgement

## ANSI C63.17 - Access criteria test interval UPCS1900

EUT	DECT Basstation
Model	WHB003BS
Approval Holder	GN Netcom A/S
Temperature / Voltage	23°C / Vnom
Test Site / Operator	Eurofins Product Service GmbH / Mr. W. Treffke
Test Specification	ANSI C63.17 - Access criteria test interval
Comment 1	The interval between access criteria tests
Comment 2	Measurement result: 1.25 ms
Comment 3	Verdict: PASS

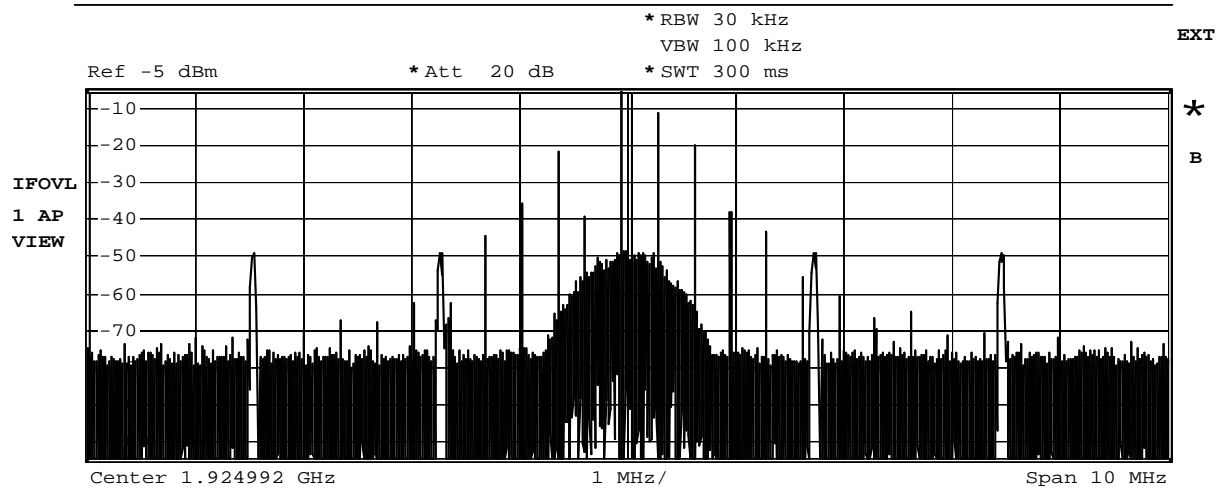
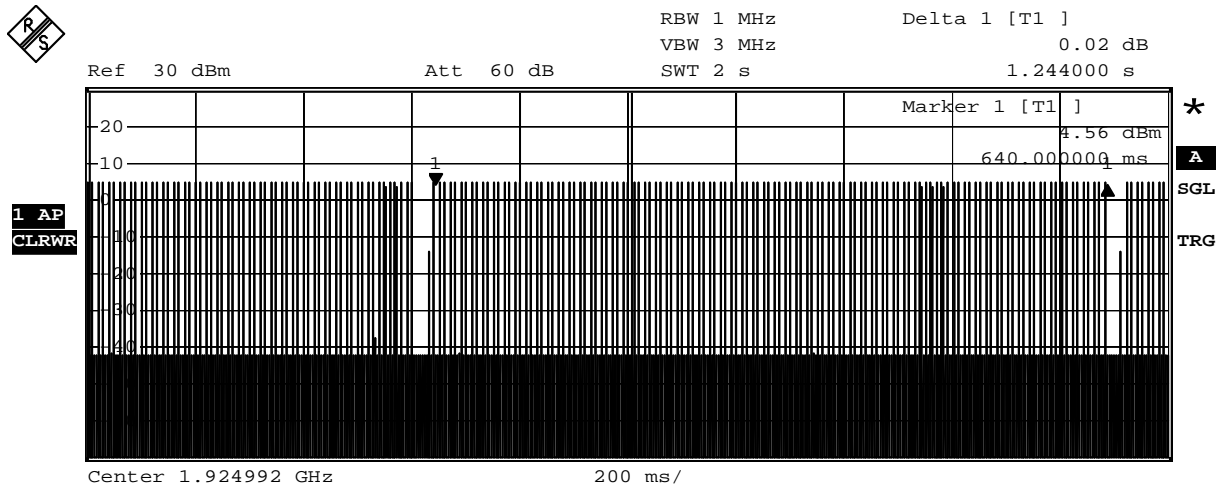

Comment: Ansi C63.17-1998 6.1.6.2  
 Date: 12.MAY.2011 08:51:12

**ANSI C63.17 - Access criteria functional test  
UPCS1900**

EUT	DECT Basstation
Model	WHB003BS
Approval Holder	GN Netcom A/S
Temperature / Voltage	23°C / Vnom
Test Site / Operator	Eurofins Product Service GmbH / Mr. W. Treffke
Test Specification	ANSI C63.17 - Access criteria functional test
Comment 1	initial condition
Comment 2	Connection at channel 2 (1924,992 MHz), in time slot 2 (840 µs)
Comment 3	

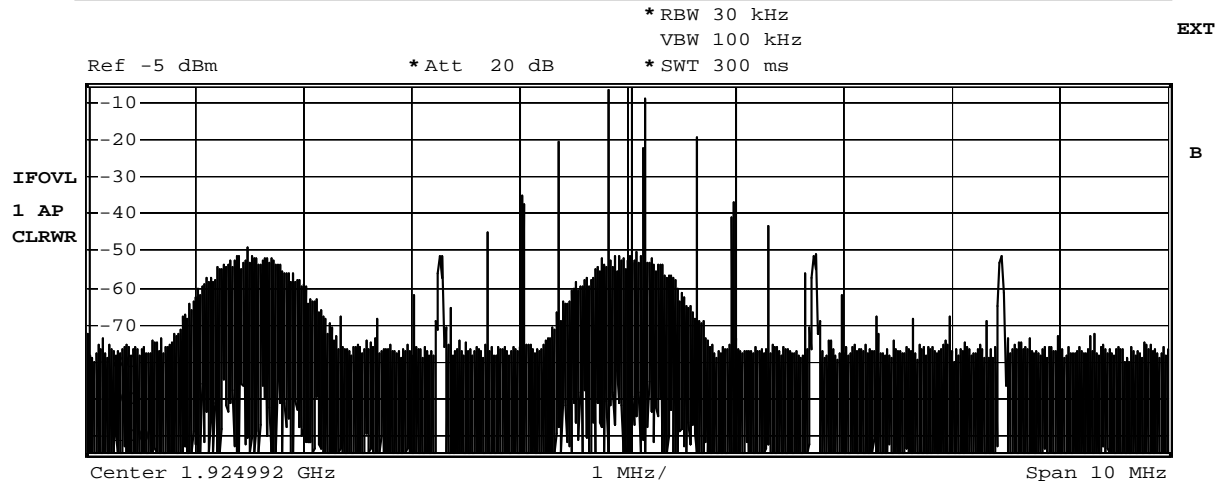
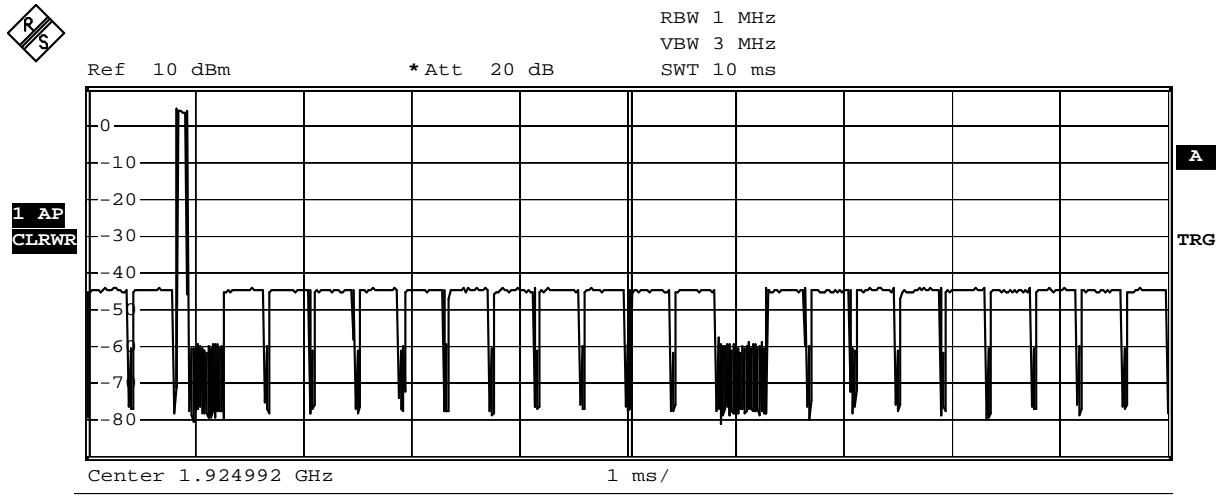

Comment: Ansi C63.17-1998 6.1.6.2  
Date: 12.MAY.2011 08:28:59

**ANSI C63.17 - Access criteria functional test  
UPCS1900**

EUT	DECT Basstation
Model	WHB003BS
Approval Holder	GN Netcom A/S
Temperature / Voltage	23°C / Vnom
Test Site / Operator	Eurofins Product Service GmbH / Mr. W. Treffke
Test Specification	ANSI C63.17 - Access criteria functional test
Comment 1	CW interference on ch 2 (initial traffic channel)
Comment 2	after the next pause
Comment 3	New connection at channel 4 (1921,536 MHz), in time slot 4 (1.666ms)

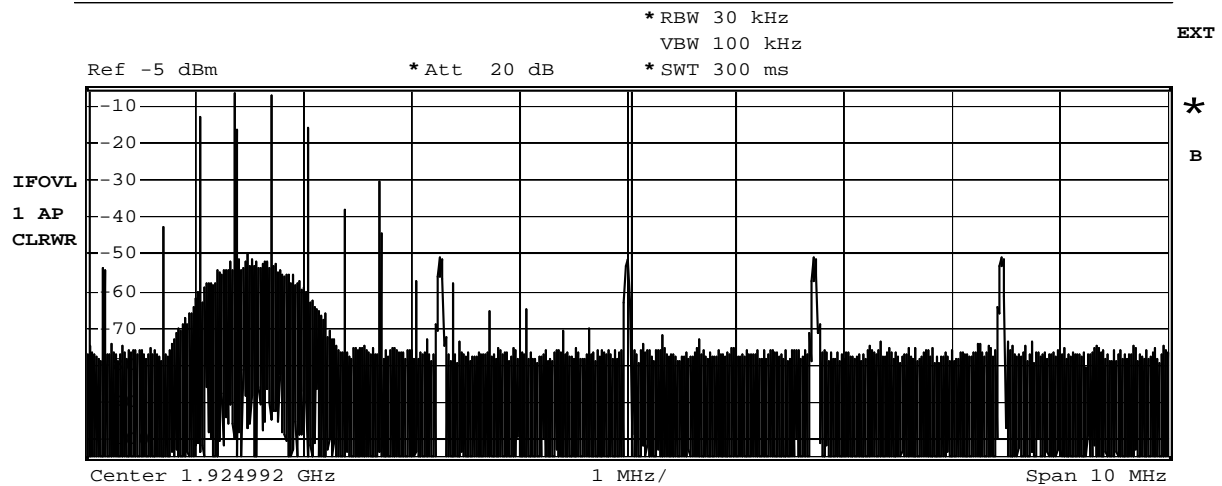
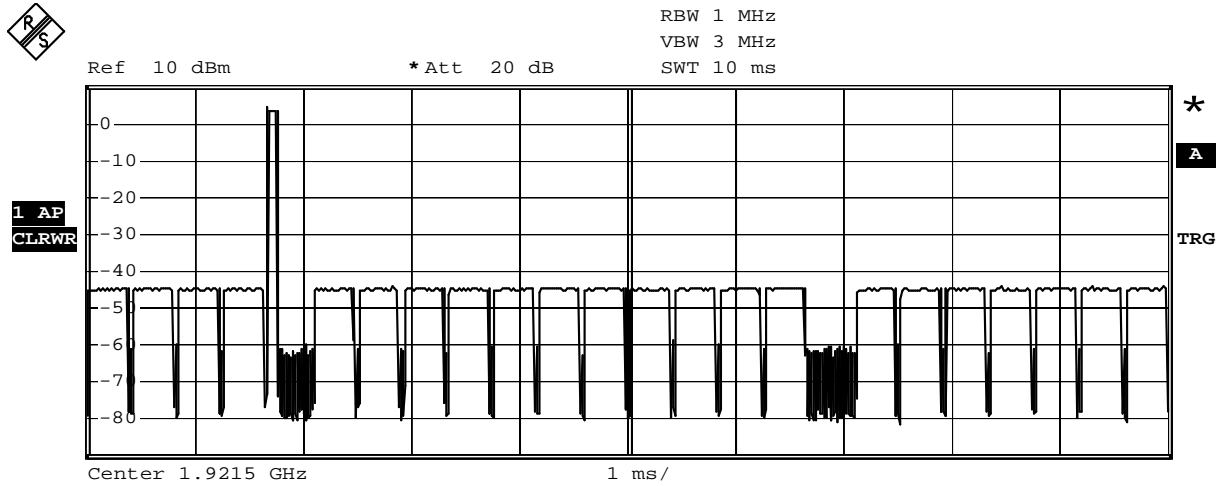

Comment: Ansi C63.17-1998 6.1.6.2  
 Date: 12.MAY.2011 08:44:16

Test case ANSI\_8.2.1\_Acknowledgments\_30s.xml  
Date 10.05.2011 09:21:02

Reference to the EUT G0M-1104-1090 / WHB003BS

Comment: 8.2.1 Acknowledgments for b) and c)

DECT base station  
GN Netcom A/S

The LOG table shows the level changes on each Channel of the transmission system

Time stamp	1921.536 MHZ	1923.264 MHz	1924.992 MHz	1926.720 MHz	1928.448 MHz	Comment
	Peak in dBm RMS in dBm	Peak in dBm RMS in dBm	Peak in dBm RMS in dBm	Peak in dBm RMS in dBm	Peak in dBm RMS in dBm	
00:00:45.3593750	-66 -69,9	-59,1 -69,6	-21,6 -40,4	-54,5 -69,6	-65,7 -69,6	Connection EUT to companion device
00:01:00.0343750	-66 -70	-57,6 -69,5	-21,7 -42,2	-53,3 -69,4	-66,9 -69,6	Block acknowledge- ments from the companion device
00:01:05.3593750	-64,8 -69,9	-56,9 -69,7	-21,8 -46,8	-53,5 -69,6	-65,3 -69,6	EUT change to dummy bearer

The EUT terminates transmissions on the communications channel after 5.3 seconds.

## Annex J      Emission inside and outside the sub-band; Spurious Emission

### FCC Part 15.323 In-band unwanted emission

#### Testprocedure ANSI 63.17 UPCS

EUT	DECT base station
Model	Jabra PRO 9x0
Applicant	GN Netcom A/S
Temperature	23°C
Test Site / Operator	Eurofins Product Service GmbH
Test Specification	In-band unwanted emission
	1.448MHz



CENTER FREQUENCY	
1.92672 GHz	

\*RBW 10 kHz

\*VBW 30 kHz

\*SWT 23 s

Ref 10 dBm

\*Att 20 dB

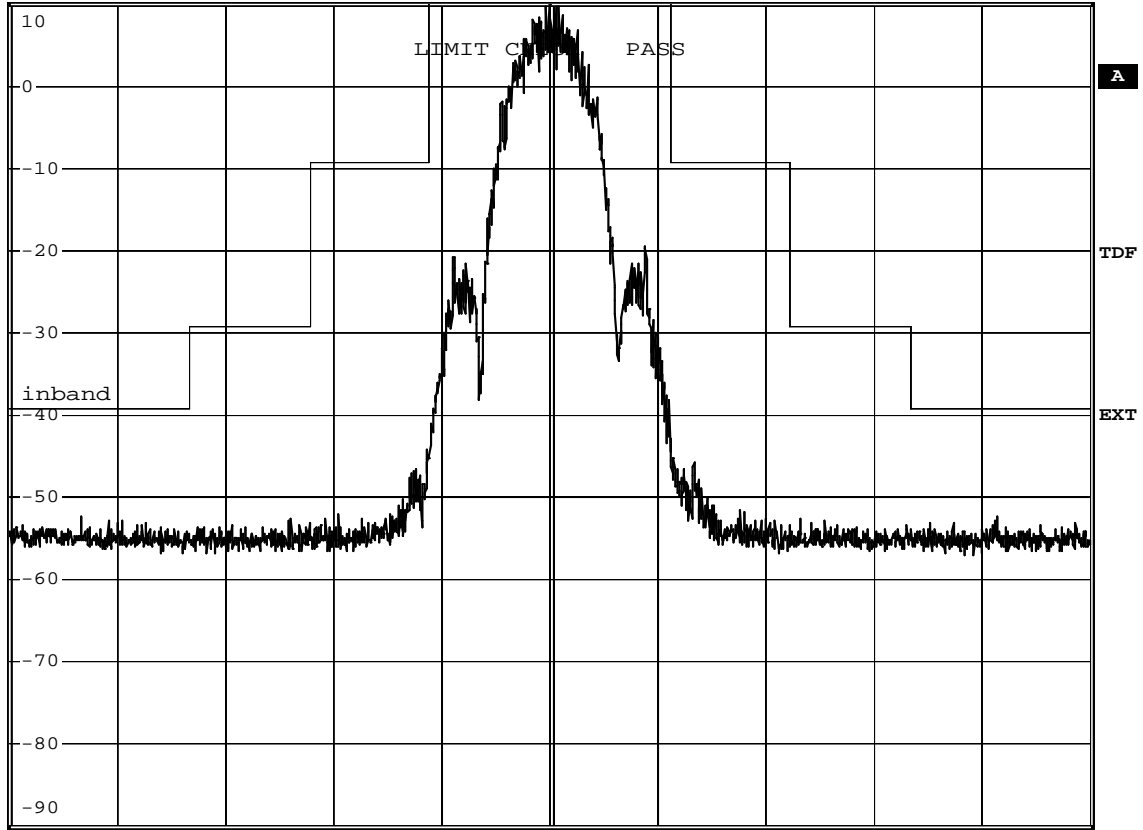
 1 PK  
MAXH

Center 1.921536 GHz

1.3 MHz/

Span 13 MHz

Comment: Ansi C63.17-2006 6.1.6.1

Date: 9.MAY.2011 13:23:53

## FCC Part 15.323 In-band unwanted emission

### Testprocedure ANSI 63.17 UPCS

EUT	DECT base station
Model	WHB003BS
Applicant	GN Netcom A/S
Temperature	23°C
Test Site / Operator	Eurofins Product Service GmbH
Test Specification	In-band unwanted emission

1.45MHz



In-band unwanted emis

\*RBW 10 kHz

\*VBW 30 kHz

\*SWT 23 s

Ref 10 dBm

\*Att 20 dB

1 PK  
MAXH

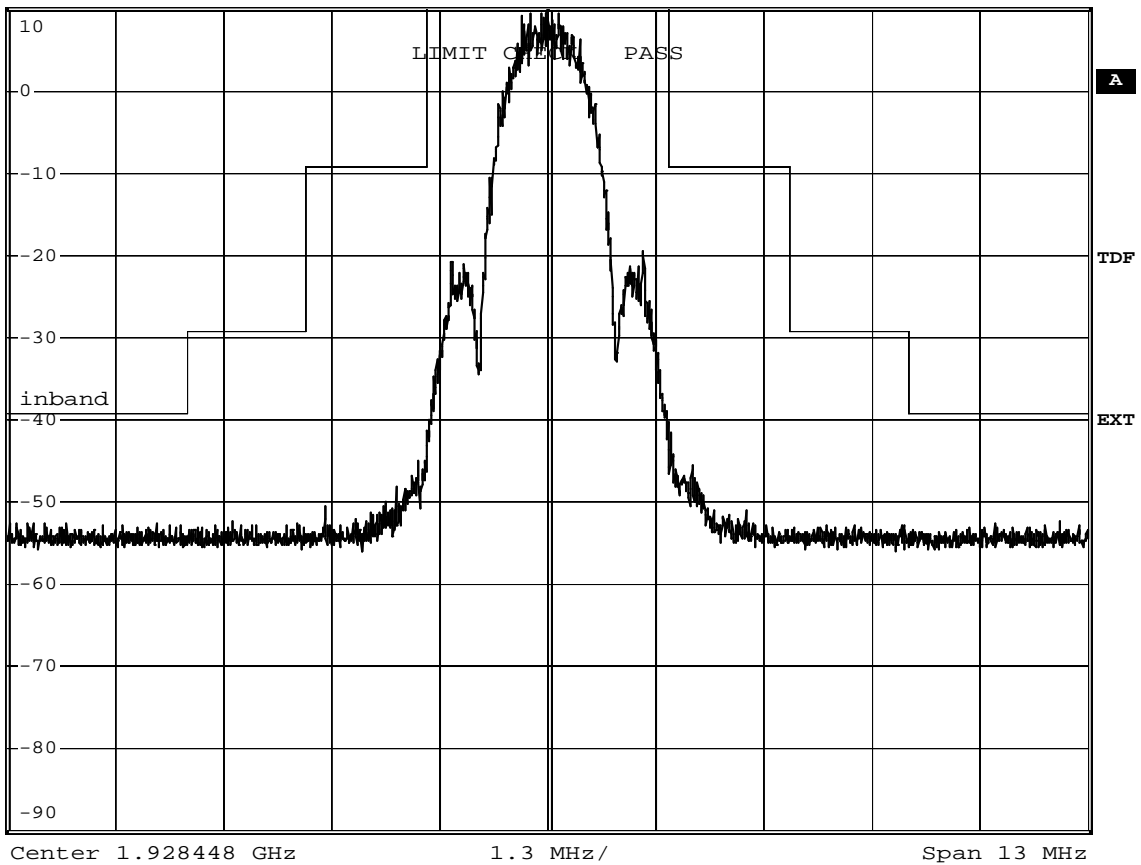

Comment: Ansi C63.17-2006 6.1.6.1

Date: 9.MAY.2011 13:43:42

Test Report No.: G0M-1104-1092-C-2

Eurofins Product Service GmbH  
Storkower Str. 38c, D-15526 Reichenwalde, Germany

Page 79 of 133

### FCC Part 15.323 Out-of-band emission

#### Testprocedure ANSI 63.17 UPCS

EUT	DECT base station
Model	Jabra PRO 9x0
Applicant	GN Netcom A/S
Temperature	23°C
Test Site / Operator	Eurofins Product Service GmbH
Test Specification	Out-of-band emission

measurement on the lowest carrier  
Carrier=1921.536MHz

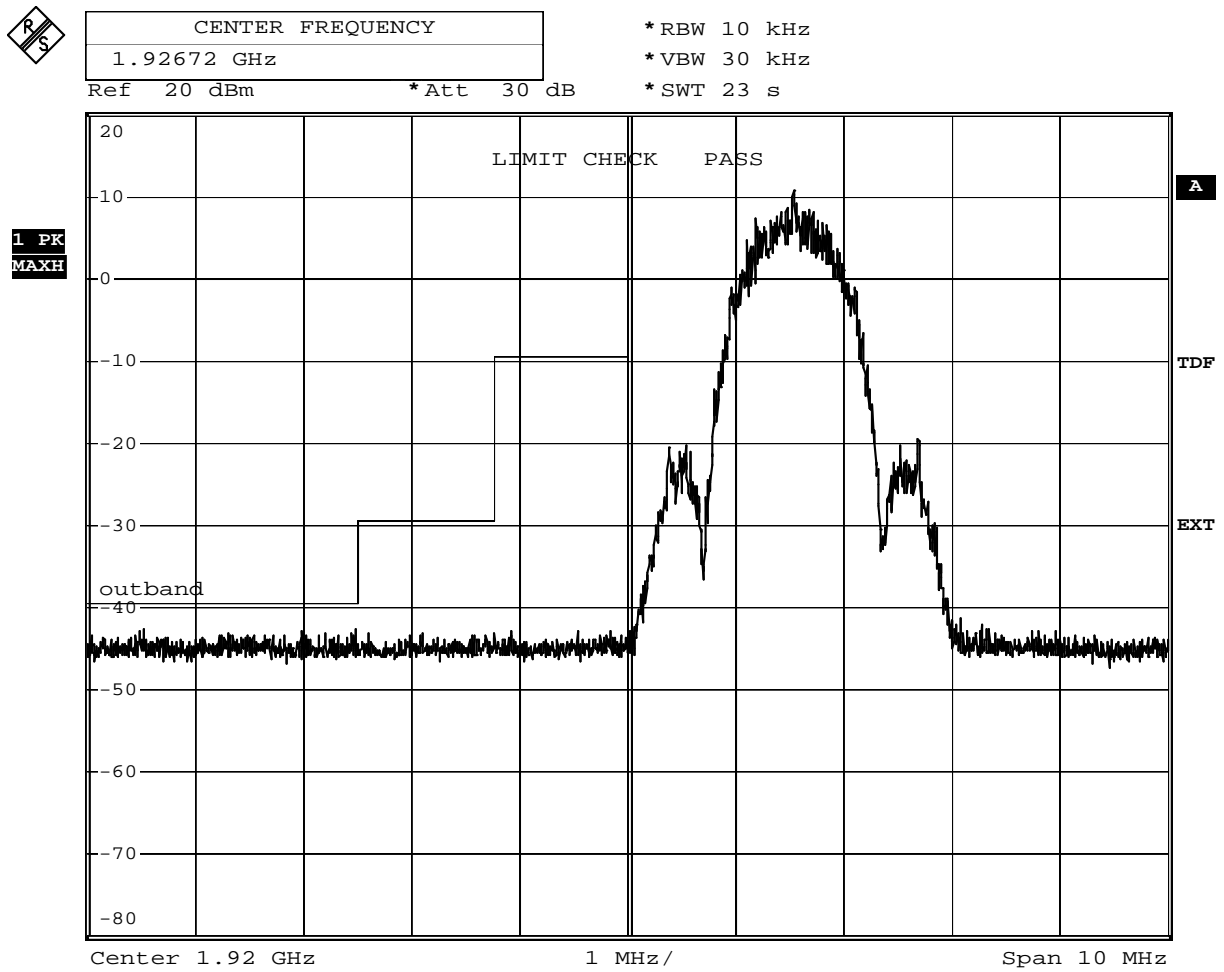

Comment: Ansi C63.17-2006 6.1.6.2  
Date: 9.MAY.2011 13:26:00



## FCC Part 15.323 Out-of-band emission

### Testprocedure ANSI 63.17 UPCS

EUT	DECT base station
Model	WHB003BS
Applicant	GN Netcom A/S
Temperature	23°C
Test Site / Operator	Eurofins Product Service GmbH
Test Specification	Out-of-band emission

measurement on the highest carrier  
Carrier=1928.448MHz



Out-of-band emission

\*RBW 10 kHz

\*VBW 30 kHz

\*SWT 23 s

Ref 20 dBm

\*Att 30 dB

1 PK  
MAXH

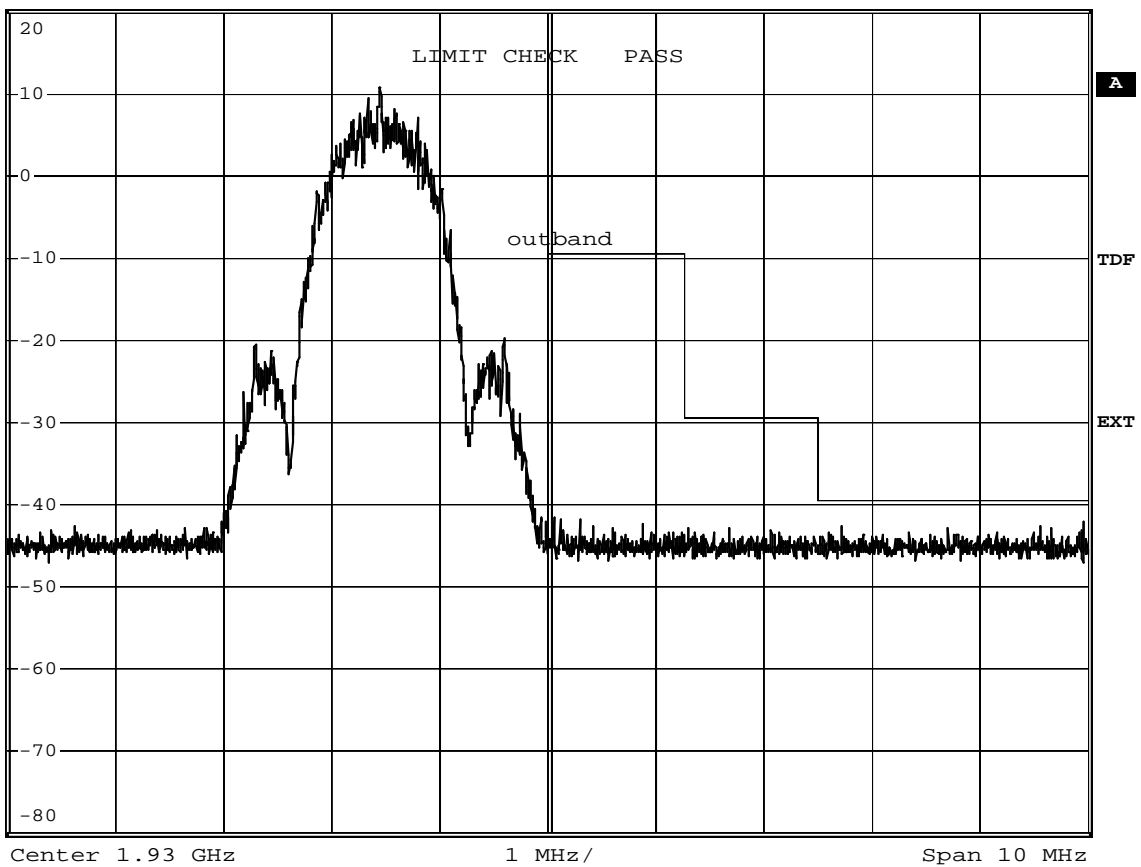

Comment: Ansi C63.17-2006 6.1.6.2

Date: 9.MAY.2011 13:47:55

Test Report No.: G0M-1104-1092-C-2

Eurofins Product Service GmbH  
Storkower Str. 38c, D-15526 Reichenwalde, Germany

Page 81 of 133

## Annex K Frame period

### FCC Part 15.323 Frame Period and jitter

#### Testprocedure ANSI 63.17 UPCS

EUT	DECT base station
Model	Jabra PRO 9x0
Applicant	GN Netcom A/S
Temperature	23°C
Test Site / Operator	Eurofins Product Service GmbH
Test Specification	Frame Period and jitter

Width of the time class	0,002086 µs
Mean	9,999851 ms
Deviation	0,000004
Max-Min	0,052154 µs
Test result	Verdict = PASS

Histogram

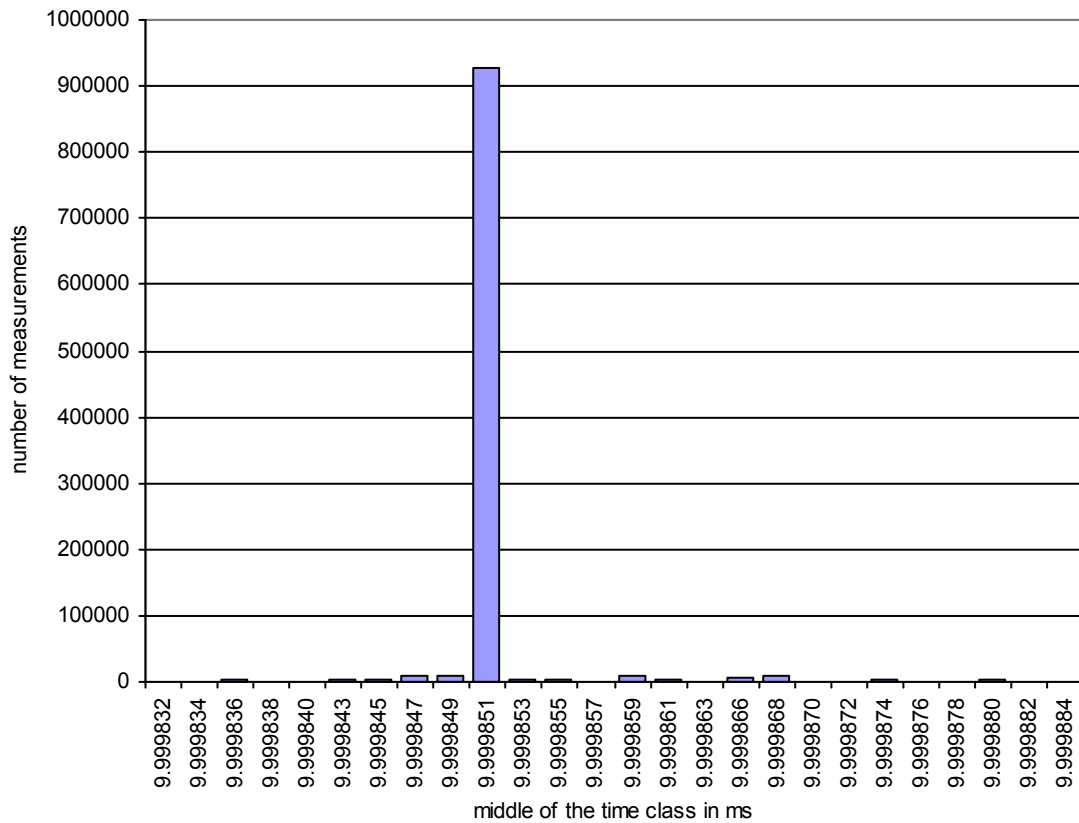

## FCC Part 15.323 Frame repetition

### Testprocedure ANSI 63.17

#### UPCS

EUT	DECT base station
Model	Jabra PRO 9x0
Applicant	GN Netcom A/S
Temperature	23°C
Test Site / Operator	Eurofins Product Service GmbH
Test Specification	Frame repetition

Width of the frequency class	0,000002 Hz
Mean	99,999940 Hz
Deviation	0,000017
Stability in ppm	0,499944 ppm
Test result	Verdict = PASS

### Histogram

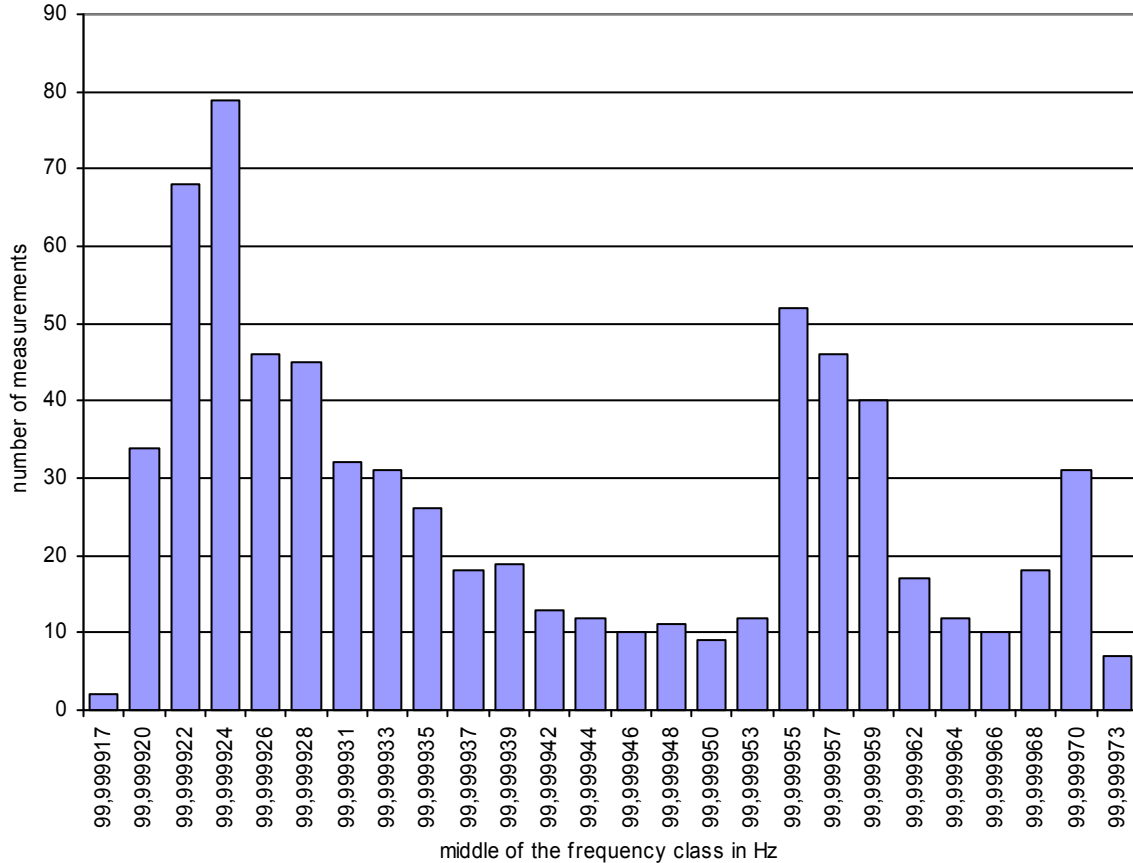

## Annex L Frequency Stability

### FCC Part 15.323 Frequency Stability

#### Testprocedure ANSI 63.17

EUT	DECT base station
Model	Jabra PRO 9x0
Applicant	GN Netcom A/S
Temperature	0 °C
Test Site / Operator	Eurofins Product Service GmbH
Test Specification	Frequency stability
Power supply	Vnom
Frequency of carrier	1924,991594 MHz
Measured mean	1925,001017 MHz
Stability (supply temp)	4,89 ppm
Result	Verdict = PASS
Stability over time	fmax : 0,71 ppm fmin : 0,77 ppm
Result	Verdict = PASS

Histogram

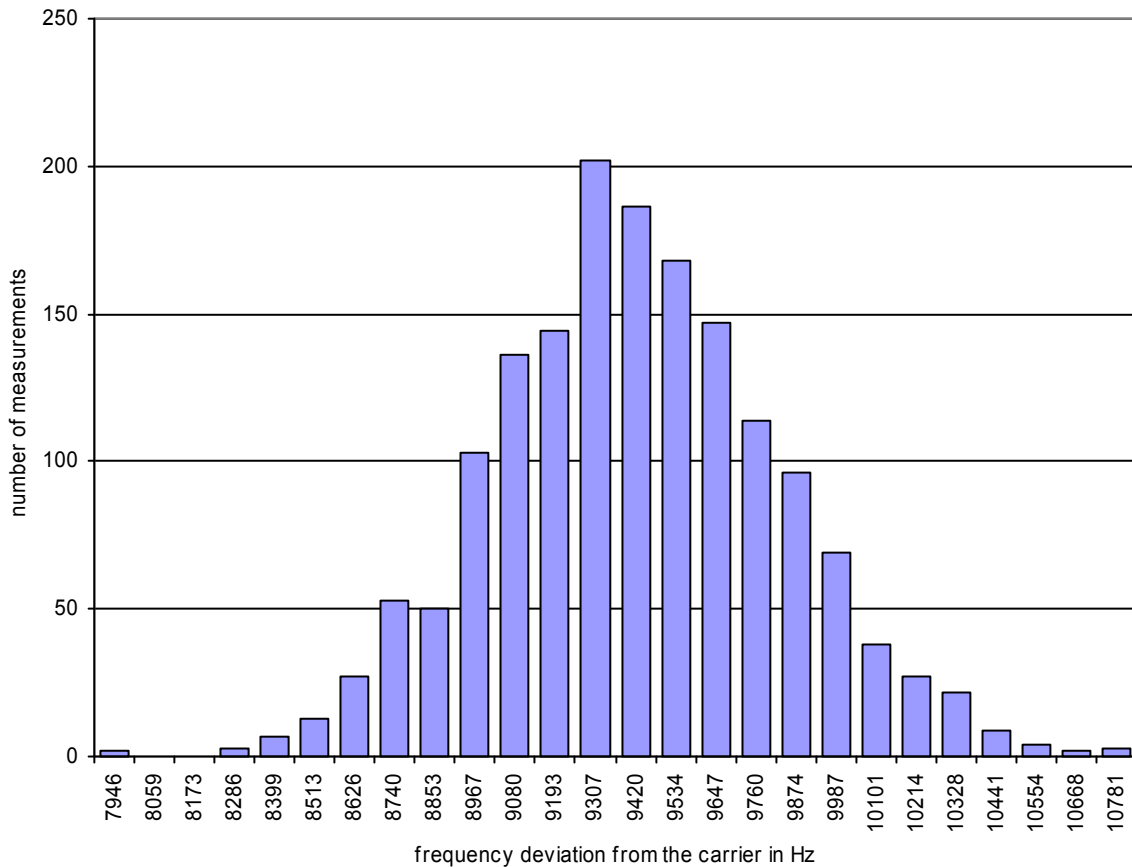

## FCC Part 15.323 Frequency Stability

### Testprocedure ANSI 63.17

EUT	DECT base station
Model	Jabra PRO 9x0
Applicant	GN Netcom A/S
Test Site / Operator	Eurofins Product Service GmbH
Test Specification	Frequency stability

Temperature	20 °C
Power supply	Vnom
Frequency of carrier	1924,991594MHz
Measured mean	1924,991594MHz
Stability (supply temp)	0,0 ppm (reference)
Result	Verdict = PASS
Stability over time	fmax : 0,62 ppm fmin : 0,68 ppm
Result	Verdict = PASS

**Histogram**

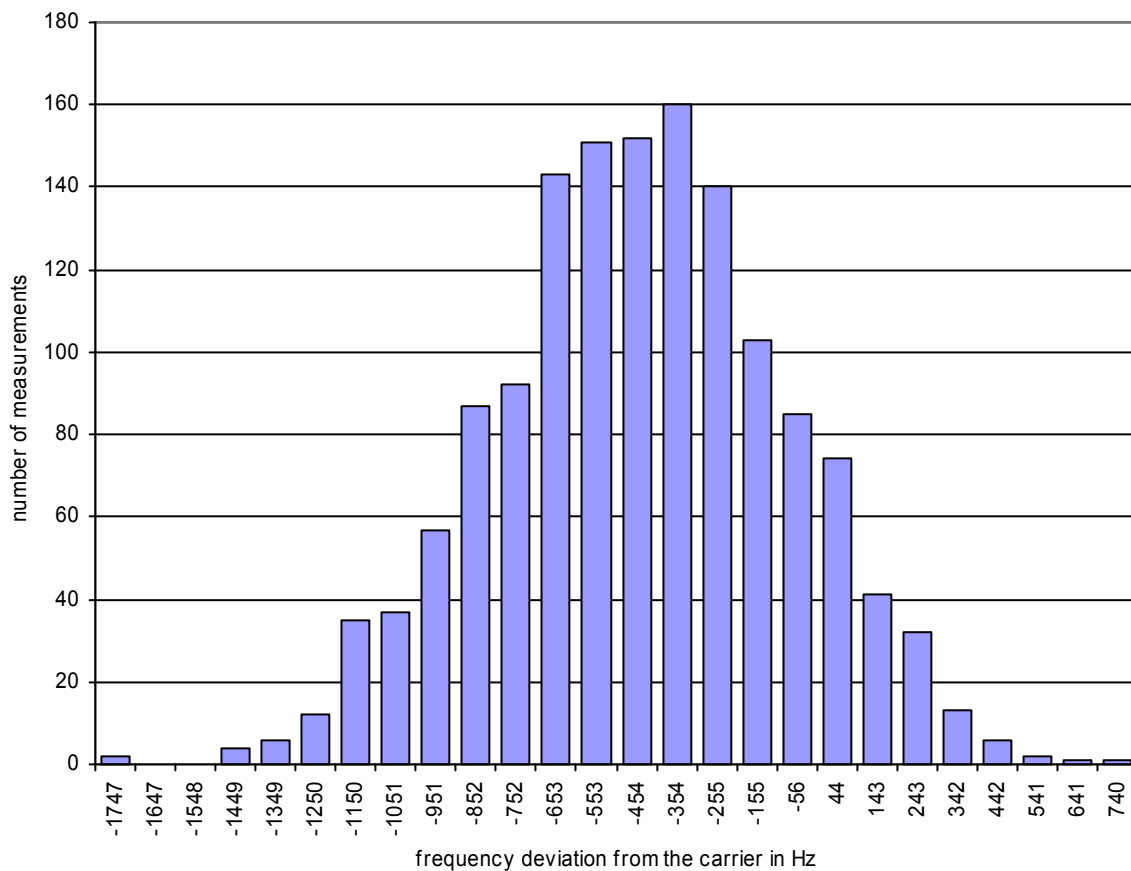

## FCC Part 15.323 Frequency Stability

### Testprocedure ANSI 63.17

EUT	DECT base station
Model	Jabra PRO 9x0
Applicant	GN Netcom A/S
Test Site / Operator	Eurofins Product Service GmbH
Test Specification	Frequency stability

Temperature	50 °C
Power supply	Vnom
Frequency of carrier	1924,991594 MHz
Measured mean	1924,986774 MHz
Stability (supply temp)	-2,50 ppm
Result	Verdict = PASS
Stability over time	fmax : 0,85 ppm fmin : 0,71 ppm
Result	Verdict = PASS

Histogram

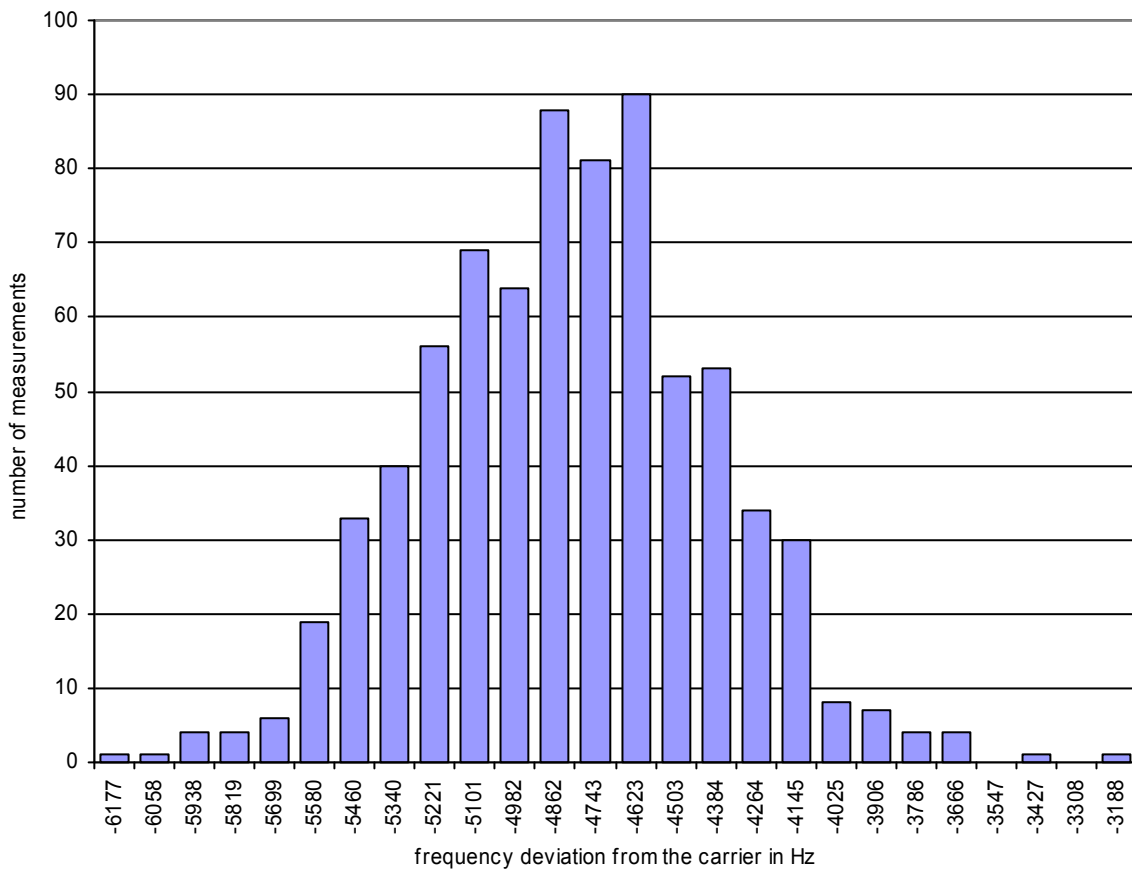

## FCC Part 15.323 Frequency Stability

### Testprocedure ANSI 63.17

EUT	DECT base station
Model	Jabra PRO 9x0
Applicant	GN Netcom A/S
Test Site / Operator	Eurofins Product Service GmbH
Test Specification	Frequency stability

Temperature	20 °C
Power supply	Vmin
Frequency of carrier	1924,991594MHz
Measured mean	1924,990611 MHz
Stability (supply temp)	0,28 ppm
Result	Verdict = PASS
Stability over time	fmax : 0,71 ppm fmin : 0,55 ppm
Result	Verdict = PASS

Histogram

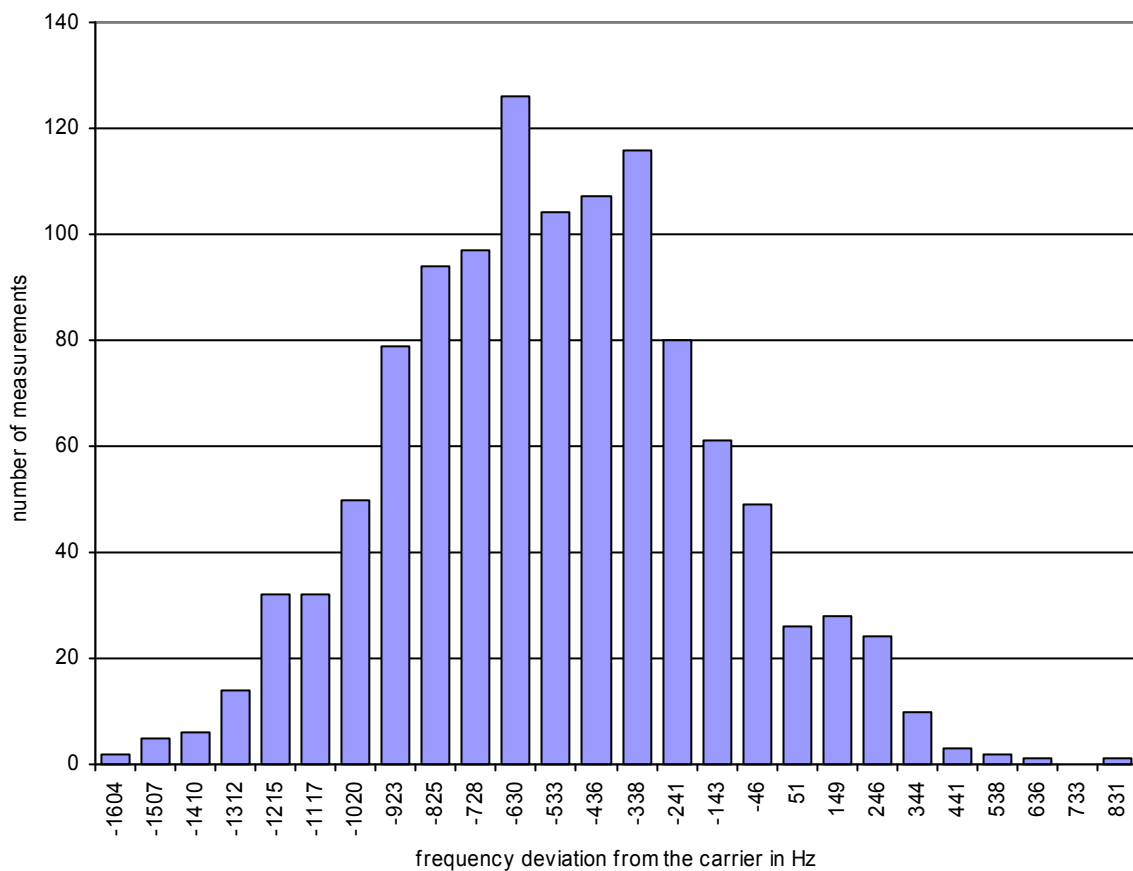

## FCC Part 15.323 Frequency Stability

### Testprocedure ANSI 63.17

EUT	DECT base station
Model	Jabra PRO 9x0
Applicant	GN Netcom A/S
Test Site / Operator	Eurofins Product Service GmbH
Test Specification	Frequency stability

Temperature	20 °C
Power supply	Vmax
Frequency of carrier	1924,991594MHz
Measured mean	1924,990572 MHz
Stability (supply temp)	0,30 ppm
Result	Verdict = PASS
Stability over time	fmax : 0,60 ppm fmin : 0,62 ppm
Result	Verdict = PASS

Histogram

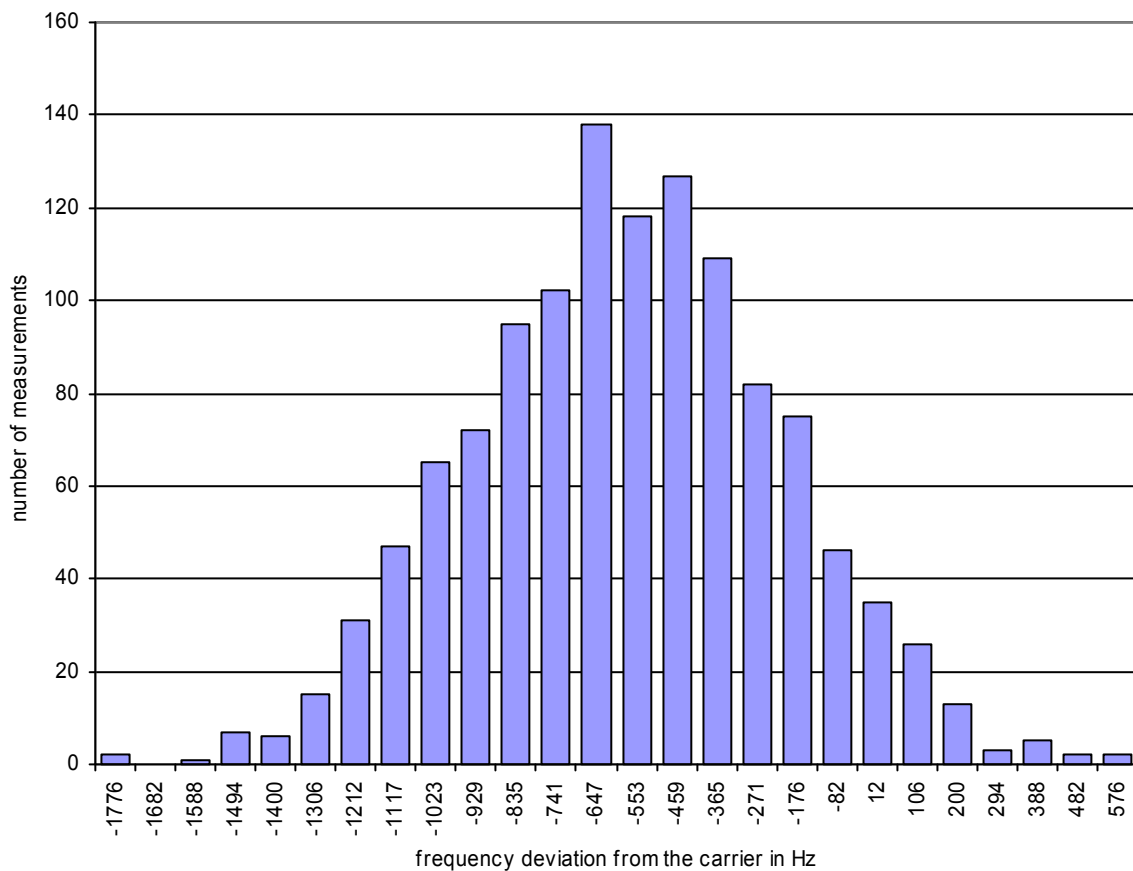



## **Annex M      Transmitter radiated spurious emissions**

# Radiated spurious emissions under normal conditions

## FCC RULES PART 15.209

Approval Holder: GN Netcom A/S / GOM-1104-1092  
EUT / Model: UPCS BaseStation / WHB003BS  
FP / CH 0: 1928.448MHz / Ant: 1 / vertical  
Test Site / Operator: Eurofins Product Service GmbH / Mr. Pudell  
Test Condition: Tnom.: 24°C / Unom: 7.5 V DC ( Ext. Power Supply )  
Test Specification: Anechoic chamber / mode: Tx  
Comment 1: Dist.: 3m, Ant.: HK 116  
Comment 2: Freq.: 197.956MHz, Emax: 33.29dBµV/m, RBW: 100kHz

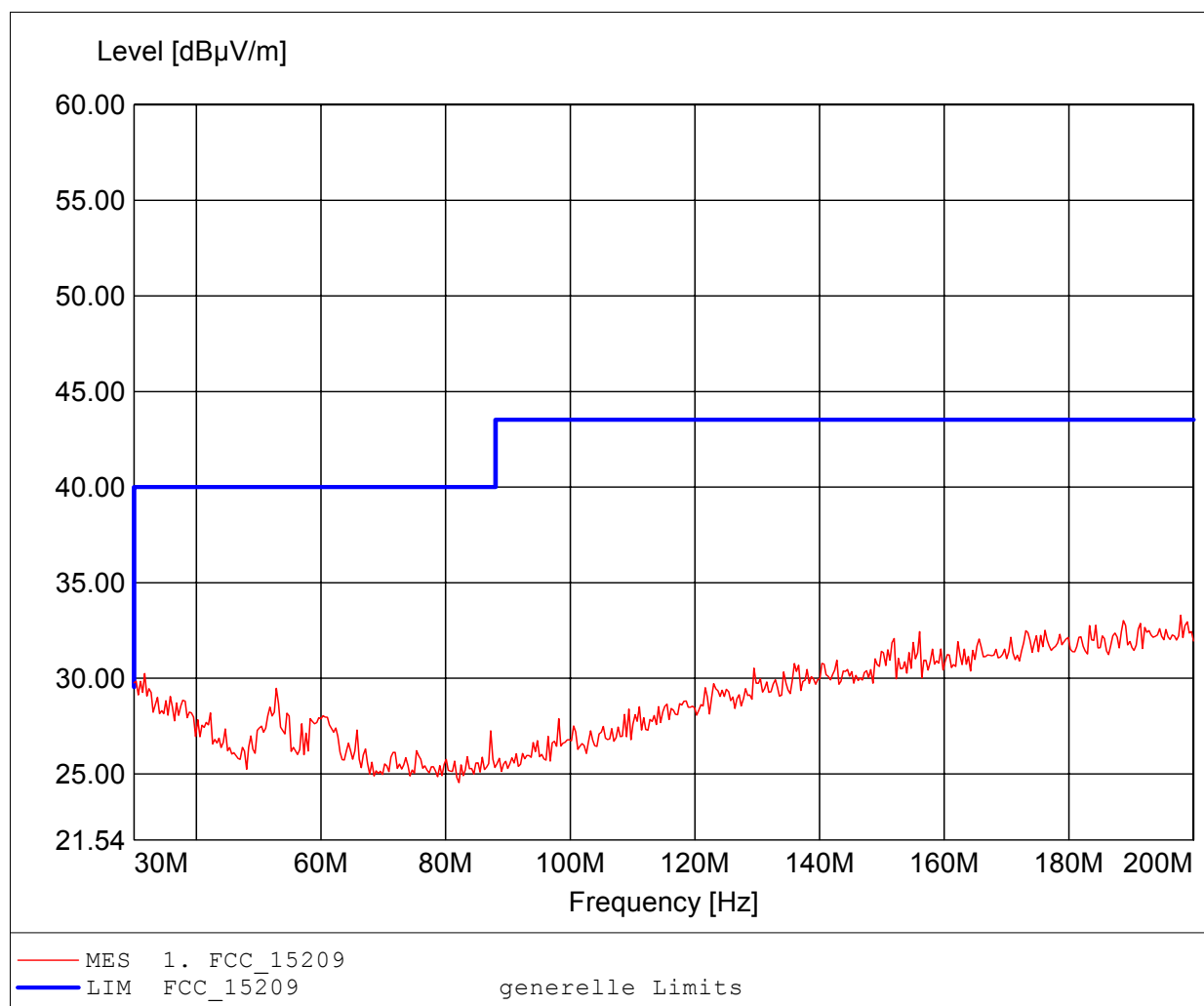

# Radiated spurious emissions under normal conditions

## FCC RULES PART 15.209

Approval Holder: GN Netcom A/S / GOM-1104-1092  
EUT / Model: UPCS BaseStation / WHB003BS  
FP / CH 0: 1928.448MHz / Ant: 1 / vertical  
Test Site / Operator: Eurofins Product Service GmbH / Mr. Pudell  
Test Condition: Tnom.: 24°C / Unom: 7.5 V DC ( Ext. Power Supply )  
Test Specification: Anechoic chamber / mode: Tx  
Comment 1: Dist.: 3m, Ant.: HK 116  
Comment 2: Freq.: 193.527MHz, Emax: 33.67dBµV/m, RBW: 100kHz

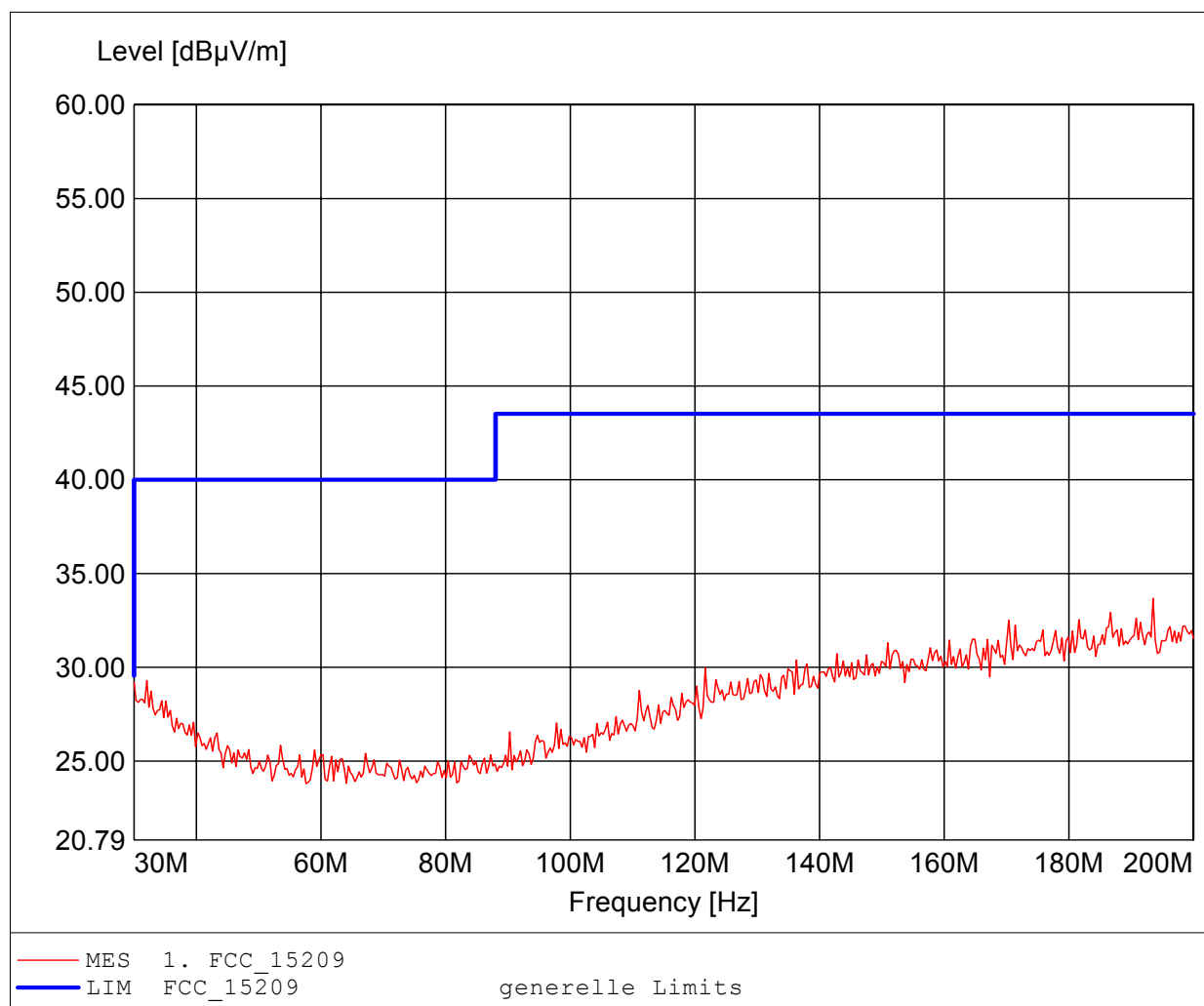

**Radiated spurious emissions under normal conditions**

**FCC RULES PART 15.209**

Approval Holder: GN Netcom A/S / GOM-1104-1092  
 EUT / Model: UPCS BaseStation / WHB003BS  
 FP / CH 0: 1928.448MHz / Ant: 1 / vertical  
 Test Site / Operator: Eurofins Product Service GmbH / Mr. Pudell  
 Test Condition: Tnom.: 24°C / Unom: 7.5 V DC ( Ext. Power Supply )  
 Test Specification: Anechoic chamber / mode: Tx  
 Comment 1: Dist.: 3m, Ant.: HL 223, ampl.  
 Comment 2: Freq.: 996.794MHz, Emax: 31.74dBµV/m, RBW: 100kHz

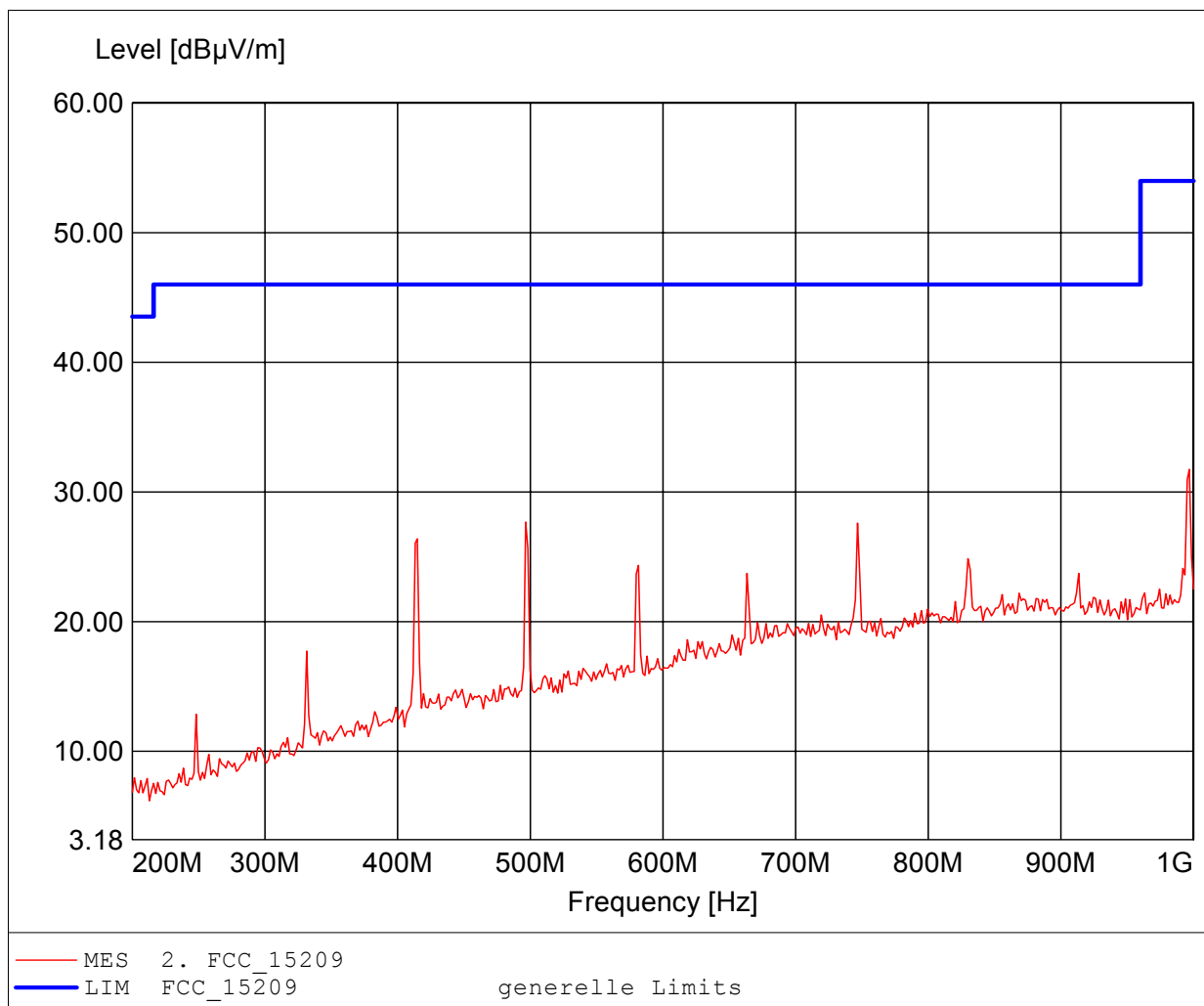

**Radiated spurious emissions under normal conditions**

**FCC RULES PART 15.209**

Approval Holder: GN Netcom A/S / GOM-1104-1092  
EUT / Model: UPCS BaseStation / WHB003BS  
FP / CH 0: 1928.448MHz / Ant: 1 / vertical  
Test Site / Operator: Eurofins Product Service GmbH / Mr. Pudell  
Test Condition: Tnom.: 24°C / Unom: 7.5 V DC ( Ext. Power Supply )  
Test Specification: Anechoic chamber / mode: Tx  
Comment 1: Dist.: 3m, Ant.: HL 223, ampl.  
Comment 2: Freq.: 995.190MHz, Emax: 36.44dBµV/m, RBW: 100kHz

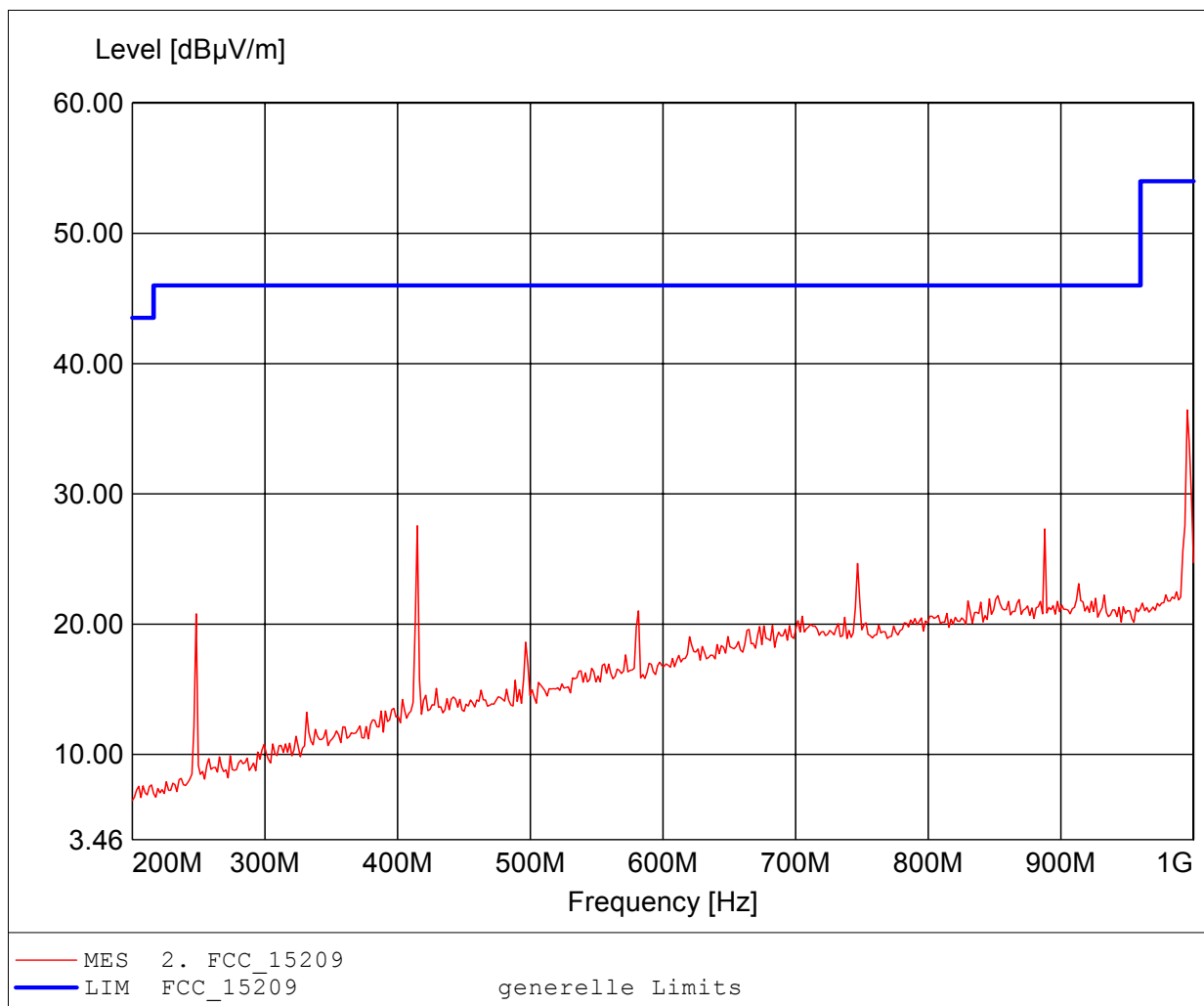

# Radiated spurious emissions under normal conditions

## FCC RULES PART 15.209

Approval Holder: GN Netcom A/S / GOM-1104-1092  
EUT / Model: UPCS BaseStation / WHB003BS  
FP / CH 0: 1928.448MHz / Ant: 1 / vertical  
Test Site / Operator: Eurofins Product Service GmbH / Mr. Pudell  
Test Condition: Tnom.: 24°C / Unom: 7.5 V DC ( Ext. Power Supply )  
Test Specification: Anechoic chamber / mode: Tx  
Comment 1: Dist.: 3m, Ant.: BBHA 9120D, HP+ampl.  
Comment 2: Freq.: 3.862GHz, Emax: 57.71dBuV/m, RBW: 1MHz

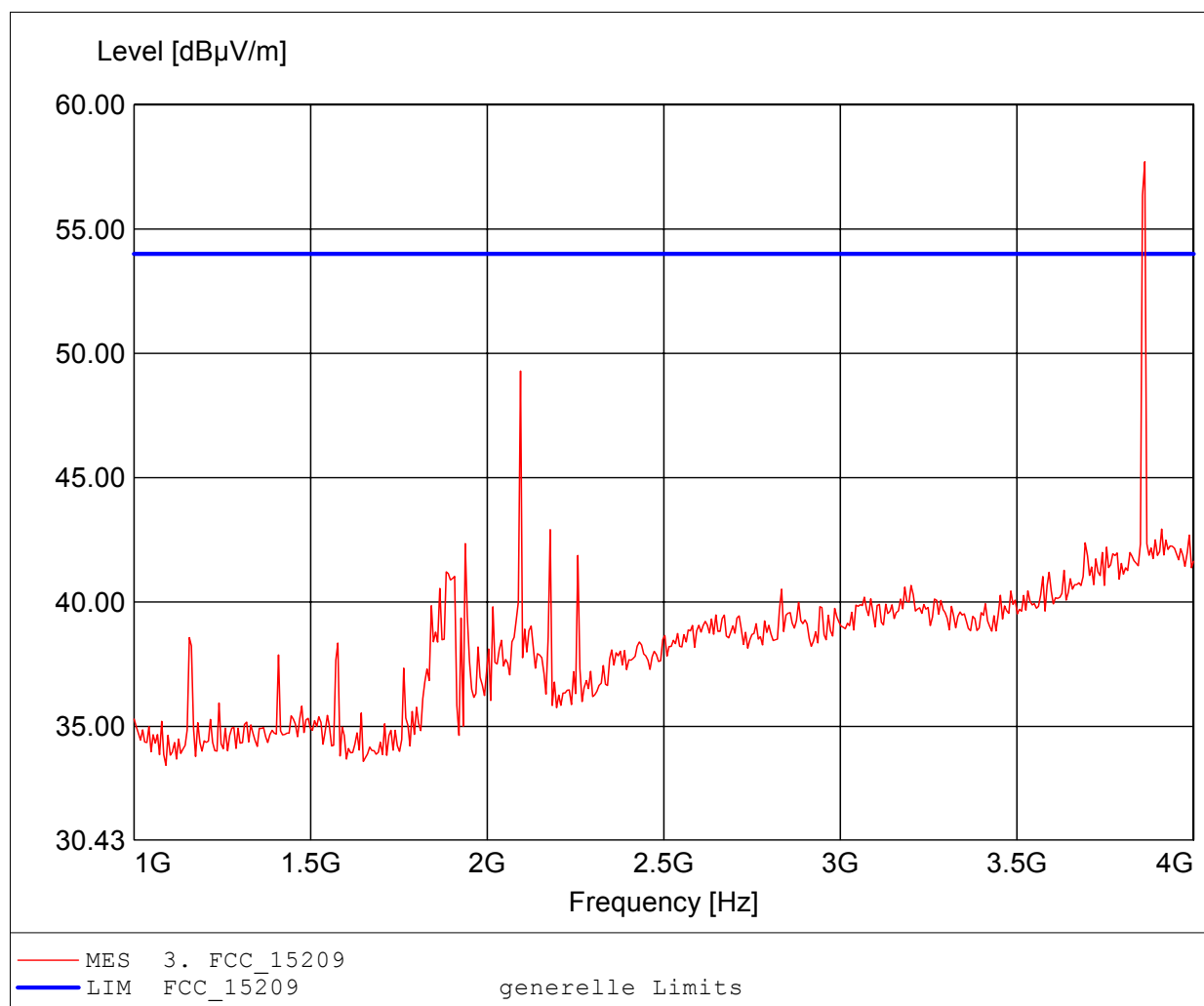

# Harmonics, Radiated

## FCC RULES PART 15.209

Approval Holder: GN Netcom A/S / GOM-1104-1092  
EUT / Model: UPCS BaseStation / WHB003BS  
FP / CH 0: 1928.448MHz / Ant: 1 / vertical  
Test Site / Operator: Eurofins Product Service GmbH / Mr. Pudell  
Test Condition: Tnom.: 24°C / Unom: 7.5 V DC ( Ext. Power Supply )  
Test Specification: Anechoic chamber / mode: Tx  
Comment 1: Dist.: 3m, Ant.: BBHA 9120D, HP+ampl., AV-Detector  
Comment 2: Freq.: 3.857GHz, Emax: 44.63dBuV/m, RBW: 1MHz

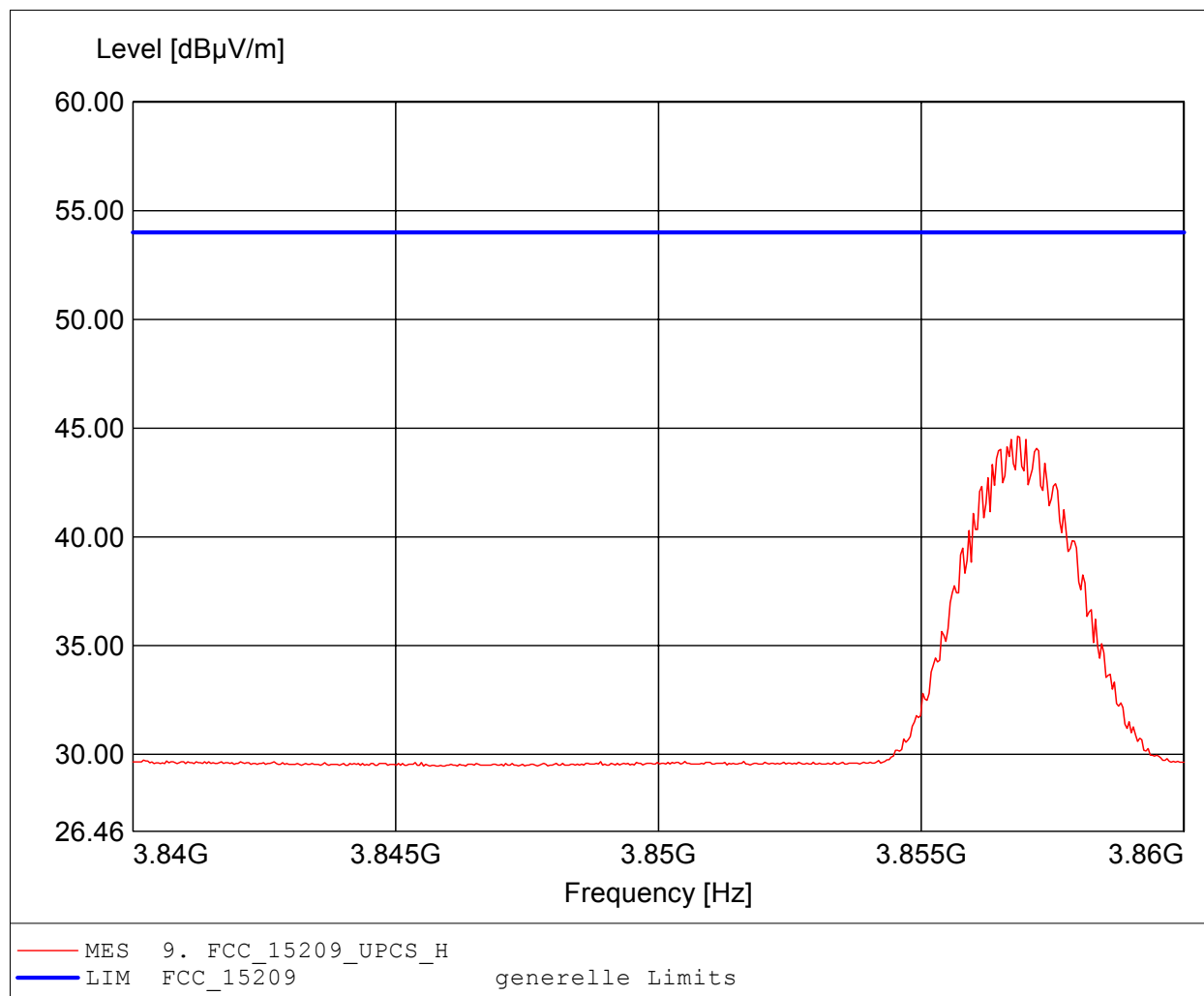

**Radiated spurious emissions under normal conditions**

**FCC RULES PART 15.209**

Approval Holder: GN Netcom A/S / GOM-1104-1092  
EUT / Model: UPCS BaseStation / WHB003BS  
FP / CH 0: 1928.448MHz / Ant: 1 / vertical  
Test Site / Operator: Eurofins Product Service GmbH / Mr. Pudell  
Test Condition: Tnom.: 24°C / Unom: 7.5 V DC ( Ext. Power Supply )  
Test Specification: Anechoic chamber / mode: Tx  
Comment 1: Dist.: 3m, Ant.: BBHA 9120D, HP+ampl.  
Comment 2: Freq.: 3.862GHz, Emax: 52.91dBuV/m, RBW: 1MHz

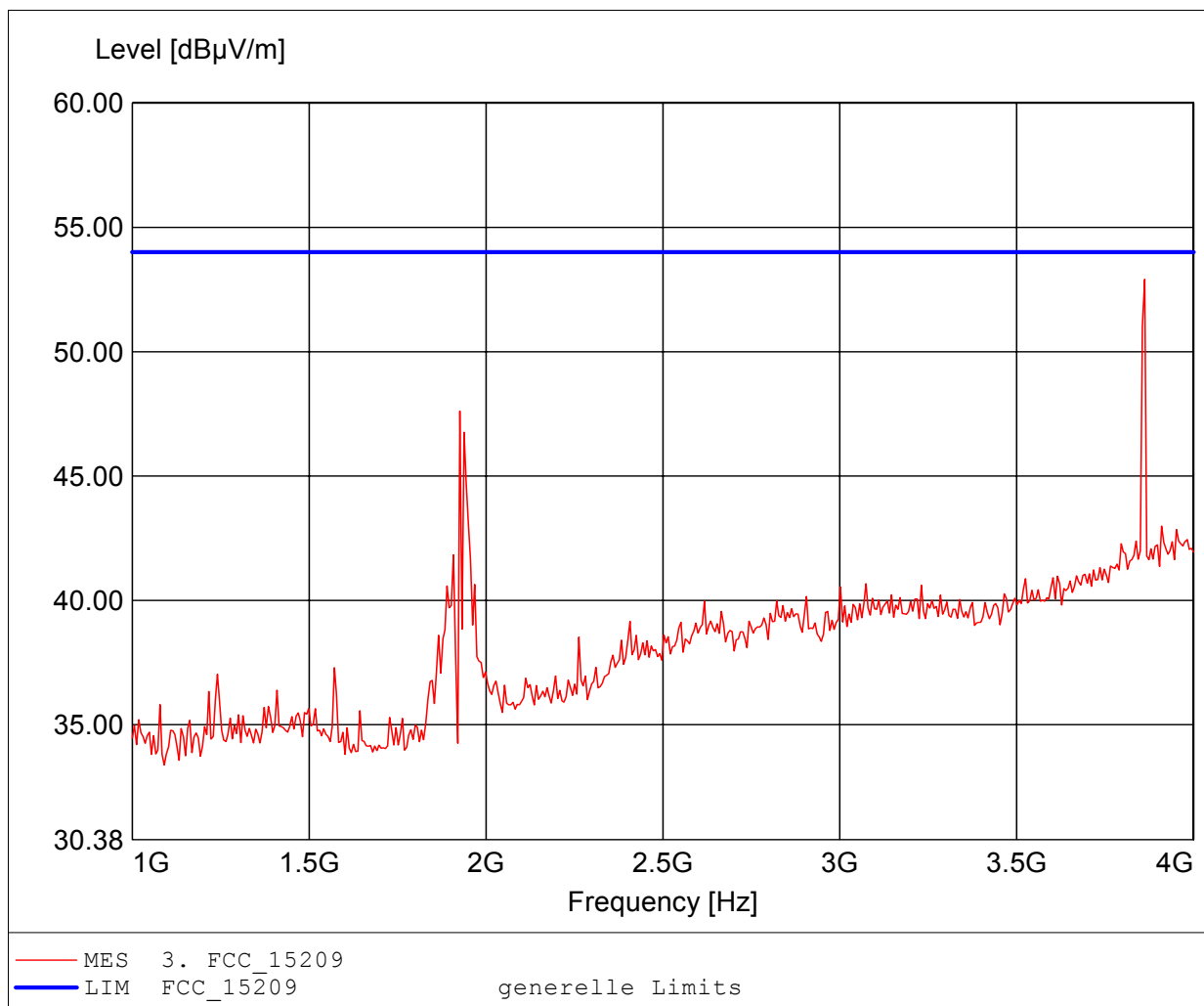



# Harmonics, Radiated

## FCC RULES PART 15.209

Approval Holder: GN Netcom A/S / GOM-1104-1092  
EUT / Model: UPCS BaseStation / WHB003BS  
FP / CH 0: 1928.448MHz / Ant: 1 / vertical  
Test Site / Operator: Eurofins Product Service GmbH / Mr. Pudell  
Test Condition: Tnom.: 24°C / Unom: 7.5 V DC ( Ext. Power Supply )  
Test Specification: Anechoic chamber / mode: Tx  
Comment 1: Dist.: 3m, Ant.: BBHA 9120D, HP+ampl., AV-Detector  
Comment 2: Freq.: 3.857GHz, Emax: 41.42dBuV/m, RBW: 1MHz

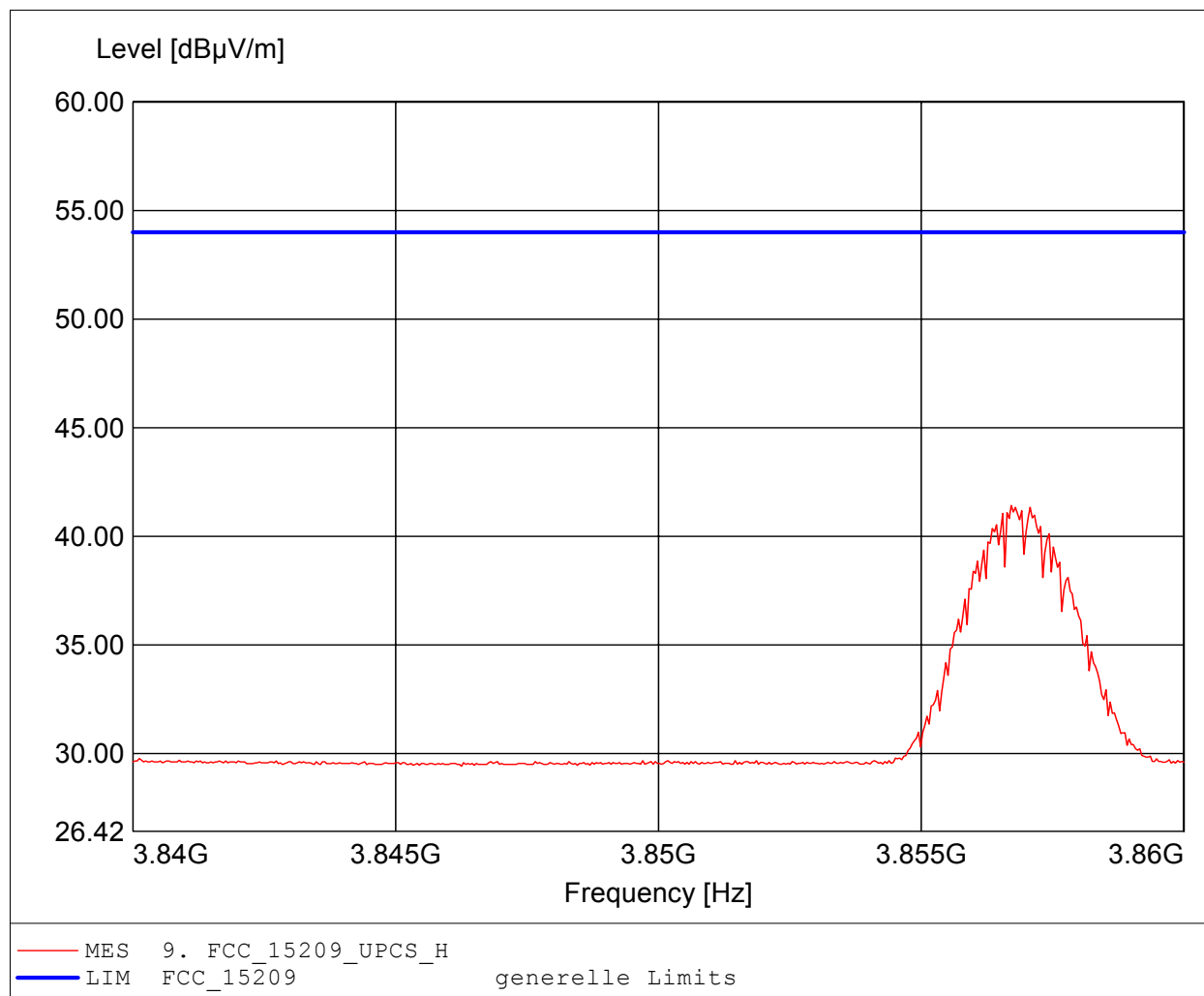

**Radiated spurious emissions under normal conditions**

**FCC RULES PART 15.209**

Approval Holder: GN Netcom A/S / GOM-1104-1092  
EUT / Model: UPCS BaseStation / WHB003BS  
FP / CH 0: 1928.448MHz / Ant: 1 / vertical  
Test Site / Operator: Eurofins Product Service GmbH / Mr. Pudell  
Test Condition: Tnom.: 24°C / Unom: 7.5 V DC ( Ext. Power Supply )  
Test Specification: Anechoic chamber / mode: Tx  
Comment 1: Dist.: 3m, Ant.: BBHA 9120D, HP+ampl.  
Comment 2: Freq.: 7.719GHz, Emax: 60.89dBuV/m, RBW: 1MHz

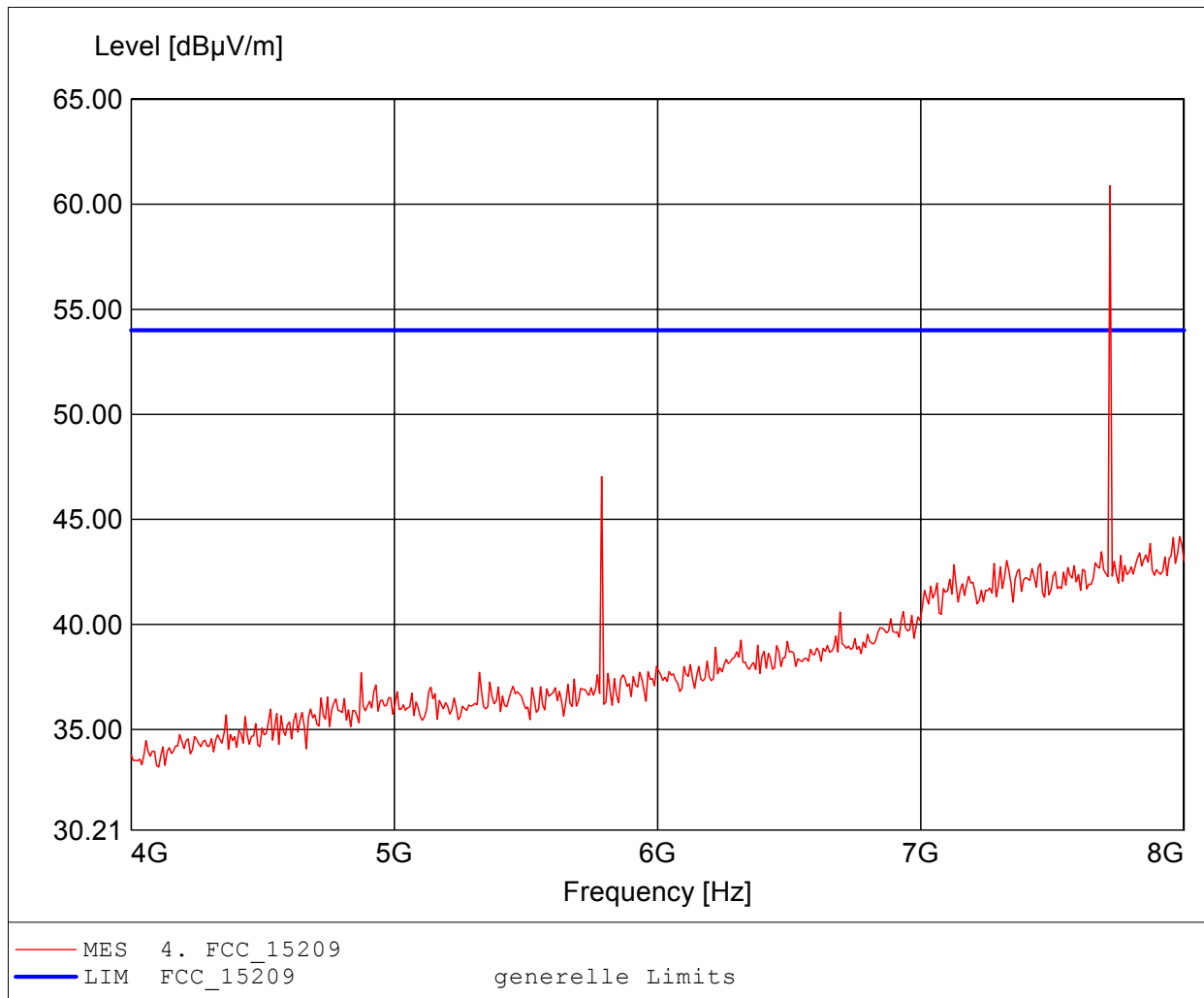

# Harmonics, Radiated

## FCC RULES PART 15.209

Approval Holder: GN Netcom A/S / GOM-1104-1092  
EUT / Model: UPCS BaseStation / WHB003BS  
FP / CH 0: 1928.448MHz / Ant: 1 / vertical  
Test Site / Operator: Eurofins Product Service GmbH / Mr. Pudell  
Test Condition: Tnom.: 24°C / Unom: 7.5 V DC ( Ext. Power Supply )  
Test Specification: Anechoic chamber / mode: Tx  
Comment 1: Dist.: 3m, Ant.: BBHA 9120D, HP+ampl., AV-Detector  
Comment 2: Freq.: 7.713GHz, Emax: 42.36dBuV/m, RBW: 1MHz

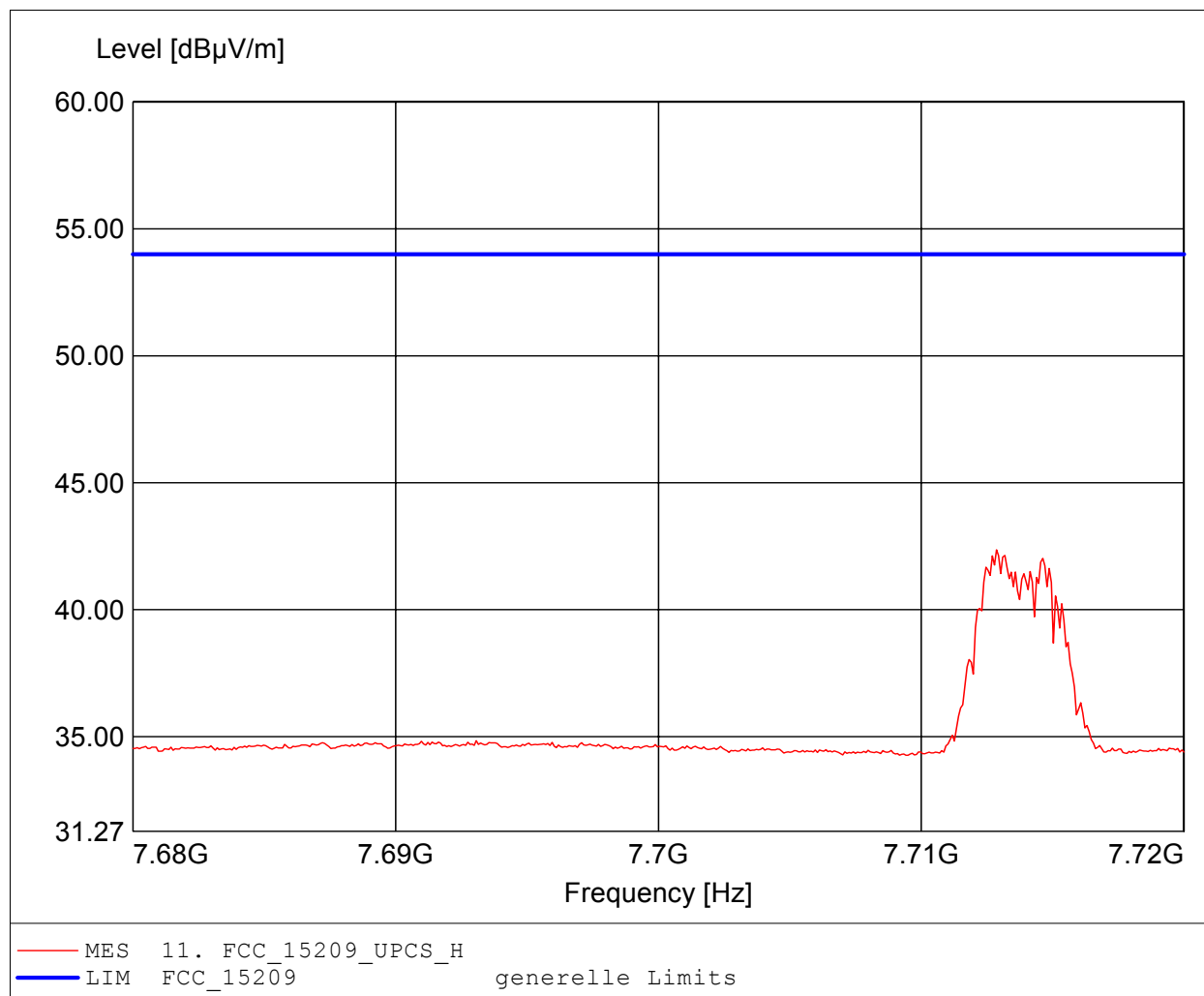

# Radiated spurious emissions under normal conditions

## FCC RULES PART 15.209

Approval Holder: GN Netcom A/S / GOM-1104-1092  
EUT / Model: UPCS BaseStation / WHB003BS  
FP / CH 0: 1928.448MHz / Ant: 1 / vertical  
Test Site / Operator: Eurofins Product Service GmbH / Mr. Pudell  
Test Condition: Tnom.: 24°C / Unom: 7.5 V DC ( Ext. Power Supply )  
Test Specification: Anechoic chamber / mode: Tx  
Comment 1: Dist.: 3m, Ant.: BBHA 9120D, HP+ampl.  
Comment 2: Freq.: 7.719GHz, Emax: 56.59dBuV/m, RBW: 1MHz

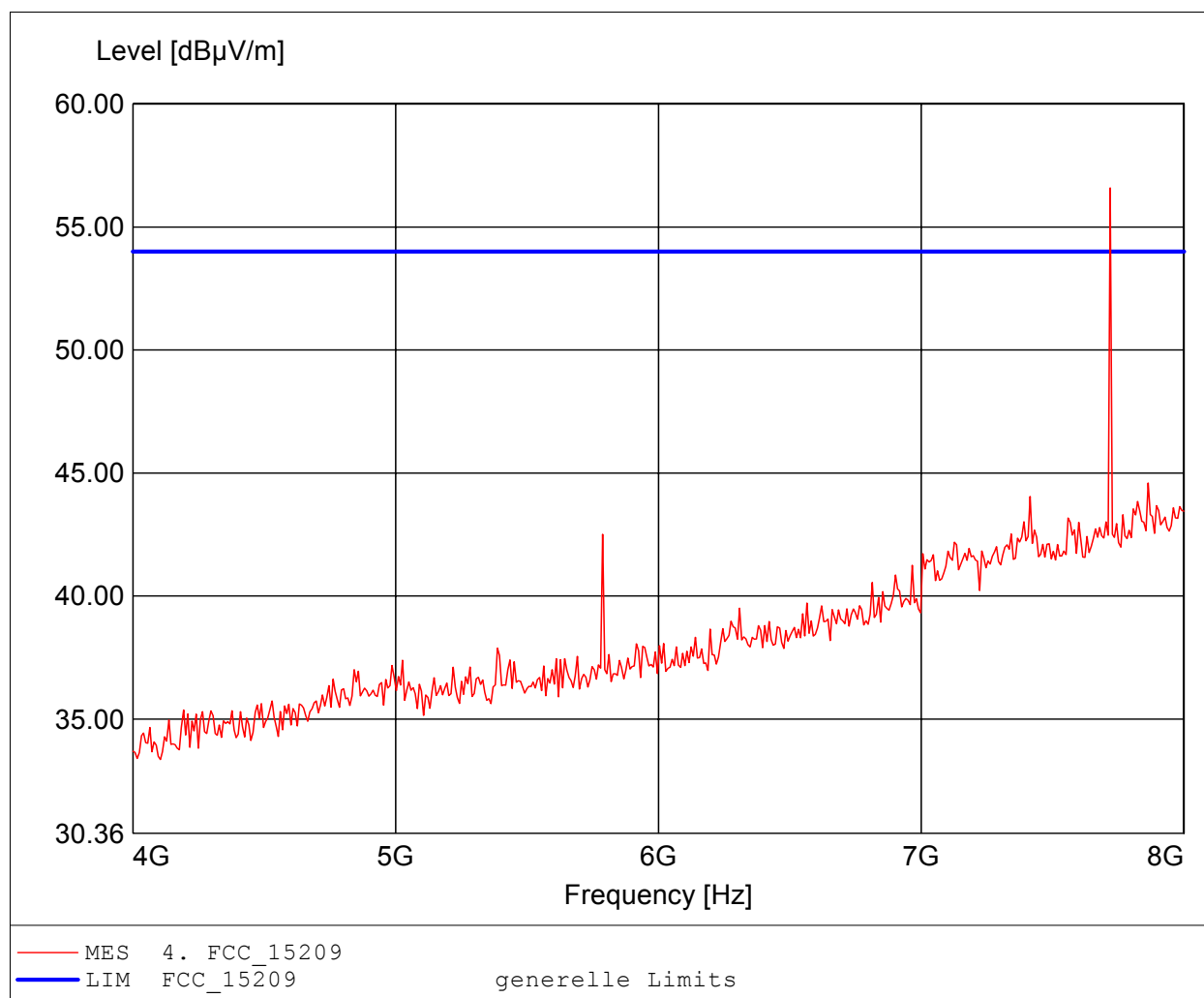

# Harmonics, Radiated

## FCC RULES PART 15.209

Approval Holder: GN Netcom A/S / GOM-1104-1092  
EUT / Model: UPCS BaseStation / WHB003BS  
FP / CH 0: 1928.448MHz / Ant: 1 / vertical  
Test Site / Operator: Eurofins Product Service GmbH / Mr. Pudell  
Test Condition: Tnom.: 24°C / Unom: 7.5 V DC ( Ext. Power Supply )  
Test Specification: Anechoic chamber / mode: Tx  
Comment 1: Dist.: 3m, Ant.: BBHA 9120D, HP+ampl., AV-Detector  
Comment 2: Freq.: 7.713GHz, Emax: 41.01dBuV/m, RBW: 1MHz

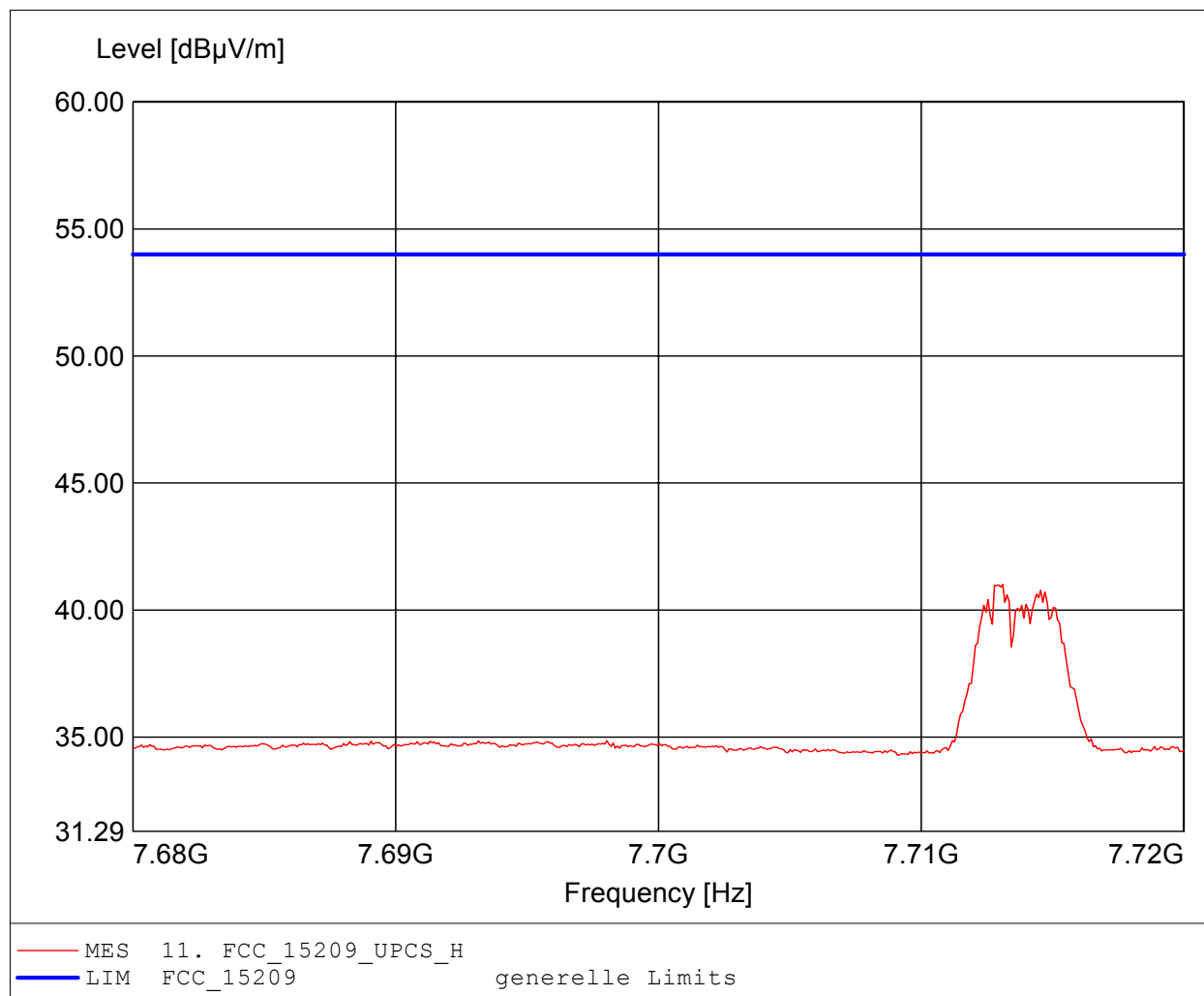

**Radiated spurious emissions under normal conditions**

**FCC RULES PART 15.209**

Approval Holder: GN Netcom A/S / GOM-1104-1092  
EUT / Model: UPCS BaseStation / WHB003BS  
FP / CH 0: 1928.448MHz / Ant: 1 / vertical  
Test Site / Operator: Eurofins Product Service GmbH / Mr. Pudell  
Test Condition: Tnom.: 24°C / Unom: 7.5 V DC ( Ext. Power Supply )  
Test Specification: Anechoic chamber / mode: Tx  
Comment 1: Dist.: 3m, Ant.: BBHA 9120D, HP+ampl.  
Comment 2: Freq.: 11.575GHz, Emax: 42.97dBµV/m, RBW: 1MHz

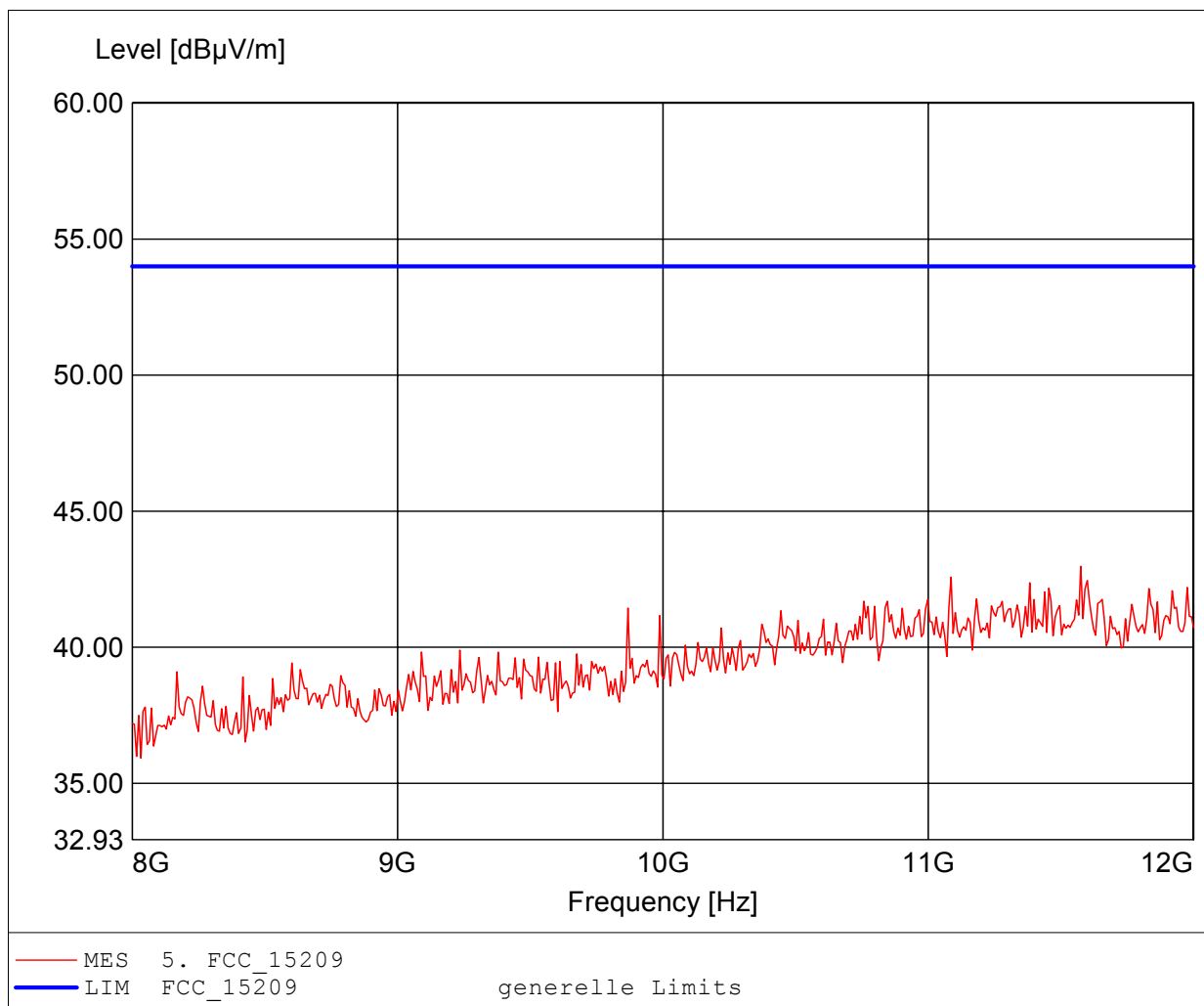

# Radiated spurious emissions under normal conditions

## FCC RULES PART 15.209

Approval Holder: GN Netcom A/S / GOM-1104-1092  
EUT / Model: UPCS BaseStation / WHB003BS  
FP / CH 0: 1928.448MHz / Ant: 1 / vertical  
Test Site / Operator: Eurofins Product Service GmbH / Mr. Pudell  
Test Condition: Tnom.: 24°C / Unom: 7.5 V DC ( Ext. Power Supply )  
Test Specification: Anechoic chamber / mode: Tx  
Comment 1: Dist.: 3m, Ant.: BBHA 9120D, HP+ampl.  
Comment 2: Freq.: 11.006GHz, Emax: 42.65dBµV/m, RBW: 1MHz

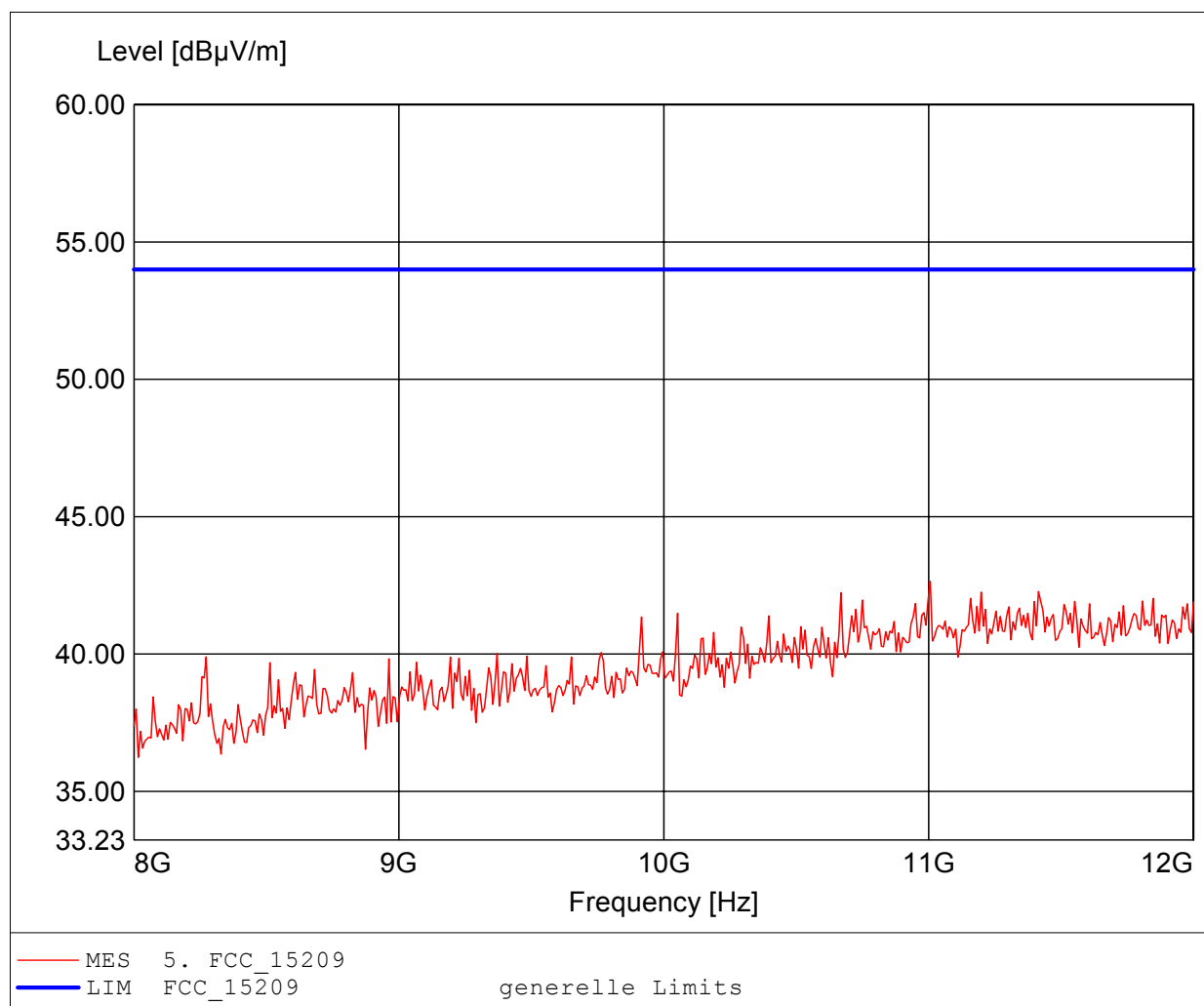

**Radiated spurious emissions under normal conditions**

**FCC RULES PART 15.209**

Approval Holder: GN Netcom A/S / GOM-1104-1092  
EUT / Model: UPCS BaseStation / WHB003BS  
FP / CH 0: 1928.448MHz / Ant: 1 / vertical  
Test Site / Operator: Eurofins Product Service GmbH / Mr. Pudell  
Test Condition: Tnom.: 24°C / Unom: 7.5 V DC ( Ext. Power Supply )  
Test Specification: Anechoic chamber / mode: Tx  
Comment 1: Dist.: 3m, Ant.: BBHA 9120D, HP+ampl.  
Comment 2: Freq.: 17.988GHz, Emax: 51.35dBµV/m, RBW: 1MHz

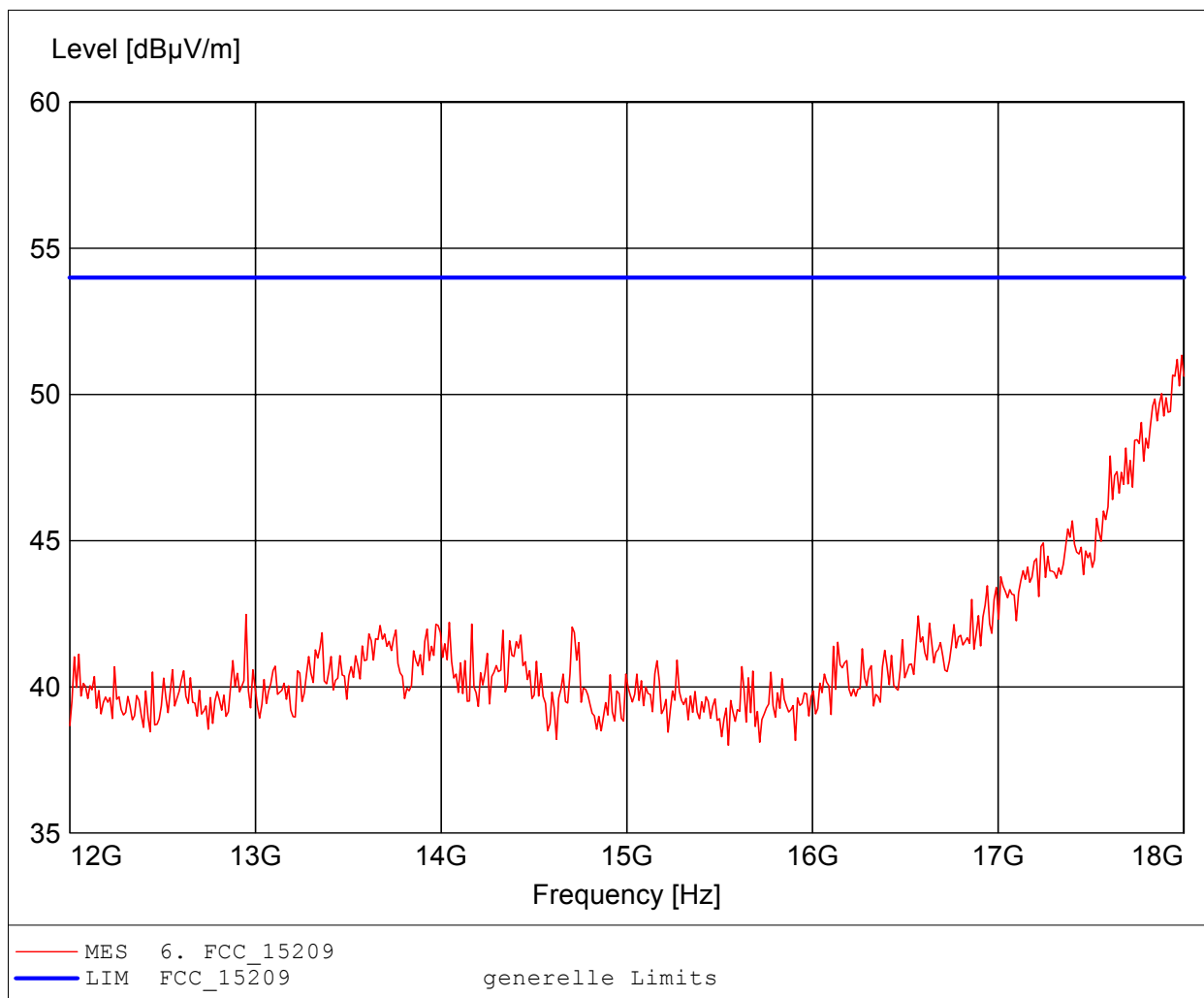



**Radiated spurious emissions under normal conditions**

**FCC RULES PART 15.209**

Approval Holder: GN Netcom A/S / GOM-1104-1092  
EUT / Model: UPCS BaseStation / WHB003BS  
FP / CH 0: 1928.448MHz / Ant: 1 / vertical  
Test Site / Operator: Eurofins Product Service GmbH / Mr. Pudell  
Test Condition: Tnom.: 24°C / Unom: 7.5 V DC ( Ext. Power Supply )  
Test Specification: Anechoic chamber / mode: Tx  
Comment 1: Dist.: 3m, Ant.: BBHA 9120D, HP+ampl.  
Comment 2: Freq.: 18.000GHz, Emax: 51.89dBµV/m, RBW: 1MHz

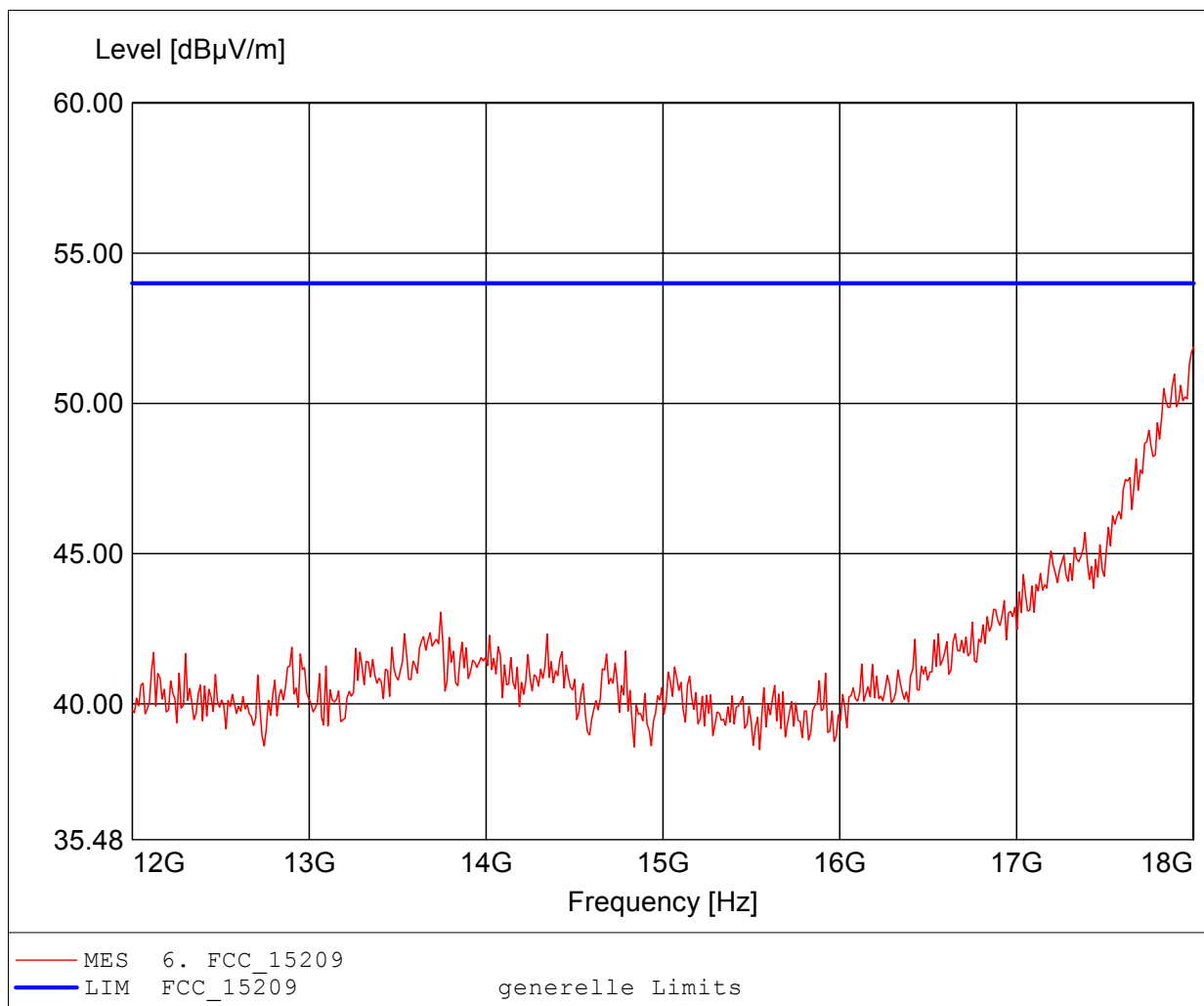

**Radiated spurious emissions under normal conditions**

**FCC RULES PART 15.209**

Approval Holder: GN Netcom A/S / GOM-1104-1092  
EUT / Model: UPCS BaseStation / WHB003BS  
FP / CH 0: 1928.448MHz / Ant: 1 / vertical  
Test Site / Operator: Eurofins Product Service GmbH / Mr. Pudell  
Test Condition: Tnom.: 24°C / Unom: 7.5 V DC ( Ext. Power Supply )  
Test Specification: Anechoic chamber / mode: Tx  
Comment 1: Dist.: 3m, Ant.: HL025, ampl.  
Comment 2: Freq.: 24.626GHz, Emax: 49.88dBµV/m, RBW: 1MHz

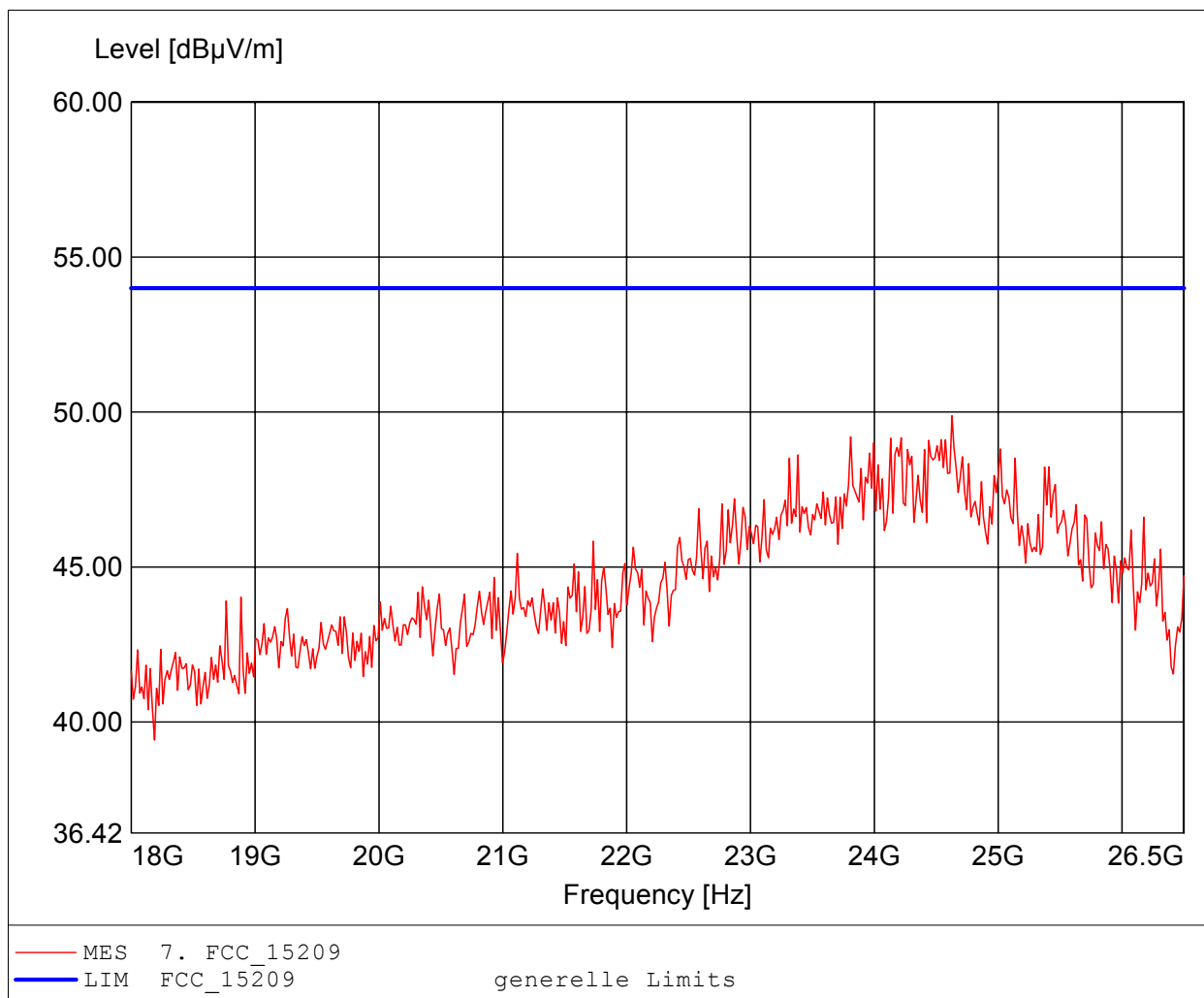

# Radiated spurious emissions under normal conditions

## FCC RULES PART 15.209

Approval Holder: GN Netcom A/S / GOM-1104-1092  
EUT / Model: UPCS BaseStation / WHB003BS  
FP / CH 0: 1928.448MHz / Ant: 1 / vertical  
Test Site / Operator: Eurofins Product Service GmbH / Mr. Pudell  
Test Condition: Tnom.: 24°C / Unom: 7.5 V DC ( Ext. Power Supply )  
Test Specification: Anechoic chamber / mode: Tx  
Comment 1: Dist.: 3m, Ant.: HL025, ampl.  
Comment 2: Freq.: 24.728GHz, Emax: 49.86dBµV/m, RBW: 1MHz

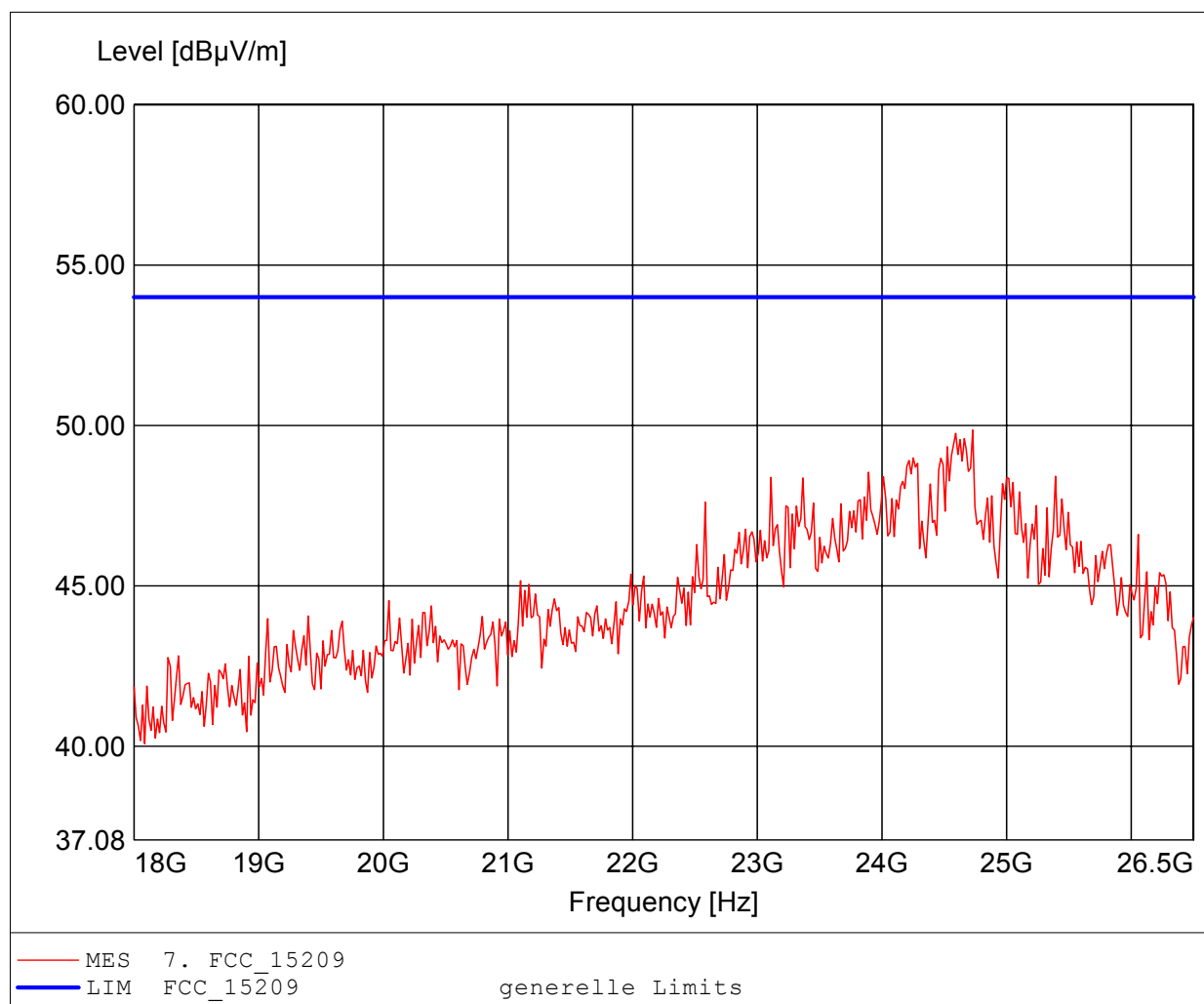

# Radiated spurious emissions under normal conditions

## FCC RULES PART 15.209

Approval Holder: GN Netcom A/S / GOM-1104-1092  
EUT / Model: UPCS BaseStation / WHB003BS  
FP / CH 4: 1921.536MHz / Ant: 1 / vertical  
Test Site / Operator: Eurofins Product Service GmbH / Mr. Pudell  
Test Condition: Tnom.: 24°C / Unom: 7.5 V DC ( Ext. Power Supply )  
Test Specification: Anechoic chamber / mode: Tx  
Comment 1: Dist.: 3m, Ant.: HK 116  
Comment 2: Freq.: 192.505MHz, Emax: 33.64dBµV/m, RBW: 100kHz

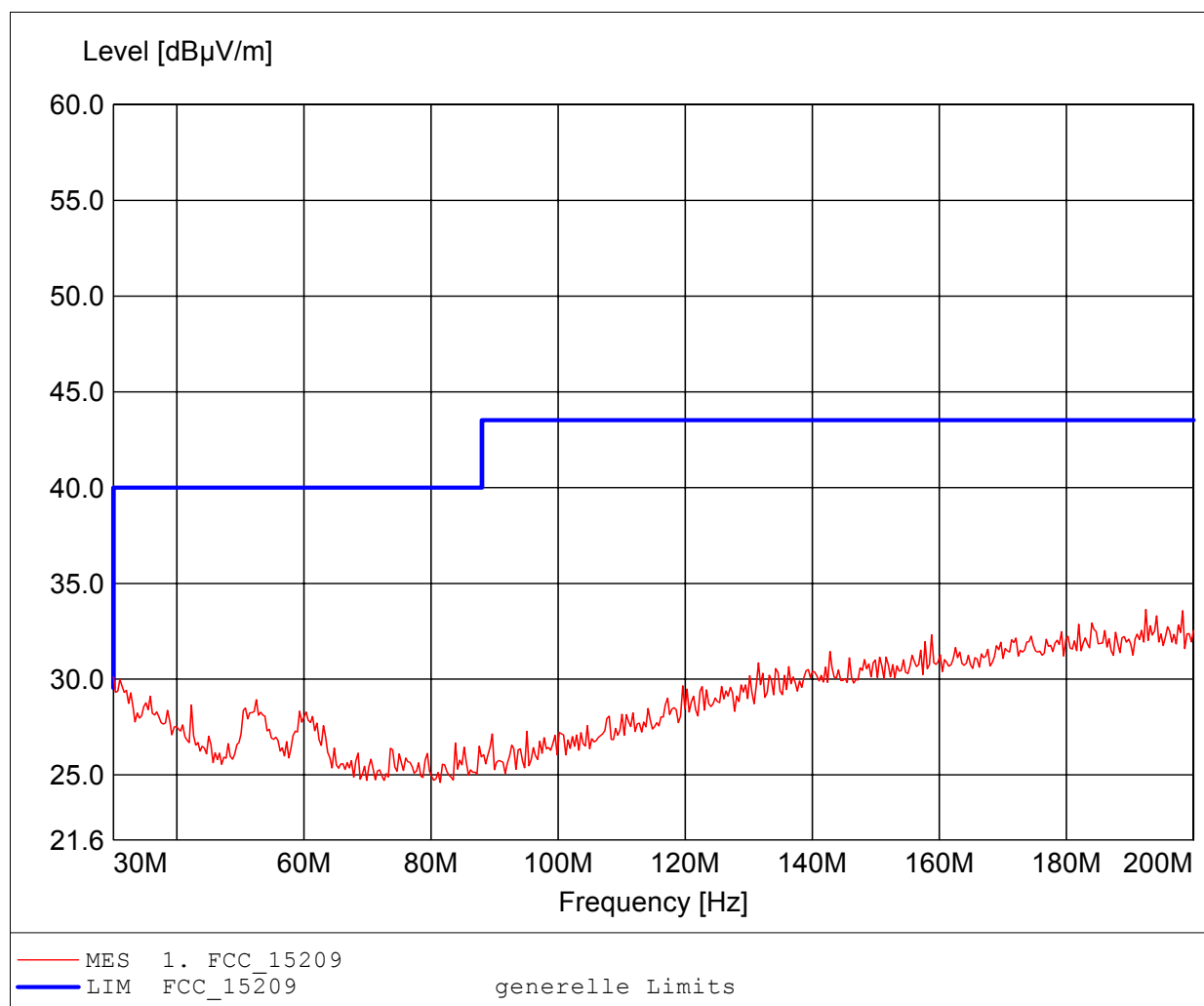

**Radiated spurious emissions under normal conditions**

**FCC RULES PART 15.209**

Approval Holder: GN Netcom A/S / GOM-1104-1092  
 EUT / Model: UPCS BaseStation / WHB003BS  
 FP / CH 4: 1921.536MHz / Ant: 1 / vertical  
 Test Site / Operator: Eurofins Product Service GmbH / Mr. Pudell  
 Test Condition: Tnom.: 24°C / Unom: 7.5 V DC ( Ext. Power Supply )  
 Test Specification: Anechoic chamber / mode: Tx  
 Comment 1: Dist.: 3m, Ant.: HK 116  
 Comment 2: Freq.: 189.098MHz, Emax: 32.88dBµV/m, RBW: 100kHz

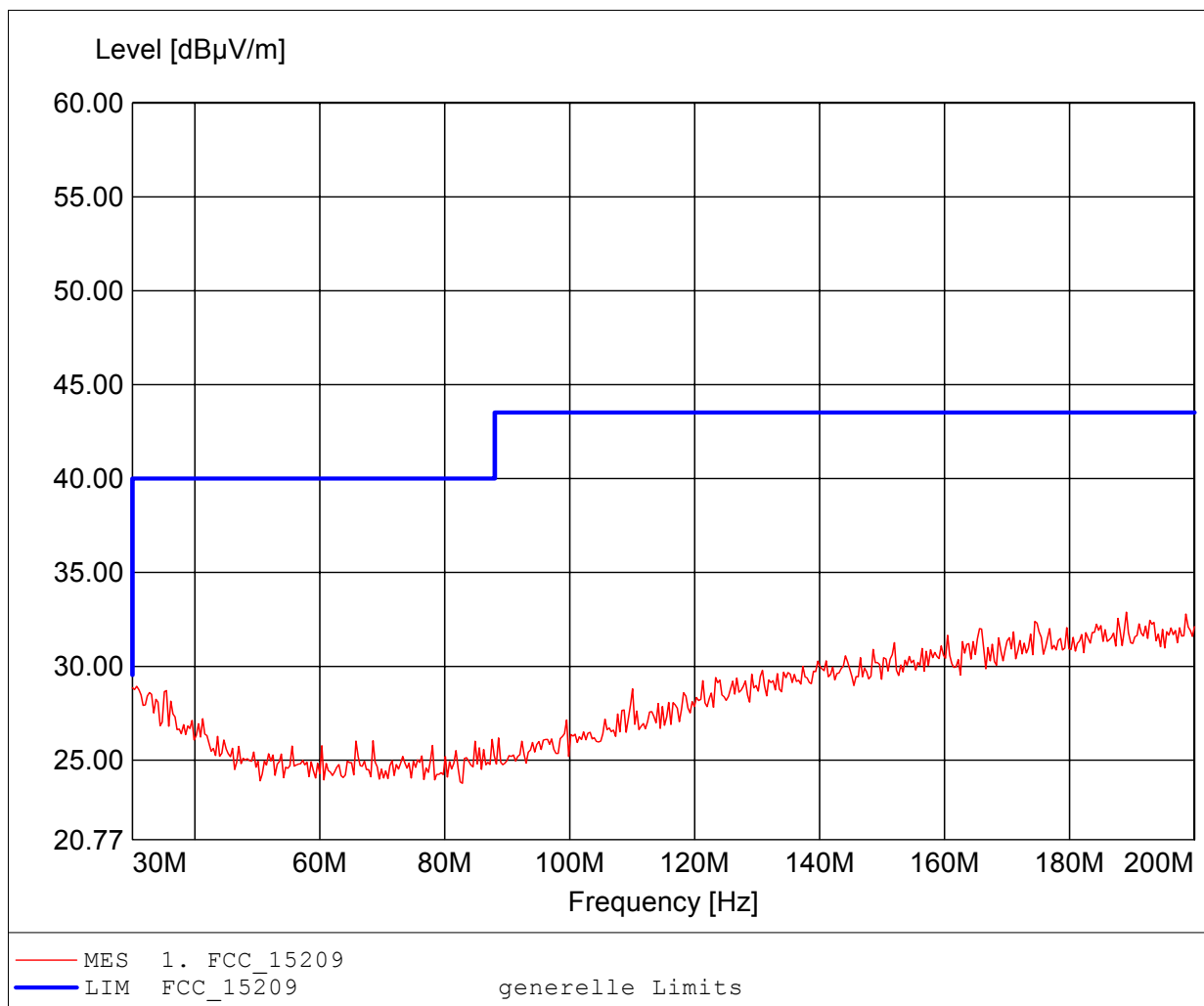

**Radiated spurious emissions under normal conditions**

**FCC RULES PART 15.209**

Approval Holder: GN Netcom A/S / GOM-1104-1092  
EUT / Model: UPCS BaseStation / WHB003BS  
FP / CH 4: 1921.536MHz / Ant: 1 / vertical  
Test Site / Operator: Eurofins Product Service GmbH / Mr. Pudell  
Test Condition: Tnom.: 24°C / Unom: 7.5 V DC ( Ext. Power Supply )  
Test Specification: Anechoic chamber / mode: Tx  
Comment 1: Dist.: 3m, Ant.: HL 223, ampl.  
Comment 2: Freq.: 995.190MHz, Emax: 31.37dBµV/m, RBW: 100kHz

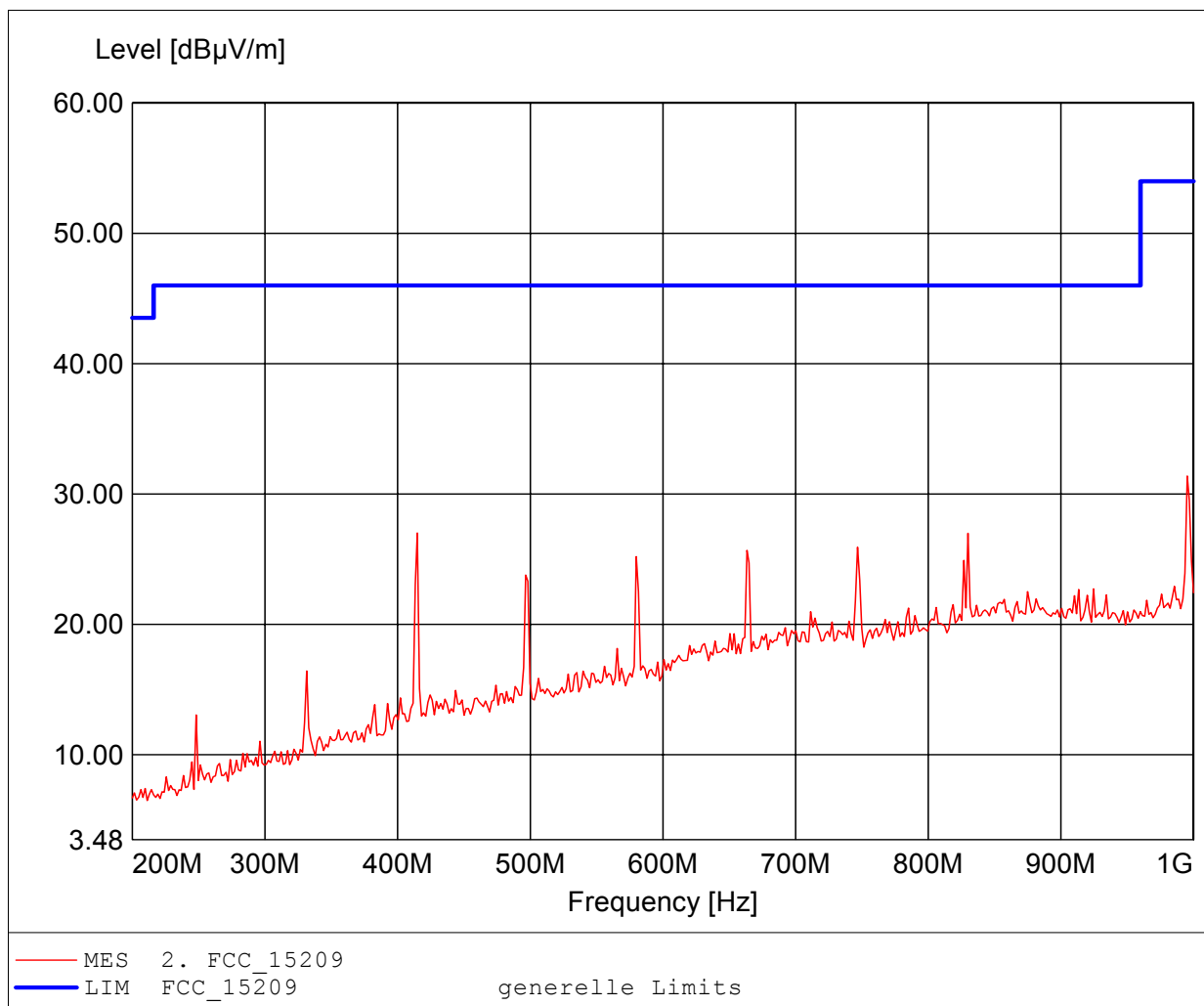

# Radiated spurious emissions under normal conditions

## FCC RULES PART 15.209

Approval Holder: GN Netcom A/S / GOM-1104-1092  
EUT / Model: UPCS BaseStation / WHB003BS  
FP / CH 4: 1921.536MHz / Ant: 1 / vertical  
Test Site / Operator: Eurofins Product Service GmbH / Mr. Pudell  
Test Condition: Tnom.: 24°C / Unom: 7.5 V DC ( Ext. Power Supply )  
Test Specification: Anechoic chamber / mode: Tx  
Comment 1: Dist.: 3m, Ant.: HL 223, ampl.  
Comment 2: Freq.: 996.794MHz, Emax: 34.36dBµV/m, RBW: 100kHz

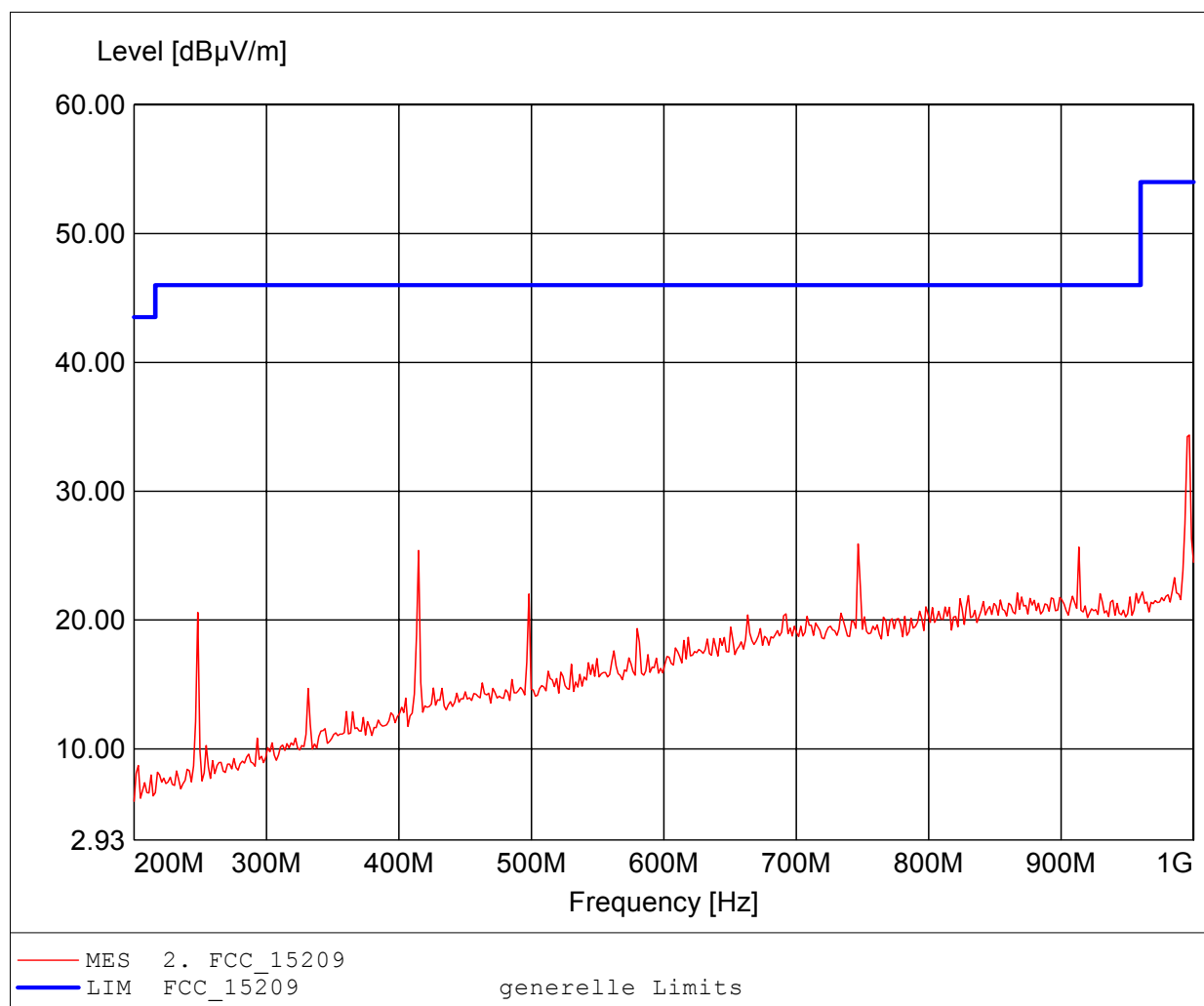

# Radiated spurious emissions under normal conditions

## FCC RULES PART 15.209

Approval Holder: GN Netcom A/S / GOM-1104-1092  
EUT / Model: UPCS BaseStation / WHB003BS  
FP / CH 4: 1921.536MHz / Ant: 1 / vertical  
Test Site / Operator: Eurofins Product Service GmbH / Mr. Pudell  
Test Condition: Tnom.: 24°C / Unom: 7.5 V DC ( Ext. Power Supply )  
Test Specification: Anechoic chamber / mode: Tx  
Comment 1: Dist.: 3m, Ant.: BBHA 9120D, HP+ampl.  
Comment 2: Freq.: 3.844GHz, Emax: 61.01dBμV/m, RBW: 1MHz

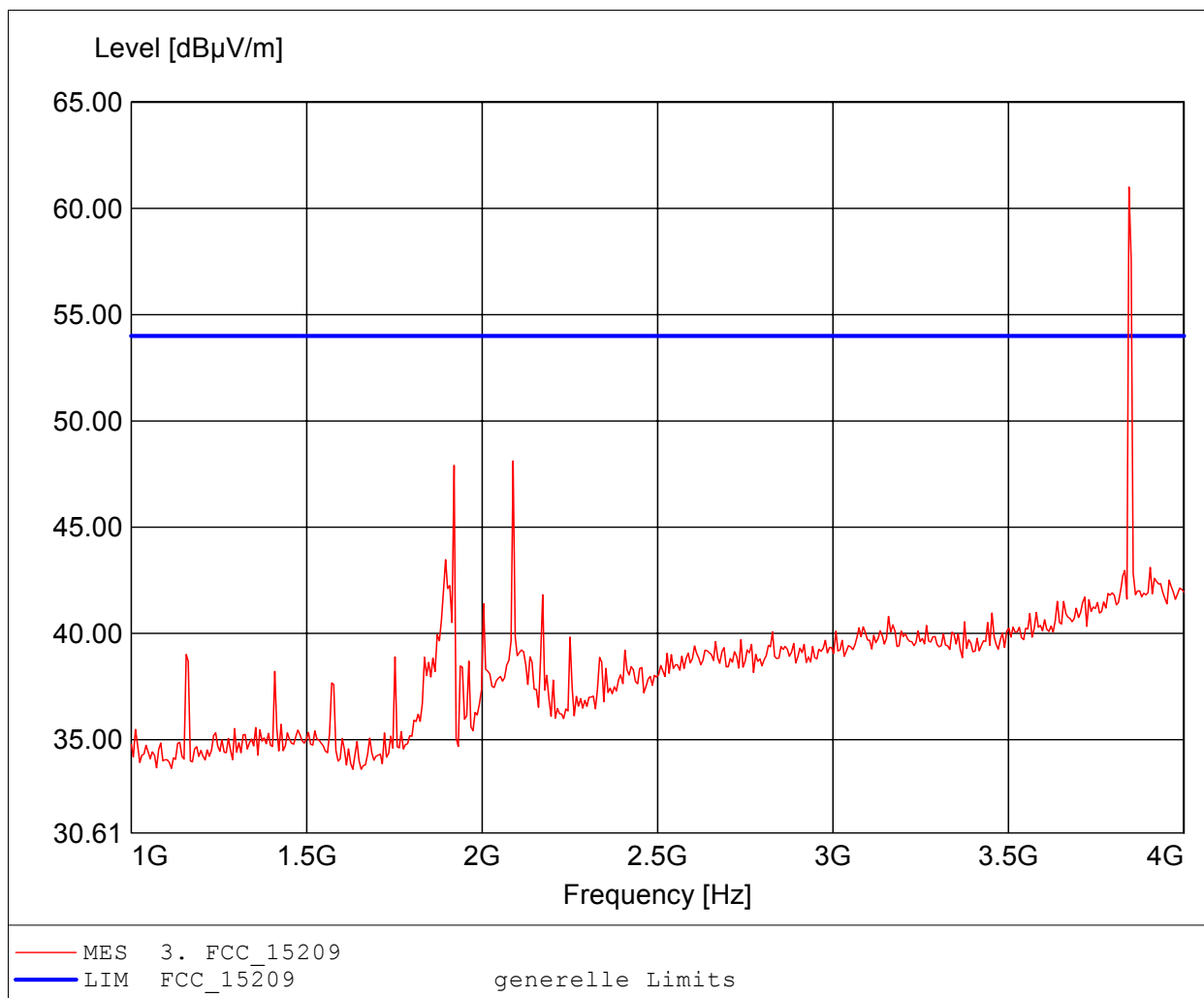



# Harmonics, Radiated

## FCC RULES PART 15.209

Approval Holder: GN Netcom A/S / GOM-1104-1092  
EUT / Model: UPCS BaseStation / WHB003BS  
FP / CH 4: 1921.536MHz / Ant: 1 / vertical  
Test Site / Operator: Eurofins Product Service GmbH / Mr. Pudell  
Test Condition: Tnom.: 24°C / Unom: 7.5 V DC ( Ext. Power Supply )  
Test Specification: Anechoic chamber / mode: Tx  
Comment 1: Dist.: 3m, Ant.: BBHA 9120D, HP+ampl., AV-Detector  
Comment 2: Freq.: 3.843GHz, Emax: 45.44dBuV/m, RBW: 1MHz

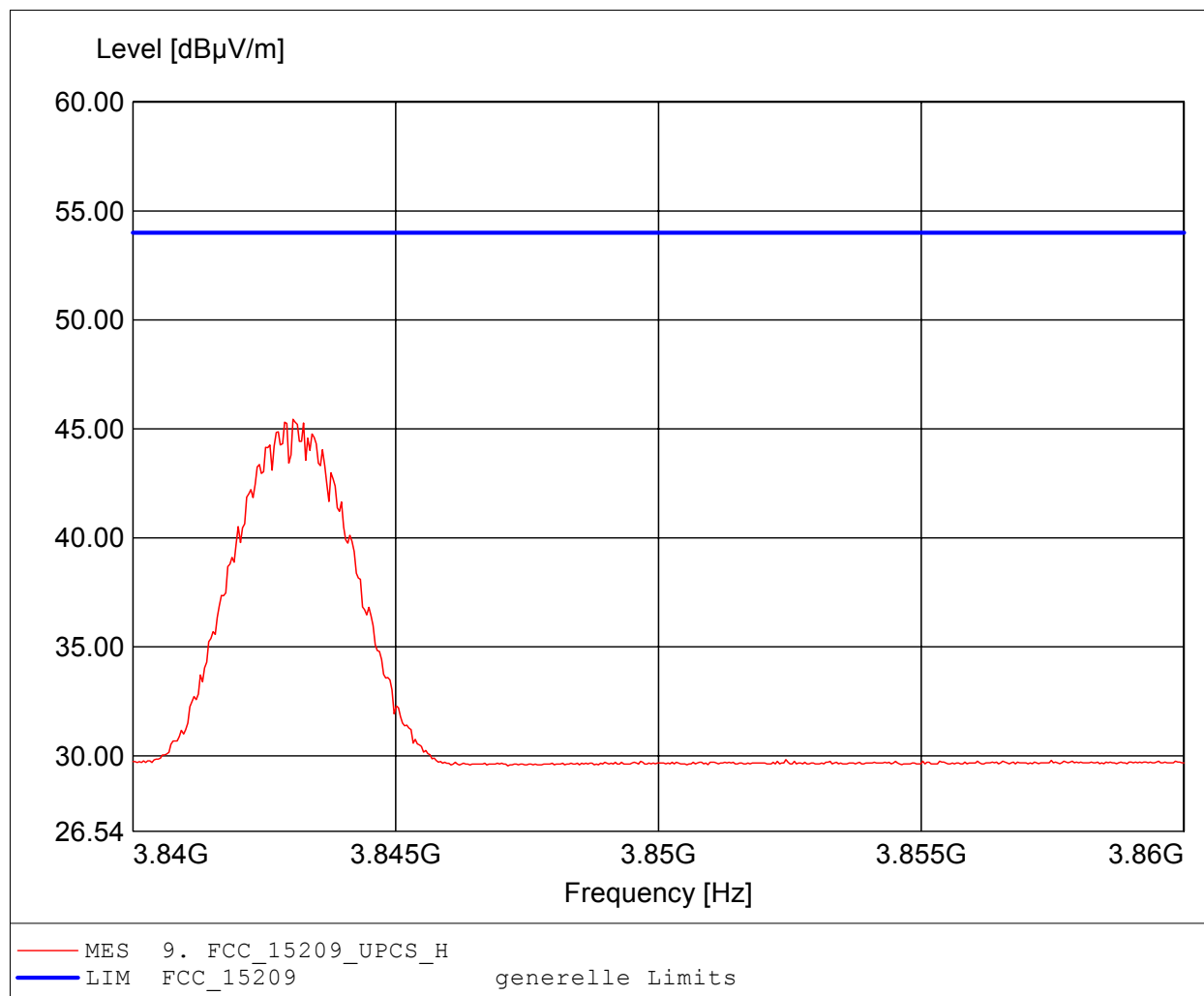

# Radiated spurious emissions under normal conditions

## FCC RULES PART 15.209

Approval Holder: GN Netcom A/S / GOM-1104-1092  
EUT / Model: UPCS BaseStation / WHB003BS  
FP / CH 4: 1921.536MHz / Ant: 1 / vertical  
Test Site / Operator: Eurofins Product Service GmbH / Mr. Pudell  
Test Condition: Tnom.: 24°C / Unom: 7.5 V DC ( Ext. Power Supply )  
Test Specification: Anechoic chamber / mode: Tx  
Comment 1: Dist.: 3m, Ant.: BBHA 9120D, HP+ampl.  
Comment 2: Freq.: 3.844GHz, Emax: 52.78dBuV/m, RBW: 1MHz

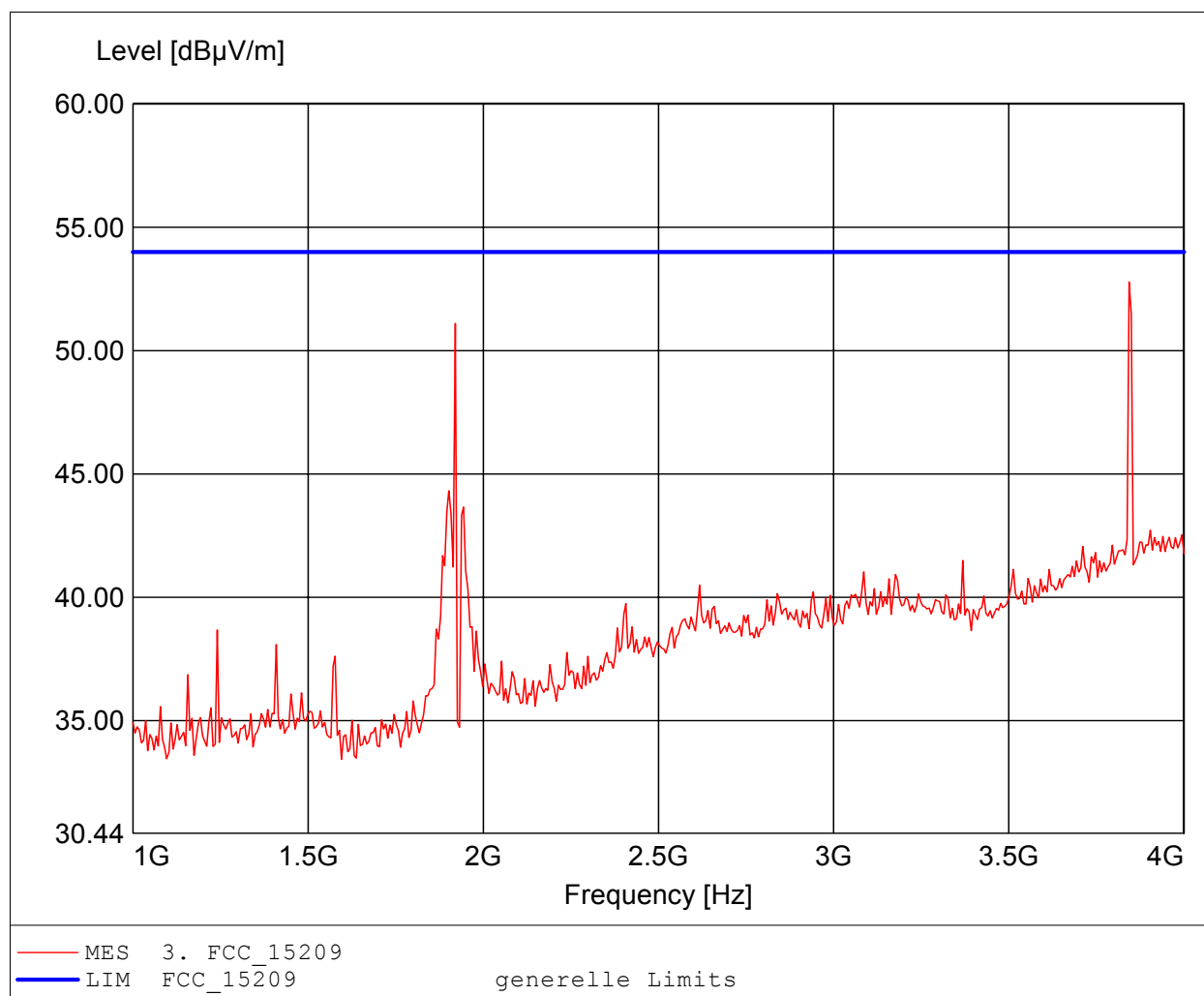

# Harmonics, Radiated

## FCC RULES PART 15.209

Approval Holder: GN Netcom A/S / GOM-1104-1092  
EUT / Model: UPCS BaseStation / WHB003BS  
FP / CH 4: 1921.536MHz / Ant: 1 / vertical  
Test Site / Operator: Eurofins Product Service GmbH / Mr. Pudell  
Test Condition: Tnom.: 24°C / Unom: 7.5 V DC ( Ext. Power Supply )  
Test Specification: Anechoic chamber / mode: Tx  
Comment 1: Dist.: 3m, Ant.: BBHA 9120D, HP+ampl., AV-Detector  
Comment 2: Freq.: 3.843GHz, Emax: 42.47dBuV/m, RBW: 1MHz

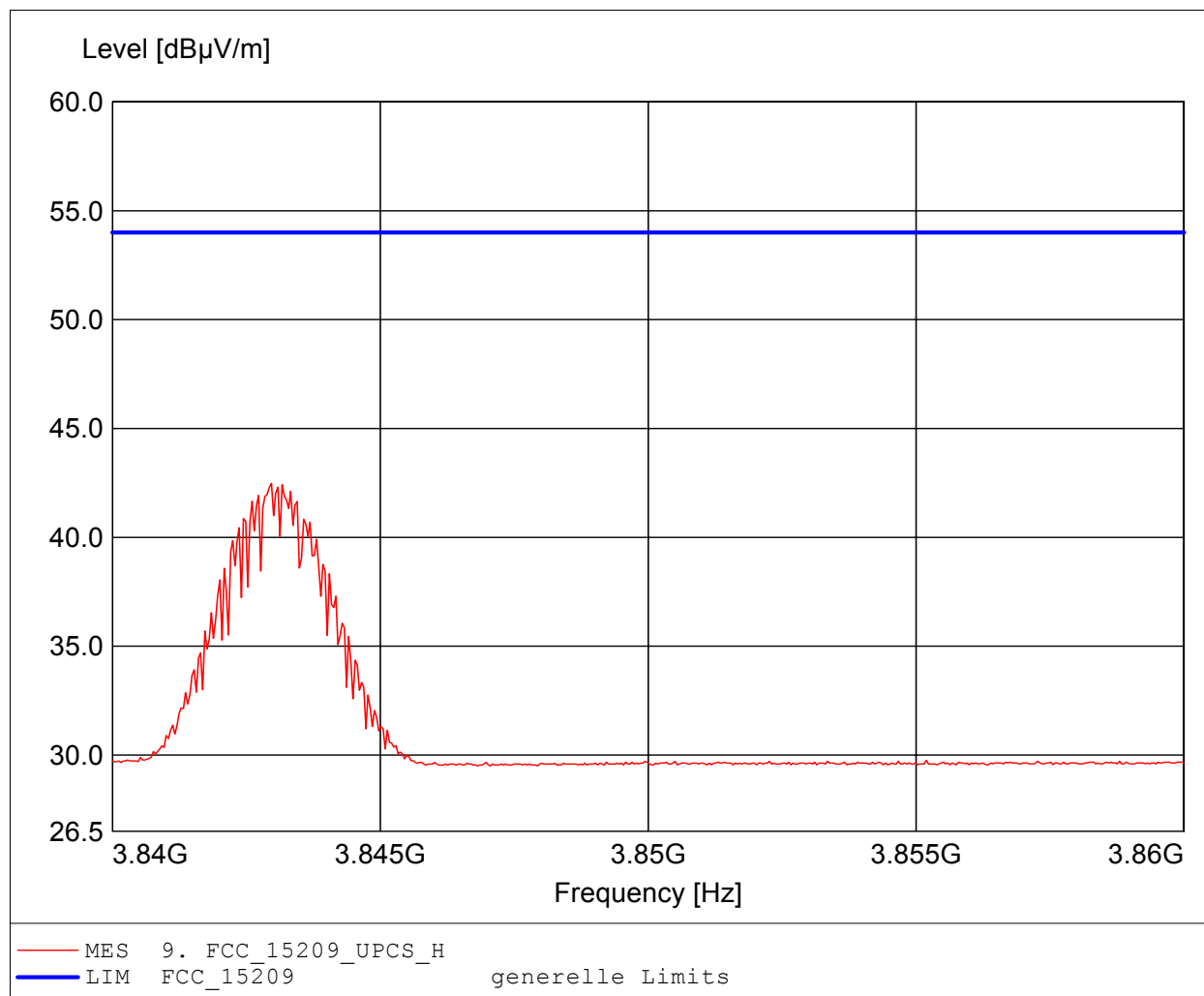

**Radiated spurious emissions under normal conditions**

**FCC RULES PART 15.209**

Approval Holder: GN Netcom A/S / GOM-1104-1092  
 EUT / Model: UPCS BaseStation / WHB003BS  
 FP / CH 4: 1921.536MHz / Ant: 1 / vertical  
 Test Site / Operator: Eurofins Product Service GmbH / Mr. Pudell  
 Test Condition: Tnom.: 24°C / Unom: 7.5 V DC ( Ext. Power Supply )  
 Test Specification: Anechoic chamber / mode: Tx  
 Comment 1: Dist.: 3m, Ant.: BBHA 9120D, HP+ampl.  
 Comment 2: Freq.: 7.687GHz, Emax: 45.48dBuV/m, RBW: 1MHz

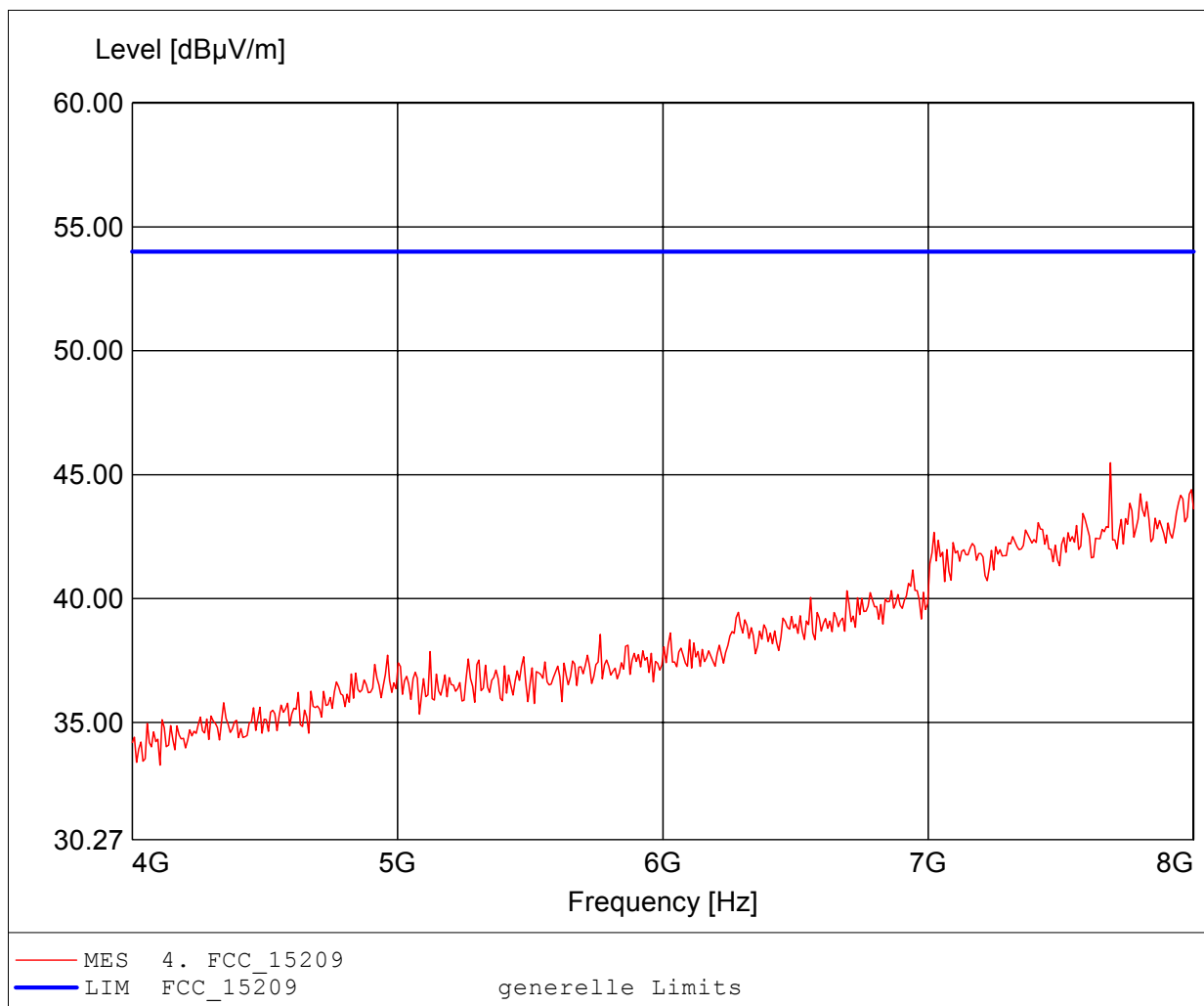

# Radiated spurious emissions under normal conditions

## FCC RULES PART 15.209

Approval Holder: GN Netcom A/S / GOM-1104-1092  
EUT / Model: UPCS BaseStation / WHB003BS  
FP / CH 4: 1921.536MHz / Ant: 1 / vertical  
Test Site / Operator: Eurofins Product Service GmbH / Mr. Pudell  
Test Condition: Tnom.: 24°C / Unom: 7.5 V DC ( Ext. Power Supply )  
Test Specification: Anechoic chamber / mode: Tx  
Comment 1: Dist.: 3m, Ant.: BBHA 9120D, HP+ampl.  
Comment 2: Freq.: 7.687GHz, Emax: 60.73dBμV/m, RBW: 1MHz

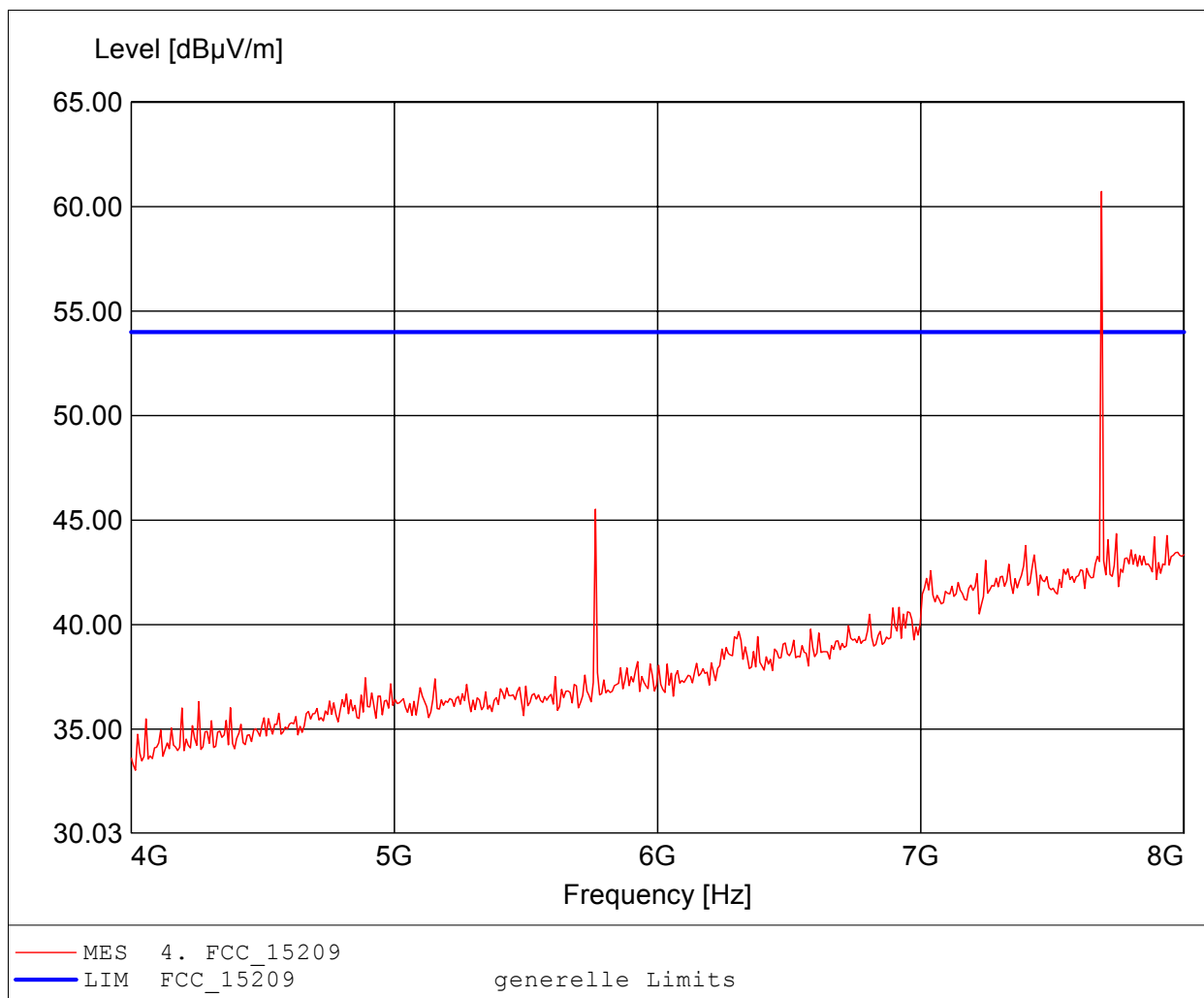

**Harmonics, Radiated**

**FCC RULES PART 15.209**

Approval Holder: GN Netcom A/S / GOM-1104-1092  
EUT / Model: UPCS BaseStation / WHB003BS  
FP / CH 4: 1921.536MHz / Ant: 1 / vertical  
Test Site / Operator: Eurofins Product Service GmbH / Mr. Pudell  
Test Condition: Tnom.: 24°C / Unom: 7.5 V DC ( Ext. Power Supply )  
Test Specification: Anechoic chamber / mode: Tx  
Comment 1: Dist.: 3m, Ant.: BBHA 9120D, HP+ampl., AV-Detector  
Comment 2: Freq.: 7.687GHz, Emax: 42.35dBuV/m, RBW: 1MHz

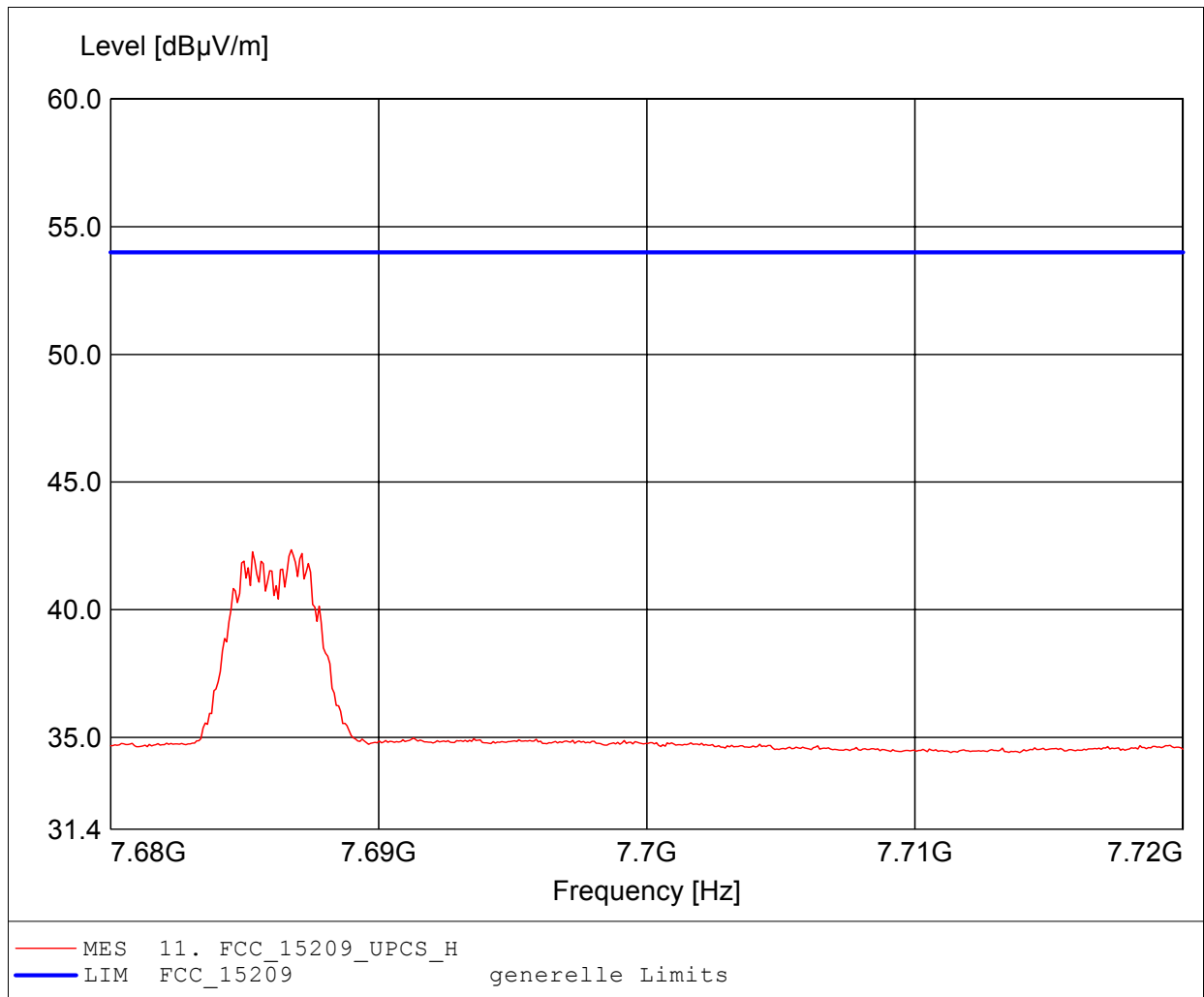

**Radiated spurious emissions under normal conditions**

**FCC RULES PART 15.209**

Approval Holder: GN Netcom A/S / GOM-1104-1092  
EUT / Model: UPCS BaseStation / WHB003BS  
FP / CH 4: 1921.536MHz / Ant: 1 / vertical  
Test Site / Operator: Eurofins Product Service GmbH / Mr. Pudell  
Test Condition: Tnom.: 24°C / Unom: 7.5 V DC ( Ext. Power Supply )  
Test Specification: Anechoic chamber / mode: Tx  
Comment 1: Dist.: 3m, Ant.: BBHA 9120D, HP+ampl.  
Comment 2: Freq.: 11.439GHz, Emax: 43.30dBµV/m, RBW: 1MHz

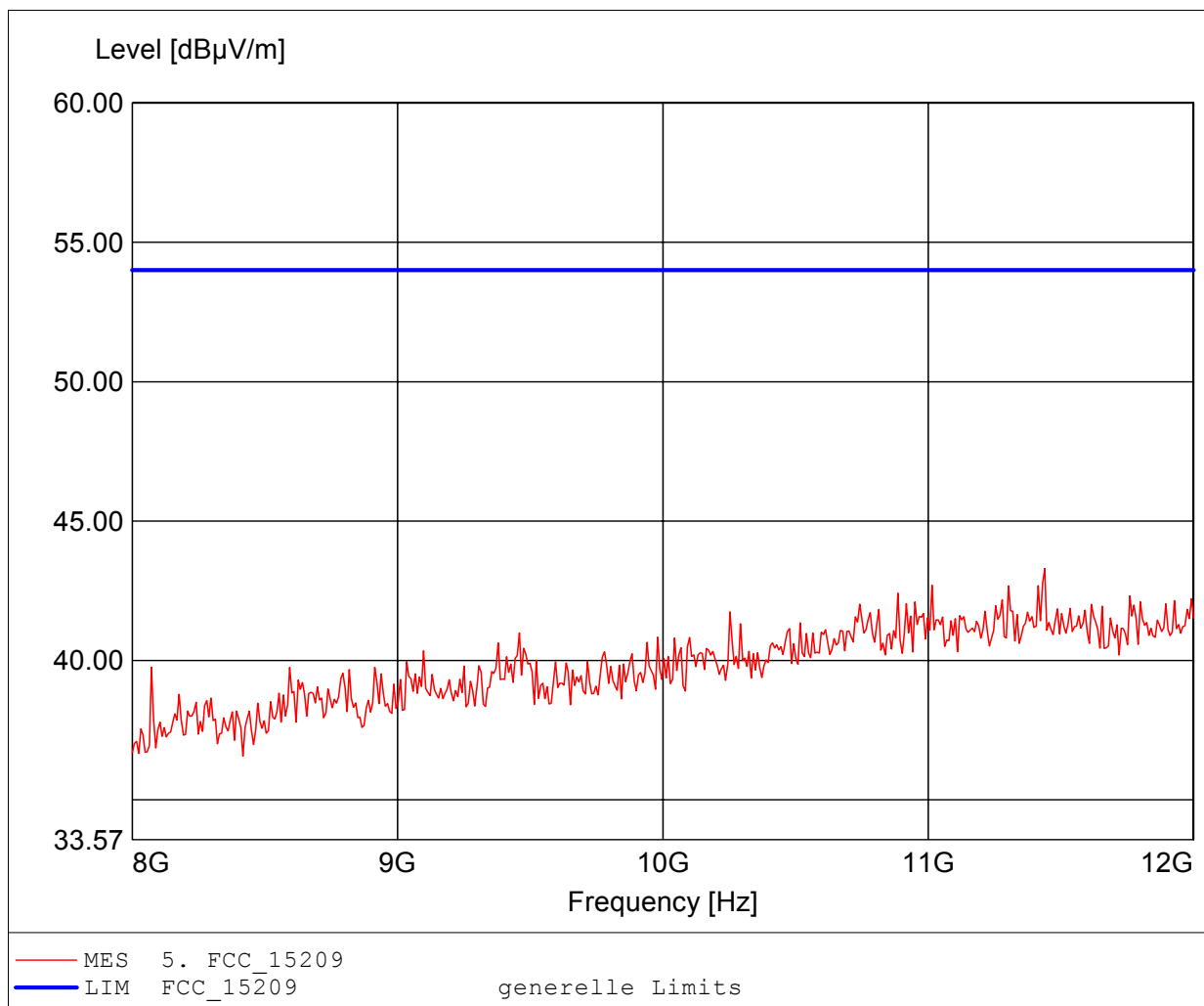

# Radiated spurious emissions under normal conditions

## FCC RULES PART 15.209

Approval Holder: GN Netcom A/S / GOM-1104-1092  
EUT / Model: UPCS BaseStation / WHB003BS  
FP / CH 4: 1921.536MHz / Ant: 1 / vertical  
Test Site / Operator: Eurofins Product Service GmbH / Mr. Pudell  
Test Condition: Tnom.: 24°C / Unom: 7.5 V DC ( Ext. Power Supply )  
Test Specification: Anechoic chamber / mode: Tx  
Comment 1: Dist.: 3m, Ant.: BBHA 9120D, HP+ampl.  
Comment 2: Freq.: 10.974GHz, Emax: 42.65dBµV/m, RBW: 1MHz

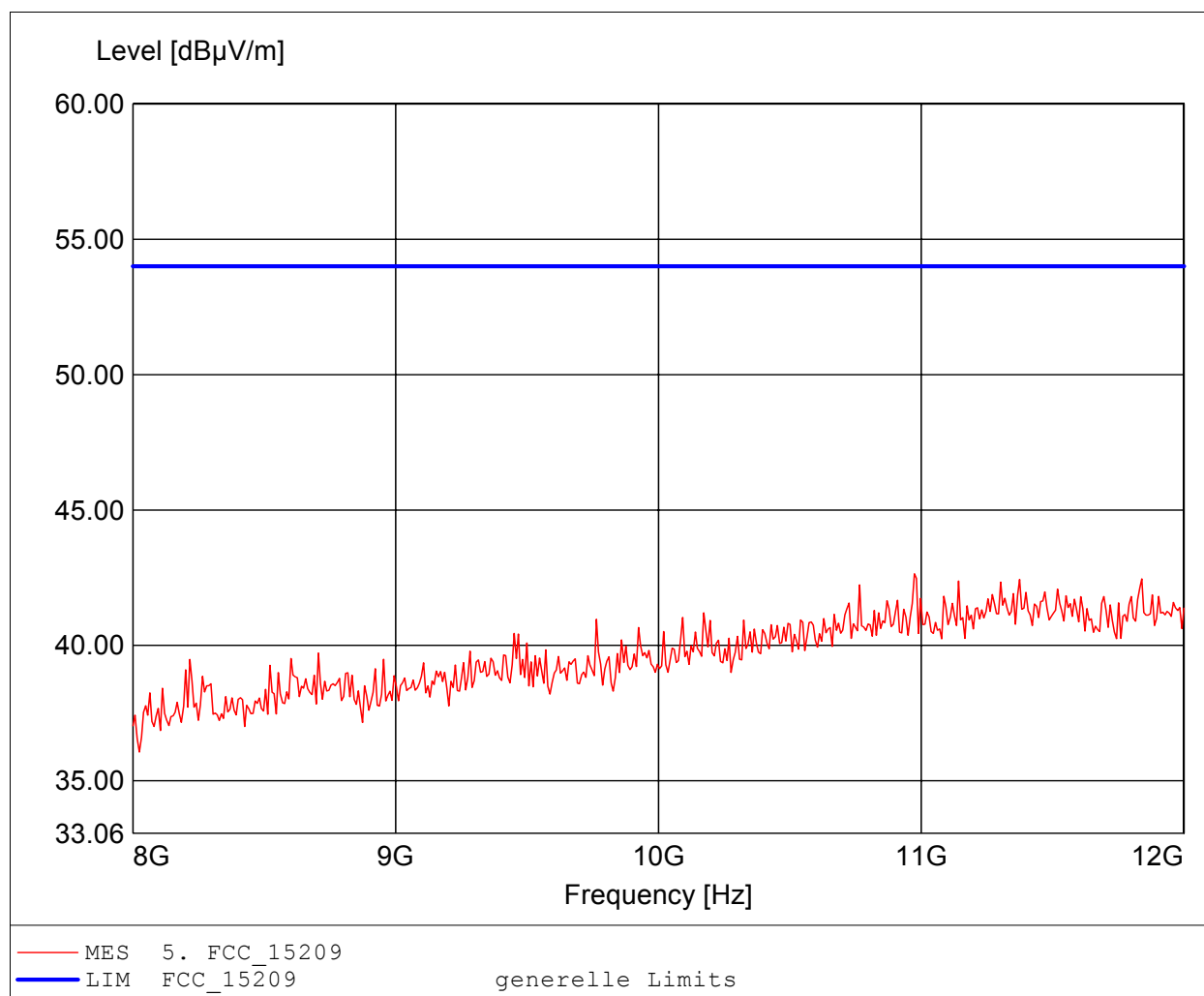



# Radiated spurious emissions under normal conditions

## FCC RULES PART 15.209

Approval Holder: GN Netcom A/S / GOM-1104-1092  
EUT / Model: UPCS BaseStation / WHB003BS  
FP / CH 4: 1921.536MHz / Ant: 1 / vertical  
Test Site / Operator: Eurofins Product Service GmbH / Mr. Pudell  
Test Condition: Tnom.: 24°C / Unom: 7.5 V DC ( Ext. Power Supply )  
Test Specification: Anechoic chamber / mode: Tx  
Comment 1: Dist.: 3m, Ant.: BBHA 9120D, HP+ampl.  
Comment 2: Freq.: 17.976GHz, Emax: 52.24dBµV/m, RBW: 1MHz

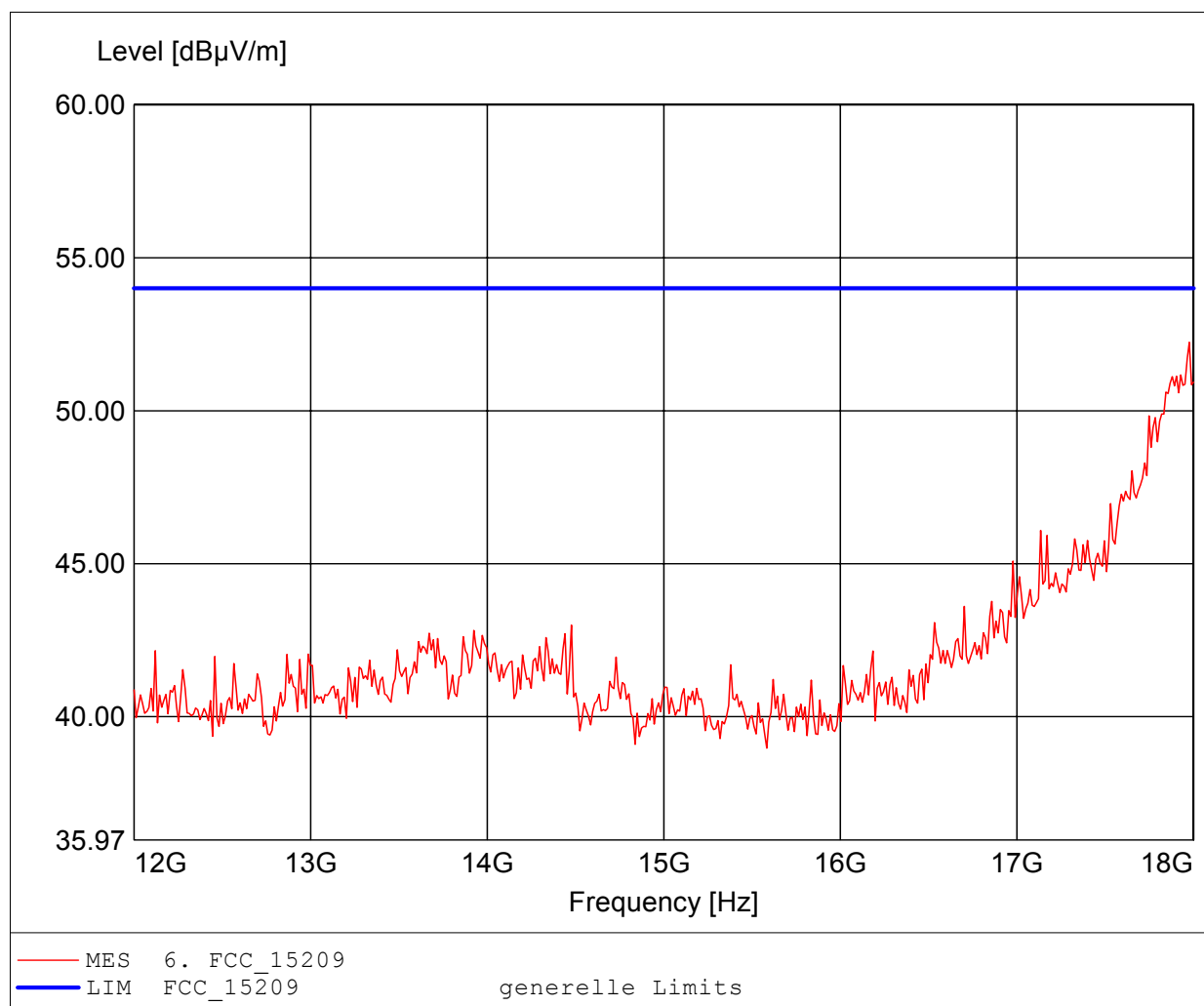

**Radiated spurious emissions under normal conditions**

**FCC RULES PART 15.209**

Approval Holder: GN Netcom A/S / GOM-1104-1092  
EUT / Model: UPCS BaseStation / WHB003BS  
FP / CH 4: 1921.536MHz / Ant: 1 / vertical  
Test Site / Operator: Eurofins Product Service GmbH / Mr. Pudell  
Test Condition: Tnom.: 24°C / Unom: 7.5 V DC ( Ext. Power Supply )  
Test Specification: Anechoic chamber / mode: Tx  
Comment 1: Dist.: 3m, Ant.: BBHA 9120D, HP+ampl.  
Comment 2: Freq.: 17.940GHz, Emax: 51.84dBµV/m, RBW: 1MHz

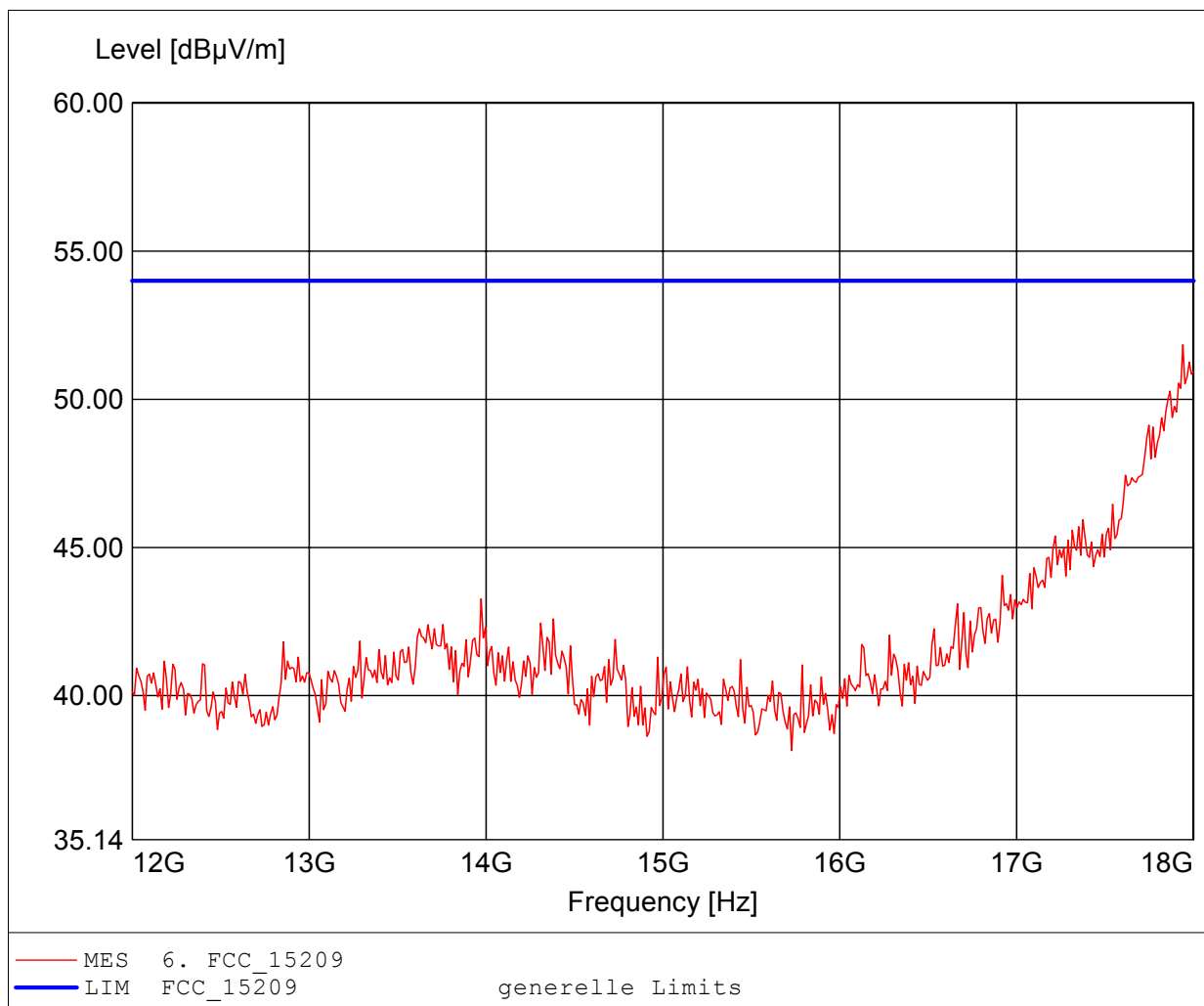

**Radiated spurious emissions under normal conditions**

**FCC RULES PART 15.209**

Approval Holder: GN Netcom A/S / GOM-1104-1092  
 EUT / Model: UPCS BaseStation / WHB003BS  
 FP / CH 4: 1921.536MHz / Ant: 1 / vertical  
 Test Site / Operator: Eurofins Product Service GmbH / Mr. Pudell  
 Test Condition: Tnom.: 24°C / Unom: 7.5 V DC ( Ext. Power Supply )  
 Test Specification: Anechoic chamber / mode: Tx  
 Comment 1: Dist.: 3m, Ant.: HL025, ampl.  
 Comment 2: Freq.: 24.558GHz, Emax: 50.08dBµV/m, RBW: 1MHz

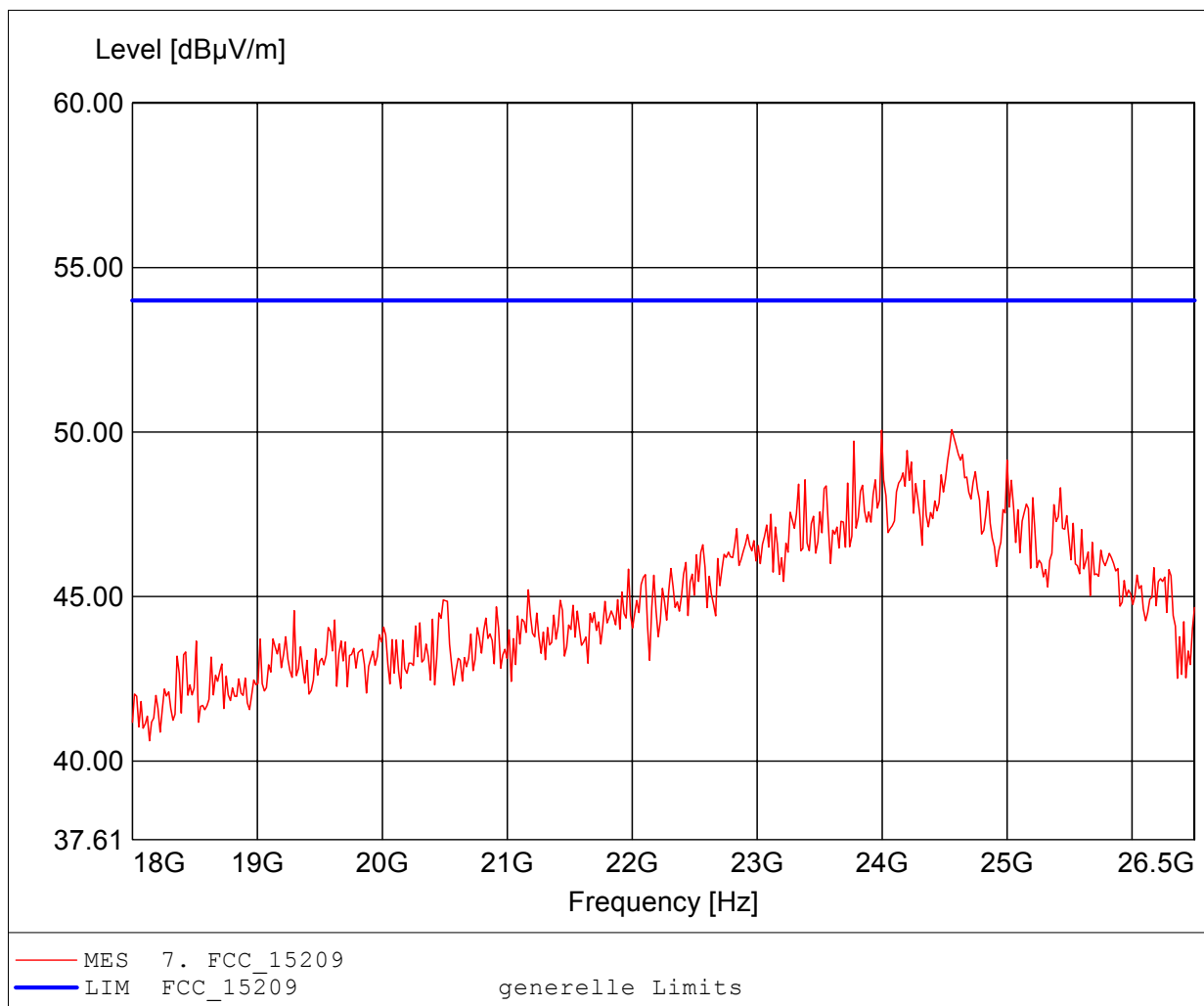

# Radiated spurious emissions under normal conditions

## FCC RULES PART 15.209

Approval Holder: GN Netcom A/S / GOM-1104-1092  
EUT / Model: UPCS BaseStation / WHB003BS  
FP / CH 4: 1921.536MHz / Ant: 1 / vertical  
Test Site / Operator: Eurofins Product Service GmbH / Mr. Pudell  
Test Condition: Tnom.: 24°C / Unom: 7.5 V DC ( Ext. Power Supply )  
Test Specification: Anechoic chamber / mode: Tx  
Comment 1: Dist.: 3m, Ant.: HL025, ampl.  
Comment 2: Freq.: 24.234GHz, Emax: 50.33dB $\mu$ V/m, RBW: 1MHz

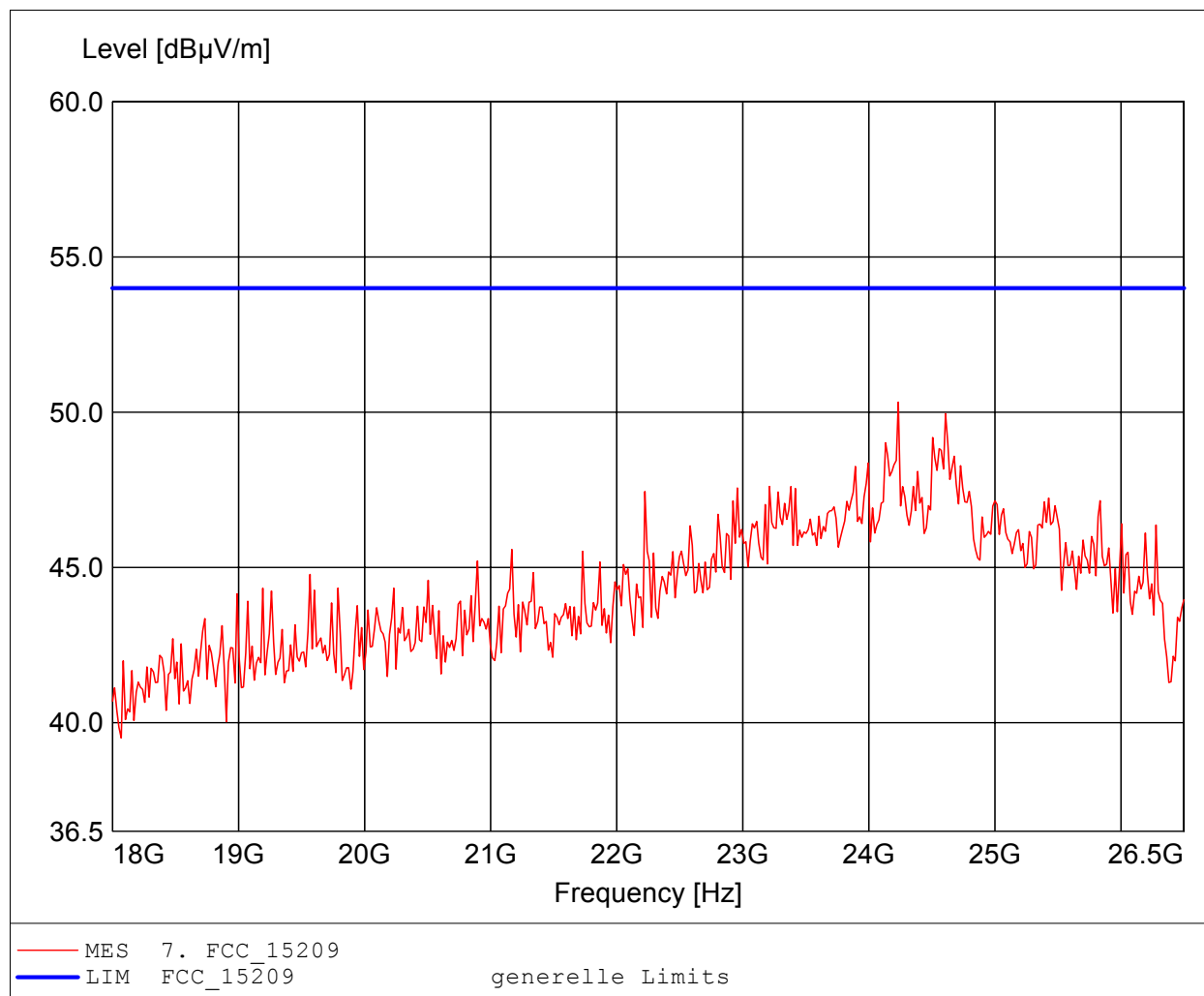

## **Annex N      Receiver radiated spurious emissions**

**Field Strength under normal conditions**  
**Standards Industry Canada, RSS-GEN**

Approval Holder: GN Netcom A/S / G0M-1104-1092  
EUT / Model: UPCS BaseStation / WHB003BS  
FP / CH 2: 1924.992MHz / Ant: 1 / vertical  
Test Site / Operator: Eurofins Product Service GmbH / Mr. Pudell  
Test Conditions 1: Tnom.: 24°C / Unom: 7.5 V DC ( Ext. Power Supply )  
Test Conditions 2: Freq. / CH: 2  
Comment 1: Dist.: 3m, Ant.: HK 116  
Comment 2: Freq:197.956MHz Emax:32.57dBµV/m RBW: 100 kHz

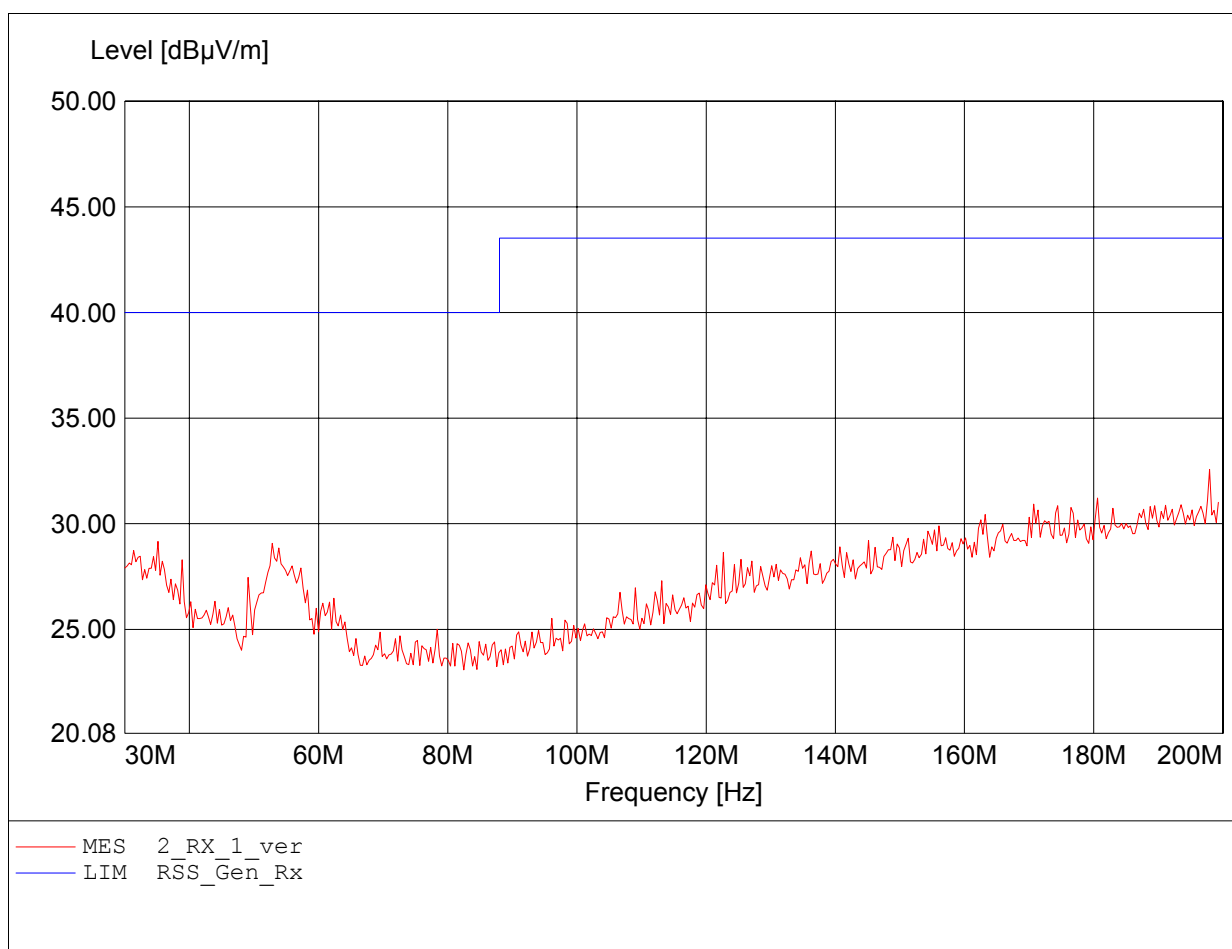

**Field Strength under normal conditions  
Standards Industry Canada, RSS-GEN**

Approval Holder: GN Netcom A/S / GOM-1104-1092  
EUT / Model: UPCS BaseStation / WHB003BS  
FP / CH 2: 1924.992MHz / Ant: 1 / vertical  
Test Site / Operator: Eurofins Product Service GmbH / Mr. Pudell  
Test Conditions 1: Tnom.: 24°C / Unom: 7.5 V DC ( Ext. Power Supply )  
Test Conditions 2: Freq. / CH: 2  
Comment 1: Dist.: 3m, Ant.: HK 116  
Comment 2: Freq:197.615MHz Emax:32.36dBµV/m RBW: 100 kHz

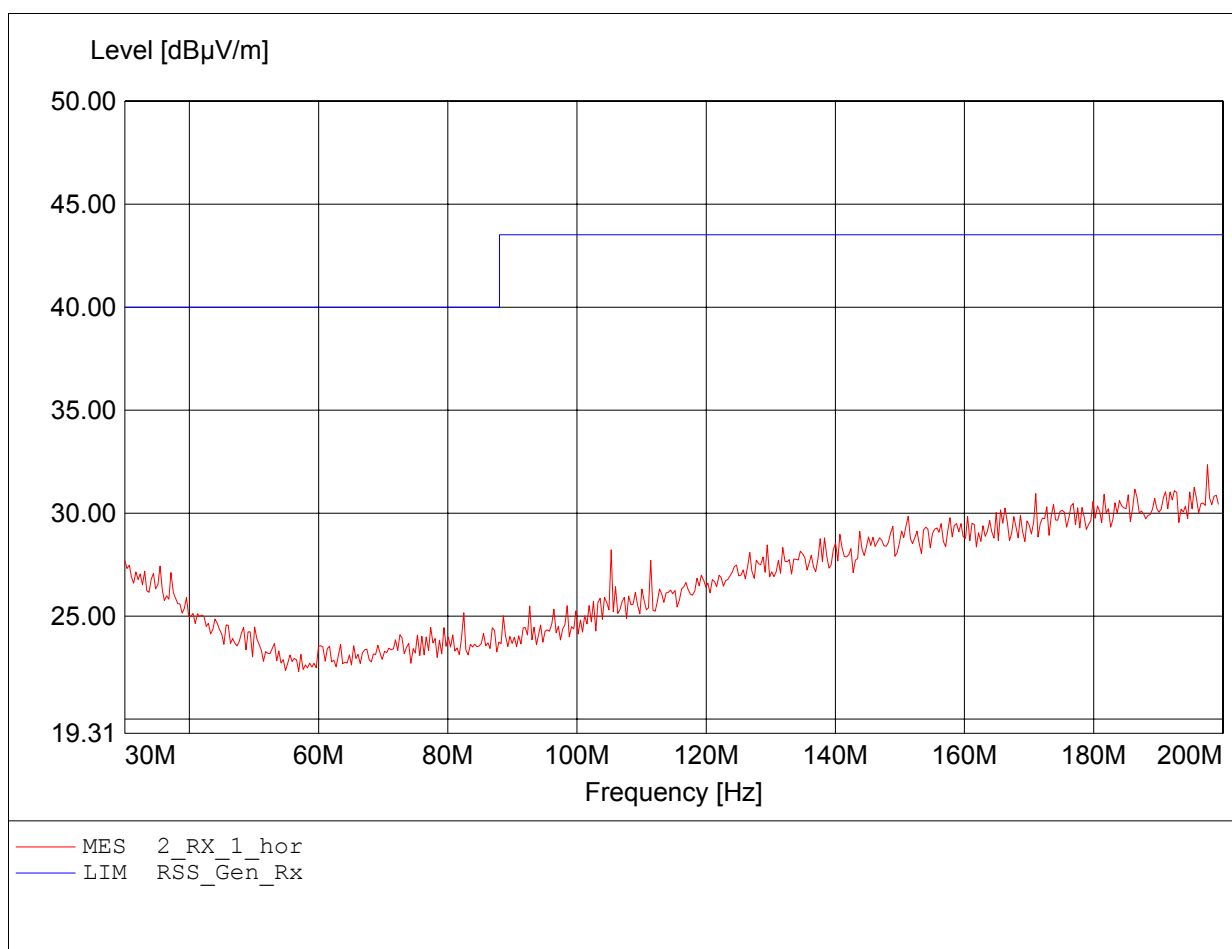

**Field Strength under normal conditions  
Standards Industry Canada, RSS-GEN**

Approval Holder: GN Netcom A/S / GOM-1104-1092  
EUT / Model: UPCS BaseStation / WHB003BS  
FP / CH 2: 1924.992MHz / Ant: 1 / vertical  
Test Site / Operator: Eurofins Product Service GmbH / Mr. Pudell  
Test Conditions 1: Tnom.: 24°C / Unom: 7.5 V DC ( Ext. Power Supply )  
Test Conditions 2: Freq. / CH: 2  
Comment 1: Dist.: 3m, Ant.: HL 223, ampl.  
Comment 2: Freq:996.794MHz Emax:31.21dBµV/m RBW: 100 kHz

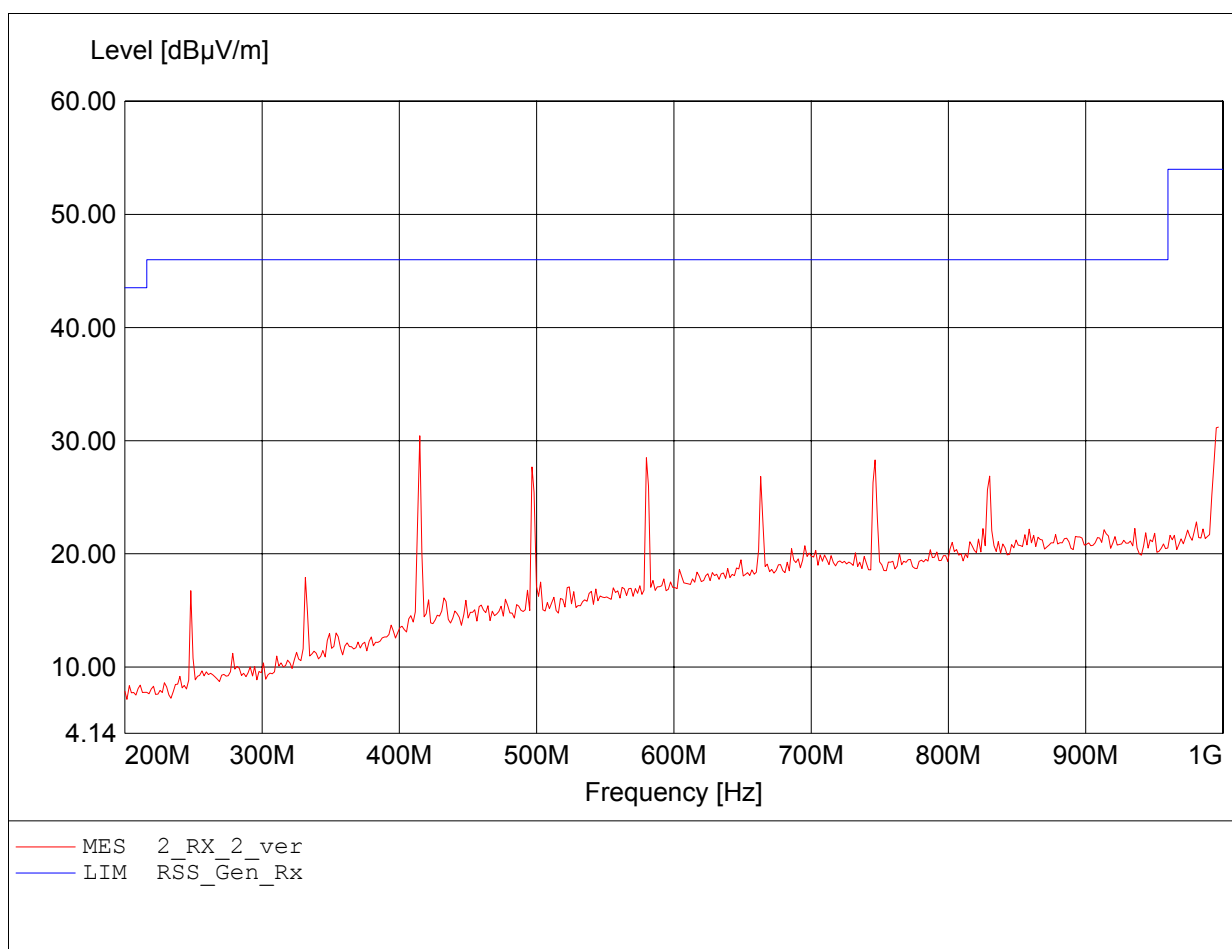



**Field Strength under normal conditions  
Standards Industry Canada, RSS-GEN**

Approval Holder: GN Netcom A/S / GOM-1104-1092  
EUT / Model: UPCS BaseStation / WHB003BS  
FP / CH 2: 1924.992MHz / Ant: 1 / vertical  
Test Site / Operator: Eurofins Product Service GmbH / Mr. Pudell  
Test Conditions 1: Tnom.: 24°C / Unom: 7.5 V DC ( Ext. Power Supply )  
Test Conditions 2: Freq. / CH: 2  
Comment 1: Dist.: 3m, Ant.: HL 223, ampl.  
Comment 2: Freq:996.794MHz Emax:35.80dBµV/m RBW: 100 kHz

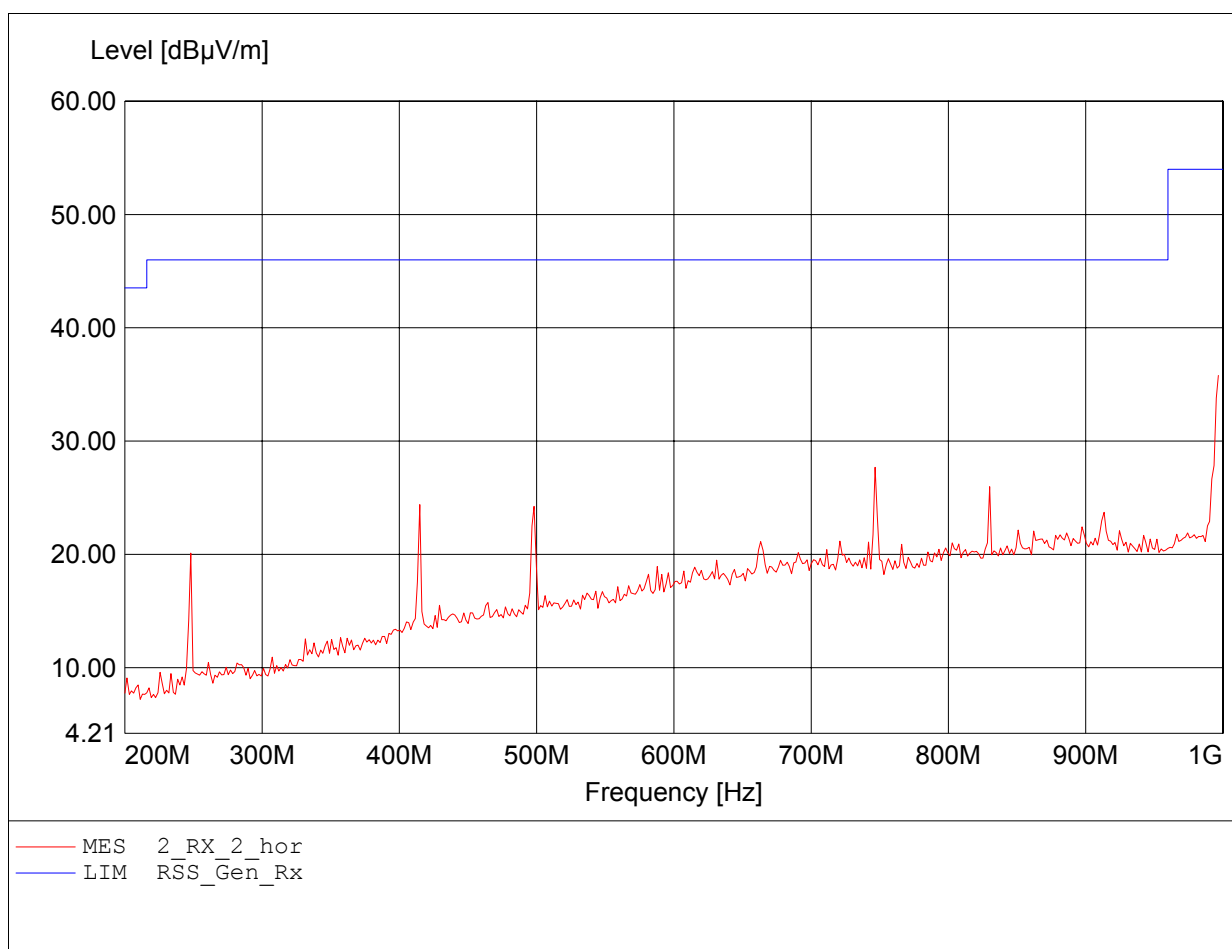

**Field Strength under normal conditions**  
**Standards Industry Canada, RSS-GEN**

Approval Holder: GN Netcom A/S / G0M-1104-1092  
EUT / Model: UPCS BaseStation / WHB003BS  
FP / CH 2: 1924.992MHz / Ant: 1 / vertical  
Test Site / Operator: Eurofins Product Service GmbH / Mr. Pudell  
Test Conditions 1: Tnom.: 24°C / Unom: 7.5 V DC ( Ext. Power Supply )  
Test Conditions 2: Freq. / CH: 2  
Comment 1: Dist.: 3m, Ant.: HL025, ampl.  
Comment 2: Freq:3.988GHz Emax:41.49dBµV/m RBW: 1 MHz

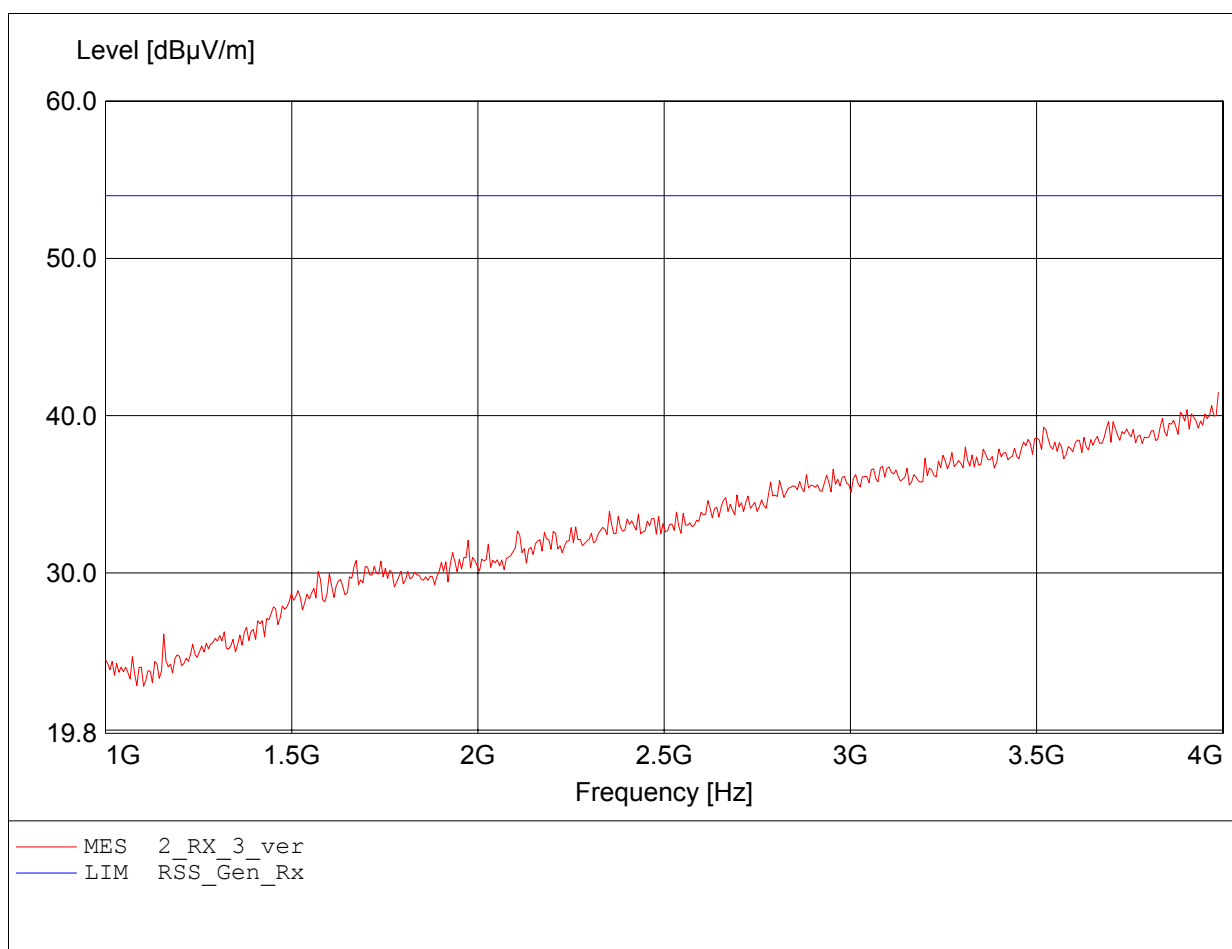

**Field Strength under normal conditions  
Standards Industry Canada, RSS-GEN**

Approval Holder: GN Netcom A/S / GOM-1104-1092  
 EUT / Model: UPCS BaseStation / WHB003BS  
 FP / CH 2: 1924.992MHz / Ant: 1 / vertical  
 Test Site / Operator: Eurofins Product Service GmbH / Mr. Pudell  
 Test Conditions 1: Tnom.: 24°C / Unom: 7.5 V DC ( Ext. Power Supply )  
 Test Conditions 2: Freq. / CH: 2  
 Comment 1: Dist.: 3m, Ant.: HL025, ampl.  
 Comment 2: Freq:3.856GHz Emax:40.74dBμV/m RBW: 1 MHz

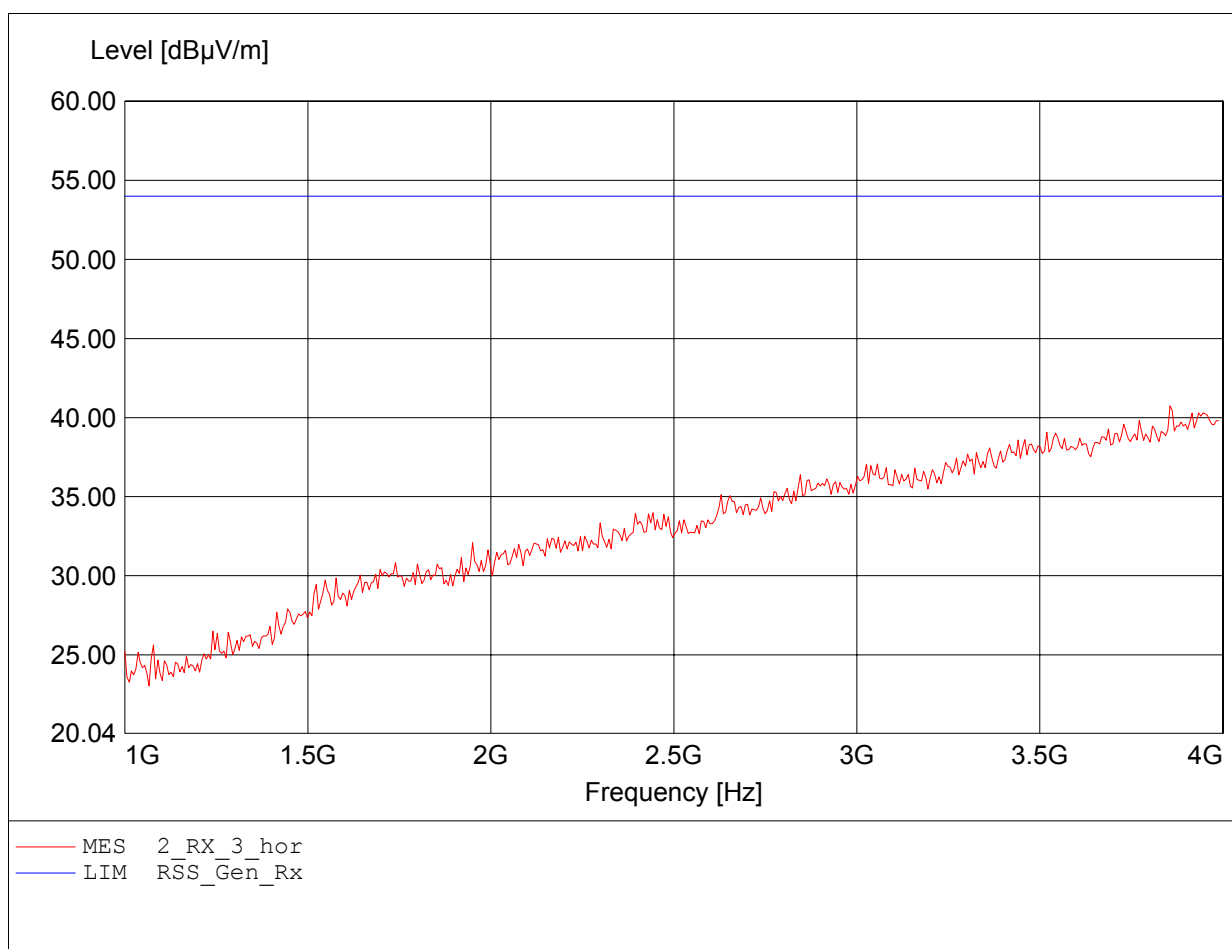

**Field Strength under normal conditions**  
**Standards Industry Canada, RSS-GEN**

Approval Holder: GN Netcom A/S / GOM-1104-1092  
EUT / Model: UPCS BaseStation / WHB003BS  
FP / CH 2: 1924.992MHz / Ant: 1 / vertical  
Test Site / Operator: Eurofins Product Service GmbH / Mr. Pudell  
Test Conditions 1: Tnom.: 24°C / Unom: 7.5 V DC ( Ext. Power Supply )  
Test Conditions 2: Freq. / CH: 2  
Comment 1: Dist.: 3m, Ant.: HL025, ampl.  
Comment 2: Freq:7.727GHz Emax:42.14dBμV/m RBW: 1 MHz

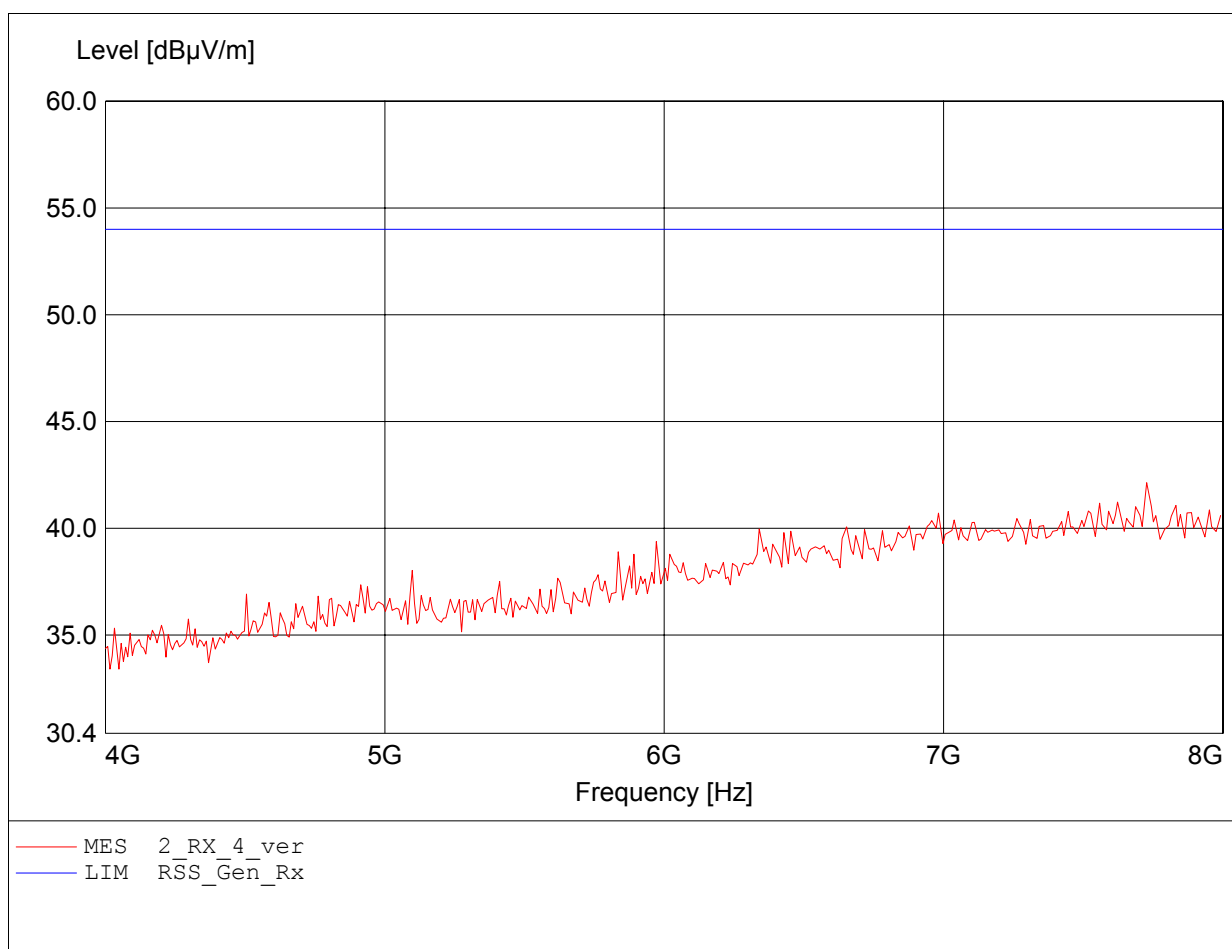

**Field Strength under normal conditions  
Standards Industry Canada, RSS-GEN**

Approval Holder: GN Netcom A/S / GOM-1104-1092  
EUT / Model: UPCS BaseStation / WHB003BS  
FP / CH 2: 1924.992MHz / Ant: 1 / vertical  
Test Site / Operator: Eurofins Product Service GmbH / Mr. Pudell  
Test Conditions 1: Tnom.: 24°C / Unom: 7.5 V DC ( Ext. Power Supply )  
Test Conditions 2: Freq. / CH: 2  
Comment 1: Dist.: 3m, Ant.: HL025, ampl.  
Comment 2: Freq:7.872GHz Emax:41.90dBµV/m RBW: 1 MHz

