



Test report No.: 2330787R-RFUSV05S-A

TEST REPORT

Product Name	PanaCast 50 Video Bar System
Trademark	Jabra
Model and /or type reference	VSM040
FCC ID	BCE-VSM040
Applicant's name / address	GN Audio USA Inc. 900 Chelmsfort St, Tower 2, Floor 8 , Lowell, Massachusetts, 01851 United States
Manufacturer's name	GN Audio A/S
Test method requested, standard	FCC CFR Title 47 Part 15 Subpart B ANSI C63.4: 2014, ANSI C63.10: 2013
Verdict Summary	IN COMPLIANCE
Documented By (Senior Project Specialist / April Chen)	<i>April Chen</i>
Tested By (Senior Engineer / Ivan Chuang)	<i>Ivan Chuang</i>
Approved By (Senior Engineer / Alan Chen)	<i>Alan Chen</i>
Date of Receipt	2023/03/22
Date of Issue	2023/05/24
Report Version	V1.0

INDEX

	Page
1. General Information.....	5
1.1. EUT Description.....	5
1.2. Test System Details	8
1.3. Configuration of Test System	8
1.4. EUT Exercise Software	8
1.5. Test Facility	9
1.6. List of Test Item and Equipment	10
1.7. Uncertainty	11
2. Conducted Emission	12
2.1. Test Setup	12
2.2. Limits.....	12
2.3. Test Procedure	13
2.4. Test Result of Conducted Emission.....	14
3. Radiated Emission	16
3.1. Test Setup	16
3.2. Limits.....	17
3.3. Test Procedure	18
3.4. Test Result of Radiated Emission.....	19

Appendix 1: EUT Test Photographs

Appendix 2: Product Photos-Please refer to the file: 2330787R-Product Photos

Competences and Guarantees

DEKRA is a testing laboratory competent to carry out the tests described in this report.

In order to assure the traceability to other national and international laboratories, DEKRA has a calibration and maintenance program for its measurement equipment.

DEKRA guarantees the reliability of the data presented in this report, which is the result of the measurements and the tests performed to the item under test on the date and under the conditions stated in the report and it is based on the knowledge and technical facilities available at DEKRA at the time of performance of the test.

DEKRA is liable to the client for the maintenance of the confidentiality of all information related to the item under test and the results of the test.

The results presented in this Test Report apply only to the particular item under test established in this document.

IMPORTANT: No parts of this report may be reproduced or quoted out of context, in any form or by any means, except in full, without the previous written permission of DEKRA.

General conditions

1. The test results relate only to the samples tested.
2. The test results shown in the test report are traceable to the national/international standard through the calibration report of the equipment and evaluated measurement uncertainty herein.
3. This report must not be used to claim product endorsement by TAF or any agency of the government.
4. The test report shall not be reproduced without the written approval of DEKRA Testing and Certification Co., Ltd.
5. Measurement uncertainties evaluated for each testing system and associated connections are given here to provide the system information for reference. Compliance determinations do not take into account measurement uncertainties for each testing system, but are based on the results of the compliance measurement.

Revision History

Report No.	Version	Description	Issued Date
2330787R-RFUSV05S-A	V1.0	Initial issue of report.	2023/05/24

1. General Information

1.1. EUT Description

Product Name	PanaCast 50 Video Bar System
Trademark	Jabra
Model and /or type reference	VSM040
EUT Rated Voltage	AC 100-240V, 50-60Hz
EUT Test Voltage	AC 120V/50Hz
Frequency Range	802.11b/g/n-20 MHz: 2412-2462 MHz 802.11n/ac-40 MHz: 2422-2452 MHz 802.11a/n/ac-20 MHz: 5180-5320 MHz, 5500-5700 MHz, 5720MHz, 5745-5825 MHz 802.11n/ac-40 MHz: 5190-5310, 5510-5670 MHz, 5710 MHz, 5755-5795 MHz 802.11ac-80 MHz: 5210-5290 MHz, 5530-5690 MHz, 5775 MHz Bluetooth: 2402 – 2480 MHz
Number of Channels	802.11b/g/n-20 MHz: 11, 802.11n-40 MHz: 7 802.11a/n/ac-20 MHz: 25; 802.11n/ac-40 MHz: 12; 802.11ac-80 MHz: 6 Bluetooth: V2.1+EDR: 79CH, Bluetooth LE: 40CH
Data Speed	802.11b: 1-11 Mbps, 802.11g: 6-54 Mbps, 802.11n: up to 300 Mbps 802.11a: 6-54 Mbps, 802.11n: up to 300 Mbps, 802.11ac-80 MHz: up to 866.7 Mbps Bluetooth: 1-3 Mbps
Type of Modulation	802.11b:DSSS (DBPSK, DQPSK, CCK) 802.11a/g/n/ac: OFDM, BPSK, QPSK, 16QAM, 64QAM, 256QAM Bluetooth: V2.1+EDR: GFSK(1Mbps) / π /4DQPSK(2Mbps) / 8DPSK(3Mbps), LE: GFSK(1Mbps)
Channel Control	Auto
Power Cord	Non-shielded, 1m
Adapter	MFR: Jabra, M/N: WH-231 Input: AC 100-240V~1.5A 50/60Hz Output: 12V $\overline{\text{---}}$ 5A 60W Cable out: Non-shielded, 2m

Antenna List

No.	Manufacturer	Part No.	Antenna Type	Peak Gain
1	Wistron	025.9022Y.0001 (Main)	PCB	2.83 dBi for 2400 MHz 2.53 dBi for 5150~5250 MHz 2.58 dBi for 5250~5350 MHz 2.91 dBi for 5470~5725 MHz
		025.90230.0001 (Aux)		0.07 dBi for 2400 MHz 2.79 dBi for 5150~5250 MHz 2.7 dBi for 5250~5350 MHz 1.93 dBi for 5470~5725 MHz

Note: The antenna of EUT is conform to FCC 15.203.

Bluetooth V2.1+EDR Center Frequency of Each Channel:

Channel	Frequency (MHz)	Channel	Frequency (MHz)	Channel	Frequency (MHz)	Channel	Frequency (MHz)
00	2402	20	2422	40	2442	60	2462
01	2403	21	2423	41	2443	61	2463
02	2404	22	2424	42	2444	62	2464
03	2405	23	2425	43	2445	63	2465
04	2406	24	2426	44	2446	64	2466
05	2407	25	2427	45	2447	65	2467
06	2408	26	2428	46	2448	66	2468
07	2409	27	2429	47	2449	67	2469
08	2410	28	2430	48	2450	68	2470
09	2411	29	2431	49	2451	69	2471
10	2412	30	2432	50	2452	70	2472
11	2413	31	2433	51	2453	71	2473
12	2414	32	2434	52	2454	72	2474
13	2415	33	2435	53	2455	73	2475
14	2416	34	2436	54	2456	74	2476
15	2417	35	2437	55	2457	75	2477
16	2418	36	2438	56	2458	76	2478
17	2419	37	2439	57	2459	77	2479
18	2420	38	2440	58	2460	78	2480
19	2421	39	2441	59	2461	--	--

Bluetooth LE Center Frequency of Each Channel:

Channel	Frequency (MHz)	Channel	Frequency (MHz)	Channel	Frequency (MHz)	Channel	Frequency (MHz)
00	2402	01	2404	02	2406	03	2408
04	2410	05	2412	06	2414	07	2416
08	2418	09	2420	10	2422	11	2424
12	2426	13	2428	14	2430	15	2432
16	2434	17	2436	18	2438	19	2440
20	2442	21	2444	22	2446	23	2448
24	2450	25	2452	26	2454	27	2456
28	2458	29	2460	30	2462	31	2464
32	2466	33	2468	34	2470	35	2472
36	2474	37	2476	38	2478	39	2480

802.11b/g/n-20 MHz Center Frequency of Each Channel (WLAN):

Channel	Frequency (MHz)	Channel	Frequency (MHz)	Channel	Frequency (MHz)	Channel	Frequency (MHz)
01	2412	02	2417	03	2422	04	2427
05	2432	06	2437	07	2442	08	2447
09	2452	10	2457	11	2462	--	--

802.11n-40 MHz Center Frequency of Each Channel (WLAN):

Channel	Frequency (MHz)	Channel	Frequency (MHz)	Channel	Frequency (MHz)	Channel	Frequency (MHz)
03	2422	04	2427	05	2432	06	2437
07	2442	08	2447	09	2452	--	--

802.11a/n/ac-20 MHz Center Working Frequency of Each Channel:

Channel	Frequency (MHz)	Channel	Frequency (MHz)	Channel	Frequency (MHz)	Channel	Frequency (MHz)
36	5180	40	5200	44	5220	48	5240
52	5260	56	5280	60	5300	64	5320
100	5500	104	5520	108	5540	112	5560
116	5580	120	5600	124	5620	128	5640
132	5660	136	5680	140	5700	144	5720
149	5745	153	5765	157	5785	161	5805
165	5825	--	--	--	--	--	--

802.11n/ac-40 MHz Center Working Frequency of Each Channel:

Channel	Frequency (MHz)	Channel	Frequency (MHz)	Channel	Frequency (MHz)	Channel	Frequency (MHz)
38	5190	46	5230	54	5270	62	5310
102	5510	110	5550	118	5590	126	5630
134	5670	142	5710	151	5755	159	5795

802.11ac-80 MHz Center Working Frequency of Each Channel:

Channel	Frequency (MHz)	Channel	Frequency (MHz)	Channel	Frequency (MHz)	Channel	Frequency (MHz)
42	5210	58	5290	106	5530	122	5610
138	5690	155	5775	--	--	--	--

Note:

1. The EUT is a PanaCast 50 Video Bar System with a built-in WLAN (802.11a/b/g/n/ac) with Bluetooth LE 、 V2.1+EDR transceiver.
2. Regarding to the operation frequency band, the lowest, middle, and highest frequency are selected to perform the test.
3. This device is a composite device in accordance with Part 15 regulations. The function for the transmitting was measured and made a test report that the report number is 2330787R-RFUSV01S-A, 2330787R-RFUSV01S-B, 2330787R-RFUSV01S-C and 2330787R-RFUSV03S-A, certified under FCC ID: BCE-VSM040.
4. DEKRA verified the construction and function in typical operation. All the test modes were carried out with the EUT in normal operation, which was shown in this test report and defined as:

Test Mode	Mode 1	Receive
-----------	--------	---------

1.2. Test System Details

The types for all equipment, plus descriptions of all cables used in the tested system (including inserted cards) are:

Product	Manufacturer	Model No.	Serial No.	Power Cord
1 Power Adapter	Jabra	WH-231	N/A	N/A
2 Monitor	Lenovo	A21215FS0	V5DMD987	Non-Shielded, 1.8m
3 Notebook PC	DELL	Latitude 5501	9V4JL13	N/A
4 DVD PLAYER	SAMPO	DVB-123	12527058	Non-Shielded, 1.8m
5 FLASH	SanDisk	16GB Ultra Flair CZ73	N/A	N/A
6 FLASH	SanDisk	16GB Ultra Flair CZ73	N/A	N/A

Cable Type	Cable Description
A Power Cable	Non-shielded, 2m
B HDMI Cable	Shielded, 1.8m
C HDMI Cable	Shielded, 4.6m
D LAN Cable	Non-shielded, 1.6m
E USB Cable	Shielded, 4.6m
F Audio Cable	Shielded, 1.8m
G HDMI Cable	Shielded, 1.8m

1.3. Configuration of Test System

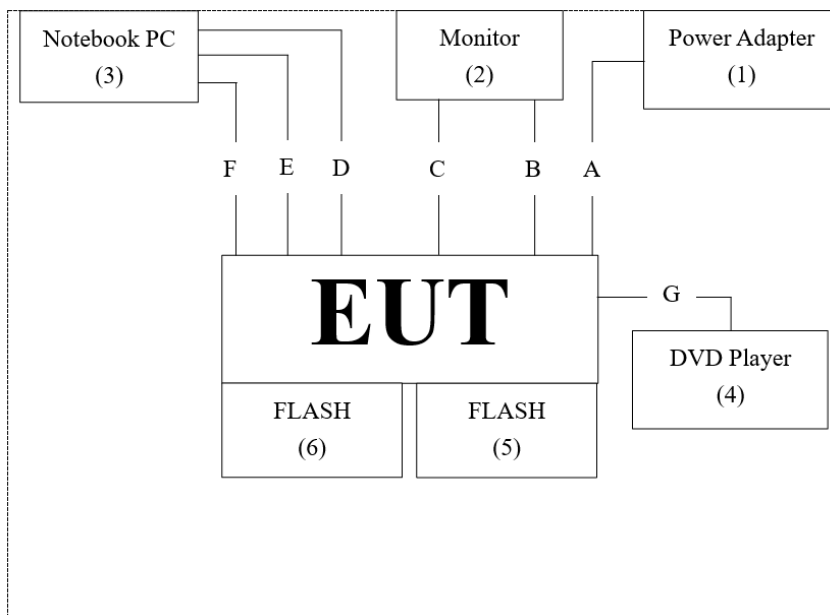

1.4. EUT Exercise Software

1	Setup the EUT as shown in Section 1.3.
2	Execute software “QRCT Version 4.0.209.0” on the EUT.
3	Configure the test mode, the test channel, and the data rate.
4	Press “OK” to start the continuous Transmit.
5	Verify that the EUT works properly.

1.5. Test Facility

Ambient conditions in the laboratory:

Performed Item	Items	Required	Actual
Conducted Emission	Temperature (°C)	10~40 °C	22.5 °C
	Humidity (%RH)	10~90 %	48.6 %
Radiated Emission	Temperature (°C)	10~40 °C	22.5 °C
	Humidity (%RH)	10~90 %	48.6 %

USA	FCC Registration Number: TW0033
Canada	CAB Identifier Number: TW3023 / Company Number: 26930

Site Description	Accredited by TAF
	Accredited Number: 3023

Test Laboratory	DEKRA Testing and Certification Co., Ltd.
	Linkou Laboratory
Address	No.5-22, Ruishukeng Linkou District, New Taipei City, 24451, Taiwan, R.O.C.
Performed Location	No. 26, Huaya 1st Rd., Guishan Dist., Taoyuan City 333411, Taiwan, R.O.C.
Phone Number	+886-3-275-7255
Fax Number	+886-3-327-8031

1.6. List of Test Item and Equipment

For Conduction Measurements / HY-SR01

	Equipment	Manufacturer	Model No.	Serial No.	Cal. Date	Due Date
V	EMI Test Receiver	R&S	ESR7	101601	2022/06/23	2023/06/22
V	Two-Line V-Network	R&S	ENV216	101306	2023/03/16	2024/03/15
V	Two-Line V-Network	R&S	ENV216	101307	2022/07/04	2023/07/03
V	Coaxial Cable	SUHNER	RG400_BNC	RF001	2022/05/24	2023/05/23

Note:

1. All equipments are calibrated every one year.
2. The test instruments marked with “V” are used to measure the final test results.
3. Test Software Version: e3 230303 dekra V9.

For Radiated Measurements / HY-CB03

	Equipment	Manufacturer	Model No.	Serial No.	Cal. Date	Due Date
V	Loop Antenna	AMETEK	HLA6121	49611	2023/02/21	2024/02/20
V	Bi-Log Antenna	SCHWARZBECK	VULB9168	9168-675	2021/08/11	2023/08/10
V	Horn Antenna	RF SPIN	DRH18-E	210508A18ES	2022/06/08	2023/06/07
V	Horn Antenna	Com-Power	AH-840	101100	2021/10/04	2023/10/03
V	Pre-Amplifier	SGH	0301	20211007-10	2023/01/10	2024/01/09
V	Pre-Amplifier	SGH	PRAMP118	20200701	2023/01/10	2024/01/09
V	Pre-Amplifier	EMCI	EMC05820SE	980310	2023/01/10	2024/01/09
V	Pre-Amplifier	EMCI	EMC184045SE	980369	2023/01/10	2024/01/09
	Coaxial Cable	EMCI	EMC102-KM-KM-600	1160314		
	Coaxial Cable	EMCI	EMC102-KM-KM-7000	170242		
	Filter	MICRO TRONICS	BRM50702	G269	2023/01/05	2024/01/04
V	Filter	MICRO TRONICS	BRM50716	G196	2023/01/05	2024/01/04
V	EMI Test Receiver	R&S	ESR3	102793	2022/12/05	2023/12/04
V	Spectrum Analyzer	R&S	FSV3044	101114	2023/02/16	2024/02/15
V	Coaxial Cable	SGH	SGH18	2021005-1	2023/01/10	2024/01/09
	Coaxial Cable	SGH	SGH18	202108-4		
	Coaxial Cable	SGH	HA800	GD20110223-1		
	Coaxial Cable	SGH	HA800	GD20110222-3		

Note:

1. Bi-Log Antenna and Horn Antenna(AH-840) is calibrated every two years, the other equipments are calibrated every one year.
2. The test instruments marked with “V” are used to measure the final test results.
3. Test Software Version: e3 230303 dekra V9.

1.7. Uncertainty

Uncertainties have been calculated according to the DEKRA internal document.

The reported expanded uncertainties are based on a standard uncertainty multiplied by a coverage factor of $k=2$, providing a level of confidence of approximately 95%.

Measurement uncertainties evaluated for each testing system and associated connections are given here to provide the system information for reference. Compliance determinations do not take into account measurement uncertainties for each testing system, but are based on the results of the compliance measurement.

Test item	Uncertainty
Conducted Emission	± 3.50 dB
Radiated Emission	9 kHz~30 MHz: ± 3.88 dB 30 MHz~1 GHz: ± 4.42 dB 1 GHz~18 GHz: ± 4.28 dB 18 GHz~40 GHz: ± 3.90 dB

2. Conducted Emission

2.1. Test Setup

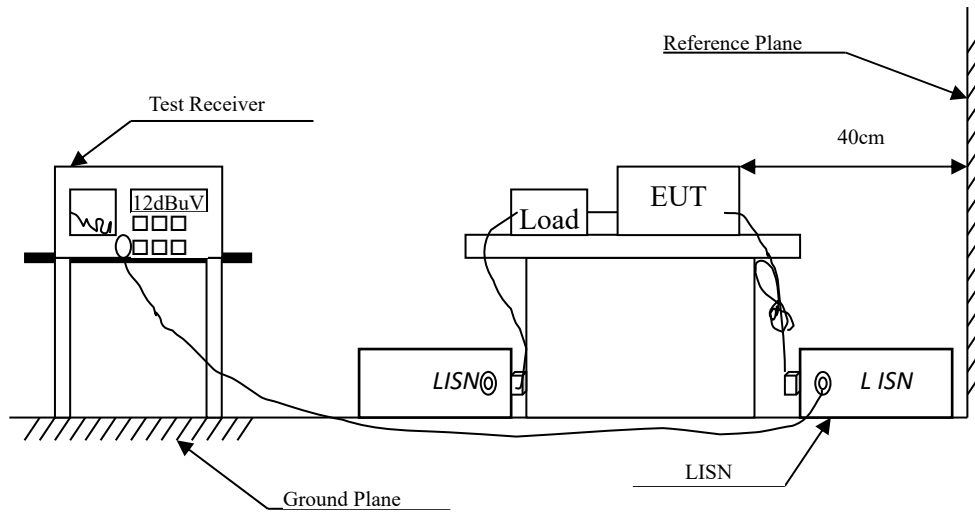

2.2. Limits

FCC Part 15 Subpart B Paragraph 15.107 (dB μ V) Limit		
Frequency MHz	Limits	
	QP	AV
0.15 - 0.50	66-56	56-46
0.50-5.0	56	46
5.0 - 30	60	50

Remarks: In the above table, the tighter limit applies at the band edges.

2.3. Test Procedure

The EUT and simulators are connected to the main power through a line impedance stabilization network (L.I.S.N.). This provides a 50 ohm /50uH coupling impedance for the measuring equipment. The peripheral devices are also connected to the main power through a LISN that provides a 50ohm /50uH coupling impedance with 50ohm termination. (Please refers to the block diagram of the test setup and photographs.)

Both sides of A.C. line are checked for maximum conducted interference. In order to find the maximum emission, the relative positions of equipment and all of the interface cables must be changed according to ANSI C63.4: 2014 on conducted measurement.

Conducted emissions were investigated over the frequency range from 0.15MHz to 30MHz using a receiver bandwidth of 9kHz.

2.4. Test Result of Conducted Emission

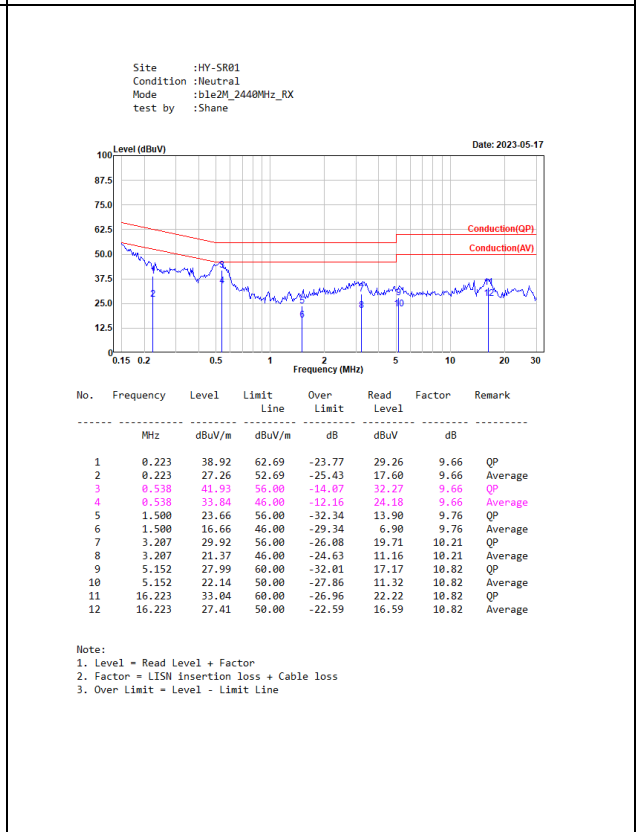
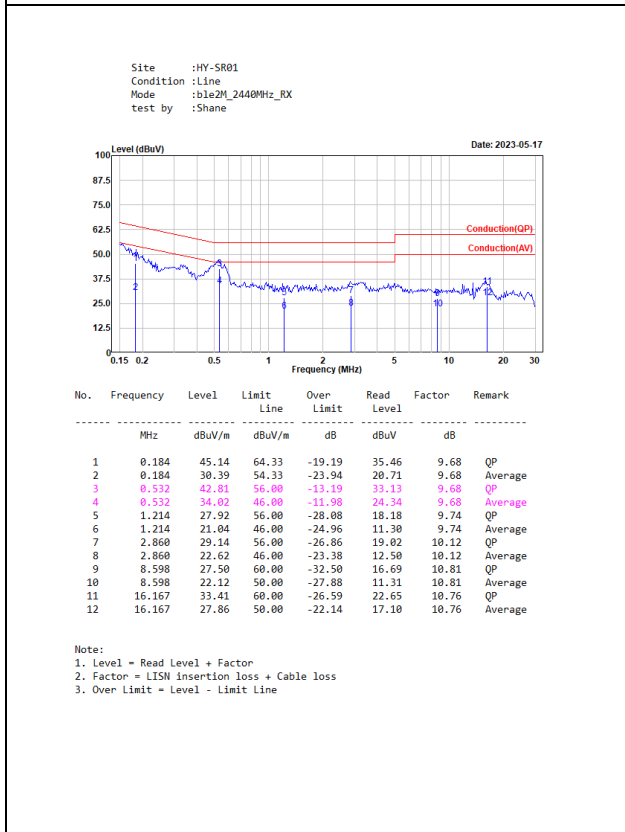
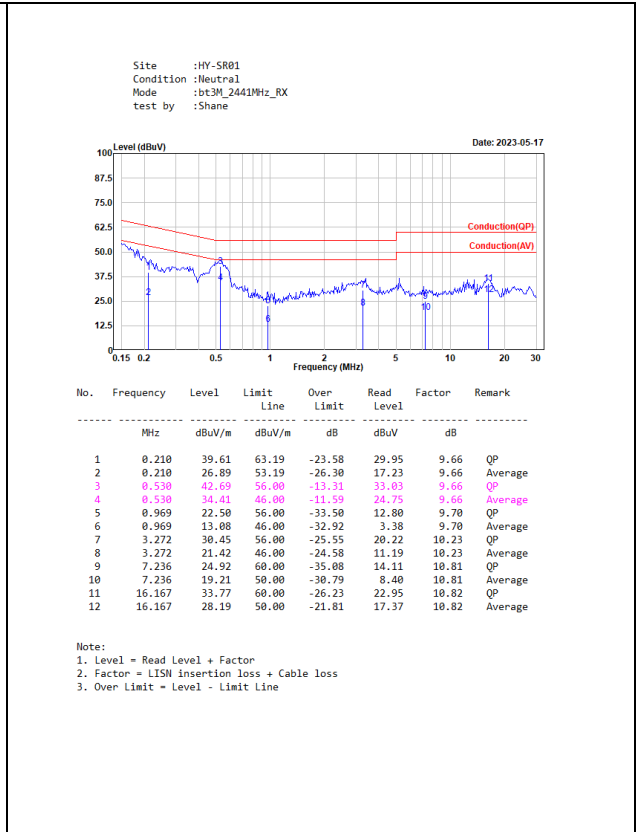
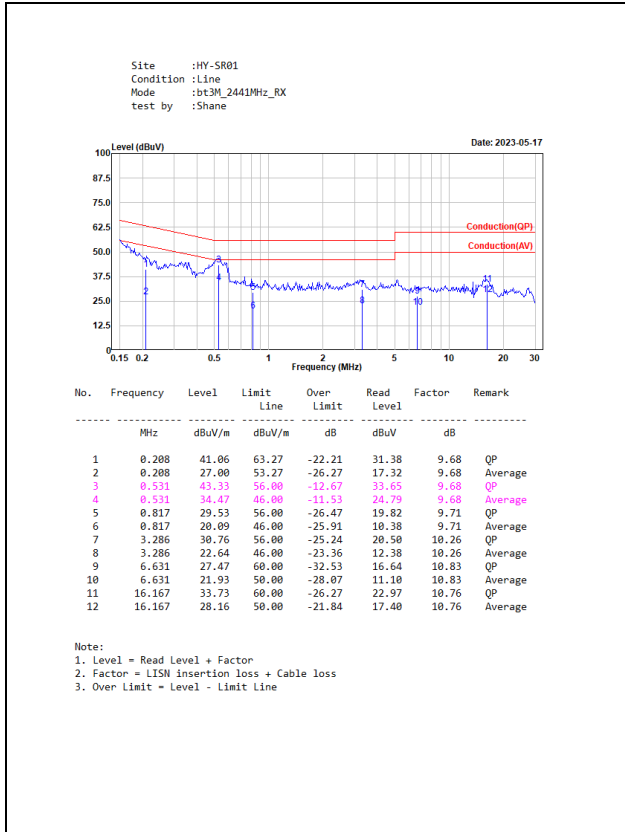

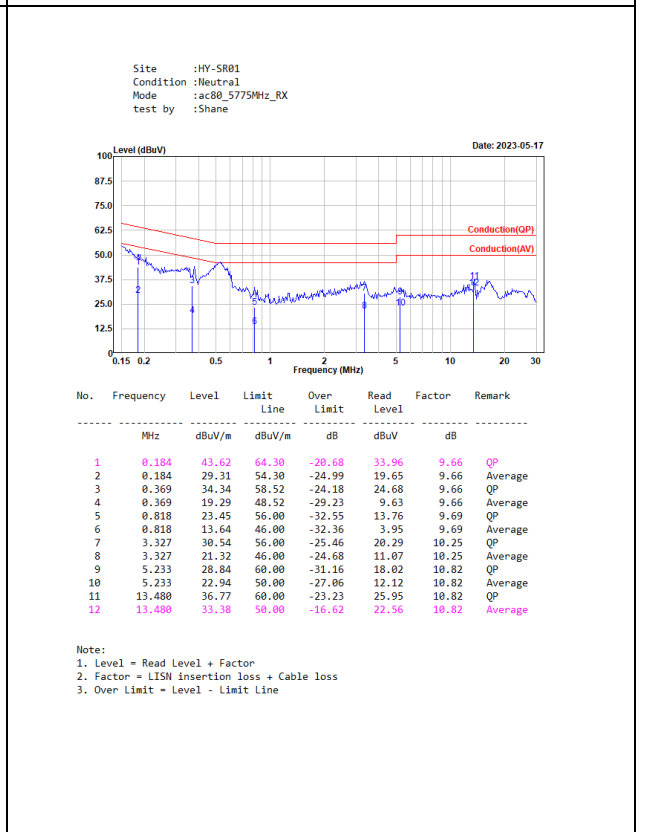
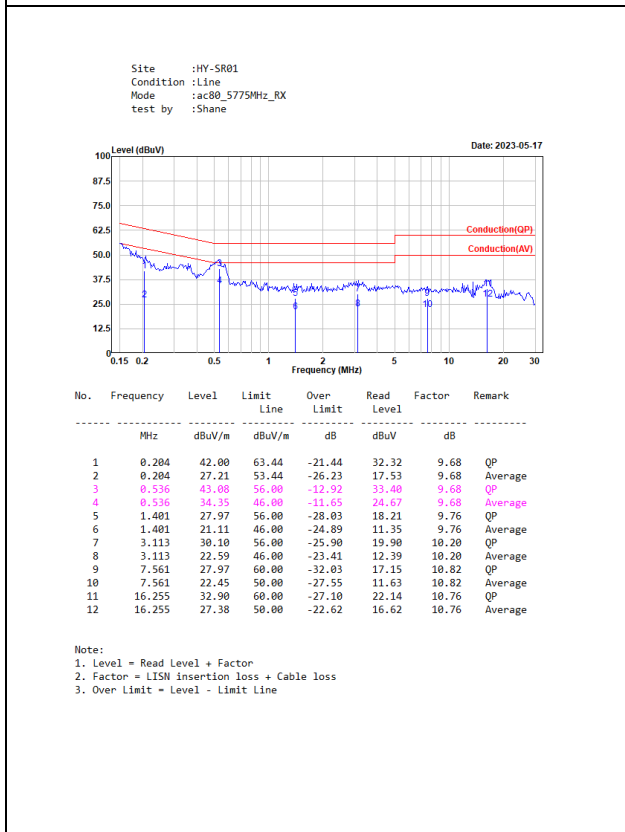
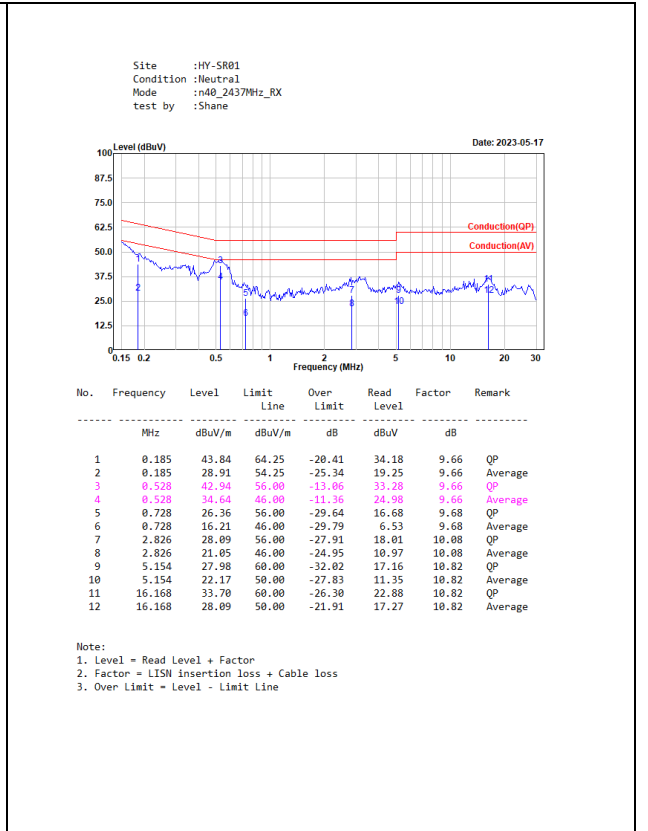
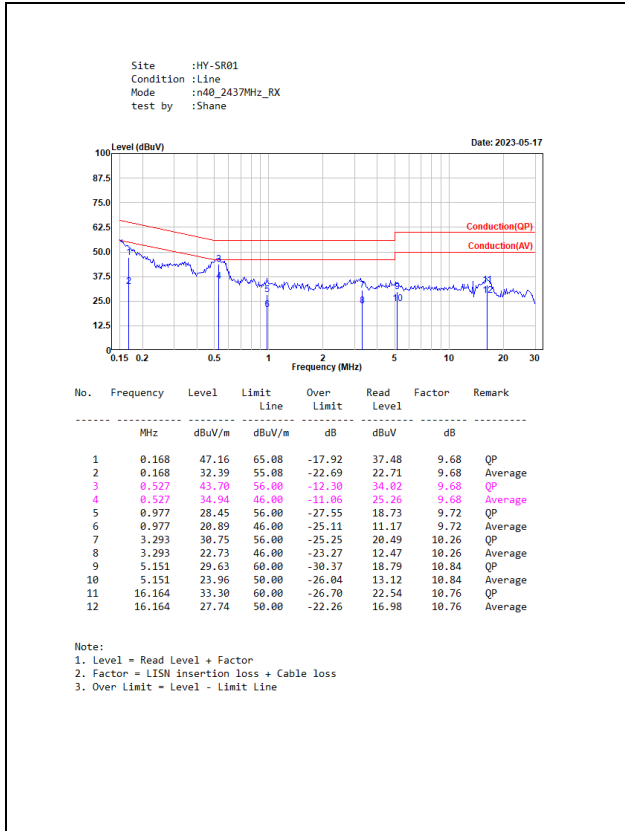

3. Radiated Emission

3.1. Test Setup

Radiated Emission Below 1 GHz

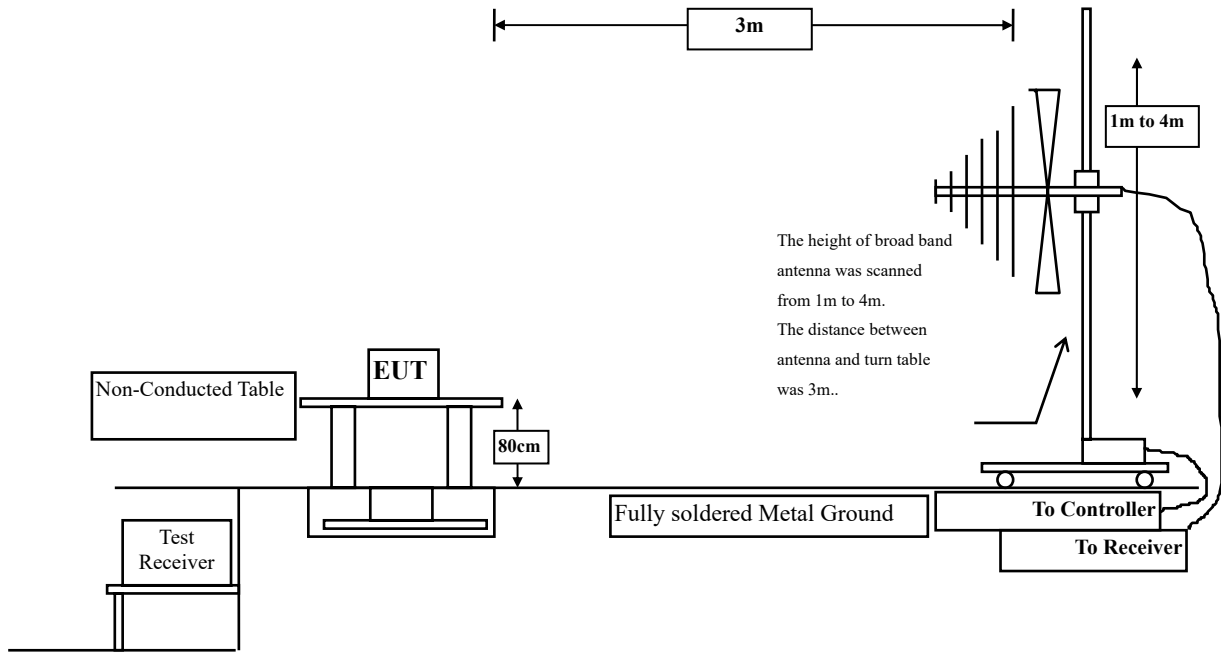

Radiated Emission Above 1 GHz

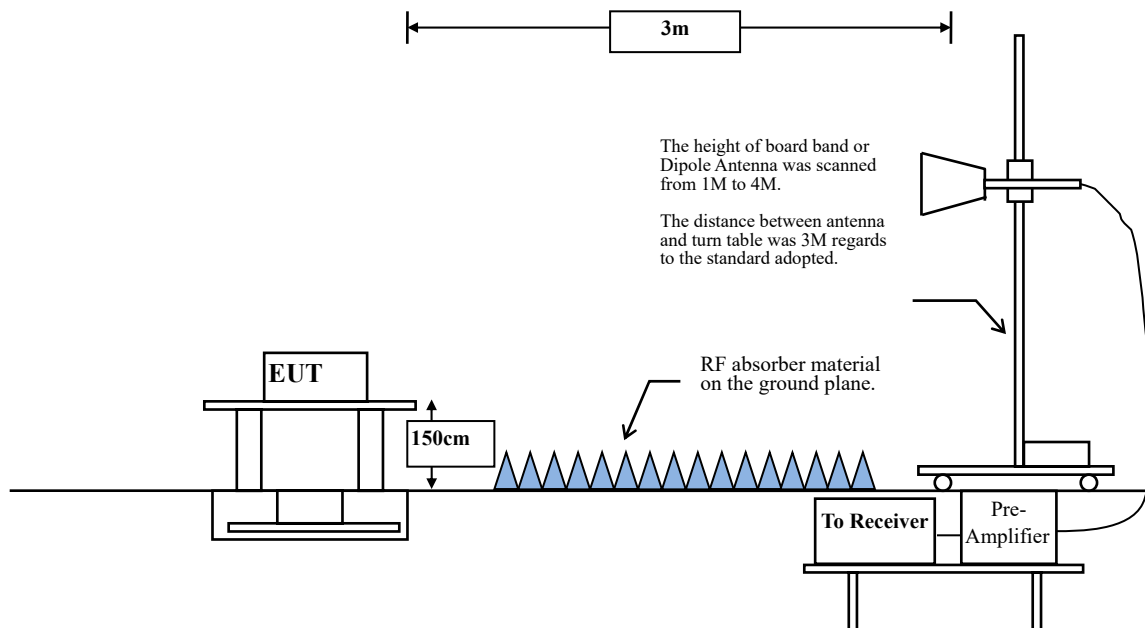

3.2. Limits

FCC Part 15 Subpart B Paragraph 15.109 Limits		
Frequency MHz	$\mu\text{V}/\text{m}$ @3m	$\text{dB}\mu\text{V} / \text{m}@3\text{m}$
30-88	100	40
88-216	150	43.5
216-960	200	46
Above 960	500	54

Remarks: 1. RF Voltage ($\text{dB}\mu\text{V}$) = $20 \log$ RF Voltage (μV)

2. In the Above Table, the tighter limit applies at the band edges.

3. Distance refers to the distance in meters between the measuring instrument antenna and the closed point of any part of the device or system.

3.3. Test Procedure

Measuring the frequency range below 1GHz, the EUT is placed on a turn table which is 0.8 meter above ground, when measuring the frequency range above 1GHz, the EUT is placed on a turn table which is 1.5 meter above ground.

The turn table can rotate 360 degrees to determine the position of the maximum emission level.

The EUT was positioned such that the distance from antenna to the EUT was 3 meters.

The antenna can move up and down between 1 meter and 4 meters to find out the maximum emission level.

Both horizontal and vertical polarization of the antenna are set on measurement. In order to find the maximum emission, all of the interface cables must be manipulated according to ANSI C63.10: 2013 on radiated measurement.

The resolution bandwidth below 1GHz setting on the field strength meter is 120 kHz and above 1GHz is 1MHz. Radiated emission measurements below 1GHz are made using broadband Bilog antenna and above 1GHz are made using Horn Antennas.

The measurement is divided into the Preliminary Measurement and the Final Measurement.

The suspected frequencies are searched for in Preliminary Measurement with the measurement antenna kept pointed at the source of the emission both in azimuth and elevation, with the polarization of the antenna oriented for maximum response. The antenna is pointed at an angle towards the source of the emission, and the EUT is rotated in both height and polarization to maximize the measured emission. The emission is kept within the illumination area of the 3 dB bandwidth of the antenna.

The measurement frequency range from 30MHz - 10th Harmonic of fundamental was investigated.

3.4. Test Result of Radiated Emission

