

Jabra GN

USER MANUAL



PANACAST 50

Video Bar System

Technology for life's new rhythm

© 2023 GN Audio A/S. All rights reserved. Jabra® is a trademark of GN Audio A/S. The Bluetooth® word mark and logos are registered trademarks owned by the Bluetooth SIG, Inc. and any use of such marks by GN Audio A/S is under license.

Made in China

MODEL:



Declaration of Conformity can be found on www.jabra.com/doc

1. Welcome.....	4	6.4 Dynamic Composition	
2. Overview.....	5	6.5 Field of view	
2.1 Jabra PanaCast 50 Video Bar Base Unit overview		6.6 Pan, Tilt, Zoom presets - only for Zoom Rooms	
2.2 Jabra PanaCast Control overview		6.7 Image quality settings	
2.3 Included accessories - Jabra PanaCast 50 Video Bar Base Unit		6.8 Video flicker	
2.4 Included accessories - Jabra PanaCast Control		7. Share content.....	23
2.5 Optional accessories		8. Safety capacity settings.....	24
3. Hardware setup overview	12	9. Update firmware.....	25
4. Visual indicators.....	14	10.Support	26
5. Settings management.....	15	10.1 FAQ and technical specifications	
6. Video settings.....	17	10.2 How to care for your Jabra device	
6.1 Intelligent Zoom		10.3 How to factory reset - Jabra PanaCast 50 Video Bar System Base Unit	
6.2 Virtual Director		10.4 How to factory reset - Jabra PanaCast Control	
6.3 Panoramic View - Manual			

1. Welcome

Thank you for using the Jabra PanaCast 50 Video Bar System. We hope you will enjoy it!

Here are some key features you will benefit from the Jabra PanaCast 50 Video Bar System:

- World-class audio with full duplex and powerful stereo speakers
- Unique 180° full room coverage in high-definition Panoramic-4K for a more natural view of the meeting room
- Access to an easier meeting experience with the touchscreen-activated PanaCast Control
- Certified for the strict requirements of Microsoft Teams Rooms and Zoom Rooms to connect, share, and collaborate seamlessly and securely
- On-device AI that powers a range of intelligent features for immersive and natural virtual collaboration

2. Overview

2.1 Jabra PanaCast 50 Video Bar Base Unit overview

FRONT SIDE

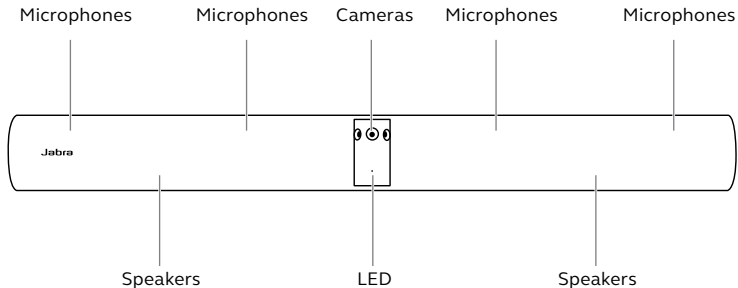

BACK SIDE

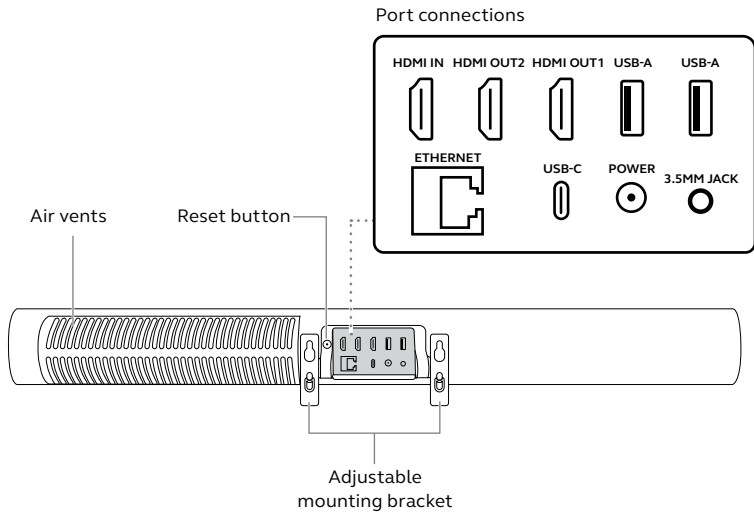

2.2 Jabra PanaCast Control overview

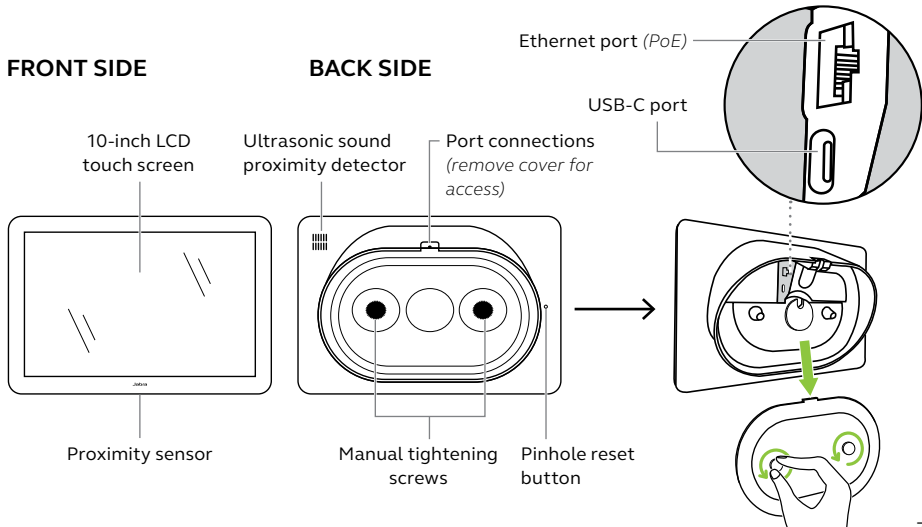

2.3 Included accessories - Jabra PanaCast 50 Video Bar Base Unit

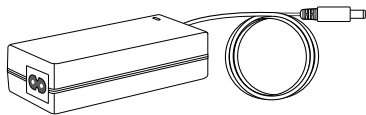

AC power adapter (1.83m/6ft)



AC power cable
(1m/3.28ft)

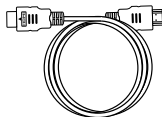

HDMI cable
(1.83m/6ft)

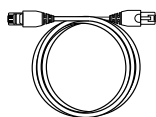

RJ45 Ethernet cable
(4.57m/15ft)

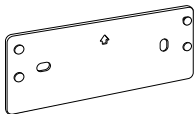

Wall mount



Camera privacy cover

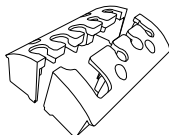

Cable compartment cover (2 pcs)
& **embedded screws** (4 pcs)
& **screwdriver**



Additional accessories can be purchased at jabra.com/accessories.

2.4 Included accessories - Jabra PanaCast Control

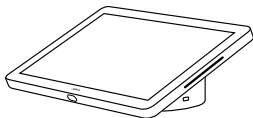

Touch controller

POWER OVER ETHERNET (PoE) KIT

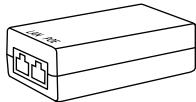

PoE injector

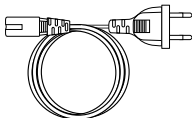

AC power cable
(1m/3.28ft)

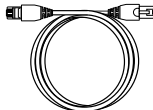

RJ45 Ethernet cable (2 pcs)
(4.57m/15ft)

Additional accessories can be purchased at jabra.com/accessories.

2.5 Optional accessories

Accessories can be purchased at jabra.com/accessories.

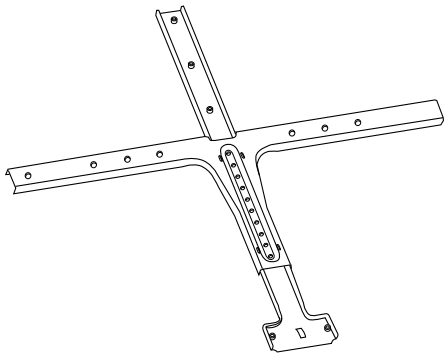

Screen mount

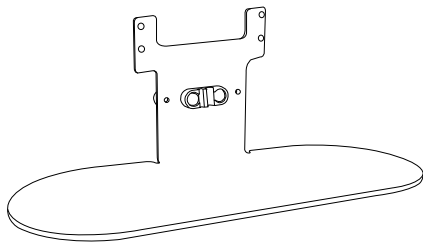
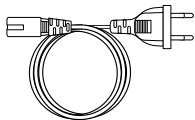
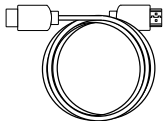

Table stand

Accessories can be purchased at jabra.com/accessories.



**Regional power
cords**(1m/3.28ft)



HDMI cable
(1.83m/6ft)

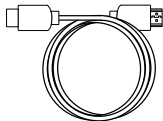

**HDMI ingest
cable**
(4.57m/15ft)

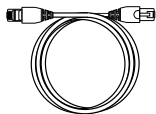

**RJ45 Ethernet
cable**
(4.57m/15ft)



USB-A to C cable
(4.57m/15ft)



USB-A to B cable
(1.83m/6ft)



**Touch controller
table mount**

3. Hardware setup overview

This is an overview of the steps required to set up the Jabra PanaCast Video Bar System.

1. Mount the video bar.

Refer to the assembly videos or assembly instructions.

2. Connect the cables.

Refer to the cabling instructions available in the Installation manual.

3. Set up the touch controller.

Follow the setup wizard displayed on the touch controller. During the last step of the configuration, it is necessary to log into the video conferencing account of your service provider.

4. Manage settings and devices.

Access the Web console by entering the IP address of the video bar and the password. If this is the first time accessing the Web Console, the default username is admin and the password is the last 6 digits of the video bar serial number.

To access the Jabra PanaCast 50 Video Bar System manuals, assembly videos and instructions, go to jabra.com/support or jabra.com/help/panacast50vbs/getstarted.

4. Visual indicators

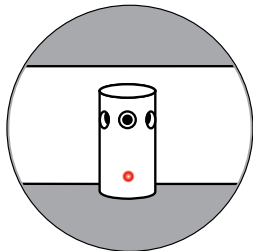
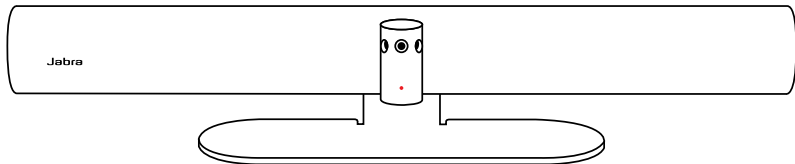

LED STATUS

Off or not streaming	(LED off)
Starting up	○ (flashing white)
Connected	○ (on for 3 seconds)
In call or streaming video/media	○
In call, audio muted	●
Firmware updating	● (flashing pink)

5. Settings management

After the Jabra PanaCast 50 Video Bar System configuration process is completed, the touch controller will display the video conferencing app of your service provider.

To access the settings of the touch controller, go to **the admin device settings menu** in the video conferencing app.

Basic settings and **general information** of the touch controller will be displayed.

Advanced settings of the touch controller are available when logging in as an administrator. If this is the first login, the default username is **admin** and the password is the **last 6 digits of the touch controller serial number**.

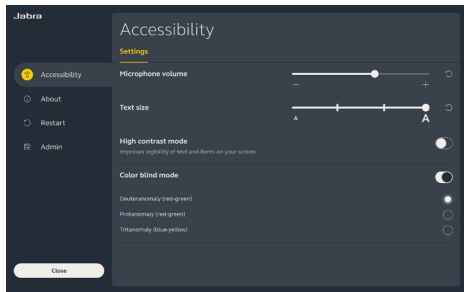

All Jabra PanaCast 50 Video Bar System settings can be configured using the Web Console.

To access the Web Console, enter the IP address of the video bar in a browser. The IP address is displayed on the monitor connected to the video bar.

If this is the first time accessing the Web Console, the default username is **admin** and the password is the **last 6 digits of the video bar serial number**.

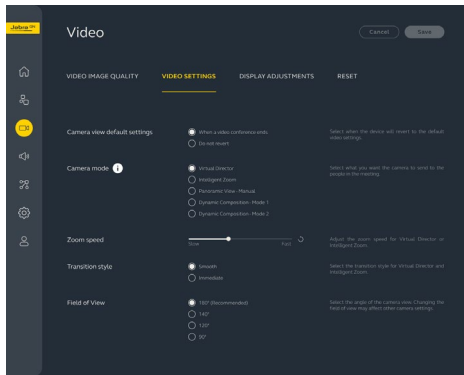

6. Video settings

Administrators can remotely configure the video conferencing settings through the Web Console or directly in the touch controller through the admin device settings menu in the video conferencing app.

6.1 Intelligent Zoom

Intelligent Zoom is a Camera mode that dynamically frames all visible people within 4.5 meters (15 feet).

Only one Camera mode can be active at a time. By default, Camera mode is set to Intelligent Zoom.

6.2 Virtual Director

Virtual Director is a Camera mode that features Speaker tracking, focusing on whomever is speaking in the camera view.

6.3 Panoramic View - Manual

Panoramic View - Manual is a Camera mode that displays a panoramic view of the meeting room.

6.4 Dynamic Composition

Dynamic Composition is an advanced Camera mode that displays up to 4 participants in a meeting room in a tiled view. The tiled view will dynamically update to display the participants who are actively speaking.

-Dynamic Composition - Mode 1
Displays up to 4 participants in a gallery view

-Dynamic Composition - Mode 2
Displays a view of the whole room, the person speaking, and the previous person speaking in a gallery view.

If this Camera mode is selected, a reboot of the device is required.



6.5 Field of view

The angle of the camera can be optically adjusted for a wider or narrower view of the meeting room.

By default, **Field of view** is set to 180°.

6.6 Pan, Tilt, Zoom presets - only for Zoom Rooms

Pan, Tilt, Zoom presets allow administrators to adjust and save the camera view using the touch controller. Saved presets do not overwrite the default Pan, Tilt, Zoom settings. Users can select saved presets when a new meeting starts.

6.7 Image quality settings

The image brightness, contrast, saturation, sharpness, and white balance can be adjusted in the Web Console or using the touch controller through the admin device settings menu in the video conferencing app.

Additionally, Vivid HDR and Automatic white balance can be enabled. If Vivid HDR is enabled, contrast, saturation, and sharpness cannot be adjusted manually. If Automatic white balance is enabled, the white balance cannot be adjusted manually.

6.8 Video flicker

Video flicker can occur if the Jabra PanaCast 50 Video Bar System is not set to the correct geographical region. To prevent video flicker, select Auto (50Hz/60Hz) for regions that support NTSC format, or 50Hz for regions that support PAL format.

By default, **Video flicker** is set to Auto.

7. Share content

The touch controller has both Bluetooth® technology and an ultrasonic sound proximity detector that allows users to share content directly from their computers or mobile devices.

When sharing content using a Bluetooth® connection, the mobile device must be within 10 meters (32.8 feet) of the touch controller.

8. Safety capacity settings

The JabraPanaCast 50 Video Bar System works together with the video conferencing app to monitor the safety capacity limit of a meeting room.

These settings are configured and managed directly in the web portal of your video conferencing service provider.

9. Update firmware

Firmware updates improve performance or add new functionality to Jabra devices. Jabra PanaCast 50 Video Bar System firmware updates are available using the Web Console or the touch controller.

10.Support

10.1 FAQ and technical specifications

View the FAQ, certifications, and technical specifications at jabra.com/help/panacast50vbs

10.2 How to care for your Jabra device

The Jabra PanaCast 50 Video Bar System is for indoor use only.

- Avoid direct sunlight and temperatures above 40°C/104°F or below 0°C/32°F.
- Do not expose the camera or cables to rain or other liquids.
- Do not position the devices near the vents of a monitor or TV as this may cause the devices to overheat and malfunction.
- Clean the cloth surface with a cloth dampened with a mild soap solution.

10.3 How to factory reset - Jabra PanaCast 50 Video Bar System Base Unit

Resetting will restore the video bar to its factory default settings.

Press and hold the **Reset** button on the back of the video bar for 15 seconds until the LED flashes pink and the 'factory data reset' message is displayed on the monitor.

The video bar will restart and play an audio notification when ready for use. The reboot takes approximately 1 minute.

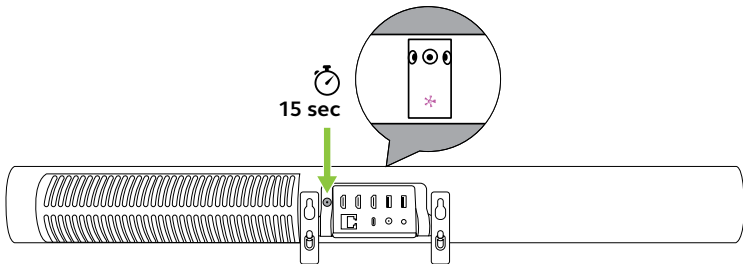

10.4 How to factory reset - Jabra PanaCast Control

Resetting will restore the touch controller to its factory default settings.

Use a paperclip to press and hold the **Pinhole reset** button on the back of the touch controller for 15 seconds until the 'factory data reset' message is displayed on the screen.

The reboot takes approximately 1 minute.

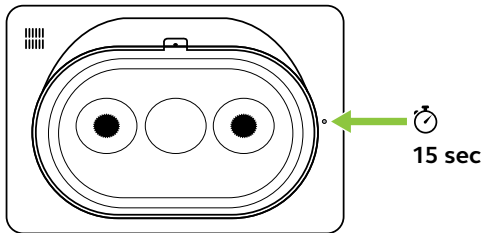

To learn more about the Jabra PanaCast 50 Video Bar System,
go to **jabra.com/help/panacast50vbs/getstarted**