



Test report No.: 2330787R-RFUSV01S-B

TEST REPORT

Product Name	PanaCast 50 Video Bar System
Trademark	Jabra
Model and /or type reference	VSM040
FCC ID	BCE-VSM040
Applicant's name / address	GN Audio USA Inc. 900 Chelmsfort St, Tower 2, Floor 8 , Lowell, Massachusetts, 01851 United States
Manufacturer's name	GN Audio A/S
Test method requested, standard	FCC CFR Title 47 Part 15 Subpart C ANSI C63.4: 2014, ANSI C63.10: 2013
Verdict Summary	IN COMPLIANCE
Documented By (Senior Project Specialist / April Chen)	<i>April Chen</i>
Tested By (Senior Engineer / Ivan Chuang)	<i>Ivan Chuang</i>
Approved By (Senior Engineer / Alan Chen)	<i>Alan Chen</i>
Date of Receipt	2023/03/22
Date of Issue	2023/05/24
Report Version	V1.0

INDEX

	Page
1. General Information	6
1.1. EUT Description.....	6
1.2. Tested System Details.....	8
1.3. Configuration of Tested System	8
1.4. EUT Exercise Software	8
1.5. Test Facility	9
1.6. List of Test Equipment.....	10
1.7. Uncertainty	11
2. Conducted Emission	12
2.1. Test Setup	12
2.2. Limits.....	12
2.3. Test Procedure	12
2.4. Test Result of Conducted Emission.....	13
3. Peak Power Output.....	14
3.1. Test Setup	14
3.2. Limit	14
3.3. Test Procedure	14
3.4. Test Result of Peak Power Output.....	15
4. Radiated Emission	17
4.1. Test Setup	17
4.2. Limits.....	18
4.3. Test Procedure	19
4.4. Test Result of Radiated Emission.....	20
5. RF Antenna Conducted Test	33
5.1. Test Setup	33
5.2. Limits.....	33
5.3. Test Procedure	33
5.4. Test Result of RF Antenna Conducted Test.....	34
6. Band Edge.....	36
6.1. Test Setup	36
6.2. Limit	37

6.3.	Test Procedure	37
6.4.	Test Result of Band Edge	38
7.	Channel Number	50
7.1.	Test Setup	50
7.2.	Limit	50
7.3.	Test Procedure	50
7.4.	Test Result of Channel Number.....	51
8.	Channel Separation.....	53
8.1.	Test Setup	53
8.2.	Limit	53
8.3.	Test Procedure	53
8.4.	Test Result of Channel Separation.....	54
9.	Dwell Time	56
9.1.	Test Setup	56
9.2.	Limit	56
9.3.	Test Procedure	56
9.4.	Test Result of Dwell Time	57
10.	Occupied Bandwidth.....	59
10.1.	Test Setup	59
10.2.	Limits.....	59
10.3.	Test Procedure	59
10.4.	Test Result of Occupied Bandwidth	60
11.	Duty Cycle.....	62
11.1.	Test Setup	62
11.2.	Test Result of Duty Cycle.....	63

Appendix 1: EUT Test Photographs

Appendix 2: Product Photos-Please refer to the file: 2330878R-Product Photos

Competences and Guarantees

DEKRA is a testing laboratory competent to carry out the tests described in this report.

In order to assure the traceability to other national and international laboratories, DEKRA has a calibration and maintenance program for its measurement equipment.

DEKRA guarantees the reliability of the data presented in this report, which is the result of the measurements and the tests performed to the item under test on the date and under the conditions stated in the report and it is based on the knowledge and technical facilities available at DEKRA at the time of performance of the test.

DEKRA is liable to the client for the maintenance of the confidentiality of all information related to the item under test and the results of the test.

The results presented in this Test Report apply only to the particular item under test established in this document.

IMPORTANT: No parts of this report may be reproduced or quoted out of context, in any form or by any means, except in full, without the previous written permission of DEKRA.

General conditions

1. The test results relate only to the samples tested.
2. The test results shown in the test report are traceable to the national/international standard through the calibration report of the equipment and evaluated measurement uncertainty herein.
3. This report must not be used to claim product endorsement by TAF or any agency of the government.
4. The test report shall not be reproduced without the written approval of DEKRA Testing and Certification Co., Ltd.
5. Measurement uncertainties evaluated for each testing system and associated connections are given here to provide the system information for reference. Compliance determinations do not take into account measurement uncertainties for each testing system, but are based on the results of the compliance measurement.

Revision History

Report No.	Version	Description	Issued Date
2330787R-RFUSV01S-B	V1.0	Initial issue of report.	2023/05/24

1. General Information

1.1. EUT Description

Product Name	PanaCast 50 Video Bar System
Trademark	Jabra
Model and /or type reference	VSM040
EUT Rated Voltage	AC 100-240V, 50-60Hz
EUT Test Voltage	AC 120V/50Hz
Frequency Range	2402 - 2480 MHz
Channel Number	79 CH
Type of Modulation	GFSK(1 Mbps) / π /4DQPSK(2 Mbps) / 8DPSK(3 Mbps)
Channel Control	Auto
Power Cord	Non-shielded, 1m
Adapter	MFR: Jabra, M/N: WH-231 Input: AC 100-240V~1.5A 50/60Hz Output: 12V $\overline{=}$ 5A 60W Cable out: Non-shielded, 2m

Antenna List

No.	Manufacturer	Part No.	Antenna Type	Peak Gain
1	Wistron	025.9022Y.0001 (Main)	PCB	2.83 dBi for 2400 MHz
		025.90230.0001 (Aux)		0.07 dBi for 2400 MHz

Note: The antenna of EUT conforms to FCC 15.203.

Center Frequency of Each Channel:

Channel	Frequency (MHz)	Channel	Frequency (MHz)	Channel	Frequency (MHz)	Channel	Frequency (MHz)
00	2402	01	2403	02	2404	03	2405
04	2406	05	2407	06	2408	07	2409
08	2410	09	2411	10	2412	11	2413
12	2414	13	2415	14	2416	15	2417
16	2418	17	2419	18	2420	19	2421
20	2422	21	2423	22	2424	23	2425
24	2426	25	2427	26	2428	27	2429
28	2430	29	2431	30	2432	31	2433
32	2434	33	2435	34	2436	35	2437
36	2438	37	2439	38	2440	39	2441
40	2442	41	2443	42	2444	43	2445
44	2446	45	2447	46	2448	47	2449
48	2450	49	2451	50	2452	51	2453
52	2454	53	2455	54	2456	55	2457
56	2458	57	2459	58	2460	59	2461
60	2462	61	2463	62	2464	63	2465
64	2466	65	2467	66	2468	67	2469
68	2470	69	2471	70	2472	71	2473
72	2474	73	2475	74	2476	75	2477
76	2478	77	2479	78	2480	--	--

Note:

1. The EUT is a PanaCast 50 Video Bar System with built-in WLAN and Bluetooth transceiver, this report for Bluetooth V2.1+EDR.
2. Bluetooth signal is only transmitted by Main antenna port.
4. Regarding to the operation frequency, the lowest, middle and highest frequency are selected to perform the test.
5. DEKRA has evaluated each test mode. Only the worst case is shown in the report.
6. These tests were conducted on a sample for the purpose of demonstrating compliance of transmitter with Part 15 Subpart C Paragraph 15.247 for spread spectrum devices.
7. The test mode is based on the Bluetooth technology, while testing 1Mbps, 2Mbps and 3Mbps, the worst case is 1Mbps and 3Mbps, and only worse case data is recorded in this report.

Test Mode	Mode 1	Transmit - 1 Mbps
		Transmit - 3 Mbps

1.2. Tested System Details

The types for all equipment, plus descriptions of all cables used in the tested system (including inserted cards) are:

Product	Manufacturer	Model No.	Serial No.	Power Cord
1 Power Adapter	Jabra	WH-231	N/A	N/A
2 Monitor	Lenovo	A21215FS0	V5DMD987	Non-Shielded, 1.8m
3 Notebook PC	DELL	Latitude 5501	9V4JL13	N/A
4 DVD PLAYER	SAMPO	DVB-123	12527058	Non-Shielded, 1.8m
5 FLASH	SanDisk	16GB Ultra Flair CZ73	N/A	N/A
6 FLASH	SanDisk	16GB Ultra Flair CZ73	N/A	N/A

Cable Type	Cable Description
A Power Cable	Non-shielded, 2m
B HDMI Cable	Shielded, 1.8m
C HDMI Cable	Shielded, 4.6m
D LAN Cable	Non-shielded, 1.6m
E USB Cable	Shielded, 4.6m
F Audio Cable	Shielded, 1.8m
G HDMI Cable	Shielded, 1.8m

1.3. Configuration of Tested System

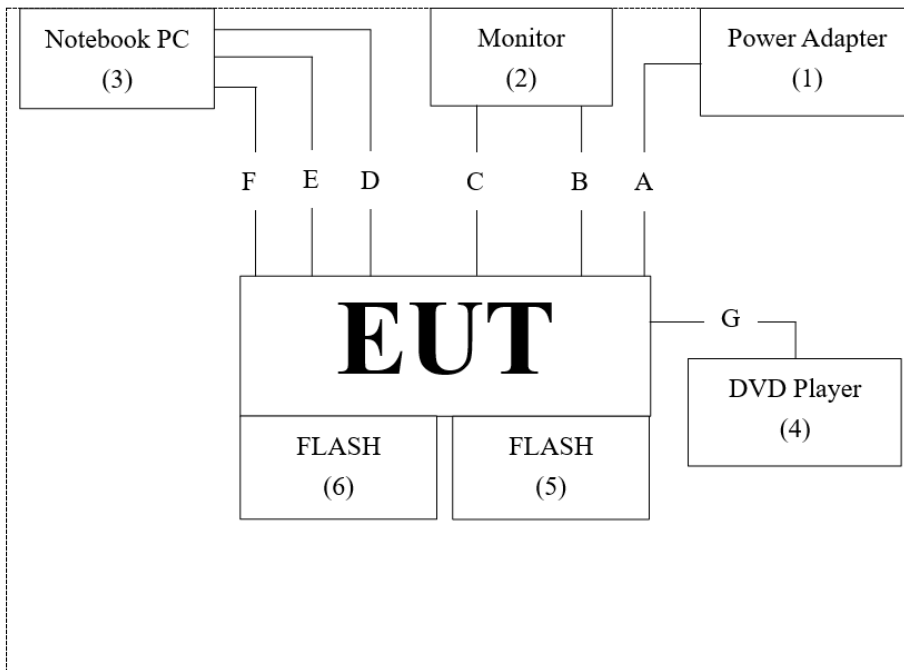

1.4. EUT Exercise Software

1	Setup the EUT as shown in Section 1.3.
2	Execute software “QRCT Version 4.0.209.0” on the EUT.
3	Configure the test mode, the test channel, and the data rate.
4	Press “OK” to start the continuous transmit.
5	Verify that the EUT works properly.

1.5. Test Facility

Ambient conditions in the laboratory:

Performed Item	Items	Required	Actual
Conducted Emission	Temperature (°C)	10~40 °C	26.8 °C
	Humidity (%RH)	10~90 %	45.9 %
Radiated Emission	Temperature (°C)	10~40 °C	23.5 °C
	Humidity (%RH)	10~90 %	65.3 %
Conductive	Temperature (°C)	10~40 °C	23.6 °C
	Humidity (%RH)	10~90 %	57.1 %

USA	FCC Registration Number: TW0033
Canada	CAB Identifier Number: TW3023 / Company Number: 26930

Site Description	Accredited by TAF
	Accredited Number: 3023

Test Laboratory	DEKRA Testing and Certification Co., Ltd.
	Linkou Laboratory
Address	No.5-22, Ruishukeng Linkou District, New Taipei City, 24451, Taiwan, R.O.C
Performed Location	No. 26, Huaya 1st Rd., Guishan Dist., Taoyuan City 333411, Taiwan, R.O.C.
Phone Number	+886-3-275-7255
Fax Number	+886-3-327-8031

1.6. List of Test Equipment

For Conduction Measurements / HY-SR01

	Equipment	Manufacturer	Model No.	Serial No.	Cal. Date	Due Date
V	EMI Test Receiver	R&S	ESR7	101601	2022/06/23	2023/06/22
V	Two-Line V-Network	R&S	ENV216	101306	2023/03/16	2024/03/15
V	Two-Line V-Network	R&S	ENV216	101307	2022/07/04	2023/07/03
V	Coaxial Cable	SUHNER	RG400 BNC	RF001	2022/05/24	2023/05/23

Note:

1. All equipments are calibrated every one year.
2. The test instruments marked with “V” are used to measure the final test results.
3. Test Software Version: e3 230303 dekra V9.

For Conducted Measurements / HY-SR02

	Equipment	Manufacturer	Model No.	Serial No.	Cal. Date	Due Date
V	Spectrum Analyzer	R&S	FSV30	103466	2022/12/22	2023/12/21
V	Peak Power Analyzer	KEYSIGHT	8990B	MY51000410	2022/08/06	2023/08/05
V	Wideband Power Sensor	KEYSIGHT	N1923A	MY56080003	2022/08/05	2023/08/04
V	Wideband Power Sensor	KEYSIGHT	N1923A	MY56080004	2022/08/05	2023/08/04

Note:

1. All equipments are calibrated every one year.
2. The test instruments marked with “V” are used to measure the final test results.
3. Test Software Version: RF Conducted Test Tools R3 V3.0.1.14.

For Radiated Measurements / HY-CB03

	Equipment	Manufacturer	Model No.	Serial No.	Cal. Date	Due Date
V	Loop Antenna	AMETEK	HLA6121	49611	2023/02/21	2024/02/20
V	Bi-Log Antenna	SCHWARZBECK	VULB9168	9168-675	2021/08/11	2023/08/10
V	Horn Antenna	RF SPIN	DRH18-E	210508A18ES	2022/06/08	2023/06/07
V	Horn Antenna	Com-Power	AH-840	101100	2021/10/04	2023/10/03
V	Pre-Amplifier	SGH	0301	20211007-10	2023/01/10	2024/01/09
V	Pre-Amplifier	SGH	PRAMP118	20200701	2023/01/10	2024/01/09
V	Pre-Amplifier	EMCI	EMC05820SE	980310	2023/01/10	2024/01/09
V	Pre-Amplifier	EMCI	EMC184045SE	980369	2023/01/10	2024/01/09
	Coaxial Cable	EMCI	EMC102-KM-KM-600	1160314		
	Coaxial Cable	EMCI	EMC102-KM-KM-7000	170242		
V	Filter	MICRO TRONICS	BRM50702	G269	2023/01/05	2024/01/04
	Filter	MICRO TRONICS	BRM50716	G196	2023/01/05	2024/01/04
V	EMI Test Receiver	R&S	ESR3	102793	2022/12/05	2023/12/04
V	Spectrum Analyzer	R&S	FSV3044	101114	2023/02/16	2024/02/15
V	Coaxial Cable	SGH	SGH18	2021005-1	2023/01/10	2024/01/09
	Coaxial Cable	SGH	SGH18	202108-4		
	Coaxial Cable	SGH	HA800	GD20110223-1		
	Coaxial Cable	SGH	HA800	GD20110222-3		

Note:

1. Bi-Log Antenna and Horn Antenna(AH-840) is calibrated every two years, the other equipments are calibrated every one year.
2. The test instruments marked with “V” are used to measure the final test results.
3. Test Software Version: e3 230303 dekra V9.

1.7. Uncertainty

Uncertainties have been calculated according to the DEKRA internal document.

The reported expanded uncertainties are based on a standard uncertainty multiplied by a coverage factor of $k=2$, providing a level of confidence of approximately 95%.

Measurement uncertainties evaluated for each testing system and associated connections are given here to provide the system information for reference. Compliance determinations do not take into account measurement uncertainties for each testing system but are based on the results of the compliance measurement.

Test item	Uncertainty
Conducted Emission	± 3.50 dB
Peak Power Output	Spectrum Analyzer: ± 2.14 dB Power Meter: ± 1.05 dB
Radiated Emission	9 kHz~30 MHz: ± 3.88 dB 30 MHz~1 GHz: ± 4.42 dB 1 GHz~18 GHz: ± 4.28 dB 18 GHz~40 GHz: ± 3.90 dB
RF Antenna Conducted Test	± 2.14 dB
Band Edge	9 kHz~30 MHz: ± 3.88 dB 30 MHz~1 GHz: ± 4.42 dB 1 GHz~18 GHz: ± 4.28 dB 18 GHz~40 GHz: ± 3.90 dB
Channel Number	N/A
Channel Separation	± 1580.61 Hz
Dwell Time	± 0.53 %
Occupied Bandwidth	± 1580.61 Hz
Duty Cycle	± 0.53 %

2. Conducted Emission

2.1. Test Setup

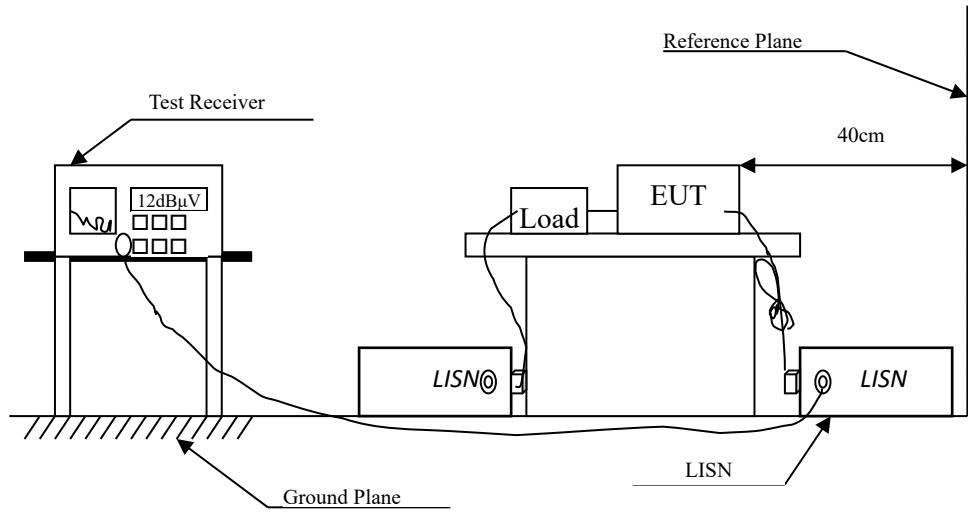

2.2. Limits

FCC Part 15 Subpart C Paragraph 15.207 (dBμV) Limit		
Frequency MHz	Limits	
	QP	AV
0.15 - 0.50	66-56	56-46
0.50 - 5.0	56	46
5.0 - 30	60	50

Remarks: In the above table, the tighter limit applies at the band edges.

2.3. Test Procedure

The EUT and Peripherals are connected to the main power through a line impedance stabilization network (L.I.S.N.). This provides a 50 ohm /50uH coupling impedance for the measuring equipment. The peripheral devices are also connected to the main power through a LISN that provides a 50ohm /50uH coupling impedance with 50ohm termination. (Please refer to the block diagram of the test setup and photographs.)

Both sides of A.C. line are checked for maximum conducted interference. In order to find the maximum emission, the relative positions of equipment and all the interface cables must be changed according to ANSI C63.4: 2014 on conducted measurement.

Conducted emissions were investigated over the frequency range from 0.15MHz to 30MHz using a receiver bandwidth of 9kHz.

The EUT setup and the test procedure are according to ANSI C63.4, 2014 to comply with the requirements of FCC 47CFR Subpart C.

2.4. Test Result of Conducted Emission

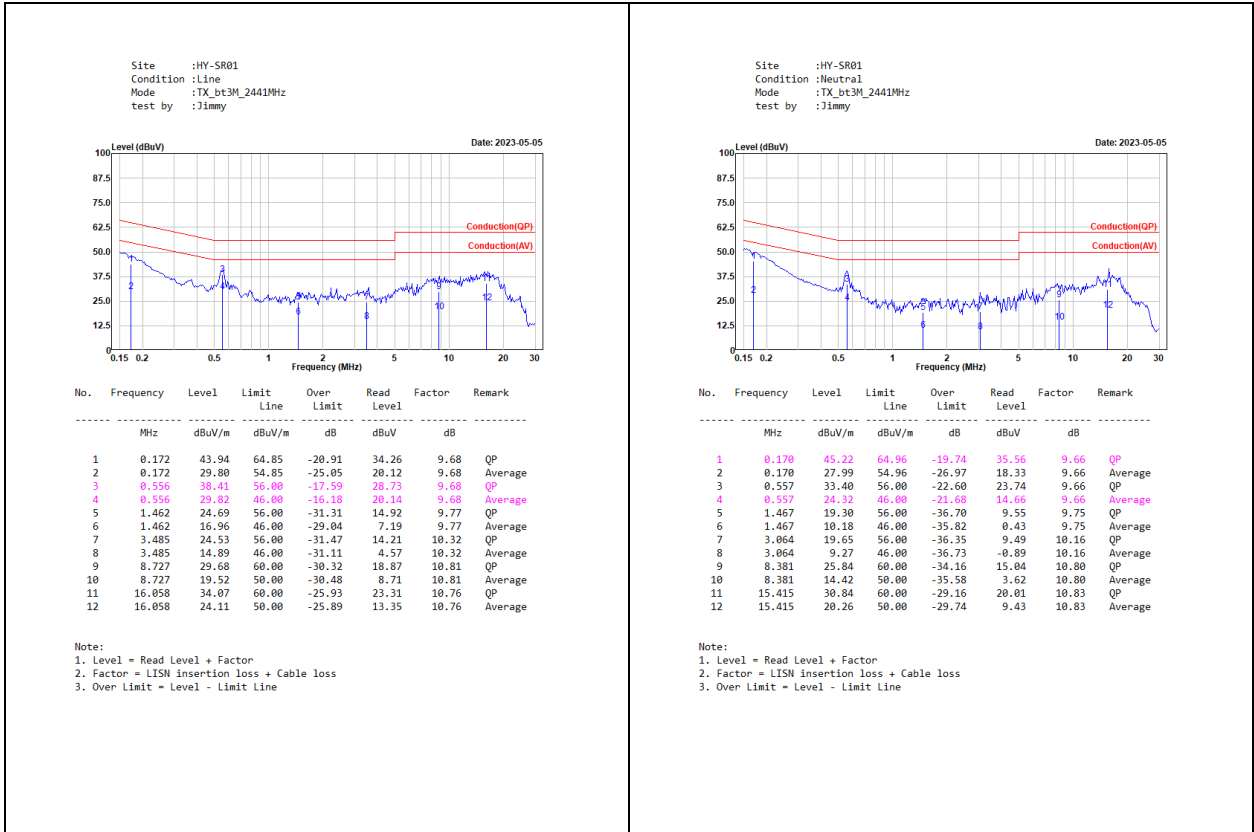

3. Peak Power Output

3.1. Test Setup

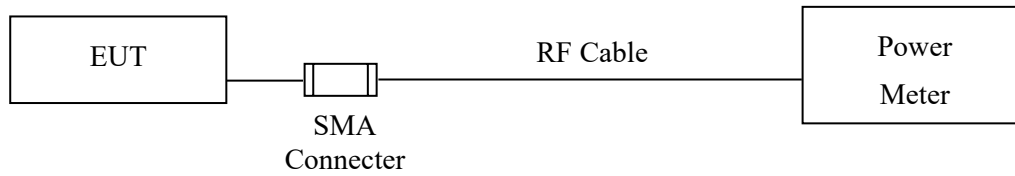

3.2. Limit

The maximum peak power shall be less 1 Watt, for all other frequency hopping systems in the 2400-2483.5MHz band: 0.125 watts.

3.3. Test Procedure

Tested according to FHSS test procedure of KDB 558074 section 9 (b for compliance to FCC 47CFR 15.247 requirements.

3.4. Test Result of Peak Power Output

Product : PanaCast 50 Video Bar System
Test Item : Peak Power Output
Test Mode : Transmit - 1 Mbps
Test Date : 2023/03/27

Channel No.	Frequency (MHz)	Measurement Level (dBm)	Required Limit	Result
00	2402	16.18	0.125Watt= 21 dBm	Pass
39	2441	17.67	0.125Watt= 21 dBm	Pass
78	2480	16.80	0.125Watt= 21 dBm	Pass

Product : PanaCast 50 Video Bar System
Test Item : Peak Power Output
Test Mode : Transmit - 3 Mbps
Test Date : 2023/03/27

Channel No.	Frequency (MHz)	Measurement Level (dBm)	Required Limit	Result
00	2402	15.70	0.125Watt= 21 dBm	Pass
39	2441	17.33	0.125Watt= 21 dBm	Pass
78	2480	16.46	0.125Watt= 21 dBm	Pass

4. Radiated Emission

4.1. Test Setup

Radiated Emission Under 30 MHz

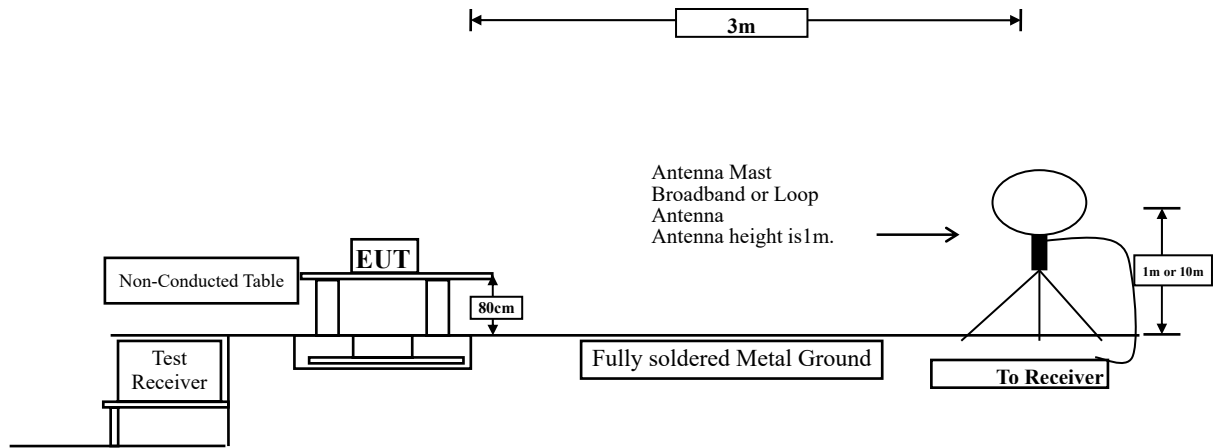

Radiated Emission Below 1 GHz

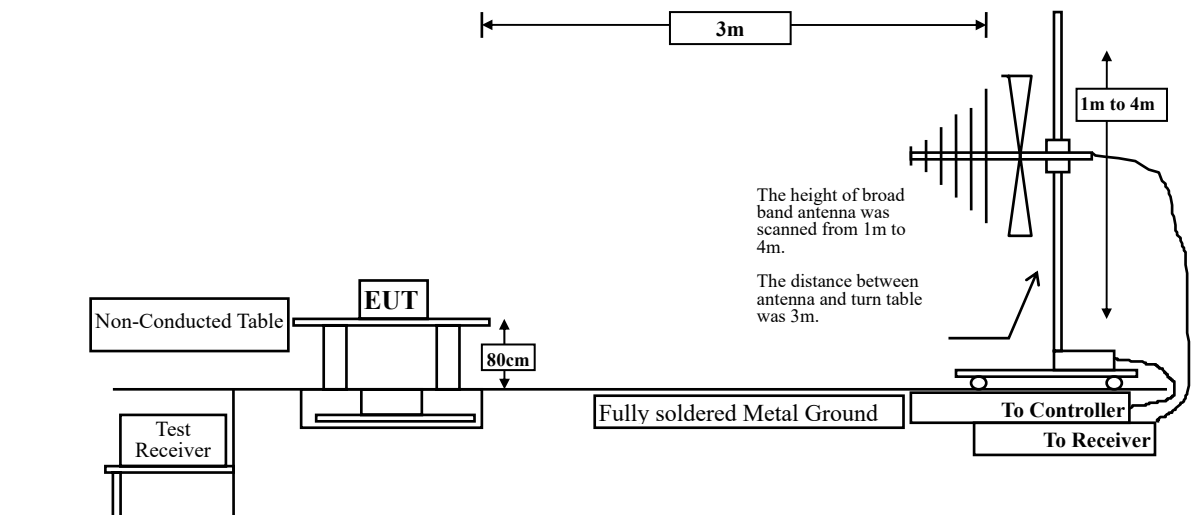

Radiated Emission Above 1 GHz

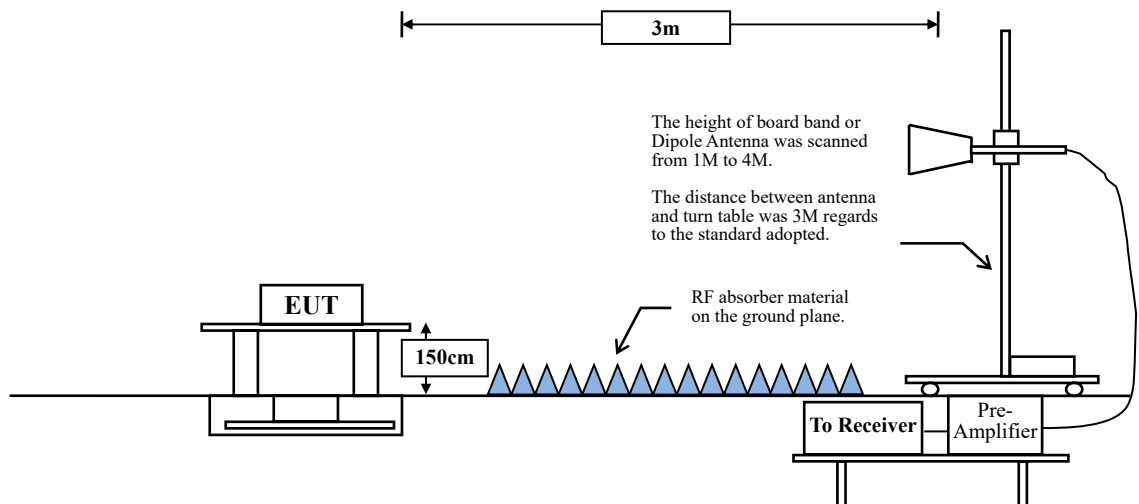

4.2. Limits

➤ **General Radiated Emission Limits**

Emissions radiated outside of the specified frequency bands, except for harmonics, shall be attenuated by at least 20dB below the level of the fundamental or to the general radiated emission limits in paragraph 15.209, whichever is the lesser attenuation.

FCC Part 15 Subpart C Paragraph 15.209 Limits		
Frequency MHz	Field strength (microvolts/meter)	Measurement distance (meter)
0.009-0.490	2400/F(kHz)	300
0.490-1.705	24000/F(kHz)	30
1.705-30	30	30
30-88	100	3
88-216	150	3
216-960	200	3
Above 960	500	3

Remarks:

1. RF Voltage (dB μ V) = 20 log RF Voltage (μ V)
2. In the Above Table, the tighter limit applies at the band edges.
3. Distance refers to the distance in meters between the measuring instrument antenna and the closed point of any part of the device or system.

4.3. Test Procedure

The EUT was setup according to ANSI C63.10, 2013 and tested compliance to FCC 47CFR 15.247 requirements.

Measuring the frequency range below 1 GHz, the EUT is placed on a turn table which is 0.8 meter above ground, when measuring the frequency range above 1GHz, the EUT is placed on a turn table which is 1.5 meter above ground.

The turn table is rotated 360 degrees to determine the position of the maximum emission level.

The EUT was positioned such that the distance from antenna to the EUT was 3 meters.

The antenna is scanned between 1 meter and 4 meters to find out the maximum emission level. This is repeated for both horizontal and vertical polarization of the antenna. In order to find the maximum emission, all of the interface cables were manipulated according to ANSI C63.10: 2013 on radiated measurement.

The resolution bandwidth below 30 MHz setting on the field strength meter is 9kHz and 30 MHz~1 GHz is 120 kHz and above 1 GHz is 1 MHz.

Radiated emission measurements below 30 MHz are made using Loop Antenna and 30 MHz~1 GHz are made using broadband Bilog antenna and above 1 GHz are made using Horn Antennas.

The measurement is divided into the Preliminary Measurement and the Final Measurement.

The suspected frequencies are searched for in Preliminary Measurement with the measurement antenna kept pointed at the source of the emission both in azimuth and elevation, with the polarization of the antenna oriented for maximum response. The antenna is pointed at an angle towards the source of the emission, and the EUT is rotated in both height and polarization to maximize the measured emission. The emission is kept within the illumination area of the 3 dB bandwidth of the antenna.

The measurement frequency range form 9 kHz - 10th Harmonic of fundamental was investigated.

4.4. Test Result of Radiated Emission

Site :HY-CB03
 Condition :3m ,HORIZONTAL
 Mode :TX_bt1M_2402MHz
 Test BY :Peter

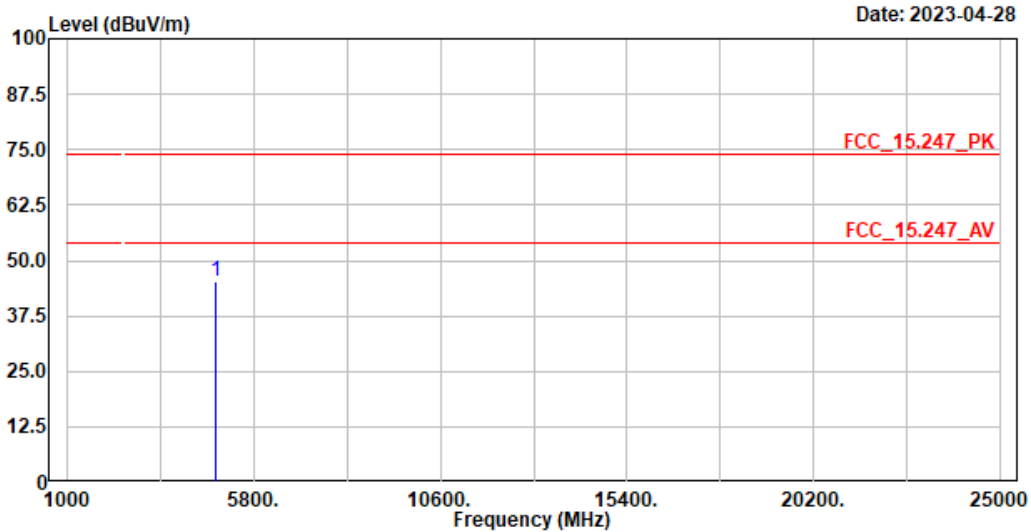

No.	Frequency	Level	Limit	Over	Read	Factor	Remark
	MHz	dBuV/m	dBuV/m	dB	dBuV	dB	
1	4804.000	45.37	74.00	-28.63	59.56	-14.19	Peak

Note:

1. Level = Read Level + Factor
2. Factor = Antenna Factor + Cable Loss - Preamp Factor
3. Over Limit = Level - Limit Line
4. The emission levels of other frequencies are very lower than the limit and not show in test report.

Horizontal-Average Detector:

Frequency (MHz)	Peak Measurement (dBμV/m)	Duty Cycle Factor (dB)	Measurement Level (dBμV/m)	Margin (dB)	Limit (dBμV/m)
--	--	--	--	--	--

Site :HY-CB03
 Condition :3m ,VERTICAL
 Mode :TX_bt1M_2402MHz
 Test BY :Peter

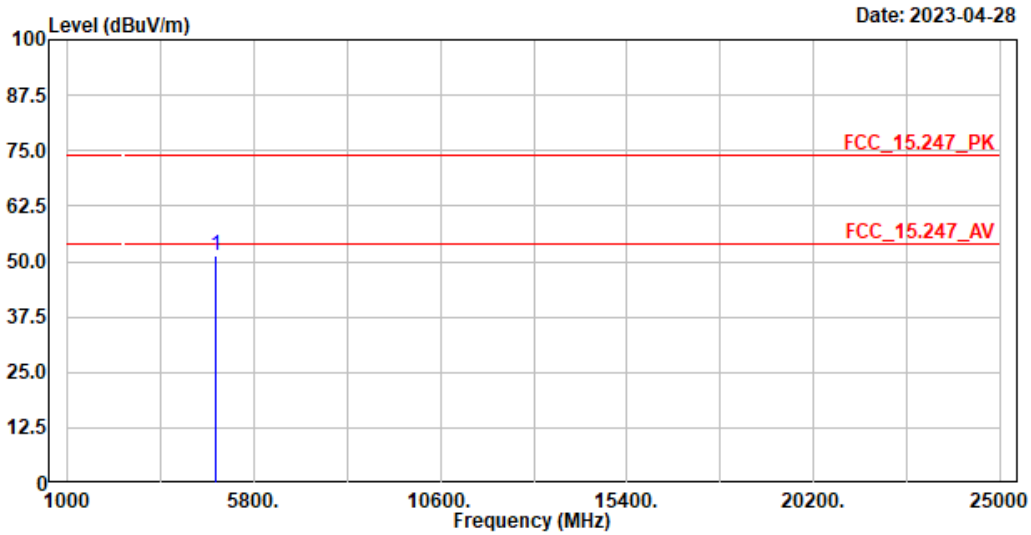

Date: 2023-04-28

No.	Frequency	Level	Limit	Over	Read	Factor	Remark
	MHz	dBuV/m	dBuV/m	dB	dBuV	dB	
1	4804.000	51.49	74.00	-22.51	65.68	-14.19	Peak

Note:

1. Level = Read Level + Factor
2. Factor = Antenna Factor + Cable Loss - Preamp Factor
3. Over Limit = Level - Limit Line
4. The emission levels of other frequencies are very lower than the limit and not show in test report.

Vertical-Average Detector:

Frequency (MHz)	Peak Measurement (dBμV/m)	Duty Cycle Factor (dB)	Measurement Level (dBμV/m)	Margin (dB)	Limit (dBμV/m)
--	--	--	--	--	--

Site :HY-CB03
 Condition :3m ,HORIZONTAL
 Mode :TX_bt1M_2441MHz
 Test BY :Peter

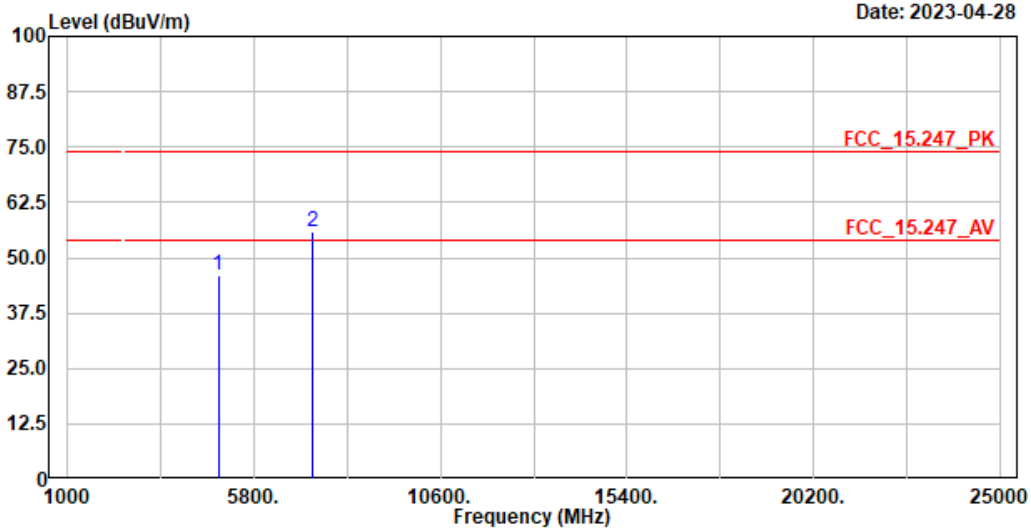

No.	Frequency	Level	Limit	Over	Read	Factor	Remark
	MHz	dBuV/m	dBuV/m	dB	dBuV	dB	
1	4882.000	45.87	74.00	-28.13	59.91	-14.04	Peak
2	7323.000	55.72	74.00	-18.28	62.47	-6.75	Peak

Note:

1. Level = Read Level + Factor
2. Factor = Antenna Factor + Cable Loss - Preamp Factor
3. Over Limit = Level - Limit Line
4. The emission levels of other frequencies are very lower than the limit and not show in test report.

Horizontal-Average Detector:

Frequency (MHz)	Peak Measurement (dBμV/m)	Duty Cycle Factor (dB)	Measurement Level (dBμV/m)	Margin (dB)	Limit (dBμV/m)
7323	55.72	-24.734	30.986	-23.014	54.000

Site :HY-CB03
 Condition :3m ,VERTICAL
 Mode :TX_bt1M_2441MHz
 Test BY :Peter

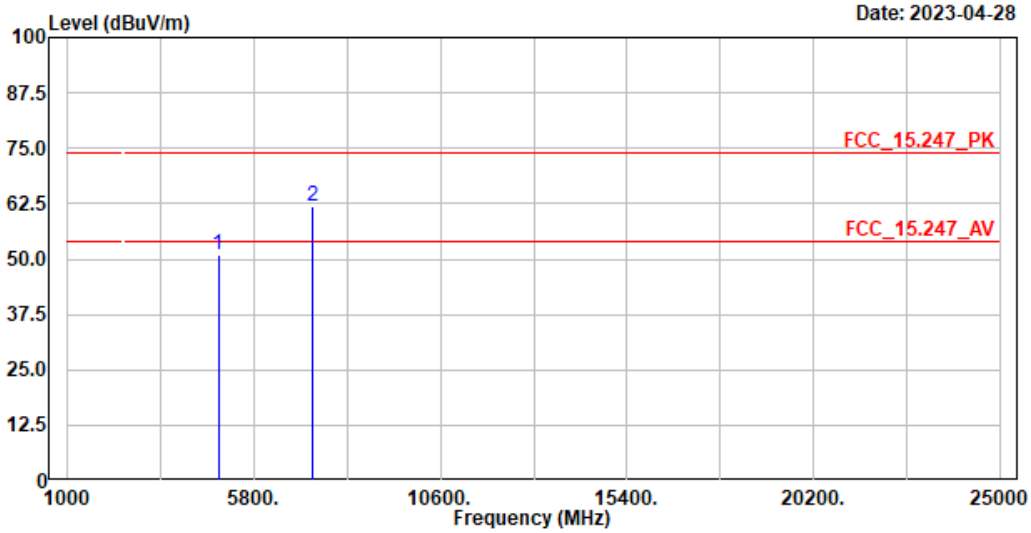

No.	Frequency	Level	Limit Line	Over Limit	Read Level	Factor	Remark
	MHz	dBuV/m	dBuV/m	dB	dBuV	dB	
1	4882.000	50.89	74.00	-23.11	64.93	-14.04	Peak
2	7323.000	61.73	74.00	-12.27	68.48	-6.75	Peak

Note:

1. Level = Read Level + Factor
2. Factor = Antenna Factor + Cable Loss - Preamp Factor
3. Over Limit = Level - Limit Line
4. The emission levels of other frequencies are very lower than the limit and not show in test report.

Vertical-Average Detector:

Frequency (MHz)	Peak Measurement (dBμV/m)	Duty Cycle Factor (dB)	Measurement Level (dBμV/m)	Margin (dB)	Limit (dBμV/m)
7323	61.73	-24.734	36.996	-17.004	54.000

Site :HY-CB03
 Condition :3m ,HORIZONTAL
 Mode :TX_bt1M_2480MHz
 Test BY :Peter

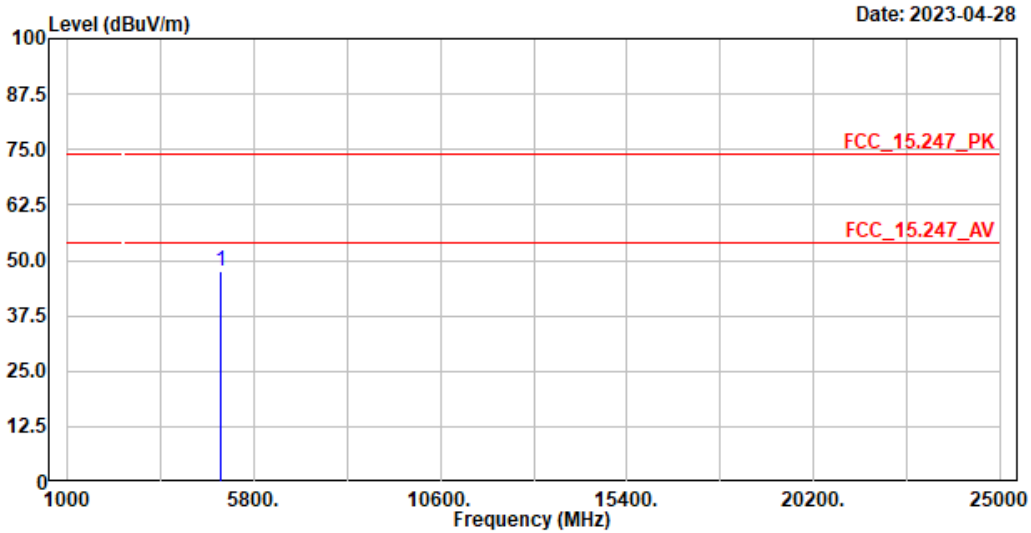

No.	Frequency	Level	Limit	Over	Read	Factor	Remark
	MHz	dBuV/m	dBuV/m	dB	dBuV	dB	
1	4960.000	47.46	74.00	-26.54	61.22	-13.76	Peak

Note:

1. Level = Read Level + Factor
2. Factor = Antenna Factor + Cable Loss - Preamp Factor
3. Over Limit = Level - Limit Line
4. The emission levels of other frequencies are very lower than the limit and not show in test report.

Horizontal-Average Detector:

Frequency (MHz)	Peak Measurement (dBμV/m)	Duty Cycle Factor (dB)	Measurement Level (dBμV/m)	Margin (dB)	Limit (dBμV/m)
--	--	--	--	--	--

Site :HY-CB03
 Condition :3m ,VERTICAL
 Mode :TX_bt1M_2480MHz
 Test BY :Peter

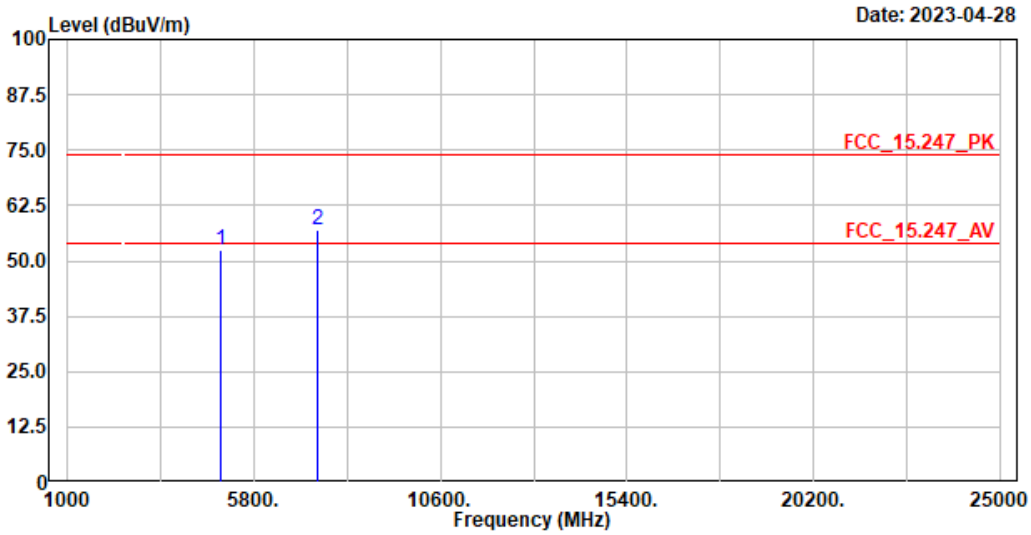

No.	Frequency	Level	Limit	Over	Read	Factor	Remark
	MHz	dBuV/m	dBuV/m	dB	dBuV	dB	
1	4960.000	52.44	74.00	-21.56	66.20	-13.76	Peak
2	7440.000	56.83	74.00	-17.17	63.58	-6.75	Peak

Note:

1. Level = Read Level + Factor
2. Factor = Antenna Factor + Cable Loss - Preamp Factor
3. Over Limit = Level - Limit Line
4. The emission levels of other frequencies are very lower than the limit and not show in test report.

Vertical-Average Detector:

Frequency (MHz)	Peak Measurement (dBμV/m)	Duty Cycle Factor (dB)	Measurement Level (dBμV/m)	Margin (dB)	Limit (dBμV/m)
7440	56.83	-24.734	32.096	-21.904	54.000

Site :HY-CB03
 Condition :3m ,HORIZONTAL
 Mode :TX_bt3M_2402MHz
 Test BY :Peter

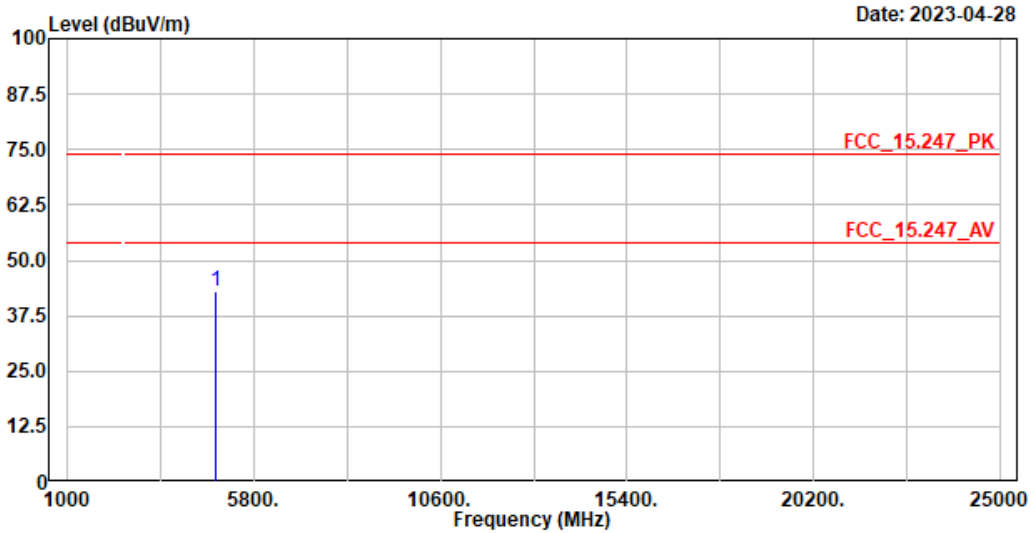

Date: 2023-04-28

No.	Frequency	Level	Limit Line	Over Limit	Read Level	Factor	Remark
	MHz	dBuV/m	dBuV/m	dB	dBuV	dB	
1	4804.000	43.08	74.00	-30.92	57.27	-14.19	Peak

Note:

1. Level = Read Level + Factor
2. Factor = Antenna Factor + Cable Loss - Preamp Factor
3. Over Limit = Level - Limit Line
4. The emission levels of other frequencies are very lower than the limit and not show in test report.

Horizontal-Average Detector:

Frequency (MHz)	Peak Measurement (dBμV/m)	Duty Cycle Factor (dB)	Measurement Level (dBμV/m)	Margin (dB)	Limit (dBμV/m)
--	--	--	--	--	--

Site :HY-CB03
 Condition :3m ,VERTICAL
 Mode :TX_bt3M_2402MHz
 Test BY :Peter

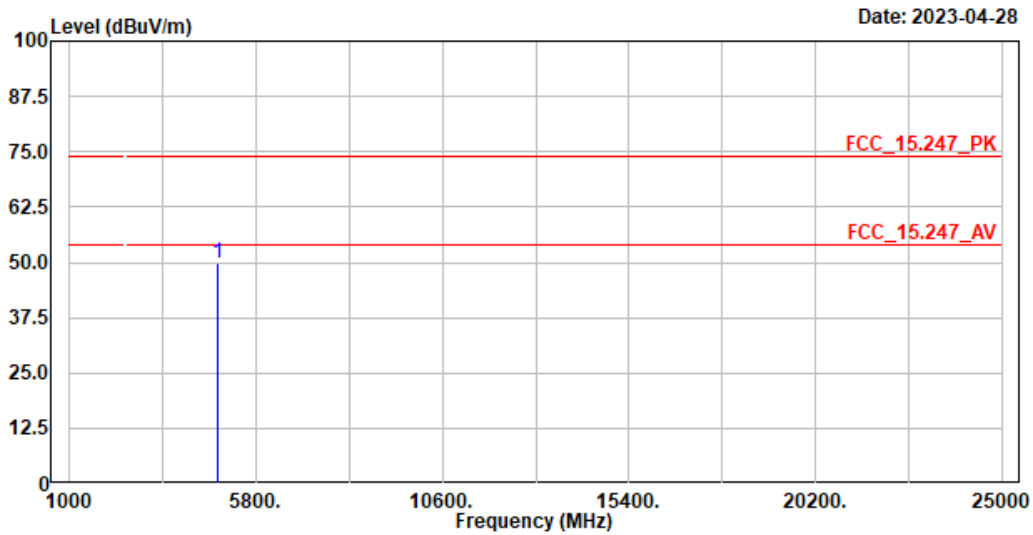

No.	Frequency	Level	Limit	Over	Read	Factor	Remark
	MHz	dBuV/m	dBuV/m	dB	dBuV	dB	
1	4804.000	49.75	74.00	-24.25	63.94	-14.19	Peak

Note:

1. Level = Read Level + Factor
2. Factor = Antenna Factor + Cable Loss - Preamp Factor
3. Over Limit = Level - Limit Line
4. The emission levels of other frequencies are very lower than the limit and not show in test report.

Vertical-Average Detector:

Frequency (MHz)	Peak Measurement (dBμV/m)	Duty Cycle Factor (dB)	Measurement Level (dBμV/m)	Margin (dB)	Limit (dBμV/m)
--	--	--	--	--	--

Site :HY-CB03
 Condition :3m ,HORIZONTAL
 Mode :TX_bt3M_2441MHz
 Test BY :Peter

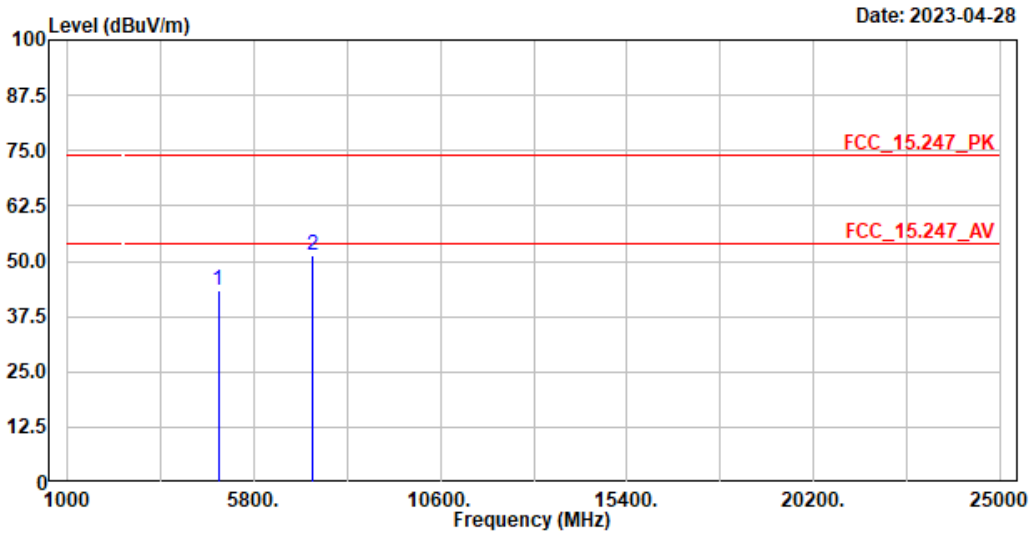

No.	Frequency MHz	Level dBuV/m	Limit Line dBuV/m	Over Limit dB	Read Level dBuV	Factor dB	Remark
1	4882.000	43.50	74.00	-30.50	57.54	-14.04	Peak
2	7323.000	51.18	74.00	-22.82	57.93	-6.75	Peak

Note:

1. Level = Read Level + Factor
2. Factor = Antenna Factor + Cable Loss - Preamp Factor
3. Over Limit = Level - Limit Line
4. The emission levels of other frequencies are very lower than the limit and not show in test report.

Horizontal-Average Detector:

Frequency (MHz)	Peak Measurement (dBμV/m)	Duty Cycle Factor (dB)	Measurement Level (dBμV/m)	Margin (dB)	Limit (dBμV/m)
--	--	--	--	--	--

Site :HY-CB03
 Condition :3m ,VERTICAL
 Mode :TX_bt3M_2441MHz
 Test BY :Peter

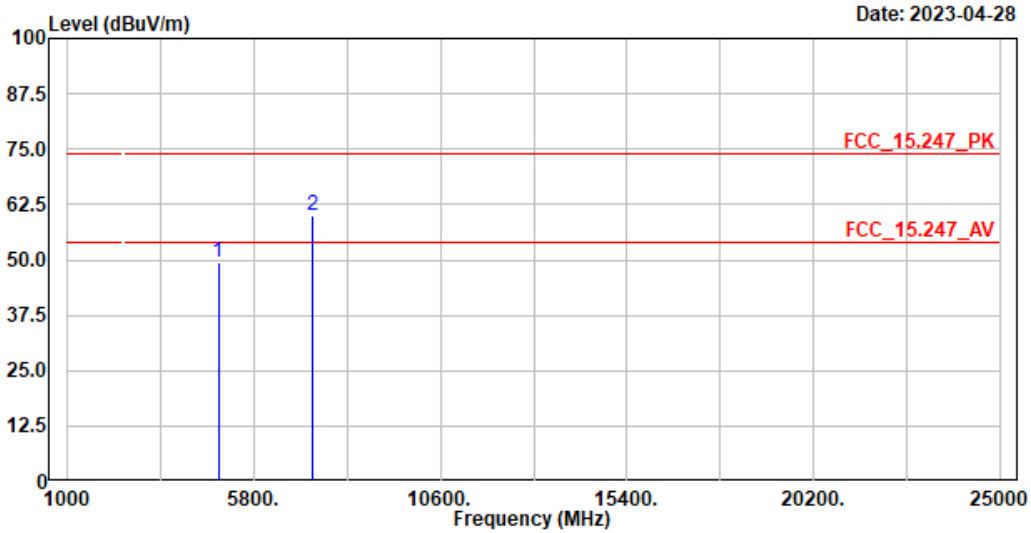

No.	Frequency	Level	Limit Line	Over Limit	Read Level	Factor	Remark
	MHz	dBuV/m	dBuV/m	dB	dBuV	dB	
1	4882.000	49.57	74.00	-24.43	63.61	-14.04	Peak
2	7323.000	60.03	74.00	-13.97	66.78	-6.75	Peak

Note:

1. Level = Read Level + Factor
2. Factor = Antenna Factor + Cable Loss - Preamp Factor
3. Over Limit = Level - Limit Line
4. The emission levels of other frequencies are very lower than the limit and not show in test report.

Vertical-Average Detector:

Frequency (MHz)	Peak Measurement (dBμV/m)	Duty Cycle Factor (dB)	Measurement Level (dBμV/m)	Margin (dB)	Limit (dBμV/m)
7323	60.03	-24.734	35.296	-18.704	54.000

Site :HY-CB03
 Condition :3m ,HORIZONTAL
 Mode :TX_bt3M_2480MHz
 Test BY :Peter

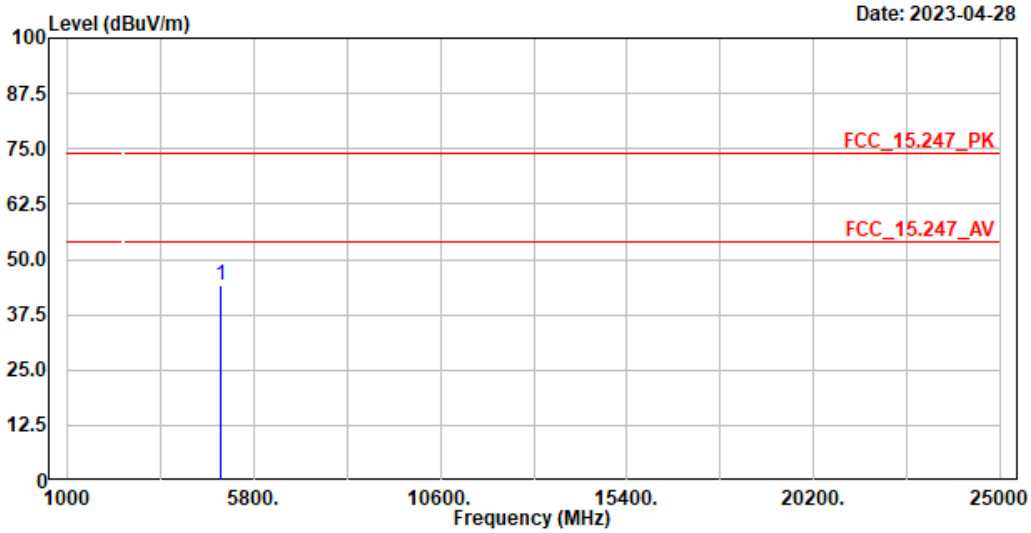

No.	Frequency	Level	Limit Line	Over Limit	Read Level	Factor	Remark
	MHz	dBuV/m	dBuV/m	dB	dBuV	dB	
1	4960.000	44.06	74.00	-29.94	57.82	-13.76	Peak

Note:

1. Level = Read Level + Factor
2. Factor = Antenna Factor + Cable Loss - Preamp Factor
3. Over Limit = Level - Limit Line
4. The emission levels of other frequencies are very lower than the limit and not show in test report.

Horizontal-Average Detector:

Frequency (MHz)	Peak Measurement (dBμV/m)	Duty Cycle Factor (dB)	Measurement Level (dBμV/m)	Margin (dB)	Limit (dBμV/m)
--	--	--	--	--	--

Site :HY-CB03
 Condition :3m ,VERTICAL
 Mode :TX_bt3M_2480MHz
 Test BY :Peter

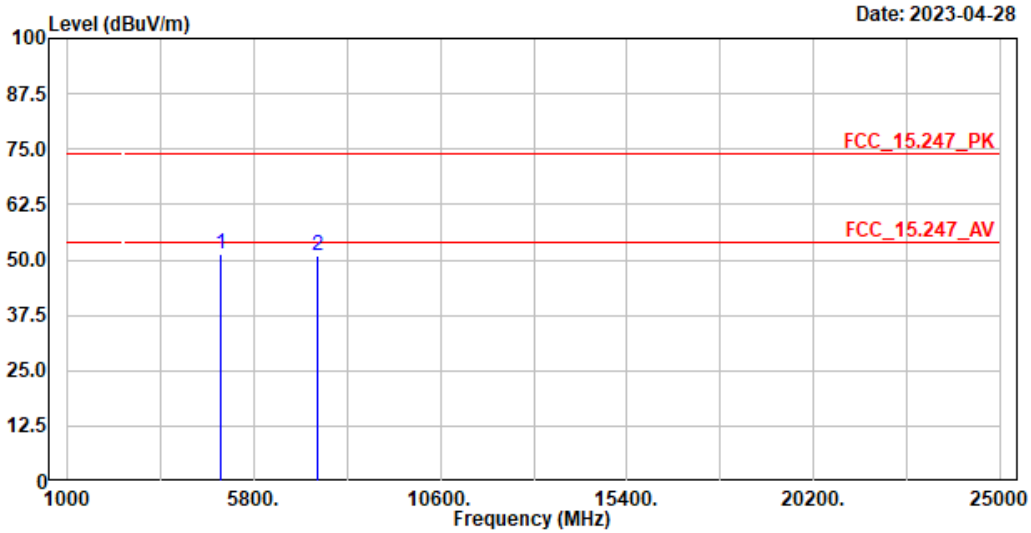

No.	Frequency	Level	Limit Line	Over Limit	Read Level	Factor	Remark
	MHz	dBuV/m	dBuV/m	dB	dBuV	dB	
1	4960.000	51.18	74.00	-22.82	64.94	-13.76	Peak
2	7440.000	50.79	74.00	-23.21	57.54	-6.75	Peak

Note:

1. Level = Read Level + Factor
2. Factor = Antenna Factor + Cable Loss - Preamp Factor
3. Over Limit = Level - Limit Line
4. The emission levels of other frequencies are very lower than the limit and not show in test report.

Vertical-Average Detector:

Frequency (MHz)	Peak Measurement (dBμV/m)	Duty Cycle Factor (dB)	Measurement Level (dBμV/m)	Margin (dB)	Limit (dBμV/m)
--	--	--	--	--	--

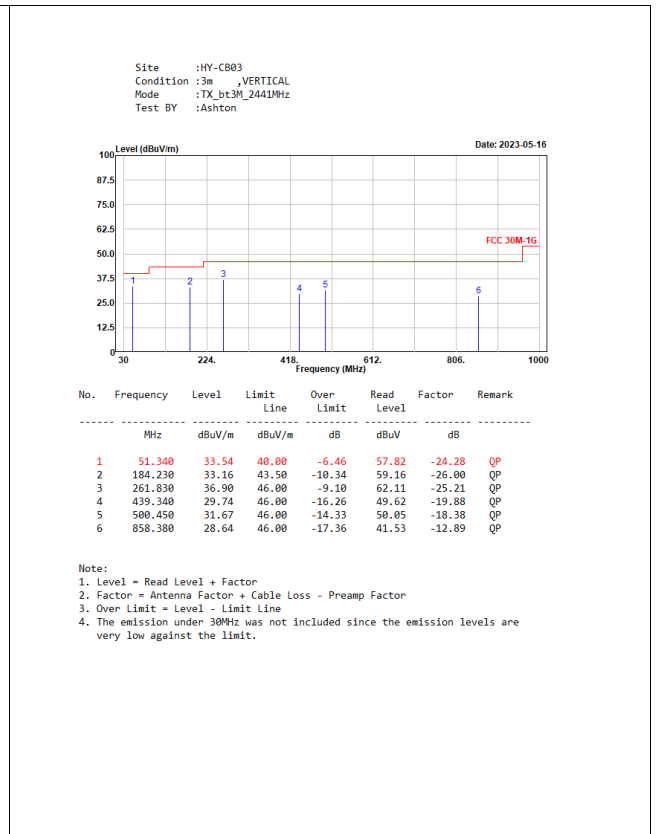
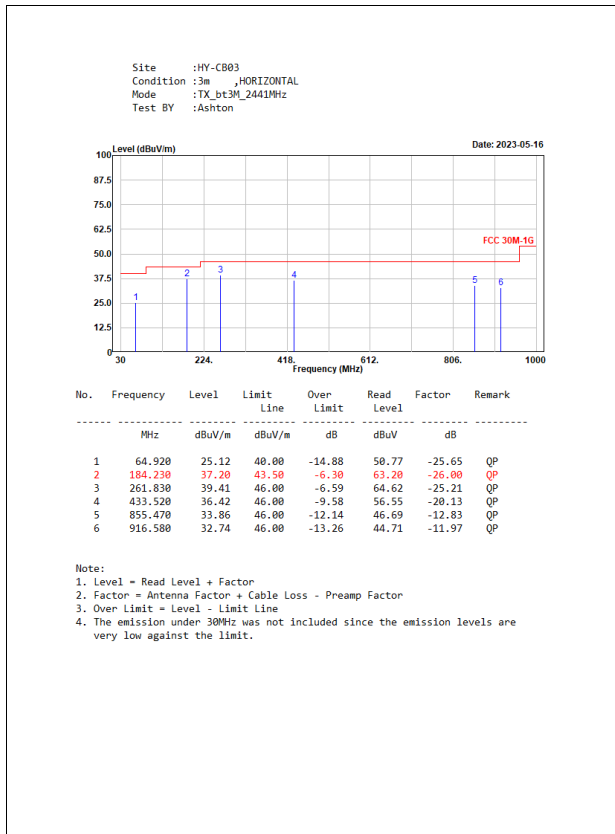

5. RF Antenna Conducted Test

5.1. Test Setup

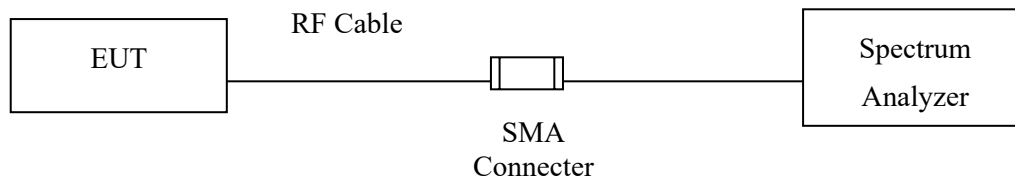

5.2. Limits

According to FCC Section 15.247(d). In any 100 kHz bandwidth outside the frequency band in which the spread spectrum or digitally modulated intentional radiator is operating, the radio frequency power that is produced by the intentional radiator shall be at least 20 dB below that in the 100 kHz bandwidth within the band that contains the highest level of the desired power, based on either an RF conducted or measurement, provided the transmitter demonstrates compliance with the peak conducted power limits. If the transmitter complies with the conducted power limits based on the use of RMS averaging over a time interval, the attenuation required under this paragraph shall be 30 dB instead of 20 dB.

5.3. Test Procedure

Tested according to FHSS test procedure of KDB558074 section 9 b) for compliance to FCC 47CFR 15.247 requirements.

5.4. Test Result of RF Antenna Conducted Test

Product : PanaCast 50 Video Bar System
 Test Item : RF Antenna Conducted Test
 Test Mode : Transmit - 1 Mbps
 Test Date : 2023/03/27

Channel 00:

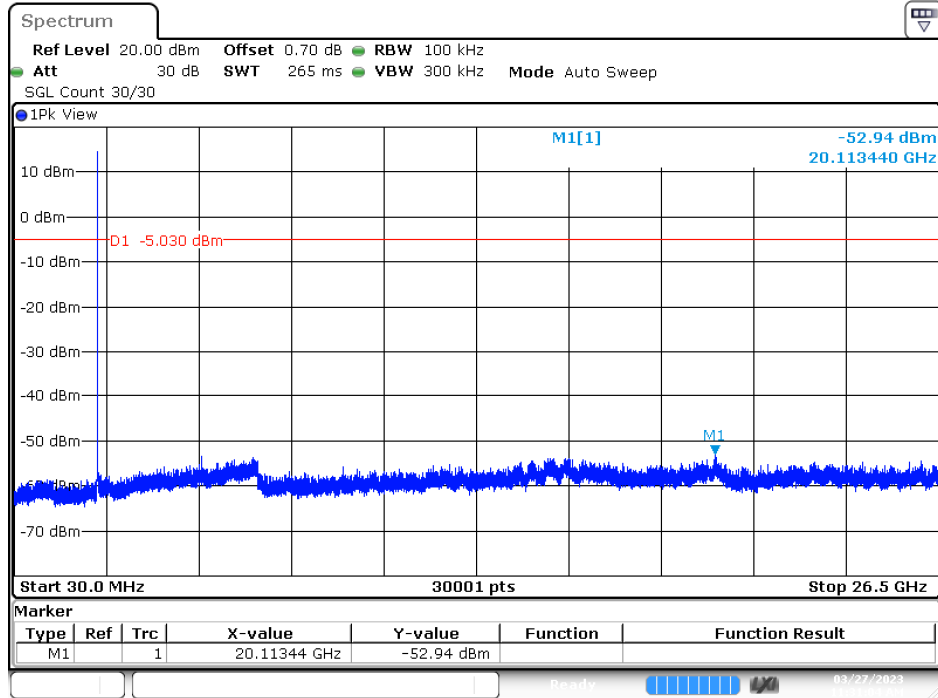

Date: 27.MAR.2023 11:31:04

Product : PanaCast 50 Video Bar System
 Test Item : RF Antenna Conducted Test
 Test Mode : Transmit - 3 Mbps
 Test Date : 2023/03/27

Channel 78:

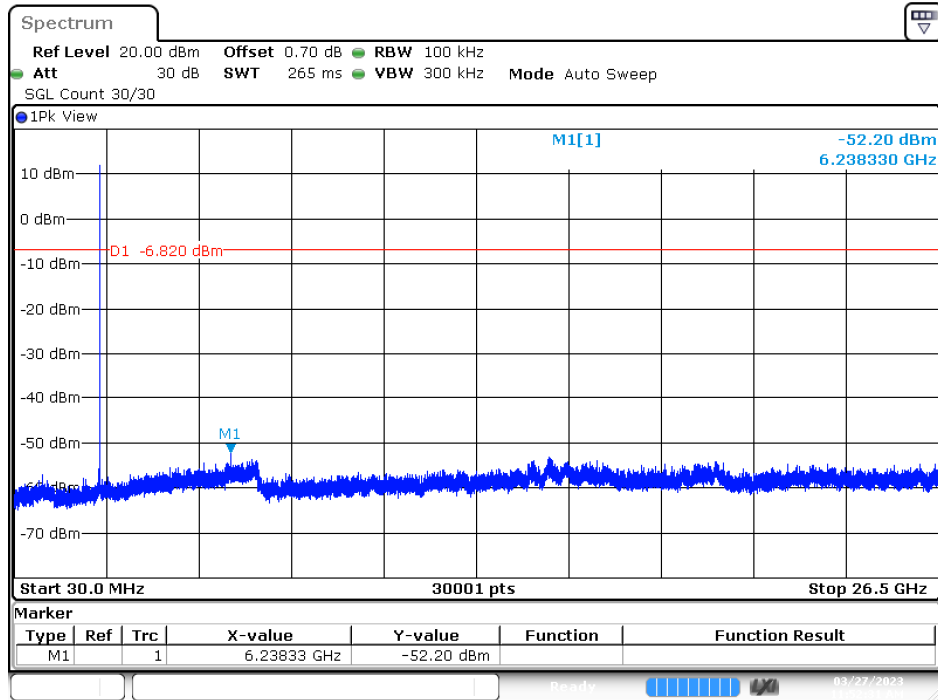

Date: 27.MAR.2023 11:52:32

6. Band Edge

6.1. Test Setup

RF Conducted Measurement

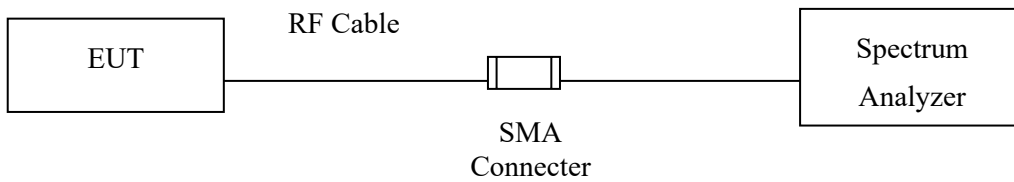

RF Radiated Measurement:

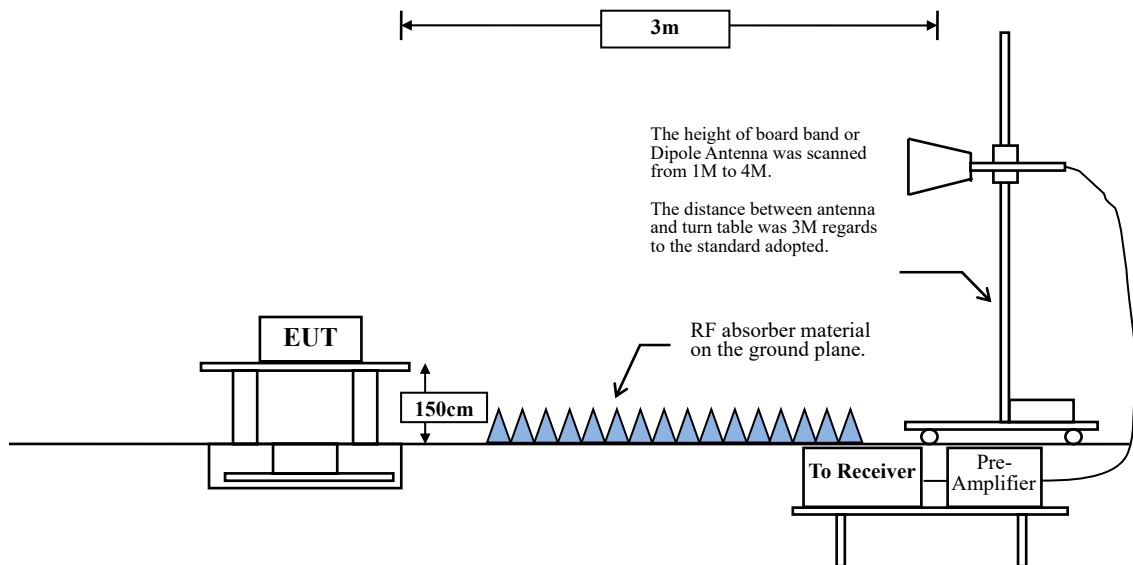

6.2. Limit

According to FCC Section 15.247(d). In any 100 kHz bandwidth outside the frequency band in which the spread spectrum or digitally modulated intentional radiator is operating, the radio frequency power that is produced by the intentional radiator shall be at least 20 dB below that in the 100 kHz bandwidth within the band that contains the highest level of the desired power, based on either an RF conducted or measurement, provided the transmitter demonstrates compliance with the peak conducted power limits. If the transmitter complies with the conducted power limits based on the use of RMS averaging over a time interval, the attenuation required under this paragraph shall be 30 dB instead of 20 dB. Attenuation below the general limits specified in Section 15.209(a) is not required. In addition, radiated emissions which fall in the restricted bands, as defined in Section 15.205(a), must also comply with the radiated emission limits specified in Section 15.209(a) (see Section 15.205(c)).

6.3. Test Procedure

The EUT is placed on a turn table which is 1.5 meter above ground. The turn table is rotated 360 degrees to determine the position of the maximum emission level. The EUT was positioned such that the distance from antenna to the EUT was 3 meters.

The antenna can move up and down between 1 meter and 4 meters to find out the maximum emission level.

Both horizontal and vertical polarization of the antenna are set on measurement. In order to find the maximum emission, all of the interface cables must be manipulated according to ANSI C63.10: 2013 on radiated measurement.

The bandwidth setting below 1 GHz and above 1 GHz on the field strength meter is 120 kHz and 1MHz, respectively.

6.4. Test Result of Band Edge

Site :HY-CB03
 Condition :3m ,Horizontal
 Mode :TX_bt1M_2402MHz
 Test BY :Ashton

Date: 2023-04-28

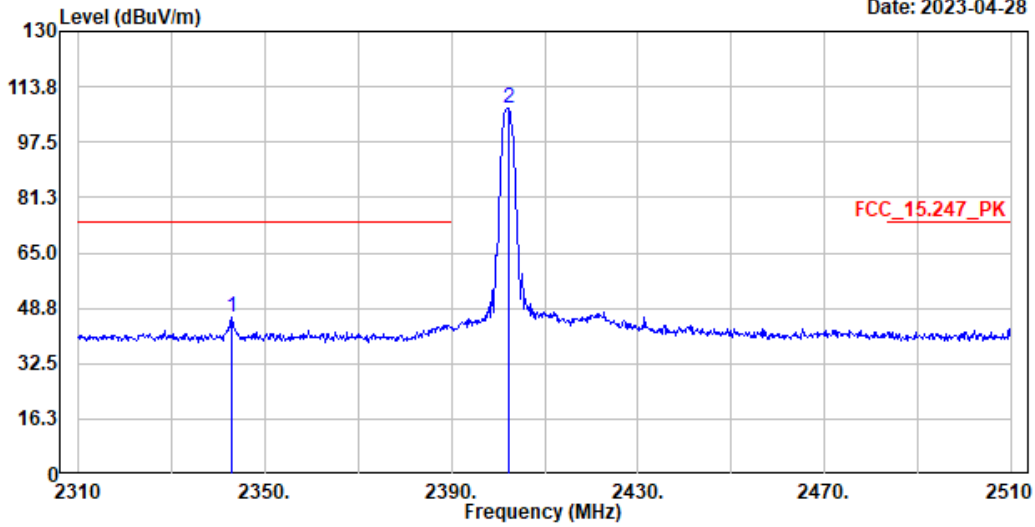

No.	Frequency	Level	Limit Line	Over Limit	Read Level	Factor	Remark
	MHz	dBuV/m	dBuV/m	dB	dBuV	dB	
1	2342.800	45.88	74.00	-28.12	38.90	6.98	Peak
2	2402.200	107.63	-----	-----	100.71	6.92	Peak

Note:

1. Level = Read Level + Factor
2. Factor = Antenna Factor + Cable Loss - Preamp Factor
3. Over Limit = Level - Limit Line
4. The emission levels of other frequencies are very lower than the limit and not show in test report.

Horizontal-Average Detector:

Frequency (MHz)	Peak Measurement (dBμV/m)	Duty Cycle Factor (dB)	Measurement Level (dBμV/m)	Margin (dB)	Limit (dBμV/m)
2342.8	45.88	-24.734	21.146	-32.854	54.000
2402.2	107.63	-24.734	82.896	--	--

Site :HY-CB03
 Condition :3m ,Vertical
 Mode :TX_bt1M_2402MHz
 Test BY :Ashton

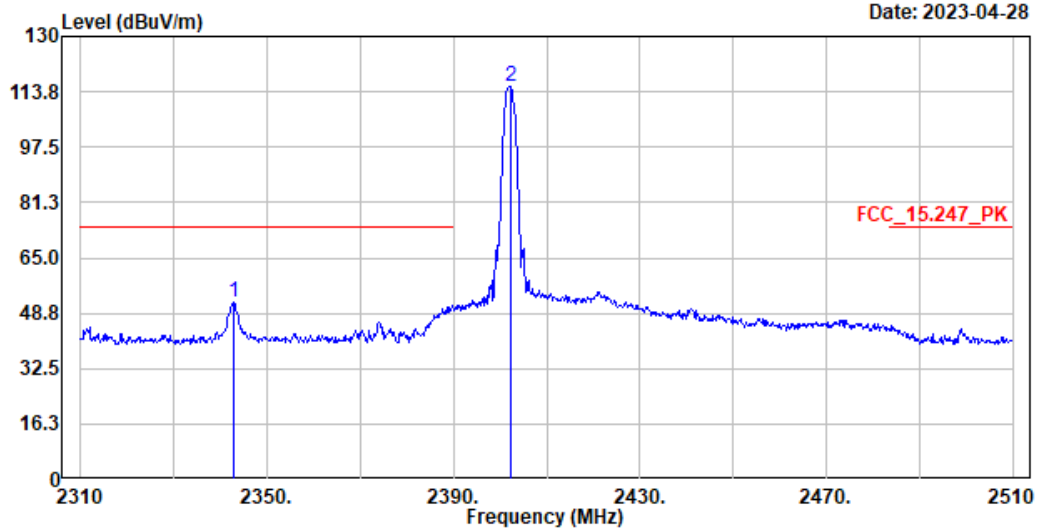

No.	Frequency	Level	Limit	Over	Read	Factor	Remark
	MHz	dBuV/m	dBuV/m	dB	dBuV	dB	
1	2342.800	51.76	74.00	-22.24	44.78	6.98	Peak
2	2402.200	115.24	-----	-----	108.32	6.92	Peak

Note:

1. Level = Read Level + Factor
2. Factor = Antenna Factor + Cable Loss - Preamp Factor
3. Over Limit = Level - Limit Line
4. The emission levels of other frequencies are very lower than the limit and not show in test report.

Vertical-Average Detector:

Frequency (MHz)	Peak Measurement (dBμV/m)	Duty Cycle Factor (dB)	Measurement Level (dBμV/m)	Margin (dB)	Limit (dBμV/m)
2342.8	51.76	-24.734	27.026	-26.974	54.000
2402.2	115.24	-24.734	90.506	--	--

Site :HY-CB03
 Condition :3m ,Horizontal
 Mode :TX_bt1M_2480MHz
 Test BY :Ashton

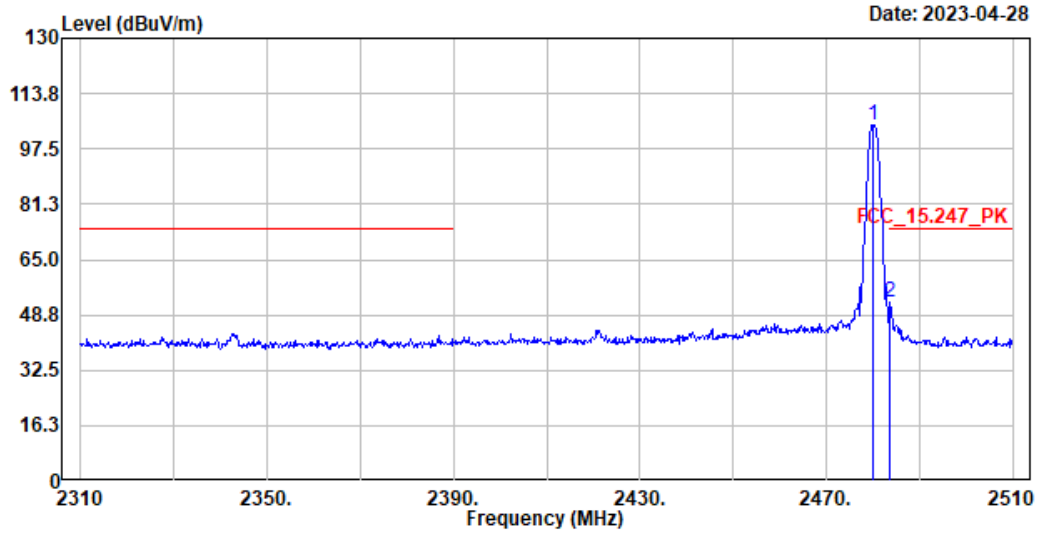

No.	Frequency	Level	Limit	Over	Read	Factor	Remark
	MHz	dBuV/m	Line	Limit	Level		
	MHz	dBuV/m	dBuV/m	dB	dBuV	dB	
1	2480.000	104.40	-----	-----	97.50	6.90	Peak
2	2483.600	52.51	74.00	-21.49	45.61	6.90	Peak

Note:

1. Level = Read Level + Factor
2. Factor = Antenna Factor + Cable Loss - Preamp Factor
3. Over Limit = Level - Limit Line
4. The emission levels of other frequencies are very lower than the limit and not show in test report.

Horizontal-Average Detector:

Frequency (MHz)	Peak Measurement (dBμV/m)	Duty Cycle Factor (dB)	Measurement Level (dBμV/m)	Margin (dB)	Limit (dBμV/m)
2480	104.4	-24.734	79.666	--	--
2483.6	52.51	-24.734	27.776	-26.224	54.000

Site :HY-CB03
 Condition :3m ,Vertical
 Mode :TX_bt1M_2480MHz
 Test BY :Ashton

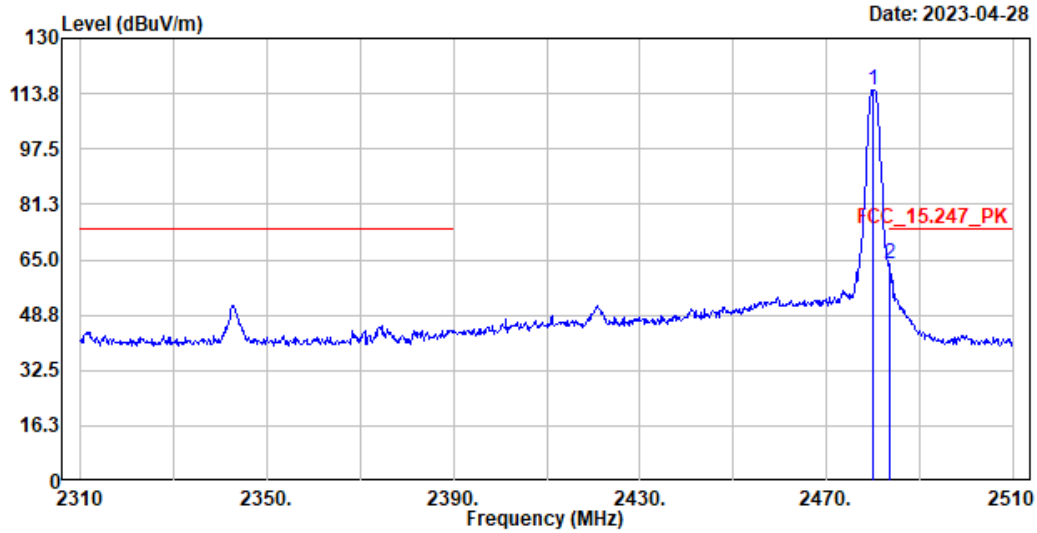

No.	Frequency	Level	Limit	Over	Read	Factor	Remark
	MHz	dBuV/m	dBuV/m	dB	dBuV	dB	
1	2480.000	114.89	-----	-----	107.99	6.90	Peak
2	2483.600	63.55	74.00	-10.45	56.65	6.90	Peak

Note:

1. Level = Read Level + Factor
2. Factor = Antenna Factor + Cable Loss - Preamp Factor
3. Over Limit = Level - Limit Line
4. The emission levels of other frequencies are very lower than the limit and not show in test report.

Vertical-Average Detector:

Frequency (MHz)	Peak Measurement (dBμV/m)	Duty Cycle Factor (dB)	Measurement Level (dBμV/m)	Margin (dB)	Limit (dBμV/m)
2480	114.89	-24.734	90.156	--	--
2483.6	63.55	-24.734	38.816	-15.184	54.000

Site :HY-CB03
 Condition :3m ,Horizontal
 Mode :TX_bt3M_2402MHz
 Test BY :Ashton

Date: 2023-04-28

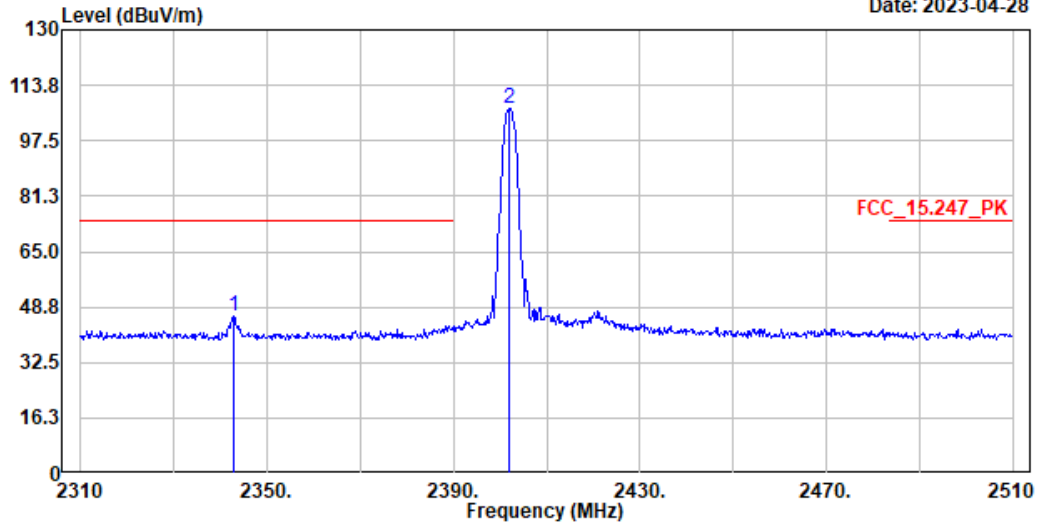

No.	Frequency	Level	Limit	Over	Read	Factor	Remark
	MHz	dBuV/m	dBuV/m	dB	dBuV	dB	
1	2342.800	46.06	74.00	-27.94	39.08	6.98	Peak
2	2402.000	107.15	-----	-----	100.23	6.92	Peak

Note:

1. Level = Read Level + Factor
2. Factor = Antenna Factor + Cable Loss - Preamp Factor
3. Over Limit = Level - Limit Line
4. The emission levels of other frequencies are very lower than the limit and not show in test report.

Horizontal-Average Detector:

Frequency (MHz)	Peak Measurement (dBμV/m)	Duty Cycle Factor (dB)	Measurement Level (dBμV/m)	Margin (dB)	Limit (dBμV/m)
2342.8	46.06	-24.734	21.326	-32.674	54.000
2402	107.15	-24.734	82.416	--	--

Site :HY-CB03
 Condition :3m ,Vertical
 Mode :TX_bt3M_2402MHz
 Test BY :Ashton

Date: 2023-04-28

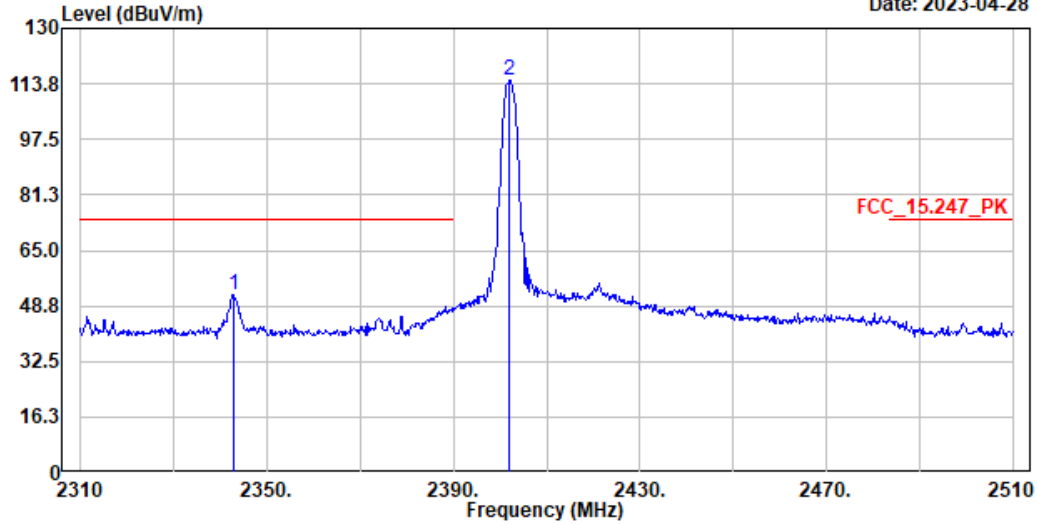

No.	Frequency	Level	Limit	Over	Read	Factor	Remark
	MHz	dBuV/m	dBuV/m	dB	dBuV	dB	
1	2343.000	51.95	74.00	-22.05	44.97	6.98	Peak
2	2402.000	114.77	-----	-----	107.85	6.92	Peak

Note:

1. Level = Read Level + Factor
2. Factor = Antenna Factor + Cable Loss - Preamp Factor
3. Over Limit = Level - Limit Line
4. The emission levels of other frequencies are very lower than the limit and not show in test report.

Vertical-Average Detector:

Frequency (MHz)	Peak Measurement (dBμV/m)	Duty Cycle Factor (dB)	Measurement Level (dBμV/m)	Margin (dB)	Limit (dBμV/m)
2343	51.95	-24.734	27.216	-26.784	54.000
2402	114.77	-24.734	90.036	--	--

Site :HY-CB03
 Condition :3m ,Horizontal
 Mode :TX_bt3M_2480MHz
 Test BY :Ashton

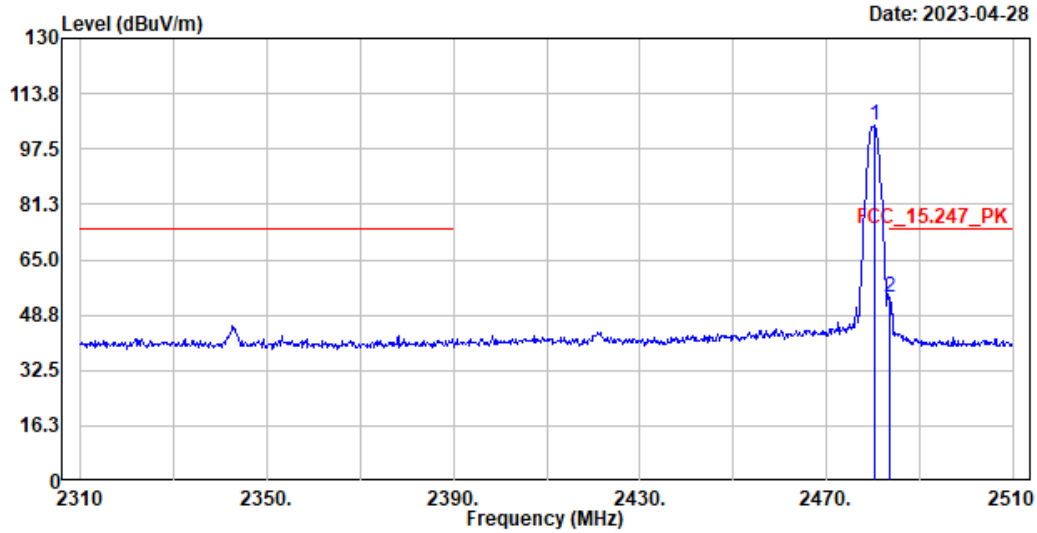

No.	Frequency	Level	Limit	Over	Read	Factor	Remark
	MHz	dBuV/m	Line	Limit	Level		
	MHz	dBuV/m	dBuV/m	dB	dBuV	dB	
1	2480.200	104.26	-----	-----	97.36	6.90	Peak
2	2483.600	53.96	74.00	-20.04	47.06	6.90	Peak

Note:

1. Level = Read Level + Factor
2. Factor = Antenna Factor + Cable Loss - Preamp Factor
3. Over Limit = Level - Limit Line
4. The emission levels of other frequencies are very lower than the limit and not show in test report.

Horizontal-Average Detector:

Frequency (MHz)	Peak Measurement (dBμV/m)	Duty Cycle Factor (dB)	Measurement Level (dBμV/m)	Margin (dB)	Limit (dBμV/m)
2480.2	104.26	-24.734	79.526	--	--
2483.6	53.96	-24.734	29.226	-24.774	54.000

Site :HY-CB03
 Condition :3m ,Vertical
 Mode :TX_bt3M_2480MHz
 Test BY :Ashton

Date: 2023-04-28

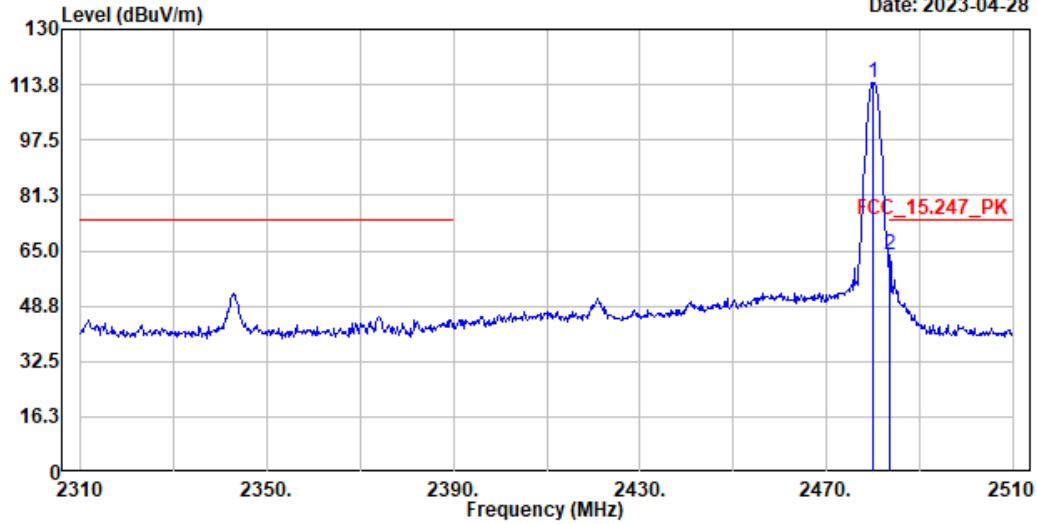

No.	Frequency	Level	Limit	Over	Read	Factor	Remark
	MHz	dBuV/m	dBuV/m	Limit	Level	dB	
1	2480.000	114.47	-----	-----	107.57	6.90	Peak
2	2483.600	63.89	74.00	-10.11	56.99	6.90	Peak

Note:

1. Level = Read Level + Factor
2. Factor = Antenna Factor + Cable Loss - Preamp Factor
3. Over Limit = Level - Limit Line
4. The emission levels of other frequencies are very lower than the limit and not show in test report.

Vertical-Average Detector:

Frequency (MHz)	Peak Measurement (dBμV/m)	Duty Cycle Factor (dB)	Measurement Level (dBμV/m)	Margin (dB)	Limit (dBμV/m)
2480	114.47	-24.734	89.736	--	--
2483.6	63.89	-24.734	39.156	-14.844	54.000

Product : PanaCast 50 Video Bar System
 Test Item : Band Edge
 Test Mode : Transmit - 1 Mbps (Hopping off)
 Test Date : 2023/03/27

Measurement Level	Result
Δ (dB)	
> 20	PASS

Channel 00:

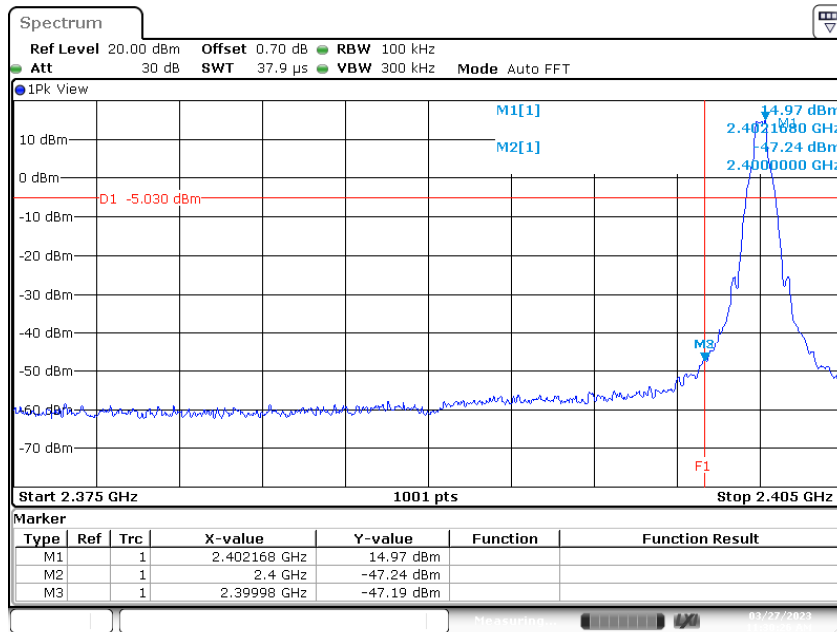

Date: 27.MAR.2023 11:30:27

Channel 78:

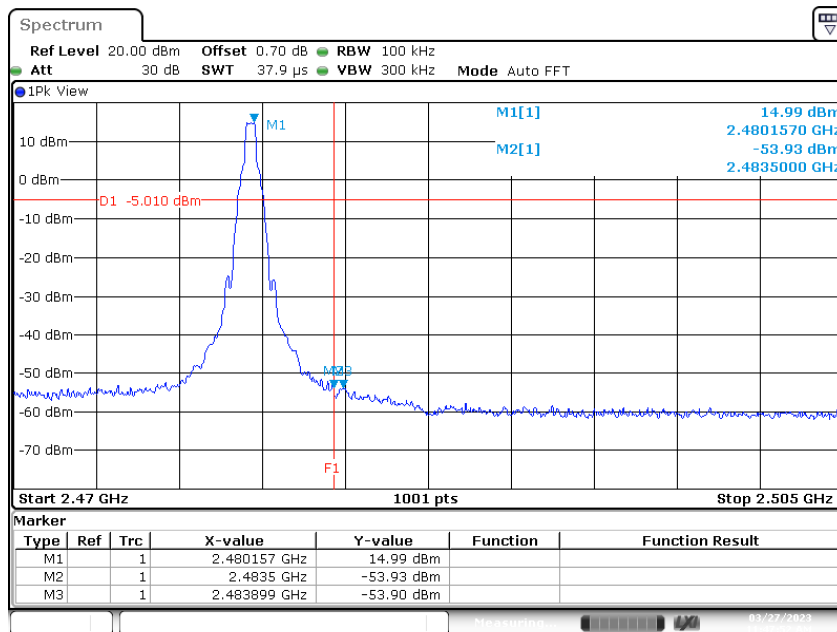

Date: 27.MAR.2023 11:47:52

Product : PanaCast 50 Video Bar System
 Test Item : Band Edge
 Test Mode : Transmit - 3 Mbps (Hopping off)
 Test Date : 2023/03/27

Measurement Level Δ (dB)	Result
> 20	PASS

Channel 00:

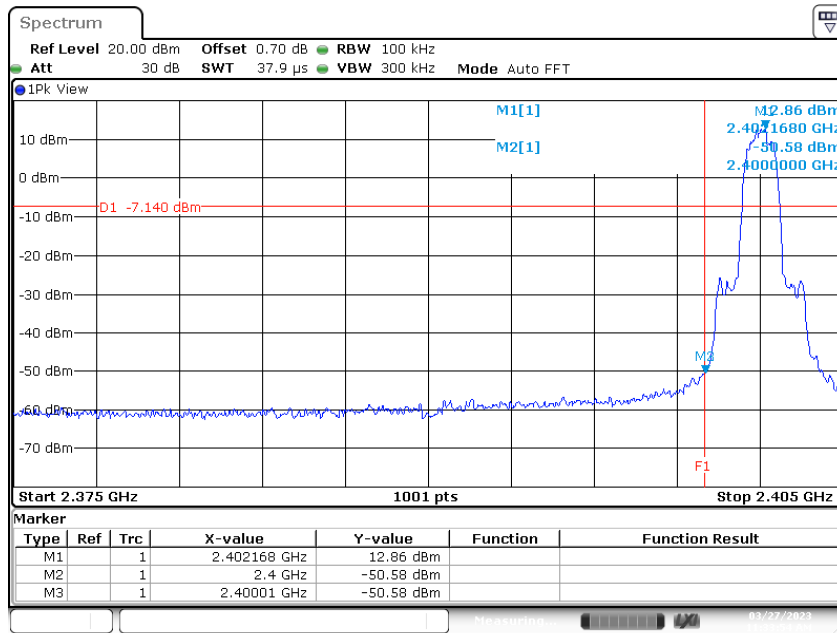

Date: 27.MAR.2023 11:33:54

Channel 78:

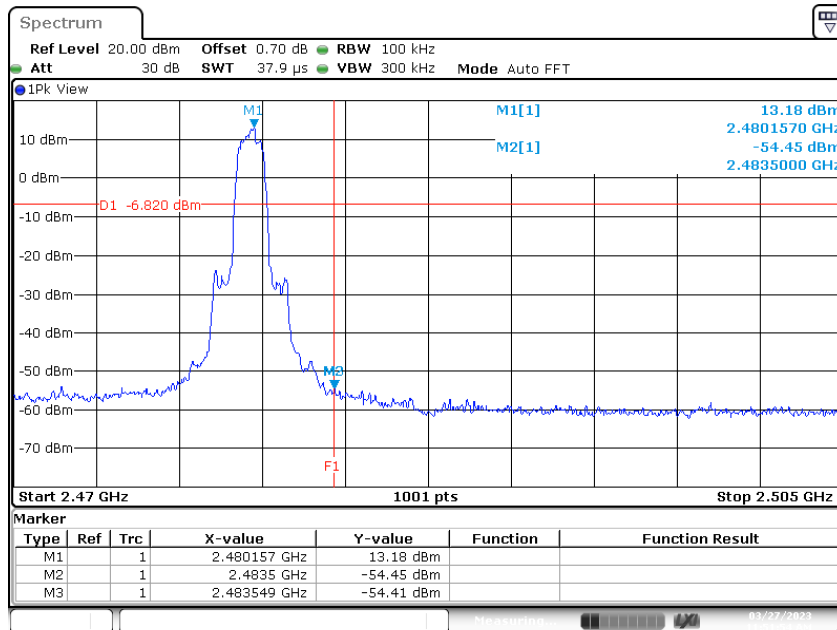

Date: 27.MAR.2023 11:51:54

Product : PanaCast 50 Video Bar System
 Test Item : Band Edge
 Test Mode : Transmit - 1 Mbps (Hopping on)
 Test Date : 2023/03/27

Measurement Level	Result
Δ (dB)	
> 20	PASS

Channel Hopping:

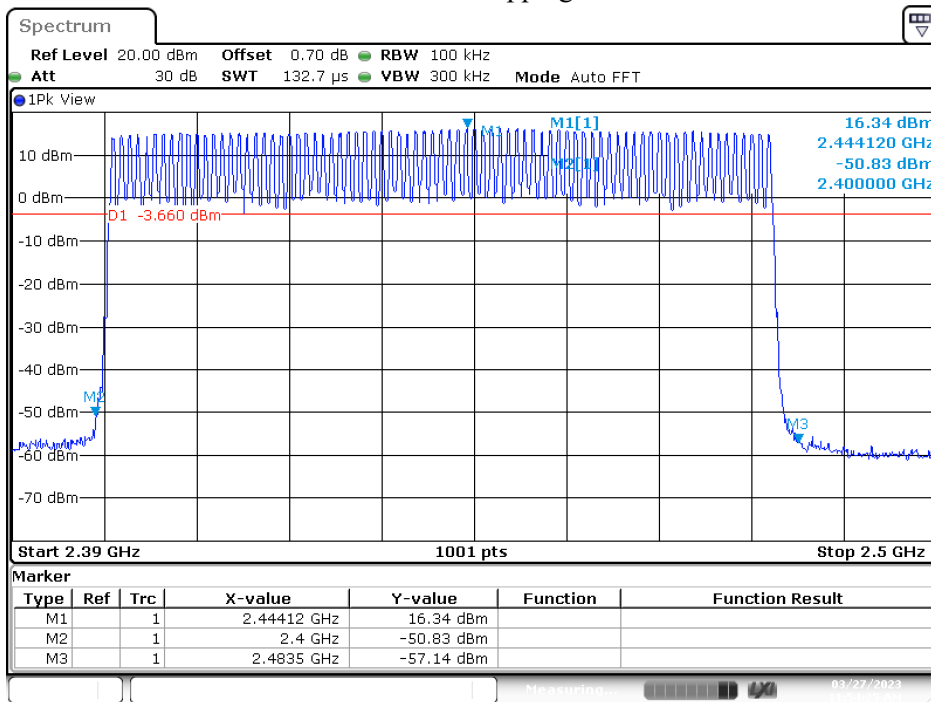

Date: 27.MAR.2023 11:54:25

Product : PanaCast 50 Video Bar System
 Test Item : Band Edge
 Test Mode : Transmit - 3 Mbps (Hopping on)
 Test Date : 2023/03/27

Measurement Level	Result
Δ (dB)	
> 20	PASS

Channel Hopping:

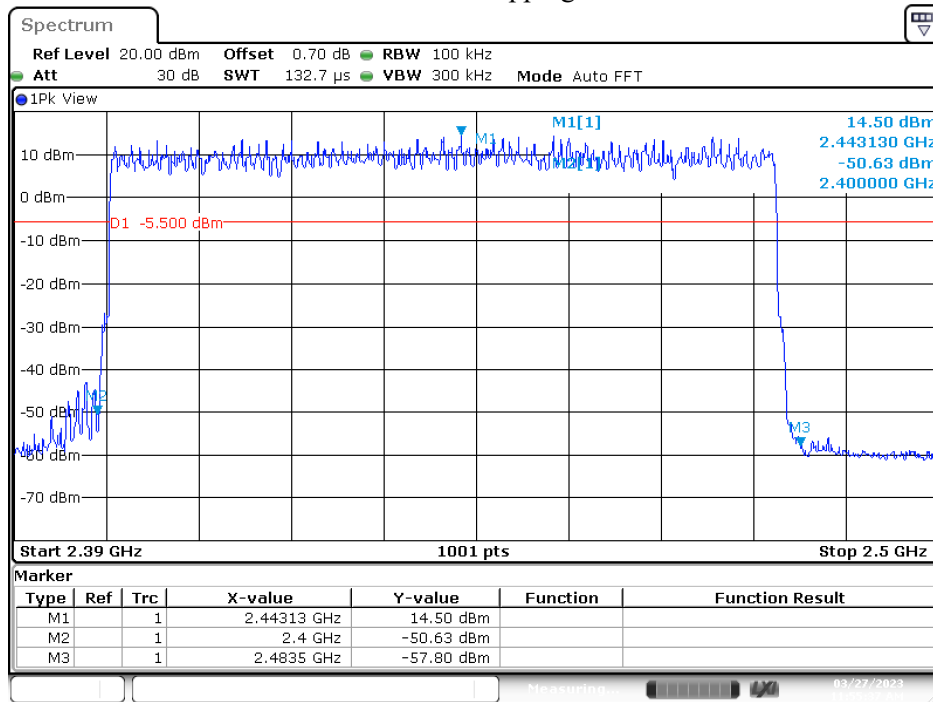

Date: 27.MAR.2023 11:55:37

7. Channel Number

7.1. Test Setup

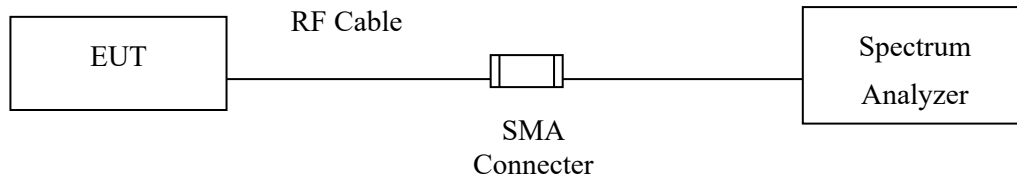

7.2. Limit

Frequency hopping systems operating in the 2400-2483.5 MHz bands shall use at least 15 hopping frequencies.

7.3. Test Procedure

Tested according to FHSS test procedure of KDB558074 section 9 (b for compliance to FCC 47CFR 15.247 requirements.

7.4. Test Result of Channel Number

Product : PanaCast 50 Video Bar System
 Test Item : Channel Number
 Test Mode : Transmit - 1 Mbps
 Test Date : 2023/03/27

Frequency Range (MHz)	Measurement (Hopping Channel)	Required Limit (Hopping Channel)	Result
2402 ~ 2480	79	>15	Pass

2402 MHz

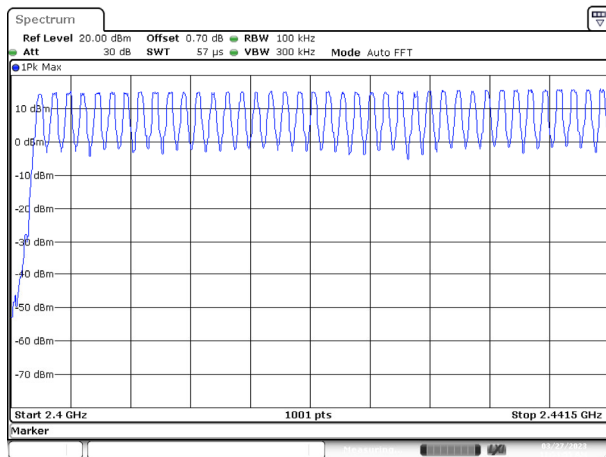

Date: 27.MAR.2023 11:53:55

2480 MHz

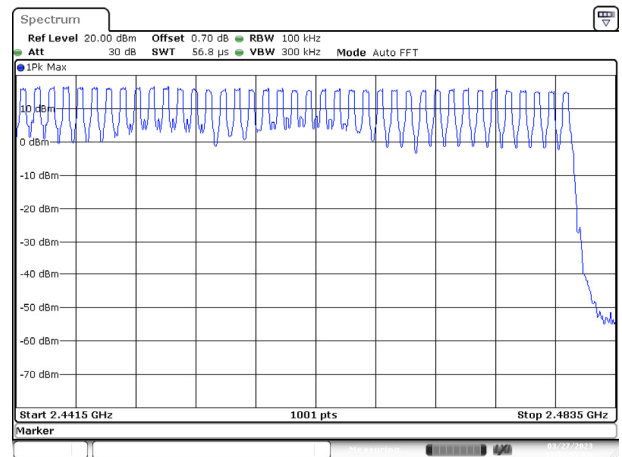

Date: 27.MAR.2023 11:59:55

Product : PanaCast 50 Video Bar System
 Test Item : Channel Number
 Test Mode : Transmit - 3 Mbps
 Test Date : 2023/03/27

Frequency Range (MHz)	Measurement (Hopping Channel)	Required Limit (Hopping Channel)	Result
2402 ~ 2480	79	>15	Pass

2402 MHz

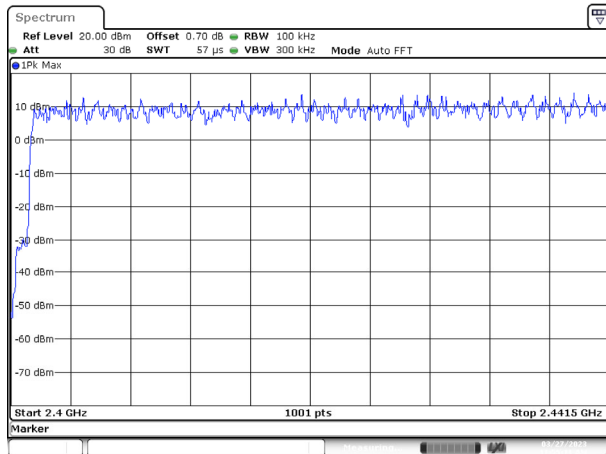

Date: 27.MAR.2023 11:55:11

2480 MHz

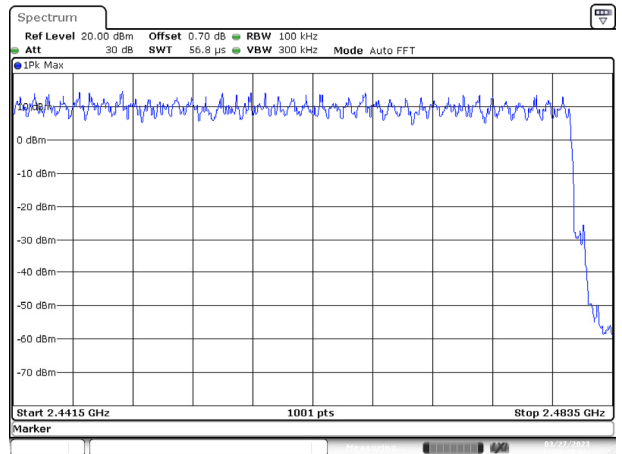

Date: 27.MAR.2023 11:56:28

8. Channel Separation

8.1. Test Setup

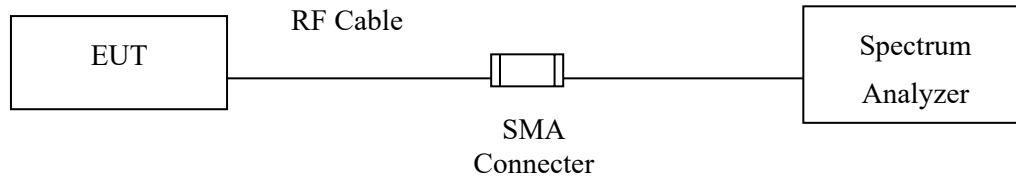

8.2. Limit

Frequency hopping systems shall have hopping channel carrier frequencies separated by a minimum of 25 kHz or the 20 dB bandwidth of the hopping channel, whichever is greater. Alternatively, frequency hopping systems operating in the 2400-2483.5 MHz band may have hopping channel carrier frequencies that are separated by 25 kHz or two-thirds of the 20 dB bandwidth of the hopping channel, whichever is greater.

8.3. Test Procedure

Tested according to FHSS test procedure of KDB558074 section 9 (b for compliance to FCC 47CFR 15.247 requirements.

8.4. Test Result of Channel Separation

Product : PanaCast 50 Video Bar System
 Test Item : Channel Separation
 Test Mode : Transmit - 1 Mbps
 Test Date : 2023/03/27

Channel No.	Frequency (MHz)	Measurement Level (kHz)	Limit (kHz)	Limit of (2/3)*20dB Bandwidth (kHz)	Result
00	2402	1001	>25	621.4	Pass
39	2441	998	>25	621.4	Pass
78	2480	998	>25	621.4	Pass

Note: The 20dB Bandwidth is refer to section 10.

Channel 00

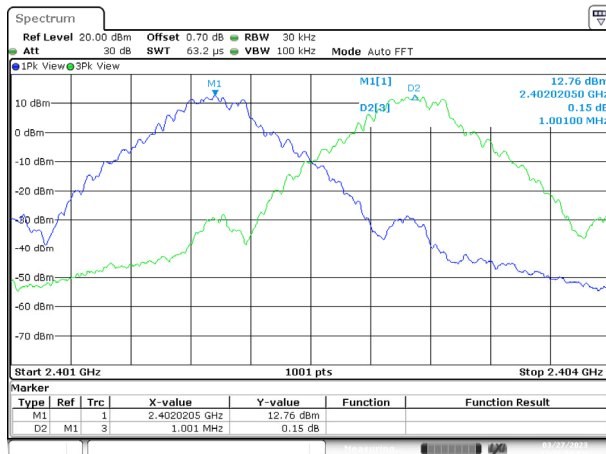

Date: 27.MAR.2023 11:30:09

Channel 39

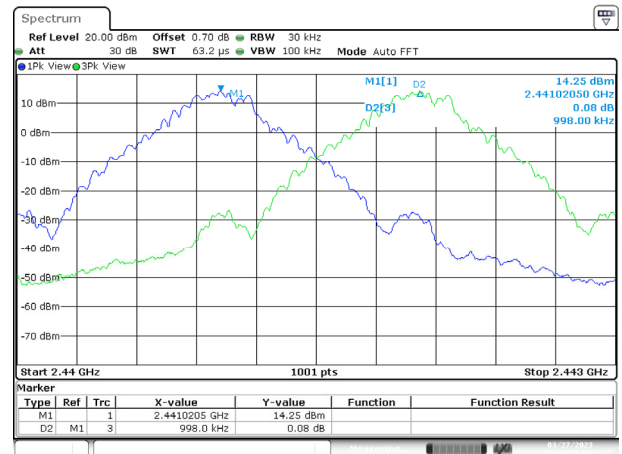

Date: 27.MAR.2023 11:40:59

Channel 78

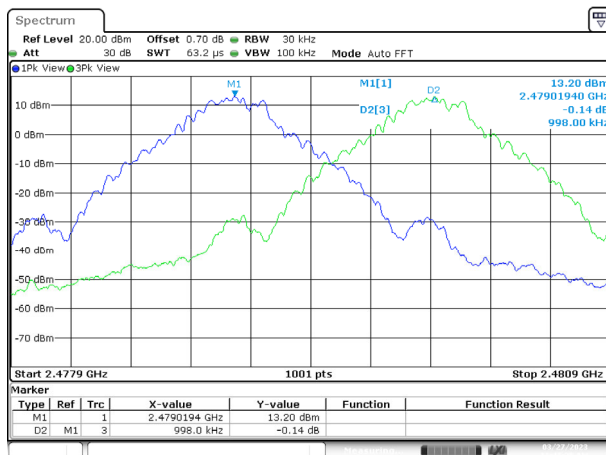

Date: 27.MAR.2023 11:47:28

Product : PanaCast 50 Video Bar System
 Test Item : Channel Separation
 Test Mode : Transmit - 3 Mbps
 Test Date : 2023/03/27

Channel No.	Frequency (MHz)	Measurement Level (kHz)	Limit (kHz)	Limit of (2/3)*20dB Bandwidth (kHz)	Result
00	2402	1001	>25 kHz	859.1	Pass
39	2441	1001	>25 kHz	863.1	Pass
78	2480	1001	>25 kHz	859.1	Pass

Note: The 20dB Bandwidth is refer to section 10.

Channel 00

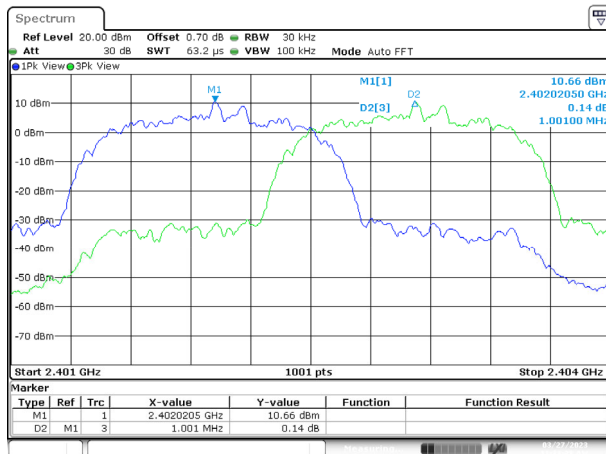

Date: 27.MAR.2023 11:33:38

Channel 39

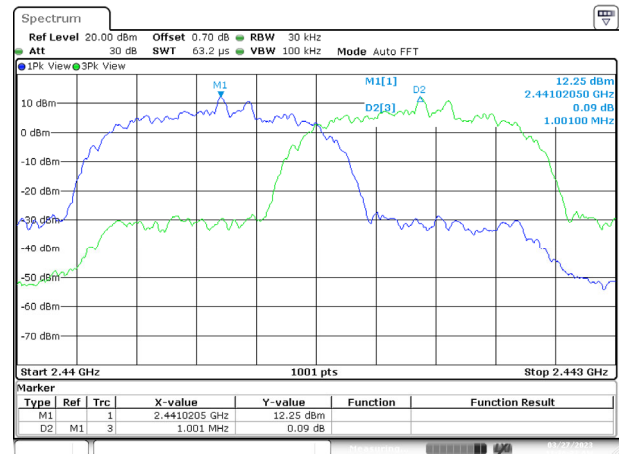

Date: 27.MAR.2023 11:36:33

Channel 78

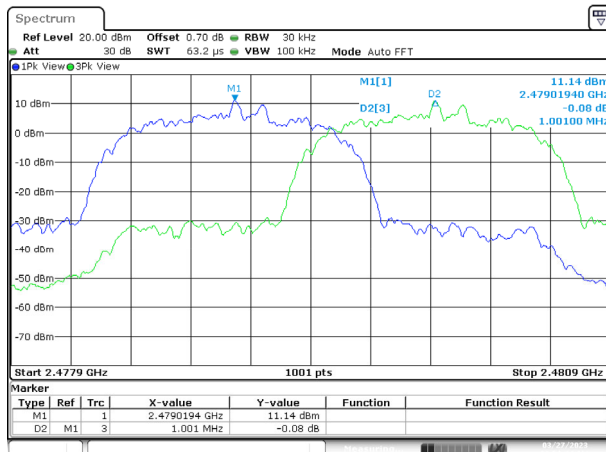

Date: 27.MAR.2023 11:51:44

9. Dwell Time

9.1. Test Setup

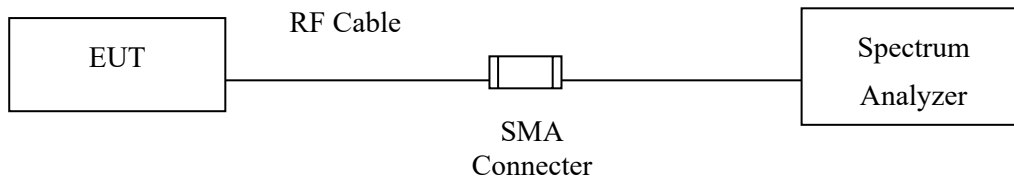

9.2. Limit

The average time of occupancy on any channel shall not be greater than 0.4 seconds within a period of 0.4 seconds multiplied by the number of hopping channels employed.

9.3. Test Procedure

Tested according to FHSS test procedure of KDB558074 section 9 (b for compliance to FCC 47CFR 15.247 requirements).

9.4. Test Result of Dwell Time

Product : PanaCast 50 Video Bar System
 Test Item : Dwell Time
 Test Mode : Transmit - 1 Mbps (Channel 00,39,78)
 Test Date : 2023/03/27

Frequency (MHz)	Time slot length (ms)	Hopping of Number	Sweep time (ms)	Dwell Time (ms)	Limit (ms)	Result
2402	2.899	104	31600	301.496	400	Pass
2441	2.899	104	31600	301.496	400	Pass
2480	2.899	104	31600	301.496	400	Pass

Dwell time = Time slot length (ms)*Hopping of Number

Hopping of Number is S.A software calculated value.

CH 39 Time slot length

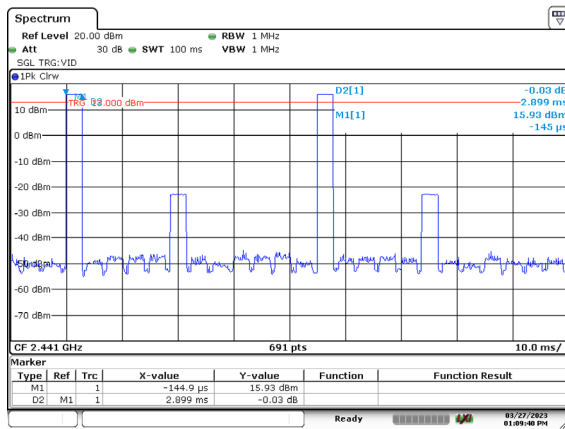

CH 39 Hopping of Number

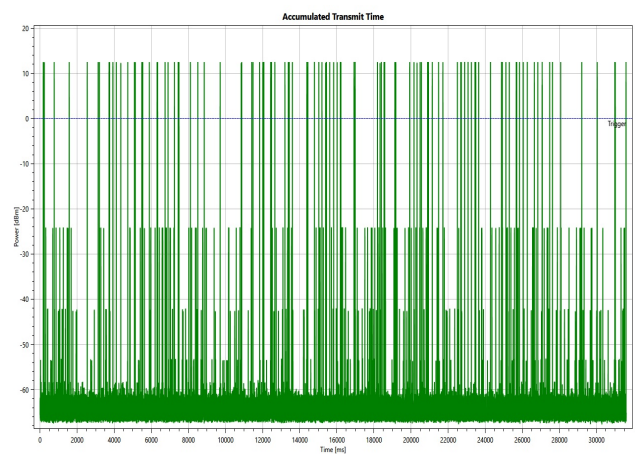

Product : PanaCast 50 Video Bar System
 Test Item : Dwell Time
 Test Mode : Transmit - 3 Mbps (Channel 00,39,78)
 Test Date : 2023/03/27

Frequency (MHz)	Time slot length (ms)	Hopping of Number	Sweep time (ms)	Dwell Time (ms)	Limit (ms)	Result
2402	2.899	105	31600	304.395	400	Pass
2441	2.899	105	31600	304.395	400	Pass
2480	2.899	105	31600	304.395	400	Pass

Dwell time = Time slot length (ms)*Hopping of Number
 Hopping of Number is S.A software calculated value.

CH 39 Time slot length

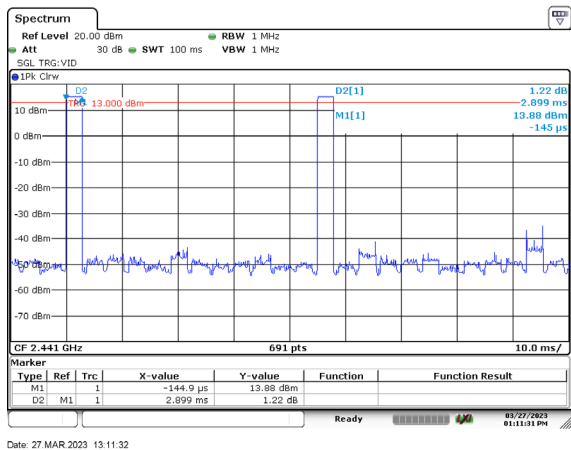

CH 39 Hopping of Number

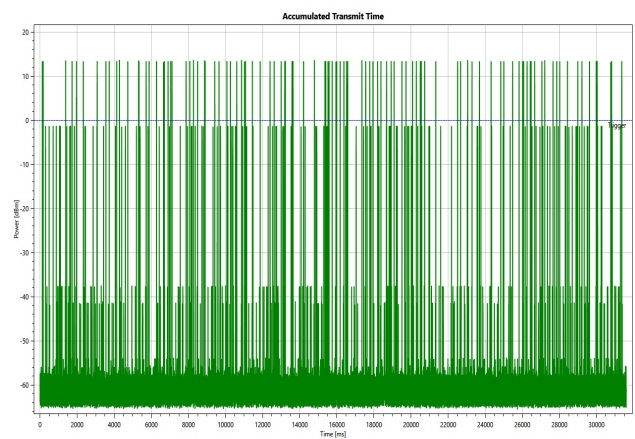

10. Occupied Bandwidth

10.1. Test Setup

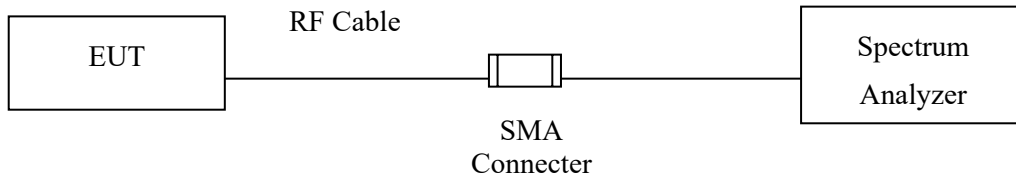

10.2. Limits

N/A

10.3. Test Procedure

Tested according to FHSS test procedure of KDB558074 section 9 (b for compliance to FCC 47CFR 15.247 requirements.

10.4. Test Result of Occupied Bandwidth

Product : PanaCast 50 Video Bar System
 Test Item : Occupied Bandwidth Data
 Test Mode : Transmit - 1 Mbps
 Test Date : 2023/03/27

Channel No.	Frequency (MHz)	Measurement Level (kHz)	Required Limit (kHz)	Result
00	2402	830	--	NA
39	2441	827	--	NA
78	2480	830	--	NA

Channel 00:

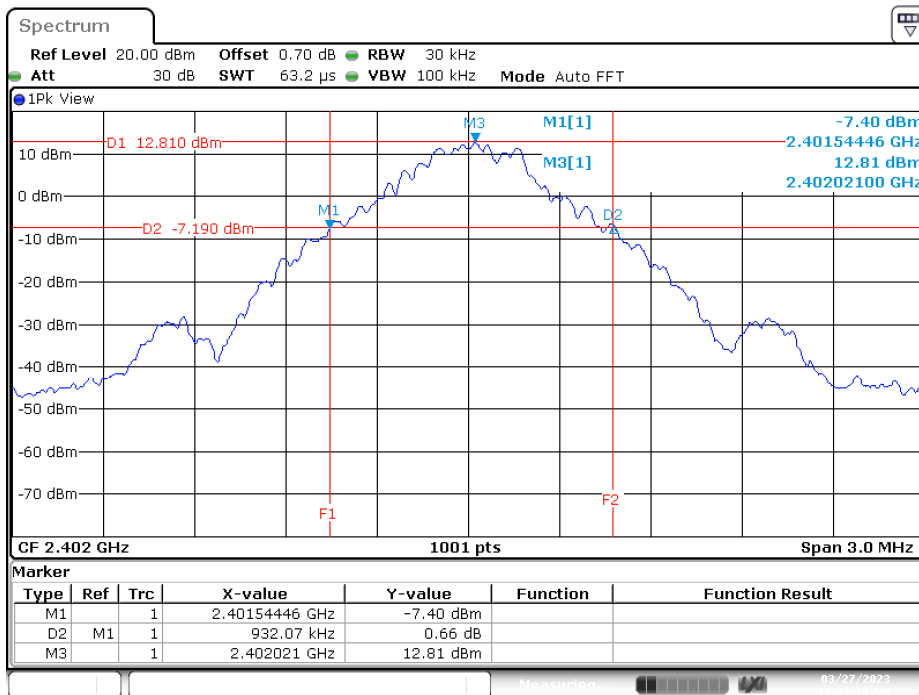

Date: 27.MAR.2023 11:29:31

Product : PanaCast 50 Video Bar System
 Test Item : Occupied Bandwidth Data
 Test Mode : Transmit - 3 Mbps
 Test Date : 2023/03/27

Channel No.	Frequency (MHz)	Measurement Level (kHz)	Required Limit (kHz)	Result
00	2402	1181	--	NA
39	2441	1181	--	NA
78	2480	1181	--	NA

Channel 39:

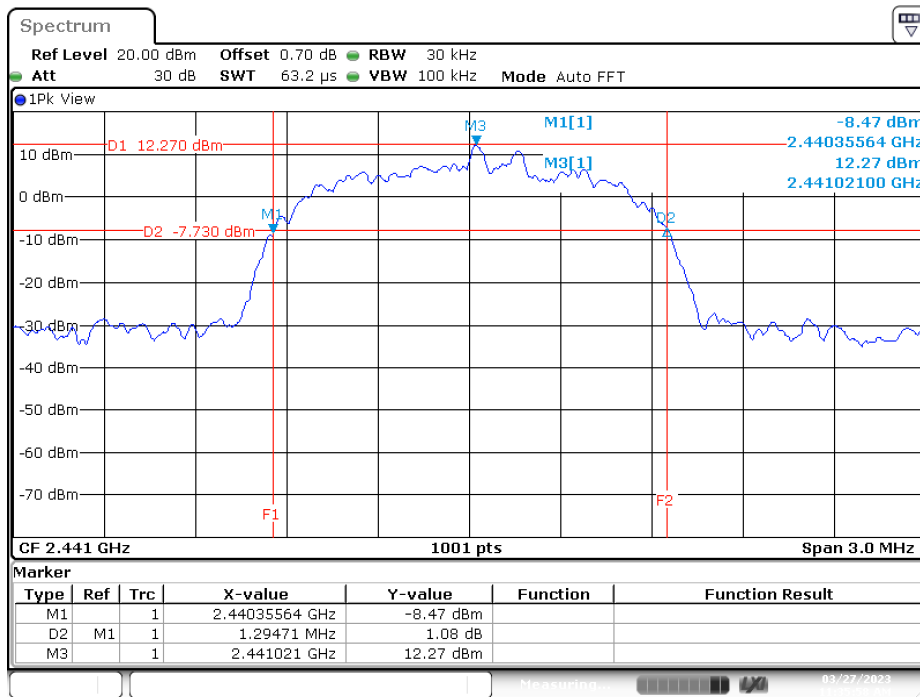

Date: 27.MAR.2023 11:35:58

11. Duty Cycle

11.1. Test Setup

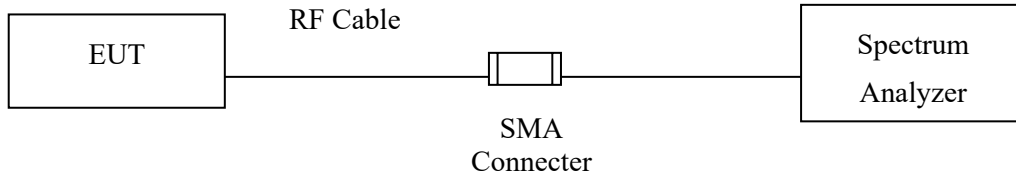

11.2. Test Result of Duty Cycle

Product : PanaCast 50 Video Bar System
 Test Item : Duty Cycle Data
 Test Mode : Transmit - 1 Mbps

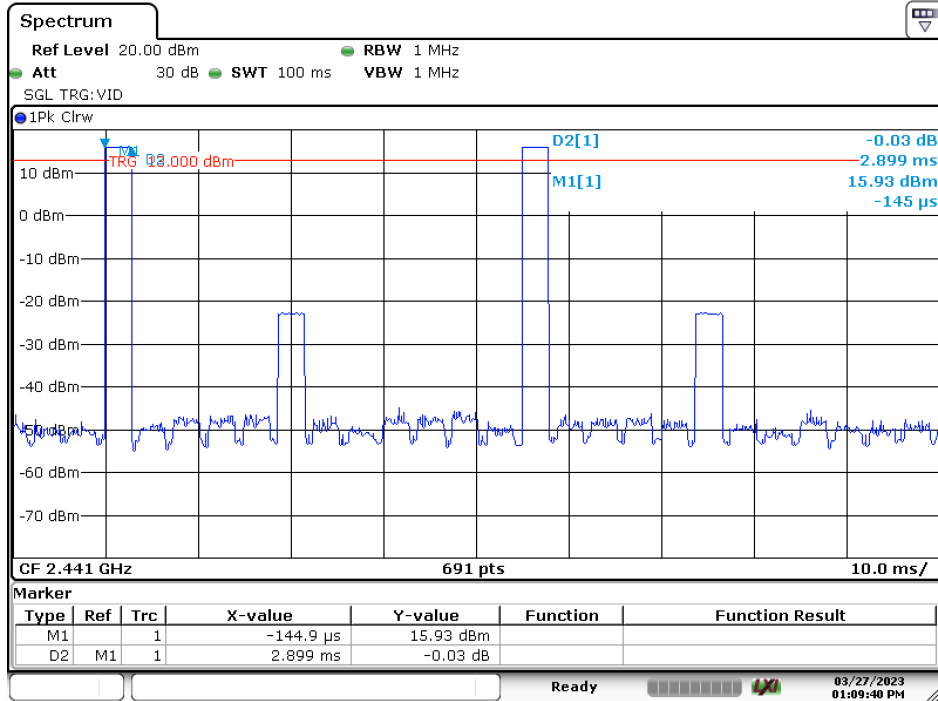

Date: 27.MAR.2023 13:09:41

Time on of 100ms = 5.798 msec

Duty Cycle = 5.798 msec / 100msec = 0.05798

Duty Cycle correction factor = 20 LOG 0.05798 = -24.734 dB

Duty Cycle correction factor	-24.734 dB
-------------------------------------	-------------------

Product : PanaCast 50 Video Bar System
 Test Item : Duty Cycle Data
 Test Mode : Transmit - 3 Mbps

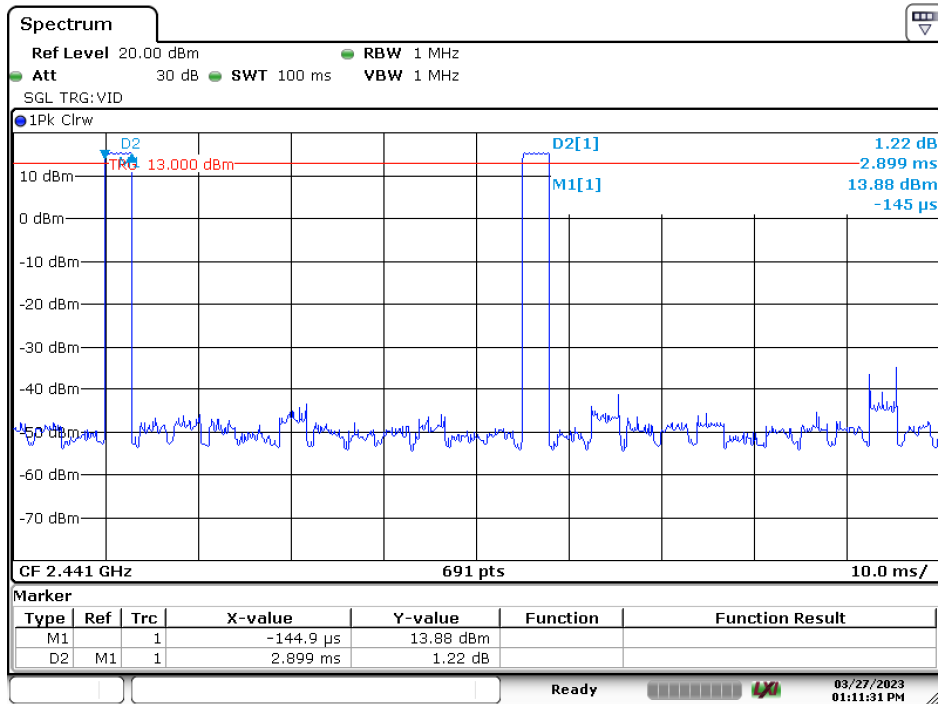

Date: 27.MAR.2023 13:11:32

Time on of 100ms = 5.798 msec

Duty Cycle = 5.798 msec / 100msec = 0.05798

Duty Cycle correction factor = 20 LOG 0.05798 = -24.734 dB

Duty Cycle correction factor	-24.734 dB
-------------------------------------	-------------------