

FCC Test Report

| | |
|--------------|-------------|
| Product Name | PanaCast 50 |
| Model No | VSM020 |
| FCC ID. | BCE-VSM020 |

| | |
|-----------|--|
| Applicant | GN Audio A/S |
| Address | Lautrupbjerg 7, 2750 Ballerup, Denmark |

| | |
|-----------------|----------------------|
| Date of Receipt | Dec. 21, 2020 |
| Issued Date | Feb. 17, 2021 |
| Report No. | 20C0767R-E3032110125 |
| Report Version | V1.0 |



The test results relate only to the samples tested.

The test results shown in the test report are traceable to the national/international standard through the calibration report of the equipment and evaluated measurement uncertainty herein.

This report must not be used to claim product endorsement by TAF or any agency of the government.

The test report shall not be reproduced without the written approval of DEKRA Testing and Certification Co., Ltd.

Measurement uncertainties evaluated for each testing system and associated connections are given here to provide the system information for reference. Compliance determinations do not take into account measurement uncertainties for each testing system, but are based on the results of the compliance measurement.

Test Report

Issued Date: Feb. 17, 2021

Report No.: 20C0767R-E3032110125



| | |
|---------------------|---|
| Product Name | PanaCast 50 |
| Applicant | GN Audio A/S |
| Address | Lautrupbjerg 7, 2750 Ballerup, Denmark |
| Manufacturer | GN Audio A/S |
| Model No. | VSM020 |
| FCC ID. | BCE-VSM020 |
| EUT Rated Voltage | AC 100-240V, 50-60Hz |
| EUT Test Voltage | AC 120V, 60Hz |
| Trade Name | Jabra |
| Applicable Standard | FCC CFR Title 47 Part 15 Subpart E ANSI C63.4: 2014, ANSI C63.10: 2013 KDB Publication 789033 |
| Test Result | Complied |

Documented By : Ida Tung
(Adm. Specialist / Ida Tung)

Tested By : Ivan Chuang
(Senior Engineer / Ivan Chuang)

Approved By : 
(Director / Vincent Lin)

TABLE OF CONTENTS

| Description | Page |
|---|------------|
| 1. GENERAL INFORMATION..... | 6 |
| 1.1. EUT Description..... | 6 |
| 1.2. Tested System Details..... | 9 |
| 1.3. Configuration of tested System | 9 |
| 1.4. EUT Exercise Software | 9 |
| 1.5. Test Facility | 10 |
| 1.6. List of Test Equipment | 11 |
| 1.7. Uncertainty | 12 |
| 2. Conducted Emission | 13 |
| 2.1. Test Setup | 13 |
| 2.2. Limits | 13 |
| 2.3. Test Procedure | 14 |
| 2.4. Test Result of Conducted Emission..... | 15 |
| 3. Maximun conducted output power..... | 17 |
| 3.1. Test Setup | 17 |
| 3.2. Limits | 18 |
| 3.3. Test Procedure | 19 |
| 3.4. Test Result of Maximum conducted output power..... | 20 |
| 4. Peak Power Spectral Density | 42 |
| 4.1. Test Setup | 42 |
| 4.2. Limits | 42 |
| 4.3. Test Procedure | 43 |
| 4.4. Test Result of Peak Power Spectral Density | 44 |
| 5. Radiated Emission..... | 71 |
| 5.1. Test Setup | 71 |
| 5.2. Limits | 72 |
| 5.3. Test Procedure | 73 |
| 5.4. Test Result of Radiated Emission..... | 75 |
| 6. Band Edge..... | 159 |
| 6.1. Test Setup | 159 |
| 6.2. Limits | 160 |
| 6.3. Test Procedure | 160 |
| 6.4. Test Result of Band Edge | 162 |
| 7. Occupied Bandwidth..... | 238 |
| 7.1. Test Setup | 238 |

| | | |
|--|---|------------|
| 7.2. | Limits | 238 |
| 7.3. | Test Procedure | 238 |
| 7.4. | Test Result of Occupied Bandwidth | 239 |
| 8. | Duty Cycle..... | 246 |
| 8.1. | Test Setup | 246 |
| 8.2. | Test Procedure | 246 |
| 8.3. | Test Result of Duty Cycle..... | 247 |
| 9. | EMI Reduction Method During Compliance Testing | 250 |
| Attachment 1: EUT Test Photographs | | |
| Attachment 2: EUT Detailed Photographs | | |

Revision History

| Report No. | Version | Description | Issued Date |
|----------------------|----------------|--------------------------|--------------------|
| 20C0767R-E3032110125 | V1.0 | Initial issue of report. | Feb. 17, 2021 |

1. GENERAL INFORMATION

1.1. EUT Description

| | |
|--------------------|--|
| Product Name | PanaCast 50 |
| Trade Name | Jabra |
| FCC ID. | BCE-VSM020 |
| Model No. | VSM020 |
| Frequency Range | 802.11a/n-20MHz: 5180-5320MHz, 5500-5720MHz, 5745-5825MHz 802.11n-40MHz: 5190-5310, 5510-5710MHz, 5755-5795MHz 802.11ac-80MHz: 5210-5290MHz, 5530-5690MHz, 5775MHz |
| Number of Channels | 802.11a/n-20MHz: 25; 802.11n-40MHz: 12; 802.11ac-80MHz: 6 |
| Data Rate | 802.11a: 6 - 54Mbps 802.11n: up to 150Mbps 802.11ac-80MHz: up to 433.3Mbps |
| Channel Control | Auto |
| Type of Modulation | 802.11a/n/ac: OFDM, BPSK, QPSK, 16QAM, 64QAM, 256QAM |
| Antenna type | PIFA Antenna |
| Antenna Gain | Refer to the table "Antenna List" |
| USB Cable | MFR: GN Audio A/S, M/N: Type C cable Shielded, 2m |
| Power Adapter | MFR: Wang Huei, M/N: WH-231 Input: AC 100-240V~1.5A, 50-60Hz Output: 12.0V=5.0A, 60W Cable Out: Non-shielded, 2m Power Cord: Non-shielded, 1m |
| Contain Module | Qualcomm / WCN3980 |

Antenna List

| No. | Manufacturer | Part No. | Antenna Type | Peak Gain |
|-----|--------------|-------------|--------------|---|
| 1 | GN Audio A/S | PanaCast 50 | PIFA Antenna | -0.46dBi for 5.150-5.250 GHz -0.46dBi for 5.250-5.350 GHz -0.60dBi for 5.470-5.725 GHz 0.01dBi for 5.725~5.85GHz |

Note: The antenna of EUT is conforming to FCC 15.203.

802.11a/n-20MHz Center Working Frequency of Each Channel:

| Channel | Frequency | Channel | Frequency | Channel | Frequency | Channel | Frequency |
|--------------|-----------|--------------|-----------|--------------|-----------|--------------|-----------|
| Channel 36: | 5180 MHz | Channel 40: | 5200 MHz | Channel 44: | 5220 MHz | Channel 48: | 5240 MHz |
| Channel 52: | 5260 MHz | Channel 56: | 5280 MHz | Channel 60: | 5300 MHz | Channel 64: | 5320 MHz |
| Channel 100: | 5500 MHz | Channel 104: | 5520 MHz | Channel 108: | 5540 MHz | Channel 112: | 5560 MHz |
| Channel 116: | 5580 MHz | Channel 120: | 5600 MHz | Channel 124: | 5620 MHz | Channel 128: | 5640 MHz |
| Channel 132: | 5660 MHz | Channel 136: | 5680 MHz | Channel 140: | 5700 MHz | Channel 144: | 5720 MHz |
| Channel 149: | 5745 MHz | Channel 153: | 5765 MHz | Channel 157: | 5785 MHz | Channel 161: | 5805 MHz |
| Channel 165: | 5825 MHz | | | | | | |

802.11n-40MHz Center Working Frequency of Each Channel:

| Channel | Frequency | Channel | Frequency | Channel | Frequency | Channel | Frequency |
|--------------|-----------|--------------|-----------|--------------|-----------|--------------|-----------|
| Channel 38: | 5190 MHz | Channel 46: | 5230 MHz | Channel 54: | 5270 MHz | Channel 62: | 5310 MHz |
| Channel 102: | 5510 MHz | Channel 110: | 5550 MHz | Channel 118: | 5590 MHz | Channel 126: | 5630 MHz |
| Channel 134: | 5670 MHz | Channel 142: | 5710 MHz | Channel 151: | 5755 MHz | Channel 159: | 5795 MHz |

802.11ac-80MHz Center Working Frequency of Each Channel:

| Channel | Frequency | Channel | Frequency | Channel | Frequency | Channel | Frequency |
|--------------|-----------|--------------|-----------|--------------|-----------|--------------|-----------|
| Channel 42: | 5210 MHz | Channel 58: | 5290 MHz | Channel 106: | 5530 MHz | Channel 122: | 5610 MHz |
| Channel 138: | 5690 MHz | Channel 155: | 5775 MHz | | | | |

Note:

1. This device is a PanaCast 50 with a built-in WLAN (802.11a/b/g/n/ac) with Bluetooth (5.0 and V3.0+HS, V2.1+EDR) transceiver, this report for 5GHz WLAN.
2. Regarding to the operation frequency, the lowest, middle and highest frequency are selected to perform the test.
3. Lowest and highest data rates are tested in each mode. Only worst case is shown in the report.
4. These tests were conducted on a sample of the equipment for the purpose of demonstrating compliance of transmitter with Part 15 Subpart E for Unlicensed National Information Infrastructure devices.

| | |
|-----------|--|
| Test Mode | Mode 1: Transmit (802.11a 6Mbps) Mode 2: Transmit (802.11n-20BW 7.2Mbps) Mode 3: Transmit (802.11n-40BW 15Mbps) Mode 4: Transmit (802.11ac-80BW 32.5Mbps) |
|-----------|--|

1.2. Tested System Details

The types for all equipment, plus descriptions of all cables used in the tested system (including inserted cards) are:

| Product | Manufacturer | Model No. | Serial No. | Power Cord |
|-----------------|--------------|-----------|--------------|------------|
| 1 Power Adapter | Wang Huei | WH-231 | N/A | N/A |
| 2 Notebook PC | Lenovo | T470 | N/A | N/A |
| 3 iPod shuffle | APPLE | A1373 | CC4PG9NGF4RY | N/A |

| Signal Cable Type | Signal cable Description |
|-------------------|--------------------------|
| A Power Cable | Non-shielded, 2m |
| B USB Cable | Shielded, 2m |
| C LAN Cable | Non-shielded, 2m |
| D Audio Cable | Shielded, 1.8m |
| E Power Cable | Non-shielded, 1m |

1.3. Configuration of tested System

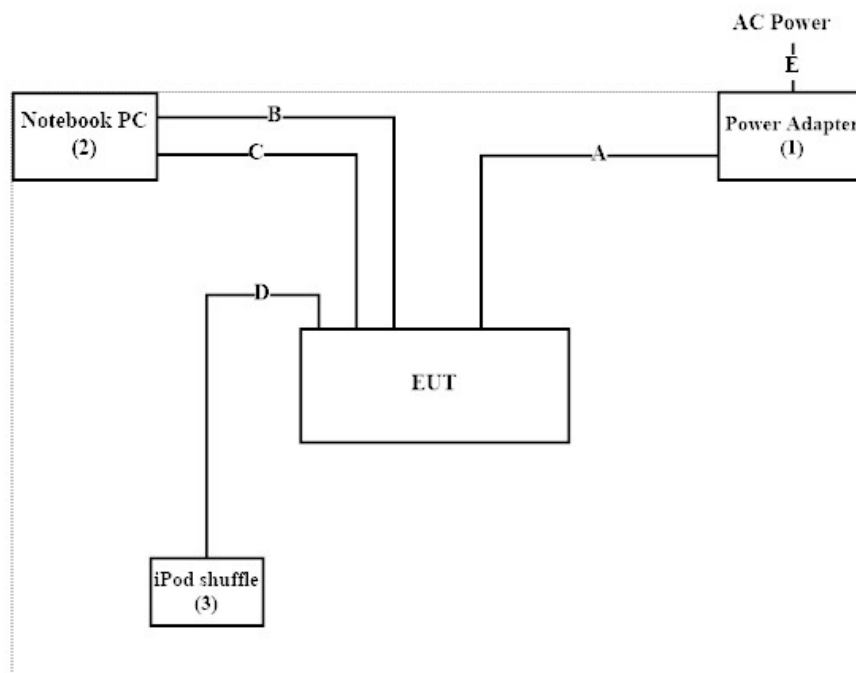

1.4. EUT Exercise Software

1. Setup the EUT as shown in Section 1.3.
2. Execute software "Qualcomm Radio Control Toolkit Version 4.0.00177.0" on the EUT.
3. Configure the test mode, the test channel, and the data rate.
4. Press "OK" to start the continuous Transmit.
5. Verify that the EUT works properly.

1.5. Test Facility

Ambient conditions in the laboratory:

| Performed Item | Items | Required | Actual |
|--------------------|------------------|----------|---------|
| Conducted Emission | Temperature (°C) | 10~40 °C | 20.0 °C |
| | Humidity (%RH) | 10~90 % | 67.6 % |
| Radiated Emission | Temperature (°C) | 10~40 °C | 20.1 °C |
| | Humidity (%RH) | 10~90 % | 65.5 % |
| Conductive | Temperature (°C) | 10~40 °C | 22.0 °C |
| | Humidity (%RH) | 10~90 % | 55.0 % |

USA : FCC Registration Number: TW0023

Canada : IC Registration Number: 25880

Site Description : Accredited by TAF
Accredited Number: 3023

Test Laboratory : DEKRA Testing and Certification Co., Ltd
Address : No.159, Sec. 2, Wenhua 1st Rd., Linkou Dist.,
New Taipei City 24457, Taiwan, R.O.C.

Phone number : 886-2-2602-7968
Fax number : 866-2-2602-3286
Email address : info.tw@dekra.com
Website : <http://www.dekra.com.tw>

1.6. List of Test Equipment

For Conduction measurements /ASR1

| | Equipment | Manufacturer | Model No. | Serial No. | Cali. Data | Due. Data |
|---|--------------------|--------------|-----------|------------|------------|------------|
| X | EMI Test Receiver | R&S | ESR7 | 101601 | 2020.05.28 | 2021.05.27 |
| X | Two-Line V-Network | R&S | ENV216 | 101306 | 2020.03.25 | 2021.03.24 |
| X | Two-Line V-Network | R&S | ENV216 | 101307 | 2020.04.17 | 2021.04.16 |
| X | Coaxial Cable | DEKRA | RG400_BNC | RF001 | 2020.05.24 | 2021.05.23 |

Note:

1. All equipments are calibrated every one year.
2. The test instruments marked with “X” are used to measure the final test results.
3. Test Software version : DEKRA Testing System V2.0

For Conducted measurements /ASR2

| | Equipment | Manufacturer | Model No. | Serial No. | Cali. Data | Due. Data |
|---|-------------------|--------------|-----------|------------|------------|------------|
| X | Spectrum Analyzer | Agilent | N9010A | MY55150401 | 2020.09.15 | 2021.09.14 |
| X | Spectrum Analyzer | R&S | FSV30 | 103466 | 2020.12.28 | 2021.12.27 |
| X | Power Meter | Anritsu | ML2496A | MY51000539 | 2020.05.13 | 2021.05.12 |
| X | Power Sensor | Anritsu | MA2411B | MY59240002 | 2020.05.22 | 2021.05.21 |
| X | Power Sensor | Anritsu | MA2411B | MY59240003 | 2020.05.22 | 2021.05.21 |

Note:

1. All equipments are calibrated every one year.
2. The test instruments marked with “X” are used to measure the final test results.
3. Test Software version : DEKRA Conduction Test System V9.0.5.

For Radiated measurements /ACB1

| | Equipment | Manufacturer | Model No. | Serial No. | Cali. Data | Due. Data |
|---|-------------------|---------------|--------------|------------|------------|------------|
| X | Loop Antenna | AMETEK | HLA6121 | 49611 | 2020.03.16 | 2021.03.15 |
| X | Bi-Log Antenna | SCHWARZBECK | VULB9168 | 9168-675 | 2020.07.20 | 2021.07.19 |
| X | Horn Antenna | ETS-Lindgren | 3117 | 00201366 | 2020.09.21 | 2021.09.20 |
| X | Horn Antenna | Com-Power | AH-840 | 101088 | 2020.09.11 | 2021.09.10 |
| X | Pre-Amplifier | EMCI | EMC001330 | 980301 | 2020.06.04 | 2021.06.03 |
| X | Pre-Amplifier | EMCI | EMC051845SE | 980632 | 2020.08.21 | 2021.08.20 |
| X | Pre-Amplifier | EMCI | EMC05820SE | 980308 | 2020.09.18 | 2021.09.17 |
| X | Pre-Amplifier | EMCI | EMC184045SE | 980314 | 2020.06.10 | 2021.06.09 |
| | Filter | MICRO TRONICS | BRM50702 | G251 | 2020.09.17 | 2021.09.16 |
| X | Filter | MICRO TRONICS | BRM50716 | G188 | 2020.09.17 | 2021.09.16 |
| X | EMI Test Receiver | R&S | ESR7 | 101601 | 2020.05.21 | 2021.05.20 |
| X | Spectrum Analyzer | R&S | FSV40 | 101147 | 2020.04.20 | 2021.04.19 |
| X | Coaxial Cable | SUHNER | SUCOFLEX 106 | RF002 | 2020.07.03 | 2021.07.02 |
| X | Mircoflex Cable | HUBER SUHNER | SUCOFLEX 102 | MY3381/2 | 2020.06.10 | 2021.06.09 |

Note:

1. Loop Antenna is calibrated every two years, the other equipments are calibrated every one year.
2. The test instruments marked with “X” are used to measure the final test results.
3. Test Software version : DEKRA Testing System V2.0

1.7. Uncertainty

Uncertainties have been calculated according to the DEKRA internal document, and is described in each test chapter of this report.

The reported expanded uncertainties are based on a standard uncertainty multiplied by a coverage factor of $k=2$, providing a level of confidence of approximately 95%.

Measurement uncertainties evaluated for each testing system and associated connections are given here to provide the system information for reference. Compliance determinations do not take into account measurement uncertainties for each testing system, but are based on the results of the compliance measurement.

| Test item | Uncertainty | |
|--------------------------------|-------------------------|------------------------|
| Conducted Emission | ±3.42 dB | |
| Maximun conducted output power | Power Meter ±0.91 dB | |
| Peak Power Spectral Density | ±2.53 dB | |
| Radiated Emission | Under 1GHz ±4.06 dB | Above 1GHz ±3.73 dB |
| Band Edge | ±2.53 dB | |
| Occupied Bandwidth | ±682.83 Hz | |
| Duty Cycle | ±2.31 ms | |

2. Conducted Emission

2.1. Test Setup

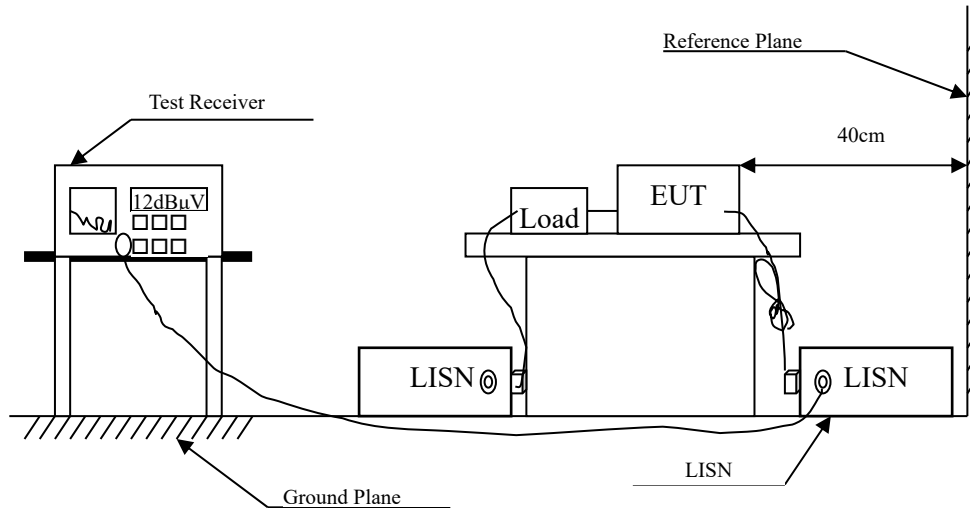

2.2. Limits

| FCC Part 15 Subpart C Paragraph 15.207 (dBµV) Limit | | |
|---|--------|-------|
| Frequency MHz | Limits | |
| | QP | AV |
| 0.15 - 0.50 | 66-56 | 56-46 |
| 0.50-5.0 | 56 | 46 |
| 5.0 - 30 | 60 | 50 |

Remarks : In the above table, the tighter limit applies at the band edges.

2.3. Test Procedure

The EUT and simulators are connected to the main power through a line impedance stabilization network (L.I.S.N.). This provides a 50 ohm /50uH coupling impedance for the measuring equipment. The peripheral devices are also connected to the main power through a LISN that provides a 50ohm /50uH coupling impedance with 50ohm termination. (Please refers to the block diagram of the test setup and photographs.)

Both sides of A.C. line are checked for maximum conducted interference. In order to find the maximum emission, the relative positions of equipment and all of the interface cables must be changed according to ANSI C63.4:2014 on conducted measurement.

Conducted emissions were investigated over the frequency range from 0.15MHz to 30MHz using a receiver bandwidth of 9kHz.

2.4. Test Result of Conducted Emission

Product : PanaCast 50
 Test Item : Conducted Emission Test
 Power Line : L 1
 Test Mode : Mode 4: Transmit (802.11ac-80BW 32.5Mbps) (5775MHz)
 Test Date : 2021/02/10

L 1

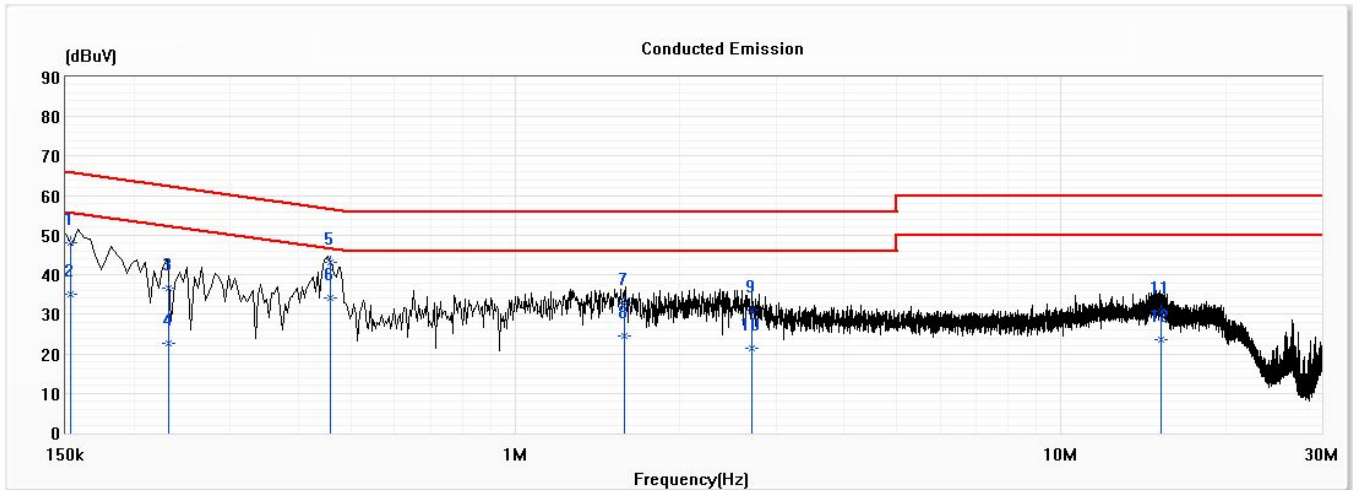

| No | Frequency (MHz) | Emission Level (dBuV) | Limit (dBuV) | Margin (dB) | Reading Level (dBuV) | Correct Factor (dB) | Detector Type |
|----|-----------------|-----------------------|--------------|-------------|----------------------|---------------------|---------------|
| 1 | 0.153 | 48.24 | 65.83 | -17.60 | 38.58 | 9.66 | QP |
| 2 | 0.153 | 35.17 | 55.83 | -20.66 | 25.51 | 9.66 | AV |
| 3 | 0.231 | 36.50 | 62.41 | -25.90 | 26.85 | 9.65 | QP |
| 4 | 0.231 | 22.78 | 52.41 | -29.63 | 13.13 | 9.65 | AV |
| 5 | 0.457 | 43.03 | 56.75 | -13.72 | 33.37 | 9.66 | QP |
| *6 | 0.457 | 34.24 | 46.75 | -12.51 | 24.58 | 9.66 | AV |
| 7 | 1.587 | 33.00 | 56.00 | -23.00 | 23.29 | 9.71 | QP |
| 8 | 1.587 | 24.40 | 46.00 | -21.60 | 14.69 | 9.71 | AV |
| 9 | 2.708 | 31.07 | 56.00 | -24.93 | 21.33 | 9.73 | QP |
| 10 | 2.708 | 21.27 | 46.00 | -24.73 | 11.53 | 9.73 | AV |
| 11 | 15.204 | 30.57 | 60.00 | -29.43 | 20.62 | 9.94 | QP |
| 12 | 15.204 | 23.46 | 50.00 | -26.54 | 13.52 | 9.94 | AV |

Note:

1. All Reading Levels are Quasi-Peak and average value.
2. “ * “ means the worst emission level.
3. Measurement Level = Reading Level + Correct Factor

Product : PanaCast 50
 Test Item : Conducted Emission Test
 Power Line : N
 Test Mode : Mode 4: Transmit (802.11ac-80BW 32.5Mbps) (5775MHz)
 Test Date : 2021/02/10

N

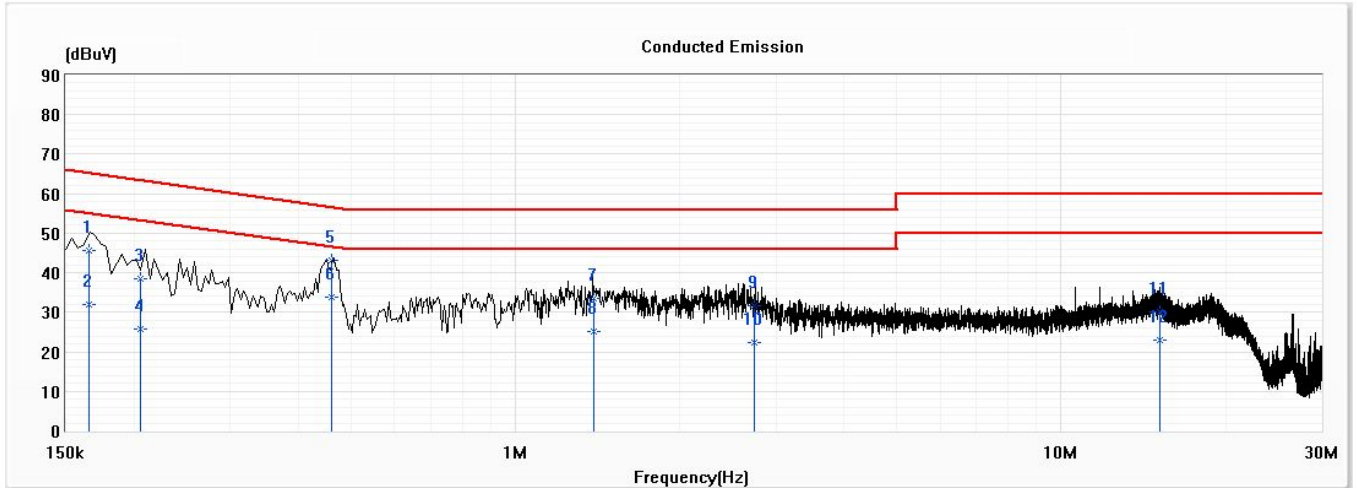

| No | Frequency (MHz) | Emission Level (dBuV) | Limit (dBuV) | Margin (dB) | Reading Level (dBuV) | Correct Factor (dB) | Detector Type |
|----|-----------------|-----------------------|--------------|-------------|----------------------|---------------------|---------------|
| 1 | 0.166 | 45.74 | 65.17 | -19.43 | 36.07 | 9.67 | QP |
| 2 | 0.166 | 31.83 | 55.17 | -23.33 | 22.16 | 9.67 | AV |
| 3 | 0.206 | 38.61 | 63.38 | -24.78 | 28.94 | 9.67 | QP |
| 4 | 0.206 | 25.69 | 53.38 | -27.69 | 16.02 | 9.67 | AV |
| 5 | 0.461 | 43.01 | 56.67 | -13.66 | 33.34 | 9.67 | QP |
| *6 | 0.461 | 33.88 | 46.67 | -12.79 | 24.21 | 9.67 | AV |
| 7 | 1.391 | 33.44 | 56.00 | -22.56 | 23.73 | 9.70 | QP |
| 8 | 1.391 | 25.22 | 46.00 | -20.78 | 15.51 | 9.70 | AV |
| 9 | 2.746 | 31.68 | 56.00 | -24.32 | 21.93 | 9.74 | QP |
| 10 | 2.746 | 22.22 | 46.00 | -23.78 | 12.48 | 9.74 | AV |
| 11 | 15.188 | 30.25 | 60.00 | -29.75 | 20.25 | 10.00 | QP |
| 12 | 15.188 | 23.08 | 50.00 | -26.92 | 13.08 | 10.00 | AV |

Note:

1. All Reading Levels are Quasi-Peak and average value.
2. “ * “ means the worst emission level.
3. Measurement Level = Reading Level + Correct Factor

3. Maximun conducted output power

3.1. Test Setup

26dB Occupied Bandwidth

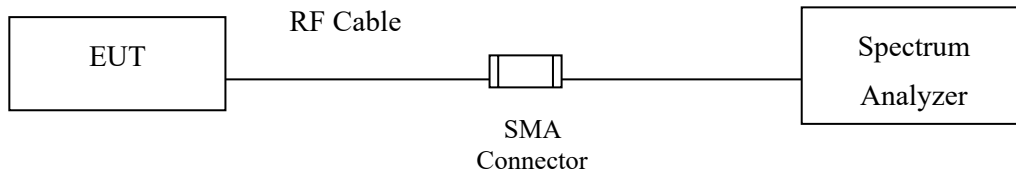

Conduction Power Measurement (for 802.11an)

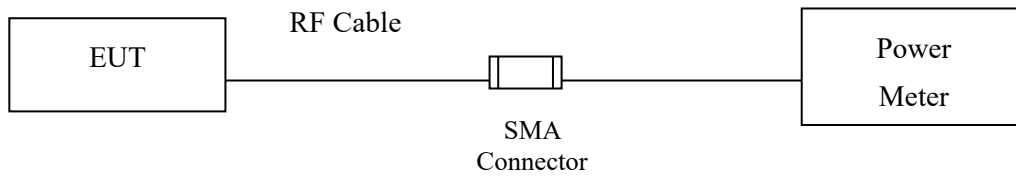

Conduction Power Measurement (for 802.11ac)

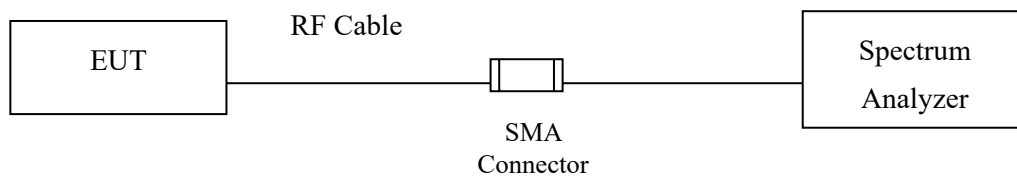

3.2. Limits

For the band 5.15-5.25 GHz,

(i) For an outdoor access point operating in the band 5.15-5.25 GHz, the maximum conducted output power over the frequency band of operation shall not exceed 1 W, provided the maximum antenna gain does not exceed 6 dBi. If transmitting antennas of directional gain greater than 6 dBi are used, the maximum conducted output power shall be reduced by the amount in dB that the directional gain of the antenna exceeds 6 dBi. The maximum e.i.r.p. at any elevation angle above 30 degrees as measured from the horizon must not exceed 125 mW (21 dBm).

(ii) For an indoor access point operating in the band 5.15-5.25 GHz, the maximum conducted output power over the frequency band of operation shall not exceed 1 W provided the maximum antenna gain does not exceed 6 dBi. In addition, if transmitting antennas of directional gain greater than 6 dBi are used, the maximum conducted output power shall be reduced by the amount in dB that the directional gain of the antenna exceeds 6 dBi.

(iii) For fixed point-to-point access points operating in the band 5.15-5.25 GHz, the maximum conducted output power over the frequency band of operation shall not exceed 1 W. Fixed point-to-point U-NII devices may employ antennas with directional gain up to 23 dBi without any corresponding reduction in the maximum conducted output power. For fixed point-to-point transmitters that employ a directional antenna gain greater than 23 dBi, a 1 dB reduction in maximum conducted output power is required for each 1 dB of antenna gain in excess of 23 dBi. Fixed, point-to-point operations exclude the use of point-to-multipoint systems, omnidirectional applications, and multiple collocated transmitters transmitting the same information. The operator of the U-NII device, or if the equipment is professionally installed, the installer, is responsible for ensuring that systems employing high gain directional antennas are used exclusively for fixed, point-to-point operations.

(iv) For mobile and portable client devices in the 5.15-5.25 GHz band, the maximum conducted output power over the frequency band of operation shall not exceed 250 mW provided the maximum antenna gain does not exceed 6 dBi. In addition, if transmitting antennas of directional gain greater than 6 dBi are used, the maximum conducted output power shall be reduced by the amount in dB that the directional gain of the antenna exceeds 6 dBi.

For the 5.25-5.35 GHz and 5.47-5.725 GHz bands, the maximum conducted output power over the frequency bands of operation shall not exceed the lesser of 250 mW or $11 \text{ dBm} + 10 \log B$, where B is the 99% emission bandwidth in megahertz. If transmitting antennas of directional gain greater than 6 dBi are used, the maximum conducted output power shall be reduced by the amount in dB that the directional gain of the antenna exceeds 6 dBi.

For the band 5.725-5.85 GHz, the maximum conducted output power over the frequency band of operation shall not exceed 1 W. In addition, if transmitting antennas of directional gain greater than 6 dBi are used, the maximum conducted output power shall be reduced by the amount in dB that the directional gain of the antenna exceeds 6 dBi. However, fixed point-to-point UNII devices operating in this band may employ transmitting antennas with directional gain greater than 6 dBi without any corresponding reduction in transmitter conducted power. Fixed, point-to-point operations exclude the use of point-to-multipoint systems, omnidirectional applications, and multiple collocated transmitters transmitting the same information. The operator of the U-NII device, or if the equipment is professionally installed, the installer, is responsible for ensuring that systems employing high gain directional antennas are used exclusively for fixed, point-to-point operations.

3.3. Test Procedure

As an alternative to FCC KDB-789033, the EUT maximum conducted output power was measured with an average power meter employing a video bandwidth greater than the 6dB BW of the emission under test. Maximum conducted output power was read directly from the meter across all data rates, and across three channels within each sub-band. Special care was used to make sure that the EUT was transmitting in continuous mode. This method exceeds the limitations of FCC KDB-789033, and provides more accurate measurements.

802.11an (BW \leq 40MHz) Maximum conducted output power using KDB 789033 section E)3)b) Method PM-G (Measurement using a gated RF average power meter)

Note: the power meter have a video bandwidth that is greater than or equal to the measurement bandwidth, (Anritsu/ MA2411B video bandwidth: 65MHz)

802.11ac (BW=80MHz) Maximum conducted output power using KDB 789033 section E)2)b) Method SA-1 (trace averaging with the EUT transmitting at full power throughout each sweep).

When transmitted signals consist of two or more non-contiguous spectrum segments (e.g., 80+80 MHz mode) or when a single spectrum segment of a transmission crosses the boundary between two adjacent U-NII bands, KDB 644545 D03 section D) procedure is used for measurements.

3.4. Test Result of Maximum conducted output power

Product : PanaCast 50
 Test Item : Maximum conducted output power
 Test Mode : Mode 1: Transmit (802.11a 6Mbps)
 Test Date : 2020/12/31

| Cable loss=1dB | | Maximum conducted output power | | | | | | | |
|----------------|-----------------|--------------------------------|-------|-------|-------|-------|-------|-------|-------|
| Channel No. | Frequency (MHz) | Data Rate (Mbps) | | | | | | | |
| | | 6 | 9 | 12 | 18 | 24 | 36 | 48 | 54 |
| | | Measurement Level (dBm) | | | | | | | |
| 36 | 5180 | 13.7 | -- | -- | -- | -- | -- | -- | -- |
| 44 | 5220 | 13.97 | 13.88 | 13.8 | 13.75 | 13.68 | 13.65 | 13.62 | 13.58 |
| 48 | 5240 | 13.78 | -- | -- | -- | -- | -- | -- | -- |
| 52 | 5260 | 13.65 | -- | -- | -- | -- | -- | -- | -- |
| 60 | 5300 | 13.87 | 13.81 | 13.73 | 13.67 | 13.64 | 13.61 | 13.55 | 13.51 |
| 64 | 5320 | 13.85 | -- | -- | -- | -- | -- | -- | -- |
| 100 | 5500 | 14.7 | -- | -- | -- | -- | -- | -- | -- |
| 116 | 5580 | 14.94 | 14.91 | 14.81 | 14.72 | 14.66 | 14.59 | 14.49 | 14.43 |
| 140 | 5700 | 14.87 | -- | -- | -- | -- | -- | -- | -- |
| 149 | 5745 | 14.96 | -- | -- | -- | -- | -- | -- | -- |
| 157 | 5785 | 14.78 | 14.75 | 14.72 | 14.63 | 14.58 | 14.5 | 14.47 | 14.39 |
| 165 | 5825 | 14.9 | -- | -- | -- | -- | -- | -- | -- |

Note: Maximum conducted output power Value =Reading value on average power meter + cable loss

Maximum conducted output power Measurement:

| Channel No | Frequency Range (MHz) | 26dB Bandwidth (MHz) | Output Power (dBm) | Output Power Limit | |
|------------|-----------------------|----------------------|--------------------|--------------------|---------------|
| | | | | (dBm) | dBm+10log(BW) |
| 36 | 5180 | -- | 13.7 | 24 | -- |
| 44 | 5220 | -- | 13.97 | 24 | -- |
| 48 | 5240 | -- | 13.78 | 24 | -- |
| 52 | 5260 | 22.500 | 13.65 | 24 | 24.52 |
| 60 | 5300 | 22.850 | 13.87 | 24 | 24.59 |
| 64 | 5320 | 22.150 | 13.85 | 24 | 24.45 |
| 100 | 5500 | 22.500 | 14.7 | 24 | 24.52 |
| 116 | 5580 | 22.950 | 14.94 | 24 | 24.61 |
| 140 | 5700 | 22.200 | 14.87 | 24 | 24.46 |
| 149 | 5745 | -- | 14.96 | 30 | -- |
| 157 | 5785 | -- | 14.78 | 30 | -- |
| 165 | 5825 | -- | 14.9 | 30 | -- |

26dB Occupied Bandwidth: Channel 52:

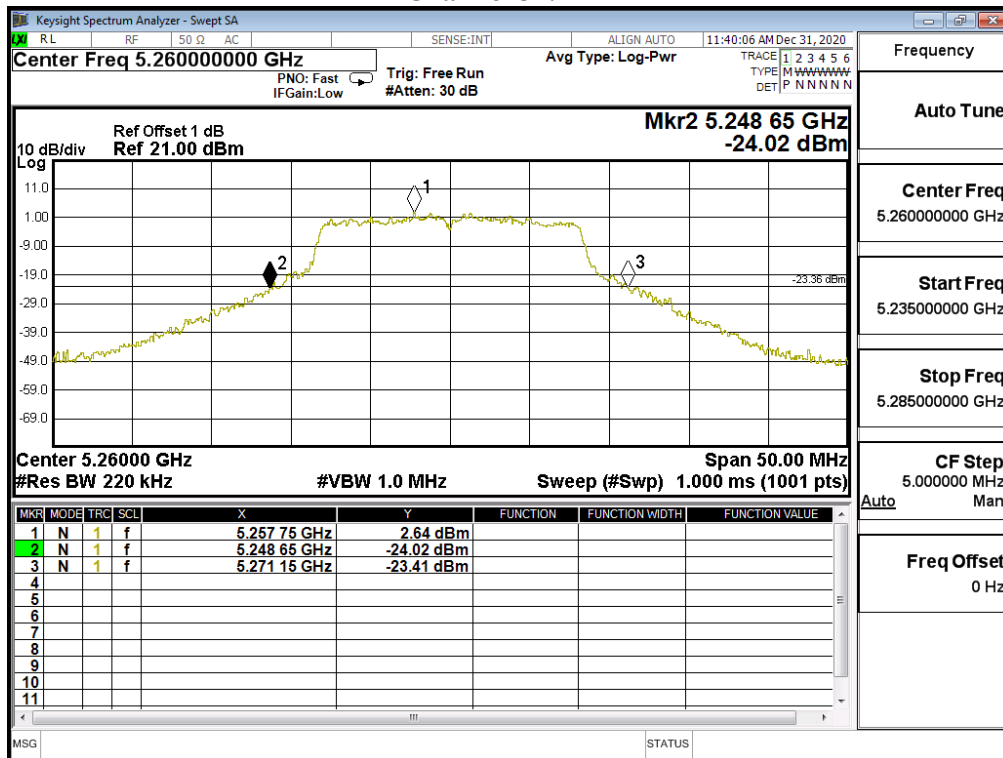

Channel 60:

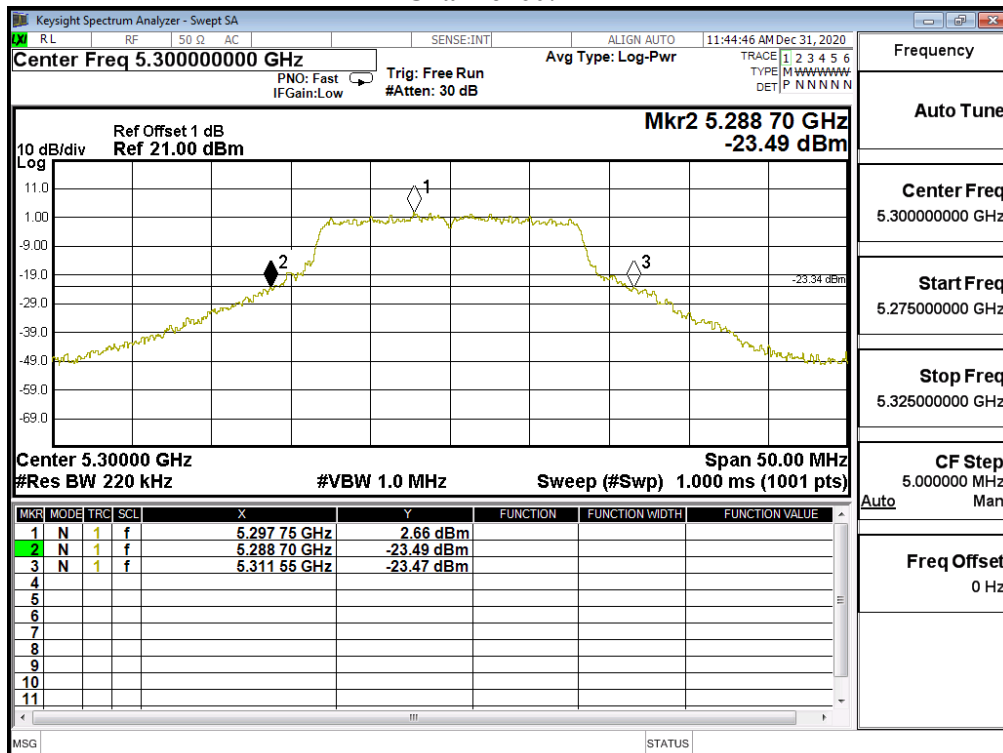

Channel 64:

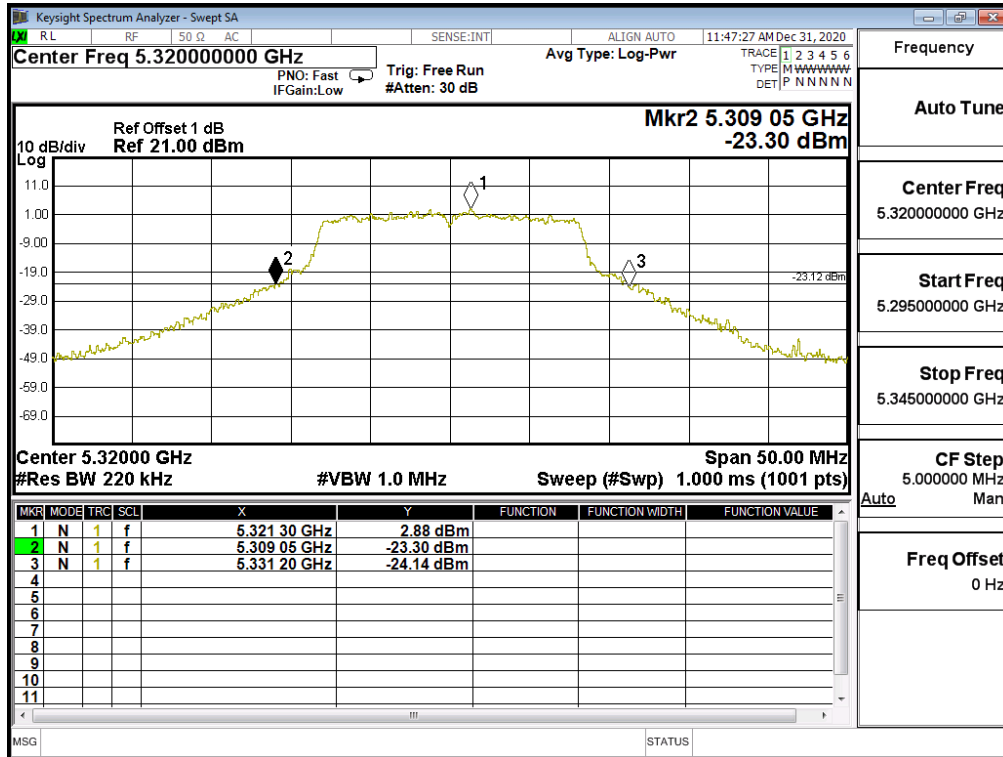

Channel 100:

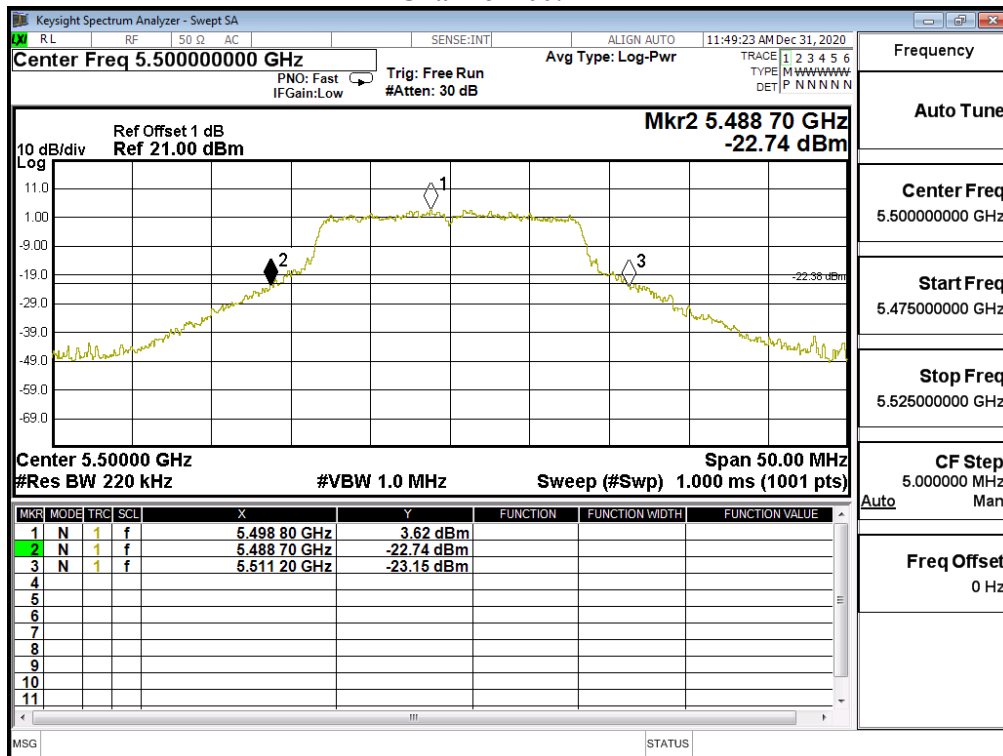

Channel 116:

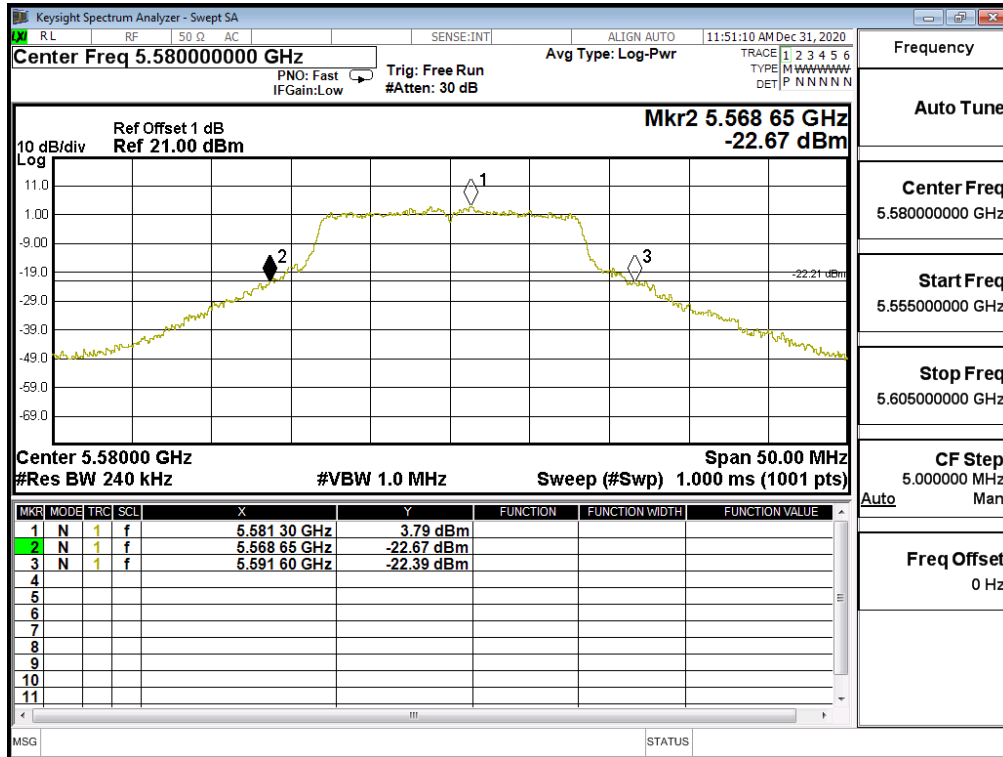

Channel 140:

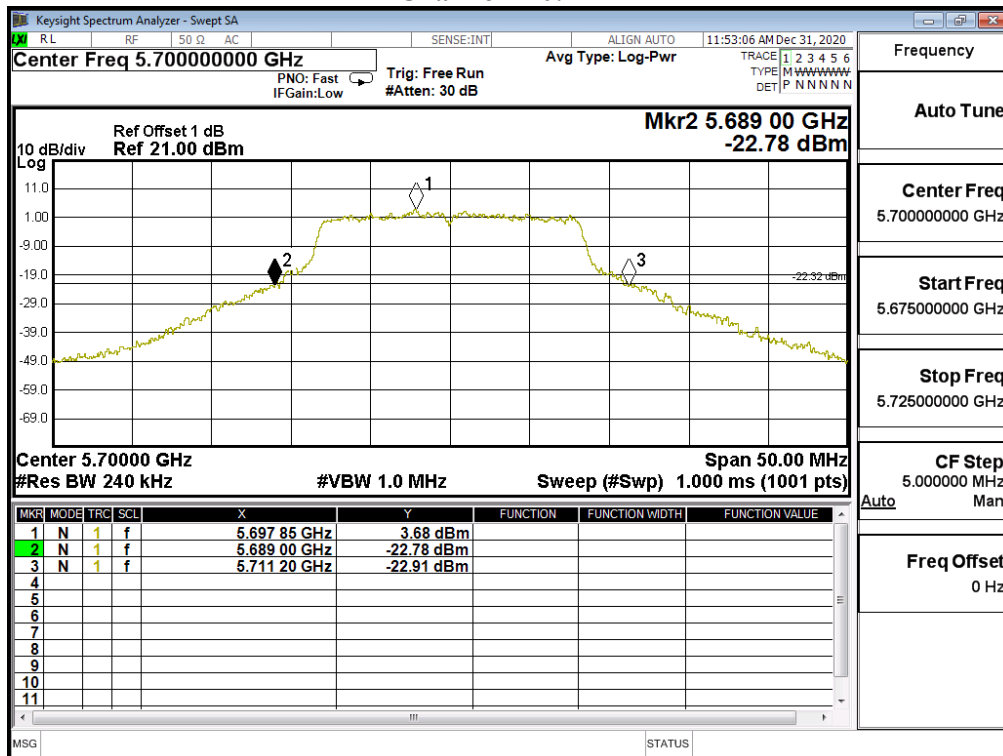

Product : PanaCast 50
 Test Item : Maximum conducted output power
 Test Mode : Mode 2: Transmit (802.11n-20BW 7.2Mbps)
 Test Date : 2020/12/31

| Cable loss=1dB | | Maximum conducted output power | | | | | | | |
|----------------|-----------------|--------------------------------|-------|-------|-------|-------|-------|-------|-------|
| Channel No. | Frequency (MHz) | Data Rate (Mbps) | | | | | | | |
| | | 7.2 | 14.4 | 21.7 | 28.9 | 43.3 | 57.8 | 65 | 72.2 |
| | | Measurement Level (dBm) | | | | | | | |
| 36 | 5180 | 14.8 | -- | -- | -- | -- | -- | -- | -- |
| 44 | 5220 | 14.83 | 14.78 | 14.74 | 14.71 | 14.68 | 14.6 | 14.55 | 14.52 |
| 48 | 5240 | 14.86 | -- | -- | -- | -- | -- | -- | -- |
| 52 | 5260 | 14.92 | -- | -- | -- | -- | -- | -- | -- |
| 60 | 5300 | 14.97 | 14.89 | 14.85 | 14.8 | 14.72 | 14.66 | 14.63 | 14.59 |
| 64 | 5320 | 14.77 | -- | -- | -- | -- | -- | -- | -- |
| 100 | 5500 | 14.97 | -- | -- | -- | -- | -- | -- | -- |
| 116 | 5580 | 14.8 | 14.77 | 14.71 | 14.61 | 14.54 | 14.46 | 14.36 | 14.27 |
| 140 | 5700 | 14.7 | -- | -- | -- | -- | -- | -- | -- |
| 144(U-NII-2C) | 5720 | 14.05 | 14.02 | 13.98 | 13.93 | 13.84 | 13.78 | 13.74 | 13.65 |
| 144(U-NII-3) | 5720 | 7.54 | 7.44 | 7.38 | 7.3 | 7.21 | 7.17 | 7.09 | 7.05 |
| 149 | 5745 | 14.78 | -- | -- | -- | -- | -- | -- | -- |
| 157 | 5785 | 14.95 | 14.85 | 14.78 | 14.71 | 14.61 | 14.51 | 14.48 | 14.42 |
| 165 | 5825 | 14.74 | -- | -- | -- | -- | -- | -- | -- |

Note: Maximum conducted output power Value =Reading value on average power meter + cable loss

Maximum conducted output power Measurement:

| Channel No | Frequency Range (MHz) | 26dB Bandwidth (MHz) | Output Power (dBm) | Output Power Limit | |
|---------------|-----------------------|----------------------|--------------------|--------------------|---------------|
| | | | | (dBm) | dBm+10log(BW) |
| 36 | 5180 | -- | 14.8 | 24 | -- |
| 44 | 5220 | -- | 14.83 | 24 | -- |
| 48 | 5240 | -- | 14.86 | 24 | -- |
| 52 | 5260 | 22.900 | 14.92 | 24 | 24.60 |
| 60 | 5300 | 23.250 | 14.97 | 24 | 24.66 |
| 64 | 5320 | 23.000 | 14.77 | 24 | 24.62 |
| 100 | 5500 | 23.050 | 14.97 | 24 | 24.63 |
| 116 | 5580 | 23.350 | 14.8 | 24 | 24.68 |
| 140 | 5700 | 23.350 | 14.7 | 24 | 24.68 |
| 144(U-NII-2C) | 5720 | 16.500 | 14.05 | 24 | 23.17 |
| 144(U-NII-3) | 5720 | -- | 7.54 | 30 | -- |
| 149 | 5745 | -- | 14.78 | 30 | -- |
| 157 | 5785 | -- | 14.95 | 30 | -- |
| 165 | 5825 | -- | 14.74 | 30 | -- |

26dB Occupied Bandwidth: Channel 52

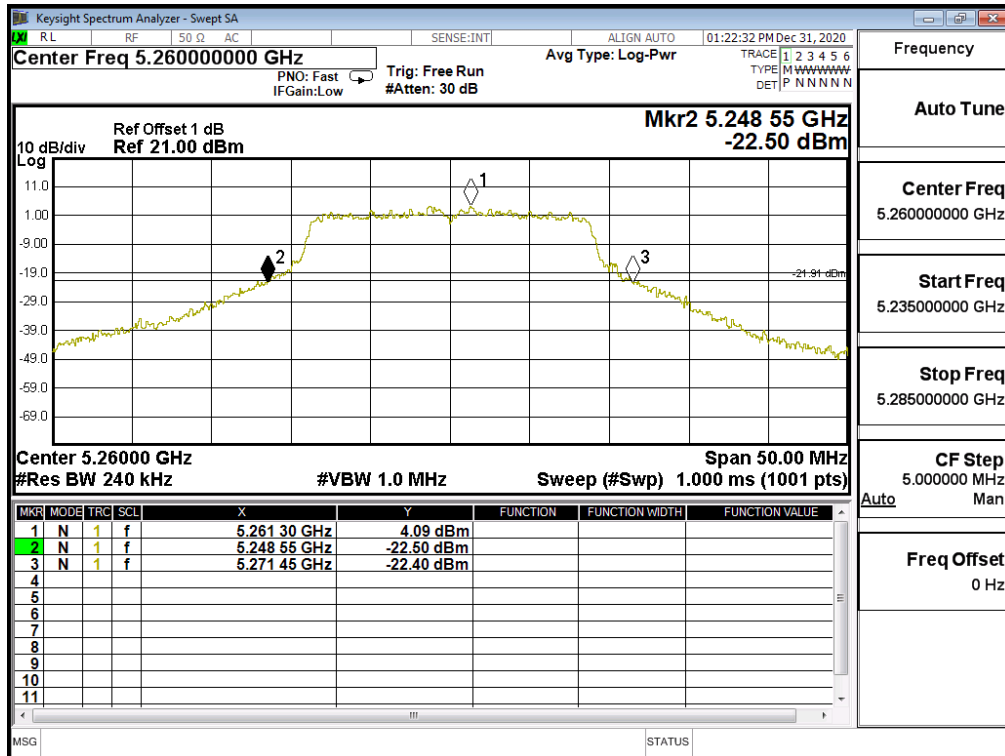

Channel 60

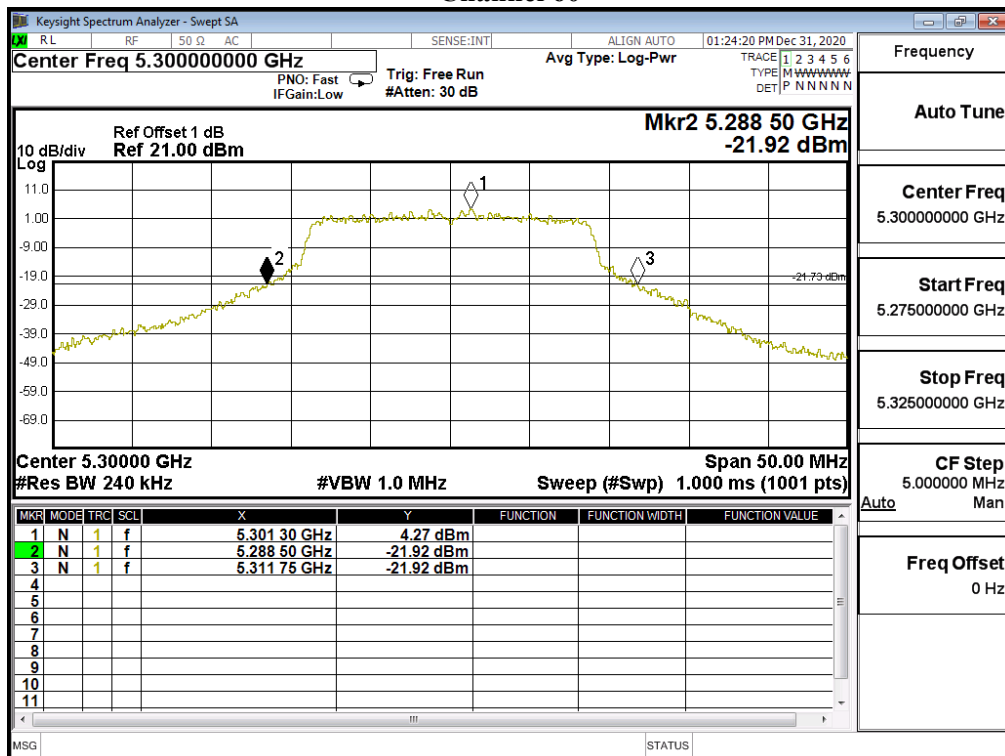

Channel 64

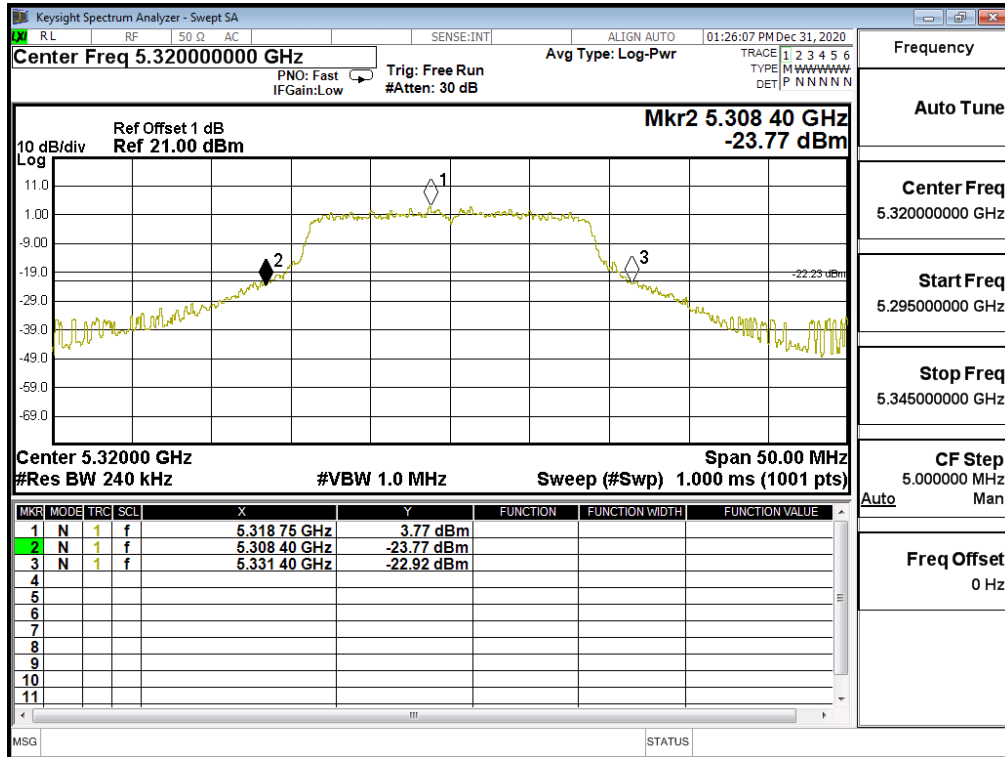

Channel 100

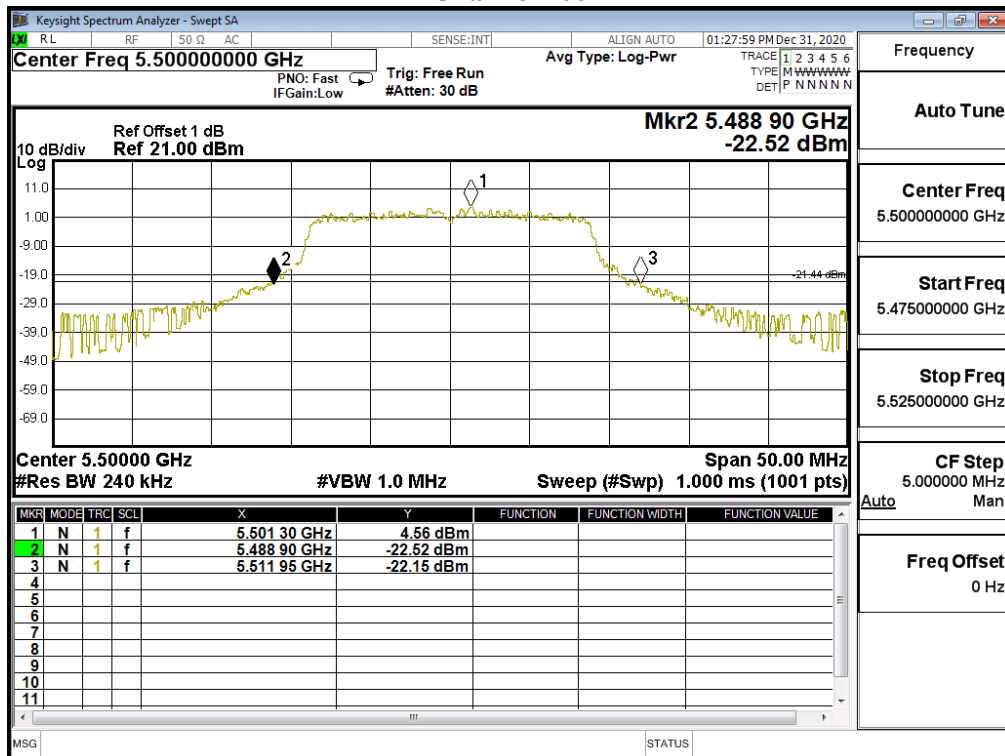

Channel 116

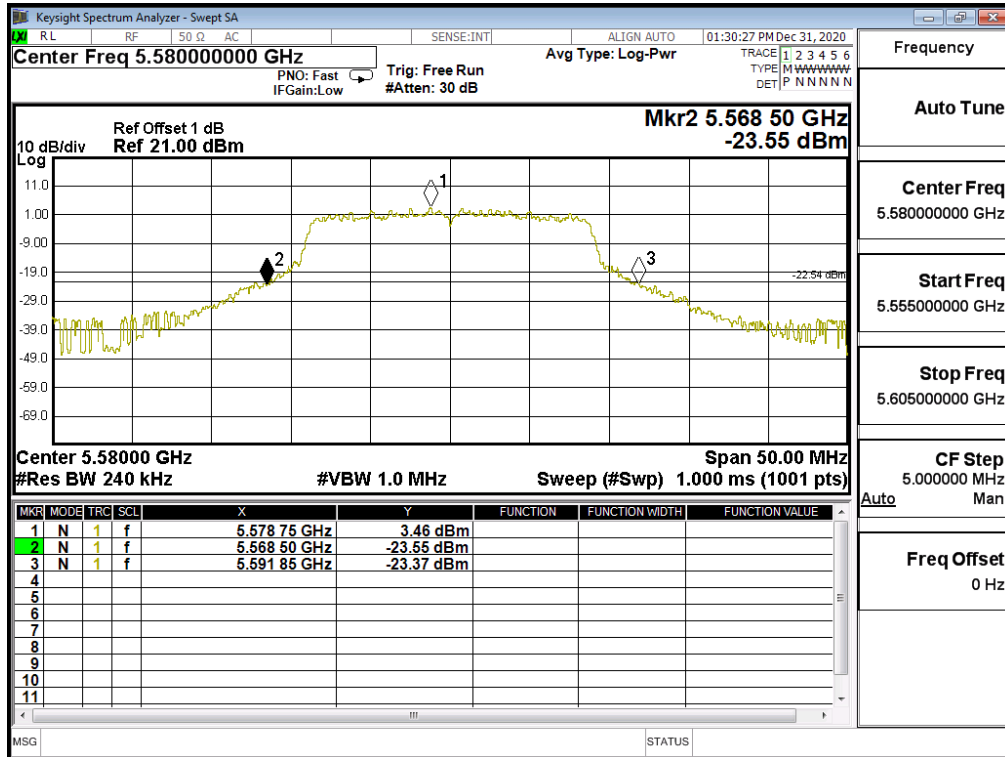

Channel 140

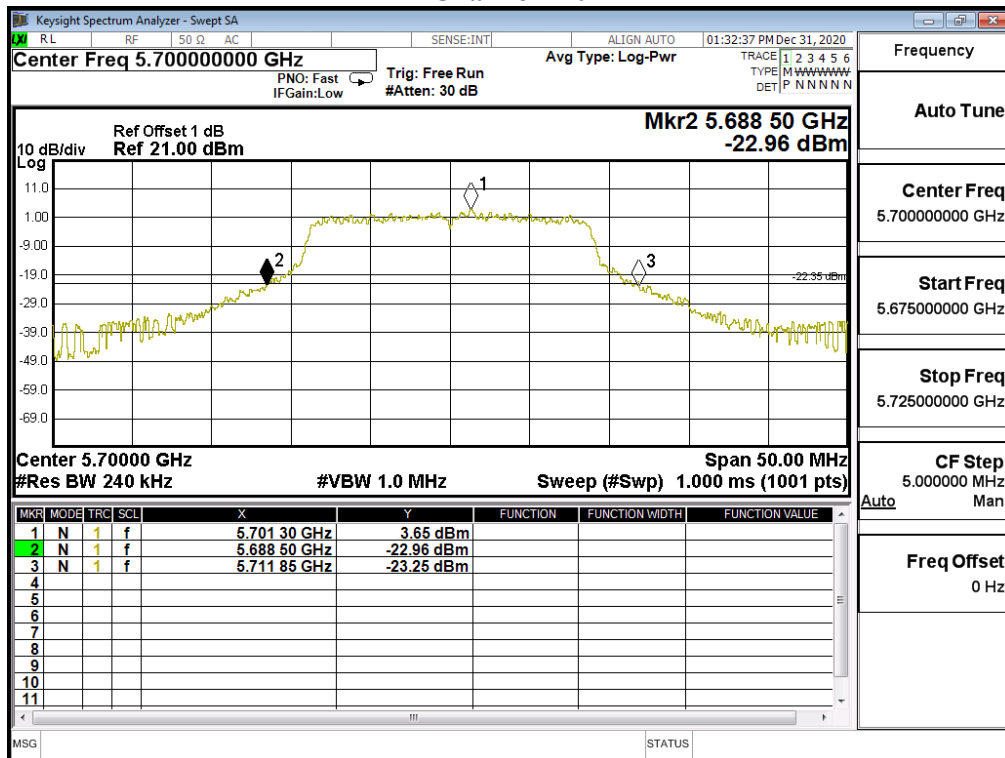

Channel 144

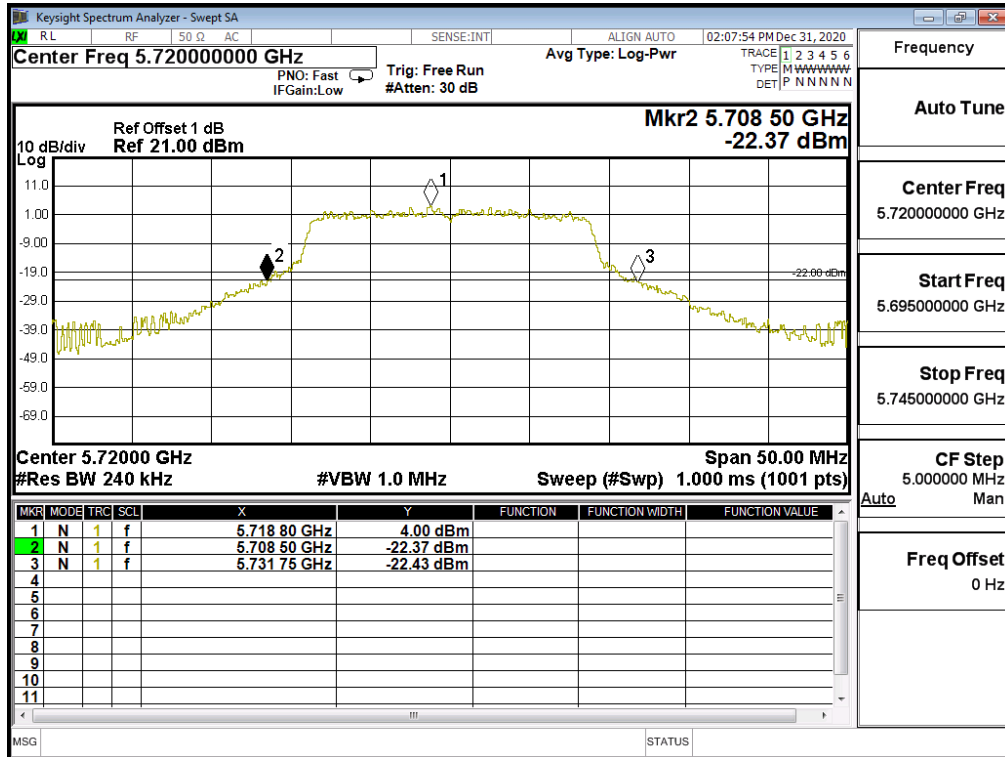

Maximum conducted output power:

Channel 144(U-NII-2C)

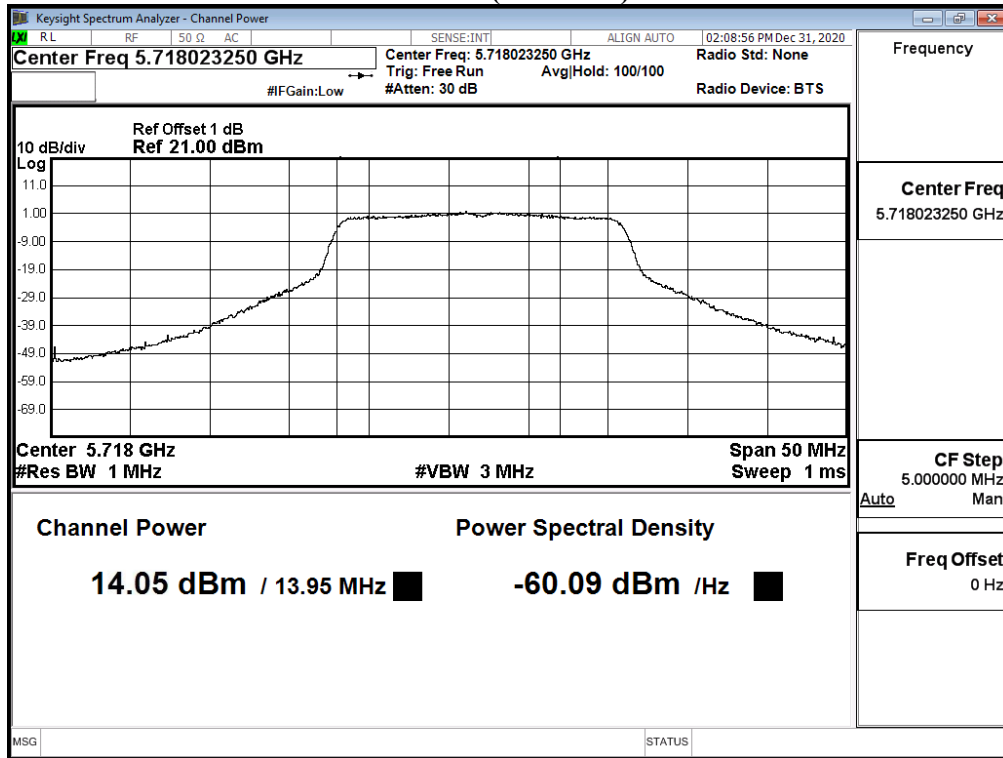

Channel 144(U-NII-3)

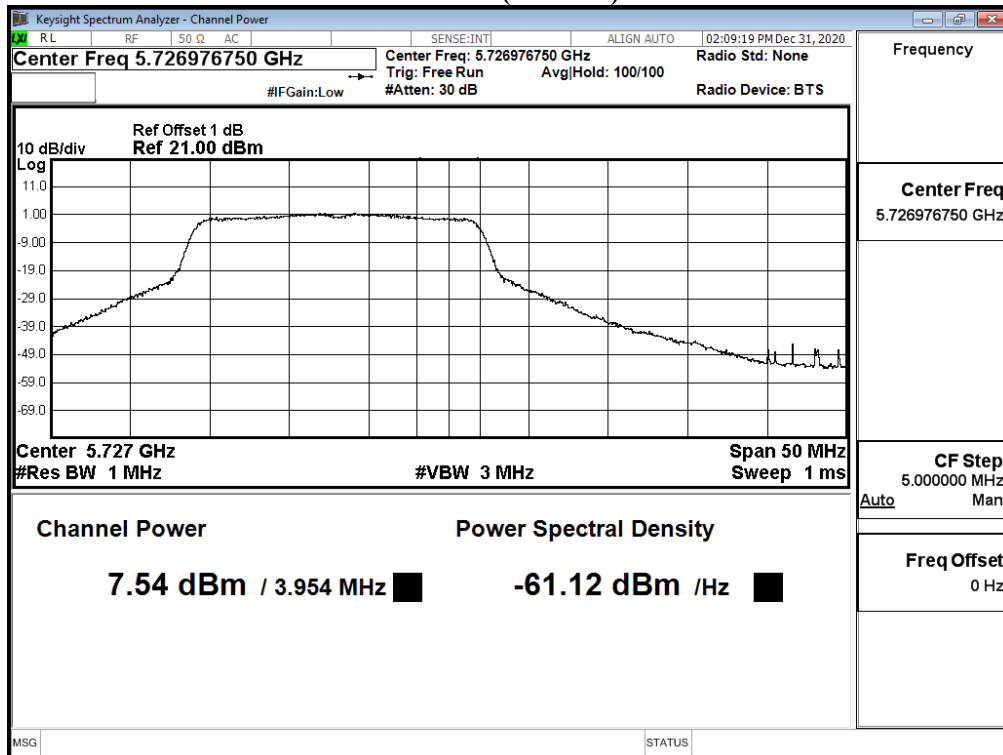

Product : PanaCast 50
 Test Item : Maximum conducted output power
 Test Mode : Mode 3: Transmit (802.11n-40BW 15Mbps)
 Test Date : 2020/12/31

| Cable loss=1dB | | Maximum conducted output power | | | | | | | |
|----------------|-----------------|--------------------------------|-------|-------|-------|-------|-------|-------|-------|
| Channel No. | Frequency (MHz) | Data Rate (Mbps) | | | | | | | |
| | | 15 | 30 | 45 | 60 | 90 | 120 | 135 | 150 |
| | | Measurement Level (dBm) | | | | | | | |
| 38 | 5190 | 12.82 | -- | -- | -- | -- | -- | -- | -- |
| 46 | 5230 | 14.46 | 14.4 | 14.34 | 14.3 | 14.24 | 14.18 | 14.11 | 14.04 |
| 54 | 5270 | 14.07 | -- | -- | -- | -- | -- | -- | -- |
| 62 | 5310 | 14.2 | 14.14 | 14.11 | 14.08 | 14 | 13.94 | 13.84 | 13.77 |
| 102 | 5510 | 14.23 | -- | -- | -- | -- | -- | -- | -- |
| 110 | 5550 | 14.02 | 13.94 | 13.87 | 13.77 | 13.73 | 13.66 | 13.56 | 13.52 |
| 134 | 5670 | 14.34 | -- | -- | -- | -- | -- | -- | -- |
| 142(U-NII-2C) | 5710 | 13.82 | 13.74 | 13.71 | 13.64 | 13.61 | 13.58 | 13.5 | 13.43 |
| 142(U-NII-3) | 5710 | 2.98 | 2.94 | 2.91 | 2.82 | 2.79 | 2.72 | 2.66 | 2.57 |
| 151 | 5755 | 14.22 | -- | -- | -- | -- | -- | -- | -- |
| 159 | 5795 | 14.36 | 14.26 | 14.18 | 14.15 | 14.09 | 14 | 13.96 | 13.91 |

Note: Maximum conducted output power Value =Reading value on average power meter + cable loss

Maximum conducted output power Measurement:

| Channel No | Frequency Range (MHz) | 26dB Bandwidth (MHz) | Output Power (dBm) | Output Power Limit | |
|---------------|--------------------------|-------------------------|-----------------------|--------------------|---------------|
| | | | | (dBm) | dBm+10log(BW) |
| 38 | 5190 | -- | 12.82 | 24 | -- |
| 46 | 5230 | -- | 14.46 | 24 | -- |
| 54 | 5270 | 41.600 | 14.07 | 24 | 27.19 |
| 62 | 5310 | 41.400 | 14.2 | 24 | 27.17 |
| 102 | 5510 | 42.000 | 14.23 | 24 | 27.23 |
| 110 | 5550 | 41.700 | 14.02 | 24 | 27.20 |
| 134 | 5670 | 41.400 | 14.34 | 24 | 27.17 |
| 142(U-NII-2C) | 5710 | 35.500 | 13.82 | 24 | 26.50 |
| 142(U-NII-3) | 5710 | -- | 2.98 | 30 | -- |
| 151 | 5755 | -- | 14.22 | 30 | -- |
| 159 | 5795 | -- | 14.36 | 30 | -- |

26dB Occupied Bandwidth:

Channel 54

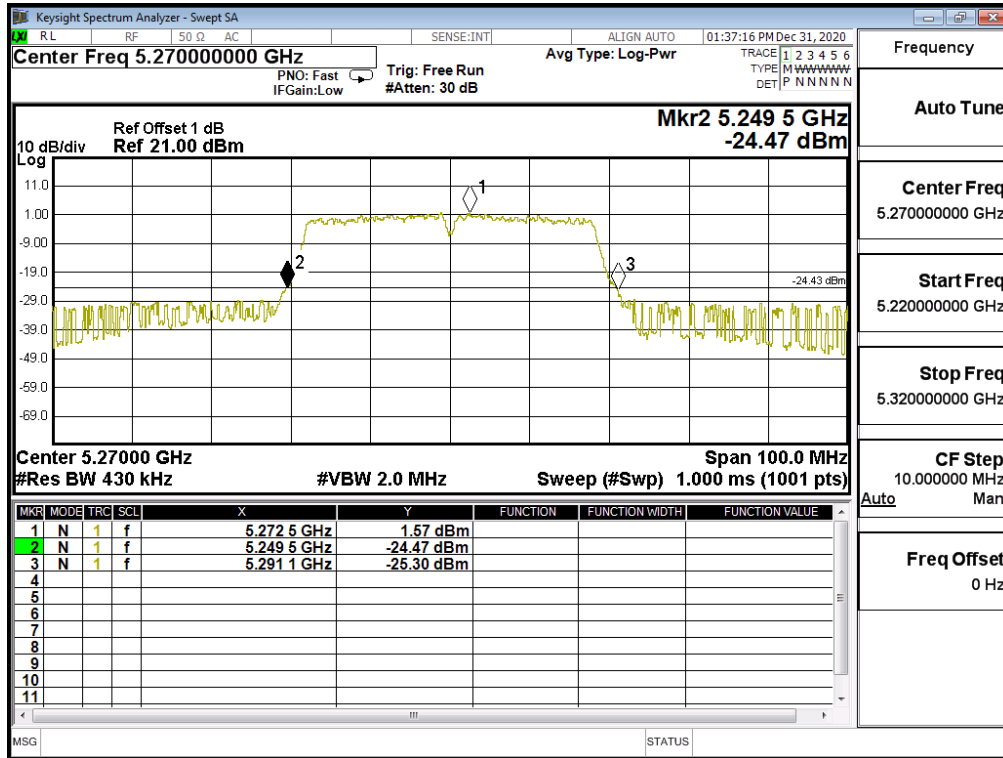

Channel 62

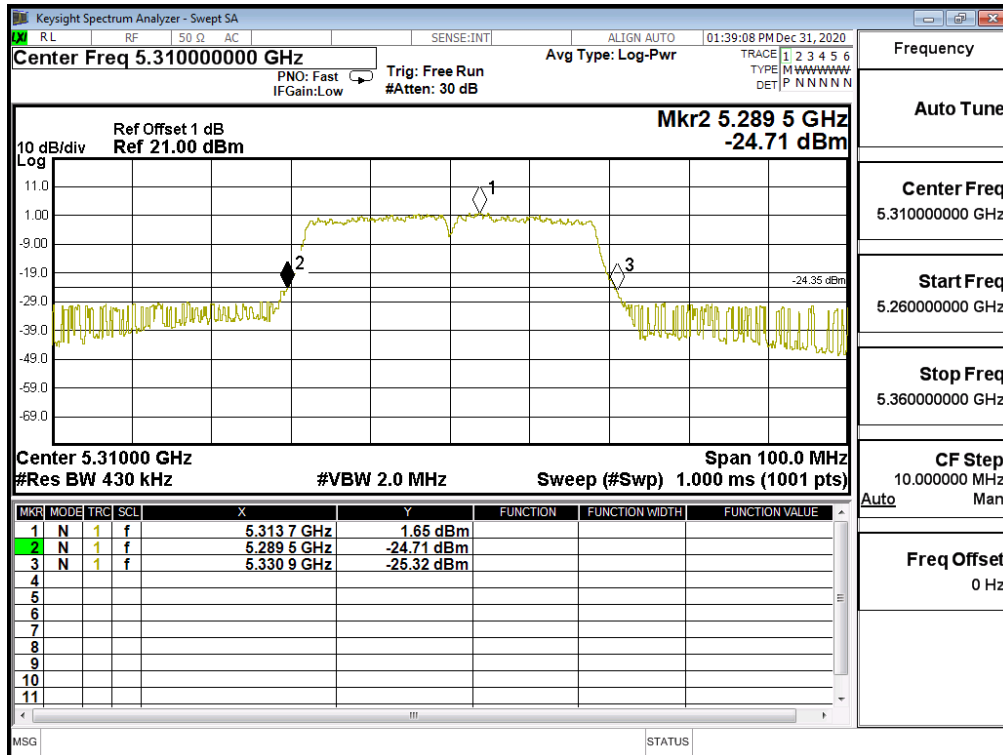

Channel 102

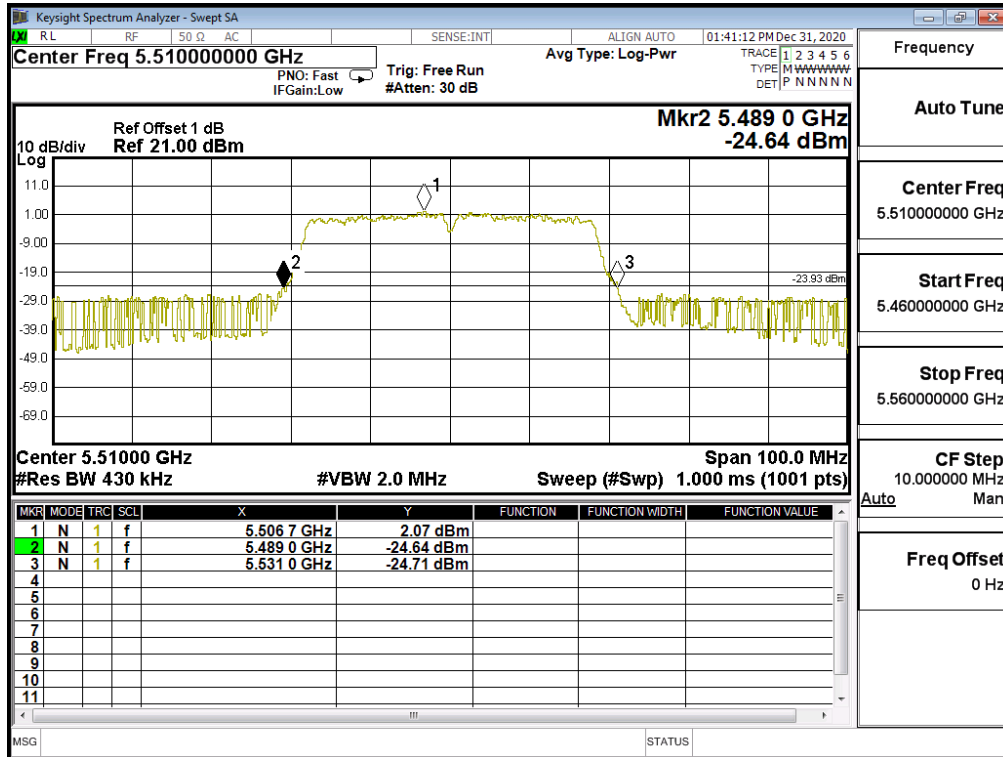

Channel 110

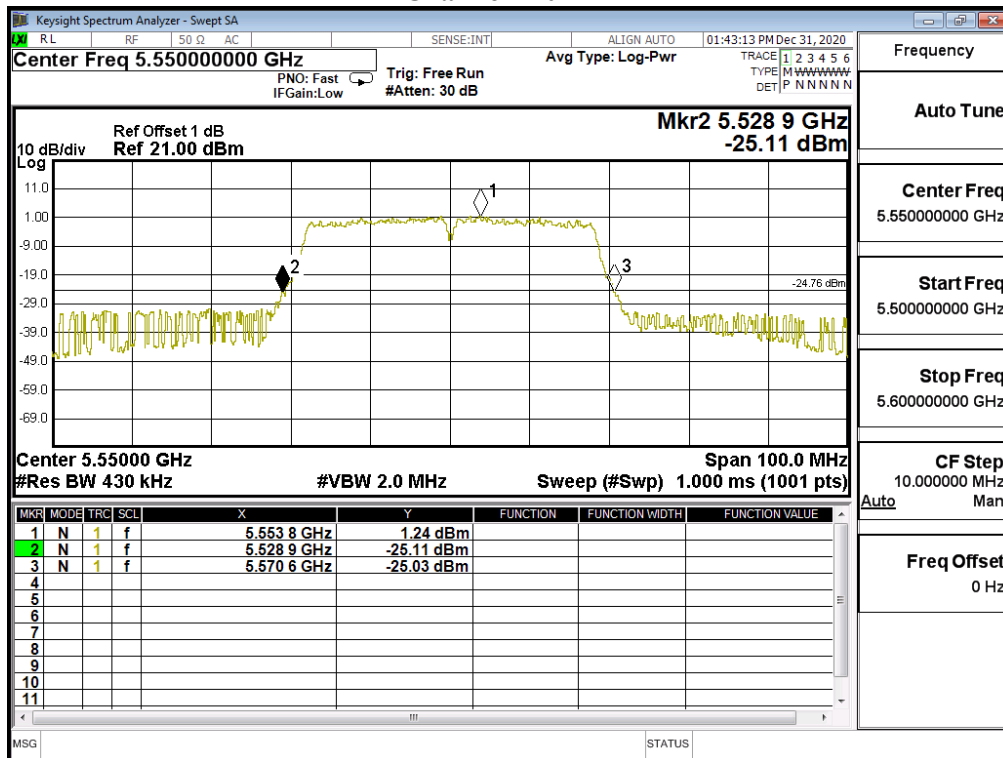

Channel 134

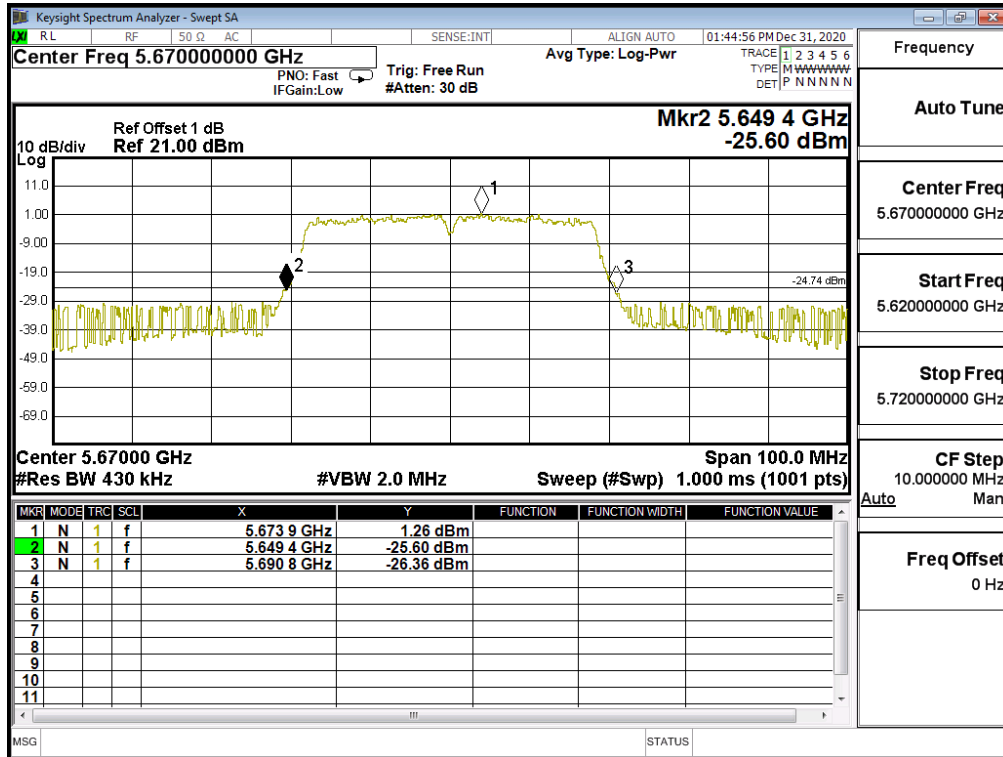

Channel 142

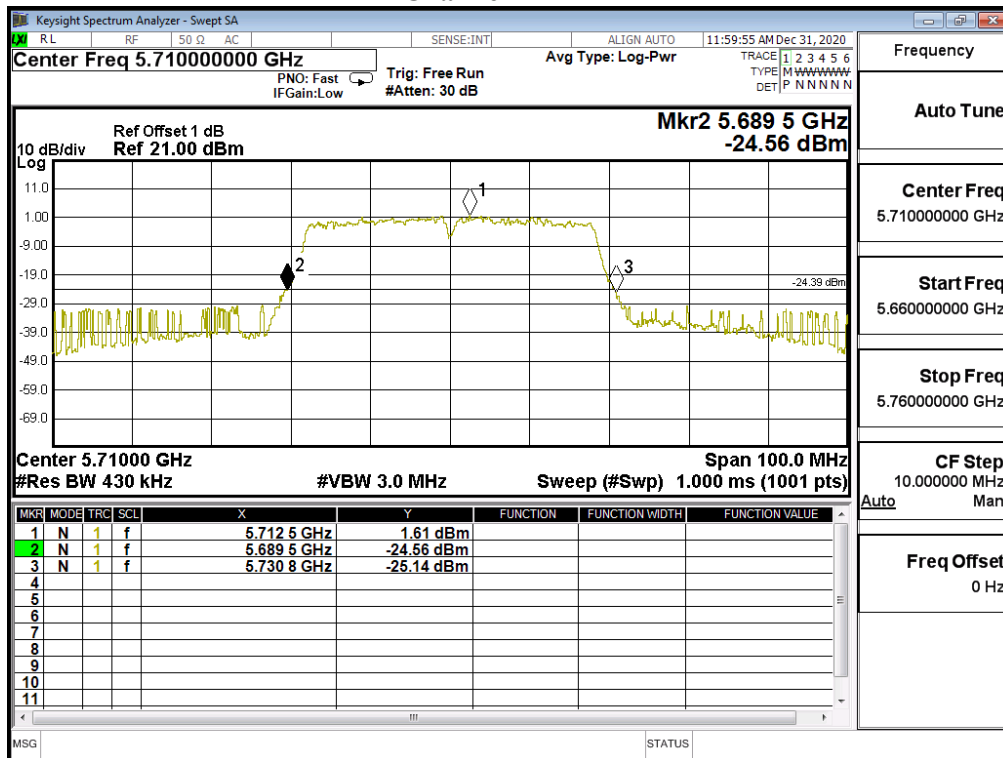

Maximum conducted output power:

Channel 142(U-NII-2C)

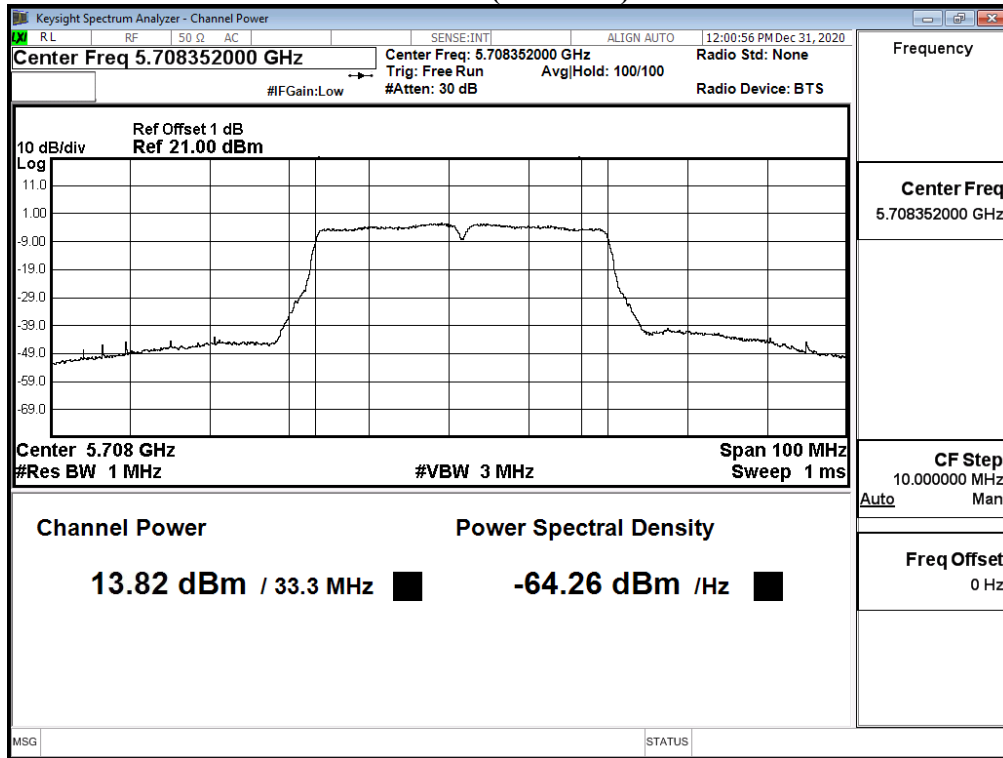

Channel 142(U-NII-3)

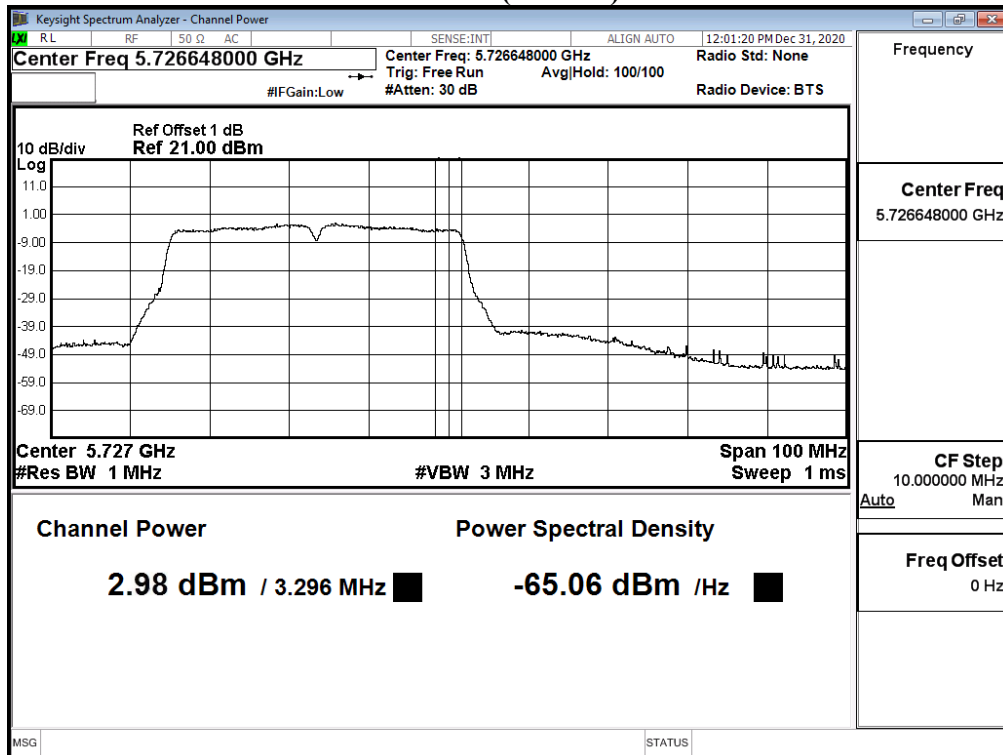

Product : PanaCast 50
 Test Item : Maximum conducted output power
 Test Mode : Mode 4: Transmit (802.11ac-80BW 32.5Mbps)
 Test Date : 2020/12/31

| Cable loss=1dB | | Maximum conducted output power | | | | | | | | | |
|----------------|-----------------|--------------------------------|-------|-------|-------|-------|-------|-------|-------|-------|-------|
| Channel No | Frequency (MHz) | Data Rate (Mbps) | | | | | | | | | |
| | | VTH0 | VTH1 | VTH2 | VTH3 | VTH4 | VTH5 | VTH6 | VTH7 | VTH8 | VTH9 |
| 42 | 5210 | 11.54 | 11.50 | 11.46 | 11.40 | 11.35 | 11.29 | 11.25 | 11.20 | 11.16 | 11.12 |
| 58 | 5290 | 11.92 | 11.86 | 11.83 | 11.80 | 11.73 | 11.66 | 11.61 | 11.55 | 11.52 | 11.49 |
| 106 | 5530 | 10.22 | -- | -- | -- | -- | -- | -- | -- | -- | -- |
| 122 | 5610 | 13.64 | 13.55 | 13.51 | 13.48 | 13.4 | 13.35 | 13.26 | 13.2 | 13.17 | 13.12 |
| 138(U-NII-2C) | 5690 | 13.82 | -- | -- | -- | -- | -- | -- | -- | -- | -- |
| 138(U-NII-3) | 5690 | -0.36 | -- | -- | -- | -- | -- | -- | -- | -- | -- |
| 155 | 5775 | 13.86 | 13.81 | 13.78 | 13.72 | 13.63 | 13.59 | 13.5 | 13.44 | 13.34 | 13.28 |

Note: Maximum conducted output power Value =Reading value on Spectrum Analyzer + cable loss

Maximum conducted output power Measurement

| Channel No | Frequency Range | 26dB Bandwidth | Output Power | Output Power Limit | | Result |
|---------------|-----------------|----------------|--------------|--------------------|---------------|--------|
| | (MHz) | (MHz) | (dBm) | (dBm) | dBm+10log(BW) | |
| 42 | 5210 | -- | 11.54 | 24 | -- | Pass |
| 58 | 5290 | 103.600 | 11.92 | 24 | 31.15 | Pass |
| 106 | 5530 | 83.800 | 10.22 | 24 | 30.23 | Pass |
| 122 | 5610 | 84.000 | 13.64 | 24 | 30.24 | Pass |
| 138(U-NII-2C) | 5690 | 77.200 | 13.82 | 24 | 29.88 | Pass |
| 138(U-NII-3) | 5690 | -- | -0.36 | 30 | -- | Pass |
| 155 | 5775 | -- | 13.86 | 30 | -- | Pass |

26dB Occupied Bandwidth: Channel 58

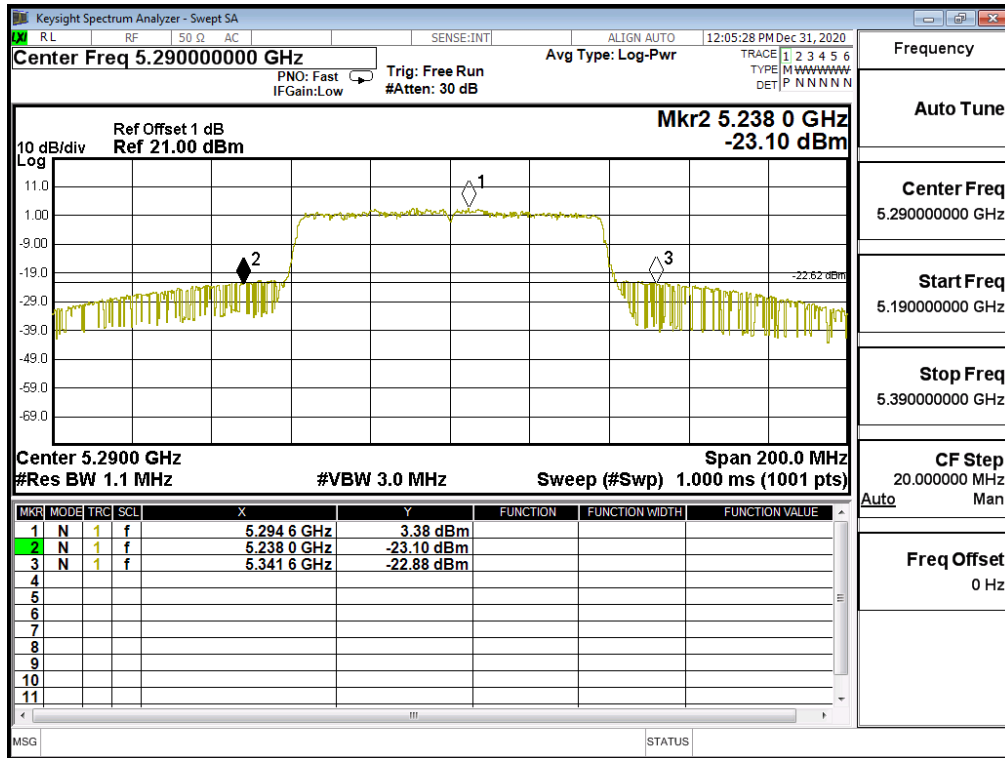

Channel 106

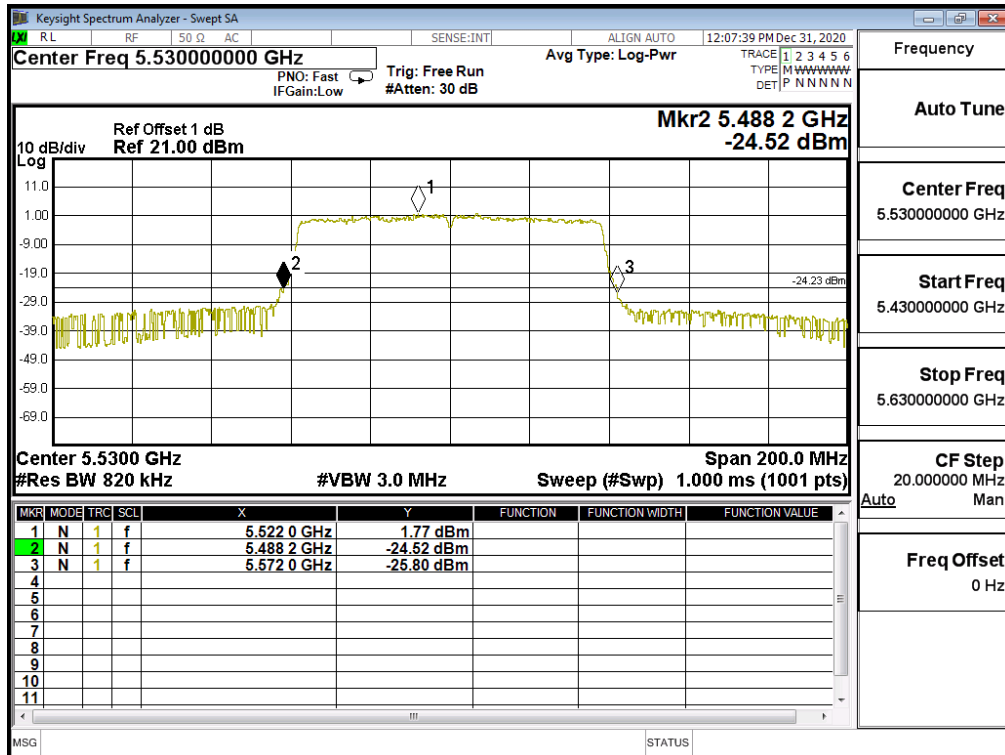

Channel 122

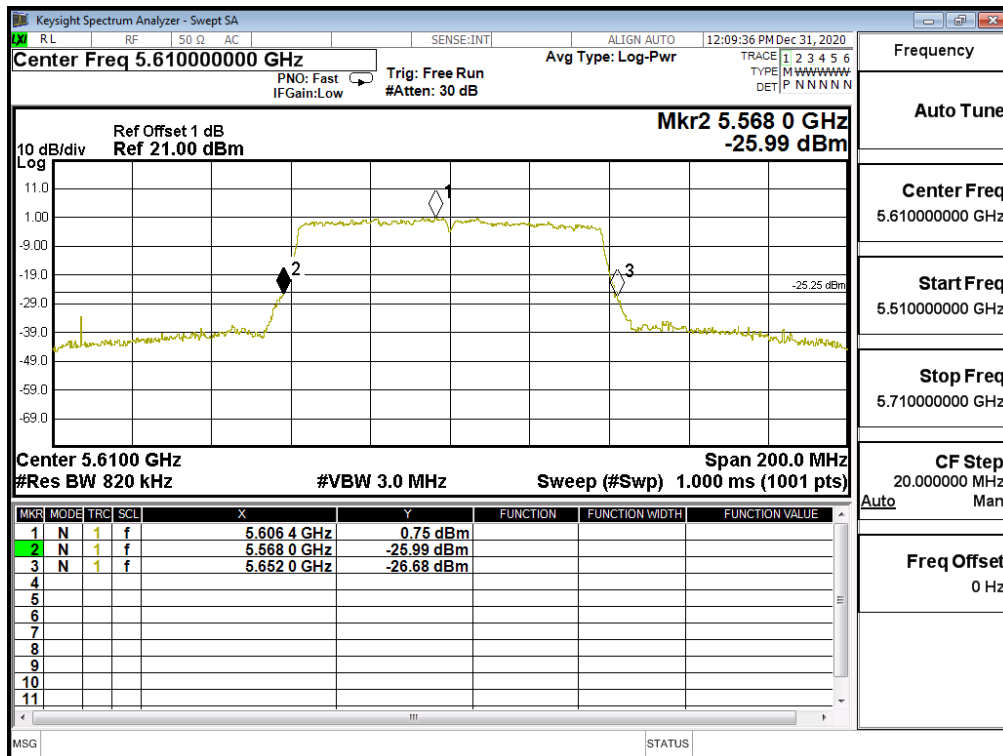

Channel 138(U-NII-2C)

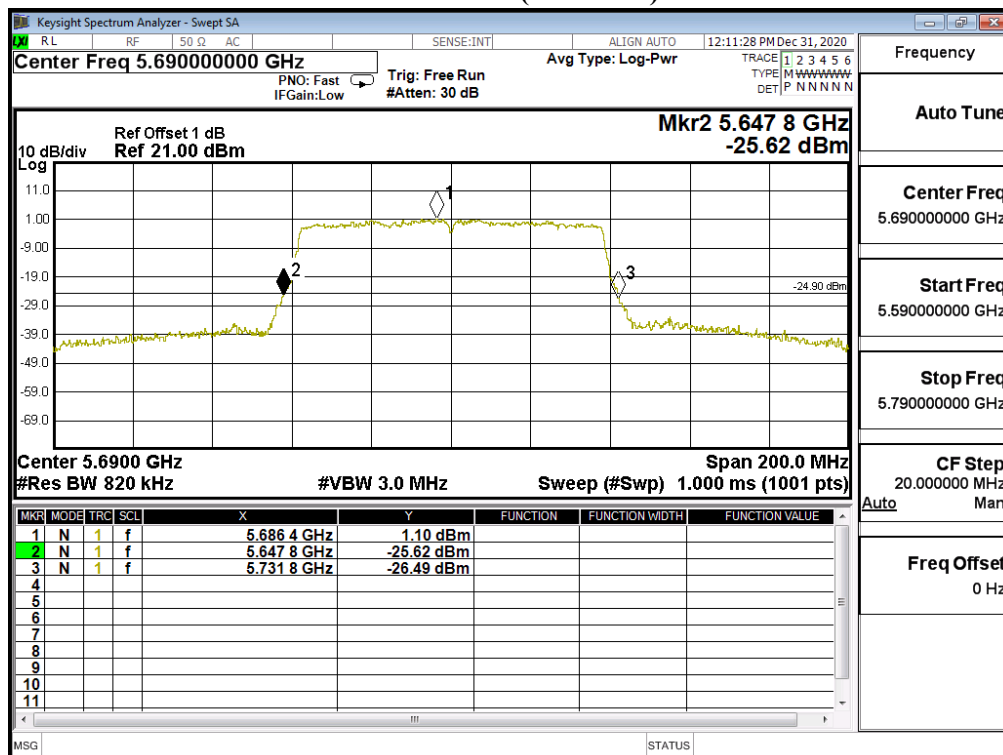

Maximum conducted output power:

Channel 138 (U-NII-2C)

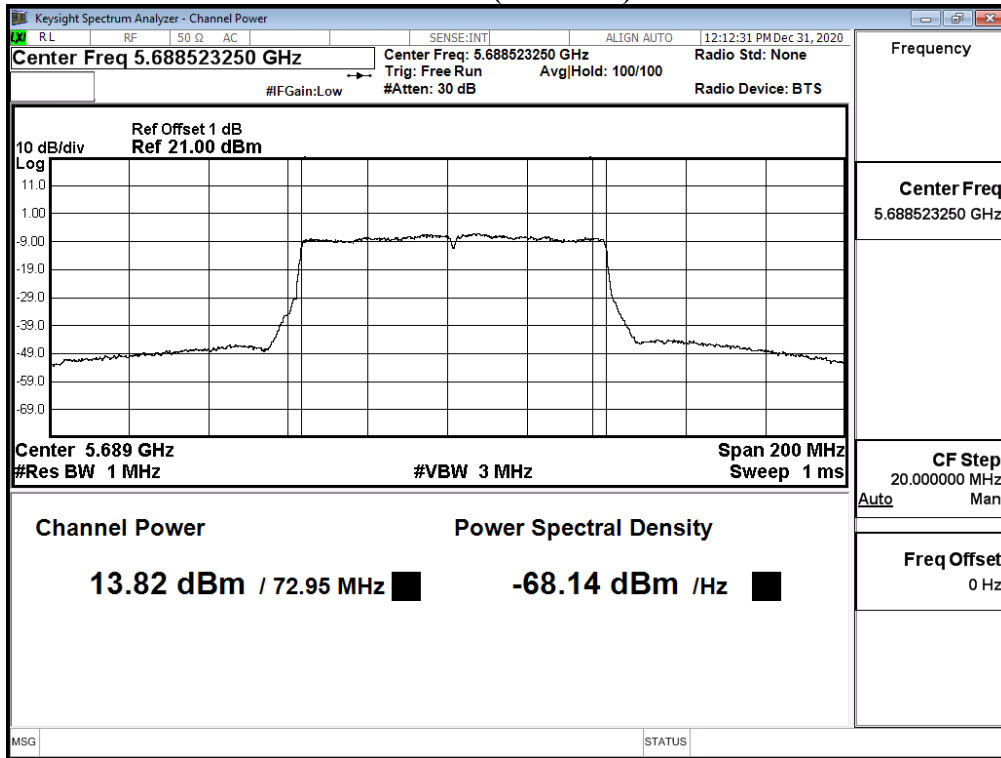

Channel 138 (U-NII-3)

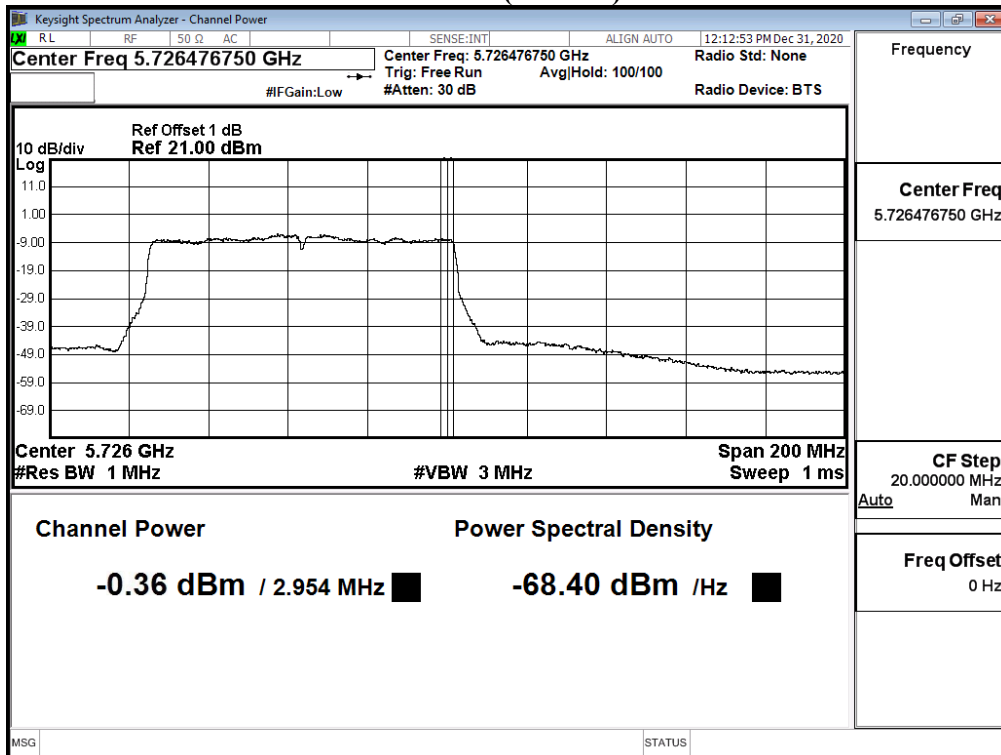

4. Peak Power Spectral Density

4.1. Test Setup

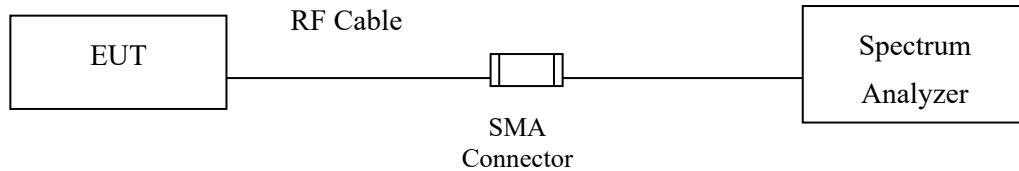

4.2. Limits

For the band 5.15-5.25 GHz,

(i) For an outdoor access point operating in the band 5.15-5.25 GHz, the maximum power spectral density shall not exceed 17 dBm in any 1 megahertz band. If transmitting antennas of directional gain greater than 6 dBi are used, the maximum power spectral density shall be reduced by the amount in dB that the directional gain of the antenna exceeds 6 dBi.

(ii) For an indoor access point operating in the band 5.15-5.25 GHz, the maximum power spectral density shall not exceed 17 dBm in any 1 megahertz band. If transmitting antennas of directional gain greater than 6 dBi are used, the maximum power spectral density shall be reduced by the amount in dB that the directional gain of the antenna exceeds 6 dBi.

(iii) For fixed point-to-point access points operating in the band 5.15-5.25 GHz, the maximum conducted output power over the frequency band of operation shall not exceed 1 W. Fixed point-to-point U-NII devices may employ antennas with directional gain up to 23 dBi without any corresponding reduction in the maximum conducted output power or maximum power spectral density. For fixed point-to-point transmitters that employ a directional antenna gain greater than 23 dBi, a 1 dB reduction in maximum conducted output power and maximum power spectral density is required for each 1 dB of antenna gain in excess of 23 dBi. Fixed, point-to-point operations exclude the use of point-to-multipoint systems, omnidirectional applications, and multiple collocated transmitters transmitting the same information. The operator of the U-NII device, or if the equipment is professionally installed, the installer, is responsible for ensuring that systems employing high gain directional antennas are used exclusively for fixed, point-to-point operations.

(iv) For mobile and portable client devices in the 5.15-5.25 GHz band, the maximum power spectral density shall not exceed 11 dBm in any 1 megahertz band. If transmitting antennas of directional gain greater than 6 dBi are used, the maximum power spectral density shall be reduced by the amount in dB that the directional gain of the antenna exceeds 6 dBi.

For the 5.25-5.35 GHz and 5.47-5.725 GHz bands, the maximum power spectral density shall not exceed 11 dBm in any 1 megahertz band. If transmitting antennas of directional gain greater than 6 dBi are used, the maximum power spectral density shall be reduced by the amount in dB that the directional gain of the antenna exceeds 6 dBi.

For the band 5.725-5.85 GHz, the maximum power spectral density shall not exceed 30 dBm in any 500-kHz band. If transmitting antennas of directional gain greater than 6 dBi are used, the maximum power spectral density shall be reduced by the amount in dB that the directional gain of the antenna exceeds 6 dBi. However, fixed point-to-point UNII devices operating in this band may employ transmitting antennas with directional gain greater than 6 dBi without any corresponding reduction in transmitter conducted power. Fixed, point-to-point operations exclude the use of point-to-multipoint systems, omnidirectional applications, and multiple collocated transmitters transmitting the same information. The operator of the U-NII device, or if the equipment is professionally installed, the installer, is responsible for ensuring that systems employing high gain directional antennas are used exclusively for fixed, point-to-point operations.

4.3. Test Procedure

The EUT was setup to ANSI C63.10, 2013; tested to UNII test procedure of FCC KDB-789033 for compliance to FCC 47CFR Subpart E requirements.

The Peak Power Spectral Density using KDB 789033 section F) procedure, Create an average power spectrum for the EUT operating mode being tested by following the instructions in section E)2) for measuring maximum conducted output power using a spectrum analyzer.

SA-1 method is selected to run the test.

For the band 5.725-5.85 GHz, Scale the observed power level to an equivalent value in 500 kHz by adjusting (increase) the measured power by a bandwidth correction factor (BWCF) where $BWCF = 10\log(500\text{ kHz}/100\text{ kHz}) = 6.98\text{ dB}$.

4.4. Test Result of Peak Power Spectral Density

Product : PanaCast 50
 Test Item : Peak Power Spectral Density
 Test Mode : Mode 1: Transmit (802.11a 6Mbps)
 Test Date : 2020/12/31

| Channel Number | Frequency (MHz) | Data Rate (Mbps) | Measurement Level (dBm) | Required Limit (dBm) | Result |
|----------------|-----------------|------------------|-------------------------|----------------------|--------|
| 36 | 5180 | 6 | 0.640 | <11 | Pass |
| 44 | 5220 | 6 | 1.030 | <11 | Pass |
| 48 | 5240 | 6 | 0.450 | <11 | Pass |
| 52 | 5260 | 6 | 0.560 | <11 | Pass |
| 60 | 5300 | 6 | 0.540 | <11 | Pass |
| 64 | 5320 | 6 | 1.010 | <11 | Pass |
| 100 | 5500 | 6 | 1.880 | <11 | Pass |
| 116 | 5580 | 6 | 1.710 | <11 | Pass |
| 140 | 5700 | 6 | 1.390 | <11 | Pass |

| Channel Number | Frequency (MHz) | Data Rate (Mbps) | PPSD (dBm) | BWCF (dB) | Total PPSD (dBm) | Required Limit (dBm) | Result |
|----------------|-----------------|------------------|------------|-----------|------------------|----------------------|--------|
| 149 | 5745 | 6 | -6.800 | 6.980 | 0.180 | <30 | Pass |
| 157 | 5785 | 6 | -7.330 | 6.980 | -0.350 | <30 | Pass |
| 165 | 5825 | 6 | -7.330 | 6.980 | -0.350 | <30 | Pass |

Channel 36:

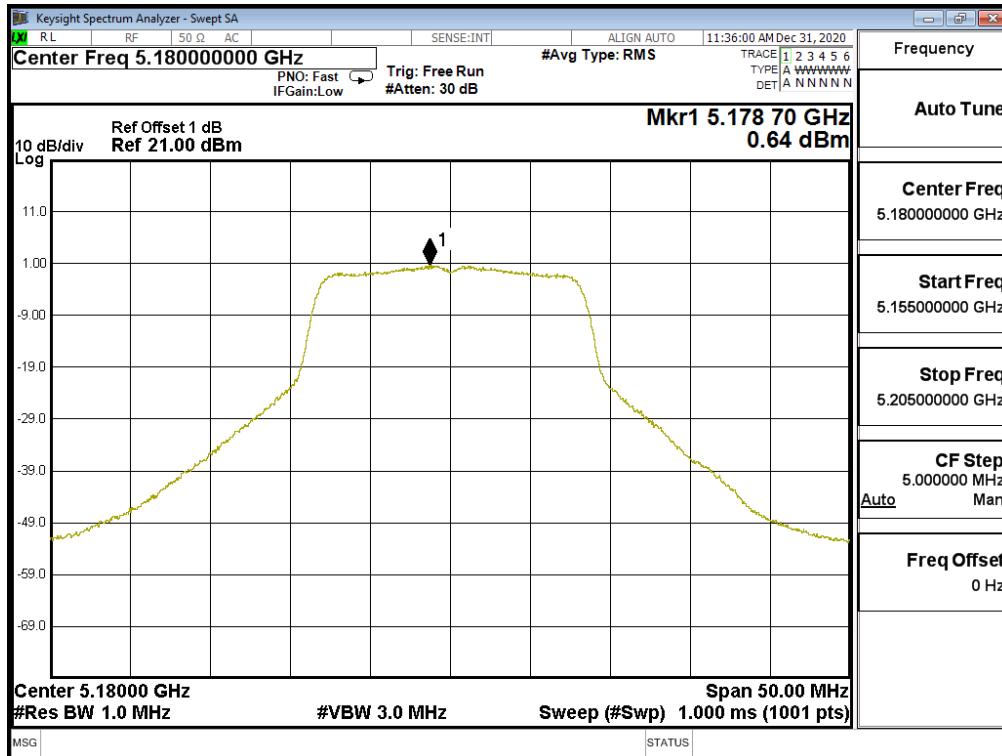

Channel 44:

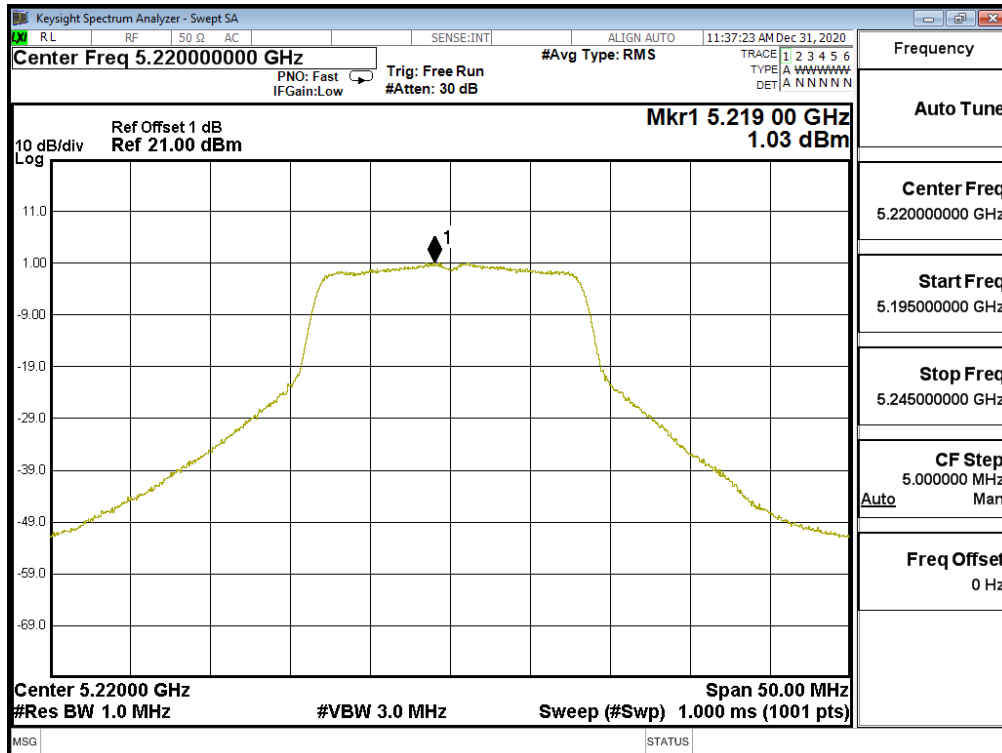

Channel 48:

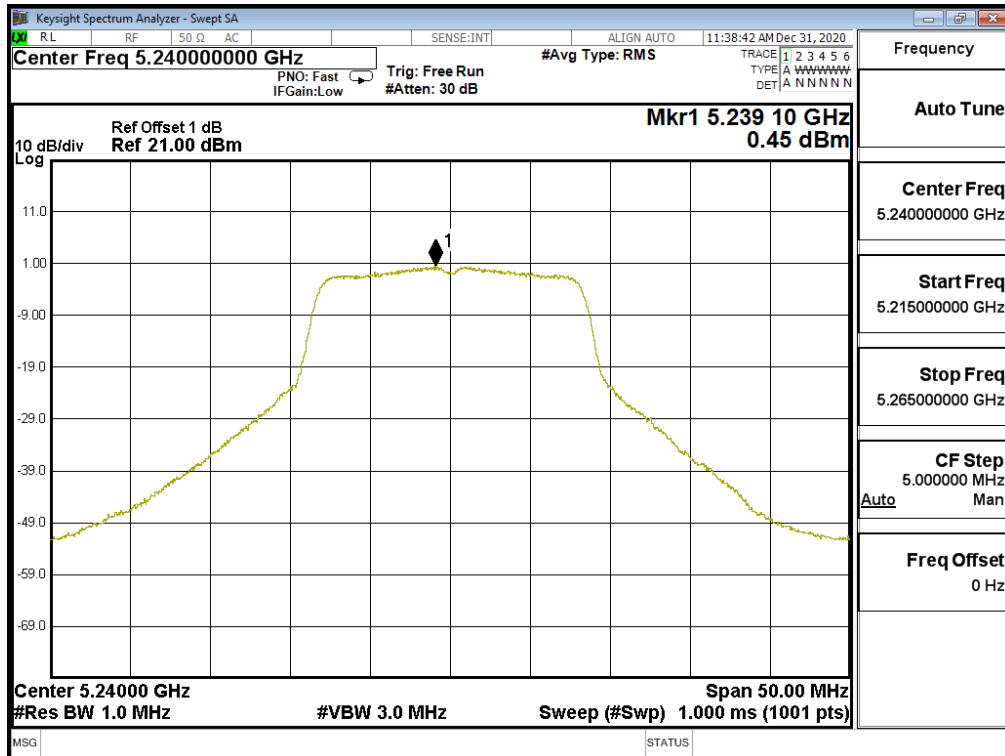

Channel 52:

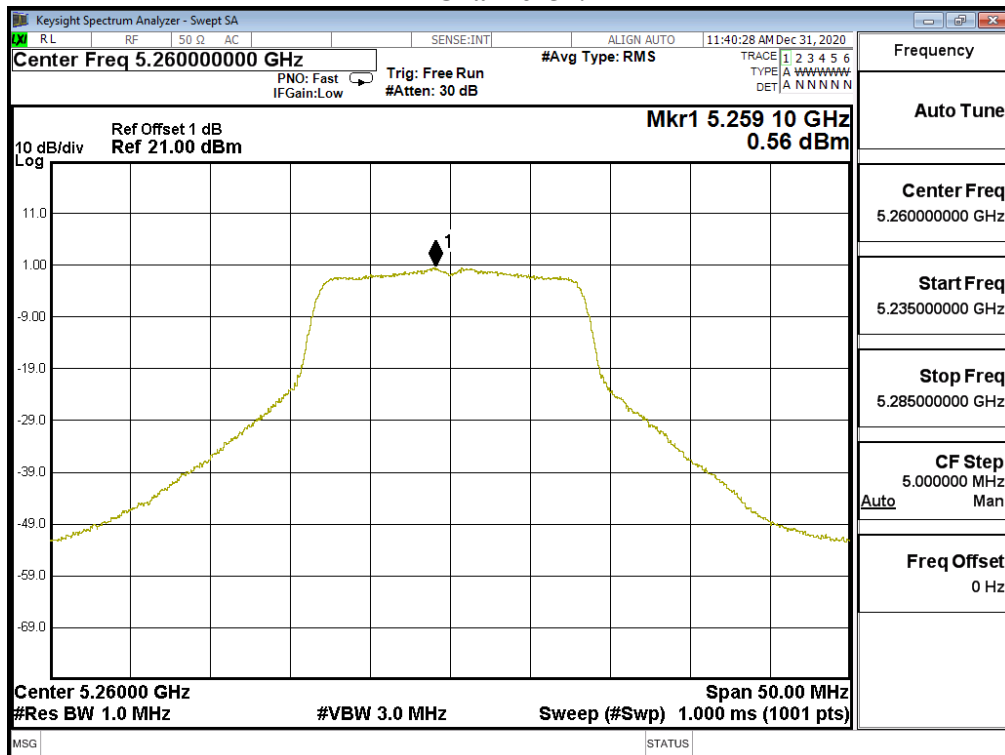

Channel 60:

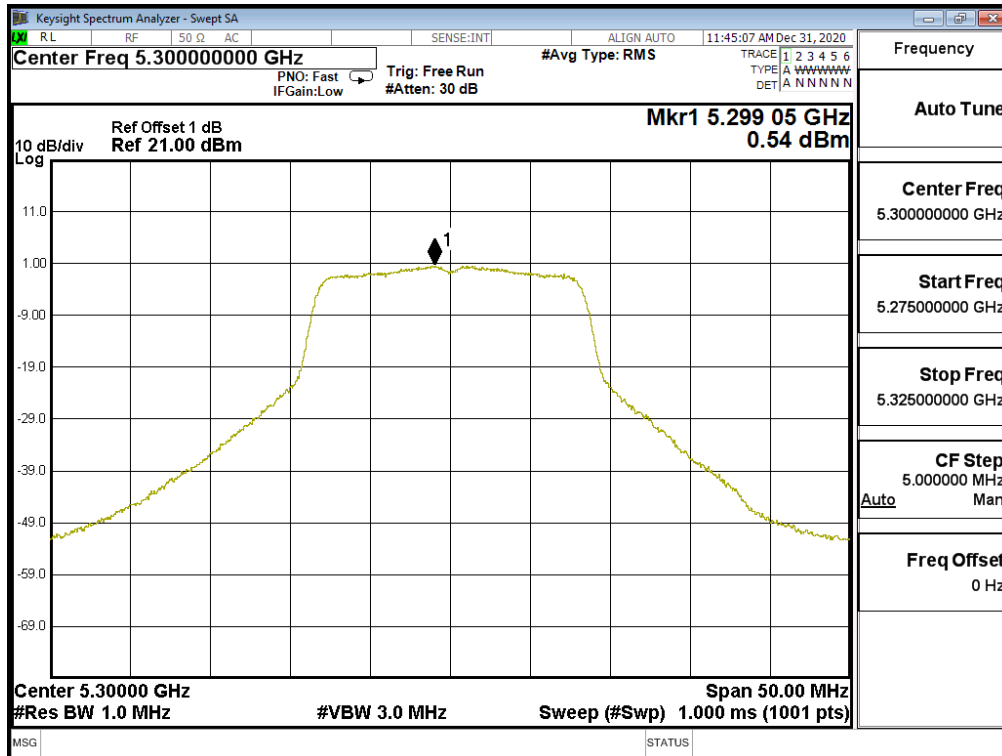

Channel 64:

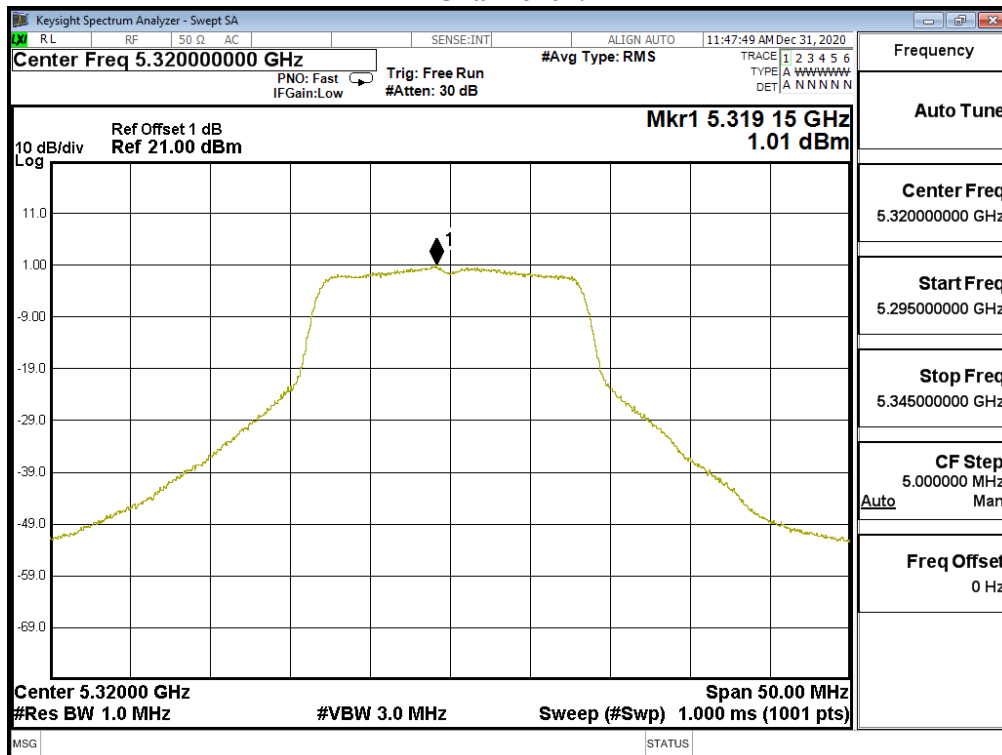

Channel 100:

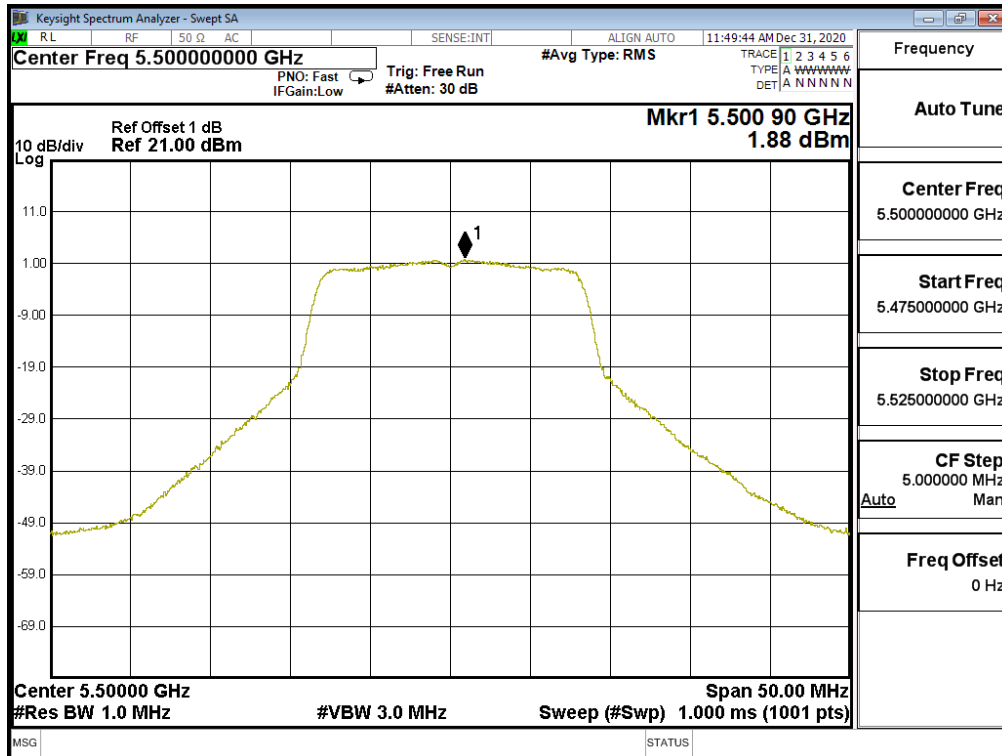

Channel 116:

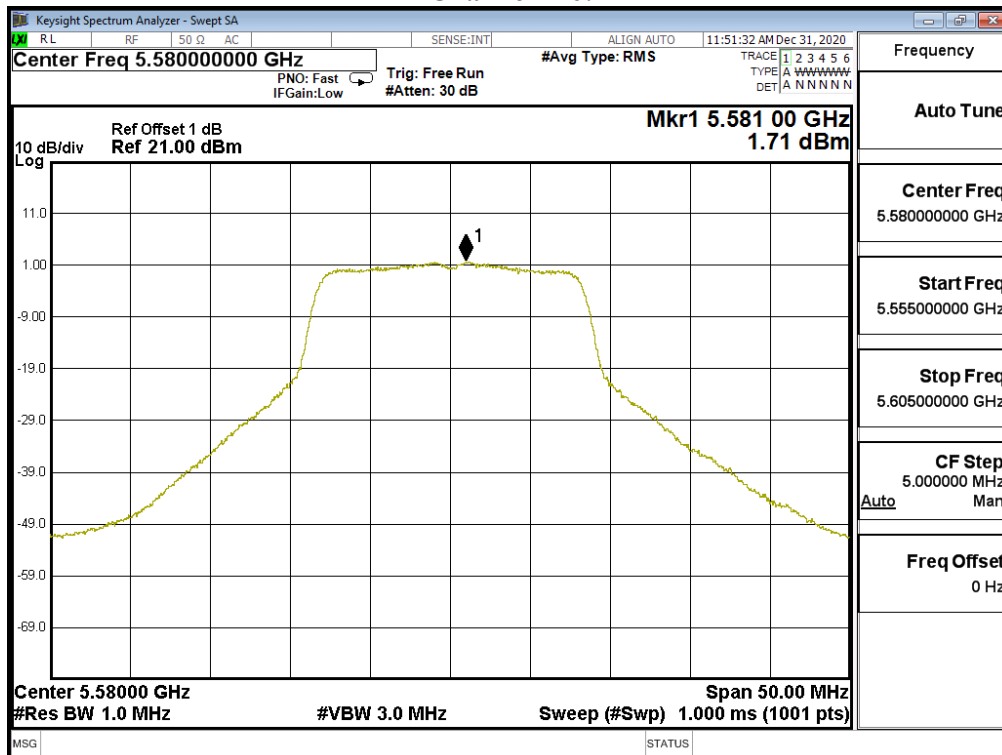

Channel 140:

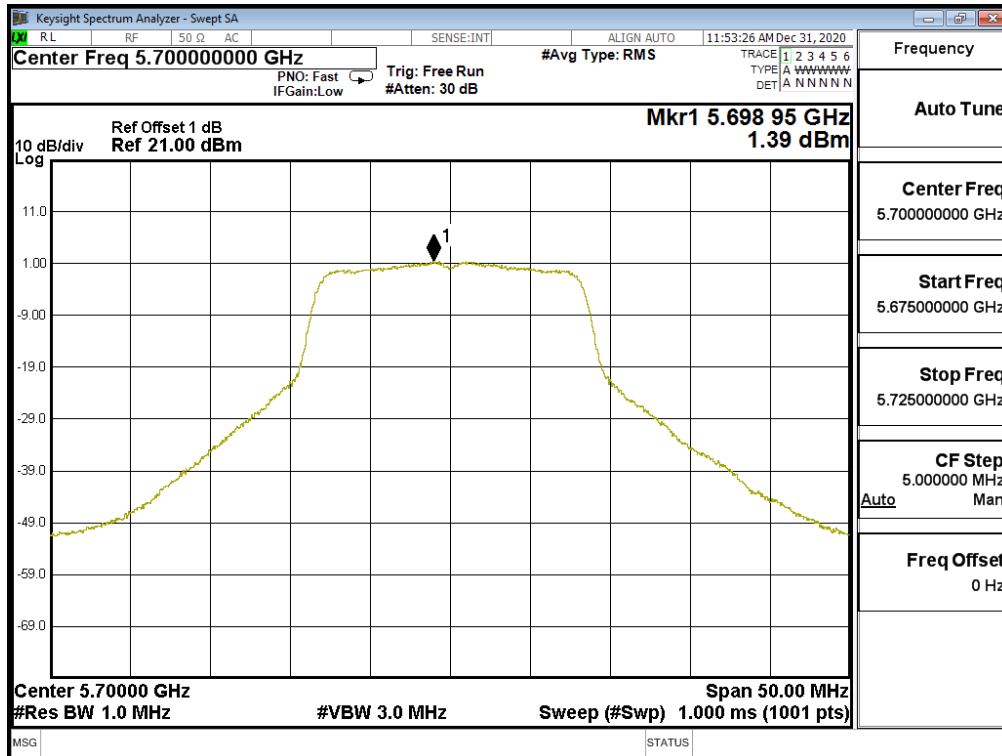

Channel 149

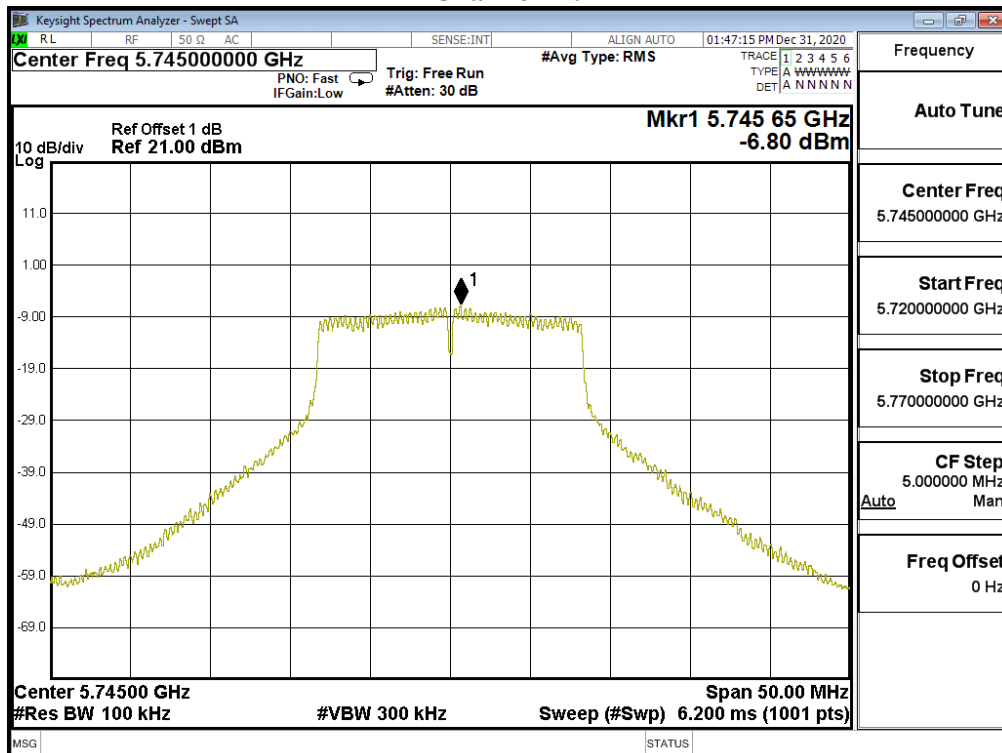

Channel 157

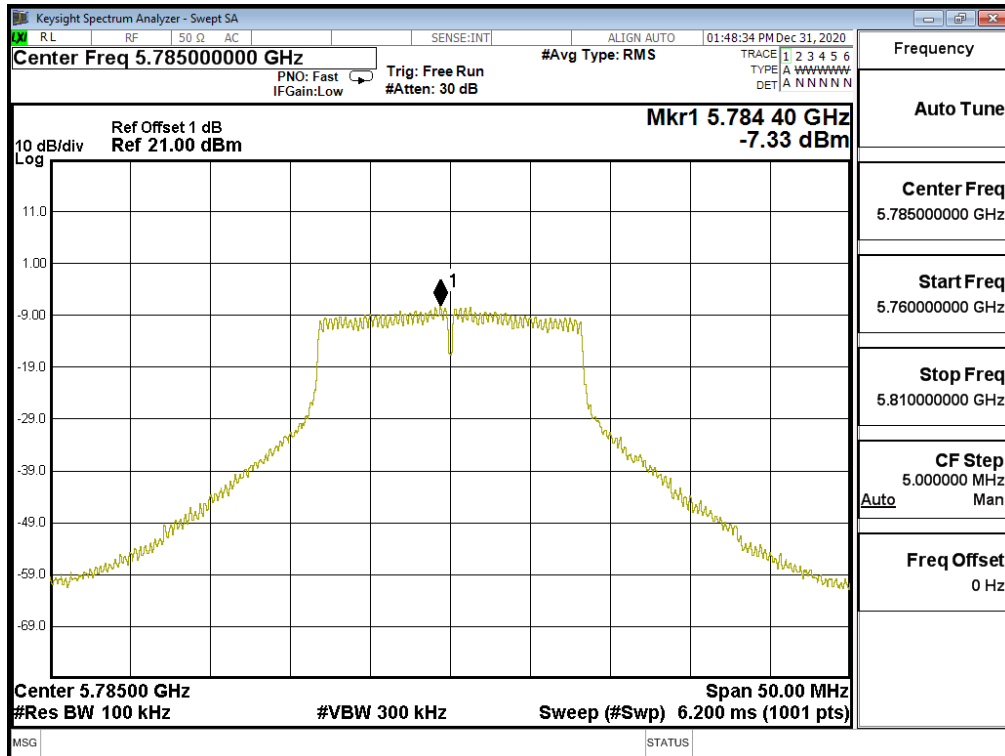

Channel 165

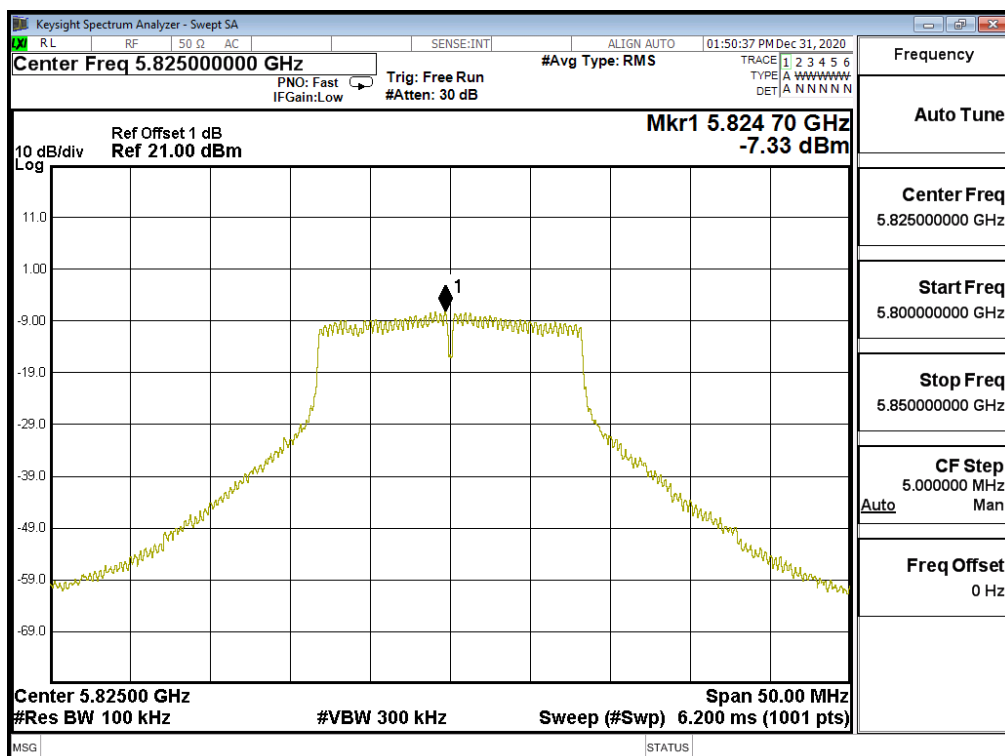

Product : PanaCast 50
 Test Item : Peak Power Spectral Density
 Test Mode : Mode 2: Transmit (802.11n-20BW 7.2Mbps)
 Test Date : 2020/12/31

| Channel Number | Frequency (MHz) | Data Rate (Mbps) | Measurement Level (dBm) | Required Limit (dBm) | Result |
|----------------|-----------------|------------------|-------------------------|----------------------|--------|
| 36 | 5180 | 6 | 0.890 | 11 | Pass |
| 44 | 5220 | 6 | 0.990 | 11 | Pass |
| 48 | 5240 | 6 | 1.420 | 11 | Pass |
| 52 | 5260 | 6 | 1.330 | 11 | Pass |
| 60 | 5300 | 6 | 1.600 | 11 | Pass |
| 64 | 5320 | 6 | 1.250 | 11 | Pass |
| 100 | 5500 | 6 | 1.890 | 11 | Pass |
| 116 | 5580 | 6 | 1.070 | 11 | Pass |
| 140 | 5700 | 6 | 0.980 | 11 | Pass |
| 144(U-NII-2C) | 5720 | 6 | 1.680 | 11 | Pass |

| Channel Number | Frequency (MHz) | Data Rate (Mbps) | PPSD (dBm) | BWCF (dB) | Total PPSD (dBm) | Required Limit (dBm) | Result |
|----------------|-----------------|------------------|------------|-----------|------------------|----------------------|--------|
| 144(U-NII-3) | 5720 | 6 | -8.740 | 6.980 | -1.760 | <30 | Pass |
| 149 | 5745 | 6 | -7.540 | 6.980 | -0.560 | <30 | Pass |
| 157 | 5785 | 6 | -7.600 | 6.980 | -0.620 | <30 | Pass |
| 165 | 5825 | 6 | -7.590 | 6.980 | -0.610 | <30 | Pass |

Channel 36:

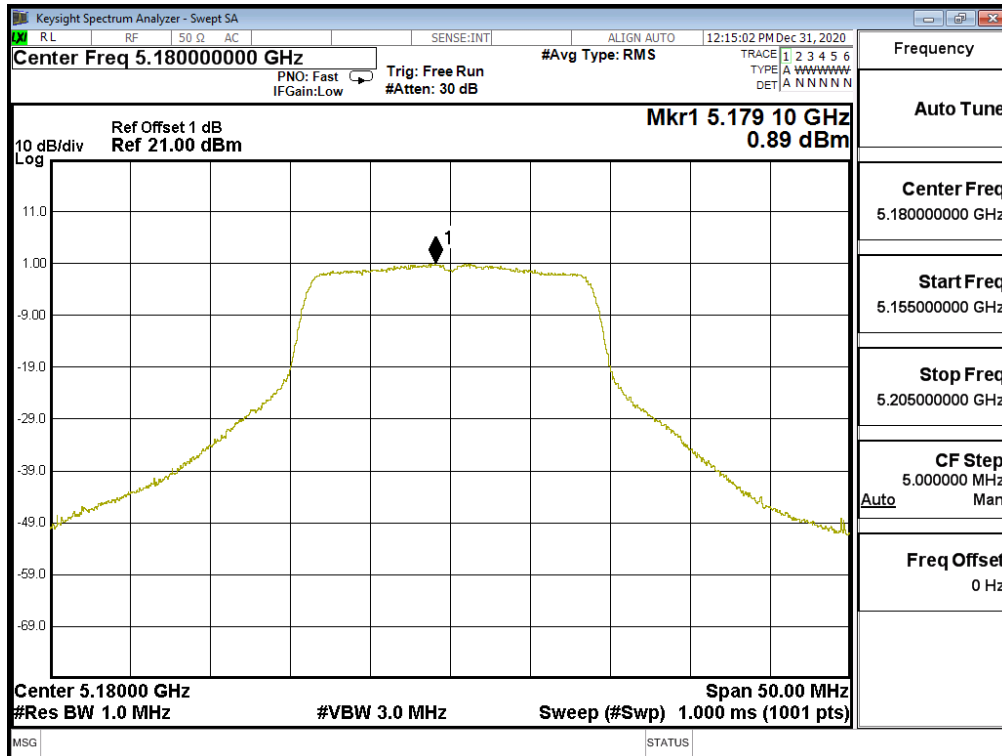

Channel 44:

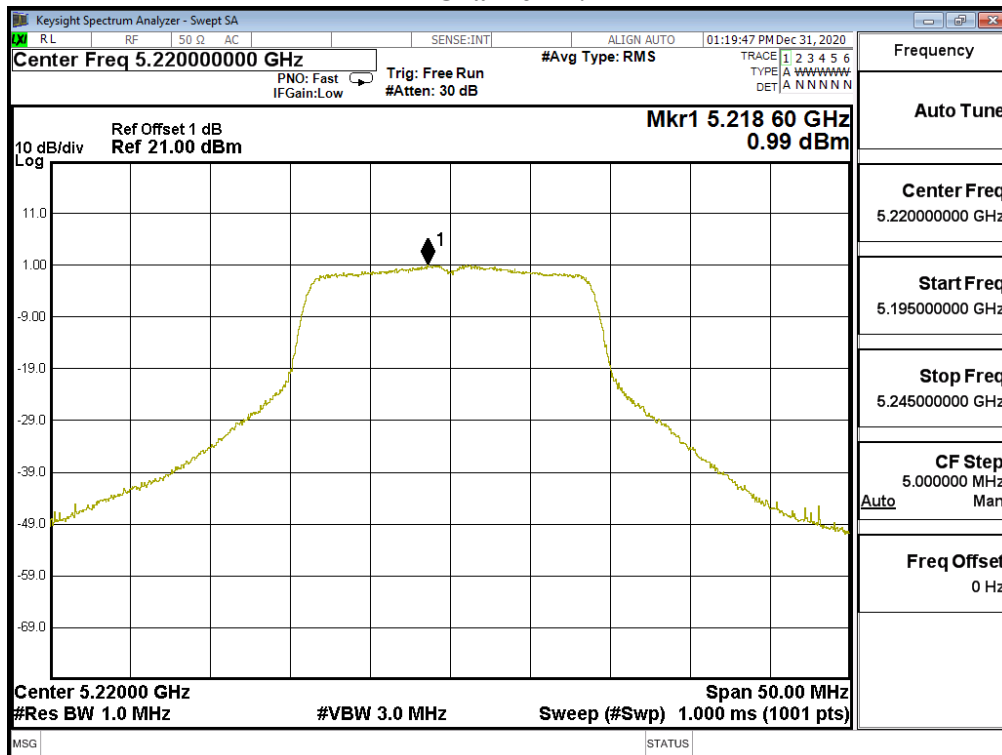

Channel 48:

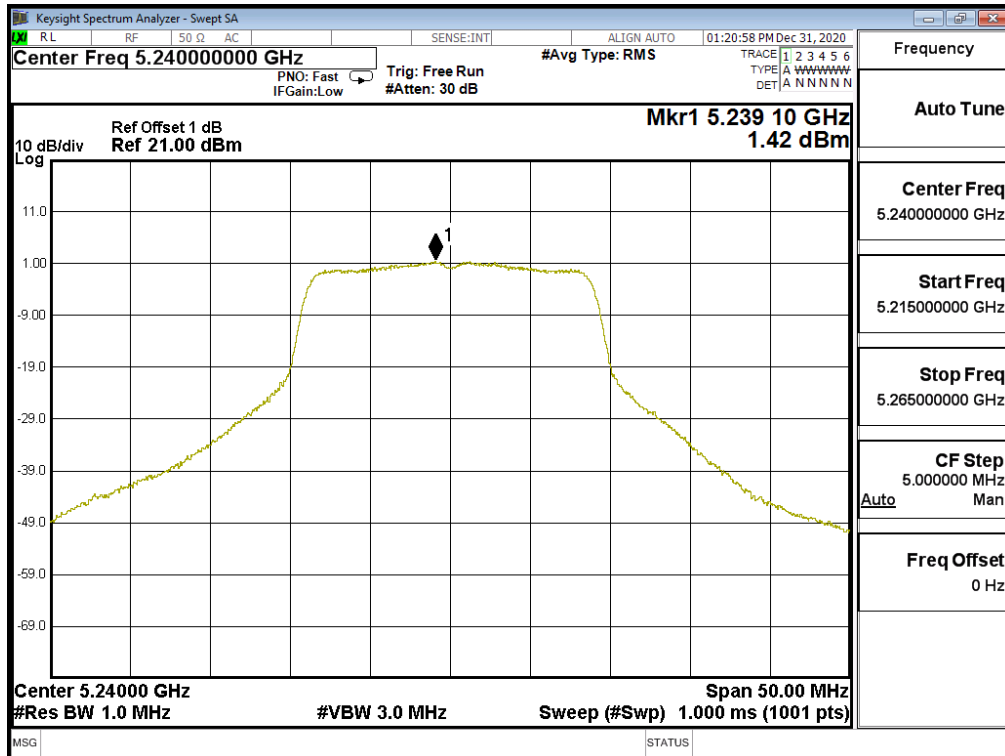

Channel 52:

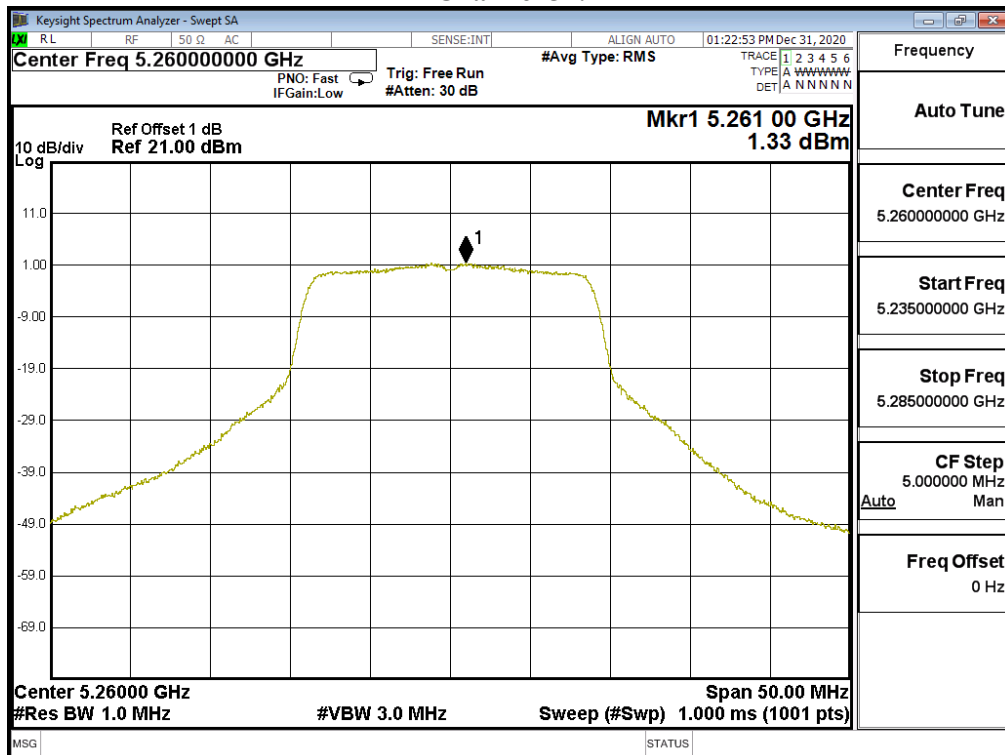

Channel 60:

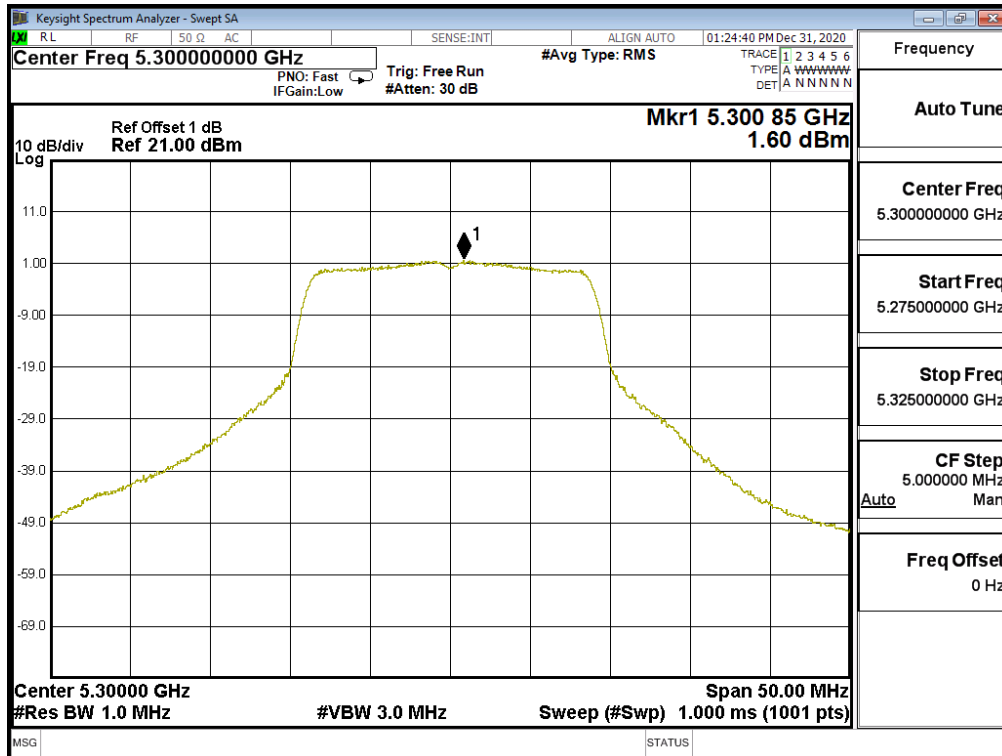

Channel 64:

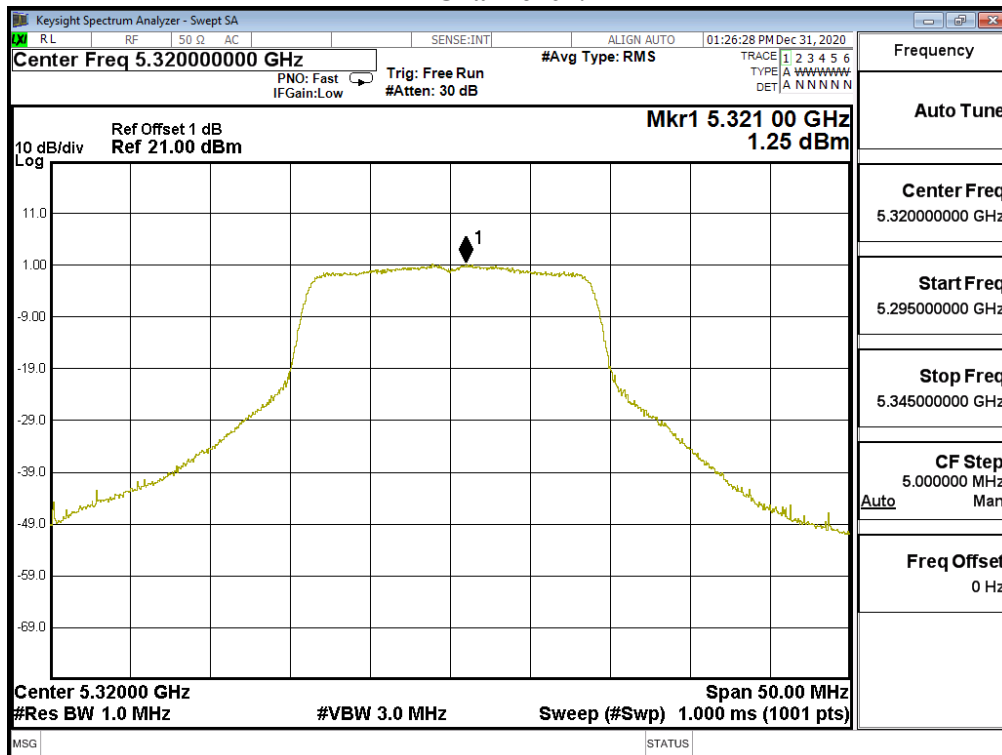

Channel 100:

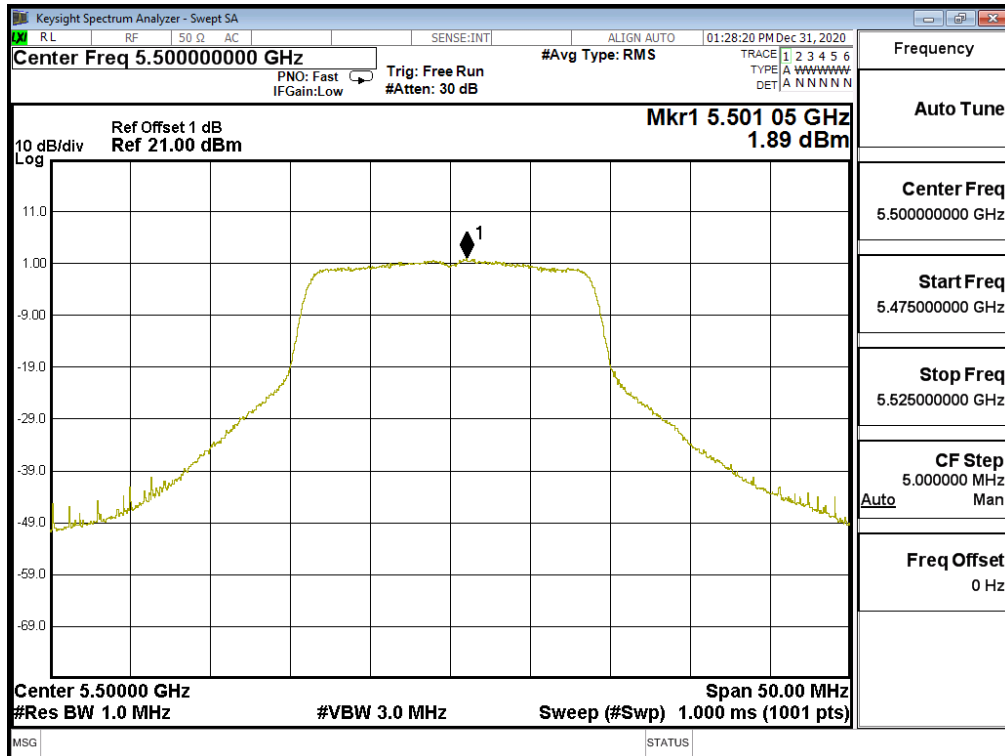

Channel 116:

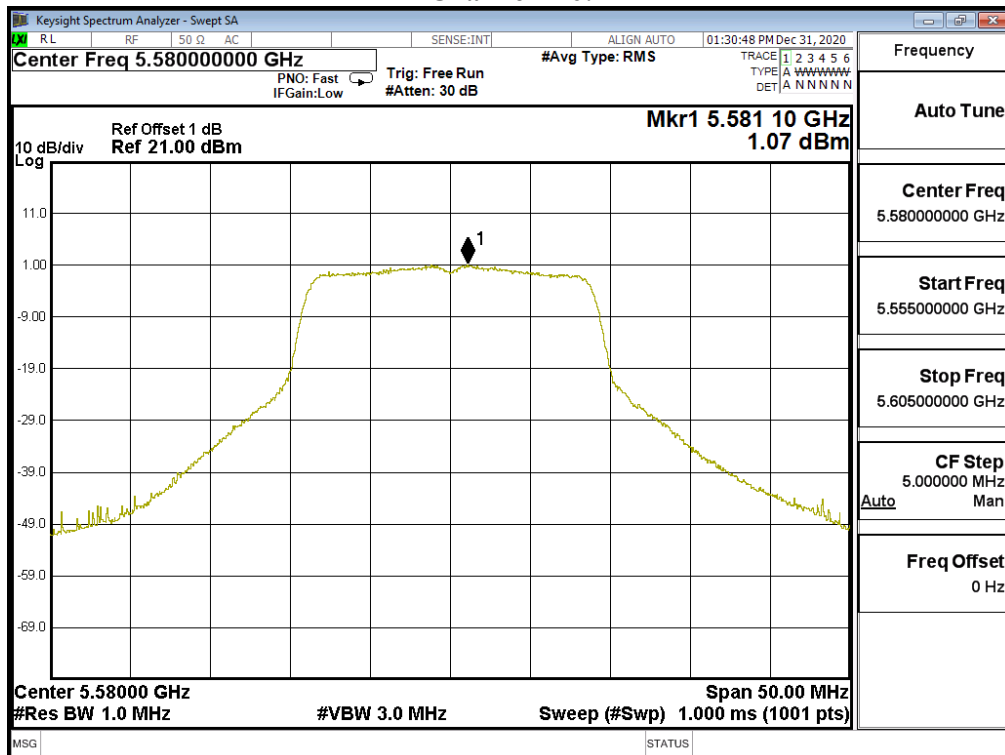

Channel 140:

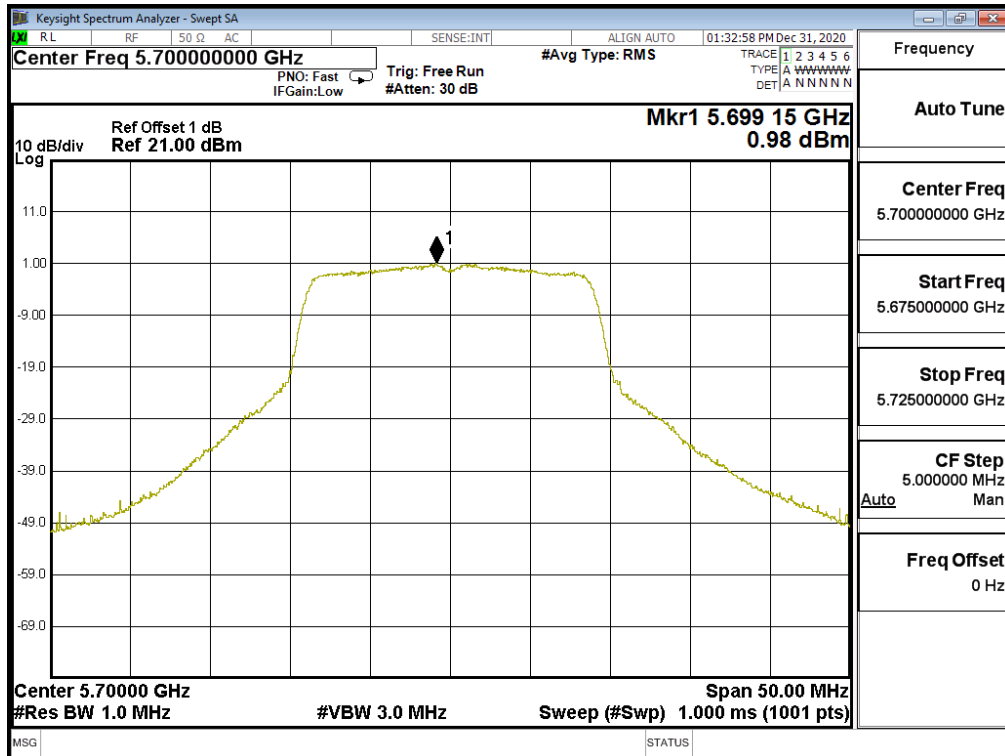

Channel 144(U-NII-2C):

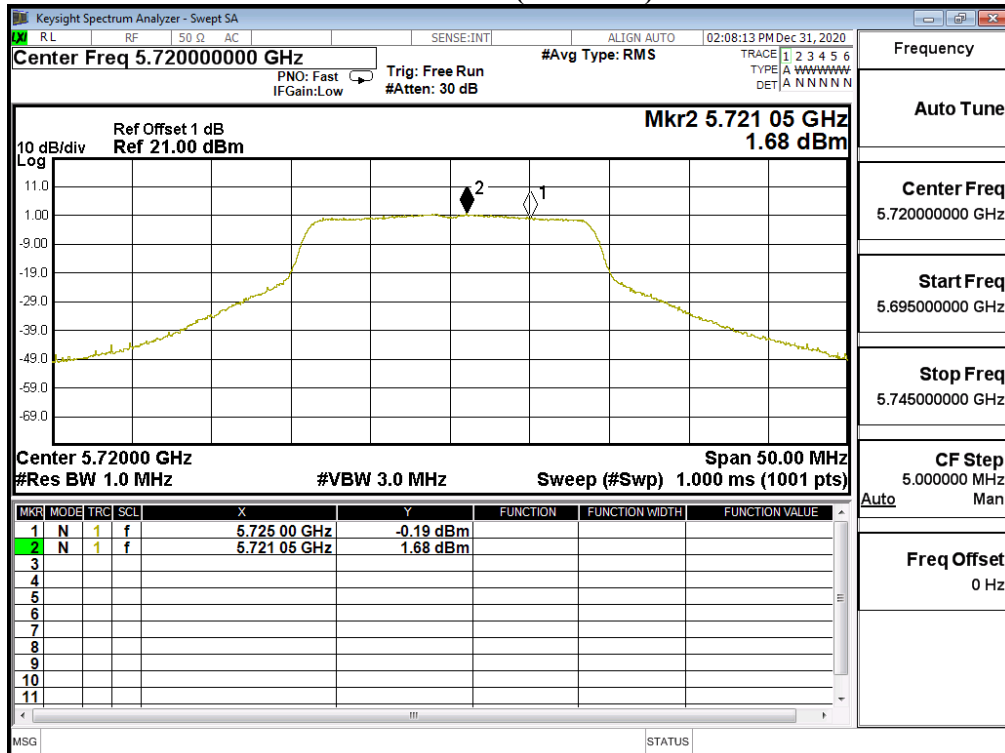

Channel 144(U-NII-3):

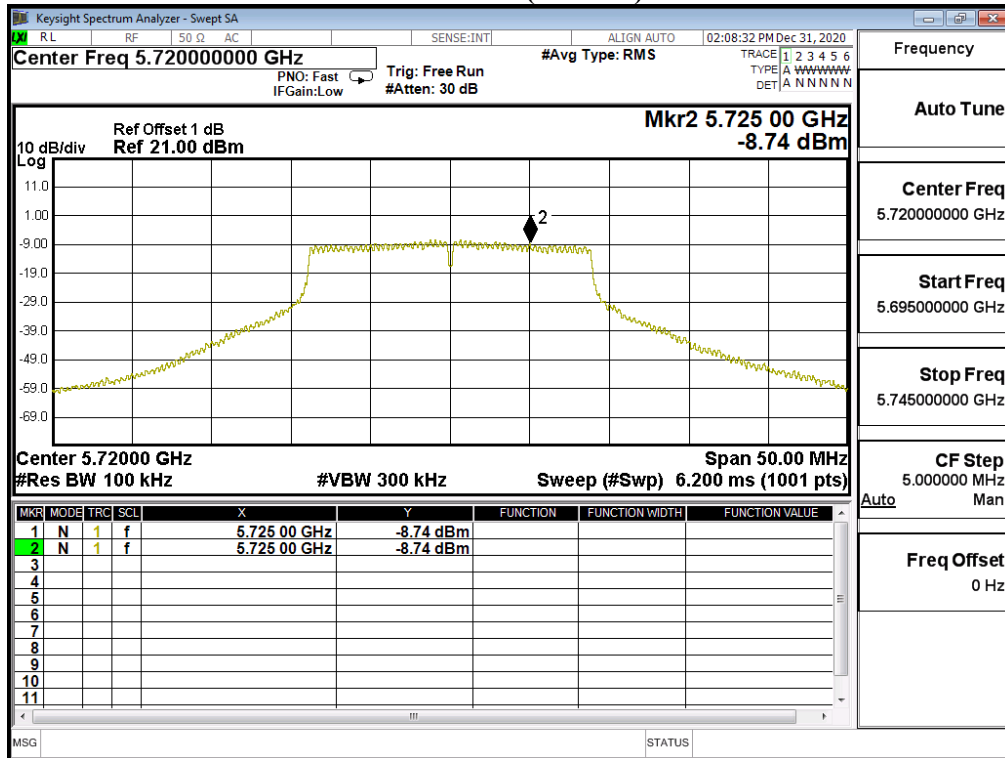

Channel 149

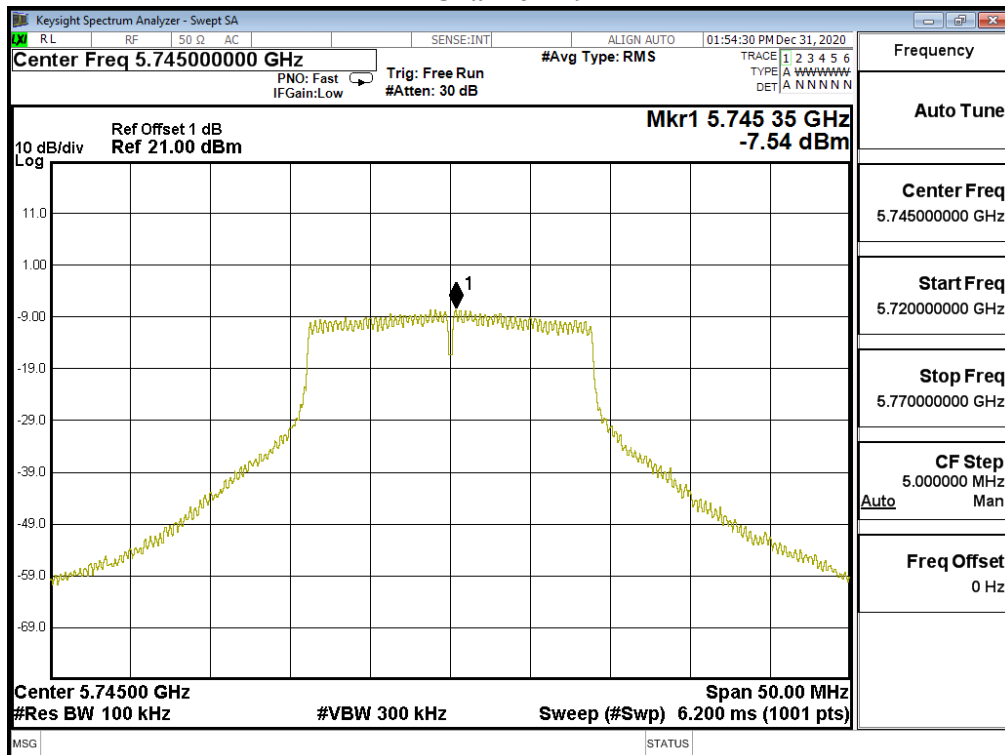

Channel 157

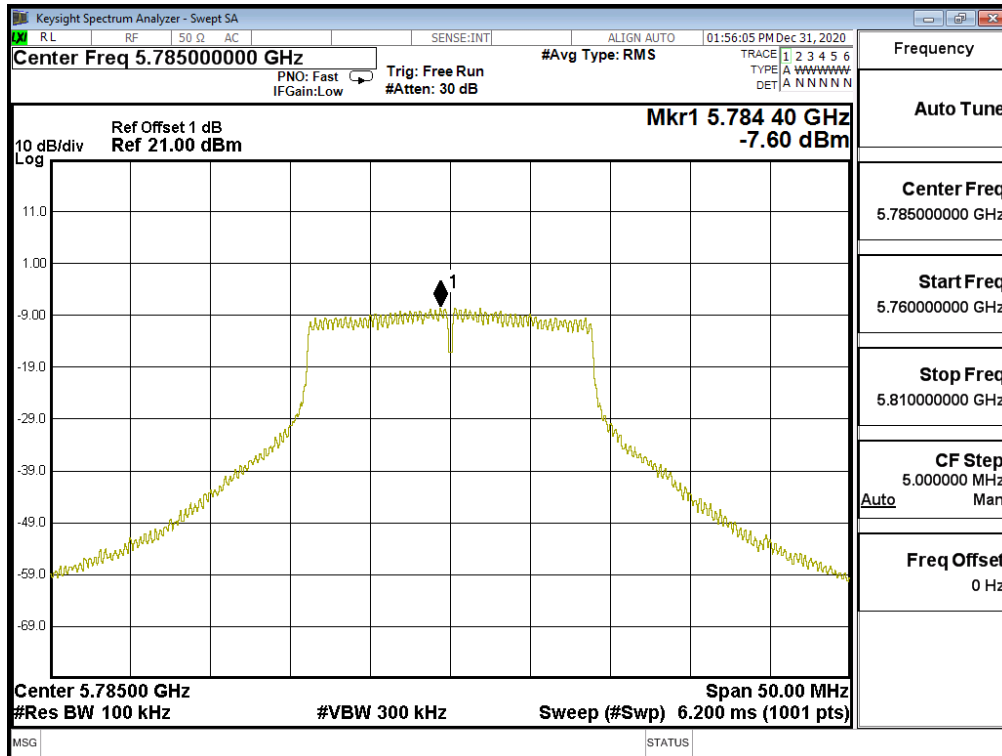

Channel 165

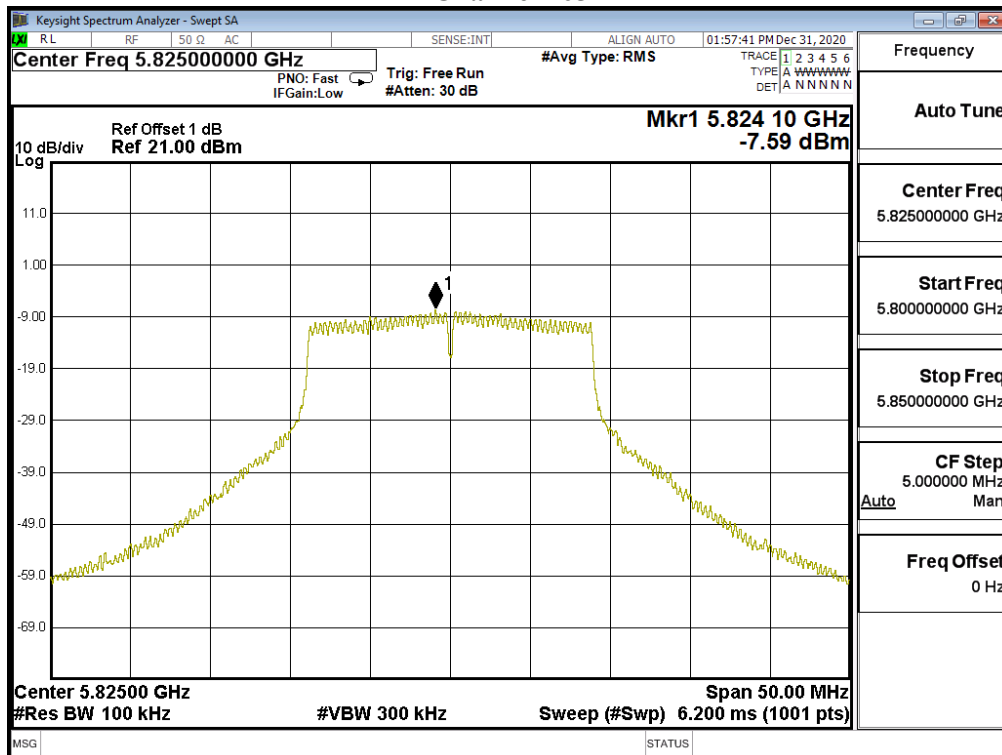

Product : PanaCast 50
 Test Item : Peak Power Spectral Density
 Test Mode : Mode 3: Transmit (802.11n-40BW 15Mbps)
 Test Date : 2020/12/31

| Channel Number | Frequency (MHz) | Data Rate (Mbps) | Measurement Level (dBm) | Required Limit (dBm) | Result |
|----------------|-----------------|------------------|-------------------------|----------------------|--------|
| 38 | 5190 | 6 | -2.570 | 11 | Pass |
| 46 | 5230 | 6 | -2.180 | 11 | Pass |
| 54 | 5270 | 6 | -2.510 | 11 | Pass |
| 62 | 5310 | 6 | -2.420 | 11 | Pass |
| 102 | 5510 | 6 | -2.210 | 11 | Pass |
| 110 | 5550 | 6 | -2.710 | 11 | Pass |
| 134 | 5670 | 6 | -2.920 | 11 | Pass |
| 142(U-NII-2C) | 5710 | 6 | -2.500 | 11 | Pass |

| Channel Number | Frequency (MHz) | Data Rate (Mbps) | PPSD (dBm) | BWCF (dB) | Total PPSD (dBm) | Required Limit (dBm) | Result |
|----------------|-----------------|------------------|------------|-----------|------------------|----------------------|--------|
| 142(U-NII-3) | 5710 | 6 | -13.430 | 6.980 | -6.450 | <30 | Pass |
| 151 | 5755 | 6 | -11.690 | 6.980 | -4.710 | <30 | Pass |
| 159 | 5795 | 6 | -11.310 | 6.980 | -4.330 | <30 | Pass |

Channel 38

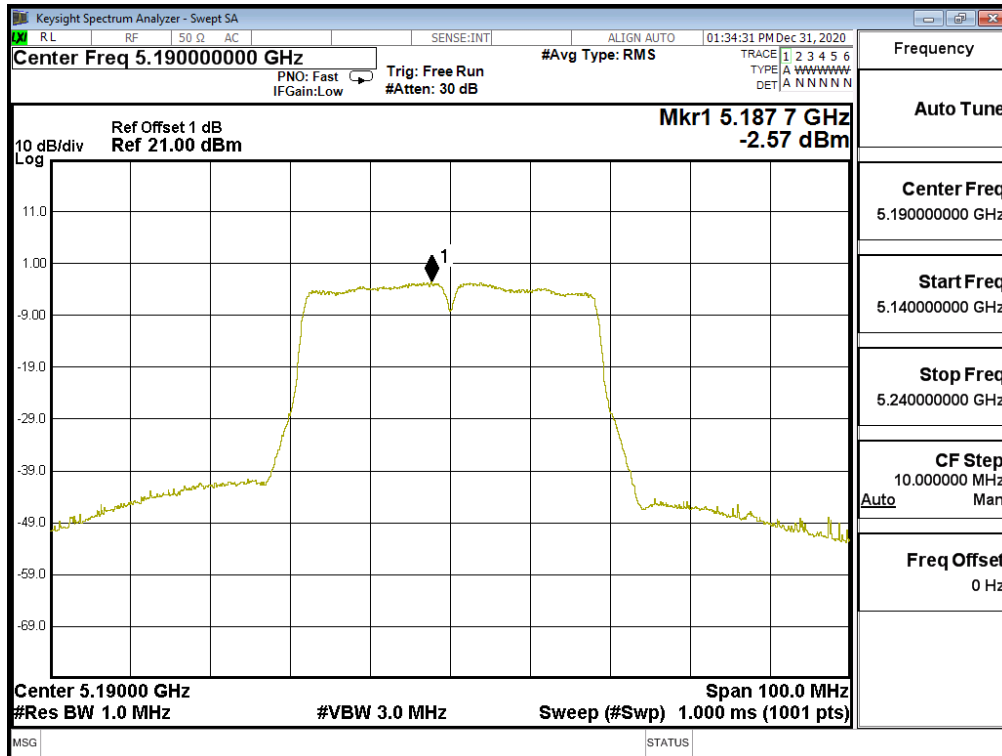

Channel 46

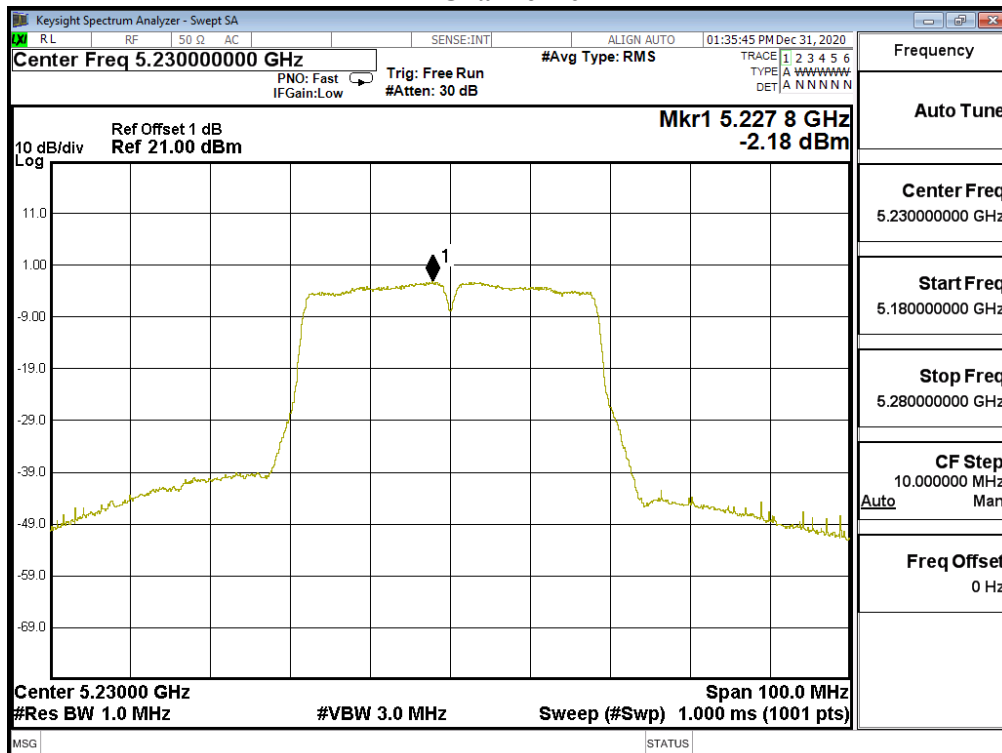

Channel 54

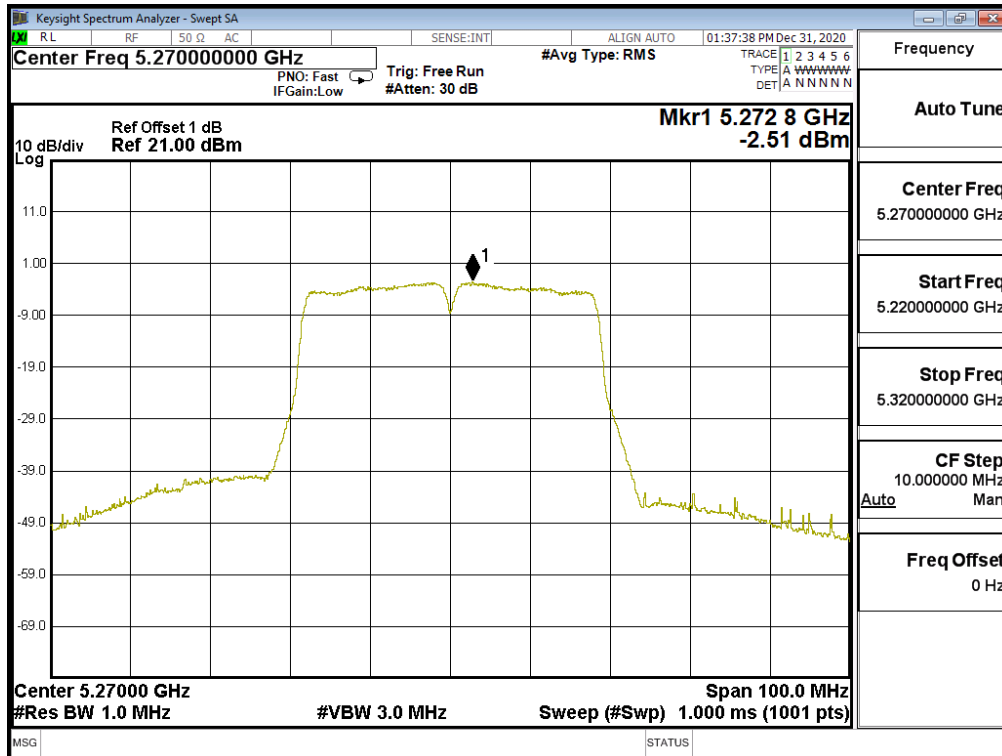

Channel 62

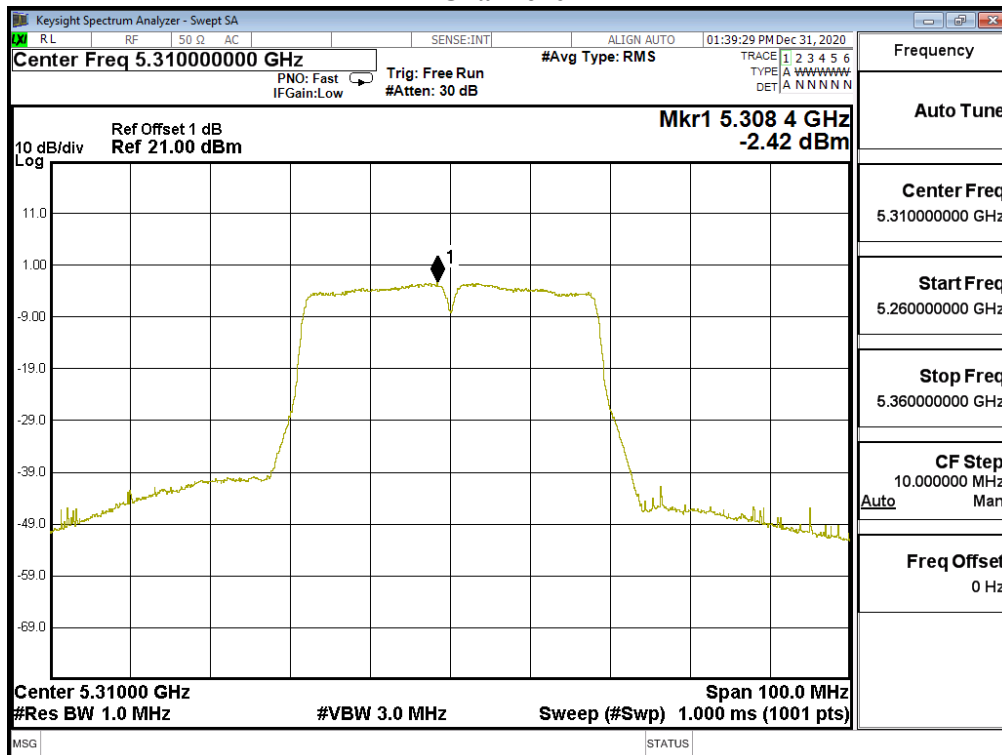

Channel 102

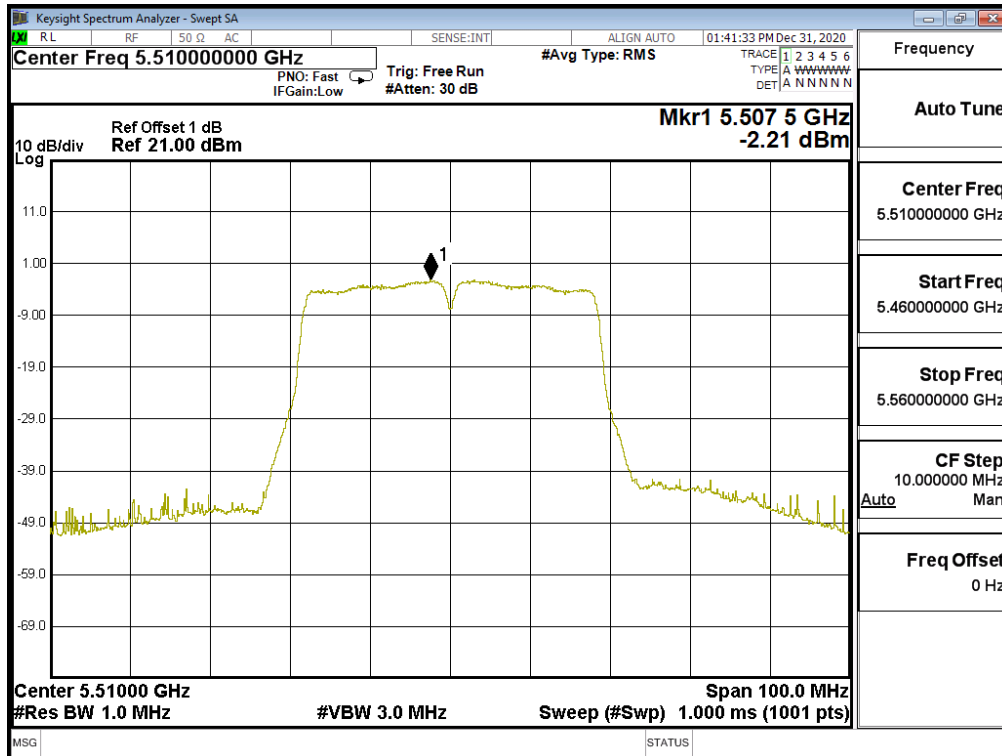

Channel 110

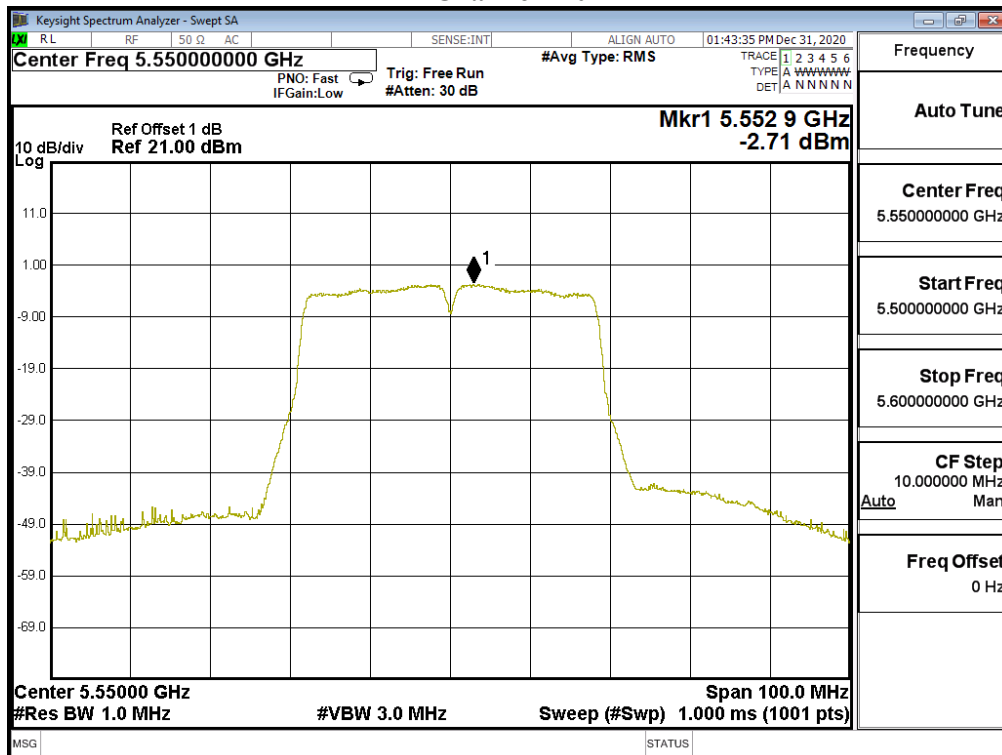

Channel 134

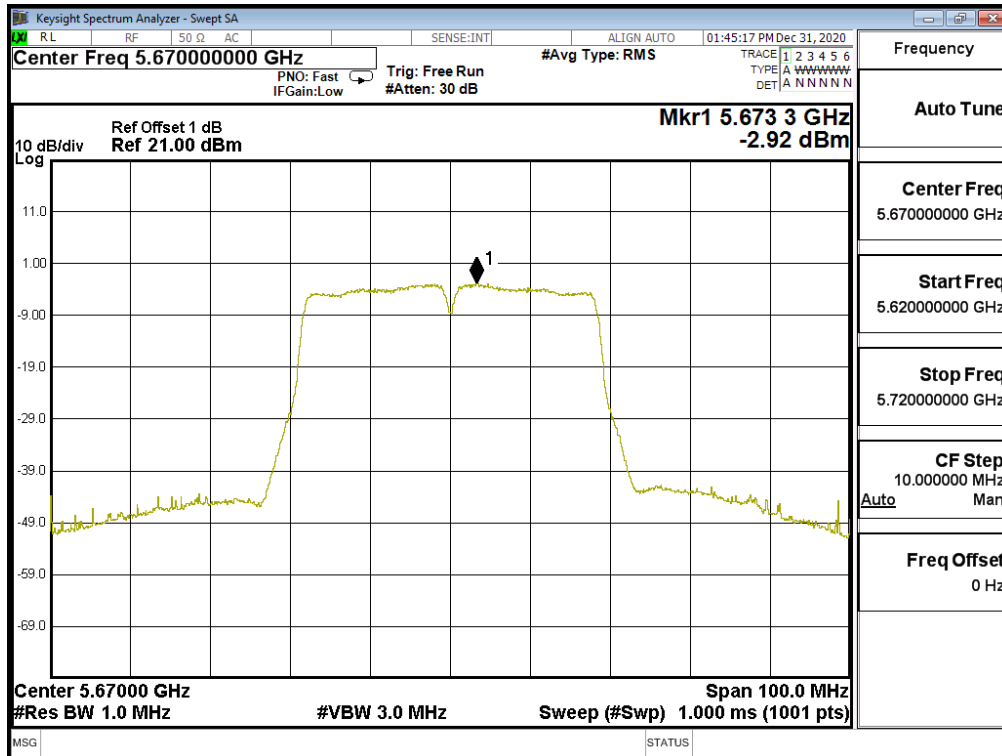

Channel 142(Band3)

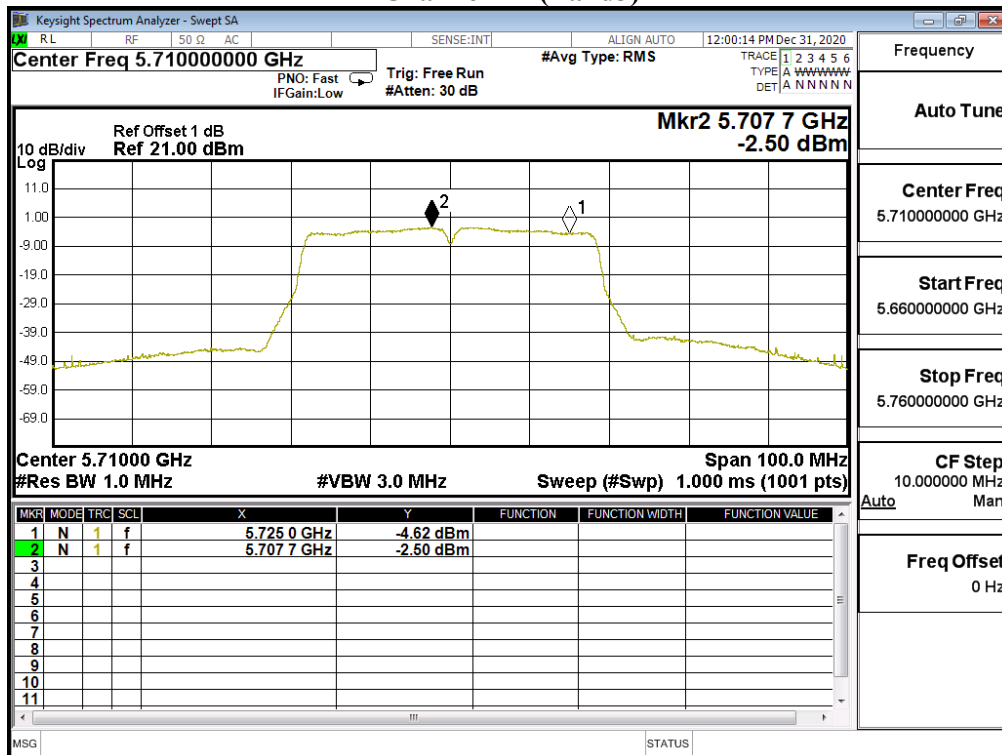

Channel 142(Band4)

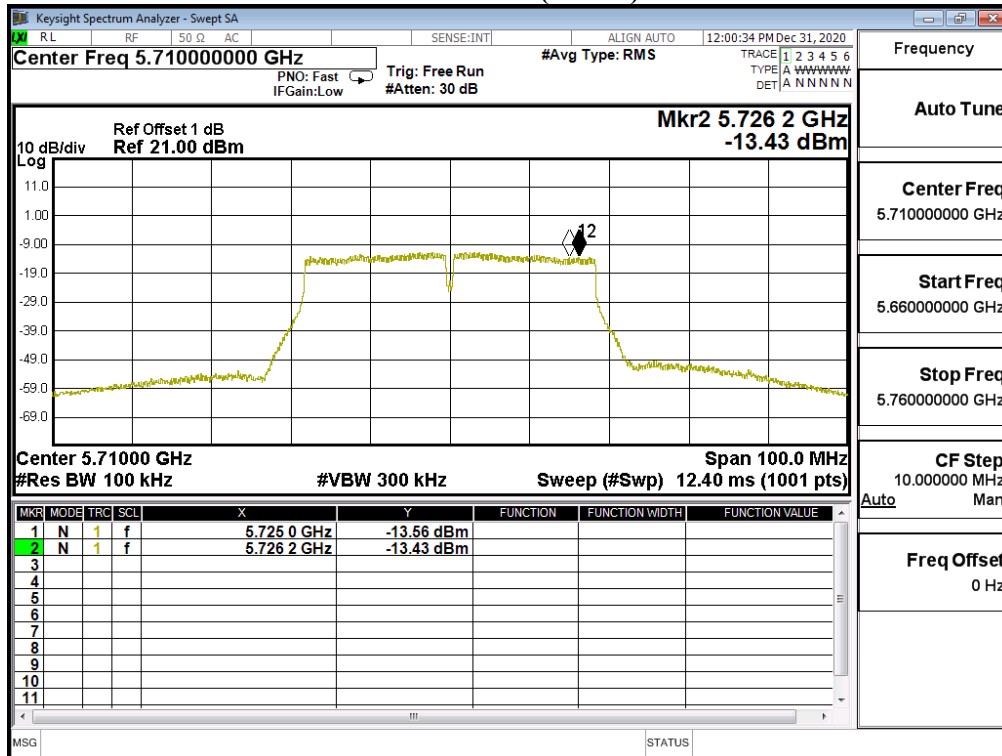

Channel 151

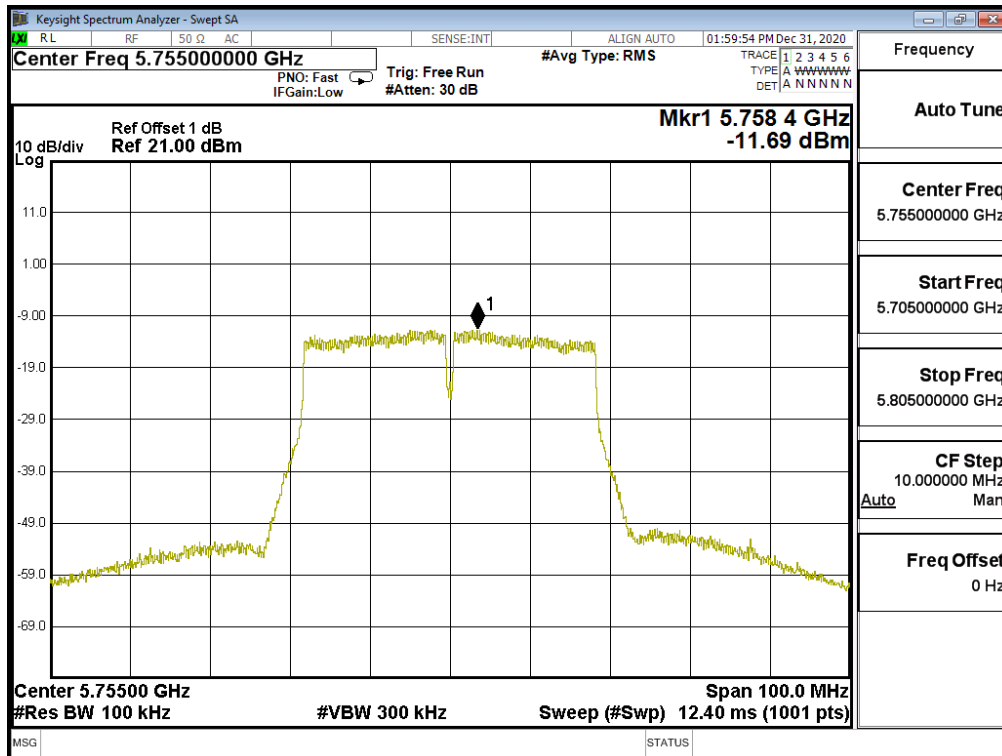

Channel 159

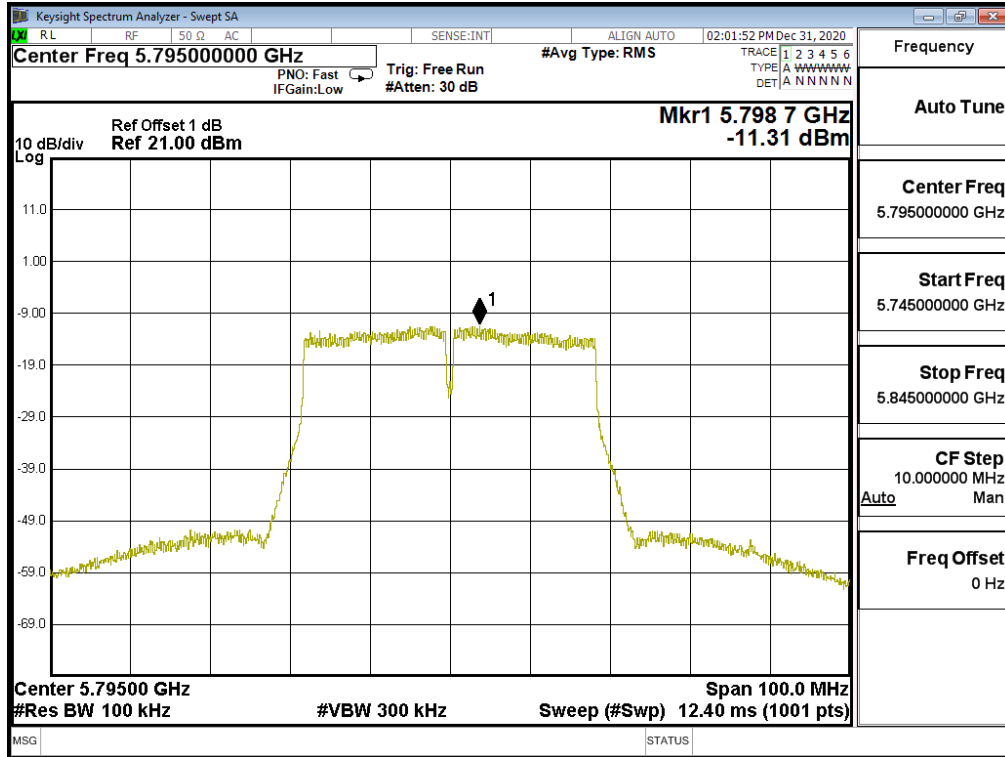

Product : PanaCast 50
Test Item : Peak Power Spectral Density
Test Mode : Mode 4: Transmit (802.11ac-80BW 32.5Mbps)
Test Date : 2020/12/31

| Channel Number | Frequency (MHz) | PPSD (dBm) | BWCF (dB) | Total PPSD (dBm) ¹ | Result |
|----------------|-----------------|------------|-----------|-------------------------------|--------|
| 42 | 5210 | -6.440 | -- | -6.440 | <11 |
| 58 | 5290 | -6.110 | -- | -6.110 | <11 |
| 106 | 5530 | -5.660 | -- | -5.660 | <11 |
| 122 | 5610 | -6.500 | -- | -6.500 | <11 |
| 138(U-NII-2C) | 5690 | -6.100 | -- | -6.100 | <11 |
| 138(U-NII-3) | 5690 | -16.410 | 6.98 | -16.410 | <30 |
| 155 | 5775 | -14.920 | 6.98 | -14.920 | <30 |

Channel 42

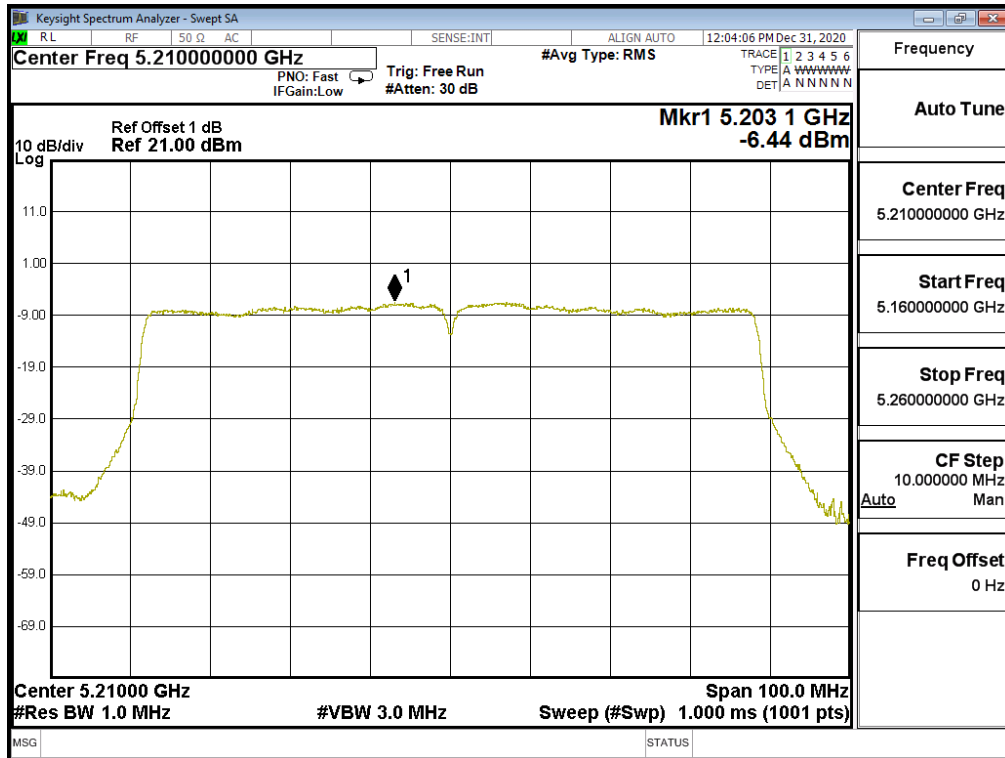

Channel 58

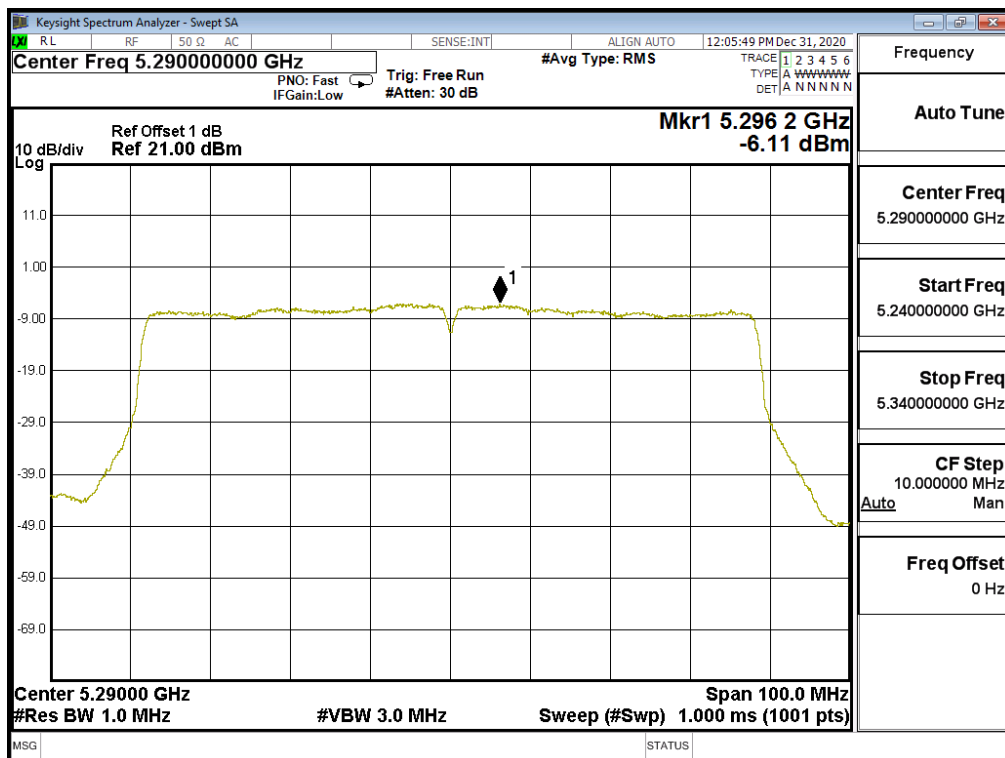

Channel 106

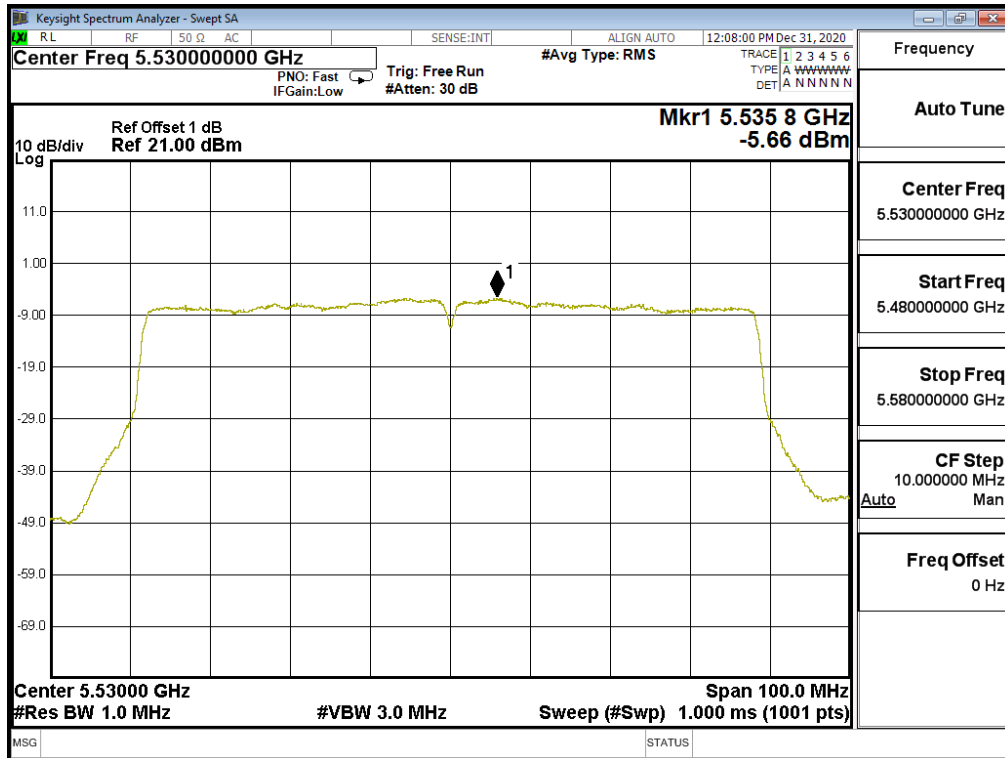

Channel 122

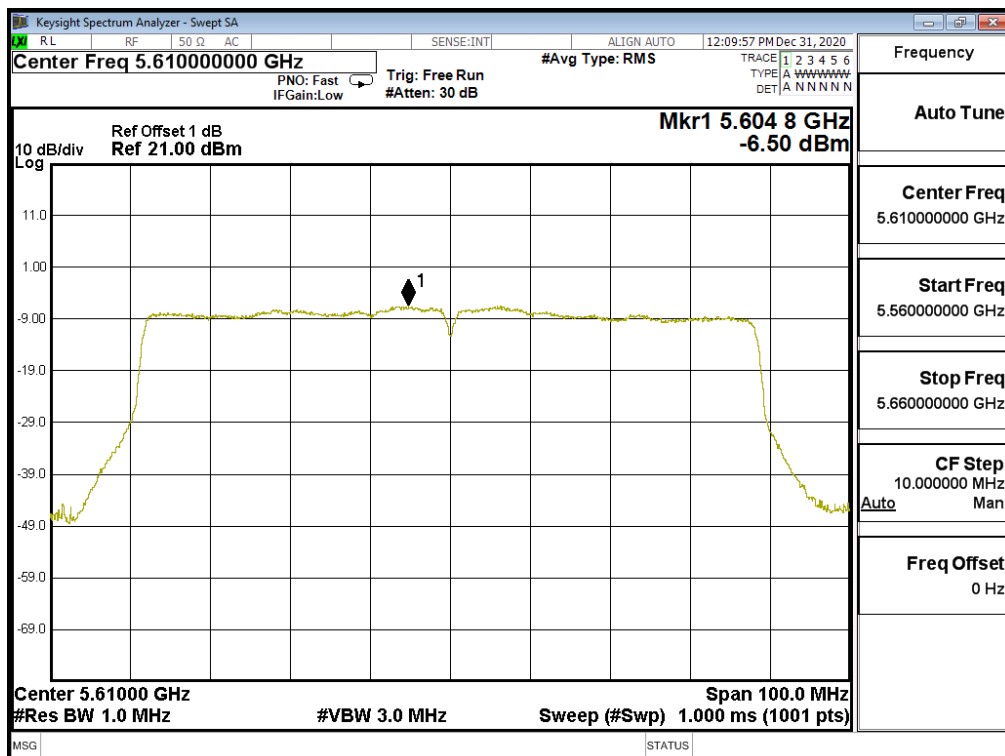

Channel 138 (U-NII-2C)

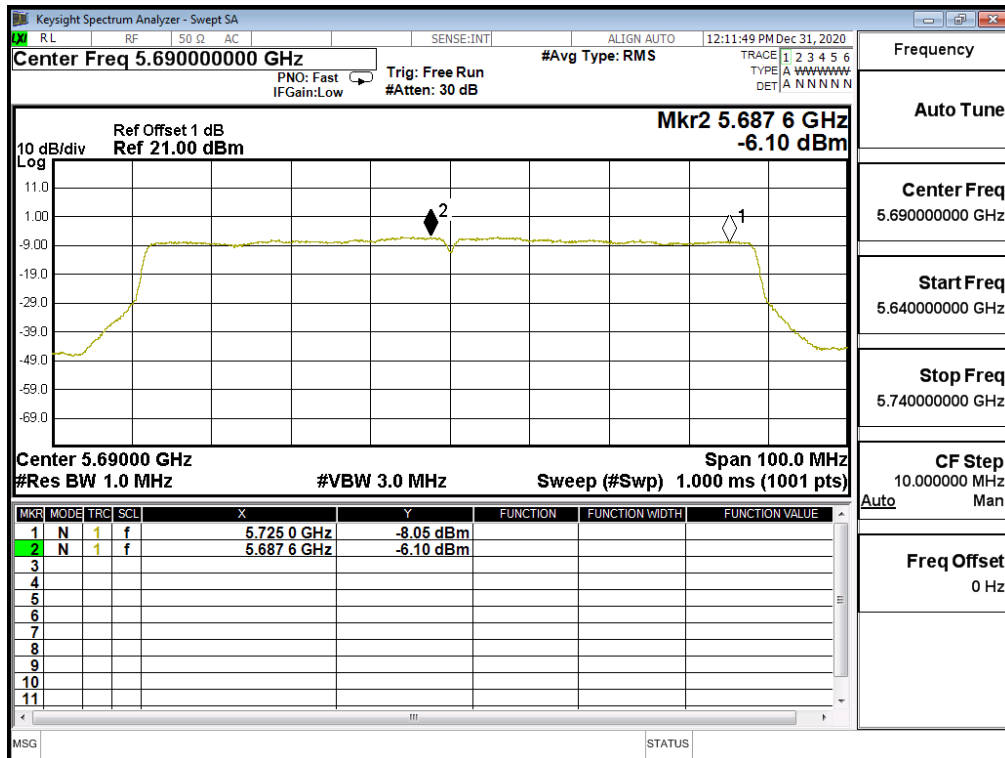

Channel 138 (U-NII-3)

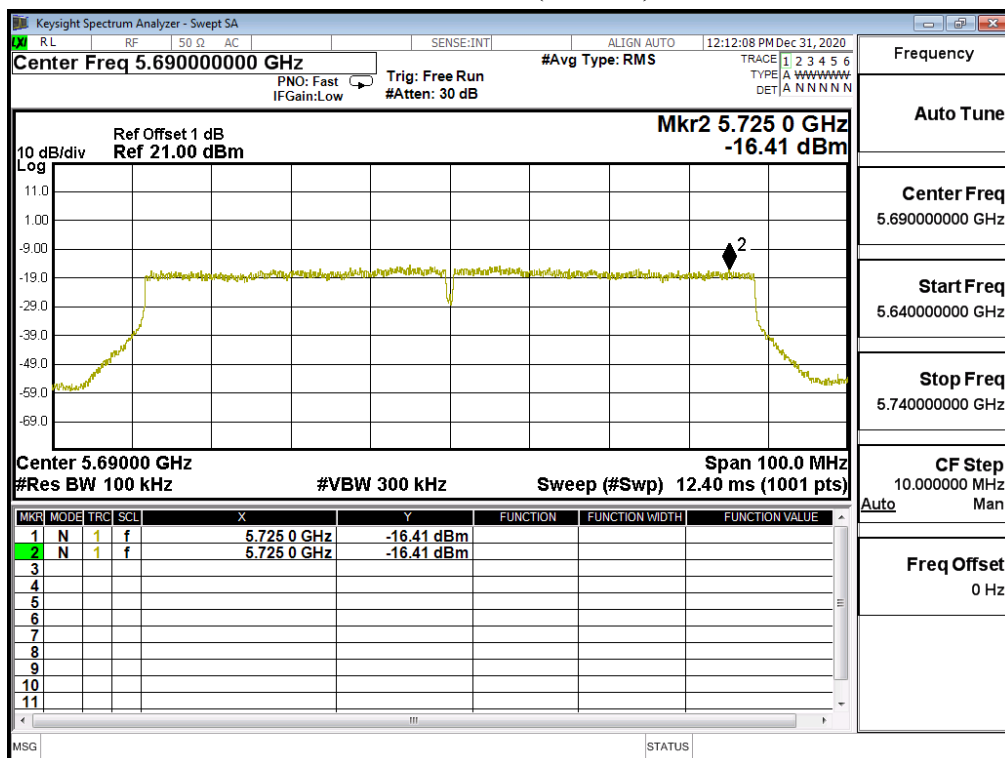

Channel 155

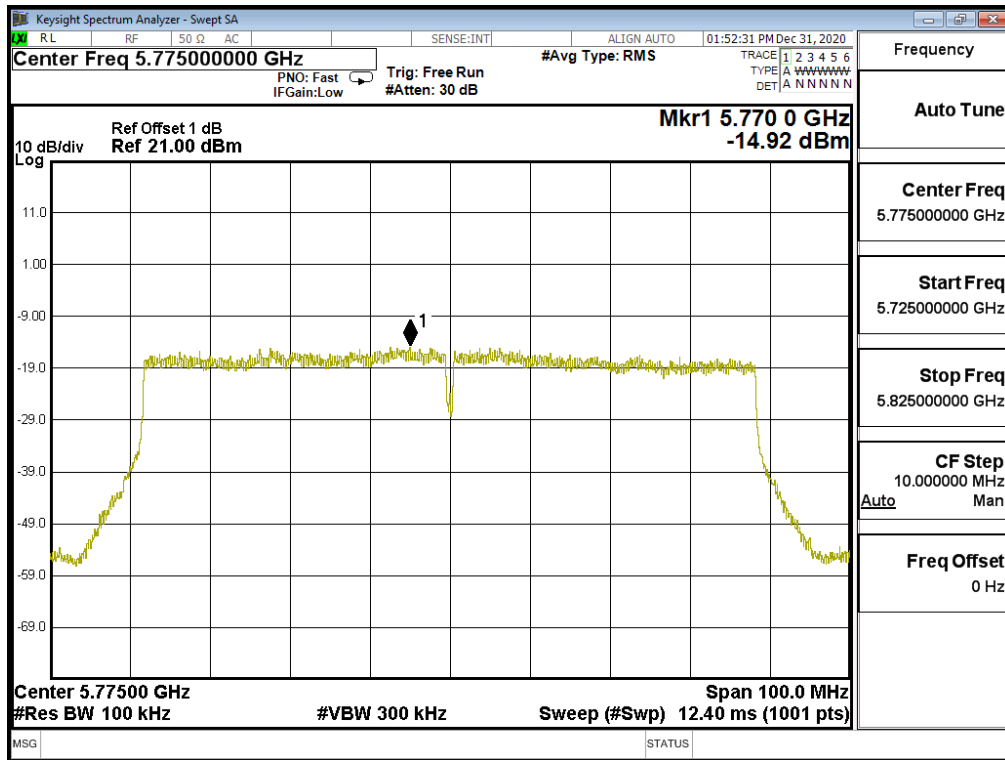

5. Radiated Emission

5.1. Test Setup

Radiated Emission Under 30MHz

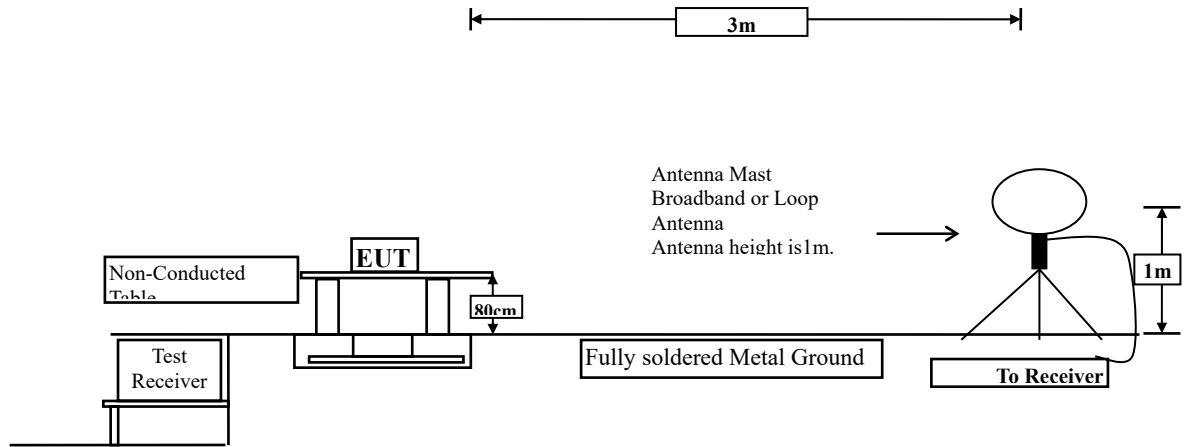

Radiated Emission Below 1GHz

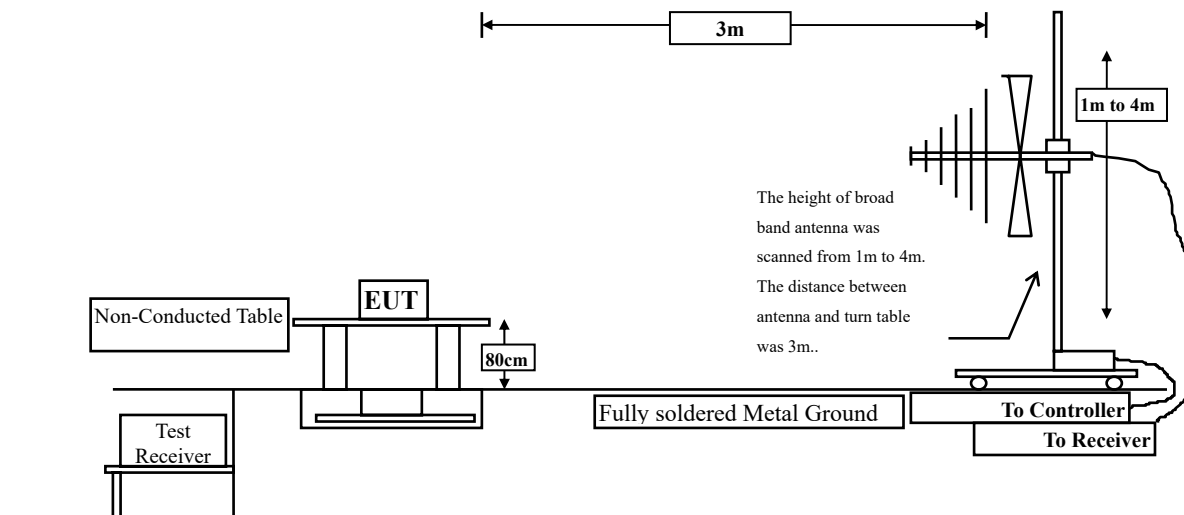

Radiated Emission Above 1GHz

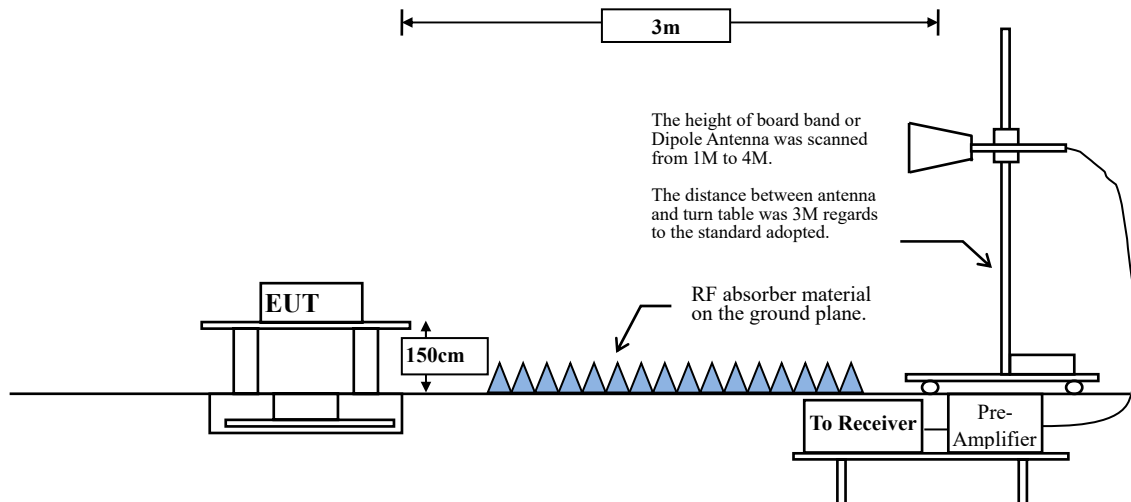

5.2. Limits

Emissions radiated outside of the specified frequency bands, except for harmonics, shall be attenuated by at least 20dB below the level of the fundamental or to the general radiated emission limits in paragraph 15.209, whichever is the lesser attenuation.

| FCC Part 15 Subpart C Paragraph 15.209(a) Limits | | |
|---|--------------------------------------|---------------------------------|
| Frequency MHz | Field strength (microvolts/meter) | Measurement distance (meter) |
| 0.009-0.490 | 2400/F(kHz) | 300 |
| 0.490-1.705 | 24000/F(kHz) | 30 |
| 1.705-30 | 30 | 30 |
| 30-88 | 100 | 3 |
| 88-216 | 150 | 3 |
| 216-960 | 200 | 3 |
| Above 960 | 500 | 3 |

Remarks: E field strength (dB μ V/m) = 20 log E field strength (uV/m)

5.3. Test Procedure

The EUT was setup according to ANSI C63.10, 2013 and tested according to FCC KDB-789033 test procedure for compliance to FCC 47CFR 15. 407 requirements.

Measuring the frequency range below 1GHz, the EUT is placed on a turn table which is 0.8 meter above ground, when measuring the frequency range above 1GHz, the EUT is placed on a turn table which is 1.5 meter above ground.

The turn table is rotated 360 degrees to determine the position of the maximum emission level.

The EUT was positioned such that the distance from antenna to the EUT was 3 meters.

The antenna is scanned between 1 meter and 4 meters to find out the maximum emission level. This is repeated for both horizontal and vertical polarization of the antenna. In order to find the maximum emission, all of the interface cables were manipulated according to ANSI C63.10: 2013 on radiated measurement.

The resolution bandwidth below 30MHz setting on the field strength meter is 9kHz and 30MHz~1GHz is 120kHz and above 1GHz is 1MHz.

Radiated emission measurements below 30MHz are made using Loop Antenna and 30MHz~1GHz are made using broadband Bilog antenna and above 1GHz are made using Horn Antennas.

The measurement is divided into the Preliminary Measurement and the Final Measurement.

The suspected frequencies are searched for in Preliminary Measurement with the measurement antenna kept pointed at the source of the emission both in azimuth and elevation, with the polarization of the antenna oriented for maximum response. The antenna is pointed at an angle towards the source of the emission, and the EUT is rotated in both height and polarization to maximize the measured emission. The emission is kept within the illumination area of the 3 dB bandwidth of the antenna. The measurement frequency range from 9kHz - 10th Harmonic of fundamental was investigated.

RBW and VBW Parameter setting:

According to KDB 789033 section II.G.5 Procedure for Unwanted Maximum Emissions Measurements above 1000 MHz.

RBW = 1MHz.

VBW \geq 3MHz.

According to KDB 789033 section II.G.6 Procedures for Average Unwanted Emissions Measurements above 1000 MHz.

RBW = 1MHz.

VBW = 10Hz, when duty cycle \geq 98 %

VBW \geq 1/T, when duty cycle < 98 %

(T refers to the minimum transmission duration over which the transmitter is on and is transmitting at its maximum power control level for the tested mode of operation.)

| 5GHz band | Duty Cycle (%) | T (ms) | 1/T (Hz) | VBW (Hz) |
|------------|----------------|--------|----------|----------|
| 802.11a | 97.17 | 1.3420 | 745 | 1k |
| 802.11n20 | 96.98 | 1.2551 | 797 | 1k |
| 802.11n40 | 94.10 | 0.6246 | 1601 | 2k |
| 802.11ac80 | 88.89 | 0.3131 | 3194 | 5k |

Note: Duty Cycle Refer to Section 8

5.4. Test Result of Radiated Emission

Product : PanaCast 50
 Test Item : Harmonic Radiated Emission Data
 Test Mode : Mode 1: Transmit (802.11a 6Mbps) (5180MHz)
 Test Date : 2021/02/05

Horizontal

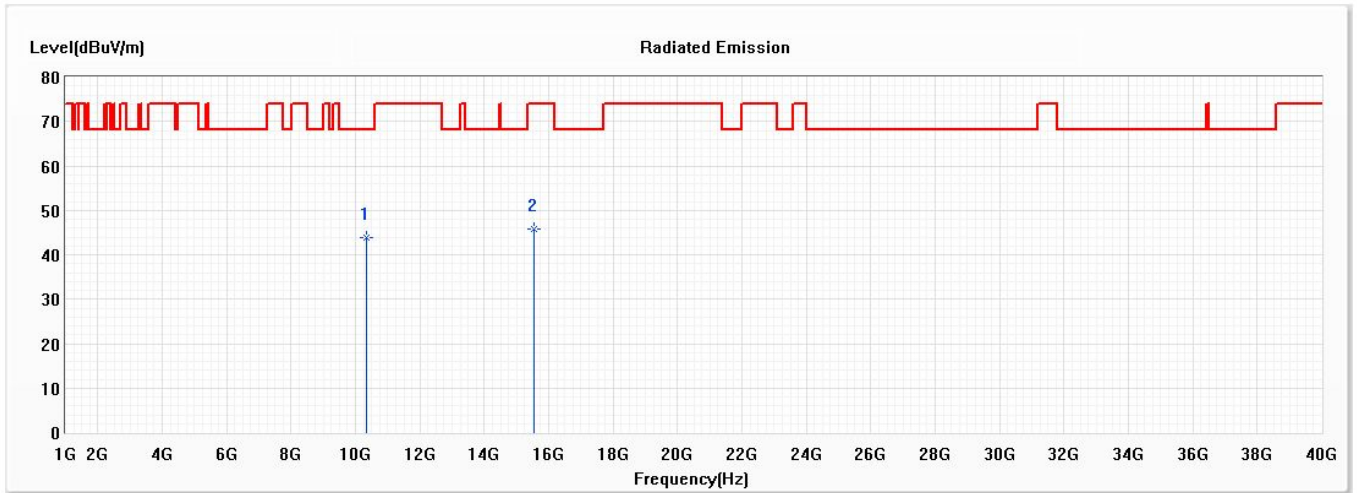

| No | Frequency (MHz) | Emission Level (dBuV/m) | Limit (dBuV/m) | Margin (dB) | Reading Level (dBuV) | Correct Factor (dB) | Detector Type |
|-----|-----------------|-------------------------|----------------|-------------|----------------------|---------------------|---------------|
| * 1 | 10360.000 | 43.78 | 68.22 | -24.44 | 53.84 | -10.06 | PK |
| 2 | 15540.000 | 45.91 | 74.00 | -28.09 | 49.80 | -3.89 | PK |

Note:

1. All Readings below 1GHz are Quasi-Peak, above 1GHz are performed with peak and/or average measurements as necessary.
2. Measurement Level = Reading Level + Correct Factor.
3. Correct Factor = Antenna factor + Cable loss – Amplifier gain.
4. The average measurement was not performed when the peak measured data under the limit of average detection.
5. The emission levels of other frequencies are very lower than the limit and not show in test report.

Product : PanaCast 50
 Test Item : Harmonic Radiated Emission Data
 Test Mode : Mode 1: Transmit (802.11a 6Mbps) (5180MHz)
 Test Date : 2021/02/05

Vertical

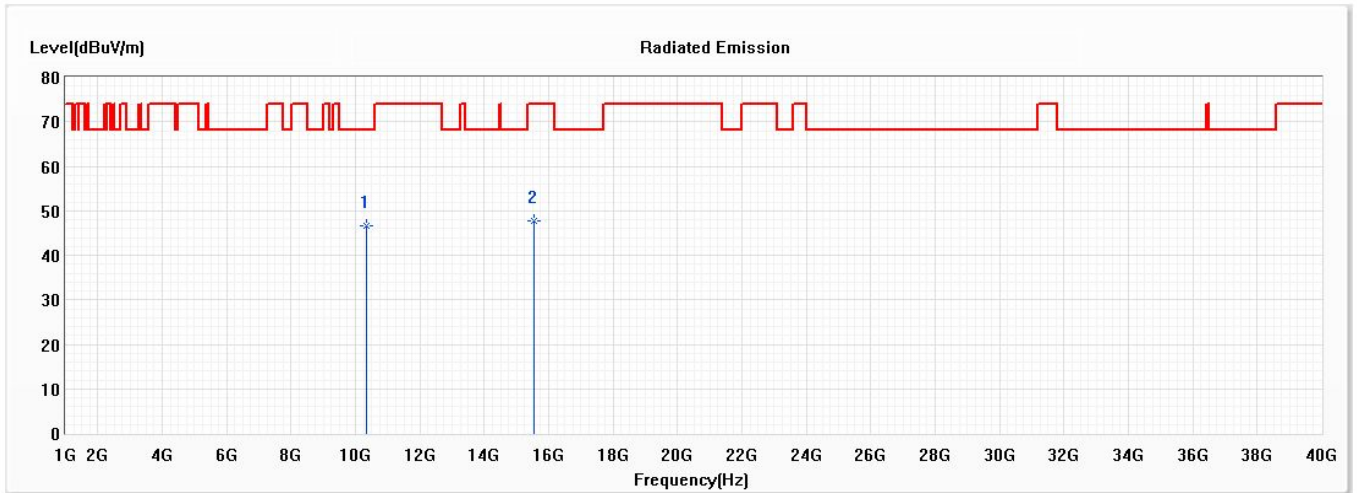

| No | Frequency (MHz) | Emission Level (dBuV/m) | Limit (dBuV/m) | Margin (dB) | Reading Level (dBuV) | Correct Factor (dB) | Detector Type |
|-----|-----------------|-------------------------|----------------|-------------|----------------------|---------------------|---------------|
| * 1 | 10360.000 | 46.71 | 68.22 | -21.51 | 56.77 | -10.06 | PK |
| 2 | 15540.000 | 47.82 | 74.00 | -26.18 | 51.71 | -3.89 | PK |

Note:

1. All Readings below 1GHz are Quasi-Peak, above 1GHz are performed with peak and/or average measurements as necessary.
2. Measurement Level = Reading Level + Correct Factor.
3. Correct Factor = Antenna factor + Cable loss – Amplifier gain.
4. The average measurement was not performed when the peak measured data under the limit of average detection.
5. The emission levels of other frequencies are very lower than the limit and not show in test report.

Product : PanaCast 50
 Test Item : Harmonic Radiated Emission Data
 Test Mode : Mode 1: Transmit (802.11a 6Mbps) (5220MHz)
 Test Date : 2021/02/05

Horizontal

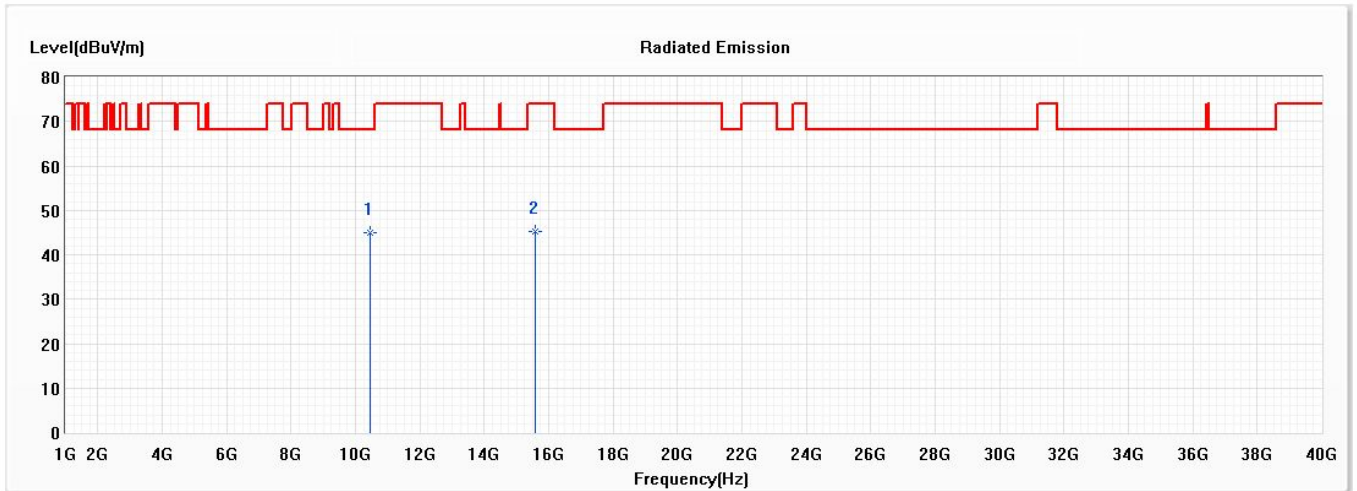

| No | Frequency (MHz) | Emission Level (dBuV/m) | Limit (dBuV/m) | Margin (dB) | Reading Level (dBuV) | Correct Factor (dB) | Detector Type |
|-----|-----------------|-------------------------|----------------|-------------|----------------------|---------------------|---------------|
| * 1 | 10440.000 | 45.04 | 68.22 | -23.18 | 55.01 | -9.97 | PK |
| 2 | 15600.000 | 45.31 | 74.00 | -28.69 | 49.04 | -3.73 | PK |

Note:

1. All Readings below 1GHz are Quasi-Peak, above 1GHz are performed with peak and/or average measurements as necessary.
2. Measurement Level = Reading Level + Correct Factor.
3. Correct Factor = Antenna factor + Cable loss – Amplifier gain.
4. The average measurement was not performed when the peak measured data under the limit of average detection.
5. The emission levels of other frequencies are very lower than the limit and not show in test report.

Product : PanaCast 50
 Test Item : Harmonic Radiated Emission Data
 Test Mode : Mode 1: Transmit (802.11a 6Mbps) (5220MHz)
 Test Date : 2021/02/05

Vertical

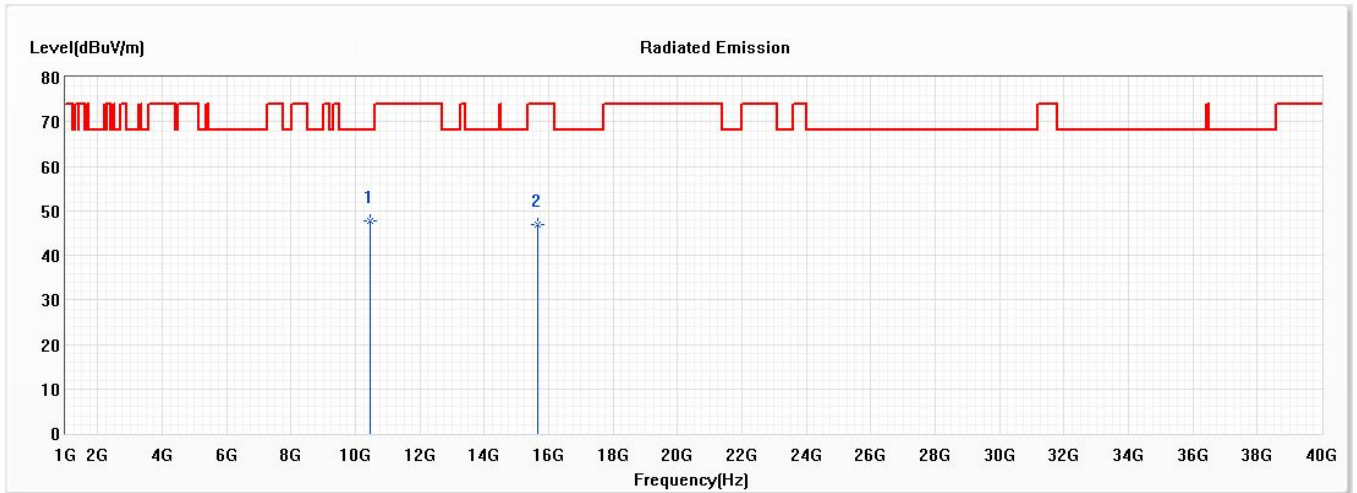

| No | Frequency (MHz) | Emission Level (dBuV/m) | Limit (dBuV/m) | Margin (dB) | Reading Level (dBuV) | Correct Factor (dB) | Detector Type |
|-----|-----------------|-------------------------|----------------|-------------|----------------------|---------------------|---------------|
| * 1 | 10440.000 | 47.74 | 68.22 | -20.48 | 57.71 | -9.97 | PK |
| 2 | 15660.000 | 46.94 | 74.00 | -27.06 | 50.44 | -3.50 | PK |

Note:

1. All Readings below 1GHz are Quasi-Peak, above 1GHz are performed with peak and/or average measurements as necessary.
2. Measurement Level = Reading Level + Correct Factor.
3. Correct Factor = Antenna factor + Cable loss – Amplifier gain.
4. The average measurement was not performed when the peak measured data under the limit of average detection.
5. The emission levels of other frequencies are very lower than the limit and not show in test report.

Product : PanaCast 50
 Test Item : Harmonic Radiated Emission Data
 Test Mode : Mode 1: Transmit (802.11a 6Mbps) (5240MHz)
 Test Date : 2021/02/05

Horizontal

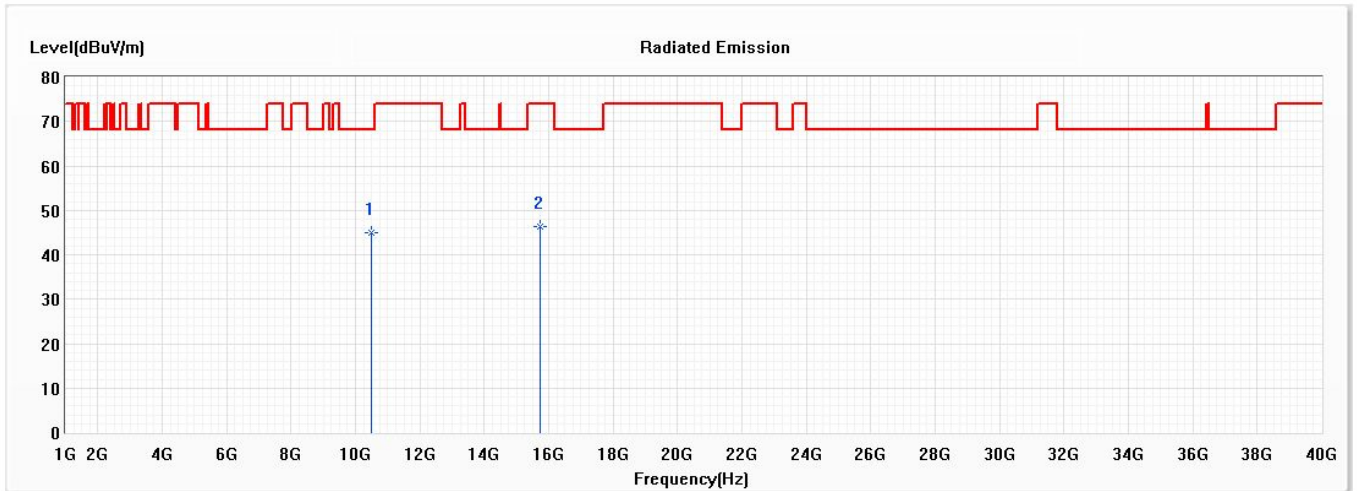

| No | Frequency (MHz) | Emission Level (dBuV/m) | Limit (dBuV/m) | Margin (dB) | Reading Level (dBuV) | Correct Factor (dB) | Detector Type |
|-----|-----------------|-------------------------|----------------|-------------|----------------------|---------------------|---------------|
| * 1 | 10480.000 | 44.83 | 68.22 | -23.39 | 54.71 | -9.88 | PK |
| 2 | 15720.000 | 46.32 | 74.00 | -27.68 | 49.66 | -3.34 | PK |

Note:

1. All Readings below 1GHz are Quasi-Peak, above 1GHz are performed with peak and/or average measurements as necessary.
2. Measurement Level = Reading Level + Correct Factor.
3. Correct Factor = Antenna factor + Cable loss – Amplifier gain.
4. The average measurement was not performed when the peak measured data under the limit of average detection.
5. The emission levels of other frequencies are very lower than the limit and not show in test report.

Product : PanaCast 50
 Test Item : Harmonic Radiated Emission Data
 Test Mode : Mode 1: Transmit (802.11a 6Mbps) (5240MHz)
 Test Date : 2021/02/05

Vertical

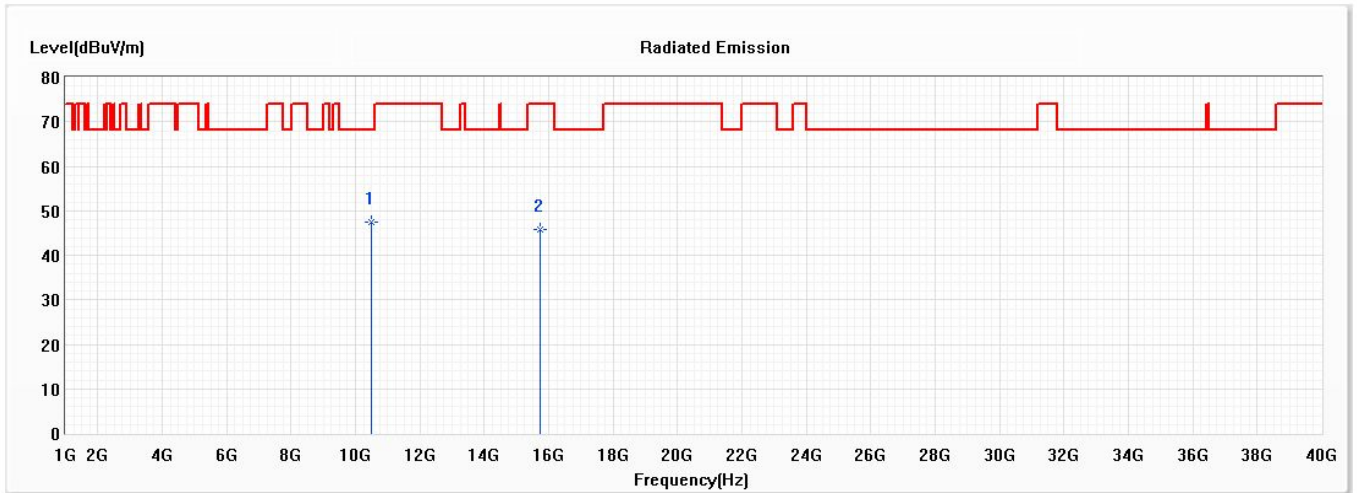

| No | Frequency (MHz) | Emission Level (dBuV/m) | Limit (dBuV/m) | Margin (dB) | Reading Level (dBuV) | Correct Factor (dB) | Detector Type |
|-----|-----------------|-------------------------|----------------|-------------|----------------------|---------------------|---------------|
| * 1 | 10480.000 | 47.46 | 68.22 | -20.76 | 57.34 | -9.88 | PK |
| 2 | 15720.000 | 45.89 | 74.00 | -28.11 | 49.23 | -3.34 | PK |

Note:

1. All Readings below 1GHz are Quasi-Peak, above 1GHz are performed with peak and/or average measurements as necessary.
2. Measurement Level = Reading Level + Correct Factor.
3. Correct Factor = Antenna factor + Cable loss – Amplifier gain.
4. The average measurement was not performed when the peak measured data under the limit of average detection.
5. The emission levels of other frequencies are very lower than the limit and not show in test report.

Product : PanaCast 50
 Test Item : Harmonic Radiated Emission Data
 Test Mode : Mode 1: Transmit (802.11a 6Mbps) (5260MHz)
 Test Date : 2021/02/05

Horizontal

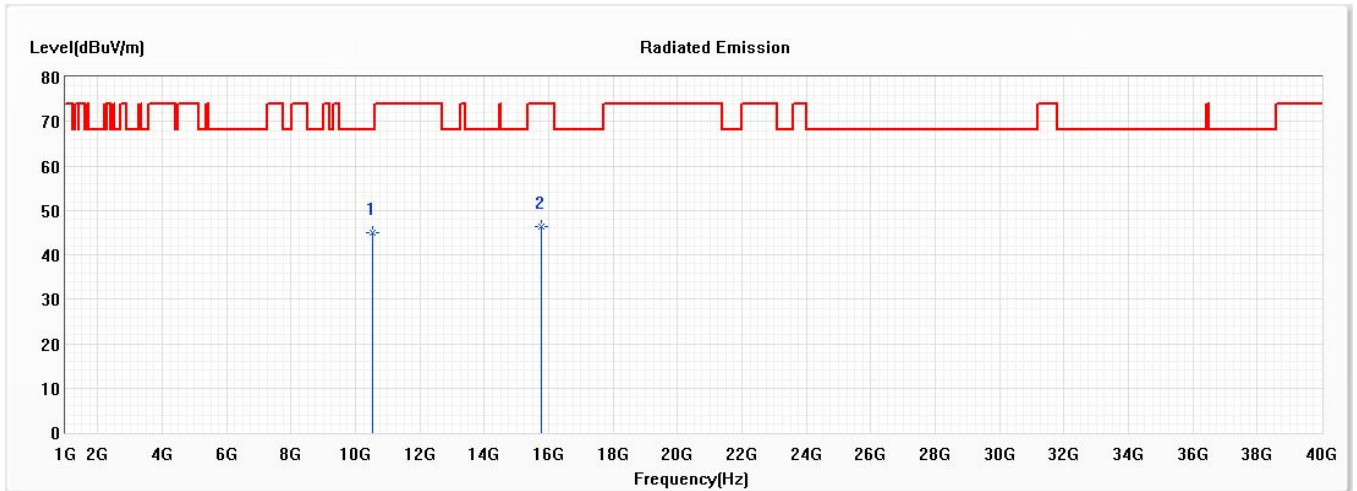

| No | Frequency (MHz) | Emission Level (dBuV/m) | Limit (dBuV/m) | Margin (dB) | Reading Level (dBuV) | Correct Factor (dB) | Detector Type |
|-----|-----------------|-------------------------|----------------|-------------|----------------------|---------------------|---------------|
| * 1 | 10520.000 | 44.97 | 68.22 | -23.25 | 54.87 | -9.90 | PK |
| 2 | 15780.000 | 46.45 | 74.00 | -27.55 | 49.69 | -3.24 | PK |

Note:

1. All Readings below 1GHz are Quasi-Peak, above 1GHz are performed with peak and/or average measurements as necessary.
2. Measurement Level = Reading Level + Correct Factor.
3. Correct Factor = Antenna factor + Cable loss – Amplifier gain.
4. The average measurement was not performed when the peak measured data under the limit of average detection.
5. The emission levels of other frequencies are very lower than the limit and not show in test report.

Product : PanaCast 50
 Test Item : Harmonic Radiated Emission Data
 Test Mode : Mode 1: Transmit (802.11a 6Mbps) (5260MHz)
 Test Date : 2021/02/05

Vertical

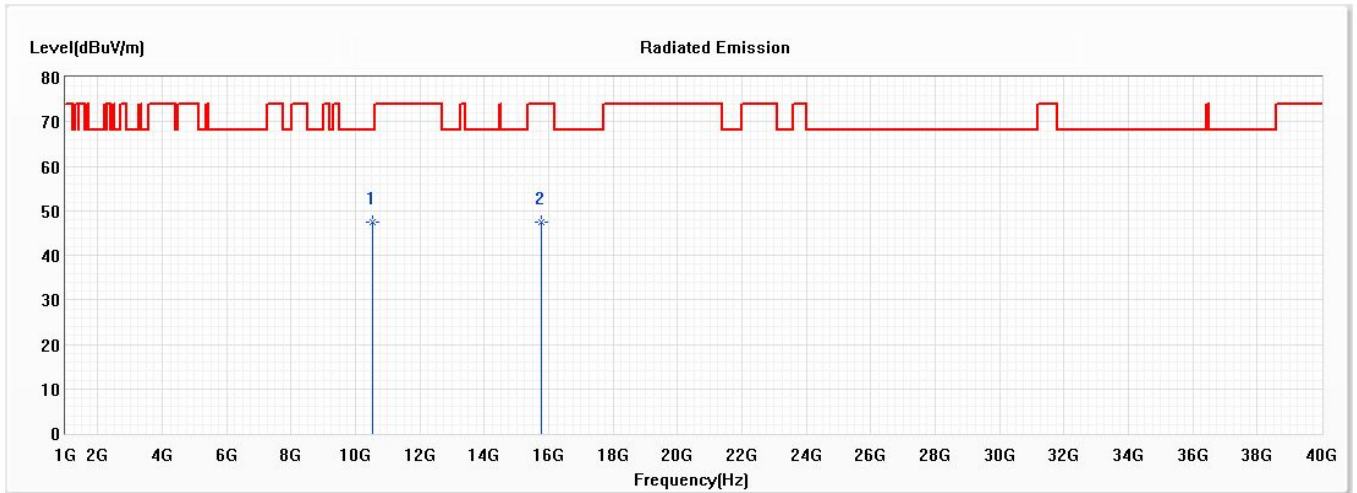

| No | Frequency (MHz) | Emission Level (dBuV/m) | Limit (dBuV/m) | Margin (dB) | Reading Level (dBuV) | Correct Factor (dB) | Detector Type |
|-----|-----------------|-------------------------|----------------|-------------|----------------------|---------------------|---------------|
| * 1 | 10520.000 | 47.51 | 68.22 | -20.71 | 57.41 | -9.90 | PK |
| 2 | 15780.000 | 47.39 | 74.00 | -26.61 | 50.63 | -3.24 | PK |

Note:

1. All Readings below 1GHz are Quasi-Peak, above 1GHz are performed with peak and/or average measurements as necessary.
2. Measurement Level = Reading Level + Correct Factor.
3. Correct Factor = Antenna factor + Cable loss – Amplifier gain.
4. The average measurement was not performed when the peak measured data under the limit of average detection.
5. The emission levels of other frequencies are very lower than the limit and not show in test report.

Product : PanaCast 50
 Test Item : Harmonic Radiated Emission Data
 Test Mode : Mode 1: Transmit (802.11a 6Mbps) (5300MHz)
 Test Date : 2021/02/05

Horizontal

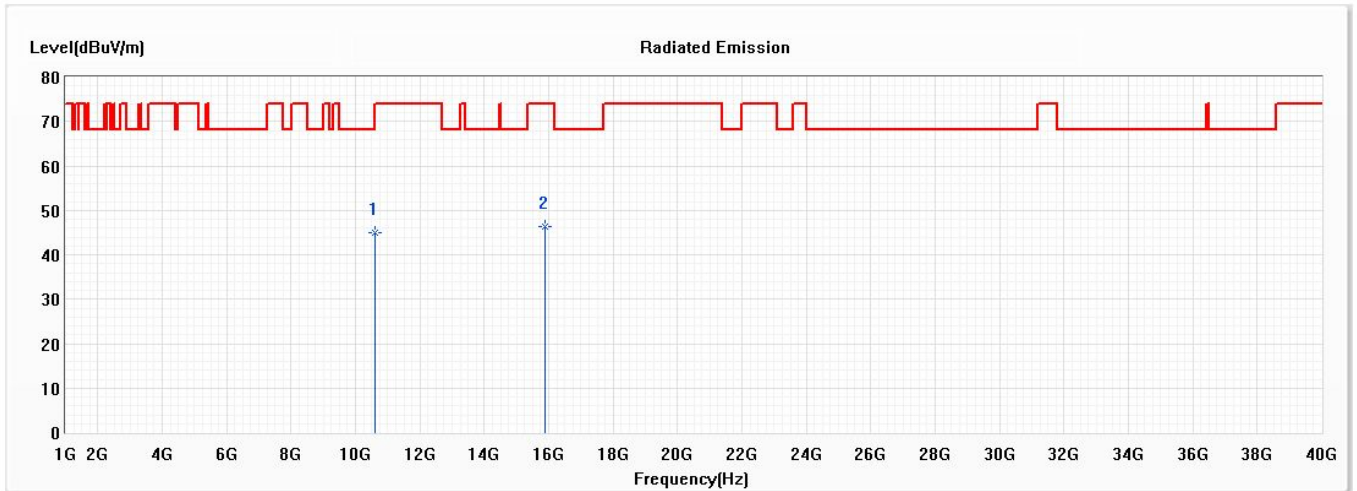

| No | Frequency (MHz) | Emission Level (dBuV/m) | Limit (dBuV/m) | Margin (dB) | Reading Level (dBuV) | Correct Factor (dB) | Detector Type |
|-----|-----------------|-------------------------|----------------|-------------|----------------------|---------------------|---------------|
| 1 | 10600.000 | 44.91 | 74.00 | -29.09 | 54.71 | -9.80 | PK |
| * 2 | 15900.000 | 46.47 | 74.00 | -27.53 | 49.51 | -3.04 | PK |

Note:

1. All Readings below 1GHz are Quasi-Peak, above 1GHz are performed with peak and/or average measurements as necessary.
2. Measurement Level = Reading Level + Correct Factor.
3. Correct Factor = Antenna factor + Cable loss – Amplifier gain.
4. The average measurement was not performed when the peak measured data under the limit of average detection.
5. The emission levels of other frequencies are very lower than the limit and not show in test report.

Product : PanaCast 50
 Test Item : Harmonic Radiated Emission Data
 Test Mode : Mode 1: Transmit (802.11a 6Mbps) (5300MHz)
 Test Date : 2021/02/05

Vertical

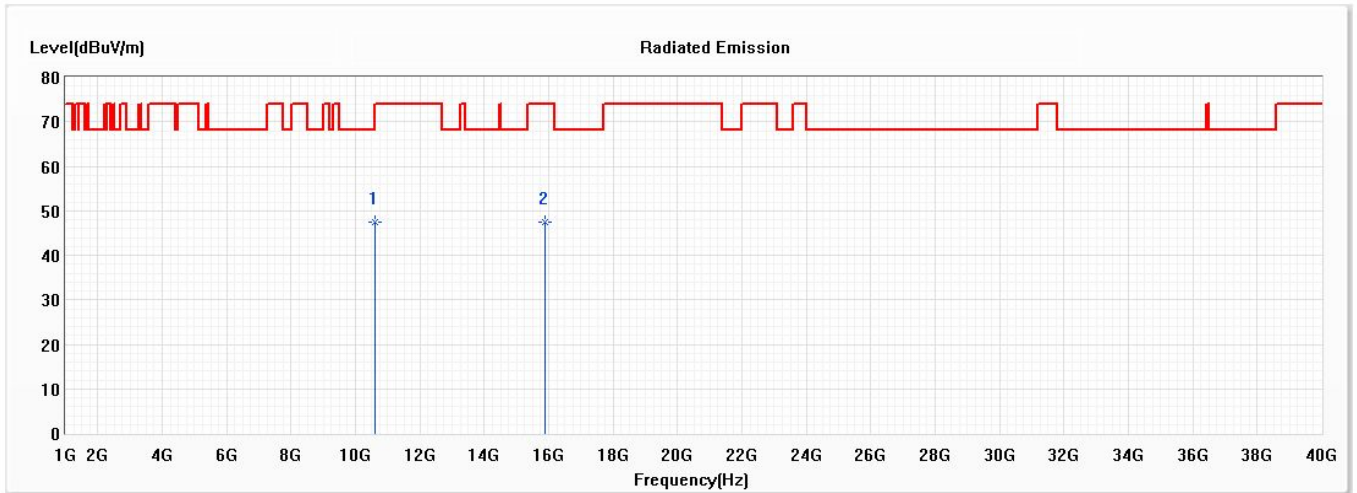

| No | Frequency (MHz) | Emission Level (dBuV/m) | Limit (dBuV/m) | Margin (dB) | Reading Level (dBuV) | Correct Factor (dB) | Detector Type |
|-----|-----------------|-------------------------|----------------|-------------|----------------------|---------------------|---------------|
| * 1 | 10600.000 | 47.58 | 74.00 | -26.42 | 57.38 | -9.80 | PK |
| 2 | 15900.000 | 47.42 | 74.00 | -26.58 | 50.46 | -3.04 | PK |

Note:

1. All Readings below 1GHz are Quasi-Peak, above 1GHz are performed with peak and/or average measurements as necessary.
2. Measurement Level = Reading Level + Correct Factor.
3. Correct Factor = Antenna factor + Cable loss – Amplifier gain.
4. The average measurement was not performed when the peak measured data under the limit of average detection.
5. The emission levels of other frequencies are very lower than the limit and not show in test report.

Product : PanaCast 50
 Test Item : Harmonic Radiated Emission Data
 Test Mode : Mode 1: Transmit (802.11a 6Mbps) (5320MHz)
 Test Date : 2021/02/05

Horizontal

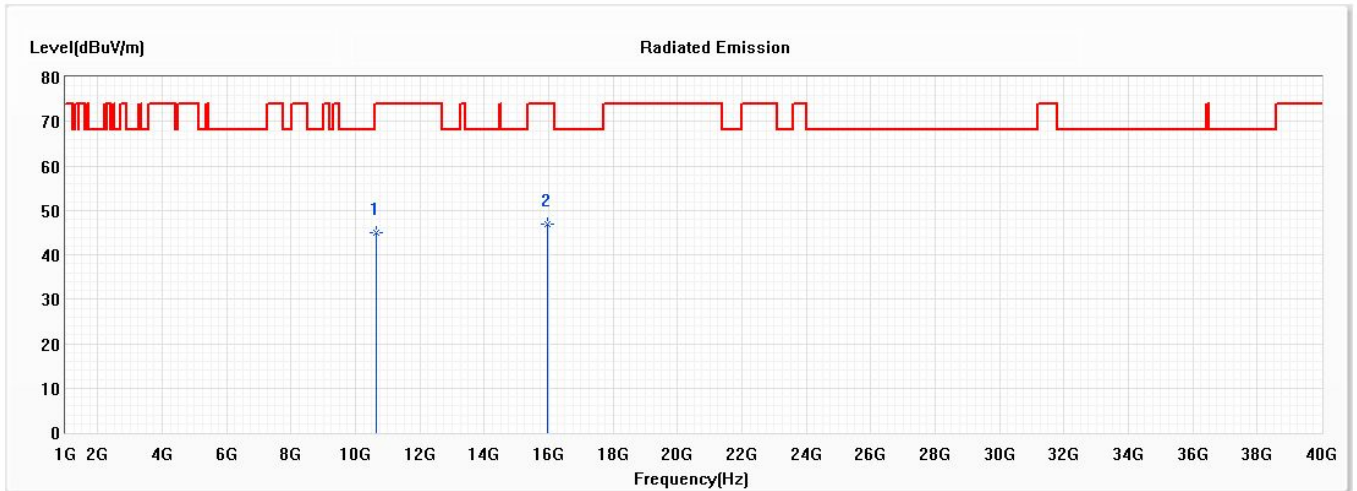

| No | Frequency (MHz) | Emission Level (dBuV/m) | Limit (dBuV/m) | Margin (dB) | Reading Level (dBuV) | Correct Factor (dB) | Detector Type |
|-----|-----------------|-------------------------|----------------|-------------|----------------------|---------------------|---------------|
| 1 | 10640.000 | 45.01 | 74.00 | -28.99 | 54.66 | -9.65 | PK |
| * 2 | 15960.000 | 46.81 | 74.00 | -27.19 | 49.67 | -2.86 | PK |

Note:

1. All Readings below 1GHz are Quasi-Peak, above 1GHz are performed with peak and/or average measurements as necessary.
2. Measurement Level = Reading Level + Correct Factor.
3. Correct Factor = Antenna factor + Cable loss – Amplifier gain.
4. The average measurement was not performed when the peak measured data under the limit of average detection.
5. The emission levels of other frequencies are very lower than the limit and not show in test report.

Product : PanaCast 50
 Test Item : Harmonic Radiated Emission Data
 Test Mode : Mode 1: Transmit (802.11a 6Mbps) (5320MHz)
 Test Date : 2021/02/05

Vertical

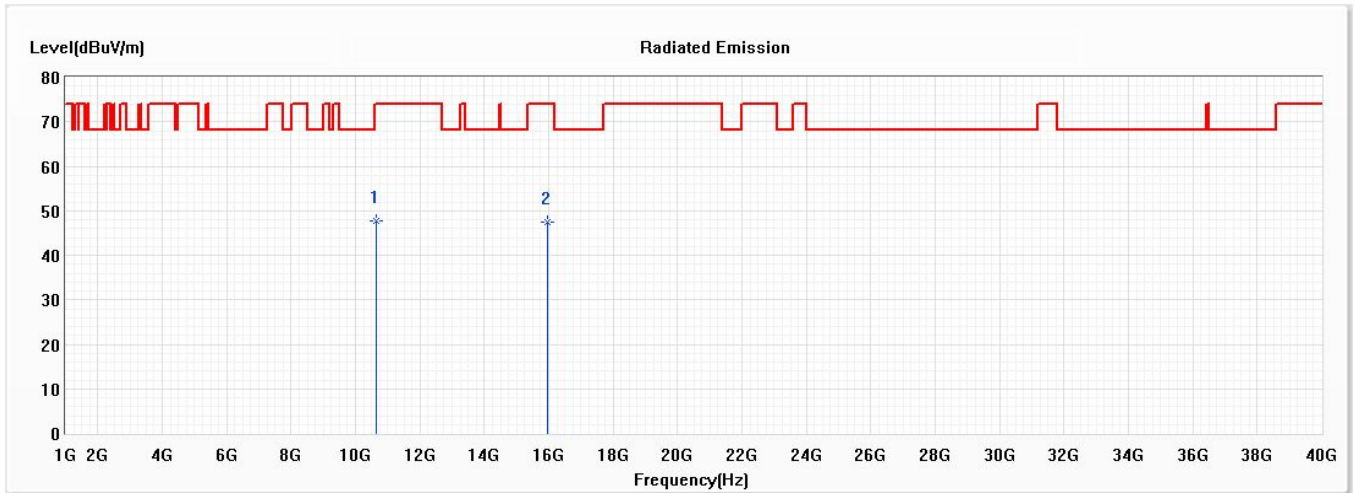

| No | Frequency (MHz) | Emission Level (dBuV/m) | Limit (dBuV/m) | Margin (dB) | Reading Level (dBuV) | Correct Factor (dB) | Detector Type |
|-----|-----------------|-------------------------|----------------|-------------|----------------------|---------------------|---------------|
| * 1 | 10640.000 | 47.64 | 74.00 | -26.36 | 57.29 | -9.65 | PK |
| 2 | 15960.000 | 47.55 | 74.00 | -26.45 | 50.41 | -2.86 | PK |

Note:

1. All Readings below 1GHz are Quasi-Peak, above 1GHz are performed with peak and/or average measurements as necessary.
2. Measurement Level = Reading Level + Correct Factor.
3. Correct Factor = Antenna factor + Cable loss – Amplifier gain.
4. The average measurement was not performed when the peak measured data under the limit of average detection.
5. The emission levels of other frequencies are very lower than the limit and not show in test report.

Product : PanaCast 50
 Test Item : Harmonic Radiated Emission Data
 Test Mode : Mode 1: Transmit (802.11a 6Mbps) (5500MHz)
 Test Date : 2021/02/05

Horizontal

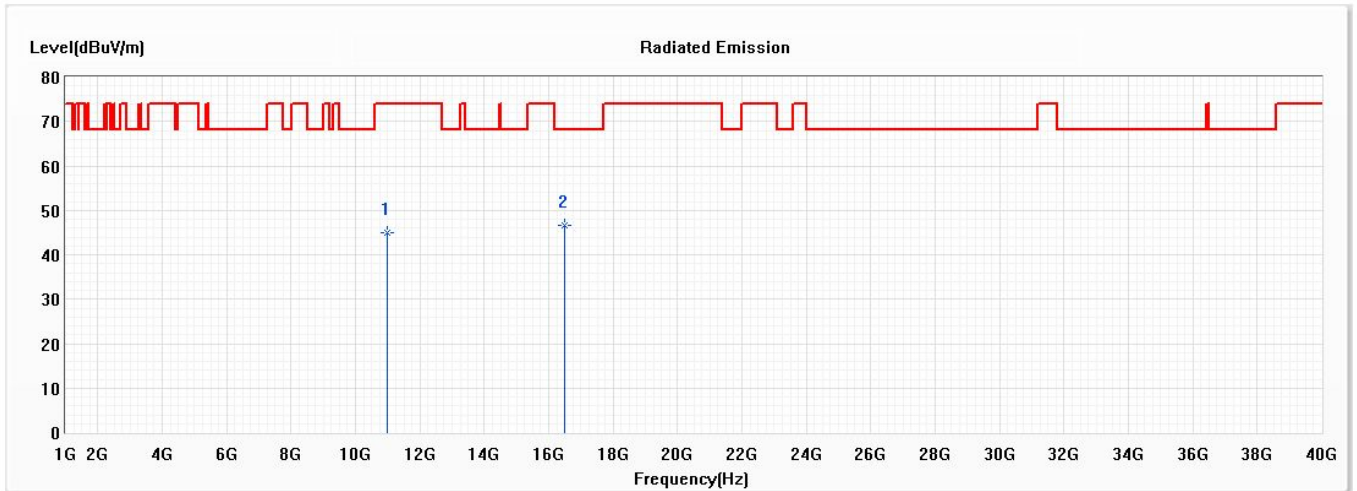

| No | Frequency (MHz) | Emission Level (dBuV/m) | Limit (dBuV/m) | Margin (dB) | Reading Level (dBuV) | Correct Factor (dB) | Detector Type |
|-----|-----------------|-------------------------|----------------|-------------|----------------------|---------------------|---------------|
| 1 | 11000.000 | 45.02 | 74.00 | -28.98 | 54.05 | -9.03 | PK |
| * 2 | 16500.000 | 46.49 | 68.22 | -21.73 | 47.78 | -1.29 | PK |

Note:

1. All Readings below 1GHz are Quasi-Peak, above 1GHz are performed with peak and/or average measurements as necessary.
2. Measurement Level = Reading Level + Correct Factor.
3. Correct Factor = Antenna factor + Cable loss – Amplifier gain.
4. The average measurement was not performed when the peak measured data under the limit of average detection.
5. The emission levels of other frequencies are very lower than the limit and not show in test report.

Product : PanaCast 50
 Test Item : Harmonic Radiated Emission Data
 Test Mode : Mode 1: Transmit (802.11a 6Mbps) (5500MHz)
 Test Date : 2021/02/05

Vertical

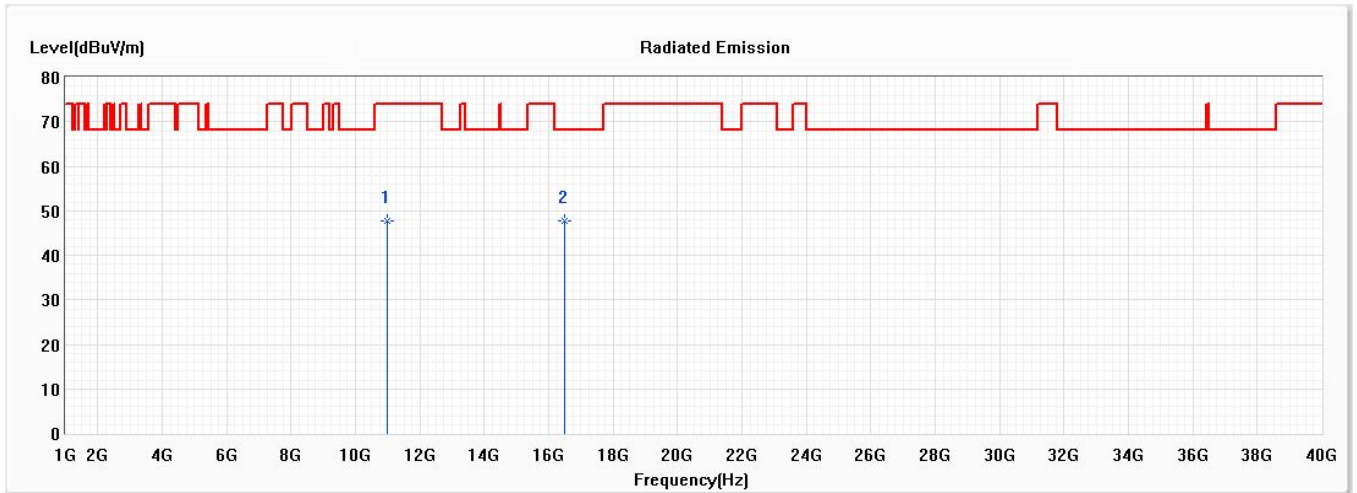

| No | Frequency (MHz) | Emission Level (dBuV/m) | Limit (dBuV/m) | Margin (dB) | Reading Level (dBuV) | Correct Factor (dB) | Detector Type |
|-----|-----------------|-------------------------|----------------|-------------|----------------------|---------------------|---------------|
| 1 | 11000.000 | 47.67 | 74.00 | -26.33 | 56.70 | -9.03 | PK |
| * 2 | 16500.000 | 47.64 | 68.22 | -20.58 | 48.93 | -1.29 | PK |

Note:

1. All Readings below 1GHz are Quasi-Peak, above 1GHz are performed with peak and/or average measurements as necessary.
2. Measurement Level = Reading Level + Correct Factor.
3. Correct Factor = Antenna factor + Cable loss – Amplifier gain.
4. The average measurement was not performed when the peak measured data under the limit of average detection.
5. The emission levels of other frequencies are very lower than the limit and not show in test report.

Product : PanaCast 50
 Test Item : Harmonic Radiated Emission Data
 Test Mode : Mode 1: Transmit (802.11a 6Mbps) (5580MHz)
 Test Date : 2021/02/05

Horizontal

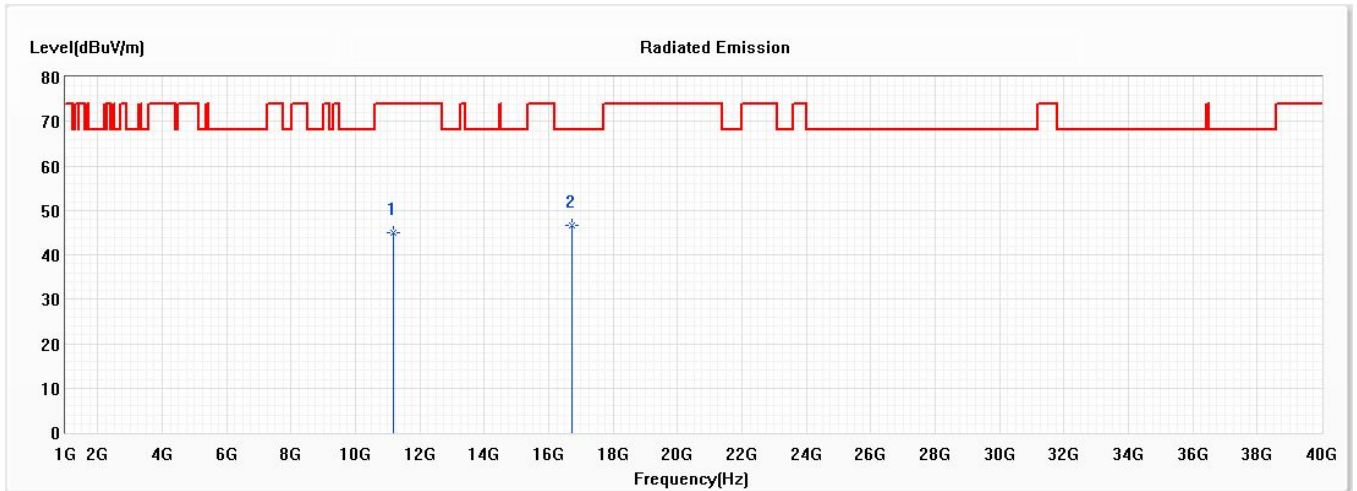

| No | Frequency (MHz) | Emission Level (dBuV/m) | Limit (dBuV/m) | Margin (dB) | Reading Level (dBuV) | Correct Factor (dB) | Detector Type |
|-----|-----------------|-------------------------|----------------|-------------|----------------------|---------------------|---------------|
| 1 | 11160.000 | 45.06 | 74.00 | -28.94 | 54.01 | -8.95 | PK |
| * 2 | 16740.000 | 46.61 | 68.22 | -21.61 | 47.30 | -0.69 | PK |

Note:

1. All Readings below 1GHz are Quasi-Peak, above 1GHz are performed with peak and/or average measurements as necessary.
2. Measurement Level = Reading Level + Correct Factor.
3. Correct Factor = Antenna factor + Cable loss – Amplifier gain.
4. The average measurement was not performed when the peak measured data under the limit of average detection.
5. The emission levels of other frequencies are very lower than the limit and not show in test report.