



Test report No.: 23A0523R-SAUSV01S-A

SAR Test Report

Product Name	Bluetooth USB Dongle
Trademark	Jabra
Model and /or type reference	END080W
Applicant's name / address	GN Audio USA Inc. 900 Chelmsfort St, Tower 2, Floor 8 , Lowell, Massachusetts, 1851 United States
Manufacturer's name	GN Audio USA Inc.
FCC ID	BCE-END080W
Applicable Standard	IEEE 1528-2013 KDB 447498 D01 v06 KDB 865664 D01 v01r04
Test Result	Max. SAR Measurement (1g) BT: 0.205 W/kg
Verdict Summary	IN COMPLIANCE
Documented By (Senior Project Specialist / April Chen)	<i>April Chen</i>
Tested By (Senior Engineer / Luke Cheng)	<i>luke cheng</i>
Approved By (Assistant Manager / San Lin)	<i>San Lin</i>
Date of Receipt	2023/10/21
Date of Issue	2024/03/01
Report Version	V1.0

INDEX

	Page
1. General Information	5
1.1 EUT Description	5
1.2 Antenna List	5
1.3 Test Environment.....	6
1.4 Measurement procedures.....	7
2. SAR Measurement System	8
2.1 DASY System Description.....	8
2.2 Area Scans.....	9
2.3 DASY E-Field Probe.....	10
2.4 DATA Acquisition Electronics (DAE) and Measurement Server	11
2.5 Robot.....	11
2.6 Device Holder.....	12
2.7 Phantom	12
3. Tissue Simulating Liquid	13
3.1 The composition of the tissue simulating liquid	13
3.2 Tissue Calibration Result.....	13
3.3 Tissue Dielectric Parameters for Phantoms	14
4. Measurement Procedure.....	15
4.1 SAR System Check.....	15
4.2 SAR Measurement Procedure.....	16
5. RF Exposure Limits.....	17
6. Test Equipment List	18
7. Measurement Uncertainty.....	19
8. Conducted Power Measurement (Including tolerance allowed for production unit)	21
9. Test Results	22
9.1 Test Results Summary	22
Appendix A. System Check Data	
Appendix B. Highest measurement Data	
Appendix C. Test Setup Photographs	
Appendix D. Probe Calibration Data	
Appendix E. Dipole & Source Calibration	
Appendix F. Product Photos-Please refer to the file: 23A0523R-Product Photos	

Competences and Guarantees

DEKRA is a testing laboratory competent to carry out the tests described in this report.

In order to assure the traceability to other national and international laboratories, DEKRA has a calibration and maintenance program for its measurement equipment.

DEKRA guarantees the reliability of the data presented in this report, which is the result of the measurements and the tests performed to the item under test on the date and under the conditions stated in the report and it is based on the knowledge and technical facilities available at DEKRA at the time of performance of the test.

DEKRA is liable to the client for the maintenance of the confidentiality of all information related to the item under test and the results of the test.

The results presented in this Test Report apply only to the particular item under test established in this document.

IMPORTANT: No parts of this report may be reproduced or quoted out of context, in any form or by any means, except in full, without the previous written permission of DEKRA.

General conditions

1. The test results relate only to the samples tested.
2. The test results shown in the test report are traceable to the national/international standard through the calibration report of the equipment and evaluated measurement uncertainty herein.
3. This report must not be used to claim product endorsement by TAF or any agency of the government.
4. The test report shall not be reproduced without the written approval of DEKRA Testing and Certification Co., Ltd.
5. Measurement uncertainties evaluated for each testing system and associated connections are given here to provide the system information for reference. Compliance determinations do not take into account measurement uncertainties for each testing system, but are based on the results of the compliance measurement.

Revision History

Report No.	Version	Description	Issued Date
23A0523R-SAUSV01S-A	V1.0	Initial issue of report.	2024/03/01

1. General Information

1.1 EUT Description

Product Name	Bluetooth USB Dongle
Trademark	Jabra
Model and /or type reference	END080W
FCC ID	BCE-END080W
Frequency Range	BT: 2402-2480MHz
Type of Modulation	GFSK(1Mbps) / π / 4DQPSK(2Mbps) / 8DPSK(3Mbps)
Device Category	Portable
RF Exposure Environment	Uncontrolled

1.2 Antenna List

No.	Manufacturer	Part No.	Antenna Type	Peak Gain
1	GN Audio A/S	50-09054	Stamp	4.44 dBi for 2400 MHz

Note: The above EUT information by manufacturer.

1.3 Test Environment

Ambient conditions in the laboratory:

Test Date: 2023/11/13

Items	Required	Actual
Temperature (°C)	18-25	23 ± 2
Humidity (%RH)	30-70	50 ± 20

USA	FCC Registration Number: TW0033
Canada	CAB Identifier Number: TW3023 / Company Number: 26930

Site Description	Accredited by TAF
	Accredited Number: 3023

Test Laboratory	DEKRA Testing and Certification Co., Ltd.
	Linkou Laboratory
Address	No.5-22, Ruishukeng Linkou District, New Taipei City, 24451, Taiwan, R.O.C
Performed Location	No. 26, Huaya 1st Rd., Guishan Dist., Taoyuan City 333411, Taiwan, R.O.C.
Phone Number	+886-3-275-7255
Fax Number	+886-3-327-8031

1.4 Measurement procedures

IEEE 1528-2013

47CFR § 2.1093

KDB 248227 D01 v02r02

KDB 447498 D01 v06

KDB 447498 D02 v02r01

KDB 865664 D01 v01r04

2. SAR Measurement System

2.1 DASY System Description

SAR Configurations is shown below:

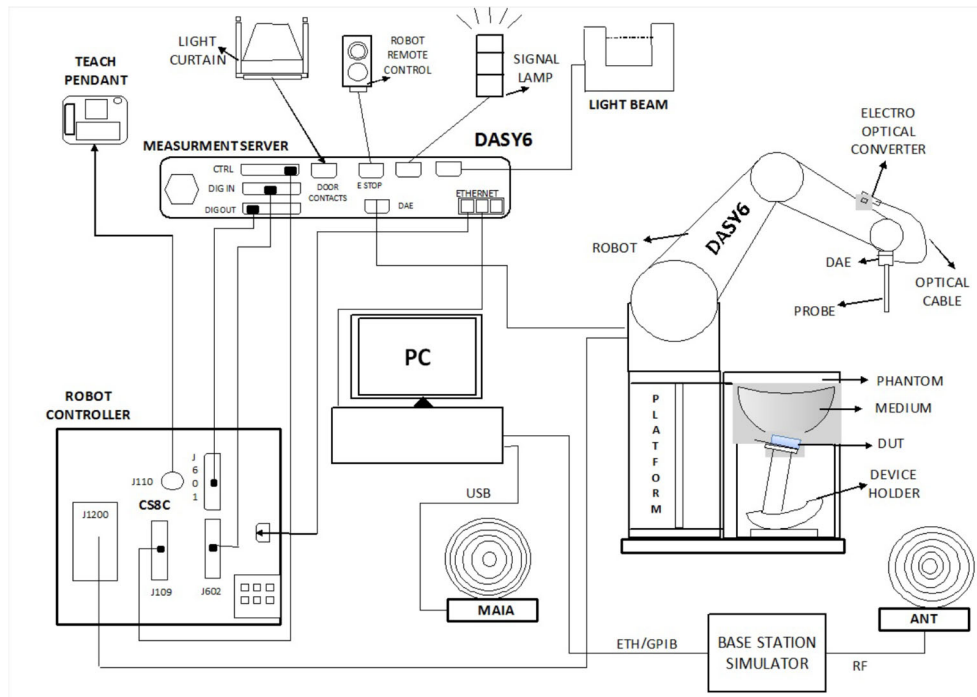

The DASY system for performing compliance tests consists of the following items:

- A standard high precision 6-axis robot with controller, teach pendant and software. An arm extension for accommodating the data acquisition electronics (DAE).
- A data acquisition electronics (DAE) which performs the signal amplification, signal multiplexing, AD-conversion, offset measurements, mechanical surface detection, collision detection, etc. The unit is battery powered with standard or rechargeable batteries. The signal is optically transmitted to the EOC.
- The Electro-optical converter (EOC) performs the conversion from optical to electrical signals for the digital communication to the DAE. To use optical surface detection, a special version of the EOC is required. The EOC signal is transmitted to the measurement server.
- The Light Beam used is for probe alignment. This improves the (absolute) accuracy of the probe positioning.
- A computer running Win7/8/10 and the DASY software.
- Remote control and teach pendant as well as additional circuitry for robot safety such as warning lamps, etc.
- The phantom, the device holder and other accessories according to the targeted measurement.

2.2 Area Scans

Area scans are defined prior to the measurement process being executed with a user defined variable spacing between each measurement point (integral) allowing low uncertainty measurements to be conducted. Scans defined for utilize a 10mm² step integral, with 1mm interpolation used to locate the peak SAR area used for zoom scan assessments.

When an Area Scan has measured all reachable points, it computes the field maxima found in the scanned area, within a range of the global maximum. The range (in dB) is specified in the standards for compliance testing.

2.2.1 Zoom Scan (Cube Scan Averaging)

Zoom Scans are used to assess the peak spatial SAR values within a cubic averaging volume containing 1 g and 10 g of simulated tissue. A density of 1000 kg/m³ is used to represent the head and body tissue density and not the phantom liquid density, in order to be consistent with the definition of the liquid dielectric properties, i.e. the side length of the 1 g cube is 10mm, with the side length of the 10 g cube 21,5mm.

The zoom scan integer steps can be user defined so as to reduce uncertainty, but normal practice for typical test applications utilize a physical step of 5x5x7 (8mmx8mmx5mm) providing a volume of 32mm in the X & Y axis, and 30mm in the Z axis.

2.2.2 SAR measurement drifts

Before an area scan and after the zoom scan, single point SAR measurements are performed at defined locations to estimate the SAR measurement drift due to device output power variations. If a device is known to drift randomly, additional single point drift reference measurements should be performed at regular intervals throughout the area and zoom scan test durations. The SAR drift shall be kept within $\pm 5\%$, whether there are substantial drifts or not. The field difference will be calculated in dB units in the DASY software.

2.2.3 Uncertainty of Inter-/Extrapolation and Averaging

In order to evaluate the uncertainty of the interpolation, extrapolation and averaged SAR calculation algorithms of the Postprocessor, DASY allows the generation of measurement grids which are artificially predefined by analytically based test functions. Therefore, the grids of area scans and zoom scans can be filled with uncertainty test data, according to the SAR benchmark functions.

2.3 DASY E-Field Probe

The SAR measurement is conducted with the dosimetric probe manufactured by SPEAG. The probe is specially designed and calibrated for use in liquid with high permittivity. The dosimetric probe has special calibration in liquid at different frequency.

SPEAG conducts the probe calibration in compliance with international and national standards under ISO 17025. The calibration data are in Appendix D.

Isotropic E-Field Probe Specification

Model	Ex3DV4	
Construction	Symmetrical design with triangular core Built-in shielding against static charges PEEK enclosure material (resistant to organic solvents, e.g., DGBE)	
Frequency	4 MHz – 10 GHz Linearity: ± 0.2 dB (30 MHz to 10 GHz)	
Directivity	± 0.1 dB in TSL (rotation around probe axis) ± 0.3 dB in TSL (rotation normal to probe axis)	
Dynamic Range	10 μ W/g to 100 mW/g Linearity: ± 0.2 dB (noise: typically < 1 μ W/g)	
Dimensions	Overall length: 337 mm (Tip: 20 mm) Tip diameter: 2.5 mm (Body: 12 mm) Typical distance from probe tip to dipole centers: 1 mm	
Application	High precision dosimetric measurements in any exposure scenario (e.g., very strong gradient fields). Only probe which enables compliance testing for frequencies up to 6 GHz with precision of better 30%.	

2.4 DATA Acquisition Electronics (DAE) and Measurement Server

The data acquisition electronics (DAE) consists of a highly sensitive electrometer-grade preamplifier with auto-zeroing, a channel and gain-switching multiplexer, a fast 16-bit AD-converter and a command decoder and control logic unit.

Transmission to the measurement server is accomplished through an optical downlink for data and status information as well as an optical uplink for commands and the clock.

The input impedance of the DAE4 is 200M Ohm; the inputs are symmetrical and floating. Common mode rejection is above 80dB.



2.5 Robot

The DASY system uses the high precision robots TX90 XL type out of the newer series from Stäubli SA (France). For the 6-axis controller DASY system, the CS8C robot controller version from Stäubli is used.

The XL robot series have many features that are important for our application:

- High precision (repeatability 0.02 mm)
- High reliability (industrial design)
- Jerk-free straight movements
- Low ELF interference (the closed metallic construction shields against motor control fields)
- 6-axis controller



2.6 Device Holder

The DASY device holder is designed to cope with different positions given in the standard. It has two scales for the device rotation (with respect to the body axis) and the device inclination (with respect to the line between the ear reference points). The rotation center for both scales is the ear reference point (EPR).

Thus the device needs no repositioning when changing the angles.

The DASY device holder has been made out of low-loss POM material having the following dielectric parameters: relative permittivity $\epsilon_r = 3$ and loss tangent $\delta = 0.02$. The amount of dielectric material has been reduced in the closest vicinity of the device, since measurements have suggested that the influence of the clamp on the test results could thus be lowered.

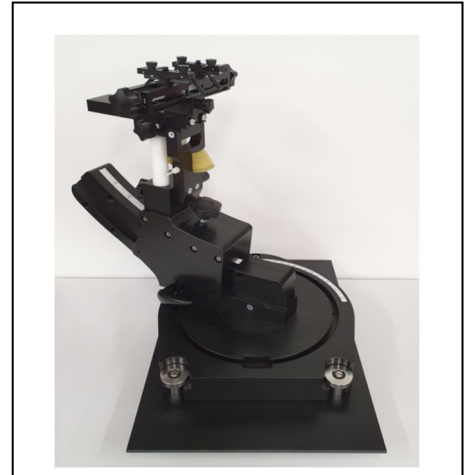

2.7 Phantom

2.7.1 SAM Twin Phantom

The SAM twin phantom is a fiberglass shell phantom with 2mm shell thickness (except the ear region where shell thickness increases to 6mm).

It has three measurement areas:

- Left head
- Right head
- Flat phantom

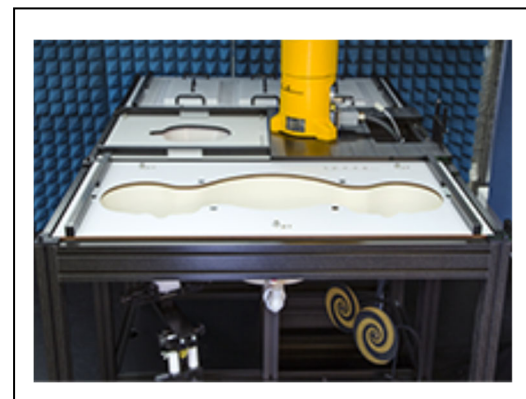

The device holder positions are adjusted to the standard measurement positions in the three sections. A cover is provided to tap the phantom during off-periods to prevent water evaporation and changes in the liquid parameters. On the phantom top, three reference markers are provided to identify the phantom position with respect to the robot.

3. Tissue Simulating Liquid

3.1 The composition of the tissue simulating liquid

Description: Aqueous solution with surfactants and inhibitors

Declarable, or hazardous components:

CAS: 107-21-1 EINECS: 203-473-3 Reg.nr.: 01-2119456816-28-0000	Ethenediol STOT RE 2, H373; Acute Tox. 4, H302	< 5.2%
CAS: 68608-26-4 EINECS: 271-781-5 Reg.nr.: 01-2119527859-22-0000	Sodium petroleum sulfonate Eye Irrit. 2, H319	< 2.9%
CAS: 107-41-5 EINECS: 203-489-0 Reg.nr.: 01-2119539582-35-0000	Hexylene Glycol / 2-Methyl-pentane-2,4-diol Skin Irrit. 2, H315; Eye Irrit. 2, H319	< 2.9%
CAS: 68920-66-1 NLP: 500-236-9 Reg.nr.: 01-2119489407-26-0000	Alkoxylated alcohol, > C₁₆ Aquatic Chronic 2, H411; Skin Irrit. 2, H315; Eye Irrit. 2, H319	< 2.0%

3.2 Tissue Calibration Result

The dielectric parameters of the liquids were verified prior to the SAR evaluation using Dielectric Probe Kit and Vector Network Analyzer.

Date	Tissue Type	Frequency (MHz)	Relative Permittivity (ϵ_r)			Conductivity (σ)			Tissue Temp. (°C)
			Measured	Target	Delta (%)	Measured	Target	Delta (%)	
2023/11/13	Head	2450	39.92	39.20	1.84	1.80	1.80	0.00	22.4
		2402	40.10	39.30	2.04	1.74	1.76	-1.14	
		2441	39.95	39.22	1.86	1.78	1.79	-0.56	
		2480	39.80	39.16	1.63	1.83	1.83	0.00	

3.3 Tissue Dielectric Parameters for Phantoms

The head tissue dielectric parameters recommended by the IEC/IEEE 62209-1528 have been incorporated in the following table. These head parameters are derived from planar layer models simulating the highest expected SAR for the dielectric properties and tissue thickness variations in a human head. Other head tissue parameters that have not been specified are interpolated according to the head parameters specified in IEC/IEEE 62209-1528.

Target Frequency (MHz)	Head	
	ϵ_r	σ (S/m)
450	43.5	0.87
750	41.9	0.89
835	41.5	0.90
900	41.5	0.97
1450	40.5	1.20
1640	40.2	1.31
1750	40.1	1.37
1800 – 2000	40.0	1.40
2450	39.2	1.80
3000	38.5	2.40
5000	36.2	4.45
5200	36.0	4.66
5400	35.8	4.86
5600	35.3	5.27
5800	35.3	5.27
6000	35.1	5.48
6500	34.5	6.07
7000	33.9	6.65
7500	33.3	7.24

4. Measurement Procedure

4.1 SAR System Check

4.1.1 Dipoles



The SAR dipoles are optimized symmetrical dipole with $\lambda/4$ balun matched to a Flat phantom section filled with tissue simulating liquids. The center conductor of the feeding line is directly connected to the second arm of the dipole. The antenna is therefore short-circuited for DC signals. They are available for the variety of frequencies between 300MHz and 10 GHz. The provided tripod is used to hold the dipole below the phantom. As the distance between the dipole center and the TSL is critical, a spacer is placed between the dipole and the phantom. The spacing distance is frequency dependent.

4.1.2 SAR System Check Result

1. Comparing to the original SAR value provided by SPEAG, the verification data should be within its specification of 10 %.
2. Below table shows the target SAR and measured SAR after normalized to 1W input power. The table below indicates the system performance check can meet the variation criterion and the plots can be referred to Appendix A of this report.

Date	Frequency (MHz)	Input Power (mW)	Measured 1g SAR (W/kg)	Targeted 1g SAR (W/kg)	Normalized 1g SAR (W/kg)	Delta 1g (%)	Measured 10g SAR (W/kg)	Targeted 10g SAR (W/kg)	Normalized 10g SAR (W/kg)	Delta 10g (%)	Tissue Temp. (°C)
2023/11/13	2450	250	13.20	52.40	52.8	0.76	6.16	24.60	24.64	0.16	22.4

4.2 SAR Measurement Procedure

The Dasy calculates SAR using the following equation,

$$\text{SAR} = \frac{\sigma |E|^2}{\rho}$$

Where :

σ : represents the simulated tissue conductivity

ρ : represents the tissue density

E :RMS electric field strength (V/m)

The SAR / APD measurements for the EUT should be performed on the channel that produces the highest rated output power of each transmitting antenna.

Pre-scans are made on the device to establish the location for the transmitting antenna, using a large area scan in either air or tissue simulation fluid.

The EUT is placed against the Universal Phantom where the maximum area scan dimensions are larger than the physical size of the resonating antenna. When the scan size is not large enough to cover the peak SAR / APD distribution, it is modified by either extending the area scan size in both the X and Y directions, or the device is shifted within the predefined area.

The area scan is then run to establish the peak SAR / APD location (interpolated resolution set at 1mm²) which is then used to orient the center of the zoom scan. The zoom scan is then executed and the 1g and 10g averages are derived from the zoom scan volume (interpolated resolution set at 1mm³).

5. RF Exposure Limits

SAR assessments have been made in line with the requirements of IEEE-1528, RSS-102 Issue 5, and comply with ANSI/IEEE C95.1-1992 “Uncontrolled Environments” limits. These limits apply to a location which is deemed as “Uncontrolled Environment” which can be described as a situation where the general public may be exposed to an RF source with no prior knowledge or control over their exposure.

Limits for General Population/Uncontrolled Exposure (W/kg)

Type Exposure	Uncontrolled Environment Limit
Spatial Peak SAR (1g cube tissue for brain or body)	1.60 W/kg
Spatial Average SAR (whole body)	0.08 W/kg
Spatial Peak SAR (10g for hands, feet, ankles and wrist)	4.00 W/kg

6. Test Equipment List

Instrument	Manufacturer	Model No.	Serial No.	Last Calibration	Next Calibration
Reference Dipole 2450MHz	Speag	D2450V2	930	2022/11/21	2025/11/20
Device Holder	Speag	N/A	N/A	N/A	N/A
Data Acquisition Electronic	Speag	DAE4	1651	2023/02/22	2024/02/21
E-Field Probe	Speag	EX3DV4	7631	2023/02/22	2024/02/21
SAR Software	Speag	DASY52	V52.10.4.1535	N/A	N/A
Power Amplifier	Mini-Circuit	ZVE-8G+	447202211	N/A	N/A
Directional Coupler	Agilent	87300C	MY44300353	N/A	N/A1
Attenuator	Woken	WATT-218FS-10	N/A	N/A	N/A1
Attenuator	Mini-Circuit	BW-S20W2+	N/A	N/A	N/A1
Vector Network Analyzer	Agilent	E5071C	MY46108013	2023/03/09	2024/03/08
Signal Generator	Anritsu	MG3694A	041902	2023/09/07	2024/09/06
Power Meter	Anritsu	ML2495A	1434004	2022/12/22	2023/12/21
Power Sensor	Anritsu	MA2411B	1339196	2022/12/22	2023/12/21

Note: 1. System Check, the path loss measured by the network analyzer, includes the signal generator, amplifier, cable, attenuator and directional coupler.

7. Measurement Uncertainty

Measurement uncertainty for 300 MHz to 3 GHz							
Error Description	Uncert. value	Prob. Dist.	Div.	(ci) 1g	(ci) 10g	Std. Unc. (1g)	Std. Unc. (10g)
Measurement System Errors							
Probe Calibration	±12.0%	N	2	1	1	±6.0%	±6.0%
Probe Calibration Drift	±1.7%	R	1.732	1	1	±1.0%	±1.0%
Probe Linearity	±4.7%	R	1.732	1	1	±2.7%	±2.7%
Broadband Signal	±2.8%	R	1.732	1	1	±1.6%	±1.6%
Probe Isotropy	±7.6%	R	1.732	1	1	±4.4%	±4.4%
Other Probe+Electronic	±0.8%	N	1	1	1	±0.8%	±0.8%
RF Ambient	±1.8%	N	1	1	1	±1.8%	±1.8%
Probe Positioning	±0.006 mm	N	1	0.14	0.14	±0.1%	±0.1%
Data Processing	±1.2%	N	1	1	1	±1.2%	±1.2%
Phantom and Device Errors							
Conductivity (meas.)	±2.5%	N	1	0.78	0.71	±2.0%	±1.8%
Conductivity (temp.)	±3.3%	R	1.732	0.78	0.71	±1.5%	±1.4%
Phantom Permittivity	±14.0%	R	1.732	0	0	±0.0%	±0.0%
Distance DUT - TSL	±2.0%	N	1	2	2	±4.0%	±4.0%
Device Positioning	±1.0%	N	1	1	1	±1.0%	±1.0%
Device Holder	±3.6%	N	1	1	1	±3.6%	±3.6%
DUT Modulation	±2.4%	R	1.732	1	1	±1.4%	±1.4%
Time-average SAR	±1.7%	R	1.732	1	1	±1.0%	±1.0%
DUT drift	±2.5%	N	1	1	1	±2.5%	±2.5%
Val Antenna Unc.	±0.0%	N	1	1	1	±0.0%	±0.0%
Unc. Input Power	±0.0%	N	1	1	1	±0.0%	±0.0%
Correction to the SAR results							
Deviation to Target	±1.9%	N	1	1	0.84	±1.9%	±1.6%
SAR scaling	±0.0%	R	1.732	1	1	±0.0%	±0.0%
Combined Uncertainty						±11.0%	±10.9%
Expanded Uncertainty						±21.9%	±21.7%

Measurement uncertainty for 3 GHz to 6 GHz							
Error Description	Uncert. value	Prob. Dist.	Div.	(ci) 1g	(ci) 10g	Std. Unc. (1g)	Std. Unc. (10g)
Measurement System Errors							
Probe Calibration	±14.0%	N	2	1	1	±7.0%	±7.0%
Probe Calibration Drift	±1.7%	R	1.732	1	1	±1.0%	±1.0%
Probe Linearity	±4.7%	R	1.732	1	1	±2.7%	±2.7%
Broadband Signal	±2.6%	R	1.732	1	1	±1.5%	±1.5%
Probe Isotropy	±7.6%	R	1.732	1	1	±4.4%	±4.4%
Other Probe+Electronic	±1.2%	N	1	1	1	±1.2%	±1.2%
RF Ambient	±1.8%	N	1	1	1	±1.8%	±1.8%
Probe Positioning	±0.005 mm	N	1	0.29	0.29	±0.2%	±0.2%
Data Processing	±2.3%	N	1	1	1	±2.3%	±2.3%
Phantom and Device Errors							
Conductivity (meas.)	±2.5%	N	1	0.78	0.71	±2.0%	±1.8%
Conductivity (temp.)	±3.4%	R	1.732	0.78	0.71	±1.5%	±1.4%
Phantom Permittivity	±14.0%	R	1.732	0.25	0.25	±2.0%	±2.0%
Distance DUT - TSL	±2.0%	N	1	2	2	±4.0%	±4.0%
Device Positioning	±1.0%	N	1	1	1	±1.0%	±1.0%
Device Holder	±3.6%	N	1	1	1	±3.6%	±3.6%
DUT Modulation	±2.4%	R	1.732	1	1	±1.4%	±1.4%
Time-average SAR	±1.7%	R	1.732	1	1	±1.0%	±1.0%
DUT drift	±2.5%	N	1	1	1	±2.5%	±2.5%
Val Antenna Unc.	±0.0%	N	1	1	1	±0.0%	±0.0%
Unc. Input Power	±0.0%	N	1	1	1	±0.0%	±0.0%
Correction to the SAR results							
Deviation to Target	±1.9%	N	1	1	0.84	±1.9%	±1.6%
SAR scaling	±0.0%	R	1.732	1	1	±0.0%	±0.0%
Combined Uncertainty						±11.9%	±11.8%
Expanded Uncertainty						±23.8%	±23.6%

8. Conducted Power Measurement (Including tolerance allowed for production unit)

BT						
Bluetooth mode maximum output power	Frequency	Mode	Modulation	SISO-Main		
				CH	Average Power (dBm)	Tune-Up Power (dBm)
Bluetooth mode maximum output power	BT 2.4GHz	BR	GFSK	0	11.24	11.5
				39	11.34	11.5
				78	11.39	11.5
		EDR	8DPSK	0	8.6	9
				39	8.78	9
				78	8.9	9
		BLE	GFSK	0	4.73	5.5
				19	4.9	5.5
				39	5.21	5.5

9. Test Results

9.1 Test Results Summary

SAR MEASUREMENT								
Ambient Temperature (°C): 23.5 ±2					Relative Humidity (%): 51%			
Liquid Temperature (°C): 22.4 ±2					Depth of Liquid (cm): >15			
Test Position	Dist. (mm)	Frequency		Conducted Power (dBm)		SAR (W/kg)		Plot No.
		Ch.	MHz	Meas.	Tune-Up Limit	Meas-1g	Scaled-1g	
Test Mode: BT-1M								
Front	5	39	2441	11.34	11.5	0.100	0.135	
Back	5	39	2441	11.34	11.5	0.083	0.112	
Back (NB)	5	39	2441	11.34	11.5	0.075	0.101	
Left-side	5	0	2402	11.24	11.5	0.134	0.185	
Left-side	5	39	2441	11.34	11.5	0.128	0.173	
Left-side	5	78	2480	11.39	11.5	0.154	0.205	9
Right-side	5	39	2441	11.34	11.5	0.079	0.106	
Right-side (NB)	5	39	2441	11.34	11.5	0.072	0.097	
Tip	5	39	2441	11.34	11.5	0.0041	0.006	

Note: Duty cycle: 77%

Appendix

Appendix A. System Check Data

Appendix B. Highest measurement Data

Appendix C. Test Setup Photographs

Appendix D. Probe Calibration Data

Appendix E. Dipole Calibration Data

Appendix F. Product Photos-Please refer to the file: 23A0523R-Product Photos

Appendix A. System Check Data

Test Laboratory: DEKRA

Date: 2023/11/13

System Performance Check_2450MHz-Head**DUT: D2450V2; Type: D2450V2**

Communication System: UID 0, CW; Frequency: 2450 MHz

Communication System PAR: 0 dB

Medium parameters used: $f = 2450$ MHz; $\sigma = 1.80$ S/m; $\epsilon_r = 39.92$; $\rho = 1000$ kg/m³

Phantom section: Flat Section

Measurement Standard: DASY5 (IEEE/IEC/ANSI C63.19-2011)

DASY Configuration:

- Probe: EX3DV4 - SN7631; ConvF(7.85, 8.9, 7.36) @ 2450 MHz; Calibrated: 2023/02/22
- Sensor-Surface: 1.4mm (Mechanical Surface Detection)
- Electronics: DAE4 Sn1651; Calibrated: 2023/02/22
- Phantom: Twin-SAM V8.0; Type: QD 000 P41 AA; Serial: 2030
- Measurement SW: DASY52, Version 52.10 (4); SEMCAD X Version 14.6.14 (7501)

Configuration/2450MHz_Head/Area Scan (10x10x1): Measurement grid: dx=12mm, dy=12mm

Maximum value of SAR (measured) = 15.8 W/kg

Configuration/2450MHz_Head/Zoom Scan (7x7x7)/Cube 0: Measurement grid: dx=5mm, dy=5mm, dz=5mm

Reference Value = 112.9 V/m; Power Drift = 0.08 dB

Peak SAR (extrapolated) = 26.2 W/kg

SAR(1 g) = 13.2 W/kg; SAR(10 g) = 6.16 W/kg

Smallest distance from peaks to all points 3 dB below = 9 mm

Ratio of SAR at M2 to SAR at M1 = 50.3%

Maximum value of SAR (measured) = 21.7 W/kg

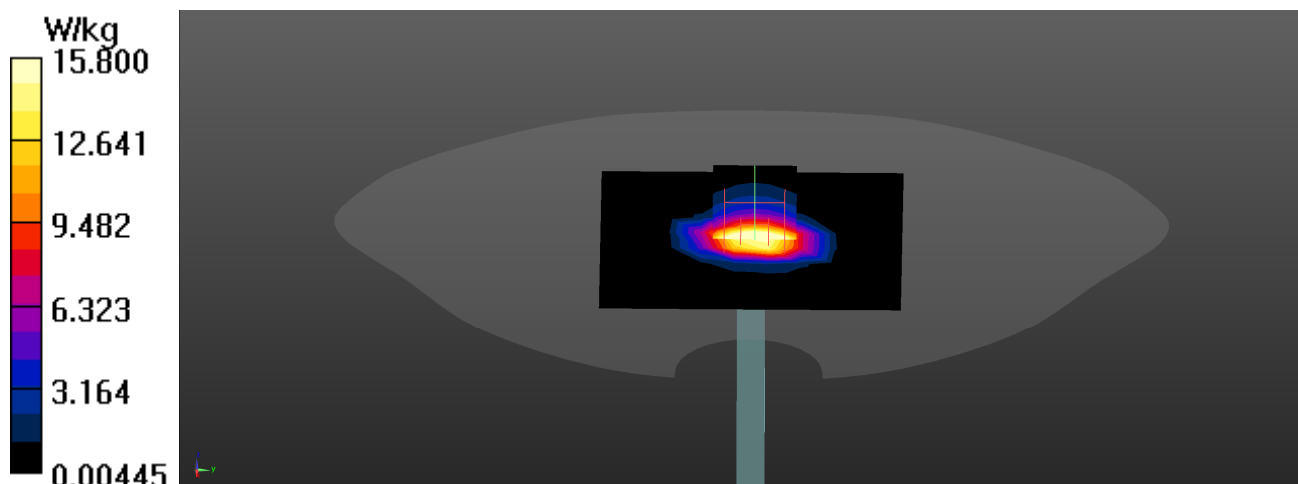

Appendix B. Highest Measurement Data

Test Laboratory: DEKRA

Date: 2023/11/13

9_Bluetooth_BT-1M_CH78_Left-side_5mm_ANT Main

DUT: Bluetooth USB Dongle; Type: END080W

Communication System: UID 0, BT 1M&3M&BLE; Frequency: 2480 MHz

Communication System PAR: 0 dB

Medium parameters used: $f = 2480$ MHz; $\sigma = 1.83$ S/m; $\epsilon_r = 39.80$; $\rho = 1000$ kg/m³

Phantom section: Flat Section

Measurement Standard: DASY5 (IEEE/IEC/ANSI C63.19-2011)

DASY Configuration:

- Probe: EX3DV4 - SN7631; ConvF(7.85, 8.9, 7.36) @ 2480 MHz; Calibrated: 2023/02/22
- Sensor-Surface: 1.4mm (Mechanical Surface Detection)
- Electronics: DAE4 Sn1651; Calibrated: 2023/02/22
- Phantom: Twin-SAM V8.0; Type: QD 000 P41 AA; Serial: 2030
- Measurement SW: DASY52, Version 52.10 (4); SEMCAD X Version 14.6.14 (7501)

Configuration/Flat/Area Scan (7x8x1): Measurement grid: dx=12mm, dy=12mm
Maximum value of SAR (measured) = 0.213 W/kg**Configuration/Flat/Zoom Scan (7x7x7)/Cube 0:** Measurement grid: dx=5mm, dy=5mm, dz=5mm

Reference Value = 6.112 V/m; Power Drift = 0.16 dB

Peak SAR (extrapolated) = 0.333 W/kg

SAR(1 g) = 0.154 W/kg; SAR(10 g) = 0.067 W/kg

Smallest distance from peaks to all points 3 dB below = 8 mm

Ratio of SAR at M2 to SAR at M1 = 47.2%

Maximum value of SAR (measured) = 0.268 W/kg

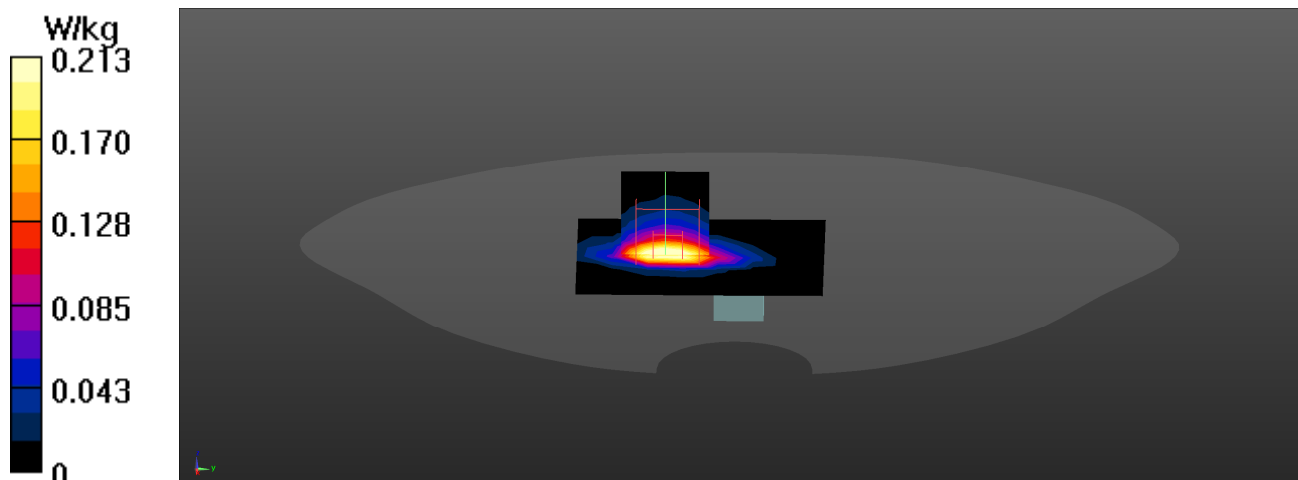

Appendix D. Probe Calibration



Accredited by the Swiss Accreditation Service (SAS)
 The Swiss Accreditation Service is one of the signatories to the EA
 Multilateral Agreement for the recognition of calibration certificates

Accreditation No.: **SCS 0108**

Client **DEKRA**
 Taoyuan City, Taiwan

Certificate No. **EX-7631_Feb23**

CALIBRATION CERTIFICATE

Object **EX3DV4 - SN:7631**

Calibration procedure(s) **QA CAL-01.v10, QA CAL-12.v10, QA CAL-14.v7, QA CAL-23.v6, QA CAL-25.v8
 Calibration procedure for dosimetric E-field probes**

Calibration date **February 22, 2023**

This calibration certificate documents the traceability to national standards, which realize the physical units of measurements (SI). The measurements and the uncertainties with confidence probability are given on the following pages and are part of the certificate.

All calibrations have been conducted in the closed laboratory facility: environment temperature (22 ± 3) °C and humidity < 70%.

Calibration Equipment used (M&TE critical for calibration)

Primary Standards	ID	Cal Date (Certificate No.)	Scheduled Calibration
Power meter NRP	SN: 104778	04-Apr-22 (No. 217-03525/03524)	Apr-23
Power sensor NRP-Z91	SN: 103244	04-Apr-22 (No. 217-03524)	Apr-23
OCP DAK-3.5 (weighted)	SN: 1249	20-Oct-22 (OCP-DAK3.5-1249_Oct22)	Oct-23
OCP DAK-12	SN: 1016	20-Oct-22 (OCP-DAK12-1016_Oct22)	Oct-23
Reference 20 dB Attenuator	SN: CC2552 (20x)	04-Apr-22 (No. 217-03527)	Apr-23
DAE4	SN: 660	16-Mar-23 (No. DAE4-660_Mar23)	Mar-24
Reference Probe ES3DV2	SN: 3013	06-Jan-23 (No. ES3-3013_Jan23)	Jan-24

Secondary Standards	ID	Check Date (in house)	Scheduled Check
Power meter E4419B	SN: GB41293874	06-Apr-16 (in house check Jun-22)	In house check: Jun-24
Power sensor E4412A	SN: MY41498087	06-Apr-16 (in house check Jun-22)	In house check: Jun-24
Power sensor E4412A	SN: 000110210	06-Apr-16 (in house check Jun-22)	In house check: Jun-24
RF generator HP 8648C	SN: US3642U01700	04-Aug-99 (in house check Jun-22)	In house check: Jun-24
Network Analyzer E8358A	SN: US41080477	31-Mar-14 (in house check Oct-22)	In house check: Oct-24

	Name	Function	Signature
Calibrated by	Jeton Kastrati	Laboratory Technician	
Approved by	Sven Kühn	Technical Manager	

Issued: February 23, 2023

This calibration certificate shall not be reproduced except in full without written approval of the laboratory.

Calibration Laboratory of

Schmid & Partner
Engineering AG

Zeughausstrasse 43, 8004 Zurich, Switzerland



S Schweizerischer Kalibrierdienst
C Service suisse d'étalonnage
S Servizio svizzero di taratura
S Swiss Calibration Service

Accredited by the Swiss Accreditation Service (SAS)
The Swiss Accreditation Service is one of the signatories to the EA Multilateral Agreement for the recognition of calibration certificates

Accreditation No.: SCS 0108

Glossary

TSL	tissue simulating liquid
NORM _{x,y,z}	sensitivity in free space
ConvF	sensitivity in TSL / NORM _{x,y,z}
DCP	diode compression point
CF	crest factor (1/duty_cycle) of the RF signal
A, B, C, D	modulation dependent linearization parameters
Polarization φ	φ rotation around probe axis
Polarization ϑ	ϑ rotation around an axis that is in the plane normal to probe axis (at measurement center), i.e., $\vartheta = 0$ is normal to probe axis
Connector Angle	information used in DASY system to align probe sensor X to the robot coordinate system

Calibration is Performed According to the Following Standards:

- IEC/IEEE 62209-1528, "Measurement Procedure For The Assessment Of Specific Absorption Rate Of Human Exposure To Radio Frequency Fields From Hand-Held And Body-Worn Wireless Communication Devices – Part 1528: Human Models, Instrumentation And Procedures (Frequency Range of 4 MHz to 10 GHz)", October 2020.
- KDB 865664, "SAR Measurement Requirements for 100 MHz to 6 GHz"

Methods Applied and Interpretation of Parameters:

- NORM_{x,y,z}**: Assessed for E-field polarization $\vartheta = 0$ ($f \leq 900$ MHz in TEM-cell; $f > 1800$ MHz: R22 waveguide). NORM_{x,y,z} are only intermediate values, i.e., the uncertainties of NORM_{x,y,z} does not affect the E²-field uncertainty inside TSL (see below ConvF).
- NORM(f)_{x,y,z}** = NORM_{x,y,z} * frequency_response (see Frequency Response Chart). This linearization is implemented in DASY4 software versions later than 4.2. The uncertainty of the frequency response is included in the stated uncertainty of ConvF.
- DCP_{x,y,z}**: DCP are numerical linearization parameters assessed based on the data of power sweep with CW signal. DCP does not depend on frequency nor media.
- PAR**: PAR is the Peak to Average Ratio that is not calibrated but determined based on the signal characteristics
- A_{x,y,z}; B_{x,y,z}; C_{x,y,z}; D_{x,y,z}; VR_{x,y,z}**: A, B, C, D are numerical linearization parameters assessed based on the data of power sweep for specific modulation signal. The parameters do not depend on frequency nor media. VR is the maximum calibration range expressed in RMS voltage across the diode.
- ConvF and Boundary Effect Parameters**: Assessed in flat phantom using E-field (or Temperature Transfer Standard for $f \leq 800$ MHz) and inside waveguide using analytical field distributions based on power measurements for $f > 800$ MHz. The same setups are used for assessment of the parameters applied for boundary compensation (alpha, depth) of which typical uncertainty values are given. These parameters are used in DASY4 software to improve probe accuracy close to the boundary. The sensitivity in TSL corresponds to NORM_{x,y,z} * ConvF whereby the uncertainty corresponds to that given for ConvF. A frequency dependent ConvF is used in DASY version 4.4 and higher which allows extending the validity from ± 50 MHz to ± 100 MHz.
- Spherical isotropy (3D deviation from isotropy)**: in a field of low gradients realized using a flat phantom exposed by a patch antenna.
- Sensor Offset**: The sensor offset corresponds to the offset of virtual measurement center from the probe tip (on probe axis). No tolerance required.
- Connector Angle**: The angle is assessed using the information gained by determining the NORM_x (no uncertainty required).

Parameters of Probe: EX3DV4 - SN:7631

Basic Calibration Parameters

	Sensor X	Sensor Y	Sensor Z	Unc (k = 2)
Norm ($\mu\text{V}/(\text{V}/\text{m})^2$) ^A	0.58	0.59	0.58	±10.1%
DCP (mV) ^B	105.0	104.0	105.0	±4.7%

Calibration Results for Modulation Response

UID	Communication System Name		A dB	B dB $\sqrt{\mu\text{V}}$	C	D dB	VR mV	Max dev.	Max Unc ^E k = 2
0	CW	X	0.00	0.00	1.00	0.00	134.1	±2.4%	±4.7%
		Y	0.00	0.00	1.00		134.3		
		Z	0.00	0.00	1.00		134.2		
10352	Pulse Waveform (200Hz, 10%)	X	1.64	61.06	6.41	10.00	60.0	±3.1%	±9.6%
		Y	1.87	62.41	7.57		60.0		
		Z	24.00	80.00	13.00		60.0		
10353	Pulse Waveform (200Hz, 20%)	X	0.84	60.00	4.80	6.99	80.0	±3.1%	±9.6%
		Y	0.83	60.00	5.31		80.0		
		Z	20.00	74.00	9.00		80.0		
10354	Pulse Waveform (200Hz, 40%)	X	0.46	60.00	3.60	3.98	95.0	±2.2%	±9.6%
		Y	2.00	64.00	5.00		95.0		
		Z	92.00	74.00	7.00		95.0		
10355	Pulse Waveform (200Hz, 60%)	X	9.18	158.87	6.88	2.22	120.0	±1.8%	±9.6%
		Y	9.23	158.10	14.78		120.0		
		Z	11.59	154.80	10.41		120.0		
10387	QPSK Waveform, 1 MHz	X	0.76	66.11	13.30	1.00	150.0	±4.9%	±9.6%
		Y	0.61	62.23	10.44		150.0		
		Z	0.46	61.14	10.23		150.0		
10388	QPSK Waveform, 10 MHz	X	1.49	66.50	14.45	0.00	150.0	±1.5%	±9.6%
		Y	1.28	63.76	12.68		150.0		
		Z	1.18	63.80	12.40		150.0		
10396	64-QAM Waveform, 100 kHz	X	1.84	66.05	16.77	3.01	150.0	±1.2%	±9.6%
		Y	1.61	63.62	15.56		150.0		
		Z	1.68	64.04	15.11		150.0		
10399	64-QAM Waveform, 40 MHz	X	2.94	66.52	15.22	0.00	150.0	±3.0%	±9.6%
		Y	2.76	65.17	14.32		150.0		
		Z	2.70	65.41	14.43		150.0		
10414	WLAN CCDF, 64-QAM, 40 MHz	X	3.99	66.00	15.34	0.00	150.0	±5.2%	±9.6%
		Y	4.06	65.79	15.13		150.0		
		Z	3.67	65.29	14.74		150.0		

Note: For details on UID parameters see Appendix

The reported uncertainty of measurement is stated as the standard uncertainty of measurement multiplied by the coverage factor k=2, which for a normal distribution corresponds to a coverage probability of approximately 95%.

^A The uncertainties of Norm X,Y,Z do not affect the E²-field uncertainty inside TSL (see Pages 5 and 6).

^B Linearization parameter uncertainty for maximum specified field strength.

^E Uncertainty is determined using the max. deviation from linear response applying rectangular distribution and is expressed for the square of the field value.

Parameters of Probe: EX3DV4 - SN:7631

Sensor Model Parameters

	C1 fF	C2 fF	α V^{-1}	T1 msV^{-2}	T2 msV^{-1}	T3 ms	T4 V^{-2}	T5 V^{-1}	T6
x	12.2	87.29	32.70	4.35	0.00	4.90	0.62	0.00	1.00
y	13.6	99.22	33.72	4.54	0.00	4.98	0.00	0.06	1.01
z	9.5	69.39	33.55	4.71	0.00	4.90	0.66	0.00	1.00

Other Probe Parameters

Sensor Arrangement	Triangular
Connector Angle	23.9°
Mechanical Surface Detection Mode	enabled
Optical Surface Detection Mode	disabled
Probe Overall Length	337 mm
Probe Body Diameter	10 mm
Tip Length	9 mm
Tip Diameter	2.5 mm
Probe Tip to Sensor X Calibration Point	1 mm
Probe Tip to Sensor Y Calibration Point	1 mm
Probe Tip to Sensor Z Calibration Point	1 mm
Recommended Measurement Distance from Surface	1.4 mm

Note: Measurement distance from surface can be increased to 3–4 mm for an *Area Scan* job.

Parameters of Probe: EX3DV4 - SN:7631

Calibration Parameter Determined in Head Tissue Simulating Media

f (MHz) ^C	Relative Permittivity ^F	Conductivity ^F (S/m)	ConvF X	ConvF Y	ConvF Z	Alpha ^G	Depth ^G (mm)	Unc (k = 2)
450	43.5	0.87	11.71	11.71	11.71	0.16	1.30	±13.3%
750	41.9	0.89	10.24	11.53	9.24	0.28	1.27	±12.0%
835	41.5	0.90	9.75	11.07	8.72	0.27	1.27	±12.0%
900	41.5	0.97	9.87	10.86	8.97	0.27	1.27	±12.0%
1450	40.5	1.20	8.21	9.39	7.62	0.40	1.27	±12.0%
1640	40.2	1.31	8.29	9.37	7.72	0.40	1.27	±12.0%
1750	40.1	1.37	8.48	9.55	8.05	0.26	1.27	±12.0%
1950	40.0	1.40	8.10	9.02	7.64	0.29	1.27	±12.0%
2300	39.5	1.67	8.25	9.30	7.74	0.29	1.27	±12.0%
2450	39.2	1.80	7.85	8.90	7.36	0.29	1.27	±12.0%
2600	39.0	1.96	7.48	8.44	7.01	0.28	1.27	±12.0%
3300	38.2	2.71	7.16	8.08	6.76	0.34	1.27	±14.0%
3500	37.9	2.91	7.38	8.27	6.86	0.35	1.27	±14.0%
3700	37.7	3.12	6.90	7.72	6.44	0.36	1.27	±14.0%
3900	37.5	3.32	6.98	7.85	6.55	0.36	1.27	±14.0%
4100	37.2	3.53	7.12	7.96	6.72	0.35	1.27	±14.0%
4400	36.9	3.84	6.60	7.38	6.28	0.38	1.27	±14.0%
4600	36.7	4.04	6.40	7.12	6.06	0.37	1.27	±14.0%
4800	36.4	4.25	6.93	7.70	6.53	0.36	1.27	±14.0%
4950	36.3	4.40	6.60	7.34	6.22	0.36	1.27	±14.0%
5250	35.9	4.71	5.67	6.32	5.35	0.32	1.53	±14.0%
5600	35.5	5.07	4.85	5.34	4.58	0.42	1.67	±14.0%
5800	35.3	5.27	4.84	5.40	4.63	0.40	1.78	±14.0%

^C Frequency validity above 300 MHz of ±100 MHz only applies for DASY v4.4 and higher (see Page 2), else it is restricted to ±50 MHz. The uncertainty is the RSS of the ConvF uncertainty at calibration frequency and the uncertainty for the indicated frequency band. Frequency validity below 300 MHz is ±10, 25, 40, 50 and 70 MHz for ConvF assessments at 30, 64, 128, 150 and 220 MHz respectively. Validity of ConvF assessed at 6 MHz is 4–9 MHz, and ConvF assessed at 13 MHz is 9–19 MHz. Above 5 GHz frequency validity can be extended to ±110 MHz.

^F The probes are calibrated using tissue simulating liquids (TSL) that deviate for ϵ and σ by less than ±5% from the target values (typically better than ±3%) and are valid for TSL with deviations of up to ±10%. If TSL with deviations from the target of less than ±5% are used, the calibration uncertainties are 11.1% for 0.7 - 3 GHz and 13.1% for 3 - 6 GHz.

^G Alpha/Depth are determined during calibration. SPEAG warrants that the remaining deviation due to the boundary effect after compensation is always less than ±1% for frequencies below 3 GHz and below ±2% for frequencies between 3–6 GHz at any distance larger than half the probe tip diameter from the boundary.

Parameters of Probe: EX3DV4 - SN:7631**Calibration Parameter Determined in Head Tissue Simulating Media**

f (MHz) ^C	Relative Permittivity ^F	Conductivity ^F (S/m)	ConvF X	ConvF Y	ConvF Z	Alpha ^G	Depth ^G (mm)	Unc (k = 2)
6500	34.5	6.07	5.18	5.95	5.00	0.20	2.50	±18.6%

^C Frequency validity at 6.5 GHz is -600/+700 MHz, and ±700 MHz at or above 7 GHz. The uncertainty is the RSS of the ConvF uncertainty at calibration frequency and the uncertainty for the indicated frequency band.

^F The probes are calibrated using tissue simulating liquids (TSL) that deviate for ϵ and σ by less than ±10% from the target values (typically better than ±6%) and are valid for TSL with deviations of up to ±10%.

^G Alpha/Depth are determined during calibration. SPEAG warrants that the remaining deviation due to the boundary effect after compensation is always less than ±1% for frequencies below 3 GHz; below ±2% for frequencies between 3–6 GHz; and below ±4% for frequencies between 6–10 GHz at any distance larger than half the probe tip diameter from the boundary.

Frequency Response of E-Field

(TEM-Cell:ifi110 EXX, Waveguide:R22)

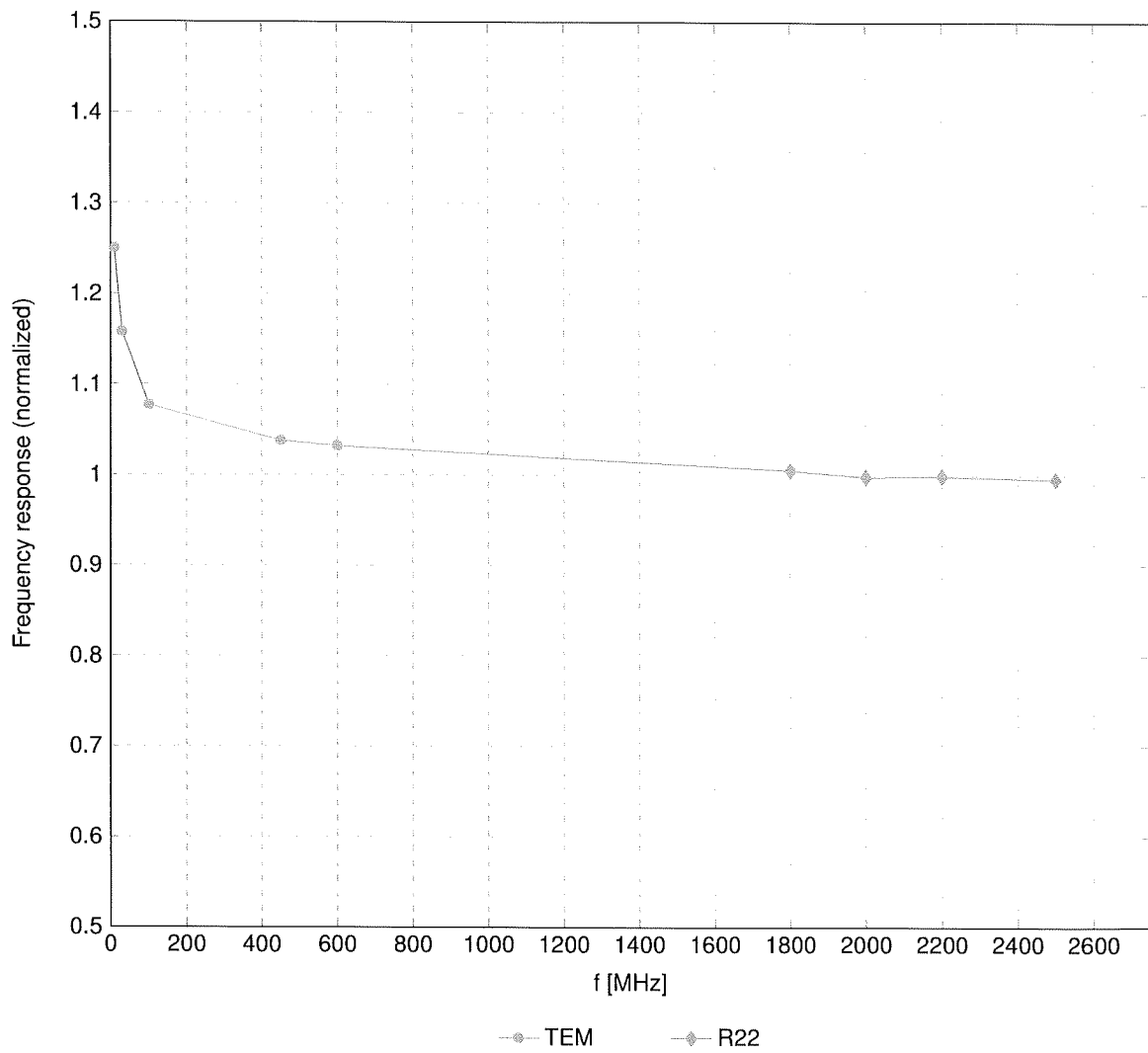

Uncertainty of Frequency Response of E-field: $\pm 6.3\%$ (k=2)

Receiving Pattern (ϕ), $\vartheta = 0^\circ$

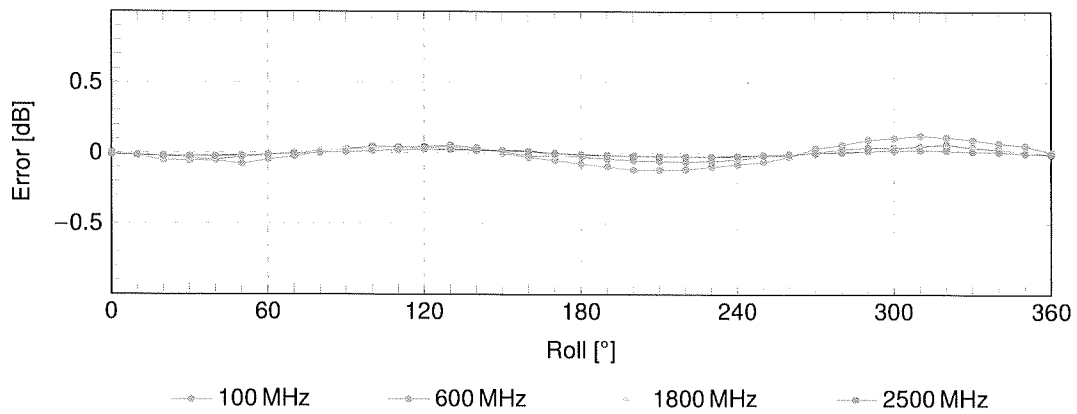
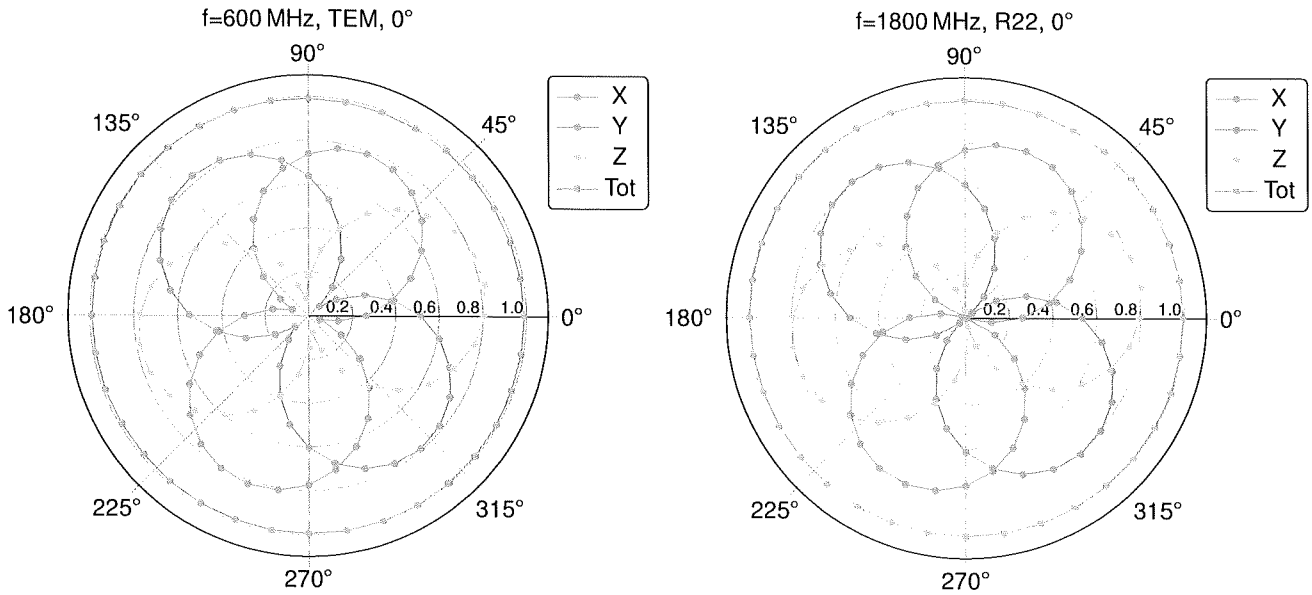

Uncertainty of Axial Isotropy Assessment: $\pm 0.5\%$ ($k=2$)

Dynamic Range $f(\text{SAR}_{\text{head}})$

(TEM cell, $f_{\text{eval}} = 1900 \text{ MHz}$)

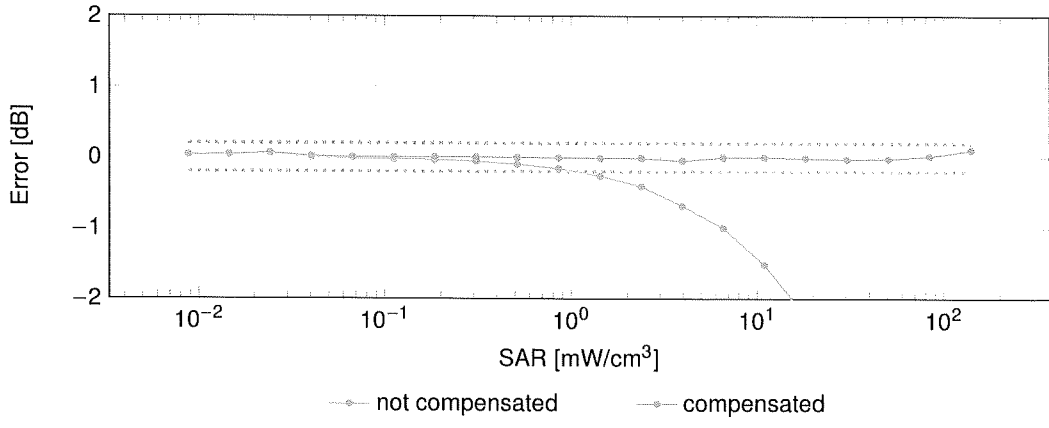
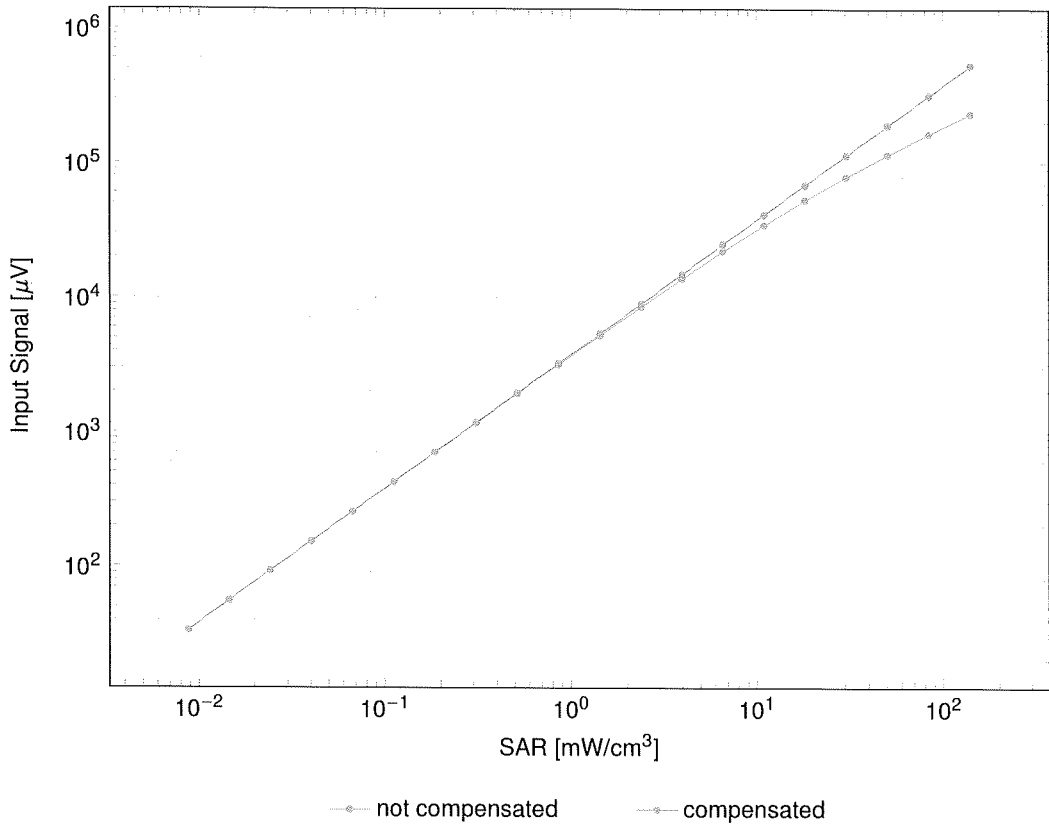

Uncertainty of Linearity Assessment: $\pm 0.6\%$ ($k=2$)

Conversion Factor Assessment

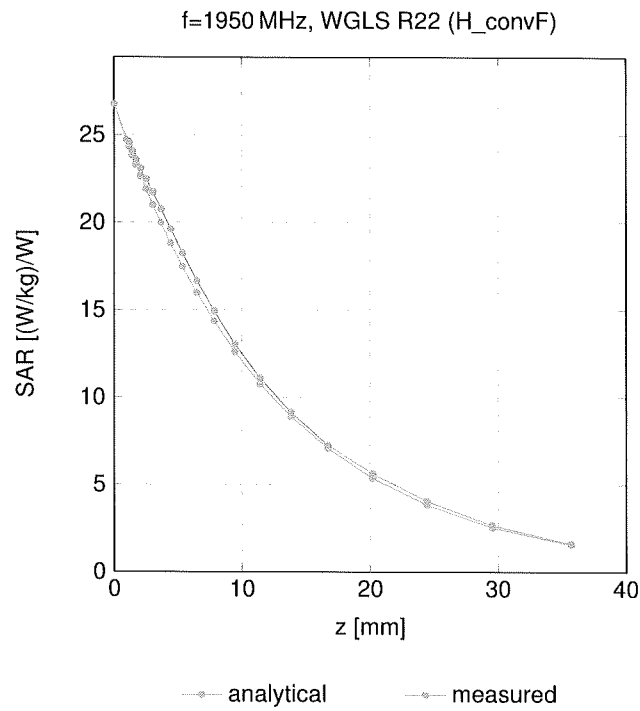

Deviation from Isotropy in Liquid

Error (ϕ, θ), f = 900 MHz

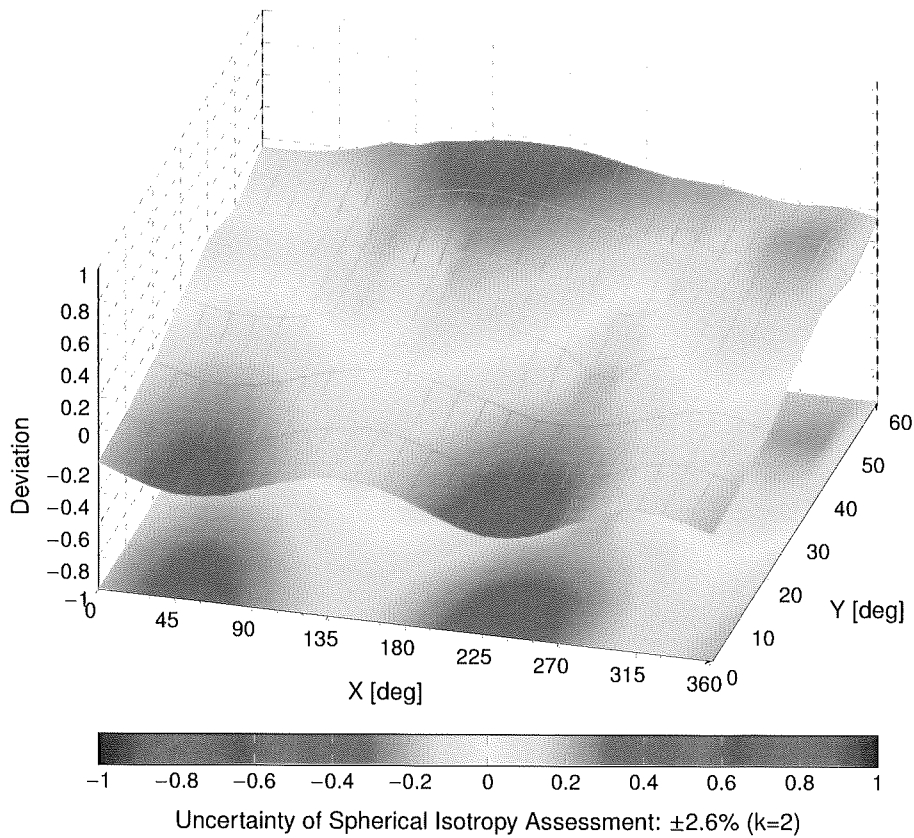

Appendix: Modulation Calibration Parameters

UID	Rev	Communication System Name	Group	PAR (dB)	Unc ^E k = 2
0		CW	CW	0.00	±4.7
10010	CAB	SAR Validation (Square, 100 ms, 10 ms)	Test	10.00	±9.6
10011	CAC	UMTS-FDD (WCDMA)	WCDMA	2.91	±9.6
10012	CAB	IEEE 802.11b WiFi 2.4 GHz (DSSS, 1 Mbps)	WLAN	1.87	±9.6
10013	CAB	IEEE 802.11g WiFi 2.4 GHz (DSSS-OFDM, 6 Mbps)	WLAN	9.46	±9.6
10021	DAC	GSM-FDD (TDMA, GMSK)	GSM	9.39	±9.6
10023	DAC	GPRS-FDD (TDMA, GMSK, TN 0)	GSM	9.57	±9.6
10024	DAC	GPRS-FDD (TDMA, GMSK, TN 0-1)	GSM	6.56	±9.6
10025	DAC	EDGE-FDD (TDMA, 8PSK, TN 0)	GSM	12.62	±9.6
10026	DAC	EDGE-FDD (TDMA, 8PSK, TN 0-1)	GSM	9.55	±9.6
10027	DAC	GPRS-FDD (TDMA, GMSK, TN 0-1-2)	GSM	4.80	±9.6
10028	DAC	GPRS-FDD (TDMA, GMSK, TN 0-1-2-3)	GSM	3.55	±9.6
10029	DAC	EDGE-FDD (TDMA, 8PSK, TN 0-1-2)	GSM	7.78	±9.6
10030	CAA	IEEE 802.15.1 Bluetooth (GFSK, DH1)	Bluetooth	5.30	±9.6
10031	CAA	IEEE 802.15.1 Bluetooth (GFSK, DH3)	Bluetooth	1.87	±9.6
10032	CAA	IEEE 802.15.1 Bluetooth (GFSK, DH5)	Bluetooth	1.16	±9.6
10033	CAA	IEEE 802.15.1 Bluetooth (PI/4-DQPSK, DH1)	Bluetooth	7.74	±9.6
10034	CAA	IEEE 802.15.1 Bluetooth (PI/4-DQPSK, DH3)	Bluetooth	4.53	±9.6
10035	CAA	IEEE 802.15.1 Bluetooth (PI/4-DQPSK, DH5)	Bluetooth	3.83	±9.6
10036	CAA	IEEE 802.15.1 Bluetooth (8-DPSK, DH1)	Bluetooth	8.01	±9.6
10037	CAA	IEEE 802.15.1 Bluetooth (8-DPSK, DH3)	Bluetooth	4.77	±9.6
10038	CAA	IEEE 802.15.1 Bluetooth (8-DPSK, DH5)	Bluetooth	4.10	±9.6
10039	CAB	CDMA2000 (1xRTT, RC1)	CDMA2000	4.57	±9.6
10042	CAB	IS-54 / IS-136 FDD (TDMA/FDM, PI/4-DQPSK, Halfrate)	AMPS	7.78	±9.6
10044	CAA	IS-91/EIA/TIA-553 FDD (FDMA, FM)	AMPS	0.00	±9.6
10048	CAA	DECT (TDD, TDMA/FDM, GFSK, Full Slot, 24)	DECT	13.80	±9.6
10049	CAA	DECT (TDD, TDMA/FDM, GFSK, Double Slot, 12)	DECT	10.79	±9.6
10056	CAA	UMTS-TDD (TD-SCDMA, 1.28 Mcps)	TD-SCDMA	11.01	±9.6
10058	DAC	EDGE-FDD (TDMA, 8PSK, TN 0-1-2-3)	GSM	6.52	±9.6
10059	CAB	IEEE 802.11b WiFi 2.4 GHz (DSSS, 2 Mbps)	WLAN	2.12	±9.6
10060	CAB	IEEE 802.11b WiFi 2.4 GHz (DSSS, 5.5 Mbps)	WLAN	2.83	±9.6
10061	CAB	IEEE 802.11b WiFi 2.4 GHz (DSSS, 11 Mbps)	WLAN	3.60	±9.6
10062	CAD	IEEE 802.11a/h WiFi 5 GHz (OFDM, 6 Mbps)	WLAN	8.68	±9.6
10063	CAD	IEEE 802.11a/h WiFi 5 GHz (OFDM, 9 Mbps)	WLAN	8.63	±9.6
10064	CAD	IEEE 802.11a/h WiFi 5 GHz (OFDM, 12 Mbps)	WLAN	9.09	±9.6
10065	CAD	IEEE 802.11a/h WiFi 5 GHz (OFDM, 18 Mbps)	WLAN	9.00	±9.6
10066	CAD	IEEE 802.11a/h WiFi 5 GHz (OFDM, 24 Mbps)	WLAN	9.38	±9.6
10067	CAD	IEEE 802.11a/h WiFi 5 GHz (OFDM, 36 Mbps)	WLAN	10.12	±9.6
10068	CAD	IEEE 802.11a/h WiFi 5 GHz (OFDM, 48 Mbps)	WLAN	10.24	±9.6
10069	CAD	IEEE 802.11a/h WiFi 5 GHz (OFDM, 54 Mbps)	WLAN	10.56	±9.6
10071	CAB	IEEE 802.11g WiFi 2.4 GHz (DSSS/OFDM, 9 Mbps)	WLAN	9.83	±9.6
10072	CAB	IEEE 802.11g WiFi 2.4 GHz (DSSS/OFDM, 12 Mbps)	WLAN	9.62	±9.6
10073	CAB	IEEE 802.11g WiFi 2.4 GHz (DSSS/OFDM, 18 Mbps)	WLAN	9.94	±9.6
10074	CAB	IEEE 802.11g WiFi 2.4 GHz (DSSS/OFDM, 24 Mbps)	WLAN	10.30	±9.6
10075	CAB	IEEE 802.11g WiFi 2.4 GHz (DSSS/OFDM, 36 Mbps)	WLAN	10.77	±9.6
10076	CAB	IEEE 802.11g WiFi 2.4 GHz (DSSS/OFDM, 48 Mbps)	WLAN	10.94	±9.6
10077	CAB	IEEE 802.11g WiFi 2.4 GHz (DSSS/OFDM, 54 Mbps)	WLAN	11.00	±9.6
10081	CAB	CDMA2000 (1xRTT, RC3)	CDMA2000	3.97	±9.6
10082	CAB	IS-54 / IS-136 FDD (TDMA/FDM, PI/4-DQPSK, Fullrate)	AMPS	4.77	±9.6
10090	DAC	GPRS-FDD (TDMA, GMSK, TN 0-4)	GSM	6.56	±9.6
10097	CAC	UMTS-FDD (HSDPA)	WCDMA	3.98	±9.6
10098	CAC	UMTS-FDD (HSUPA, Subtest 2)	WCDMA	3.98	±9.6
10099	DAC	EDGE-FDD (TDMA, 8PSK, TN 0-4)	GSM	9.55	±9.6
10100	CAF	LTE-FDD (SC-FDMA, 100% RB, 20 MHz, QPSK)	LTE-FDD	5.67	±9.6
10101	CAF	LTE-FDD (SC-FDMA, 100% RB, 20 MHz, 16-QAM)	LTE-FDD	6.42	±9.6
10102	CAF	LTE-FDD (SC-FDMA, 100% RB, 20 MHz, 64-QAM)	LTE-FDD	6.60	±9.6
10103	CAH	LTE-TDD (SC-FDMA, 100% RB, 20 MHz, QPSK)	LTE-TDD	9.29	±9.6
10104	CAH	LTE-TDD (SC-FDMA, 100% RB, 20 MHz, 16-QAM)	LTE-TDD	9.97	±9.6
10105	CAH	LTE-TDD (SC-FDMA, 100% RB, 20 MHz, 64-QAM)	LTE-TDD	10.01	±9.6
10108	CAH	LTE-FDD (SC-FDMA, 100% RB, 10 MHz, QPSK)	LTE-FDD	5.80	±9.6
10109	CAH	LTE-FDD (SC-FDMA, 100% RB, 10 MHz, 16-QAM)	LTE-FDD	6.43	±9.6
10110	CAH	LTE-FDD (SC-FDMA, 100% RB, 5 MHz, QPSK)	LTE-FDD	5.75	±9.6
10111	CAH	LTE-FDD (SC-FDMA, 100% RB, 5 MHz, 16-QAM)	LTE-FDD	6.44	±9.6

UID	Rev	Communication System Name	Group	PAR (dB)	Unc ^E k = 2
10112	CAH	LTE-FDD (SC-FDMA, 100% RB, 10 MHz, 64-QAM)	LTE-FDD	6.59	±9.6
10113	CAH	LTE-FDD (SC-FDMA, 100% RB, 5 MHz, 64-QAM)	LTE-FDD	6.62	±9.6
10114	CAD	IEEE 802.11n (HT Greenfield, 13.5 Mbps, BPSK)	WLAN	8.10	±9.6
10115	CAD	IEEE 802.11n (HT Greenfield, 81 Mbps, 16-QAM)	WLAN	8.46	±9.6
10116	CAD	IEEE 802.11n (HT Greenfield, 135 Mbps, 64-QAM)	WLAN	8.15	±9.6
10117	CAD	IEEE 802.11n (HT Mixed, 13.5 Mbps, BPSK)	WLAN	8.07	±9.6
10118	CAD	IEEE 802.11n (HT Mixed, 81 Mbps, 16-QAM)	WLAN	8.59	±9.6
10119	CAD	IEEE 802.11n (HT Mixed, 135 Mbps, 64-QAM)	WLAN	8.13	±9.6
10140	CAF	LTE-FDD (SC-FDMA, 100% RB, 15 MHz, 16-QAM)	LTE-FDD	6.49	±9.6
10141	CAF	LTE-FDD (SC-FDMA, 100% RB, 15 MHz, 64-QAM)	LTE-FDD	6.53	±9.6
10142	CAF	LTE-FDD (SC-FDMA, 100% RB, 3 MHz, QPSK)	LTE-FDD	5.73	±9.6
10143	CAF	LTE-FDD (SC-FDMA, 100% RB, 3 MHz, 16-QAM)	LTE-FDD	6.35	±9.6
10144	CAF	LTE-FDD (SC-FDMA, 100% RB, 3 MHz, 64-QAM)	LTE-FDD	6.65	±9.6
10145	CAG	LTE-FDD (SC-FDMA, 100% RB, 1.4 MHz, QPSK)	LTE-FDD	5.76	±9.6
10146	CAG	LTE-FDD (SC-FDMA, 100% RB, 1.4 MHz, 16-QAM)	LTE-FDD	6.41	±9.6
10147	CAG	LTE-FDD (SC-FDMA, 100% RB, 1.4 MHz, 64-QAM)	LTE-FDD	6.72	±9.6
10149	CAF	LTE-FDD (SC-FDMA, 50% RB, 20 MHz, 16-QAM)	LTE-FDD	6.42	±9.6
10150	CAF	LTE-FDD (SC-FDMA, 50% RB, 20 MHz, 64-QAM)	LTE-FDD	6.60	±9.6
10151	CAH	LTE-TDD (SC-FDMA, 50% RB, 20 MHz, QPSK)	LTE-TDD	9.28	±9.6
10152	CAH	LTE-TDD (SC-FDMA, 50% RB, 20 MHz, 16-QAM)	LTE-TDD	9.92	±9.6
10153	CAH	LTE-TDD (SC-FDMA, 50% RB, 20 MHz, 64-QAM)	LTE-TDD	10.05	±9.6
10154	CAH	LTE-FDD (SC-FDMA, 50% RB, 10 MHz, QPSK)	LTE-FDD	5.75	±9.6
10155	CAH	LTE-FDD (SC-FDMA, 50% RB, 10 MHz, 16-QAM)	LTE-FDD	6.43	±9.6
10156	CAH	LTE-FDD (SC-FDMA, 50% RB, 5 MHz, QPSK)	LTE-FDD	5.79	±9.6
10157	CAH	LTE-FDD (SC-FDMA, 50% RB, 5 MHz, 16-QAM)	LTE-FDD	6.49	±9.6
10158	CAH	LTE-FDD (SC-FDMA, 50% RB, 10 MHz, 64-QAM)	LTE-FDD	6.62	±9.6
10159	CAH	LTE-FDD (SC-FDMA, 50% RB, 5 MHz, 64-QAM)	LTE-FDD	6.56	±9.6
10160	CAF	LTE-FDD (SC-FDMA, 50% RB, 15 MHz, QPSK)	LTE-FDD	5.82	±9.6
10161	CAF	LTE-FDD (SC-FDMA, 50% RB, 15 MHz, 16-QAM)	LTE-FDD	6.43	±9.6
10162	CAF	LTE-FDD (SC-FDMA, 50% RB, 15 MHz, 64-QAM)	LTE-FDD	6.58	±9.6
10166	CAG	LTE-FDD (SC-FDMA, 50% RB, 1.4 MHz, QPSK)	LTE-FDD	5.46	±9.6
10167	CAG	LTE-FDD (SC-FDMA, 50% RB, 1.4 MHz, 16-QAM)	LTE-FDD	6.21	±9.6
10168	CAG	LTE-FDD (SC-FDMA, 50% RB, 1.4 MHz, 64-QAM)	LTE-FDD	6.79	±9.6
10169	CAF	LTE-FDD (SC-FDMA, 1 RB, 20 MHz, QPSK)	LTE-FDD	5.73	±9.6
10170	CAF	LTE-FDD (SC-FDMA, 1 RB, 20 MHz, 16-QAM)	LTE-FDD	6.52	±9.6
10171	AAF	LTE-FDD (SC-FDMA, 1 RB, 20 MHz, 64-QAM)	LTE-FDD	6.49	±9.6
10172	CAH	LTE-TDD (SC-FDMA, 1 RB, 20 MHz, QPSK)	LTE-TDD	9.21	±9.6
10173	CAH	LTE-TDD (SC-FDMA, 1 RB, 20 MHz, 16-QAM)	LTE-TDD	9.48	±9.6
10174	CAH	LTE-TDD (SC-FDMA, 1 RB, 20 MHz, 64-QAM)	LTE-TDD	10.25	±9.6
10175	CAH	LTE-FDD (SC-FDMA, 1 RB, 10 MHz, QPSK)	LTE-FDD	5.72	±9.6
10176	CAH	LTE-FDD (SC-FDMA, 1 RB, 10 MHz, 16-QAM)	LTE-FDD	6.52	±9.6
10177	CAJ	LTE-FDD (SC-FDMA, 1 RB, 5 MHz, QPSK)	LTE-FDD	5.73	±9.6
10178	CAH	LTE-FDD (SC-FDMA, 1 RB, 5 MHz, 16-QAM)	LTE-FDD	6.52	±9.6
10179	CAH	LTE-FDD (SC-FDMA, 1 RB, 10 MHz, 64-QAM)	LTE-FDD	6.50	±9.6
10180	CAH	LTE-FDD (SC-FDMA, 1 RB, 5 MHz, 64-QAM)	LTE-FDD	6.50	±9.6
10181	CAF	LTE-FDD (SC-FDMA, 1 RB, 15 MHz, QPSK)	LTE-FDD	5.72	±9.6
10182	CAF	LTE-FDD (SC-FDMA, 1 RB, 15 MHz, 16-QAM)	LTE-FDD	6.52	±9.6
10183	AAE	LTE-FDD (SC-FDMA, 1 RB, 15 MHz, 64-QAM)	LTE-FDD	6.50	±9.6
10184	CAF	LTE-FDD (SC-FDMA, 1 RB, 3 MHz, QPSK)	LTE-FDD	5.73	±9.6
10185	CAF	LTE-FDD (SC-FDMA, 1 RB, 3 MHz, 16-QAM)	LTE-FDD	6.51	±9.6
10186	AAF	LTE-FDD (SC-FDMA, 1 RB, 3 MHz, 64-QAM)	LTE-FDD	6.50	±9.6
10187	CAG	LTE-FDD (SC-FDMA, 1 RB, 1.4 MHz, QPSK)	LTE-FDD	5.73	±9.6
10188	CAG	LTE-FDD (SC-FDMA, 1 RB, 1.4 MHz, 16-QAM)	LTE-FDD	6.52	±9.6
10189	AAG	LTE-FDD (SC-FDMA, 1 RB, 1.4 MHz, 64-QAM)	LTE-FDD	6.50	±9.6
10193	CAD	IEEE 802.11n (HT Greenfield, 6.5 Mbps, BPSK)	WLAN	8.09	±9.6
10194	CAD	IEEE 802.11n (HT Greenfield, 39 Mbps, 16-QAM)	WLAN	8.12	±9.6
10195	CAD	IEEE 802.11n (HT Greenfield, 65 Mbps, 64-QAM)	WLAN	8.21	±9.6
10196	CAD	IEEE 802.11n (HT Mixed, 6.5 Mbps, BPSK)	WLAN	8.10	±9.6
10197	CAD	IEEE 802.11n (HT Mixed, 39 Mbps, 16-QAM)	WLAN	8.13	±9.6
10198	CAD	IEEE 802.11n (HT Mixed, 65 Mbps, 64-QAM)	WLAN	8.27	±9.6
10219	CAD	IEEE 802.11n (HT Mixed, 7.2 Mbps, BPSK)	WLAN	8.03	±9.6
10220	CAD	IEEE 802.11n (HT Mixed, 43.3 Mbps, 16-QAM)	WLAN	8.13	±9.6
10221	CAD	IEEE 802.11n (HT Mixed, 72.2 Mbps, 64-QAM)	WLAN	8.27	±9.6
10222	CAD	IEEE 802.11n (HT Mixed, 15 Mbps, BPSK)	WLAN	8.06	±9.6
10223	CAD	IEEE 802.11n (HT Mixed, 90 Mbps, 16-QAM)	WLAN	8.48	±9.6
10224	CAD	IEEE 802.11n (HT Mixed, 150 Mbps, 64-QAM)	WLAN	8.08	±9.6

UID	Rev	Communication System Name	Group	PAR (dB)	Unc ^E k = 2
10225	CAC	UMTS-FDD (HSPA+)	WCDMA	5.97	±9.6
10226	CAC	LTE-TDD (SC-FDMA, 1 RB, 1.4 MHz, 16-QAM)	LTE-TDD	9.49	±9.6
10227	CAC	LTE-TDD (SC-FDMA, 1 RB, 1.4 MHz, 64-QAM)	LTE-TDD	10.26	±9.6
10228	CAC	LTE-TDD (SC-FDMA, 1 RB, 1.4 MHz, QPSK)	LTE-TDD	9.22	±9.6
10229	CAE	LTE-TDD (SC-FDMA, 1 RB, 3 MHz, 16-QAM)	LTE-TDD	9.48	±9.6
10230	CAE	LTE-TDD (SC-FDMA, 1 RB, 3 MHz, 64-QAM)	LTE-TDD	10.25	±9.6
10231	CAE	LTE-TDD (SC-FDMA, 1 RB, 3 MHz, QPSK)	LTE-TDD	9.19	±9.6
10232	CAH	LTE-TDD (SC-FDMA, 1 RB, 5 MHz, 16-QAM)	LTE-TDD	9.48	±9.6
10233	CAH	LTE-TDD (SC-FDMA, 1 RB, 5 MHz, 64-QAM)	LTE-TDD	10.25	±9.6
10234	CAH	LTE-TDD (SC-FDMA, 1 RB, 5 MHz, QPSK)	LTE-TDD	9.21	±9.6
10235	CAH	LTE-TDD (SC-FDMA, 1 RB, 10 MHz, 16-QAM)	LTE-TDD	9.48	±9.6
10236	CAH	LTE-TDD (SC-FDMA, 1 RB, 10 MHz, 64-QAM)	LTE-TDD	10.25	±9.6
10237	CAH	LTE-TDD (SC-FDMA, 1 RB, 10 MHz, QPSK)	LTE-TDD	9.21	±9.6
10238	CAG	LTE-TDD (SC-FDMA, 1 RB, 15 MHz, 16-QAM)	LTE-TDD	9.48	±9.6
10239	CAG	LTE-TDD (SC-FDMA, 1 RB, 15 MHz, 64-QAM)	LTE-TDD	10.25	±9.6
10240	CAG	LTE-TDD (SC-FDMA, 1 RB, 15 MHz, QPSK)	LTE-TDD	9.21	±9.6
10241	CAC	LTE-TDD (SC-FDMA, 50% RB, 1.4 MHz, 16-QAM)	LTE-TDD	9.82	±9.6
10242	CAC	LTE-TDD (SC-FDMA, 50% RB, 1.4 MHz, 64-QAM)	LTE-TDD	9.86	±9.6
10243	CAC	LTE-TDD (SC-FDMA, 50% RB, 1.4 MHz, QPSK)	LTE-TDD	9.46	±9.6
10244	CAE	LTE-TDD (SC-FDMA, 50% RB, 3 MHz, 16-QAM)	LTE-TDD	10.06	±9.6
10245	CAE	LTE-TDD (SC-FDMA, 50% RB, 3 MHz, 64-QAM)	LTE-TDD	10.06	±9.6
10246	CAE	LTE-TDD (SC-FDMA, 50% RB, 3 MHz, QPSK)	LTE-TDD	9.30	±9.6
10247	CAH	LTE-TDD (SC-FDMA, 50% RB, 5 MHz, 16-QAM)	LTE-TDD	9.91	±9.6
10248	CAH	LTE-TDD (SC-FDMA, 50% RB, 5 MHz, 64-QAM)	LTE-TDD	10.09	±9.6
10249	CAH	LTE-TDD (SC-FDMA, 50% RB, 5 MHz, QPSK)	LTE-TDD	9.29	±9.6
10250	CAH	LTE-TDD (SC-FDMA, 50% RB, 10 MHz, 16-QAM)	LTE-TDD	9.81	±9.6
10251	CAH	LTE-TDD (SC-FDMA, 50% RB, 10 MHz, 64-QAM)	LTE-TDD	10.17	±9.6
10252	CAH	LTE-TDD (SC-FDMA, 50% RB, 10 MHz, QPSK)	LTE-TDD	9.24	±9.6
10253	CAG	LTE-TDD (SC-FDMA, 50% RB, 15 MHz, 16-QAM)	LTE-TDD	9.90	±9.6
10254	CAG	LTE-TDD (SC-FDMA, 50% RB, 15 MHz, 64-QAM)	LTE-TDD	10.14	±9.6
10255	CAG	LTE-TDD (SC-FDMA, 50% RB, 15 MHz, QPSK)	LTE-TDD	9.20	±9.6
10256	CAC	LTE-TDD (SC-FDMA, 100% RB, 1.4 MHz, 16-QAM)	LTE-TDD	9.96	±9.6
10257	CAC	LTE-TDD (SC-FDMA, 100% RB, 1.4 MHz, 64-QAM)	LTE-TDD	10.08	±9.6
10258	CAC	LTE-TDD (SC-FDMA, 100% RB, 1.4 MHz, QPSK)	LTE-TDD	9.34	±9.6
10259	CAE	LTE-TDD (SC-FDMA, 100% RB, 3 MHz, 16-QAM)	LTE-TDD	9.98	±9.6
10260	CAE	LTE-TDD (SC-FDMA, 100% RB, 3 MHz, 64-QAM)	LTE-TDD	9.97	±9.6
10261	CAE	LTE-TDD (SC-FDMA, 100% RB, 3 MHz, QPSK)	LTE-TDD	9.24	±9.6
10262	CAH	LTE-TDD (SC-FDMA, 100% RB, 5 MHz, 16-QAM)	LTE-TDD	9.83	±9.6
10263	CAH	LTE-TDD (SC-FDMA, 100% RB, 5 MHz, 64-QAM)	LTE-TDD	10.16	±9.6
10264	CAH	LTE-TDD (SC-FDMA, 100% RB, 5 MHz, QPSK)	LTE-TDD	9.23	±9.6
10265	CAH	LTE-TDD (SC-FDMA, 100% RB, 10 MHz, 16-QAM)	LTE-TDD	9.92	±9.6
10266	CAH	LTE-TDD (SC-FDMA, 100% RB, 10 MHz, 64-QAM)	LTE-TDD	10.07	±9.6
10267	CAH	LTE-TDD (SC-FDMA, 100% RB, 10 MHz, QPSK)	LTE-TDD	9.30	±9.6
10268	CAG	LTE-TDD (SC-FDMA, 100% RB, 15 MHz, 16-QAM)	LTE-TDD	10.06	±9.6
10269	CAG	LTE-TDD (SC-FDMA, 100% RB, 15 MHz, 64-QAM)	LTE-TDD	10.13	±9.6
10270	CAG	LTE-TDD (SC-FDMA, 100% RB, 15 MHz, QPSK)	LTE-TDD	9.58	±9.6
10274	CAC	UMTS-FDD (HSUPA, Subtest 5, 3GPP Rel8.10)	WCDMA	4.87	±9.6
10275	CAC	UMTS-FDD (HSUPA, Subtest 5, 3GPP Rel8.4)	WCDMA	3.96	±9.6
10277	CAA	PHS (QPSK)	PHS	11.81	±9.6
10278	CAA	PHS (QPSK, BW 884 MHz, Rolloff 0.5)	PHS	11.81	±9.6
10279	CAA	PHS (QPSK, BW 884 MHz, Rolloff 0.38)	PHS	12.18	±9.6
10290	AAB	CDMA2000, RC1, SO55, Full Rate	CDMA2000	3.91	±9.6
10291	AAB	CDMA2000, RC3, SO55, Full Rate	CDMA2000	3.46	±9.6
10292	AAB	CDMA2000, RC3, SO32, Full Rate	CDMA2000	3.39	±9.6
10293	AAB	CDMA2000, RC3, SO3, Full Rate	CDMA2000	3.50	±9.6
10295	AAB	CDMA2000, RC1, SO3, 1/8th Rate 25 fr.	CDMA2000	12.49	±9.6
10297	AAE	LTE-FDD (SC-FDMA, 50% RB, 20 MHz, QPSK)	LTE-FDD	5.81	±9.6
10298	AAE	LTE-FDD (SC-FDMA, 50% RB, 3 MHz, QPSK)	LTE-FDD	5.72	±9.6
10299	AAE	LTE-FDD (SC-FDMA, 50% RB, 3 MHz, 16-QAM)	LTE-FDD	6.39	±9.6
10300	AAE	LTE-FDD (SC-FDMA, 50% RB, 3 MHz, 64-QAM)	LTE-FDD	6.60	±9.6
10301	AAA	IEEE 802.16e WiMAX (29:18, 5ms, 10MHz, QPSK, PUSC)	WiMAX	12.03	±9.6
10302	AAA	IEEE 802.16e WiMAX (29:18, 5ms, 10MHz, QPSK, PUSC, 3 CTRL symbols)	WiMAX	12.57	±9.6
10303	AAA	IEEE 802.16e WiMAX (31:15, 5ms, 10MHz, 64QAM, PUSC)	WiMAX	12.52	±9.6
10304	AAA	IEEE 802.16e WiMAX (29:18, 5ms, 10MHz, 64QAM, PUSC)	WiMAX	11.86	±9.6
10305	AAA	IEEE 802.16e WiMAX (31:15, 10ms, 10MHz, 64QAM, PUSC, 15 symbols)	WiMAX	15.24	±9.6
10306	AAA	IEEE 802.16e WiMAX (29:18, 10ms, 10MHz, 64QAM, PUSC, 18 symbols)	WiMAX	14.67	±9.6

UID	Rev	Communication System Name	Group	PAR (dB)	Unc ^E k = 2
10307	AAA	IEEE 802.16e WiMAX (29:18, 10 ms, 10 MHz, QPSK, PUSC, 18 symbols)	WiMAX	14.49	±9.6
10308	AAA	IEEE 802.16e WiMAX (29:18, 10 ms, 10 MHz, 16QAM, PUSC)	WiMAX	14.46	±9.6
10309	AAA	IEEE 802.16e WiMAX (29:18, 10 ms, 10 MHz, 16QAM, AMC 2x3, 18 symbols)	WiMAX	14.58	±9.6
10310	AAA	IEEE 802.16e WiMAX (29:18, 10 ms, 10 MHz, QPSK, AMC 2x3, 18 symbols)	WiMAX	14.57	±9.6
10311	AAE	LTE-FDD (SC-FDMA, 100% RB, 15 MHz, QPSK)	LTE-FDD	6.06	±9.6
10313	AAA	iDEN 1:3	iDEN	10.51	±9.6
10314	AAA	iDEN 1:6	iDEN	13.48	±9.6
10315	AAB	IEEE 802.11b WiFi 2.4 GHz (DSSS, 1 Mbps, 96pc duty cycle)	WLAN	1.71	±9.6
10316	AAB	IEEE 802.11g WiFi 2.4 GHz (ERP-OFDM, 6 Mbps, 96pc duty cycle)	WLAN	8.36	±9.6
10317	AAD	IEEE 802.11a WiFi 5 GHz (OFDM, 6 Mbps, 96pc duty cycle)	WLAN	8.36	±9.6
10352	AAA	Pulse Waveform (200Hz, 10%)	Generic	10.00	±9.6
10353	AAA	Pulse Waveform (200Hz, 20%)	Generic	6.99	±9.6
10354	AAA	Pulse Waveform (200Hz, 40%)	Generic	3.98	±9.6
10355	AAA	Pulse Waveform (200Hz, 60%)	Generic	2.22	±9.6
10356	AAA	Pulse Waveform (200Hz, 80%)	Generic	0.97	±9.6
10387	AAA	QPSK Waveform, 1 MHz	Generic	5.10	±9.6
10388	AAA	QPSK Waveform, 10 MHz	Generic	5.22	±9.6
10396	AAA	64-QAM Waveform, 100 kHz	Generic	6.27	±9.6
10399	AAA	64-QAM Waveform, 40 MHz	Generic	6.27	±9.6
10400	AAE	IEEE 802.11ac WiFi (20 MHz, 64-QAM, 99pc duty cycle)	WLAN	8.37	±9.6
10401	AAE	IEEE 802.11ac WiFi (40 MHz, 64-QAM, 99pc duty cycle)	WLAN	8.60	±9.6
10402	AAE	IEEE 802.11ac WiFi (80 MHz, 64-QAM, 99pc duty cycle)	WLAN	8.53	±9.6
10403	AAB	CDMA2000 (1xEV-DO, Rev. 0)	CDMA2000	3.76	±9.6
10404	AAB	CDMA2000 (1xEV-DO, Rev. A)	CDMA2000	3.77	±9.6
10406	AAB	CDMA2000, RC3, SO32, SCH0, Full Rate	CDMA2000	5.22	±9.6
10410	AAH	LTE-TDD (SC-FDMA, 1 RB, 10 MHz, QPSK, UL Subframe=2,3,4,7,8,9, Subframe Conf=4)	LTE-TDD	7.82	±9.6
10414	AAA	WLAN CCDF, 64-QAM, 40 MHz	Generic	8.54	±9.6
10415	AAA	IEEE 802.11b WiFi 2.4 GHz (DSSS, 1 Mbps, 99pc duty cycle)	WLAN	1.54	±9.6
10416	AAA	IEEE 802.11g WiFi 2.4 GHz (ERP-OFDM, 6 Mbps, 99pc duty cycle)	WLAN	8.23	±9.6
10417	AAC	IEEE 802.11a/h WiFi 5 GHz (OFDM, 6 Mbps, 99pc duty cycle)	WLAN	8.23	±9.6
10418	AAA	IEEE 802.11g WiFi 2.4 GHz (DSSS-OFDM, 6 Mbps, 99pc duty cycle, Long preamble)	WLAN	8.14	±9.6
10419	AAA	IEEE 802.11g WiFi 2.4 GHz (DSSS-OFDM, 6 Mbps, 99pc duty cycle, Short preamble)	WLAN	8.19	±9.6
10422	AAC	IEEE 802.11n (HT Greenfield, 7.2 Mbps, BPSK)	WLAN	8.32	±9.6
10423	AAC	IEEE 802.11n (HT Greenfield, 43.3 Mbps, 16-QAM)	WLAN	8.47	±9.6
10424	AAC	IEEE 802.11n (HT Greenfield, 72.2 Mbps, 64-QAM)	WLAN	8.40	±9.6
10425	AAC	IEEE 802.11n (HT Greenfield, 15 Mbps, BPSK)	WLAN	8.41	±9.6
10426	AAC	IEEE 802.11n (HT Greenfield, 90 Mbps, 16-QAM)	WLAN	8.45	±9.6
10427	AAC	IEEE 802.11n (HT Greenfield, 150 Mbps, 64-QAM)	WLAN	8.41	±9.6
10430	AAE	LTE-FDD (OFDMA, 5 MHz, E-TM 3.1)	LTE-FDD	8.28	±9.6
10431	AAE	LTE-FDD (OFDMA, 10 MHz, E-TM 3.1)	LTE-FDD	8.38	±9.6
10432	AAD	LTE-FDD (OFDMA, 15 MHz, E-TM 3.1)	LTE-FDD	8.34	±9.6
10433	AAD	LTE-FDD (OFDMA, 20 MHz, E-TM 3.1)	LTE-FDD	8.34	±9.6
10434	AAB	W-CDMA (BS Test Model 1, 64 DPCH)	WCDMA	8.60	±9.6
10435	AAG	LTE-TDD (SC-FDMA, 1 RB, 20 MHz, QPSK, UL Subframe=2,3,4,7,8,9)	LTE-TDD	7.82	±9.6
10447	AAE	LTE-FDD (OFDMA, 5 MHz, E-TM 3.1, Clipping 44%)	LTE-FDD	7.56	±9.6
10448	AAE	LTE-FDD (OFDMA, 10 MHz, E-TM 3.1, Clipping 44%)	LTE-FDD	7.53	±9.6
10449	AAD	LTE-FDD (OFDMA, 15 MHz, E-TM 3.1, Clipping 44%)	LTE-FDD	7.51	±9.6
10450	AAD	LTE-FDD (OFDMA, 20 MHz, E-TM 3.1, Clipping 44%)	LTE-FDD	7.48	±9.6
10451	AAB	W-CDMA (BS Test Model 1, 64 DPCH, Clipping 44%)	WCDMA	7.59	±9.6
10453	AAE	Validation (Square, 10 ms, 1 ms)	Test	10.00	±9.6
10456	AAC	IEEE 802.11ac WiFi (160 MHz, 64-QAM, 99pc duty cycle)	WLAN	8.63	±9.6
10457	AAB	UMTS-FDD (DC-HSDPA)	WCDMA	6.62	±9.6
10458	AAA	CDMA2000 (1xEV-DO, Rev. B, 2 carriers)	CDMA2000	6.55	±9.6
10459	AAA	CDMA2000 (1xEV-DO, Rev. B, 3 carriers)	CDMA2000	8.25	±9.6
10460	AAB	UMTS-FDD (WCDMA, AMR)	WCDMA	2.39	±9.6
10461	AAC	LTE-TDD (SC-FDMA, 1 RB, 1.4 MHz, QPSK, UL Subframe=2,3,4,7,8,9)	LTE-TDD	7.82	±9.6
10462	AAC	LTE-TDD (SC-FDMA, 1 RB, 1.4 MHz, 16-QAM, UL Subframe=2,3,4,7,8,9)	LTE-TDD	8.30	±9.6
10463	AAC	LTE-TDD (SC-FDMA, 1 RB, 1.4 MHz, 64-QAM, UL Subframe=2,3,4,7,8,9)	LTE-TDD	8.56	±9.6
10464	AAD	LTE-TDD (SC-FDMA, 1 RB, 3 MHz, QPSK, UL Subframe=2,3,4,7,8,9)	LTE-TDD	7.82	±9.6
10465	AAD	LTE-TDD (SC-FDMA, 1 RB, 3 MHz, 16-QAM, UL Subframe=2,3,4,7,8,9)	LTE-TDD	8.32	±9.6
10466	AAD	LTE-TDD (SC-FDMA, 1 RB, 3 MHz, 64-QAM, UL Subframe=2,3,4,7,8,9)	LTE-TDD	8.57	±9.6
10467	AAG	LTE-TDD (SC-FDMA, 1 RB, 5 MHz, QPSK, UL Subframe=2,3,4,7,8,9)	LTE-TDD	7.82	±9.6
10468	AAG	LTE-TDD (SC-FDMA, 1 RB, 5 MHz, 16-QAM, UL Subframe=2,3,4,7,8,9)	LTE-TDD	8.32	±9.6
10469	AAG	LTE-TDD (SC-FDMA, 1 RB, 5 MHz, 64-QAM, UL Subframe=2,3,4,7,8,9)	LTE-TDD	8.56	±9.6
10470	AAG	LTE-TDD (SC-FDMA, 1 RB, 10 MHz, QPSK, UL Subframe=2,3,4,7,8,9)	LTE-TDD	7.82	±9.6
10471	AAG	LTE-TDD (SC-FDMA, 1 RB, 10 MHz, 16-QAM, UL Subframe=2,3,4,7,8,9)	LTE-TDD	8.32	±9.6

UID	Rev	Communication System Name	Group	PAR (dB)	Unc ^E k = 2
10472	AAG	LTE-TDD (SC-FDMA, 1 RB, 10 MHz, 64-QAM, UL Subframe=2,3,4,7,8,9)	LTE-TDD	8.57	±9.6
10473	AAF	LTE-TDD (SC-FDMA, 1 RB, 15 MHz, QPSK, UL Subframe=2,3,4,7,8,9)	LTE-TDD	7.82	±9.6
10474	AAF	LTE-TDD (SC-FDMA, 1 RB, 15 MHz, 16-QAM, UL Subframe=2,3,4,7,8,9)	LTE-TDD	8.32	±9.6
10475	AAF	LTE-TDD (SC-FDMA, 1 RB, 15 MHz, 64-QAM, UL Subframe=2,3,4,7,8,9)	LTE-TDD	8.57	±9.6
10477	AAG	LTE-TDD (SC-FDMA, 1 RB, 20 MHz, 16-QAM, UL Subframe=2,3,4,7,8,9)	LTE-TDD	8.32	±9.6
10478	AAG	LTE-TDD (SC-FDMA, 1 RB, 20 MHz, 64-QAM, UL Subframe=2,3,4,7,8,9)	LTE-TDD	8.57	±9.6
10479	AAC	LTE-TDD (SC-FDMA, 50% RB, 1.4 MHz, QPSK, UL Subframe=2,3,4,7,8,9)	LTE-TDD	7.74	±9.6
10480	AAC	LTE-TDD (SC-FDMA, 50% RB, 1.4 MHz, 16-QAM, UL Subframe=2,3,4,7,8,9)	LTE-TDD	8.18	±9.6
10481	AAC	LTE-TDD (SC-FDMA, 50% RB, 1.4 MHz, 64-QAM, UL Subframe=2,3,4,7,8,9)	LTE-TDD	8.45	±9.6
10482	AAD	LTE-TDD (SC-FDMA, 50% RB, 3 MHz, QPSK, UL Subframe=2,3,4,7,8,9)	LTE-TDD	7.71	±9.6
10483	AAD	LTE-TDD (SC-FDMA, 50% RB, 3 MHz, 16-QAM, UL Subframe=2,3,4,7,8,9)	LTE-TDD	8.39	±9.6
10484	AAD	LTE-TDD (SC-FDMA, 50% RB, 3 MHz, 64-QAM, UL Subframe=2,3,4,7,8,9)	LTE-TDD	8.47	±9.6
10485	AAG	LTE-TDD (SC-FDMA, 50% RB, 5 MHz, QPSK, UL Subframe=2,3,4,7,8,9)	LTE-TDD	7.59	±9.6
10486	AAG	LTE-TDD (SC-FDMA, 50% RB, 5 MHz, 16-QAM, UL Subframe=2,3,4,7,8,9)	LTE-TDD	8.38	±9.6
10487	AAG	LTE-TDD (SC-FDMA, 50% RB, 5 MHz, 64-QAM, UL Subframe=2,3,4,7,8,9)	LTE-TDD	8.60	±9.6
10488	AAG	LTE-TDD (SC-FDMA, 50% RB, 10 MHz, QPSK, UL Subframe=2,3,4,7,8,9)	LTE-TDD	7.70	±9.6
10489	AAG	LTE-TDD (SC-FDMA, 50% RB, 10 MHz, 16-QAM, UL Subframe=2,3,4,7,8,9)	LTE-TDD	8.31	±9.6
10490	AAG	LTE-TDD (SC-FDMA, 50% RB, 10 MHz, 64-QAM, UL Subframe=2,3,4,7,8,9)	LTE-TDD	8.54	±9.6
10491	AAF	LTE-TDD (SC-FDMA, 50% RB, 15 MHz, QPSK, UL Subframe=2,3,4,7,8,9)	LTE-TDD	7.74	±9.6
10492	AAF	LTE-TDD (SC-FDMA, 50% RB, 15 MHz, 16-QAM, UL Subframe=2,3,4,7,8,9)	LTE-TDD	8.41	±9.6
10493	AAF	LTE-TDD (SC-FDMA, 50% RB, 15 MHz, 64-QAM, UL Subframe=2,3,4,7,8,9)	LTE-TDD	8.55	±9.6
10494	AAG	LTE-TDD (SC-FDMA, 50% RB, 20 MHz, QPSK, UL Subframe=2,3,4,7,8,9)	LTE-TDD	7.74	±9.6
10495	AAG	LTE-TDD (SC-FDMA, 50% RB, 20 MHz, 16-QAM, UL Subframe=2,3,4,7,8,9)	LTE-TDD	8.37	±9.6
10496	AAG	LTE-TDD (SC-FDMA, 50% RB, 20 MHz, 64-QAM, UL Subframe=2,3,4,7,8,9)	LTE-TDD	8.54	±9.6
10497	AAC	LTE-TDD (SC-FDMA, 100% RB, 1.4 MHz, QPSK, UL Subframe=2,3,4,7,8,9)	LTE-TDD	7.67	±9.6
10498	AAC	LTE-TDD (SC-FDMA, 100% RB, 1.4 MHz, 16-QAM, UL Subframe=2,3,4,7,8,9)	LTE-TDD	8.40	±9.6
10499	AAC	LTE-TDD (SC-FDMA, 100% RB, 1.4 MHz, 64-QAM, UL Subframe=2,3,4,7,8,9)	LTE-TDD	8.68	±9.6
10500	AAD	LTE-TDD (SC-FDMA, 100% RB, 3 MHz, QPSK, UL Subframe=2,3,4,7,8,9)	LTE-TDD	7.67	±9.6
10501	AAD	LTE-TDD (SC-FDMA, 100% RB, 3 MHz, 16-QAM, UL Subframe=2,3,4,7,8,9)	LTE-TDD	8.44	±9.6
10502	AAD	LTE-TDD (SC-FDMA, 100% RB, 3 MHz, 64-QAM, UL Subframe=2,3,4,7,8,9)	LTE-TDD	8.52	±9.6
10503	AAG	LTE-TDD (SC-FDMA, 100% RB, 5 MHz, QPSK, UL Subframe=2,3,4,7,8,9)	LTE-TDD	7.72	±9.6
10504	AAG	LTE-TDD (SC-FDMA, 100% RB, 5 MHz, 16-QAM, UL Subframe=2,3,4,7,8,9)	LTE-TDD	8.31	±9.6
10505	AAG	LTE-TDD (SC-FDMA, 100% RB, 5 MHz, 64-QAM, UL Subframe=2,3,4,7,8,9)	LTE-TDD	8.54	±9.6
10506	AAG	LTE-TDD (SC-FDMA, 100% RB, 10 MHz, QPSK, UL Subframe=2,3,4,7,8,9)	LTE-TDD	7.74	±9.6
10507	AAG	LTE-TDD (SC-FDMA, 100% RB, 10 MHz, 16-QAM, UL Subframe=2,3,4,7,8,9)	LTE-TDD	8.36	±9.6
10508	AAG	LTE-TDD (SC-FDMA, 100% RB, 10 MHz, 64-QAM, UL Subframe=2,3,4,7,8,9)	LTE-TDD	8.55	±9.6
10509	AAF	LTE-TDD (SC-FDMA, 100% RB, 15 MHz, QPSK, UL Subframe=2,3,4,7,8,9)	LTE-TDD	7.99	±9.6
10510	AAF	LTE-TDD (SC-FDMA, 100% RB, 15 MHz, 16-QAM, UL Subframe=2,3,4,7,8,9)	LTE-TDD	8.49	±9.6
10511	AAF	LTE-TDD (SC-FDMA, 100% RB, 15 MHz, 64-QAM, UL Subframe=2,3,4,7,8,9)	LTE-TDD	8.51	±9.6
10512	AAG	LTE-TDD (SC-FDMA, 100% RB, 20 MHz, QPSK, UL Subframe=2,3,4,7,8,9)	LTE-TDD	7.74	±9.6
10513	AAG	LTE-TDD (SC-FDMA, 100% RB, 20 MHz, 16-QAM, UL Subframe=2,3,4,7,8,9)	LTE-TDD	8.42	±9.6
10514	AAG	LTE-TDD (SC-FDMA, 100% RB, 20 MHz, 64-QAM, UL Subframe=2,3,4,7,8,9)	LTE-TDD	8.45	±9.6
10515	AAA	IEEE 802.11b WiFi 2.4 GHz (DSSS, 2 Mbps, 99pc duty cycle)	WLAN	1.58	±9.6
10516	AAA	IEEE 802.11b WiFi 2.4 GHz (DSSS, 5.5 Mbps, 99pc duty cycle)	WLAN	1.57	±9.6
10517	AAA	IEEE 802.11b WiFi 2.4 GHz (DSSS, 11 Mbps, 99pc duty cycle)	WLAN	1.58	±9.6
10518	AAC	IEEE 802.11a/h WiFi 5 GHz (OFDM, 9 Mbps, 99pc duty cycle)	WLAN	8.23	±9.6
10519	AAC	IEEE 802.11a/h WiFi 5 GHz (OFDM, 12 Mbps, 99pc duty cycle)	WLAN	8.39	±9.6
10520	AAC	IEEE 802.11a/h WiFi 5 GHz (OFDM, 18 Mbps, 99pc duty cycle)	WLAN	8.12	±9.6
10521	AAC	IEEE 802.11a/h WiFi 5 GHz (OFDM, 24 Mbps, 99pc duty cycle)	WLAN	7.97	±9.6
10522	AAC	IEEE 802.11a/h WiFi 5 GHz (OFDM, 36 Mbps, 99pc duty cycle)	WLAN	8.45	±9.6
10523	AAC	IEEE 802.11a/h WiFi 5 GHz (OFDM, 48 Mbps, 99pc duty cycle)	WLAN	8.08	±9.6
10524	AAC	IEEE 802.11a/h WiFi 5 GHz (OFDM, 54 Mbps, 99pc duty cycle)	WLAN	8.27	±9.6
10525	AAC	IEEE 802.11ac WiFi (20 MHz, MCS0, 99pc duty cycle)	WLAN	8.36	±9.6
10526	AAC	IEEE 802.11ac WiFi (20 MHz, MCS1, 99pc duty cycle)	WLAN	8.42	±9.6
10527	AAC	IEEE 802.11ac WiFi (20 MHz, MCS2, 99pc duty cycle)	WLAN	8.21	±9.6
10528	AAC	IEEE 802.11ac WiFi (20 MHz, MCS3, 99pc duty cycle)	WLAN	8.36	±9.6
10529	AAC	IEEE 802.11ac WiFi (20 MHz, MCS4, 99pc duty cycle)	WLAN	8.36	±9.6
10531	AAC	IEEE 802.11ac WiFi (20 MHz, MCS6, 99pc duty cycle)	WLAN	8.43	±9.6
10532	AAC	IEEE 802.11ac WiFi (20 MHz, MCS7, 99pc duty cycle)	WLAN	8.29	±9.6
10533	AAC	IEEE 802.11ac WiFi (20 MHz, MCS8, 99pc duty cycle)	WLAN	8.38	±9.6
10534	AAC	IEEE 802.11ac WiFi (40 MHz, MCS0, 99pc duty cycle)	WLAN	8.45	±9.6
10535	AAC	IEEE 802.11ac WiFi (40 MHz, MCS1, 99pc duty cycle)	WLAN	8.45	±9.6
10536	AAC	IEEE 802.11ac WiFi (40 MHz, MCS2, 99pc duty cycle)	WLAN	8.32	±9.6
10537	AAC	IEEE 802.11ac WiFi (40 MHz, MCS3, 99pc duty cycle)	WLAN	8.44	±9.6
10538	AAC	IEEE 802.11ac WiFi (40 MHz, MCS4, 99pc duty cycle)	WLAN	8.54	±9.6
10540	AAC	IEEE 802.11ac WiFi (40 MHz, MCS6, 99pc duty cycle)	WLAN	8.39	±9.6

UID	Rev	Communication System Name	Group	PAR (dB)	Unc ^E k = 2
10541	AAC	IEEE 802.11ac WiFi (40 MHz, MCS7, 99pc duty cycle)	WLAN	8.46	±9.6
10542	AAC	IEEE 802.11ac WiFi (40 MHz, MCS8, 99pc duty cycle)	WLAN	8.65	±9.6
10543	AAC	IEEE 802.11ac WiFi (40 MHz, MCS9, 99pc duty cycle)	WLAN	8.65	±9.6
10544	AAC	IEEE 802.11ac WiFi (80 MHz, MCS0, 99pc duty cycle)	WLAN	8.47	±9.6
10545	AAC	IEEE 802.11ac WiFi (80 MHz, MCS1, 99pc duty cycle)	WLAN	8.55	±9.6
10546	AAC	IEEE 802.11ac WiFi (80 MHz, MCS2, 99pc duty cycle)	WLAN	8.35	±9.6
10547	AAC	IEEE 802.11ac WiFi (80 MHz, MCS3, 99pc duty cycle)	WLAN	8.49	±9.6
10548	AAC	IEEE 802.11ac WiFi (80 MHz, MCS4, 99pc duty cycle)	WLAN	8.37	±9.6
10550	AAC	IEEE 802.11ac WiFi (80 MHz, MCS6, 99pc duty cycle)	WLAN	8.38	±9.6
10551	AAC	IEEE 802.11ac WiFi (80 MHz, MCS7, 99pc duty cycle)	WLAN	8.50	±9.6
10552	AAC	IEEE 802.11ac WiFi (80 MHz, MCS8, 99pc duty cycle)	WLAN	8.42	±9.6
10553	AAC	IEEE 802.11ac WiFi (80 MHz, MCS9, 99pc duty cycle)	WLAN	8.45	±9.6
10554	AAD	IEEE 802.11ac WiFi (160 MHz, MCS0, 99pc duty cycle)	WLAN	8.48	±9.6
10555	AAD	IEEE 802.11ac WiFi (160 MHz, MCS1, 99pc duty cycle)	WLAN	8.47	±9.6
10556	AAD	IEEE 802.11ac WiFi (160 MHz, MCS2, 99pc duty cycle)	WLAN	8.50	±9.6
10557	AAD	IEEE 802.11ac WiFi (160 MHz, MCS3, 99pc duty cycle)	WLAN	8.52	±9.6
10558	AAD	IEEE 802.11ac WiFi (160 MHz, MCS4, 99pc duty cycle)	WLAN	8.61	±9.6
10560	AAD	IEEE 802.11ac WiFi (160 MHz, MCS6, 99pc duty cycle)	WLAN	8.73	±9.6
10561	AAD	IEEE 802.11ac WiFi (160 MHz, MCS7, 99pc duty cycle)	WLAN	8.56	±9.6
10562	AAD	IEEE 802.11ac WiFi (160 MHz, MCS8, 99pc duty cycle)	WLAN	8.69	±9.6
10563	AAD	IEEE 802.11ac WiFi (160 MHz, MCS9, 99pc duty cycle)	WLAN	8.77	±9.6
10564	AAA	IEEE 802.11g WiFi 2.4 GHz (DSSS-OFDM, 9Mbps, 99pc duty cycle)	WLAN	8.25	±9.6
10565	AAA	IEEE 802.11g WiFi 2.4 GHz (DSSS-OFDM, 12Mbps, 99pc duty cycle)	WLAN	8.45	±9.6
10566	AAA	IEEE 802.11g WiFi 2.4 GHz (DSSS-OFDM, 18Mbps, 99pc duty cycle)	WLAN	8.13	±9.6
10567	AAA	IEEE 802.11g WiFi 2.4 GHz (DSSS-OFDM, 24Mbps, 99pc duty cycle)	WLAN	8.00	±9.6
10568	AAA	IEEE 802.11g WiFi 2.4 GHz (DSSS-OFDM, 36Mbps, 99pc duty cycle)	WLAN	8.37	±9.6
10569	AAA	IEEE 802.11g WiFi 2.4 GHz (DSSS-OFDM, 48Mbps, 99pc duty cycle)	WLAN	8.10	±9.6
10570	AAA	IEEE 802.11g WiFi 2.4 GHz (DSSS-OFDM, 54Mbps, 99pc duty cycle)	WLAN	8.30	±9.6
10571	AAA	IEEE 802.11b WiFi 2.4 GHz (DSSS, 1Mbps, 90pc duty cycle)	WLAN	1.99	±9.6
10572	AAA	IEEE 802.11b WiFi 2.4 GHz (DSSS, 2Mbps, 90pc duty cycle)	WLAN	1.99	±9.6
10573	AAA	IEEE 802.11b WiFi 2.4 GHz (DSSS, 5.5Mbps, 90pc duty cycle)	WLAN	1.98	±9.6
10574	AAA	IEEE 802.11b WiFi 2.4 GHz (DSSS, 11Mbps, 90pc duty cycle)	WLAN	1.98	±9.6
10575	AAA	IEEE 802.11g WiFi 2.4 GHz (DSSS-OFDM, 6Mbps, 90pc duty cycle)	WLAN	8.59	±9.6
10576	AAA	IEEE 802.11g WiFi 2.4 GHz (DSSS-OFDM, 9Mbps, 90pc duty cycle)	WLAN	8.60	±9.6
10577	AAA	IEEE 802.11g WiFi 2.4 GHz (DSSS-OFDM, 12Mbps, 90pc duty cycle)	WLAN	8.70	±9.6
10578	AAA	IEEE 802.11g WiFi 2.4 GHz (DSSS-OFDM, 18Mbps, 90pc duty cycle)	WLAN	8.49	±9.6
10579	AAA	IEEE 802.11g WiFi 2.4 GHz (DSSS-OFDM, 24Mbps, 90pc duty cycle)	WLAN	8.36	±9.6
10580	AAA	IEEE 802.11g WiFi 2.4 GHz (DSSS-OFDM, 36Mbps, 90pc duty cycle)	WLAN	8.76	±9.6
10581	AAA	IEEE 802.11g WiFi 2.4 GHz (DSSS-OFDM, 48Mbps, 90pc duty cycle)	WLAN	8.35	±9.6
10582	AAA	IEEE 802.11g WiFi 2.4 GHz (DSSS-OFDM, 54Mbps, 90pc duty cycle)	WLAN	8.67	±9.6
10583	AAC	IEEE 802.11a/h WiFi 5 GHz (OFDM, 6Mbps, 90pc duty cycle)	WLAN	8.59	±9.6
10584	AAC	IEEE 802.11a/h WiFi 5 GHz (OFDM, 9Mbps, 90pc duty cycle)	WLAN	8.60	±9.6
10585	AAC	IEEE 802.11a/h WiFi 5 GHz (OFDM, 12Mbps, 90pc duty cycle)	WLAN	8.70	±9.6
10586	AAC	IEEE 802.11a/h WiFi 5 GHz (OFDM, 18Mbps, 90pc duty cycle)	WLAN	8.49	±9.6
10587	AAC	IEEE 802.11a/h WiFi 5 GHz (OFDM, 24Mbps, 90pc duty cycle)	WLAN	8.36	±9.6
10588	AAC	IEEE 802.11a/h WiFi 5 GHz (OFDM, 36Mbps, 90pc duty cycle)	WLAN	8.76	±9.6
10589	AAC	IEEE 802.11a/h WiFi 5 GHz (OFDM, 48Mbps, 90pc duty cycle)	WLAN	8.35	±9.6
10590	AAC	IEEE 802.11a/h WiFi 5 GHz (OFDM, 54Mbps, 90pc duty cycle)	WLAN	8.67	±9.6
10591	AAC	IEEE 802.11n (HT Mixed, 20 MHz, MCS0, 90pc duty cycle)	WLAN	8.63	±9.6
10592	AAC	IEEE 802.11n (HT Mixed, 20 MHz, MCS1, 90pc duty cycle)	WLAN	8.79	±9.6
10593	AAC	IEEE 802.11n (HT Mixed, 20 MHz, MCS2, 90pc duty cycle)	WLAN	8.64	±9.6
10594	AAC	IEEE 802.11n (HT Mixed, 20 MHz, MCS3, 90pc duty cycle)	WLAN	8.74	±9.6
10595	AAC	IEEE 802.11n (HT Mixed, 20 MHz, MCS4, 90pc duty cycle)	WLAN	8.74	±9.6
10596	AAC	IEEE 802.11n (HT Mixed, 20 MHz, MCS5, 90pc duty cycle)	WLAN	8.71	±9.6
10597	AAC	IEEE 802.11n (HT Mixed, 20 MHz, MCS6, 90pc duty cycle)	WLAN	8.72	±9.6
10598	AAC	IEEE 802.11n (HT Mixed, 20 MHz, MCS7, 90pc duty cycle)	WLAN	8.50	±9.6
10599	AAC	IEEE 802.11n (HT Mixed, 40 MHz, MCS0, 90pc duty cycle)	WLAN	8.79	±9.6
10600	AAC	IEEE 802.11n (HT Mixed, 40 MHz, MCS1, 90pc duty cycle)	WLAN	8.88	±9.6
10601	AAC	IEEE 802.11n (HT Mixed, 40 MHz, MCS2, 90pc duty cycle)	WLAN	8.82	±9.6
10602	AAC	IEEE 802.11n (HT Mixed, 40 MHz, MCS3, 90pc duty cycle)	WLAN	8.94	±9.6
10603	AAC	IEEE 802.11n (HT Mixed, 40 MHz, MCS4, 90pc duty cycle)	WLAN	9.03	±9.6
10604	AAC	IEEE 802.11n (HT Mixed, 40 MHz, MCS5, 90pc duty cycle)	WLAN	8.76	±9.6
10605	AAC	IEEE 802.11n (HT Mixed, 40 MHz, MCS6, 90pc duty cycle)	WLAN	8.97	±9.6
10606	AAC	IEEE 802.11n (HT Mixed, 40 MHz, MCS7, 90pc duty cycle)	WLAN	8.82	±9.6
10607	AAC	IEEE 802.11ac WiFi (20 MHz, MCS0, 90pc duty cycle)	WLAN	8.64	±9.6
10608	AAC	IEEE 802.11ac WiFi (20 MHz, MCS1, 90pc duty cycle)	WLAN	8.77	±9.6

UID	Rev	Communication System Name	Group	PAR (dB)	Unc ^E k = 2
10609	AAC	IEEE 802.11ac WiFi (20 MHz, MCS2, 90pc duty cycle)	WLAN	8.57	±9.6
10610	AAC	IEEE 802.11ac WiFi (20 MHz, MCS3, 90pc duty cycle)	WLAN	8.78	±9.6
10611	AAC	IEEE 802.11ac WiFi (20 MHz, MCS4, 90pc duty cycle)	WLAN	8.70	±9.6
10612	AAC	IEEE 802.11ac WiFi (20 MHz, MCS5, 90pc duty cycle)	WLAN	8.77	±9.6
10613	AAC	IEEE 802.11ac WiFi (20 MHz, MCS6, 90pc duty cycle)	WLAN	8.94	±9.6
10614	AAC	IEEE 802.11ac WiFi (20 MHz, MCS7, 90pc duty cycle)	WLAN	8.59	±9.6
10615	AAC	IEEE 802.11ac WiFi (20 MHz, MCS8, 90pc duty cycle)	WLAN	8.82	±9.6
10616	AAC	IEEE 802.11ac WiFi (40 MHz, MCS0, 90pc duty cycle)	WLAN	8.82	±9.6
10617	AAC	IEEE 802.11ac WiFi (40 MHz, MCS1, 90pc duty cycle)	WLAN	8.81	±9.6
10618	AAC	IEEE 802.11ac WiFi (40 MHz, MCS2, 90pc duty cycle)	WLAN	8.58	±9.6
10619	AAC	IEEE 802.11ac WiFi (40 MHz, MCS3, 90pc duty cycle)	WLAN	8.86	±9.6
10620	AAC	IEEE 802.11ac WiFi (40 MHz, MCS4, 90pc duty cycle)	WLAN	8.87	±9.6
10621	AAC	IEEE 802.11ac WiFi (40 MHz, MCS5, 90pc duty cycle)	WLAN	8.77	±9.6
10622	AAC	IEEE 802.11ac WiFi (40 MHz, MCS6, 90pc duty cycle)	WLAN	8.68	±9.6
10623	AAC	IEEE 802.11ac WiFi (40 MHz, MCS7, 90pc duty cycle)	WLAN	8.82	±9.6
10624	AAC	IEEE 802.11ac WiFi (40 MHz, MCS8, 90pc duty cycle)	WLAN	8.96	±9.6
10625	AAC	IEEE 802.11ac WiFi (40 MHz, MCS9, 90pc duty cycle)	WLAN	8.96	±9.6
10626	AAC	IEEE 802.11ac WiFi (80 MHz, MCS0, 90pc duty cycle)	WLAN	8.83	±9.6
10627	AAC	IEEE 802.11ac WiFi (80 MHz, MCS1, 90pc duty cycle)	WLAN	8.88	±9.6
10628	AAC	IEEE 802.11ac WiFi (80 MHz, MCS2, 90pc duty cycle)	WLAN	8.71	±9.6
10629	AAC	IEEE 802.11ac WiFi (80 MHz, MCS3, 90pc duty cycle)	WLAN	8.85	±9.6
10630	AAC	IEEE 802.11ac WiFi (80 MHz, MCS4, 90pc duty cycle)	WLAN	8.72	±9.6
10631	AAC	IEEE 802.11ac WiFi (80 MHz, MCS5, 90pc duty cycle)	WLAN	8.81	±9.6
10632	AAC	IEEE 802.11ac WiFi (80 MHz, MCS6, 90pc duty cycle)	WLAN	8.74	±9.6
10633	AAC	IEEE 802.11ac WiFi (80 MHz, MCS7, 90pc duty cycle)	WLAN	8.83	±9.6
10634	AAC	IEEE 802.11ac WiFi (80 MHz, MCS8, 90pc duty cycle)	WLAN	8.80	±9.6
10635	AAC	IEEE 802.11ac WiFi (80 MHz, MCS9, 90pc duty cycle)	WLAN	8.81	±9.6
10636	AAD	IEEE 802.11ac WiFi (160 MHz, MCS0, 90pc duty cycle)	WLAN	8.83	±9.6
10637	AAD	IEEE 802.11ac WiFi (160 MHz, MCS1, 90pc duty cycle)	WLAN	8.79	±9.6
10638	AAD	IEEE 802.11ac WiFi (160 MHz, MCS2, 90pc duty cycle)	WLAN	8.86	±9.6
10639	AAD	IEEE 802.11ac WiFi (160 MHz, MCS3, 90pc duty cycle)	WLAN	8.85	±9.6
10640	AAD	IEEE 802.11ac WiFi (160 MHz, MCS4, 90pc duty cycle)	WLAN	8.98	±9.6
10641	AAD	IEEE 802.11ac WiFi (160 MHz, MCS5, 90pc duty cycle)	WLAN	9.06	±9.6
10642	AAD	IEEE 802.11ac WiFi (160 MHz, MCS6, 90pc duty cycle)	WLAN	9.06	±9.6
10643	AAD	IEEE 802.11ac WiFi (160 MHz, MCS7, 90pc duty cycle)	WLAN	8.89	±9.6
10644	AAD	IEEE 802.11ac WiFi (160 MHz, MCS8, 90pc duty cycle)	WLAN	9.05	±9.6
10645	AAD	IEEE 802.11ac WiFi (160 MHz, MCS9, 90pc duty cycle)	WLAN	9.11	±9.6
10646	AAH	LTE-TDD (SC-FDMA, 1 RB, 5 MHz, QPSK, UL Subframe=2,7)	LTE-TDD	11.96	±9.6
10647	AAG	LTE-TDD (SC-FDMA, 1 RB, 20 MHz, QPSK, UL Subframe=2,7)	LTE-TDD	11.96	±9.6
10648	AAA	CDMA2000 (1x Advanced)	CDMA2000	3.45	±9.6
10652	AAF	LTE-TDD (OFDMA, 5 MHz, E-TM 3.1, Clipping 44%)	LTE-TDD	6.91	±9.6
10653	AAF	LTE-TDD (OFDMA, 10 MHz, E-TM 3.1, Clipping 44%)	LTE-TDD	7.42	±9.6
10654	AAE	LTE-TDD (OFDMA, 15 MHz, E-TM 3.1, Clipping 44%)	LTE-TDD	6.96	±9.6
10655	AAF	LTE-TDD (OFDMA, 20 MHz, E-TM 3.1, Clipping 44%)	LTE-TDD	7.21	±9.6
10658	AAB	Pulse Waveform (200Hz, 10%)	Test	10.00	±9.6
10659	AAB	Pulse Waveform (200Hz, 20%)	Test	6.99	±9.6
10660	AAB	Pulse Waveform (200Hz, 40%)	Test	3.98	±9.6
10661	AAB	Pulse Waveform (200Hz, 60%)	Test	2.22	±9.6
10662	AAB	Pulse Waveform (200Hz, 80%)	Test	0.97	±9.6
10670	AAA	Bluetooth Low Energy	Bluetooth	2.19	±9.6
10671	AAC	IEEE 802.11ax (20 MHz, MCS0, 90pc duty cycle)	WLAN	9.09	±9.6
10672	AAC	IEEE 802.11ax (20 MHz, MCS1, 90pc duty cycle)	WLAN	8.57	±9.6
10673	AAC	IEEE 802.11ax (20 MHz, MCS2, 90pc duty cycle)	WLAN	8.78	±9.6
10674	AAC	IEEE 802.11ax (20 MHz, MCS3, 90pc duty cycle)	WLAN	8.74	±9.6
10675	AAC	IEEE 802.11ax (20 MHz, MCS4, 90pc duty cycle)	WLAN	8.90	±9.6
10676	AAC	IEEE 802.11ax (20 MHz, MCS5, 90pc duty cycle)	WLAN	8.77	±9.6
10677	AAC	IEEE 802.11ax (20 MHz, MCS6, 90pc duty cycle)	WLAN	8.73	±9.6
10678	AAC	IEEE 802.11ax (20 MHz, MCS7, 90pc duty cycle)	WLAN	8.78	±9.6
10679	AAC	IEEE 802.11ax (20 MHz, MCS8, 90pc duty cycle)	WLAN	8.89	±9.6
10680	AAC	IEEE 802.11ax (20 MHz, MCS9, 90pc duty cycle)	WLAN	8.80	±9.6
10681	AAC	IEEE 802.11ax (20 MHz, MCS10, 90pc duty cycle)	WLAN	8.62	±9.6
10682	AAC	IEEE 802.11ax (20 MHz, MCS11, 90pc duty cycle)	WLAN	8.83	±9.6
10683	AAC	IEEE 802.11ax (20 MHz, MCS0, 99pc duty cycle)	WLAN	8.42	±9.6
10684	AAC	IEEE 802.11ax (20 MHz, MCS1, 99pc duty cycle)	WLAN	8.26	±9.6
10685	AAC	IEEE 802.11ax (20 MHz, MCS2, 99pc duty cycle)	WLAN	8.33	±9.6
10686	AAC	IEEE 802.11ax (20 MHz, MCS3, 99pc duty cycle)	WLAN	8.28	±9.6

UID	Rev	Communication System Name	Group	PAR (dB)	Unc ^E k = 2
10687	AAC	IEEE 802.11ax (20 MHz, MCS4, 99pc duty cycle)	WLAN	8.45	±9.6
10688	AAC	IEEE 802.11ax (20 MHz, MCS5, 99pc duty cycle)	WLAN	8.29	±9.6
10689	AAC	IEEE 802.11ax (20 MHz, MCS6, 99pc duty cycle)	WLAN	8.55	±9.6
10690	AAC	IEEE 802.11ax (20 MHz, MCS7, 99pc duty cycle)	WLAN	8.29	±9.6
10691	AAC	IEEE 802.11ax (20 MHz, MCS8, 99pc duty cycle)	WLAN	8.25	±9.6
10692	AAC	IEEE 802.11ax (20 MHz, MCS9, 99pc duty cycle)	WLAN	8.29	±9.6
10693	AAC	IEEE 802.11ax (20 MHz, MCS10, 99pc duty cycle)	WLAN	8.25	±9.6
10694	AAC	IEEE 802.11ax (20 MHz, MCS11, 99pc duty cycle)	WLAN	8.57	±9.6
10695	AAC	IEEE 802.11ax (40 MHz, MCS0, 90pc duty cycle)	WLAN	8.78	±9.6
10696	AAC	IEEE 802.11ax (40 MHz, MCS1, 90pc duty cycle)	WLAN	8.91	±9.6
10697	AAC	IEEE 802.11ax (40 MHz, MCS2, 90pc duty cycle)	WLAN	8.61	±9.6
10698	AAC	IEEE 802.11ax (40 MHz, MCS3, 90pc duty cycle)	WLAN	8.89	±9.6
10699	AAC	IEEE 802.11ax (40 MHz, MCS4, 90pc duty cycle)	WLAN	8.82	±9.6
10700	AAC	IEEE 802.11ax (40 MHz, MCS5, 90pc duty cycle)	WLAN	8.73	±9.6
10701	AAC	IEEE 802.11ax (40 MHz, MCS6, 90pc duty cycle)	WLAN	8.86	±9.6
10702	AAC	IEEE 802.11ax (40 MHz, MCS7, 90pc duty cycle)	WLAN	8.70	±9.6
10703	AAC	IEEE 802.11ax (40 MHz, MCS8, 90pc duty cycle)	WLAN	8.82	±9.6
10704	AAC	IEEE 802.11ax (40 MHz, MCS9, 90pc duty cycle)	WLAN	8.56	±9.6
10705	AAC	IEEE 802.11ax (40 MHz, MCS10, 90pc duty cycle)	WLAN	8.69	±9.6
10706	AAC	IEEE 802.11ax (40 MHz, MCS11, 90pc duty cycle)	WLAN	8.66	±9.6
10707	AAC	IEEE 802.11ax (40 MHz, MCS0, 99pc duty cycle)	WLAN	8.32	±9.6
10708	AAC	IEEE 802.11ax (40 MHz, MCS1, 99pc duty cycle)	WLAN	8.55	±9.6
10709	AAC	IEEE 802.11ax (40 MHz, MCS2, 99pc duty cycle)	WLAN	8.33	±9.6
10710	AAC	IEEE 802.11ax (40 MHz, MCS3, 99pc duty cycle)	WLAN	8.29	±9.6
10711	AAC	IEEE 802.11ax (40 MHz, MCS4, 99pc duty cycle)	WLAN	8.39	±9.6
10712	AAC	IEEE 802.11ax (40 MHz, MCS5, 99pc duty cycle)	WLAN	8.67	±9.6
10713	AAC	IEEE 802.11ax (40 MHz, MCS6, 99pc duty cycle)	WLAN	8.33	±9.6
10714	AAC	IEEE 802.11ax (40 MHz, MCS7, 99pc duty cycle)	WLAN	8.26	±9.6
10715	AAC	IEEE 802.11ax (40 MHz, MCS8, 99pc duty cycle)	WLAN	8.45	±9.6
10716	AAC	IEEE 802.11ax (40 MHz, MCS9, 99pc duty cycle)	WLAN	8.30	±9.6
10717	AAC	IEEE 802.11ax (40 MHz, MCS10, 99pc duty cycle)	WLAN	8.48	±9.6
10718	AAC	IEEE 802.11ax (40 MHz, MCS11, 99pc duty cycle)	WLAN	8.24	±9.6
10719	AAC	IEEE 802.11ax (80 MHz, MCS0, 90pc duty cycle)	WLAN	8.81	±9.6
10720	AAC	IEEE 802.11ax (80 MHz, MCS1, 90pc duty cycle)	WLAN	8.87	±9.6
10721	AAC	IEEE 802.11ax (80 MHz, MCS2, 90pc duty cycle)	WLAN	8.76	±9.6
10722	AAC	IEEE 802.11ax (80 MHz, MCS3, 90pc duty cycle)	WLAN	8.55	±9.6
10723	AAC	IEEE 802.11ax (80 MHz, MCS4, 90pc duty cycle)	WLAN	8.70	±9.6
10724	AAC	IEEE 802.11ax (80 MHz, MCS5, 90pc duty cycle)	WLAN	8.90	±9.6
10725	AAC	IEEE 802.11ax (80 MHz, MCS6, 90pc duty cycle)	WLAN	8.74	±9.6
10726	AAC	IEEE 802.11ax (80 MHz, MCS7, 90pc duty cycle)	WLAN	8.72	±9.6
10727	AAC	IEEE 802.11ax (80 MHz, MCS8, 90pc duty cycle)	WLAN	8.66	±9.6
10728	AAC	IEEE 802.11ax (80 MHz, MCS9, 90pc duty cycle)	WLAN	8.65	±9.6
10729	AAC	IEEE 802.11ax (80 MHz, MCS10, 90pc duty cycle)	WLAN	8.64	±9.6
10730	AAC	IEEE 802.11ax (80 MHz, MCS11, 90pc duty cycle)	WLAN	8.67	±9.6
10731	AAC	IEEE 802.11ax (80 MHz, MCS0, 99pc duty cycle)	WLAN	8.42	±9.6
10732	AAC	IEEE 802.11ax (80 MHz, MCS1, 99pc duty cycle)	WLAN	8.46	±9.6
10733	AAC	IEEE 802.11ax (80 MHz, MCS2, 99pc duty cycle)	WLAN	8.40	±9.6
10734	AAC	IEEE 802.11ax (80 MHz, MCS3, 99pc duty cycle)	WLAN	8.25	±9.6
10735	AAC	IEEE 802.11ax (80 MHz, MCS4, 99pc duty cycle)	WLAN	8.33	±9.6
10736	AAC	IEEE 802.11ax (80 MHz, MCS5, 99pc duty cycle)	WLAN	8.27	±9.6
10737	AAC	IEEE 802.11ax (80 MHz, MCS6, 99pc duty cycle)	WLAN	8.36	±9.6
10738	AAC	IEEE 802.11ax (80 MHz, MCS7, 99pc duty cycle)	WLAN	8.42	±9.6
10739	AAC	IEEE 802.11ax (80 MHz, MCS8, 99pc duty cycle)	WLAN	8.29	±9.6
10740	AAC	IEEE 802.11ax (80 MHz, MCS9, 99pc duty cycle)	WLAN	8.48	±9.6
10741	AAC	IEEE 802.11ax (80 MHz, MCS10, 99pc duty cycle)	WLAN	8.40	±9.6
10742	AAC	IEEE 802.11ax (80 MHz, MCS11, 99pc duty cycle)	WLAN	8.43	±9.6
10743	AAC	IEEE 802.11ax (160 MHz, MCS0, 90pc duty cycle)	WLAN	8.94	±9.6
10744	AAC	IEEE 802.11ax (160 MHz, MCS1, 90pc duty cycle)	WLAN	9.16	±9.6
10745	AAC	IEEE 802.11ax (160 MHz, MCS2, 90pc duty cycle)	WLAN	8.93	±9.6
10746	AAC	IEEE 802.11ax (160 MHz, MCS3, 90pc duty cycle)	WLAN	9.11	±9.6
10747	AAC	IEEE 802.11ax (160 MHz, MCS4, 90pc duty cycle)	WLAN	9.04	±9.6
10748	AAC	IEEE 802.11ax (160 MHz, MCS5, 90pc duty cycle)	WLAN	8.93	±9.6
10749	AAC	IEEE 802.11ax (160 MHz, MCS6, 90pc duty cycle)	WLAN	8.90	±9.6
10750	AAC	IEEE 802.11ax (160 MHz, MCS7, 90pc duty cycle)	WLAN	8.79	±9.6
10751	AAC	IEEE 802.11ax (160 MHz, MCS8, 90pc duty cycle)	WLAN	8.82	±9.6
10752	AAC	IEEE 802.11ax (160 MHz, MCS9, 90pc duty cycle)	WLAN	8.81	±9.6

UID	Rev	Communication System Name	Group	PAR (dB)	Unc ^E k = 2
10753	AAC	IEEE 802.11ax (160 MHz, MCS10, 90pc duty cycle)	WLAN	9.00	±9.6
10754	AAC	IEEE 802.11ax (160 MHz, MCS11, 90pc duty cycle)	WLAN	8.94	±9.6
10755	AAC	IEEE 802.11ax (160 MHz, MCS0, 99pc duty cycle)	WLAN	8.64	±9.6
10756	AAC	IEEE 802.11ax (160 MHz, MCS1, 99pc duty cycle)	WLAN	8.77	±9.6
10757	AAC	IEEE 802.11ax (160 MHz, MCS2, 99pc duty cycle)	WLAN	8.77	±9.6
10758	AAC	IEEE 802.11ax (160 MHz, MCS3, 99pc duty cycle)	WLAN	8.69	±9.6
10759	AAC	IEEE 802.11ax (160 MHz, MCS4, 99pc duty cycle)	WLAN	8.58	±9.6
10760	AAC	IEEE 802.11ax (160 MHz, MCS5, 99pc duty cycle)	WLAN	8.49	±9.6
10761	AAC	IEEE 802.11ax (160 MHz, MCS6, 99pc duty cycle)	WLAN	8.58	±9.6
10762	AAC	IEEE 802.11ax (160 MHz, MCS7, 99pc duty cycle)	WLAN	8.49	±9.6
10763	AAC	IEEE 802.11ax (160 MHz, MCS8, 99pc duty cycle)	WLAN	8.53	±9.6
10764	AAC	IEEE 802.11ax (160 MHz, MCS9, 99pc duty cycle)	WLAN	8.54	±9.6
10765	AAC	IEEE 802.11ax (160 MHz, MCS10, 99pc duty cycle)	WLAN	8.54	±9.6
10766	AAC	IEEE 802.11ax (160 MHz, MCS11, 99pc duty cycle)	WLAN	8.51	±9.6
10767	AAE	5G NR (CP-OFDM, 1 RB, 5 MHz, QPSK, 15 kHz)	5G NR FR1 TDD	7.99	±9.6
10768	AAD	5G NR (CP-OFDM, 1 RB, 10 MHz, QPSK, 15 kHz)	5G NR FR1 TDD	8.01	±9.6
10769	AAD	5G NR (CP-OFDM, 1 RB, 15 MHz, QPSK, 15 kHz)	5G NR FR1 TDD	8.01	±9.6
10770	AAD	5G NR (CP-OFDM, 1 RB, 20 MHz, QPSK, 15 kHz)	5G NR FR1 TDD	8.02	±9.6
10771	AAD	5G NR (CP-OFDM, 1 RB, 25 MHz, QPSK, 15 kHz)	5G NR FR1 TDD	8.02	±9.6
10772	AAD	5G NR (CP-OFDM, 1 RB, 30 MHz, QPSK, 15 kHz)	5G NR FR1 TDD	8.23	±9.6
10773	AAD	5G NR (CP-OFDM, 1 RB, 40 MHz, QPSK, 15 kHz)	5G NR FR1 TDD	8.03	±9.6
10774	AAD	5G NR (CP-OFDM, 1 RB, 50 MHz, QPSK, 15 kHz)	5G NR FR1 TDD	8.02	±9.6
10775	AAD	5G NR (CP-OFDM, 50% RB, 5 MHz, QPSK, 15 kHz)	5G NR FR1 TDD	8.31	±9.6
10776	AAD	5G NR (CP-OFDM, 50% RB, 10 MHz, QPSK, 15 kHz)	5G NR FR1 TDD	8.30	±9.6
10777	AAC	5G NR (CP-OFDM, 50% RB, 15 MHz, QPSK, 15 kHz)	5G NR FR1 TDD	8.30	±9.6
10778	AAD	5G NR (CP-OFDM, 50% RB, 20 MHz, QPSK, 15 kHz)	5G NR FR1 TDD	8.34	±9.6
10779	AAC	5G NR (CP-OFDM, 50% RB, 25 MHz, QPSK, 15 kHz)	5G NR FR1 TDD	8.42	±9.6
10780	AAD	5G NR (CP-OFDM, 50% RB, 30 MHz, QPSK, 15 kHz)	5G NR FR1 TDD	8.38	±9.6
10781	AAD	5G NR (CP-OFDM, 50% RB, 40 MHz, QPSK, 15 kHz)	5G NR FR1 TDD	8.38	±9.6
10782	AAD	5G NR (CP-OFDM, 50% RB, 50 MHz, QPSK, 15 kHz)	5G NR FR1 TDD	8.43	±9.6
10783	AAE	5G NR (CP-OFDM, 100% RB, 5 MHz, QPSK, 15 kHz)	5G NR FR1 TDD	8.31	±9.6
10784	AAD	5G NR (CP-OFDM, 100% RB, 10 MHz, QPSK, 15 kHz)	5G NR FR1 TDD	8.29	±9.6
10785	AAD	5G NR (CP-OFDM, 100% RB, 15 MHz, QPSK, 15 kHz)	5G NR FR1 TDD	8.40	±9.6
10786	AAD	5G NR (CP-OFDM, 100% RB, 20 MHz, QPSK, 15 kHz)	5G NR FR1 TDD	8.35	±9.6
10787	AAD	5G NR (CP-OFDM, 100% RB, 25 MHz, QPSK, 15 kHz)	5G NR FR1 TDD	8.44	±9.6
10788	AAD	5G NR (CP-OFDM, 100% RB, 30 MHz, QPSK, 15 kHz)	5G NR FR1 TDD	8.39	±9.6
10789	AAD	5G NR (CP-OFDM, 100% RB, 40 MHz, QPSK, 15 kHz)	5G NR FR1 TDD	8.37	±9.6
10790	AAD	5G NR (CP-OFDM, 100% RB, 50 MHz, QPSK, 15 kHz)	5G NR FR1 TDD	8.39	±9.6
10791	AAE	5G NR (CP-OFDM, 1 RB, 5 MHz, QPSK, 30 kHz)	5G NR FR1 TDD	7.83	±9.6
10792	AAD	5G NR (CP-OFDM, 1 RB, 10 MHz, QPSK, 30 kHz)	5G NR FR1 TDD	7.92	±9.6
10793	AAD	5G NR (CP-OFDM, 1 RB, 15 MHz, QPSK, 30 kHz)	5G NR FR1 TDD	7.95	±9.6
10794	AAD	5G NR (CP-OFDM, 1 RB, 20 MHz, QPSK, 30 kHz)	5G NR FR1 TDD	7.82	±9.6
10795	AAD	5G NR (CP-OFDM, 1 RB, 25 MHz, QPSK, 30 kHz)	5G NR FR1 TDD	7.84	±9.6
10796	AAD	5G NR (CP-OFDM, 1 RB, 30 MHz, QPSK, 30 kHz)	5G NR FR1 TDD	7.82	±9.6
10797	AAD	5G NR (CP-OFDM, 1 RB, 40 MHz, QPSK, 30 kHz)	5G NR FR1 TDD	8.01	±9.6
10798	AAD	5G NR (CP-OFDM, 1 RB, 50 MHz, QPSK, 30 kHz)	5G NR FR1 TDD	7.89	±9.6
10799	AAD	5G NR (CP-OFDM, 1 RB, 60 MHz, QPSK, 30 kHz)	5G NR FR1 TDD	7.93	±9.6
10801	AAD	5G NR (CP-OFDM, 1 RB, 80 MHz, QPSK, 30 kHz)	5G NR FR1 TDD	7.89	±9.6
10802	AAD	5G NR (CP-OFDM, 1 RB, 90 MHz, QPSK, 30 kHz)	5G NR FR1 TDD	7.87	±9.6
10803	AAD	5G NR (CP-OFDM, 1 RB, 100 MHz, QPSK, 30 kHz)	5G NR FR1 TDD	7.93	±9.6
10805	AAD	5G NR (CP-OFDM, 50% RB, 10 MHz, QPSK, 30 kHz)	5G NR FR1 TDD	8.34	±9.6
10806	AAD	5G NR (CP-OFDM, 50% RB, 15 MHz, QPSK, 30 kHz)	5G NR FR1 TDD	8.37	±9.6
10809	AAD	5G NR (CP-OFDM, 50% RB, 30 MHz, QPSK, 30 kHz)	5G NR FR1 TDD	8.34	±9.6
10810	AAD	5G NR (CP-OFDM, 50% RB, 40 MHz, QPSK, 30 kHz)	5G NR FR1 TDD	8.34	±9.6
10812	AAD	5G NR (CP-OFDM, 50% RB, 60 MHz, QPSK, 30 kHz)	5G NR FR1 TDD	8.35	±9.6
10817	AAE	5G NR (CP-OFDM, 100% RB, 5 MHz, QPSK, 30 kHz)	5G NR FR1 TDD	8.35	±9.6
10818	AAD	5G NR (CP-OFDM, 100% RB, 10 MHz, QPSK, 30 kHz)	5G NR FR1 TDD	8.34	±9.6
10819	AAD	5G NR (CP-OFDM, 100% RB, 15 MHz, QPSK, 30 kHz)	5G NR FR1 TDD	8.33	±9.6
10820	AAD	5G NR (CP-OFDM, 100% RB, 20 MHz, QPSK, 30 kHz)	5G NR FR1 TDD	8.30	±9.6
10821	AAD	5G NR (CP-OFDM, 100% RB, 25 MHz, QPSK, 30 kHz)	5G NR FR1 TDD	8.41	±9.6
10822	AAD	5G NR (CP-OFDM, 100% RB, 30 MHz, QPSK, 30 kHz)	5G NR FR1 TDD	8.41	±9.6
10823	AAD	5G NR (CP-OFDM, 100% RB, 40 MHz, QPSK, 30 kHz)	5G NR FR1 TDD	8.36	±9.6
10824	AAD	5G NR (CP-OFDM, 100% RB, 50 MHz, QPSK, 30 kHz)	5G NR FR1 TDD	8.39	±9.6
10825	AAD	5G NR (CP-OFDM, 100% RB, 60 MHz, QPSK, 30 kHz)	5G NR FR1 TDD	8.41	±9.6
10827	AAD	5G NR (CP-OFDM, 100% RB, 80 MHz, QPSK, 30 kHz)	5G NR FR1 TDD	8.42	±9.6
10828	AAD	5G NR (CP-OFDM, 100% RB, 90 MHz, QPSK, 30 kHz)	5G NR FR1 TDD	8.43	±9.6

UID	Rev	Communication System Name	Group	PAR (dB)	Unc ^E k = 2
10829	AAD	5G NR (CP-OFDM, 100% RB, 100 MHz, QPSK, 30 kHz)	5G NR FR1 TDD	8.40	±9.6
10830	AAD	5G NR (CP-OFDM, 1 RB, 10 MHz, QPSK, 60 kHz)	5G NR FR1 TDD	7.63	±9.6
10831	AAD	5G NR (CP-OFDM, 1 RB, 15 MHz, QPSK, 60 kHz)	5G NR FR1 TDD	7.73	±9.6
10832	AAD	5G NR (CP-OFDM, 1 RB, 20 MHz, QPSK, 60 kHz)	5G NR FR1 TDD	7.74	±9.6
10833	AAD	5G NR (CP-OFDM, 1 RB, 25 MHz, QPSK, 60 kHz)	5G NR FR1 TDD	7.70	±9.6
10834	AAD	5G NR (CP-OFDM, 1 RB, 30 MHz, QPSK, 60 kHz)	5G NR FR1 TDD	7.75	±9.6
10835	AAD	5G NR (CP-OFDM, 1 RB, 40 MHz, QPSK, 60 kHz)	5G NR FR1 TDD	7.70	±9.6
10836	AAD	5G NR (CP-OFDM, 1 RB, 50 MHz, QPSK, 60 kHz)	5G NR FR1 TDD	7.66	±9.6
10837	AAD	5G NR (CP-OFDM, 1 RB, 60 MHz, QPSK, 60 kHz)	5G NR FR1 TDD	7.68	±9.6
10839	AAD	5G NR (CP-OFDM, 1 RB, 80 MHz, QPSK, 60 kHz)	5G NR FR1 TDD	7.70	±9.6
10840	AAD	5G NR (CP-OFDM, 1 RB, 90 MHz, QPSK, 60 kHz)	5G NR FR1 TDD	7.67	±9.6
10841	AAD	5G NR (CP-OFDM, 1 RB, 100 MHz, QPSK, 60 kHz)	5G NR FR1 TDD	7.71	±9.6
10843	AAD	5G NR (CP-OFDM, 50% RB, 15 MHz, QPSK, 60 kHz)	5G NR FR1 TDD	8.49	±9.6
10844	AAD	5G NR (CP-OFDM, 50% RB, 20 MHz, QPSK, 60 kHz)	5G NR FR1 TDD	8.34	±9.6
10846	AAD	5G NR (CP-OFDM, 50% RB, 30 MHz, QPSK, 60 kHz)	5G NR FR1 TDD	8.41	±9.6
10854	AAD	5G NR (CP-OFDM, 100% RB, 10 MHz, QPSK, 60 kHz)	5G NR FR1 TDD	8.34	±9.6
10855	AAD	5G NR (CP-OFDM, 100% RB, 15 MHz, QPSK, 60 kHz)	5G NR FR1 TDD	8.36	±9.6
10856	AAD	5G NR (CP-OFDM, 100% RB, 20 MHz, QPSK, 60 kHz)	5G NR FR1 TDD	8.37	±9.6
10857	AAD	5G NR (CP-OFDM, 100% RB, 25 MHz, QPSK, 60 kHz)	5G NR FR1 TDD	8.35	±9.6
10858	AAD	5G NR (CP-OFDM, 100% RB, 30 MHz, QPSK, 60 kHz)	5G NR FR1 TDD	8.36	±9.6
10859	AAD	5G NR (CP-OFDM, 100% RB, 40 MHz, QPSK, 60 kHz)	5G NR FR1 TDD	8.34	±9.6
10860	AAD	5G NR (CP-OFDM, 100% RB, 50 MHz, QPSK, 60 kHz)	5G NR FR1 TDD	8.41	±9.6
10861	AAD	5G NR (CP-OFDM, 100% RB, 60 MHz, QPSK, 60 kHz)	5G NR FR1 TDD	8.40	±9.6
10863	AAD	5G NR (CP-OFDM, 100% RB, 80 MHz, QPSK, 60 kHz)	5G NR FR1 TDD	8.41	±9.6
10864	AAD	5G NR (CP-OFDM, 100% RB, 90 MHz, QPSK, 60 kHz)	5G NR FR1 TDD	8.37	±9.6
10865	AAD	5G NR (CP-OFDM, 100% RB, 100 MHz, QPSK, 60 kHz)	5G NR FR1 TDD	8.41	±9.6
10866	AAD	5G NR (DFT-s-OFDM, 1 RB, 100 MHz, QPSK, 30 kHz)	5G NR FR1 TDD	5.68	±9.6
10868	AAD	5G NR (DFT-s-OFDM, 100% RB, 100 MHz, QPSK, 30 kHz)	5G NR FR1 TDD	5.89	±9.6
10869	AAE	5G NR (DFT-s-OFDM, 1 RB, 100 MHz, QPSK, 120 kHz)	5G NR FR2 TDD	5.75	±9.6
10870	AAE	5G NR (DFT-s-OFDM, 100% RB, 100 MHz, QPSK, 120 kHz)	5G NR FR2 TDD	5.86	±9.6
10871	AAE	5G NR (DFT-s-OFDM, 1 RB, 100 MHz, 16QAM, 120 kHz)	5G NR FR2 TDD	5.75	±9.6
10872	AAE	5G NR (DFT-s-OFDM, 100% RB, 100 MHz, 16QAM, 120 kHz)	5G NR FR2 TDD	6.52	±9.6
10873	AAE	5G NR (DFT-s-OFDM, 1 RB, 100 MHz, 64QAM, 120 kHz)	5G NR FR2 TDD	6.61	±9.6
10874	AAE	5G NR (DFT-s-OFDM, 100% RB, 100 MHz, 64QAM, 120 kHz)	5G NR FR2 TDD	6.65	±9.6
10875	AAE	5G NR (CP-OFDM, 1 RB, 100 MHz, QPSK, 120 kHz)	5G NR FR2 TDD	7.78	±9.6
10876	AAE	5G NR (CP-OFDM, 100% RB, 100 MHz, QPSK, 120 kHz)	5G NR FR2 TDD	8.39	±9.6
10877	AAE	5G NR (CP-OFDM, 1 RB, 100 MHz, 16QAM, 120 kHz)	5G NR FR2 TDD	7.95	±9.6
10878	AAE	5G NR (CP-OFDM, 100% RB, 100 MHz, 16QAM, 120 kHz)	5G NR FR2 TDD	8.41	±9.6
10879	AAE	5G NR (CP-OFDM, 1 RB, 100 MHz, 64QAM, 120 kHz)	5G NR FR2 TDD	8.12	±9.6
10880	AAE	5G NR (CP-OFDM, 100% RB, 100 MHz, 64QAM, 120 kHz)	5G NR FR2 TDD	8.38	±9.6
10881	AAE	5G NR (DFT-s-OFDM, 1 RB, 50 MHz, QPSK, 120 kHz)	5G NR FR2 TDD	5.75	±9.6
10882	AAE	5G NR (DFT-s-OFDM, 100% RB, 50 MHz, QPSK, 120 kHz)	5G NR FR2 TDD	5.96	±9.6
10883	AAE	5G NR (DFT-s-OFDM, 1 RB, 50 MHz, 16QAM, 120 kHz)	5G NR FR2 TDD	6.57	±9.6
10884	AAE	5G NR (DFT-s-OFDM, 100% RB, 50 MHz, 16QAM, 120 kHz)	5G NR FR2 TDD	6.53	±9.6
10885	AAE	5G NR (DFT-s-OFDM, 1 RB, 50 MHz, 64QAM, 120 kHz)	5G NR FR2 TDD	6.61	±9.6
10886	AAE	5G NR (DFT-s-OFDM, 100% RB, 50 MHz, 64QAM, 120 kHz)	5G NR FR2 TDD	6.65	±9.6
10887	AAE	5G NR (CP-OFDM, 1 RB, 50 MHz, QPSK, 120 kHz)	5G NR FR2 TDD	7.78	±9.6
10888	AAE	5G NR (CP-OFDM, 100% RB, 50 MHz, QPSK, 120 kHz)	5G NR FR2 TDD	8.35	±9.6
10889	AAE	5G NR (CP-OFDM, 1 RB, 50 MHz, 16QAM, 120 kHz)	5G NR FR2 TDD	8.02	±9.6
10890	AAE	5G NR (CP-OFDM, 100% RB, 50 MHz, 16QAM, 120 kHz)	5G NR FR2 TDD	8.40	±9.6
10891	AAE	5G NR (CP-OFDM, 1 RB, 50 MHz, 64QAM, 120 kHz)	5G NR FR2 TDD	8.13	±9.6
10892	AAE	5G NR (CP-OFDM, 100% RB, 50 MHz, 64QAM, 120 kHz)	5G NR FR2 TDD	8.41	±9.6
10897	AAC	5G NR (DFT-s-OFDM, 1 RB, 5 MHz, QPSK, 30 kHz)	5G NR FR1 TDD	5.66	±9.6
10898	AAB	5G NR (DFT-s-OFDM, 1 RB, 10 MHz, QPSK, 30 kHz)	5G NR FR1 TDD	5.67	±9.6
10899	AAB	5G NR (DFT-s-OFDM, 1 RB, 15 MHz, QPSK, 30 kHz)	5G NR FR1 TDD	5.67	±9.6
10900	AAB	5G NR (DFT-s-OFDM, 1 RB, 20 MHz, QPSK, 30 kHz)	5G NR FR1 TDD	5.68	±9.6
10901	AAB	5G NR (DFT-s-OFDM, 1 RB, 25 MHz, QPSK, 30 kHz)	5G NR FR1 TDD	5.68	±9.6
10902	AAB	5G NR (DFT-s-OFDM, 1 RB, 30 MHz, QPSK, 30 kHz)	5G NR FR1 TDD	5.68	±9.6
10903	AAB	5G NR (DFT-s-OFDM, 1 RB, 40 MHz, QPSK, 30 kHz)	5G NR FR1 TDD	5.68	±9.6
10904	AAB	5G NR (DFT-s-OFDM, 1 RB, 50 MHz, QPSK, 30 kHz)	5G NR FR1 TDD	5.68	±9.6
10905	AAB	5G NR (DFT-s-OFDM, 1 RB, 60 MHz, QPSK, 30 kHz)	5G NR FR1 TDD	5.68	±9.6
10906	AAB	5G NR (DFT-s-OFDM, 1 RB, 80 MHz, QPSK, 30 kHz)	5G NR FR1 TDD	5.68	±9.6
10907	AAC	5G NR (DFT-s-OFDM, 50% RB, 5 MHz, QPSK, 30 kHz)	5G NR FR1 TDD	5.78	±9.6
10908	AAB	5G NR (DFT-s-OFDM, 50% RB, 10 MHz, QPSK, 30 kHz)	5G NR FR1 TDD	5.93	±9.6
10909	AAB	5G NR (DFT-s-OFDM, 50% RB, 15 MHz, QPSK, 30 kHz)	5G NR FR1 TDD	5.96	±9.6
10910	AAB	5G NR (DFT-s-OFDM, 50% RB, 20 MHz, QPSK, 30 kHz)	5G NR FR1 TDD	5.83	±9.6

UID	Rev	Communication System Name	Group	PAR (dB)	Unc ^E k = 2
10911	AAB	5G NR (DFT-s-OFDM, 50% RB, 25 MHz, QPSK, 30 kHz)	5G NR FR1 TDD	5.93	±9.6
10912	AAB	5G NR (DFT-s-OFDM, 50% RB, 30 MHz, QPSK, 30 kHz)	5G NR FR1 TDD	5.84	±9.6
10913	AAB	5G NR (DFT-s-OFDM, 50% RB, 40 MHz, QPSK, 30 kHz)	5G NR FR1 TDD	5.84	±9.6
10914	AAB	5G NR (DFT-s-OFDM, 50% RB, 50 MHz, QPSK, 30 kHz)	5G NR FR1 TDD	5.85	±9.6
10915	AAB	5G NR (DFT-s-OFDM, 50% RB, 60 MHz, QPSK, 30 kHz)	5G NR FR1 TDD	5.83	±9.6
10916	AAB	5G NR (DFT-s-OFDM, 50% RB, 80 MHz, QPSK, 30 kHz)	5G NR FR1 TDD	5.87	±9.6
10917	AAB	5G NR (DFT-s-OFDM, 50% RB, 100 MHz, QPSK, 30 kHz)	5G NR FR1 TDD	5.94	±9.6
10918	AAC	5G NR (DFT-s-OFDM, 100% RB, 5 MHz, QPSK, 30 kHz)	5G NR FR1 TDD	5.86	±9.6
10919	AAB	5G NR (DFT-s-OFDM, 100% RB, 10 MHz, QPSK, 30 kHz)	5G NR FR1 TDD	5.86	±9.6
10920	AAB	5G NR (DFT-s-OFDM, 100% RB, 15 MHz, QPSK, 30 kHz)	5G NR FR1 TDD	5.87	±9.6
10921	AAB	5G NR (DFT-s-OFDM, 100% RB, 20 MHz, QPSK, 30 kHz)	5G NR FR1 TDD	5.84	±9.6
10922	AAB	5G NR (DFT-s-OFDM, 100% RB, 25 MHz, QPSK, 30 kHz)	5G NR FR1 TDD	5.82	±9.6
10923	AAB	5G NR (DFT-s-OFDM, 100% RB, 30 MHz, QPSK, 30 kHz)	5G NR FR1 TDD	5.84	±9.6
10924	AAB	5G NR (DFT-s-OFDM, 100% RB, 40 MHz, QPSK, 30 kHz)	5G NR FR1 TDD	5.84	±9.6
10925	AAB	5G NR (DFT-s-OFDM, 100% RB, 50 MHz, QPSK, 30 kHz)	5G NR FR1 TDD	5.95	±9.6
10926	AAB	5G NR (DFT-s-OFDM, 100% RB, 60 MHz, QPSK, 30 kHz)	5G NR FR1 TDD	5.84	±9.6
10927	AAB	5G NR (DFT-s-OFDM, 100% RB, 80 MHz, QPSK, 30 kHz)	5G NR FR1 TDD	5.94	±9.6
10928	AAC	5G NR (DFT-s-OFDM, 1 RB, 5 MHz, QPSK, 15 kHz)	5G NR FR1 FDD	5.52	±9.6
10929	AAC	5G NR (DFT-s-OFDM, 1 RB, 10 MHz, QPSK, 15 kHz)	5G NR FR1 FDD	5.52	±9.6
10930	AAC	5G NR (DFT-s-OFDM, 1 RB, 15 MHz, QPSK, 15 kHz)	5G NR FR1 FDD	5.52	±9.6
10931	AAC	5G NR (DFT-s-OFDM, 1 RB, 20 MHz, QPSK, 15 kHz)	5G NR FR1 FDD	5.51	±9.6
10932	AAC	5G NR (DFT-s-OFDM, 1 RB, 25 MHz, QPSK, 15 kHz)	5G NR FR1 FDD	5.51	±9.6
10933	AAC	5G NR (DFT-s-OFDM, 1 RB, 30 MHz, QPSK, 15 kHz)	5G NR FR1 FDD	5.51	±9.6
10934	AAC	5G NR (DFT-s-OFDM, 1 RB, 40 MHz, QPSK, 15 kHz)	5G NR FR1 FDD	5.51	±9.6
10935	AAD	5G NR (DFT-s-OFDM, 1 RB, 50 MHz, QPSK, 15 kHz)	5G NR FR1 FDD	5.51	±9.6
10936	AAC	5G NR (DFT-s-OFDM, 50% RB, 5 MHz, QPSK, 15 kHz)	5G NR FR1 FDD	5.90	±9.6
10937	AAC	5G NR (DFT-s-OFDM, 50% RB, 10 MHz, QPSK, 15 kHz)	5G NR FR1 FDD	5.77	±9.6
10938	AAC	5G NR (DFT-s-OFDM, 50% RB, 15 MHz, QPSK, 15 kHz)	5G NR FR1 FDD	5.90	±9.6
10939	AAC	5G NR (DFT-s-OFDM, 50% RB, 20 MHz, QPSK, 15 kHz)	5G NR FR1 FDD	5.82	±9.6
10940	AAC	5G NR (DFT-s-OFDM, 50% RB, 25 MHz, QPSK, 15 kHz)	5G NR FR1 FDD	5.89	±9.6
10941	AAC	5G NR (DFT-s-OFDM, 50% RB, 30 MHz, QPSK, 15 kHz)	5G NR FR1 FDD	5.83	±9.6
10942	AAC	5G NR (DFT-s-OFDM, 50% RB, 40 MHz, QPSK, 15 kHz)	5G NR FR1 FDD	5.85	±9.6
10943	AAD	5G NR (DFT-s-OFDM, 50% RB, 50 MHz, QPSK, 15 kHz)	5G NR FR1 FDD	5.95	±9.6
10944	AAC	5G NR (DFT-s-OFDM, 100% RB, 5 MHz, QPSK, 15 kHz)	5G NR FR1 FDD	5.81	±9.6
10945	AAC	5G NR (DFT-s-OFDM, 100% RB, 10 MHz, QPSK, 15 kHz)	5G NR FR1 FDD	5.85	±9.6
10946	AAC	5G NR (DFT-s-OFDM, 100% RB, 15 MHz, QPSK, 15 kHz)	5G NR FR1 FDD	5.83	±9.6
10947	AAC	5G NR (DFT-s-OFDM, 100% RB, 20 MHz, QPSK, 15 kHz)	5G NR FR1 FDD	5.87	±9.6
10948	AAC	5G NR (DFT-s-OFDM, 100% RB, 25 MHz, QPSK, 15 kHz)	5G NR FR1 FDD	5.94	±9.6
10949	AAC	5G NR (DFT-s-OFDM, 100% RB, 30 MHz, QPSK, 15 kHz)	5G NR FR1 FDD	5.87	±9.6
10950	AAC	5G NR (DFT-s-OFDM, 100% RB, 40 MHz, QPSK, 15 kHz)	5G NR FR1 FDD	5.94	±9.6
10951	AAD	5G NR (DFT-s-OFDM, 100% RB, 50 MHz, QPSK, 15 kHz)	5G NR FR1 FDD	5.92	±9.6
10952	AAA	5G NR DL (CP-OFDM, TM 3.1, 5 MHz, 64-QAM, 15 kHz)	5G NR FR1 FDD	8.25	±9.6
10953	AAA	5G NR DL (CP-OFDM, TM 3.1, 10 MHz, 64-QAM, 15 kHz)	5G NR FR1 FDD	8.15	±9.6
10954	AAA	5G NR DL (CP-OFDM, TM 3.1, 15 MHz, 64-QAM, 15 kHz)	5G NR FR1 FDD	8.23	±9.6
10955	AAA	5G NR DL (CP-OFDM, TM 3.1, 20 MHz, 64-QAM, 15 kHz)	5G NR FR1 FDD	8.42	±9.6
10956	AAA	5G NR DL (CP-OFDM, TM 3.1, 5 MHz, 64-QAM, 30 kHz)	5G NR FR1 FDD	8.14	±9.6
10957	AAA	5G NR DL (CP-OFDM, TM 3.1, 10 MHz, 64-QAM, 30 kHz)	5G NR FR1 FDD	8.31	±9.6
10958	AAA	5G NR DL (CP-OFDM, TM 3.1, 15 MHz, 64-QAM, 30 kHz)	5G NR FR1 FDD	8.61	±9.6
10959	AAA	5G NR DL (CP-OFDM, TM 3.1, 20 MHz, 64-QAM, 30 kHz)	5G NR FR1 FDD	8.33	±9.6
10960	AAC	5G NR DL (CP-OFDM, TM 3.1, 5 MHz, 64-QAM, 15 kHz)	5G NR FR1 TDD	9.32	±9.6
10961	AAB	5G NR DL (CP-OFDM, TM 3.1, 10 MHz, 64-QAM, 15 kHz)	5G NR FR1 TDD	9.36	±9.6
10962	AAB	5G NR DL (CP-OFDM, TM 3.1, 15 MHz, 64-QAM, 15 kHz)	5G NR FR1 TDD	9.40	±9.6
10963	AAB	5G NR DL (CP-OFDM, TM 3.1, 20 MHz, 64-QAM, 15 kHz)	5G NR FR1 TDD	9.55	±9.6
10964	AAC	5G NR DL (CP-OFDM, TM 3.1, 5 MHz, 64-QAM, 30 kHz)	5G NR FR1 TDD	9.29	±9.6
10965	AAB	5G NR DL (CP-OFDM, TM 3.1, 10 MHz, 64-QAM, 30 kHz)	5G NR FR1 TDD	9.37	±9.6
10966	AAB	5G NR DL (CP-OFDM, TM 3.1, 15 MHz, 64-QAM, 30 kHz)	5G NR FR1 TDD	9.55	±9.6
10967	AAB	5G NR DL (CP-OFDM, TM 3.1, 20 MHz, 64-QAM, 30 kHz)	5G NR FR1 TDD	9.42	±9.6
10968	AAB	5G NR DL (CP-OFDM, TM 3.1, 100 MHz, 64-QAM, 30 kHz)	5G NR FR1 TDD	9.49	±9.6
10972	AAB	5G NR (CP-OFDM, 1 RB, 20 MHz, QPSK, 15 kHz)	5G NR FR1 TDD	11.59	±9.6
10973	AAB	5G NR (DFT-s-OFDM, 1 RB, 100 MHz, QPSK, 30 kHz)	5G NR FR1 TDD	9.06	±9.6
10974	AAB	5G NR (CP-OFDM, 100% RB, 100 MHz, 256-QAM, 30 kHz)	5G NR FR1 TDD	10.28	±9.6
10978	AAA	ULLA BDR	ULLA	1.16	±9.6
10979	AAA	ULLA HDR4	ULLA	8.58	±9.6
10980	AAA	ULLA HDR8	ULLA	10.32	±9.6
10981	AAA	ULLA HDRp4	ULLA	3.19	±9.6
10982	AAA	ULLA HDRp8	ULLA	3.43	±9.6

UID	Rev	Communication System Name	Group	PAR (dB)	Unc ^E k = 2
10983	AAA	5G NR DL (CP-OFDM, TM 3.1, 40 MHz, 64-QAM, 15 kHz)	5G NR FR1 TDD	9.31	±9.6
10984	AAA	5G NR DL (CP-OFDM, TM 3.1, 50 MHz, 64-QAM, 15 kHz)	5G NR FR1 TDD	9.42	±9.6
10985	AAA	5G NR DL (CP-OFDM, TM 3.1, 40 MHz, 64-QAM, 30 kHz)	5G NR FR1 TDD	9.54	±9.6
10986	AAA	5G NR DL (CP-OFDM, TM 3.1, 50 MHz, 64-QAM, 30 kHz)	5G NR FR1 TDD	9.50	±9.6
10987	AAA	5G NR DL (CP-OFDM, TM 3.1, 60 MHz, 64-QAM, 30 kHz)	5G NR FR1 TDD	9.53	±9.6
10988	AAA	5G NR DL (CP-OFDM, TM 3.1, 70 MHz, 64-QAM, 30 kHz)	5G NR FR1 TDD	9.38	±9.6
10989	AAA	5G NR DL (CP-OFDM, TM 3.1, 80 MHz, 64-QAM, 30 kHz)	5G NR FR1 TDD	9.33	±9.6
10990	AAA	5G NR DL (CP-OFDM, TM 3.1, 90 MHz, 64-QAM, 30 kHz)	5G NR FR1 TDD	9.52	±9.6
11003	AAA	5G NR DL (CP-OFDM, TM 3.1, 30 MHz, 64-QAM, 15 kHz)	5G NR FR1 TDD	10.24	±9.6
11004	AAA	5G NR DL (CP-OFDM, TM 3.1, 30 MHz, 64-QAM, 30 kHz)	5G NR FR1 TDD	10.73	±9.6
11005	AAA	5G NR DL (CP-OFDM, TM 3.1, 25 MHz, 64-QAM, 15 kHz)	5G NR FR1 FDD	8.70	±9.6
11006	AAA	5G NR DL (CP-OFDM, TM 3.1, 30 MHz, 64-QAM, 15 kHz)	5G NR FR1 FDD	8.55	±9.6
11007	AAA	5G NR DL (CP-OFDM, TM 3.1, 40 MHz, 64-QAM, 15 kHz)	5G NR FR1 FDD	8.46	±9.6
11008	AAA	5G NR DL (CP-OFDM, TM 3.1, 50 MHz, 64-QAM, 15 kHz)	5G NR FR1 FDD	8.51	±9.6
11009	AAA	5G NR DL (CP-OFDM, TM 3.1, 25 MHz, 64-QAM, 30 kHz)	5G NR FR1 FDD	8.76	±9.6
11010	AAA	5G NR DL (CP-OFDM, TM 3.1, 30 MHz, 64-QAM, 30 kHz)	5G NR FR1 FDD	8.95	±9.6
11011	AAA	5G NR DL (CP-OFDM, TM 3.1, 40 MHz, 64-QAM, 30 kHz)	5G NR FR1 FDD	8.96	±9.6
11012	AAA	5G NR DL (CP-OFDM, TM 3.1, 50 MHz, 64-QAM, 30 kHz)	5G NR FR1 FDD	8.68	±9.6
11013	AAA	IEEE 802.11be (320 MHz, MCS1, 99pc duty cycle)	WLAN	8.47	±9.6
11014	AAA	IEEE 802.11be (320 MHz, MCS2, 99pc duty cycle)	WLAN	8.45	±9.6
11015	AAA	IEEE 802.11be (320 MHz, MCS3, 99pc duty cycle)	WLAN	8.44	±9.6
11016	AAA	IEEE 802.11be (320 MHz, MCS4, 99pc duty cycle)	WLAN	8.44	±9.6
11017	AAA	IEEE 802.11be (320 MHz, MCS5, 99pc duty cycle)	WLAN	8.41	±9.6
11018	AAA	IEEE 802.11be (320 MHz, MCS6, 99pc duty cycle)	WLAN	8.40	±9.6
11019	AAA	IEEE 802.11be (320 MHz, MCS7, 99pc duty cycle)	WLAN	8.29	±9.6
11020	AAA	IEEE 802.11be (320 MHz, MCS8, 99pc duty cycle)	WLAN	8.27	±9.6
11021	AAA	IEEE 802.11be (320 MHz, MCS9, 99pc duty cycle)	WLAN	8.46	±9.6
11022	AAA	IEEE 802.11be (320 MHz, MCS10, 99pc duty cycle)	WLAN	8.36	±9.6
11023	AAA	IEEE 802.11be (320 MHz, MCS11, 99pc duty cycle)	WLAN	8.09	±9.6
11024	AAA	IEEE 802.11be (320 MHz, MCS12, 99pc duty cycle)	WLAN	8.42	±9.6
11025	AAA	IEEE 802.11be (320 MHz, MCS13, 99pc duty cycle)	WLAN	8.37	±9.6
11026	AAA	IEEE 802.11be (320 MHz, MCS0, 99pc duty cycle)	WLAN	8.39	±9.6

^E Uncertainty is determined using the max. deviation from linear response applying rectangular distribution and is expressed for the square of the field value.

Appendix E. Dipole & Source Calibration



Accredited by the Swiss Accreditation Service (SAS)
The Swiss Accreditation Service is one of the signatories to the EA
Multilateral Agreement for the recognition of calibration certificates

Accreditation No.: **SCS 0108**

Client **DEKRA (Auden)**

Certificate No: **D2450V2-930_Nov22**

CALIBRATION CERTIFICATE

Object **D2450V2 - SN:930**

Calibration procedure(s) **QA CAL-05.v11
Calibration Procedure for SAR Validation Sources between 0.7-3 GHz**

Calibration date: **November 21, 2022**

This calibration certificate documents the traceability to national standards, which realize the physical units of measurements (SI).
The measurements and the uncertainties with confidence probability are given on the following pages and are part of the certificate.

All calibrations have been conducted in the closed laboratory facility: environment temperature (22 ± 3)°C and humidity < 70%.

Calibration Equipment used (M&TE critical for calibration)

Primary Standards	ID #	Cal Date (Certificate No.)	Scheduled Calibration
Power meter NRP	SN: 104778	04-Apr-22 (No. 217-03525/03524)	Apr-23
Power sensor NRP-Z91	SN: 103244	04-Apr-22 (No. 217-03524)	Apr-23
Power sensor NRP-Z91	SN: 103245	04-Apr-22 (No. 217-03525)	Apr-23
Reference 20 dB Attenuator	SN: BH9394 (20k)	04-Apr-22 (No. 217-03527)	Apr-23
Type-N mismatch combination	SN: 310982 / 06327	04-Apr-22 (No. 217-03528)	Apr-23
Reference Probe EX3DV4	SN: 7349	31-Dec-21 (No. EX3-7349_Dec21)	Dec-22
DAE4	SN: 601	31-Aug-22 (No. DAE4-601_Aug22)	Aug-23

Secondary Standards	ID #	Check Date (in house)	Scheduled Check
Power meter E4419B	SN: GB39512475	30-Oct-14 (in house check Oct-22)	In house check: Oct-24
Power sensor HP 8481A	SN: US37292783	07-Oct-15 (in house check Oct-22)	In house check: Oct-24
Power sensor HP 8481A	SN: MY41093315	07-Oct-15 (in house check Oct-22)	In house check: Oct-24
RF generator R&S SMT-06	SN: 100972	15-Jun-15 (in house check Oct-22)	In house check: Oct-24
Network Analyzer Agilent E8358A	SN: US41080477	31-Mar-14 (in house check Oct-22)	In house check: Oct-24

	Name	Function	Signature
Calibrated by:	Jeton Kastrati	Laboratory Technician	
Approved by:	Sven Kühn	Technical Manager	

Issued: November 22, 2022

This calibration certificate shall not be reproduced except in full without written approval of the laboratory.



Accredited by the Swiss Accreditation Service (SAS)

The Swiss Accreditation Service is one of the signatories to the EA Multilateral Agreement for the recognition of calibration certificates

Glossary:

TSL	tissue simulating liquid
ConvF	sensitivity in TSL / NORM x,y,z
N/A	not applicable or not measured

Calibration is Performed According to the Following Standards:

- IEC/IEEE 62209-1528, "Measurement Procedure For The Assessment Of Specific Absorption Rate Of Human Exposure To Radio Frequency Fields From Hand-Held And Body-Worn Wireless Communication Devices - Part 1528: Human Models, Instrumentation And Procedures (Frequency Range of 4 MHz to 10 GHz)", October 2020.
- KDB 865664, "SAR Measurement Requirements for 100 MHz to 6 GHz"

Additional Documentation:

- DASY System Handbook

Methods Applied and Interpretation of Parameters:

- Measurement Conditions:* Further details are available from the Validation Report at the end of the certificate. All figures stated in the certificate are valid at the frequency indicated.
- Antenna Parameters with TSL:* The source is mounted in a touch configuration below the center marking of the flat phantom.
- Return Loss:* This parameter is measured with the source positioned under the liquid filled phantom (as described in the measurement condition clause). The Return Loss ensures low reflected power. No uncertainty required.
- SAR measured:* SAR measured at the stated antenna input power.
- SAR normalized:* SAR as measured, normalized to an input power of 1 W at the antenna connector.
- SAR for nominal TSL parameters:* The measured TSL parameters are used to calculate the nominal SAR result.

The reported uncertainty of measurement is stated as the standard uncertainty of measurement multiplied by the coverage factor $k=2$, which for a normal distribution corresponds to a coverage probability of approximately 95%.

Measurement Conditions

DASY system configuration, as far as not given on page 1.

DASY Version	DASY52	V52.10.4
Extrapolation	Advanced Extrapolation	
Phantom	Modular Flat Phantom	
Distance Dipole Center - TSL	10 mm	with Spacer
Zoom Scan Resolution	dx, dy, dz = 5 mm	
Frequency	2450 MHz \pm 1 MHz	

Head TSL parameters

The following parameters and calculations were applied.

	Temperature	Permittivity	Conductivity
Nominal Head TSL parameters	22.0 °C	39.2	1.80 mho/m
Measured Head TSL parameters	(22.0 \pm 0.2) °C	38.4 \pm 6 %	1.87 mho/m \pm 6 %
Head TSL temperature change during test	< 0.5 °C	----	----

SAR result with Head TSL

SAR averaged over 1 cm ³ (1 g) of Head TSL	Condition	
SAR measured	250 mW input power	13.4 W/kg
SAR for nominal Head TSL parameters	normalized to 1W	52.4 W/kg \pm 17.0 % (k=2)

SAR averaged over 10 cm ³ (10 g) of Head TSL	condition	
SAR measured	250 mW input power	6.24 W/kg
SAR for nominal Head TSL parameters	normalized to 1W	24.6 W/kg \pm 16.5 % (k=2)

Appendix (Additional assessments outside the scope of SCS 0108)

Antenna Parameters with Head TSL

Impedance, transformed to feed point	53.7 Ω + 2.9 j Ω
Return Loss	- 26.8 dB

General Antenna Parameters and Design

Electrical Delay (one direction)	1.157 ns
----------------------------------	----------

After long term use with 100W radiated power, only a slight warming of the dipole near the feedpoint can be measured.

The dipole is made of standard semirigid coaxial cable. The center conductor of the feeding line is directly connected to the second arm of the dipole. The antenna is therefore short-circuited for DC-signals. On some of the dipoles, small end caps are added to the dipole arms in order to improve matching when loaded according to the position as explained in the "Measurement Conditions" paragraph. The SAR data are not affected by this change. The overall dipole length is still according to the Standard.

No excessive force must be applied to the dipole arms, because they might bend or the soldered connections near the feedpoint may be damaged.

Additional EUT Data

Manufactured by	SPEAG
-----------------	-------

DASY5 Validation Report for Head TSL

Date: 21.11.2022

Test Laboratory: SPEAG, Zurich, Switzerland

DUT: Dipole 2450 MHz; Type: D2450V2; Serial: D2450V2 - SN:930

Communication System: UID 0 - CW; Frequency: 2450 MHz

Medium parameters used: $f = 2450$ MHz; $\sigma = 1.87$ S/m; $\epsilon_r = 38.4$; $\rho = 1000$ kg/m³

Phantom section: Flat Section

Measurement Standard: DASY5 (IEEE/IEC/ANSI C63.19-2011)

DASY52 Configuration:

- Probe: EX3DV4 - SN7349; ConvF(7.96, 7.96, 7.96) @ 2450 MHz; Calibrated: 31.12.2021
- Sensor-Surface: 1.4mm (Mechanical Surface Detection)
- Electronics: DAE4 Sn601; Calibrated: 31.08.2022
- Phantom: Flat Phantom 5.0 (front); Type: QD 000 P50 AA; Serial: 1001
- DASY52 52.10.4(1535); SEMCAD X 14.6.14(7501)

Dipole Calibration for Head Tissue/Pin=250 mW, d=10mm/Zoom Scan (7x7x7)/Cube 0:

Measurement grid: dx=5mm, dy=5mm, dz=5mm

Reference Value = 115.6 V/m; Power Drift = 0.00 dB

Peak SAR (extrapolated) = 25.9 W/kg

SAR(1 g) = 13.4 W/kg; SAR(10 g) = 6.24 W/kg

Smallest distance from peaks to all points 3 dB below = 9 mm

Ratio of SAR at M2 to SAR at M1 = 51.7%

Maximum value of SAR (measured) = 21.8 W/kg

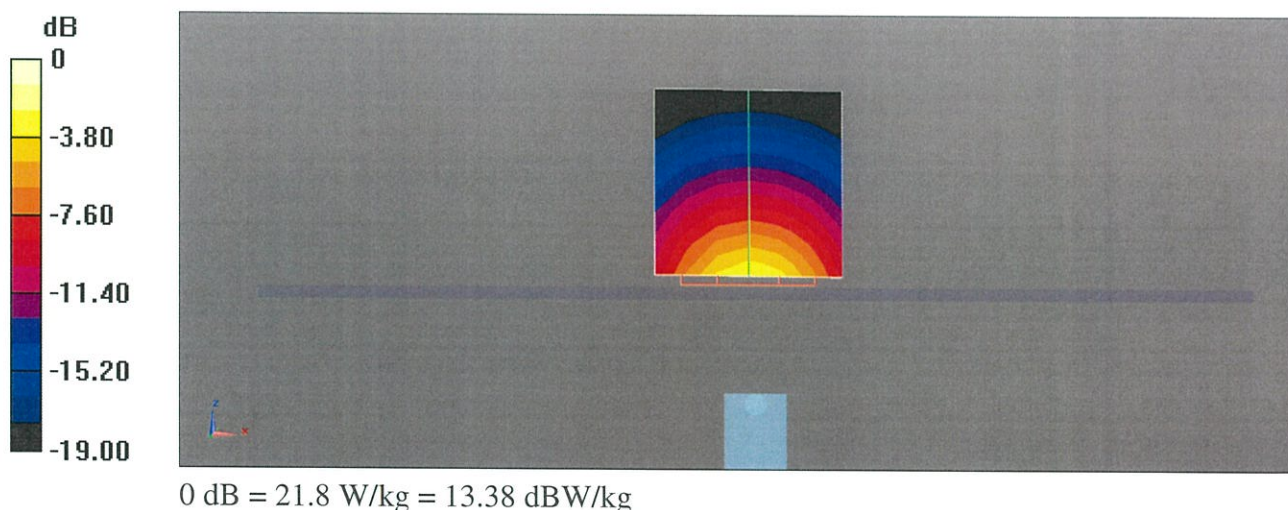

Impedance Measurement Plot for Head TSL

