

FCC Test Report

Compliance with Canada Interference-Causing
Equipment Standard ICES-003

Product Name : Wireless Headset
Model No. : AW988

Applicant : GN Audio A/S
Address : Lautrupbjerg 7,DK-2750 Ballerup,Denmark.

Date of Receipt : 2018/01/16
Issued Date : 2018/01/24
Report No. : 1810206R-ITUSP01V00-A
Report Version : V1.0



The test results relate only to the samples tested.
The test results shown in the test report are traceable to the national/international standard through the calibration of the equipment and evaluated measurement uncertainty herein.
This report must not be used to claim product endorsement by TAF or any agency of the government.
The test report shall not be reproduced without the written approval of DEKRA Testing and Certification Co., Ltd.

Test Report

Issued Date: 2018/01/24

Report No.: 1810206R-ITUSP01V00-A



Product Name : Wireless Headset
Applicant : GN Audio A/S
Address : Lautrupbjerg 7,DK-2750 Ballerup,Denmark.
Manufacturer : GN Audio A/S
Model No. : AW988
EUT Rated Voltage : DC 5V (Power by PC)
EUT Test Voltage : AC 120V / 60Hz
Trade Name : ALIENWARE
Applicable Standard : FCC CFR Title 47 Part 15 Subpart B: 2016, Class B
CISPR 22: 2008, ANSI C63.4: 2014
ICES-003 Issue 6: 2016, Class B
Test Result : Complied
Performed Location : DEKRA Testing and Certification Co., Ltd.
Linkou Laboratory
No. 5-22, Ruishukeng
Linkou District, New Taipei City, 24451, Taiwan
TEL:+866-2-8601-3788 / FAX:+866-2-8601-3789

Documented By : 

(Senior Adm. Specialist / Genie Chang)
Reviewed By : 

(Senior Engineer / Leo Lin)
Approved By : 

(Director / Vincent Lin)

Laboratory Information

We, **DEKRA Testing and Certification Co., Ltd.**, are an independent EMC and safety consultancy that was established the whole facility in our laboratories. The test facility has been accredited/accepted (audited or listed) by the following related bodies in compliance with ISO 17025, EN 45001 and specified testing scopes:

Taiwan R.O.C.	:	BSMI, NCC, TAF
Norway	:	DNV
USA	:	FCC
Japan	:	VCCI

The related certificate for our laboratories about the test site and management system can be downloaded from DEKRA Testing and Certification Co., Ltd. Web Site :

<http://www.dekra.com.tw/english/about/certificates.aspx?bval=5>

The address and introduction of DEKRA Testing and Certification Co., Ltd. laboratories can be founded in our Web site : http://www.dekra.com.tw/index_en.aspx

If you have any comments, Please don't hesitate to contact us. Our contact information is as below:

Hsin Chu Laboratory:

No.75-2, 3rd Lin, WangYe Keng, Yonghxing Tsuen, Qionglin Shiang, Hsinchu County 307, Taiwan (R.O.C.)

No.372, Sec. 4, Zhongxing Rd., Zhudong Township, Hsinchu County 310, Taiwan

No.372-2, Sec. 4, Zhongxing Rd., Zhudong Township, Hsinchu County 310, Taiwan

TEL:+886-3-592-8858 / FAX:+886-3-592-8859

TEL:+886-3-582-8001 / FAX:+886-3-5828-958 E-Mail : info.tw@dekra.com

Lin Kou Laboratory

No. 5-22, Ruishukeng, Linkou Dist., New Taipei City 24451, Taiwan (R.O.C.)

TEL : +886-2-8601-3788 / FAX : +886-2-8601-3789 E-Mail : info.tw@dekra.com

Suzhou (China) Testing Laboratory :

No.99 Hongye Rd., Suzhou Industrial Park, Suzhou,215006, Jiangsu,China

TEL : +86-512-6251-5088 / FAX : +86-512-6251-5098 E-Mail : info.tw@dekra.com

TABLE OF CONTENTS

Description	Page
1. General Information	5
1.1. EUT Description.....	5
1.2. Mode of Operation	6
1.3. Tested System Details	7
1.4. Configuration of Tested System	8
1.5. EUT Exercise Software.....	9
2. Technical Test	10
2.1. Summary of Test Result.....	10
2.2. List of Test Equipment	11
2.3. Measurement Uncertainty.....	12
2.4. Test Environment.....	13
3. Conducted Emission	14
3.1. Test Specification	14
3.2. Test Setup.....	14
3.3. Limit	14
3.4. Test Procedure	15
3.5. Test Result	16
3.6. Test Photograph	22
4. Radiated Emission.....	23
4.1. Test Specification	23
4.2. Test Setup.....	23
4.3. Limit	24
4.4. Test Procedure	25
4.5. Test Result	26
4.6. Test Photograph	30
5. Attachment.....	32
EUT Photograph.....	32

1. General Information

1.1. EUT Description

Product Name	Wireless Headset
Trade Name	ALIENWARE
Model No.	AW988
EUT Max Frequency	2.4GHz

1.2. Mode of Operation

DEKRA has verified the construction and function in typical operation. All the test modes were carried out with the EUT in normal operation, which was shown in this test report and defined as:

Pre-Test Mode	
Mode 1: Normal Operation	
Final Test Mode	
Emission	Mode 1: Normal Operation

1.3. Tested System Details

The types for all equipments, plus descriptions of all cables used in the tested system (including inserted cards) are:

Product	Manufacturer	Model No.	Serial No.	Power Cord
1 Monitor	DELL	U2410	CN-0J257M-728-01I-04NL	Non-Shielded, 1.8m
2 PC	DELL	Vostro230	2R7Z62S	Non-Shielded, 1.8m
3 Keyboard	Microsoft	1576	0065809351914	N/A
4 USB Mouse	Microsoft	1113	N/A	N/A

1.4. Configuration of Tested System

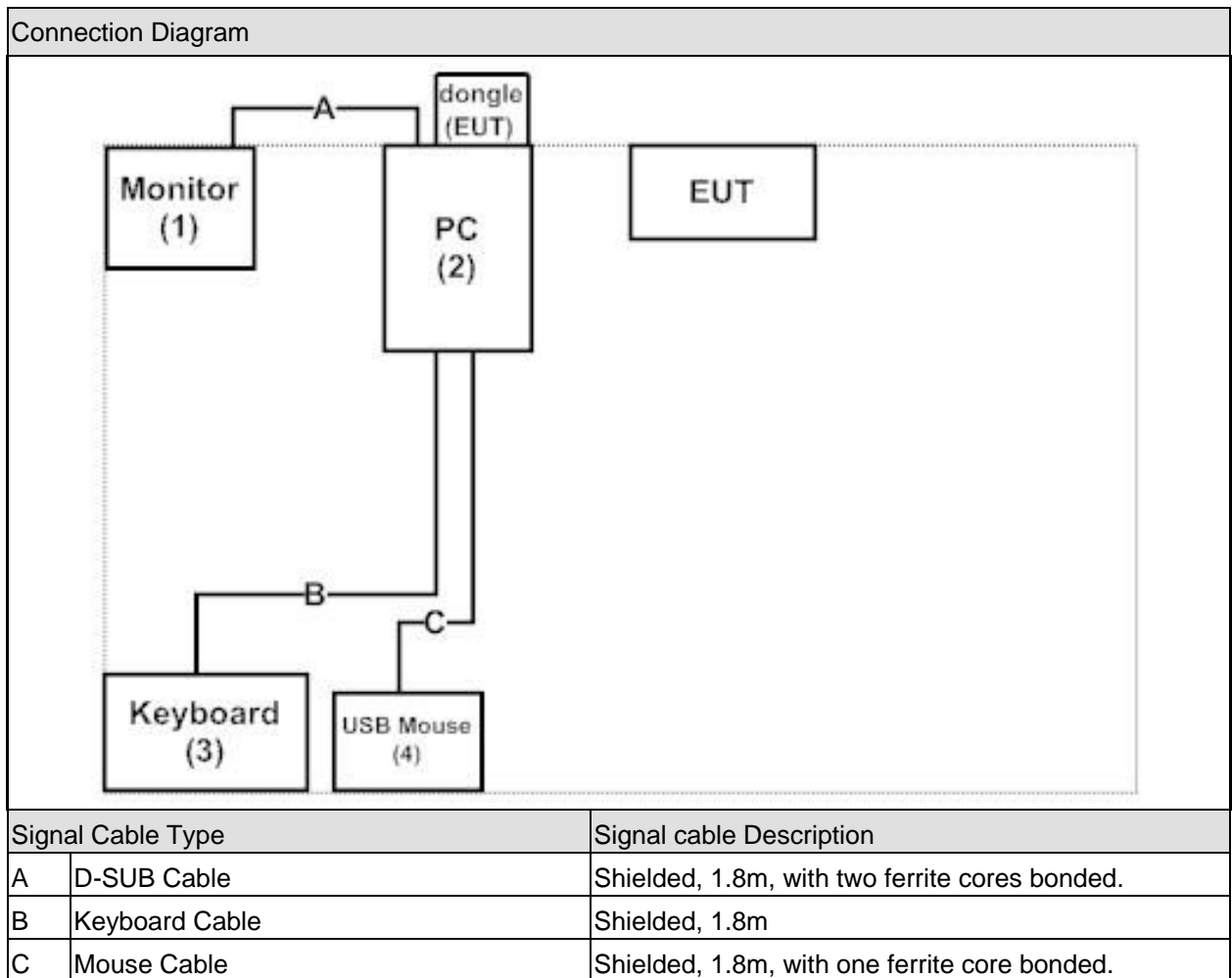

Note:

- Use Full system setup configuration determines Worst-Case Mode.
- Use 2dB law program determines Max. Cable Configuration and Worst-Case Mode.
- Radiated emission item test: Performed using the Horn Antenna 3dB Beamwidth to 3m from the EUT size sufficient to cover the procedure.
- Radiated emission item test: Performed using the Horn Antenna 3dB Beamwidth non 3m distance sufficient to cover the size of the EUT program.

1.5. EUT Exercise Software

1	Setup the EUT and simulators as shown on 1.3.
2	Turn on the power of all equipment.
3	All the features of the EUT operation normally.

2. Technical Test

2.1. Summary of Test Result

- No deviations from the test standards
- Deviations from the test standards as below description:

Emission			
Performed Item	Normative References	Test Performed	Deviation
Conducted Emission	FCC CFR Title 47 Part 15 Subpart B: 2016 Class B, ANSI C63.4: 2014	Yes	No
Radiated Emission	FCC CFR Title 47 Part 15 Subpart B: 2016 Class B, ANSI C63.4: 2014	Yes	No

Note : Test Procedure ANSI C63.4:2014 MP-5:1986

2.2. List of Test Equipment

Conducted Emission / SR8

Instrument	Manufacturer	Type No.	Serial No	Cal. Date
EMI Test Receiver	R&S	ESCS 30	100369	2017/11/07
LISN	R&S	ESH3-Z5	836679/017	2017/01/18
LISN	R&S	ENV216	100097	2017/01/18
Coaxial Cable	DEKRA	RG 400	LC018-RG	2017/06/22

Note: Test Receiver Detector: Quasipeak and Average Bandwidth: 9KHz

Radiated Emission / Site7

Instrument	Manufacturer	Type No.	Serial No	Cal. Date
Bilog Antenna	Schaffner Chase	CBL6112B	2930	2017/06/25
EMI Test Receiver	R&S	ESCI	100649	2017/07/04
Coaxial Cable	DEKRA	RG 214	LC007-RG	2017/06/19
Pre-Amplifier	DEKRA	AP/0100A	CHM/1009094	2017/06/19
Site7 NSA	DEKRA	N/A	N/A	2017/06/19

Note: Test Receiver Detector: Quasipeak Bandwidth: 120KHz

Radiated Emission / CB7

Instrument	Manufacturer	Type No.	Serial No	Cal. Date
EMI Test Receiver	R&S	ESU26	100433	2017/11/02
Horn Antenna	ETS-Lindgren	3117	00202723	2017/07/31
Horn Antenna	SCHWARZBECK	9120D	576	2017/12/07
Pre-Amplifier	EMCI	EMC051845SE	980359	2017/10/12
CB7 VSWR	DEKRA	N/A	N/A	2017/07/29

2.3. Measurement Uncertainty

Conducted Emission

The measurement uncertainty is evaluated as ± 3.44 dB.

Radiated Emission

The measurement uncertainty is evaluated as ± 4.22 dB.

Radiated Emission Above 1GHz

The measurement uncertainty is evaluated as ± 5.08 dB.

2.4. Test Environment

Performed Item	Items	Required	Actual
Conducted Emission	Temperature (°C)	15-35	20
	Humidity (%RH)	25-75	50
	Barometric pressure (mbar)	860-1060	950-1000
Radiated Emission	Temperature (°C)	15-35	21.9
	Humidity (%RH)	25-75	57
	Barometric pressure (mbar)	860-1060	950-1000

3. Conducted Emission

3.1. Test Specification

According to Standard : FCC Part 15 Subpart B, ANSI C63.4

3.2. Test Setup

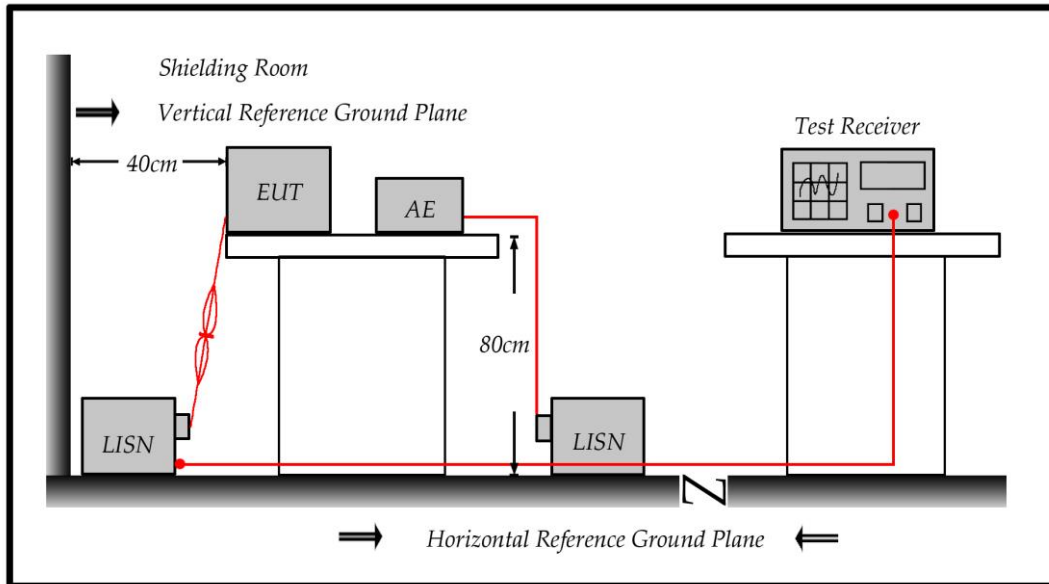

3.3. Limit

Limits		
Frequency (MHz)	QP (dBuV)	AV (dBuV)
0.15 - 0.50	66 - 56	56 - 46
0.50-5.0	56	46
5.0 - 30	60	50

Remarks: In the above table, the tighter limit applies at the band edges.

3.4. Test Procedure

The EUT and simulators are connected to the main power through a line impedance stabilization network (L.I.S.N.). This provides a 50 ohm /50uH coupling impedance for the measuring equipment. The peripheral devices are also connected to the main power through a LISN that provides a 50ohm/50uH coupling impedance with 50ohm termination.

(Please refers to the block diagram of the test setup and photographs.)

Both sides of A.C. line are checked for maximum conducted interference. In order to find the maximum emission, the relative positions of equipment and all of the interface cables must be changed on conducted measurement.

Conducted emissions were invested over the frequency range from 0.15MHz to 30MHz using a receiver bandwidth of 9kHz.

3.5. Test Result

Site : SR8	Time : 2018/01/17 - 10:46
Limit : CISPR_B_00M_QP	Margin : 10
EUT : Wireless Headset	Probe : ENV216_L1 - Line1
Power : AC 120V/60Hz	Note : Mode 1

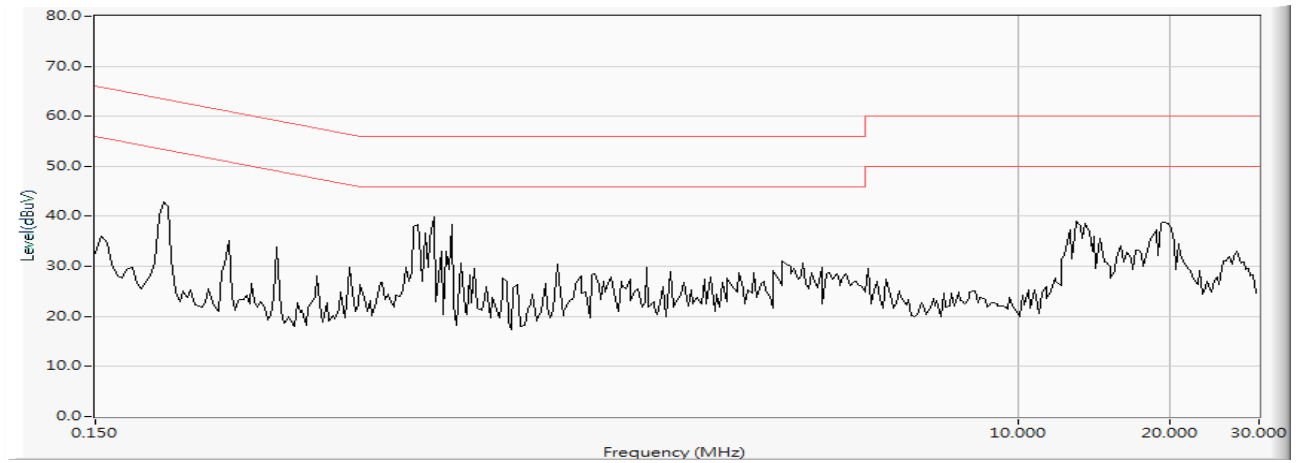

Site : SR8	Time : 2018/01/17 - 10:49
Limit : CISPR_B_00M_QP	Margin : 0
EUT : Wireless Headset	Probe : ENV216_L1 - Line1
Power : AC 120V/60Hz	Note : Mode 1

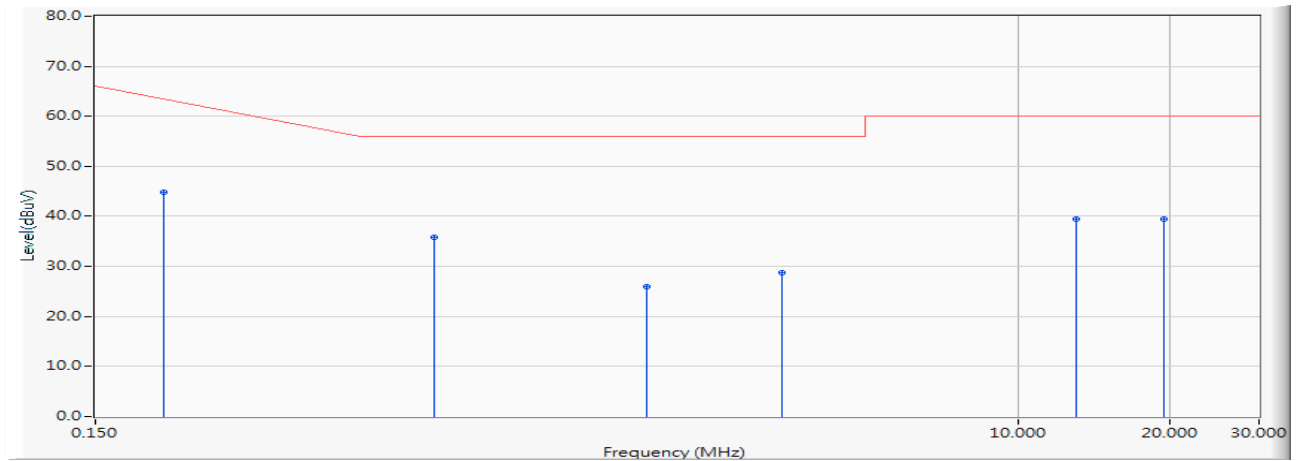

		Frequency (MHz)	Correct Factor (dB)	Reading Level (dBuV)	Measure Level (dBuV)	Margin (dB)	Limit (dBuV)	Detector Type
1	*	0.205	9.772	35.120	44.892	-19.537	64.429	QUASIPeAK
2		0.701	9.754	26.040	35.794	-20.206	56.000	QUASIPeAK
3		1.849	9.717	16.170	25.887	-30.113	56.000	QUASIPeAK
4		3.423	9.856	18.820	28.676	-27.324	56.000	QUASIPeAK
5		13.084	10.008	29.380	39.388	-20.612	60.000	QUASIPeAK
6		19.521	10.077	29.480	39.557	-20.443	60.000	QUASIPeAK

Note:

1. All Reading Levels are Quasi-Peak and average value.
2. " * ", means this data is the worst emission level.
3. Measurement Level = Reading Level + Correct Factor (LISN factor + cable loss).

Site : SR8	Time : 2018/01/17 - 10:49
Limit : CISPR_B_00M_AV	Margin : 0
EUT : Wireless Headset	Probe : ENV216_L1 - Line1
Power : AC 120V/60Hz	Note : Mode 1

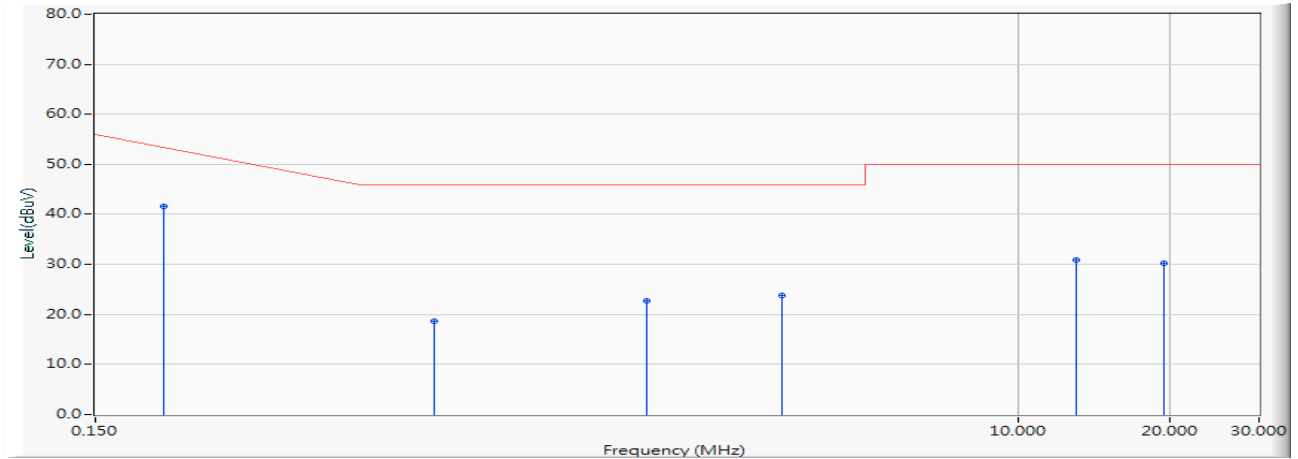

		Frequency (MHz)	Correct Factor (dB)	Reading Level (dBuV)	Measure Level (dBuV)	Margin (dB)	Limit (dBuV)	Detector Type
1	*	0.205	9.772	31.940	41.712	-12.717	54.429	AVERAGE
2		0.701	9.754	8.810	18.564	-27.436	46.000	AVERAGE
3		1.849	9.717	12.980	22.697	-23.303	46.000	AVERAGE
4		3.423	9.856	14.020	23.876	-22.124	46.000	AVERAGE
5		13.084	10.008	20.770	30.778	-19.222	50.000	AVERAGE
6		19.521	10.077	20.110	30.187	-19.813	50.000	AVERAGE

Note:

1. All Reading Levels are Quasi-Peak and average value.
2. " * ", means this data is the worst emission level.
3. Measurement Level = Reading Level + Correct Factor (LISN factor + cable loss).

Site : SR8	Time : 2018/01/17 - 10:50
Limit : CISPR_B_00M_QP	Margin : 10
EUT : Wireless Headset	Probe : ENV216_N - Line2
Power : AC 120V/60Hz	Note : Mode 1

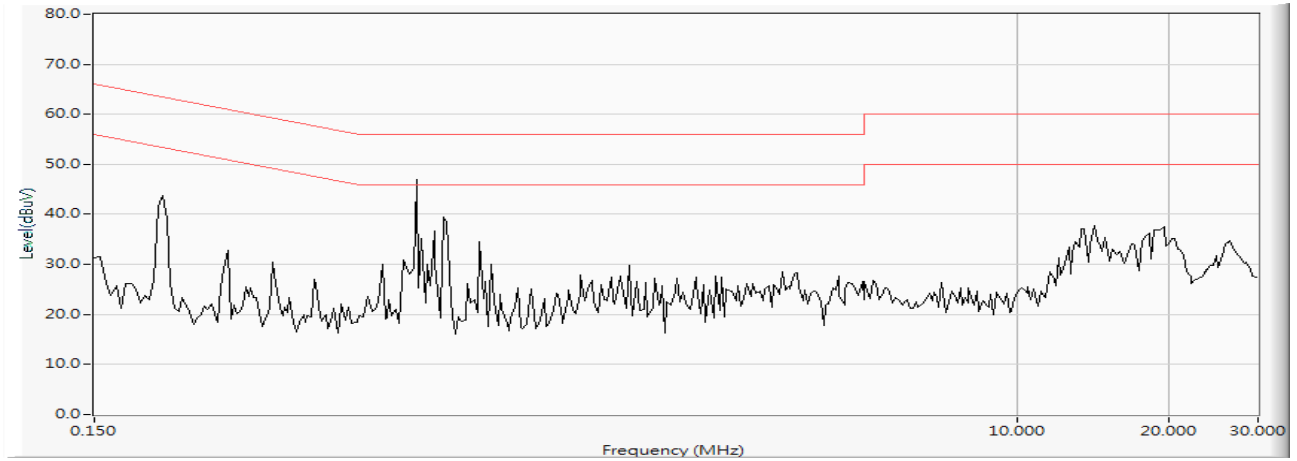

Site : SR8	Time : 2018/01/17 - 10:51
Limit : CISPR_B_00M_QP	Margin : 0
EUT : Wireless Headset	Probe : ENV216_N - Line2
Power : AC 120V/60Hz	Note : Mode 1

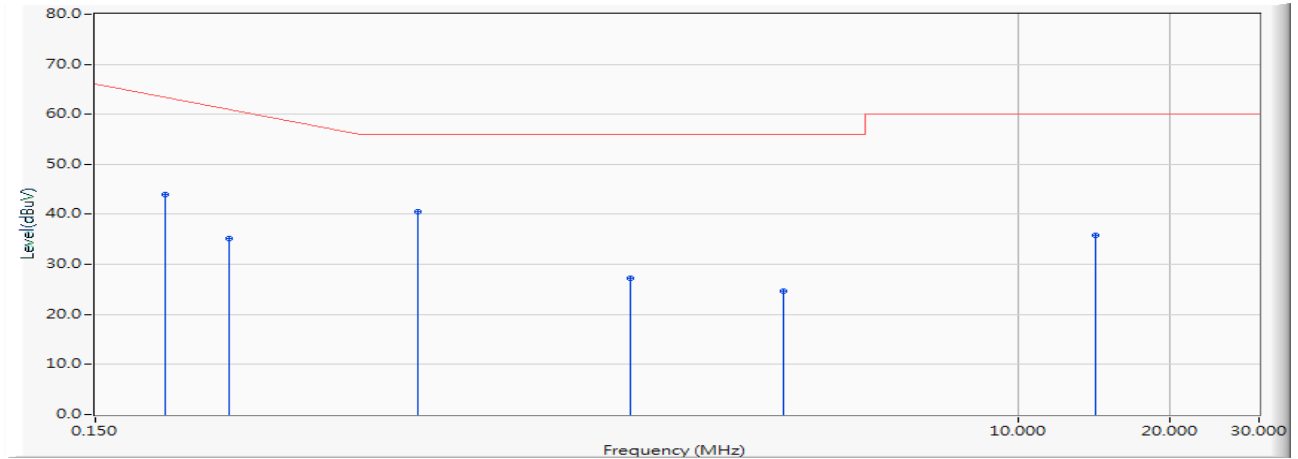

	Frequency (MHz)	Correct Factor (dB)	Reading Level (dBuV)	Measure Level (dBuV)	Margin (dB)	Limit (dBuV)	Detector Type
1	0.206	9.749	34.240	43.988	-20.412	64.400	QUASIPeAK
2	0.275	9.757	25.470	35.227	-27.202	62.429	QUASIPeAK
3	* 0.653	9.821	30.720	40.541	-15.459	56.000	QUASIPeAK
4	1.712	9.828	17.330	27.158	-28.842	56.000	QUASIPeAK
5	3.431	9.928	14.670	24.598	-31.402	56.000	QUASIPeAK
6	14.248	10.127	25.670	35.797	-24.203	60.000	QUASIPeAK

Note:

1. All Reading Levels are Quasi-Peak and average value.
2. " * ", means this data is the worst emission level.
3. Measurement Level = Reading Level + Correct Factor (LISN factor + cable loss).

Site : SR8	Time : 2018/01/17 - 10:51
Limit : CISPR_B_00M_AV	Margin : 0
EUT : Wireless Headset	Probe : ENV216_N - Line2
Power : AC 120V/60Hz	Note : Mode 1

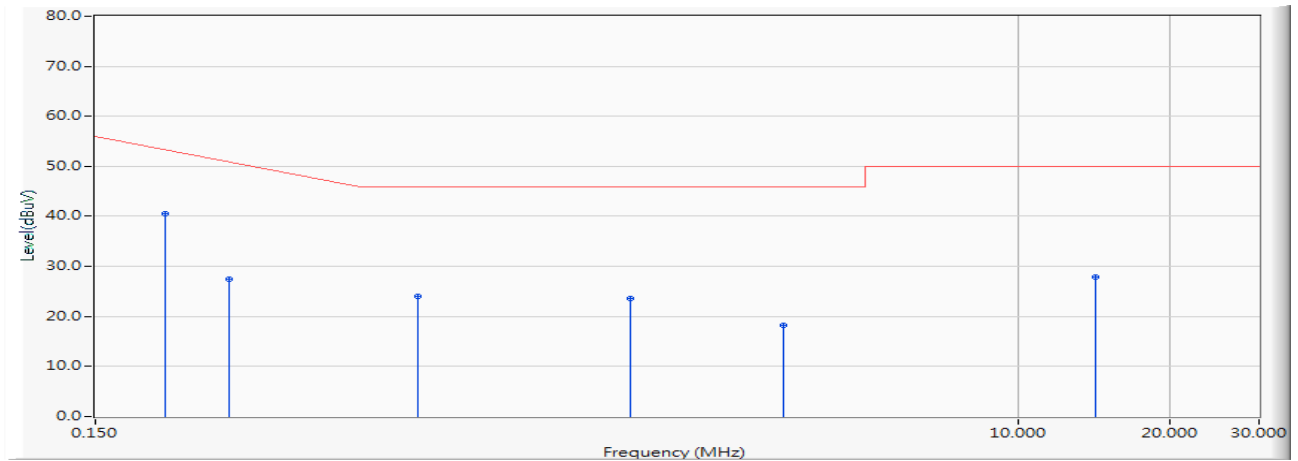

		Frequency (MHz)	Correct Factor (dB)	Reading Level (dBuV)	Measure Level (dBuV)	Margin (dB)	Limit (dBuV)	Detector Type
1	*	0.206	9.749	30.820	40.568	-13.832	54.400	AVERAGE
2		0.275	9.757	17.770	27.527	-24.902	52.429	AVERAGE
3		0.653	9.821	14.230	24.051	-21.949	46.000	AVERAGE
4		1.712	9.828	13.710	23.538	-22.462	46.000	AVERAGE
5		3.431	9.928	8.290	18.218	-27.782	46.000	AVERAGE
6		14.248	10.127	17.810	27.937	-22.063	50.000	AVERAGE

Note:

1. All Reading Levels are Quasi-Peak and average value.
2. " * ", means this data is the worst emission level.
3. Measurement Level = Reading Level + Correct Factor (LISN factor + cable loss).

4. Radiated Emission

4.1. Test Specification

According to EMC Standard : FCC Part 15 Subpart B, ANSI C63.4

4.2. Test Setup

Under 1GHz Test Setup:

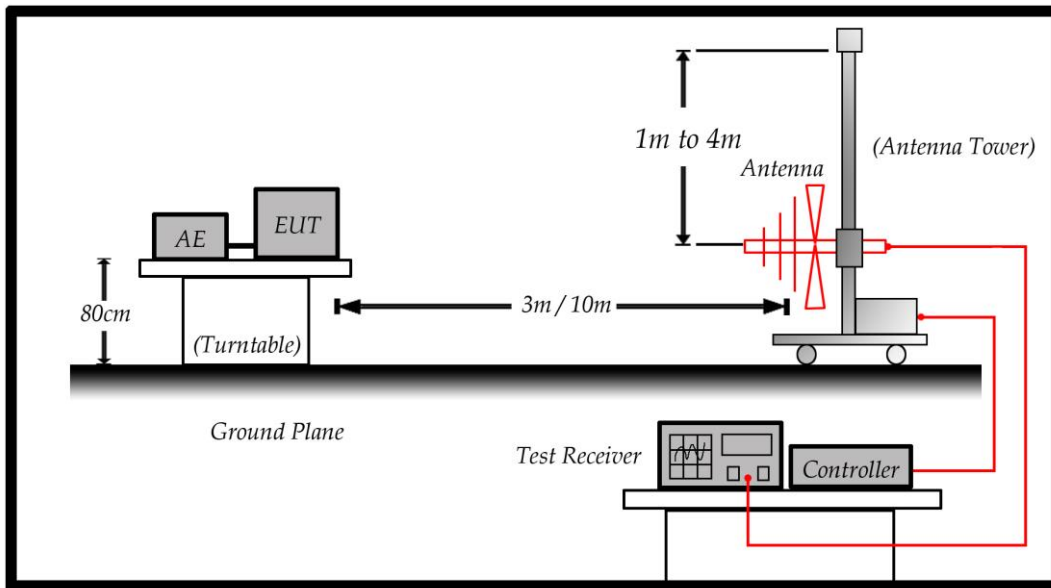

Above 1GHz Test Setup:

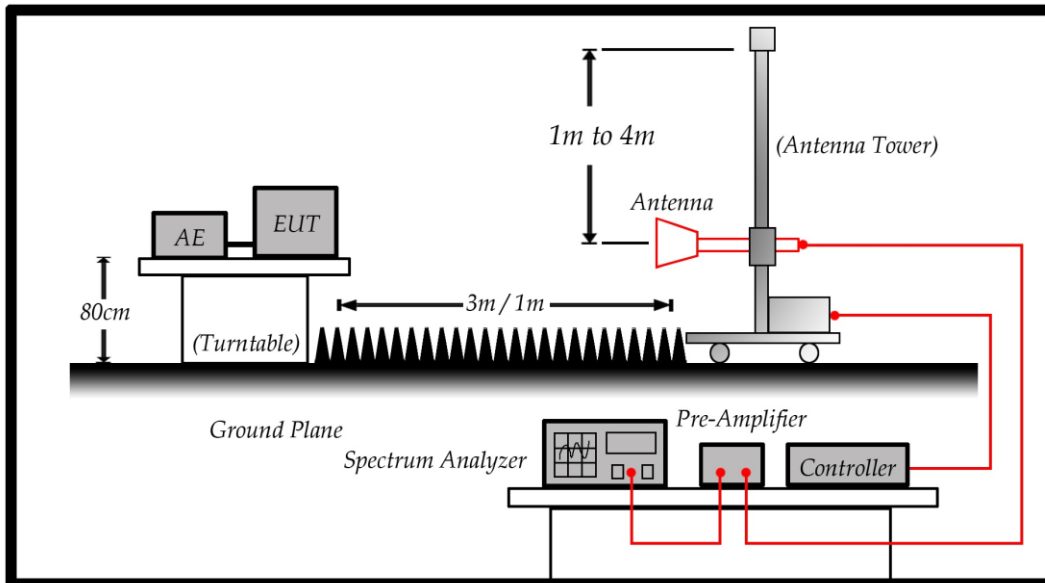

4.3. Limit

Under 1GHz test shall not exceed the following value:

Limits		
Frequency (MHz)	Distance (m)	dBuV/m
30 – 230	10	30
230 – 1000	10	37

Remark:

1. The tighter limit shall apply at the edge between two frequency bands.
2. Distance refers to the distance in meters between the measuring instrument antenna and the closed point of any part of the device or system.

Above 1GHz test shall not exceed the following value:

FCC Part 15 Subpart B Paragraph 15.109 Limits (dBuV/m)		
Frequency (MHz)	Distance (m)	dBuV/m
30-88	3	40
88-216	3	43.5
216-960	3	46
960-18000	3	54
Above 18000	1	63.54

Remark:

1. The tighter limit shall apply at the edge between two frequency bands.
2. Distance refers to the distance in meters between the measuring instrument antenna and the closed point of any part of the device or system.
3. RF Voltage (dBuV/m) = 20 log RF Voltage (uV/m)

4.4. Test Procedure

The EUT and its simulators are placed on a turn table which is 0.8 meter above ground.

The turn table can rotate 360 degrees to determine the position of the maximum emission level and the antenna can move up and down between 1 meter and 4 meters to find out the maximum emission level.

Both horizontal and vertical polarization of the antenna are set on measurement. In order to find the maximum emission, all of the interface cables must be manipulated on radiated measurement.

For an unintentional radiator, including a digital device, the spectrum shall be investigated from the lowest radio frequency signal generated or used in the device, without going below the lowest frequency for which a radiated emission limit is specified, up to the frequency shown in the following table:

Highest frequency generated or used in the device or on which the device operates or tunes (MHz)	Upper frequency of measurement range (MHz)
Below 1.705	30
1.705 – 108	1000
108 – 500	2000
500 – 1000	5000
Above 1000	5 th harmonic of the highest frequency or 40 GHz, whichever is lower

On any frequency or frequencies below or equal to 1000 MHz, the radiated limits shown are based on measuring equipment employing a quasi-peak detector function and above 1000 MHz, the radiated limits shown are based measuring equipment employing an average detector function.

When average radiated emission measurement are included emission measurement Above 1000 MHz, there also is a limit on the radio frequency emissions, as measured using instrumentation with a peak detector function, corresponding to 20 dB above the maximum permitted average limit.

For class A, the measurement distance between the EUT and antenna is 10 meters for under 1GHz and above 1GHz.

For class B, the measurement distance between the EUT and antenna is 10 meters for under 1GHz and 3 meters for above 1GHz.

The bandwidth below 1GHz setting on the field strength meter (R&S Test Receiver ESCS 30) is 120 kHz and above 1GHz is 1MHz.

4.5. Test Result

Site : SITE7	Time : 2018/01/16 - 14:46
Limit : CISPR_B_10M_QP	Margin : 6
EUT : Wireless Headset	Probe : Site7_CBL6112B_10M_1706 - HORIZONTAL
Power : AC 120V/60Hz	Note : Mode 1

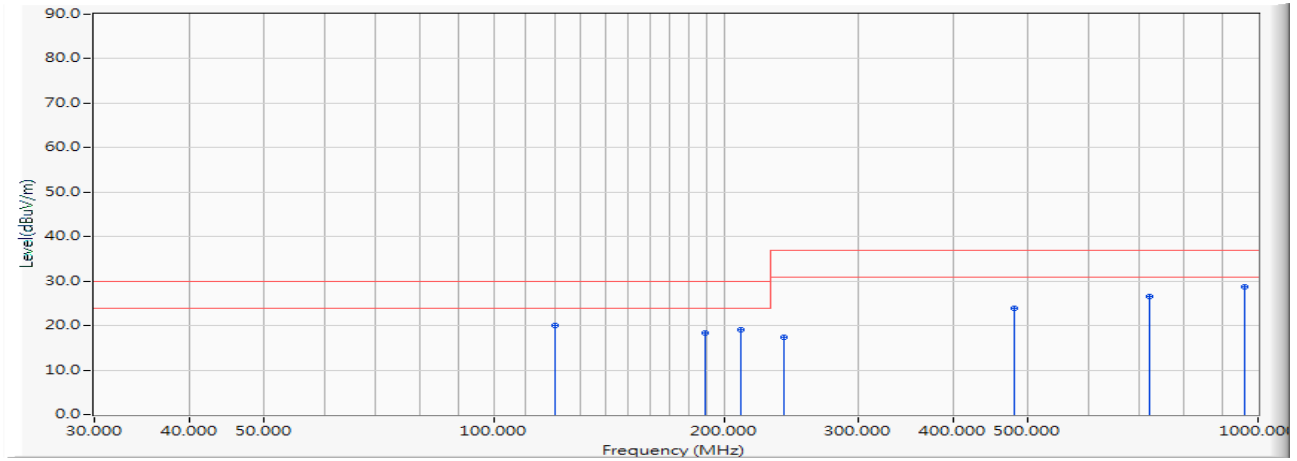

	Frequency (MHz)	Correct Factor (dB)	Reading Level (dBuV)	Measure Level (dBuV/m)	Margin (dB)	Limit (dBuV/m)	Detector Type	Ant Pos (cm)	Table Pos (deg)
1	120.000	-12.284	32.200	19.916	-10.084	30.000	QUASIPeAK	390.000	104.000
2	188.700	-14.366	32.600	18.234	-11.766	30.000	QUASIPeAK	400.000	-52.000
3	210.400	-13.860	32.900	19.040	-10.960	30.000	QUASIPeAK	390.000	88.000
4	240.000	-11.341	28.600	17.259	-19.741	37.000	QUASIPeAK	380.000	42.000
5	480.000	-3.021	26.900	23.879	-13.121	37.000	QUASIPeAK	200.000	98.000
6	720.000	1.170	25.300	26.470	-10.530	37.000	QUASIPeAK	120.000	96.000
7	* 960.000	4.448	24.300	28.748	-8.252	37.000	QUASIPeAK	100.000	81.000

Note:

1. All Readings below 1GHz are Quasi-Peak, above are performed with peak and/or average measurements as necessary.
2. " * ", means this data is the worst emission level.
3. Measurement Level = Reading Level + Correct Factor (ant factor + cable loss - amp).

Site : SITE7	Time : 2018/01/16 - 14:46
Limit : CISPR_B_10M_QP	Margin : 6
EUT : Wireless Headset	Probe : Site7_CBL6112B_10M_1706 - VERTICAL
Power : AC 120V/60Hz	Note : Mode 1

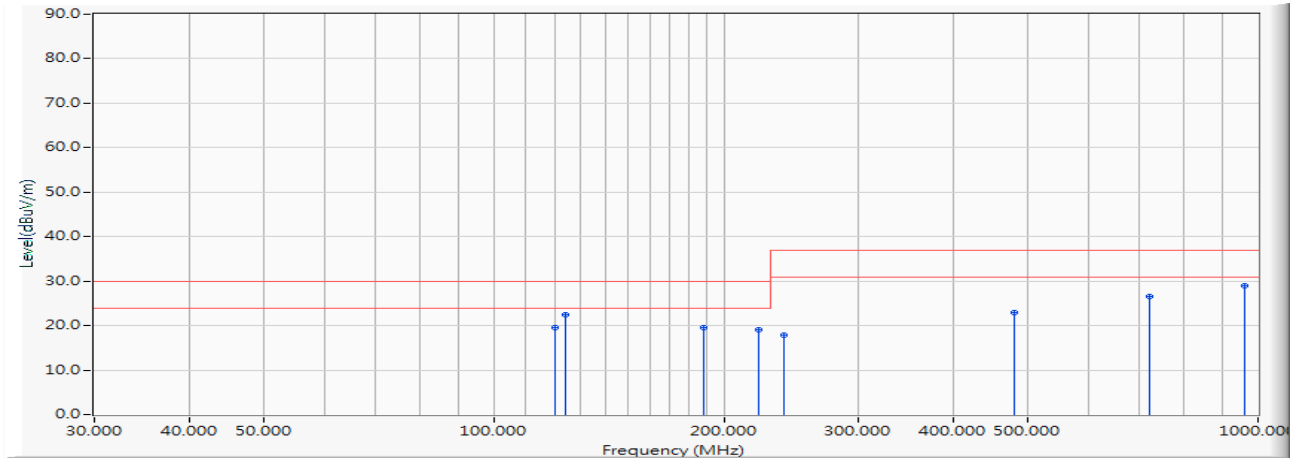

	Frequency (MHz)	Correct Factor (dB)	Reading Level (dBuV)	Measure Level (dBuV/m)	Margin (dB)	Limit (dBuV/m)	Detector Type	Ant Pos (cm)	Table Pos (deg)
1	120.000	-12.284	31.800	19.516	-10.484	30.000	QUASIPeAK	100.000	115.000
2	* 124.000	-12.299	34.700	22.401	-7.599	30.000	QUASIPeAK	100.000	94.000
3	188.100	-14.360	34.000	19.640	-10.360	30.000	QUASIPeAK	100.000	115.000
4	222.000	-13.447	32.400	18.954	-11.046	30.000	QUASIPeAK	100.000	104.000
5	240.000	-11.341	29.300	17.959	-19.041	37.000	QUASIPeAK	100.000	81.000
6	480.000	-3.021	26.000	22.979	-14.021	37.000	QUASIPeAK	300.000	41.000
7	720.000	1.170	25.400	26.570	-10.430	37.000	QUASIPeAK	260.000	91.000
8	960.000	4.448	24.400	28.848	-8.152	37.000	QUASIPeAK	175.000	88.000

Note:

1. All Readings below 1GHz are Quasi-Peak, above are performed with peak and/or average measurements as necessary.
2. " * ", means this data is the worst emission level.
3. Measurement Level = Reading Level + Correct Factor (ant factor + cable loss - amp).

Site: CB7	Time: 2018/01/16 - 22:05
Limit: FCC_B_(Above_1G)	Margin: 0
Probe: CB7_Horn_3117_1707	Polarity: Horizontal
EUT: Wireless Headset	Power: AC 120V/60Hz
Note: Mode 1	

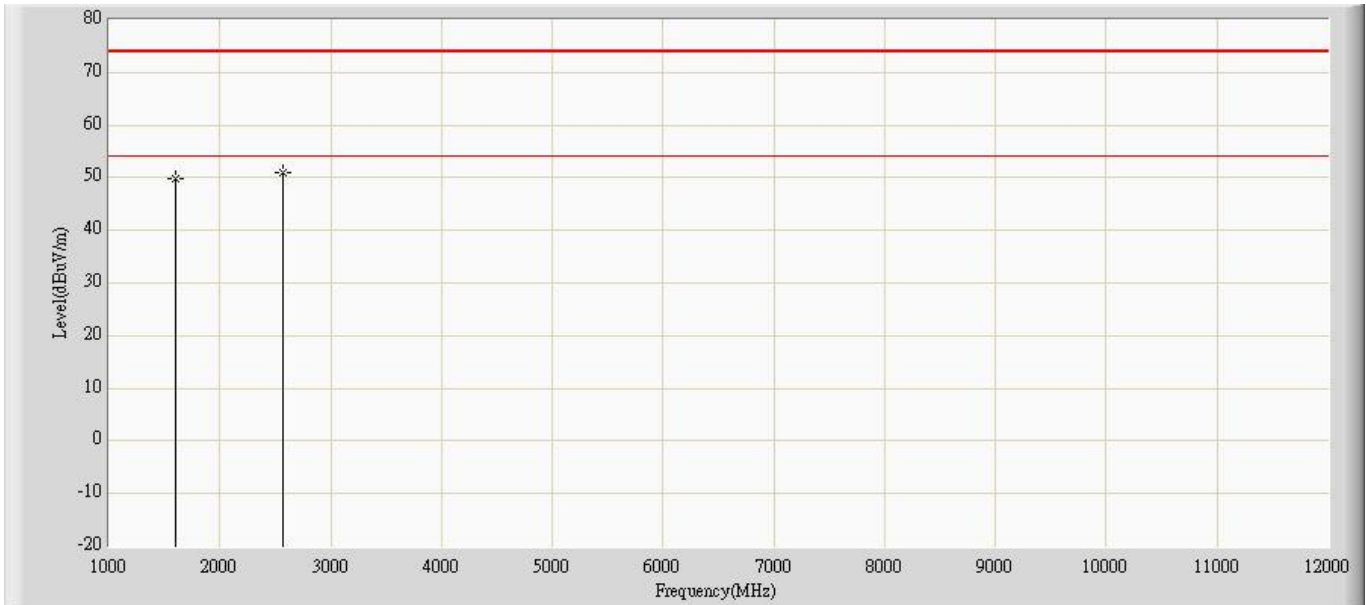

No	Flag	Mark	Frequency (MHz)	Measure Level (dBuV/m)	Reading Level (dBuV)	Over Limit (dB)	Limit (dBuV/m)	Factor	Ant Pos (cm)	Table Pos (deg)	Type
1			1595.000	49.767	62.800	-24.233	74.000	-13.033	100	-160	PK
2		*	2575.000	50.991	58.600	-23.009	74.000	-7.609	100	63	PK

Note:

1. All Readings below 1GHz are Quasi-Peak, above are performed with peak and/or average measurements as necessary.
2. " * ", means this data is the worst emission level.
3. Measurement Level = Reading Level + Factor (ant factor + cable loss - amp).

Site: CB7	Time: 2018/01/16 - 22:06
Limit: FCC_B_(Above_1G)	Margin: 0
Probe: CB7_Horn_3117_1707	Polarity: Vertical
EUT: Wireless Headset	Power: AC 120V/60Hz
Note: Mode 1	

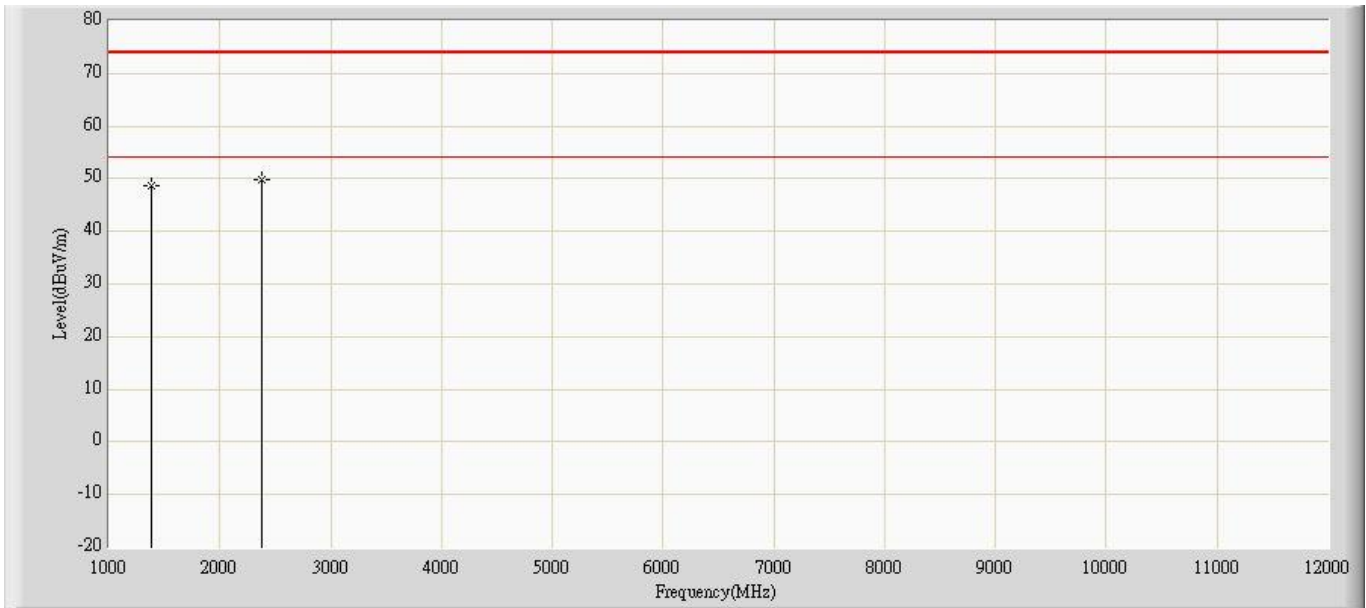

No	Flag	Mark	Frequency (MHz)	Measure Level (dBuV/m)	Reading Level (dBuV)	Over Limit (dB)	Limit (dBuV/m)	Factor	Ant Pos (cm)	Table Pos (deg)	Type
1			1385.000	48.794	62.900	-25.206	74.000	-14.106	100	113	PK
2		*	2375.000	49.902	58.200	-24.098	74.000	-8.299	100	20	PK

Note:

1. All Readings below 1GHz are Quasi-Peak, above are performed with peak and/or average measurements as necessary.
2. " * ", means this data is the worst emission level.
3. Measurement Level = Reading Level + Factor (ant factor + cable loss - amp).