

Jabra

Jabra PRO 9450, 9450-Duo,
9460 and 9470

User manual

www.jabra.com

© 2008 Jabra, GN Netcom A/S. All rights reserved. Jabra® is a registered trademark of GN Netcom A/S. All other trademarks included herein are the property of their respective owners. The Bluetooth® word mark and logos are owned by the Bluetooth SIG, Inc. and any use of such marks by GN Netcom A/S is under license.

(Design and specifications subject to change without notice).

ENGLISH

CONTENTS

1. INTRODUCTION	8
1.1 JABRA PRO FEATURES AND MODEL OPTIONS	8
1.2 ENABLING NEW FEATURES	9
2. IMPORTANT WARNINGS AND SAFETY INFORMATION	10
2.1 PROTECTING YOUR HEARING WITH PEAKSTOP AND INTELLITONE	10
2.2 POWERING THE BASE AND HEADSET	11
2.3 BATTERY INFORMATION	11
2.4 OPERATING ENVIRONMENT	11
2.5 CARE AND MAINTENANCE	11
2.6 EMERGENCY CALLING	11
2.7 CHILDREN AND PRODUCT PACKAGING	11
2.8 OTHER SPECIFICATIONS	11
3. PACKAGE CONTENTS	12
3.1 WHAT'S IN THE BOX	12
3.2 OPTIONAL ACCESSORIES	13
3.3 HEADSET DIAGRAMS	14
3.4 BASE DIAGRAM	16
4. SYSTEM SETUP AND CONNECTIONS	17
4.1 SETUP OVERVIEW AND BACKGROUND	17
4.2 THE QUICK-START SETUP WIZARD	18
4.3 ASSEMBLING THE BASE AND HEADSET	19
4.4 CONNECTING THE BASE TO YOUR DESK PHONE	21
4.5 USING A HANDSET LIFTER OR ELECTRONIC HOOKSWITCH	23
4.6 CONNECTING THE BASE TO YOUR COMPUTER	24
4.7 USING A REMOTE ONLINE INDICATOR	24
5. INSTALLING AND RUNNING THE JABRA PC SUITE	25
5.1 JABRA PC SUITE FEATURES	25
5.2 INSTALLING THE JABRA PC SUITE	25

5.3	JABRA PC SUITE PROGRAMS	25
5.4	FIRMWARE UPDATES	26
5.5	CENTRAL ADMINISTRATION AND MASS DEPLOYMENT	27
5.6	JABRA PC SUITE DOCUMENTATION	27
6.	DAILY USE—CALLING, ANSWERING AND HANGING UP	28
6.1	HEADSET CONTROLS AND INDICATORS	28
6.2	THE 'TARGET PHONE' CONCEPT	29
6.3	HOW TO MAKE A CALL	30
6.4	HOW TO ANSWER A CALL	32
6.5	HANGING UP	33
6.6	CONTROLLING THE SPEAKER VOLUME AND MICROPHONE	34
6.7	SWITCHING BETWEEN YOUR PHONE AND HEADSET	35
6.8	LAST NUMBER REDIAL	35
6.9	MANAGING CALL COLLISIONS AND CALL WAITING	35
6.10	LISTENING TO MUSIC	36
7.	THE JABRA PRO HEADSET	37
7.1	HEADSET DIAGRAMS	37
7.2	HOW TO WEAR THE HEADSET	38
7.3	ASSEMBLING OR CHANGING THE WEARING STYLE	39
7.4	HEADSET CONTROLS AND SIGNALS	40
7.5	BATTERY INDICATORS, RECHARGE AND REPLACEMENT	44
7.6	STAYING WITHIN RANGE	46
7.7	NOISE-BLACKOUT MICROPHONE (JABRA PRO 9460 AND 9470)	46
7.8	NOISE-CANCELLING MICROPHONE (JABRA PRO 9450 AND 9450-DUO)	46
8.	THE JABRA PRO TOUCHSCREEN BASE	47
8.1	BASE DIAGRAM	47
8.2	BASE CONNECTIONS AND SETUP	48
8.3	USING THE TOUCHSCREEN	48
8.4	STANDARD OPERATION	48

8.5	PAIRING AND CONNECTING THE BASE AND HEADSET	49
8.6	SETTING ACTIVE-CALL AND AUDIO PREFERENCES.....	50
8.7	MANAGING CALL COLLISION	50
8.8	MANAGING CALL WAITING	51
8.9	SETTING GENERAL USER PREFERENCES.....	53
8.9	RE-RUNNING THE DESK PHONE, PC AND/OR MOBILE PHONE SETUP WIZARDS.....	54
8.11	BASE AUDIO INDICATORS	54
8.12	NARROWBAND VS. WIDEBAND AUDIO.....	55
8.13	CONFERENCE CALLING.....	55
8.14	THEFT PROTECTION	55
8.15	DEALING WITH DENSITY ISSUES.....	55
8.16	REPLACING THE CRADLE.....	56
9.1	JABRA PRO BLUETOOTH SUPPORT	57
9.2	PAIRING AND CONNECTING THE BASE WITH OTHER BLUETOOTH DEVICES.....	58
9.3	USING THE HEADSET WITH YOUR MOBILE PHONE.....	59
9.4	REVIEWING YOUR MOBILE PHONE CALL HISTORY.....	59
10.	RECORDING YOUR CALLS	60
11.	FAQS AND TROUBLESHOOTING.....	61
12.	GETTING ASSISTANCE	63
12.1	EUROPE.....	63
12.2	USA AND CANADA	63
12.3	ASIA/PACIFIC	63
13.	TECHNICAL SPECIFICATIONS	64
13.1	ALL JABRA PRO HEADSETS.....	64
13.2	JABRA PRO MIDI HEADSET	64
13.3	JABRA PRO FLEX HEADSET.....	64
13.4	JABRA PRO 9450-DUO HEADSET.....	65

13.5 HEADSET HEARING PROTECTION.....	65
13.6 HEADSET BATTERY	65
13.7 MATERIALS AND ALLERGIES	65
13.8 TOUCHSCREEN BASE	66
13.9 JABRA PRO 9470 BASE BLUETOOTH SUPPORT	66
13.10 PRODUCT DISPOSAL	66
13.11 CERTIFICATIONS AND SAFETY APPROVALS.....	67

© 2008 Jabra, GN Netcom A/S. All rights reserved. Jabra® is a registered trademark of GN Netcom A/S. All other trademarks included herein are the property of their respective owners. The Bluetooth® word mark and logos are owned by the Bluetooth SIG, Inc. and any use of such marks by GN Netcom A/S is under license.
(Design and specifications subject to change without notice).

ENGLISH

1. INTRODUCTION

Thank you for selecting a Jabra® Jabra PRO™ headset. We are sure that you will enjoy its wide range of features and find it comfortable to wear and easy to use.

Jabra PRO headsets are available in a wide range of configurations, including several different headset designs, wearing styles, connectivity options and control features. All of the models in the Jabra PRO family feature a DECT-based wireless headset and base station. They all share hands-free working efficiency, wireless mobility, and many customization and accessory options.

All Jabra PRO headsets feature a dual noise-blackout or single noise-cancelling microphone, one or two speakers, easy-to-use controls and wireless communication. The headset is very lightweight and sits next to your ear, with the microphone extended towards your mouth by a short boom arm. Several wearing styles are available, including ear hook, headband, neckband and/or dual-mono; the options available to you will depend on which model you have purchased.

The Jabra PRO Touchscreen Base connects to your desk telephone and PC and manages the wireless link to your headset; it also recharges your headset battery while you are not using it. The touchscreen makes it easy to view information, connect to your various phones, configure the solution and more. The Jabra PRO 9470 Base also features Bluetooth, so it can connect to your mobile phone too.

1.1 JABRA PRO FEATURES AND MODEL OPTIONS

This manual describes the Jabra PRO 9470, 9450, 9460 and 9450-Duo headset solutions. Model differences, where they exist, are noted in this document.

Jabra PRO Headset Features

All Jabra PRO headsets described in the manual provide the following:

- Range from base to headset up to 150m
- Wideband audio for extra audio quality (when also supported by the connected phone).
- Touch-panel volume and mute control
- Intuitive headset control via adaptive multifunction button for answer/end call, call-waiting control and other functions
- Status LED and audio feedback
- Advanced hearing protection with Peakstop™ and Intellitone™ noise-exposure controls

The Jabra PRO 9470 and 9460 headsets also feature the following:

- Jabra PRO Midi boom design
- Dual noise-blackout microphones
- Choice of ear-hook or headband wearing style (neckband also available as an accessory)

The Jabra PRO 9450 headset also features the following:

- Jabra PRO Flex boom design
- Single noise-cancelling microphone
- Choice of ear-hook or headband wearing style (neckband also available as an accessory)

The Jabra PRO 9450-Duo also features the following:

- Jabra PRO Flex boom design
- Single noise-cancelling microphone
- Headband wearing style with a speaker for each ear (dual mono, which means that the same signal comes out of both speakers)

Jabra PRO Touchscreen Base Features

- 2.4" color touchscreen
- Touchscreen-guided set up of desk phone, mobile phone and PC connections
- Touchscreen control of calls and connections to all connected phones (including desk phone, mobile phone and/or softphone)
- Desk phone support (with optional electronic-hookswitch support for selected phones)
- Bluetooth support (Jabra PRO 9470 only) links the base to your mobile phone. Supports both the standard headset Bluetooth profile and the more advanced hands-free and phone-book lookup profiles to provide features such as redial, call-list browsing and voice-activated dialing (depending on mobile phone model).
- Advanced softphone support and control
- On-screen caller ID
- Wideband audio for extra audio quality (when also supported by the connected phone).
- Headset recharge cradle

- Call-waiting control (for managing multiple calls to your softphone or mobile phone)
- Call-collision control (for managing multiple calls to different phones, such as desk and soft phones)
- Mass-deployment features enable IT managers to load identical settings onto any number of bases via the USB connection.

1.2 ENABLING NEW FEATURES

Jabra PRO provides an e-commerce based system for adding new features to your solution. These may be features that you elected not to purchase when you first bought your headset, or they may be new features that have been released since then. New features such as these might arrive in the form of new PC software or as firmware updates to your base and/or headset.

You can obtain a new license key online by using the Jabra e-commerce site, so you never need to leave your office or wait for delivery. A link to the online shop is provided in the Jabra Control Center. Please see the Jabra PC Suite online help for complete details about how to purchase and enter new license keys.

2. IMPORTANT WARNINGS AND SAFETY INFORMATION

2.1 PROTECTING YOUR HEARING WITH PEAKSTOP AND INTELLITONE

WARNING: Whenever you wear a headset, you are exposing your ears to a potential hearing risk. The risk is higher than with traditional telephones because a headset is held firmly against your ear while your hands may be busy with something else; this means that it may take longer to react to a sudden, loud sound in your headset. Furthermore, extensive headset use at loud volumes may damage your hearing over time; the more you use your headset each day, the lower the maximum volume should be to protect you against hearing loss. Jabra PRO headsets provide effective measures that protect you against both of these types of dangers and ensure that your noise exposure at work does not exceed local regulations. Read this to learn now.

Peakstop Acoustic-Shock Protection

Jabra PRO headsets offer protection against sudden, loud audio spikes, such as static on the line, fax signals or loud noises on the other end. Your Jabra PRO headset will automatically suppress the spike, thereby protecting your ears from acoustic shock. In Jabra PRO models, this system is called Peakstop™, which is only available from Jabra.

This level of protection is also called Intellitone level 0 (see below).

Intellitone Noise-Exposure Protection

Hearing risk is evaluated as a function of both volume and duration. Therefore, the maximum sound level should be lowered as the number of hours you spend using the headset increases. Most countries have noise-exposure regulations for the workplace, some of which may also apply to headset users.

Jabra PRO headsets offer a choice of four protection levels (all of which also include the standard Peakstop protection described above). These features protect your hearing by preventing acoustic shocks and limiting the maximum noise exposure from the headset during your workday. This system is called Intellitone™, which is only available from Jabra.

All four Intellitone levels above zero meet and exceed de facto global protection levels, and are compliant with NIOSH standards and EU health and safety codes of 85 dB(A).

The TT4 protection level is compliant with pertinent Australian recommendation.

The table below summarizes the protection levels available.

Protection level	Criteria for selecting
Level 0	Basic protection against overly-loud sound spikes [118 dB(A)]; auto volume disabled
Level 1*	Less than 4 hours on telephone/day
Level 2*	4-8 hours on telephone/day
Level 3*	More than 8 hours on telephone/day
Level 4 (TT4)	Recommended Australian protection level (Telstra)

Table 1: Levels of Intellitone hearing protection

It is possible to lock and password-protect the Intellitone setting.

For details about how to configure Intellitone for your headset, please see one of the following:

- To set the Intellitone level using the touchscreen, please see *8.9: Setting General User Preferences*.
- To set the Intellitone level using Jabra Control Center on your PC, please see the Jabra PC Suite online help.
- To set a password and lock or unlock the Intellitone settings, use the Jabra Control Center on your PC; please see the Jabra PC Suite online help.

Important: Check your local laws or regulations to find out whether a specific protection level is mandated in your area. Note also that your headset settings do not affect the sound level of your desk phone headset, so you may be receiving less protection when using the headset.

2.2 POWERING THE BASE AND HEADSET

Warning: Do not attempt to charge your Jabra headset with anything other than the Jabra PRO Touchscreen Base. Do not attempt to power the Jabra PRO Touchscreen Base with any power supply other than the one provided with the product. The use of any other AC adapter may damage or destroy the headset and/or base and may invalidate any approval or warranty; it can also be dangerous. For availability of approved accessories, please check with your dealer. When you disconnect the power cord of any accessory, grasp and pull the plug, not the cord. Never use a charger that is damaged.

2.3 BATTERY INFORMATION

The headset is powered by a rechargeable battery. The full performance of a new battery is achieved only after two or three complete charge and discharge cycles. The battery can be charged and discharged hundreds of times, but will eventually wear out; replacements are available from Jabra. Recharge your headset only with the chargers designed specifically for it.

If left unused, a fully charged battery will lose its charge over time. Storing the device in extremely hot or cold places may reduce the capacity and lifetime of the battery. Always try to keep the battery between 15°C and 25°C (59°F and 77°F). A device with a hot or cold battery may not work temporarily, even when the battery is fully charged. Battery performance is particularly limited in temperatures well below freezing.

Do not dispose of the headset in a fire as the battery may explode. Batteries may also explode if damaged. Dispose of the headset according to local regulations. Please recycle when possible. Do not dispose as household waste.

2.4 OPERATING ENVIRONMENT

The base and headset are intended for indoor use at conventional levels of room temperature and humidity. Avoid getting the base or headset wet and never submerge them in water.

The standard operating temperature is -10° to +60° C (14° to 140° F). Avoid exposing the base or headset to temperatures outside of this range.

2.5 CARE AND MAINTENANCE

Protect your base and headset just as you would any other type of sensitive electronic equipment. If your Jabra devices require cleaning, then consider the following advice:

- If necessary, clean the touchscreen with a standard computer-screen cleaning solution, such as dry wipes, anti-static screen cleaner and/or prepackaged towelettes.
- The headset, headband neckband and ear hook can be wiped clean with a dry cloth if needed.
- The cords and base unit can be dry-dusted as required.
- The leatherette ear cushion(s) can be cleaned or replaced. When cleaning, remove them and wipe with a damp cloth.
- Avoid getting moisture or liquids into any button ports, receptors or other openings.
- Avoid exposing the product to rain.

2.6 EMERGENCY CALLING

If you need to call emergency services (such as 911 in the US), always use a standard land-line or mobile telephone. Do not use a softphone or (in most cases) any type of VoIP phone. This is because emergency-service numbers immediately trace your call to make sure that response teams (such as police, fire fighters and paramedics) can find you even if the call gets cut off or the signal is weak. This call-tracing feature will not work on a softphone or in many standard VoIP phones.

2.7 CHILDREN AND PRODUCT PACKAGING

The packaging, including plastic bags and wrapping parts, are not toys for children. The bags themselves or the many small parts they contain may cause choking if ingested. Keep all packaging out of the reach of children.

2.8 OTHER SPECIFICATIONS

For complete technical specifications, see *Chapter 13: Technical Specifications*.

3. PACKAGE CONTENTS

3.1 WHAT'S IN THE BOX

- 1. Headset appropriate for your Jabra PRO model
- 2. Base
- 3. Headset cradle
- 4. Power adapter
- 5. Ear hook (not included with Jabra PRO 9450-Duo)
- 6. Headband (not included with Jabra PRO 9450-Duo)
- 7. Telephone cable
- 8. USB cable
- 9. Installation CD with Jabra PC Suite Software, user's guide and other tools

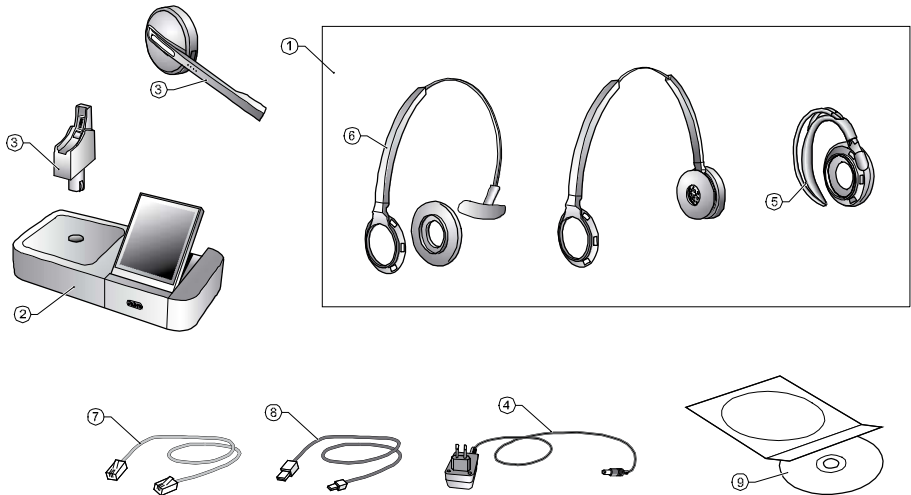

Figure 1: Components included with Jabra PRO models that feature a touchscreen base.

3.2 OPTIONAL ACCESSORIES

The following accessories for Jabra PRO are available separately and are occasionally mentioned in the other chapters of this manual. You may have ordered one or more of these together with your headset.

- 1 Remote Handset lifter GN1000 RHL**
- 2 Electronic-hookswitch adapter for your desk-phone model**
- 3 Neckband (not compatible with Jabra PRO 9450-Duo)**
- 4 Replacement headband**
- 5 Replacement ear hook**
- 6 Replacement ear cushions**

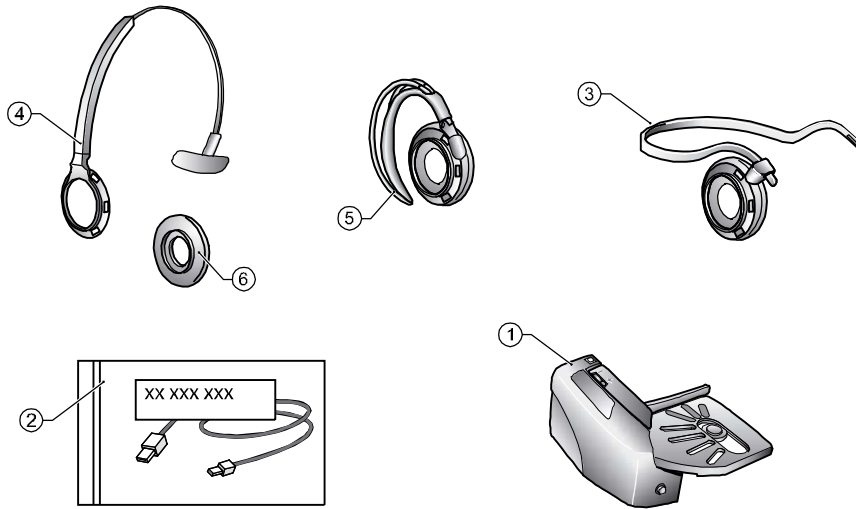

Figure 2: Jabra PRO accessories (available separately)

3.3 HEADSET DIAGRAMS

Jabra PRO models are available with several headset options, each of which is illustrated below. The following key applies to all three headset illustrations:

- 1 Multifunction button (answer/end call, among other functions)**
- 2 Touch panel for volume and mute control**
- 3 Activity and status indicator (multicolor LED)**
- 4 Noise-cancelling port or noise-blackout microphone**
- 5 Voice microphone**
- 6 Boom arm (flex or midi)**
- 7 Recharge contact**
- 8 Mount for wearing-style attachments**
- 9 Speaker(s)**

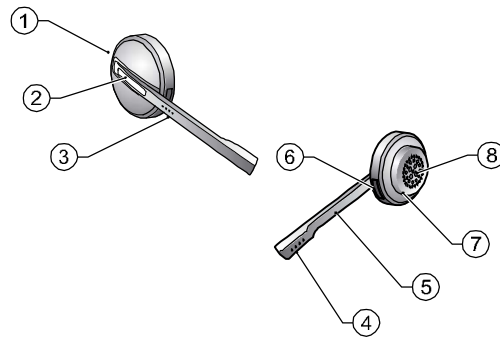

Figure 3: Jabra PRO Midi headset (included with Jabra PRO 9470 and Jabra PRO 9460) as seen from the outer and inner sides, respectively



Figure 4: Jabra PRO Flex headset (included with Jabra PRO 9450) as seen from the outer and inner sides, respectively



Figure 5: Jabra PRO 9450-Duo headset

Note: most of the other illustrations in this manual show the Jabra PRO Midi headset; all other headset models feature similar controls at similar locations, as illustrated in the figures above.

3.4 BASE DIAGRAM

- 1 Headset cradle
- 2 Recharge contact
- 3 Touchscreen
- 4 Desk-phone termination switch (not included on the Jabra PRO 9470 base, where this is software controlled)
- 5 Cover for desk-phone control (not included on the Jabra PRO 9470 base)
- 6 Telephone port
- 7 Handset port
- 8 AUX port
- 9 USB port
- 10 Power adapter port
- 11 Remote online-indicator port
- 12 Security slot
- 13 Speaker for ring tones and touchscreen audio feedback

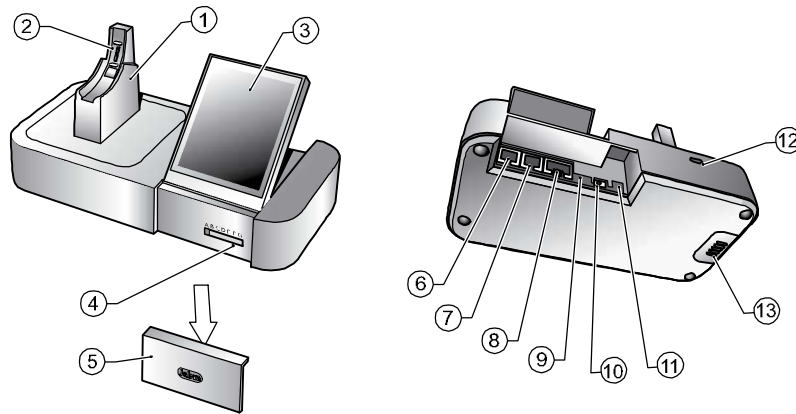

Figure 6: Jabra PRO Touchscreen Base, seen from the front and back, respectively

6 Telephone port



7 Handset port



8 AUX port



9 USB port



10 Power adapter port



11 Remote online-indicator port



4. SYSTEM SETUP AND CONNECTIONS

This chapter explains how to assemble your Jabra PRO solution and connect it to your other office equipment.

4.1 SETUP OVERVIEW AND BACKGROUND

This provides an overview of how your headset and base work with your other phones. It also provides background information that may help you to understand the capabilities of your headset and the purpose of its many settings and options.

Connection Diagram

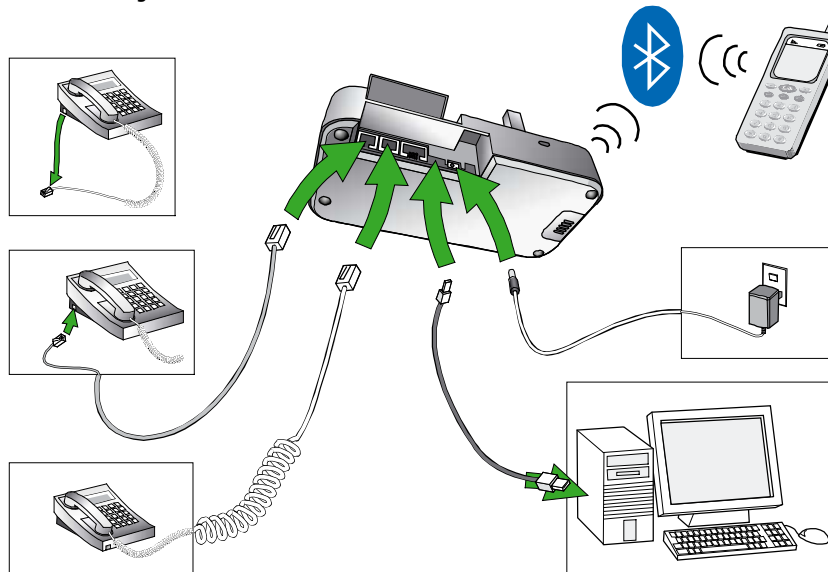

Figure 7: Jabra PRO base connections (Bluetooth available with Jabra PRO 9470 only)

Using a Headset with a Desk Phone

Desk phone technology predates headset technology by many years. There are many different desk phone models and each of them is designed slightly differently—often without regard for eventual integration with a headset. To accommodate the full range of desk phones in use, Jabra PRO is able to adapt itself to your phone by offering the following settings:

- **Termination standard**
All desk phones use the same type of 4-wire cable to connect the handset to the phone body. However, the order in which these four wires are connected inside the handset varies from manufacturer to manufacturer. This means that even though the phone cable fits, the signal travelling down each wire might not match the expectations of your desk phone. Jabra PRO supports all of the possible combinations and will assist you in finding the right one.
- **Microphone level**
Due to differences in microphone designs, the sound level sent from the handset to the phone body varies between desk phone models. The sound volume sent from your Jabra PRO base must therefore be adjusted to ensure that it is neither too quiet (making you hard to hear) nor too loud (making you sound distorted) for your desk-phone model.
- **Electronic hookswitch or handset lifter**
Usually, desk phones are only able to connect to the phone network when you physically lift the handset or press the headset button (if present), thus releasing the hookswitch. However, you can automate this by using either a remote handset lifter or electronic-hookswitch adapter (depending on phone type), which are available as optional accessories for Jabra PRO. These solutions enable you to answer the phone or hang up using only the button on your headset or its docking operations.

The Jabra PRO setup wizard will help you to make each of the above settings.

Using a Headset with a Softphone

All Jabra PRO models described in this manual can be used together with softphones running on your PC, such as Skype, Cisco IP Communicator and Microsoft Office Communicator.

When you use Jabra PRO together with a supported softphone application, you will be able to answer calls using the headset button and/or touchscreen, control call waiting and manage other calling features. The features available to you will depend on which softphone you are using and whether there is a Jabra driver available for it. To use Jabra PRO with a softphone, you must connect the Jabra PRO base to your PC via a USB cable and install the Jabra PC Suite collection of software and softphone drivers on your PC. The Jabra PRO setup wizard will help you do this.

Using a Jabra PRO 9470 Headset with a Mobile Phone

Jabra PRO 9470 can be used together with your mobile phone via a Bluetooth connection between the Jabra PRO 9470 Base and your phone.

To enable Bluetooth communication, you must pair the Jabra PRO 9470 Base with your mobile phone. This enables the two devices to communicate with each other and to encrypt all transmissions, thereby ensuring that other people cannot intercept and understand your conversation. Pairing is a standard feature of all types of Bluetooth devices.

The Jabra PRO 9470 Base supports both the standard headset Bluetooth profile and the more advanced hands-free and phone-book lookup profiles. The features available to you (such as redial, call-list browsing and voice-activated dialing) will depend on which of these profiles are also supported by your mobile phone.

The Jabra PRO setup wizard will help you to connect your base and mobile phone.

4.2 THE QUICK-START SETUP WIZARD

Getting started is very simple—all you need to do is apply power to the base and then follow the instructions on the touchscreen. The touchscreen will walk you through all of the required cable connections and configuration settings, though you may also need to refer to your desk phone documentation (especially if you will be using an electronic-hookswitch connection). When you are done, you will have a fully working and integrated solution.

To run the setup wizard:

1. If you have not already done so, then review the information outlined in [4.1: Setup Overview and Background](#). It will help you understand the types of tasks that the setup wizard will ask you to do.
2. Assemble the base and apply power to it. (See also [4.3: Assembling the Base and Headset](#)).
3. Right after it powers up for the first time, the base launches the setup wizard on the touchscreen. Follow the instructions on the first screen and then touch the “next” icon (a right-pointing arrow). For an overview of how to work with the touchscreen, see also [8.3: Using the Touchscreen](#). Note the following for when the wizard is helping you set up your desk phone:
 - At one point, the wizard will ask you to call the Jabra test server. This enables the base to test each available termination switch setting and to set the microphone level based on signals exchanged with the test server (both of these settings are internal and will be set automatically). See your Jabra PRO Quick Start Guide for a list of Jabra test-server phone numbers to find the one nearest you (you can also find this list on our web site).
 - As pointed out in Figure 6, the Jabra PRO 9450 base has a physical termination switch while Jabra PRO 9470 does not. Both types of base require this setting, but the 9470 base has an internal, software-controlled switch for this function. If you have a Jabra PRO 9450 Base, then the setup wizard will instruct you about how to set this switch while it is communicating with the Jabra test server; Jabra PRO 9470 is able to make this setting without additional user interaction.
4. Continue until the wizard tells you that you are finished. At this point, all of your phones should be connected and your headset will be fully configured to work with each of them.

The remainder of this chapter provides extra information about each step of the setup process. Refer to this chapter if you have trouble while working through the on-screen setup wizard.

Tip: Once you have completed the wizard, it will not launch again automatically. However, you can re-start the setup wizard manually at any time, thereby reinitializing some or all base and headset settings. See [8.10: Re-running the Desk Phone, PC and/or Mobile Phone Setup Wizards](#) for details.

Tip: Once you have completed the wizard, it will not launch again automatically. However, you can re-start the setup wizard manually at any time, thereby reinitializing some or all base and headset settings. See [8.10: Re-running the Desk Phone, PC and/or Mobile Phone Setup Wizards](#) for details.

4.3 ASSEMBLING THE BASE AND HEADSET

The base is shipped with the headset battery just partially charged (usually with enough of a charge to be used during setup). The first thing you should do after opening the package is to attach the cradle, plug in the base and insert the headset into the cradle so that it charges up if needed.

Attach the Headset Cradle

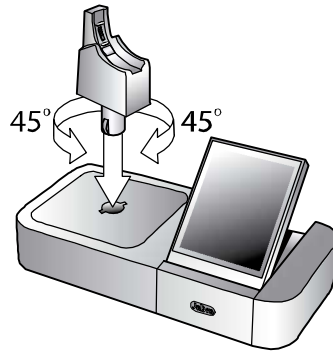

Figure 8: Attaching the headset cradle to the base

To attach the headset cradle to the base:

1. Hold the cradle against the base as shown in Figure 8 (so that the pins on either side of the cradle post align with the slots on either side of the hole on the base).
2. Rotate the cradle 45° clockwise or counterclockwise, whichever you prefer. The cradle will lock into place with a soft click.

Tip: Because the cradle is removable, it is possible to upgrade it later so that you can use a future Jabra headset with your existing Jabra PRO base station.

Apply Power to the Base

Connect the power supply to the port marked  on the base, and then plug the power supply into a wall outlet as shown in Figure 9.

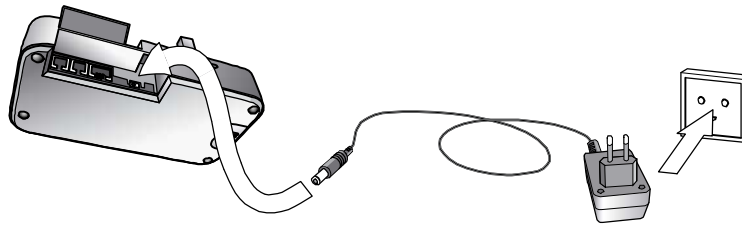

Figure 9: Powering the base

Tip: If this is the first time you have plugged in your unit, the setup wizard will launch automatically on your touchscreen. It guides you through all of the remaining steps required to setup your headset. We recommend that you work through the wizard now and refer to the remainder of this chapter only if you have trouble understanding what the wizard is asking you to do.

Assemble the Headset

Most Jabra PRO headsets (other than Jabra PRO 9450-Duo) can be worn in any of several wearing styles, including headband, ear hook and neckband. Ear hook and headband wearing-style attachments are included; the neckband is available separately. Jabra PRO 9450-Duo is always worn as a headset and does not require any assembly.

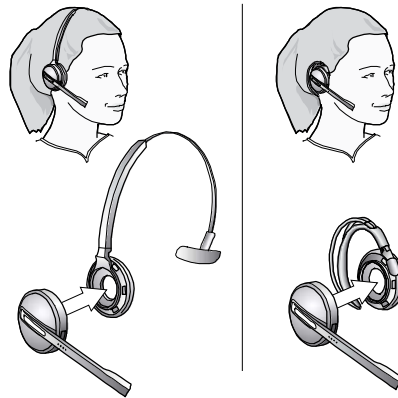

Figure 10: Assembling the Jabra PRO headset into various styles

Assemble the headset into a wearing style by doing the following:

1. Select a wearing-style attachment (e.g., headband or ear hook).
2. Gently press the headset assembly onto the outer side of the attachment until it clicks into place.
3. Gently press the ear cushion assembly onto the inner side of the attachment, also until it clicks into place.
4. Rotate the boom arm for left- or right-ear use as needed. Always position the microphone so that it sits as close to the corner of your mouth as possible when you wear the headset.

Important: Regardless of which wearing style you choose, always be sure to adjust the headset so that the microphone is positioned as close to your mouth as possible. This will maximize the noise-cancelling effect of the microphone and make sure that your voice comes through loud and clear.

Place the Headset in its Cradle

Whenever you are not using your headset, you should keep it in its recharge cradle. This will ensure that it is always ready for use. The battery level is indicated by a battery icon on the touchscreen.

The headset slips easily into its cradle as shown in Figure 11. It is held firmly in place by a magnet.

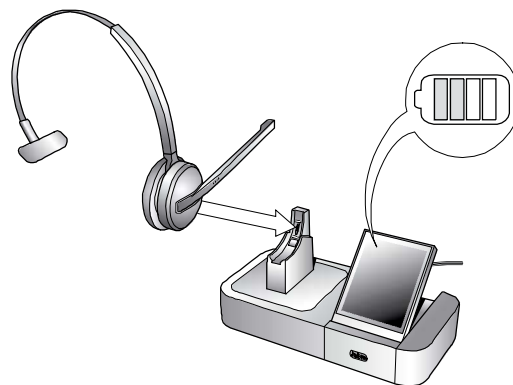

Figure 11: Inserting the headset into the cradle for storage and charging.

JJABRA PRO 9450, 9450-DUO, 9460 AND 9470 USER MANUAL

4.4 CONNECTING THE BASE TO YOUR DESK PHONE

Identifying Your Desk Phone Features

There are many types of desk phones, each of which works slightly differently. All Jabra PRO models are able to work with nearly all types of desk phones, but the way you connect and configure the base will vary according to the type of phone you are using. Check your desk phone (by looking at its connectors and/or documentation) to see which of the following features it has, then see the appropriate below to learn how to connect your Jabra PRO base to the phone:

- **Standard desk phone**
This type of phone does not include any built-in support for adding a headset. You will therefore connect the Jabra PRO base between the handset and the desk phone body, enabling you to use either the handset or headset. All desk phones can be connected in this way.
- **Desk phone with headset port**
Some phones provide a dedicated headset port (usually at the back of the phone). These phones typically also have a button on the front panel for switching the conversation between the headset and handset. This type of phone may or may not have an electronic hookswitch (see below).
- **Desk phone with electronic hookswitch**
Most desk phones connect to the phone network only when you physically lift the handset or press the headset button (if present). However, some phones are able to open this connection electronically in response to commands from your headset. This requires an extra adapter cable and support for one of the electronic hookswitch standards recognized by Jabra PRO. Please see our web site and/or refer to your telephone's user manual for details about electronic hookswitch compatibility.
- **Desk phone without electronic hookswitch**
If your phone does not have an electronic hookswitch, you must lift the handset each time you want to make or answer a call—or you could install a handset lifter, which will do this automatically in response to commands from your headset. When you use a handset lifter, the solution will work in essentially the same way as one that includes an electronic hookswitch. We recommend the GN1000 RHL handset lifter, which is available separately; please speak to your Jabra dealer for details.

Connecting to a Desk Phone without a Headset Support

If your desk phone does not include any built-in support for adding a headset, then connect the Jabra PRO base between the handset and the desk-phone body as described below.

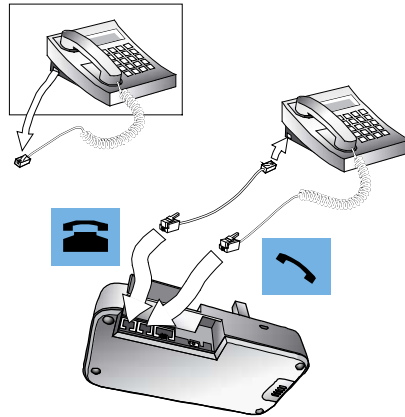



Figure 12: Connecting to a desk phone without a headset port

1. On your desk phone, find the wire that connects the handset to the phone body and disconnect this wire at the phone-body side. To do this, use your fingernail to press down the small tab at the top of the square connector and then gently pull the wire away from the phone body.
2. Plug the now loose end of your handset cord to the port marked  on the base. Press it in until you hear or feel the soft click of the connector tab popping into place.

3. Find the short telephone connector cord included with your headset and connect one end of it to the port marked  on the base. Connect the other end to the handset port on your desk phone body (the same port from which you removed the handset cable).
4. Your base and desk phone are now connected. Note, however, that you must still configure the connection (termination standard) and microphone volume before you can use your headset. Usually, you will do this as you work through the setup wizard right after you first turned on the base. However, if you skipped this part of the setup, or if you buy a new desk phone, then you can reconfigure the connection at any time using the touchscreen; see [8.10: Re-running the Desk Phone, PC and/or Mobile Phone Setup Wizards](#) for instructions.

Connecting to a Standard Headset Port

If your desk phone includes a dedicated headset port, then you can take advantage of this feature by connecting the Jabra PRO base as follows:

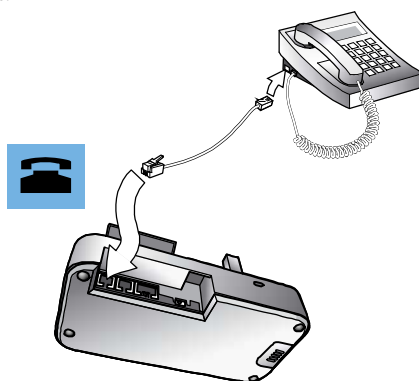



Figure 13: Connecting to a desk phone with a headset port

1. Find the short telephone cord included with your headset and connect one end of it to the port marked  on the Jabra PRO base. Connect the other end to the headset port on your desk-phone body. See your desk-phone documentation if you are not sure where this port is. If the supplied cord does not fit the port of your desk-phone, then see "Connecting to a Proprietary Headset Port," below.
2. Your base and desk phone are now connected. Note, however, that you must still configure the connection (termination standard) and microphone volume before you can use your headset. Usually, you will do this as you work through the setup wizard right after you first turned on the base. However, if you skipped this part of the setup, or if you buy a new desk phone, then you can reconfigure the connection at any time using the touchscreen; see [8.10: Re-running the Desk Phone, PC and/or Mobile Phone Setup Wizards](#) for instructions.

Note: Do not connect the base to a dedicated headset port if you want to use a GN1000; connect it inline with the handset instead (see also "Connecting to a Desk Phone without a Headset Support," above). One reason to use the GN1000 instead of the headset port is that the GN1000 has a ring detector, thereby enabling the base and headset to target the desk phone automatically when it rings (many electronic-hookswitch solutions also provide ring detection).

Connecting to a Proprietary Headset Port

Some types of desk phones provide a special type of headset port that is not the same as a standard telephone port. This is usually part of an advanced solution that might also support features such as electronic hookswitch, voice mail, recording and/or other functionality. These types of phones also include the standard handset ports described above, but you should consider taking advantage of the proprietary connection if possible.

To use this type of connection, you must purchase a special adapter designed to match the requirements of your desk phone and headset. Jabra supplies many types of adapters for this purpose. The adapter comes with instructions for how to connect it. See also [4.5: Using a Handset Lifter or Electronic Hookswitch](#) for more information about this type of solution.

4.5 USING A HANDSET LIFTER OR ELECTRONIC HOOKSWITCH

Traditional desk phones open a connection to the phone network only when you physically lift the handset from the phone (thereby releasing the hookswitch). This means that you must lift the handset (or press a desk-phone handset button, if present) whenever you want to place or receive a call. However, you can automate this connection by adding one of the following:

- GN1000 Remote Handset Lifter, which will work with nearly any phone.
- An electronic-hookswitch connection, which requires a supported desk phone and a phone-specific adapter from Jabra

Electronic solutions such as these enable you to answer an incoming call when away from your desk simply by pressing a button on the headset.

Another advantage of most of these types of solutions is that the base and headset are able to tell when your desk phone is ringing, thereby enabling you to answer the call just by lifting the headset from its cradle or tapping a button; otherwise, you may need to switch the current target of your headset to your desk phone before answering. The GN1000 and most electronic-hookswitch solutions support ring detection.

Connecting to the GN1000 Remote Handset Lifter

The GN1000 Remote Handset Lifter is an accessory available from Jabra. It is a motorized device that physically lifts the handset when you use controls of your headset or base. You can use the handset lifter with nearly any type of desk phone—including phones that also happen to have electronic-hookswitch support.

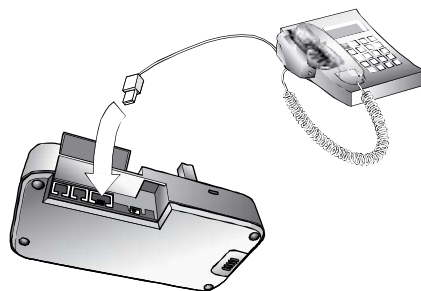

Figure 14: Connecting to a GN1000 RHL handset lifter

To connect the Jabra PRO base to a GN1000 RHL handset lifter:

1. Connect the Jabra PRO base to your desk phone using the standard in-line setup as described in 4.4: *Connecting the Base to Your Desk Phone*. Do not use your desk phone's headset port if it has one.
2. Assemble the GN1000 RHL handset lifter and attach it to your desk phone as described in the lifter's documentation.
3. Connect the control cord attached to the GN1000 to the port marked **AUX** on the Jabra PRO base. Press it in until you hear or feel the soft click of the connector tab popping into place.
4. Your base and handset lifter are now connected.

Using an Electronic Hookswitch Connection

Some phones are able to open a network connection electronically in response to hookswitch signals from the handset. The connection and communication standards for using the electronic-hookswitch feature vary according to the type of desk phone you have. To use this feature, you must therefore purchase and install the appropriate type of electronic hookswitch adapter for your phone; these are available from Jabra.

Adapter requirements can be very different between desk phone models; for example, some models require a "Y" cable that splits audio and electronic hookswitch paths on their way from the desk phone to the Jabra PRO base, while others use a single cable that carries the hookswitch signal alone, with audio signals sent via the handset or headset socket (as they are on phones without an electronic hookswitch). Please see our web site and/or refer to your telephone's user manual for details about electronic hookswitch compatibility.

To connect the Jabra PRO base to an electronic hookswitch port:

1. Make sure that you have purchased the correct electronic-hookswitch adapter for your desk phone model from Jabra.
2. Connect the electronic-hookswitch adapter as described in the cabling guide included with the adapter.
3. Configure the Jabra PRO base to communicate correctly with your model of desk phone. The required standard is clearly printed on a label attached to the hookswitch cable. The touchscreen setup wizard will automatically ask for this during initial setup; see also 8.10: *Re-running the Desk Phone, PC and/or Mobile Phone Setup Wizards* for instructions about how to make this setting at any time after the initial setup.
4. Check the documentation for your desk phone to see which (if any) steps are required to configure your desk phone to use the electronic switch.

4.6 CONNECTING THE BASE TO YOUR COMPUTER

Connect the touchscreen base to your computer if you would like to use your headset together with a softphone running on the PC. You can also use this connection to configure your headset and base and to update their firmware.

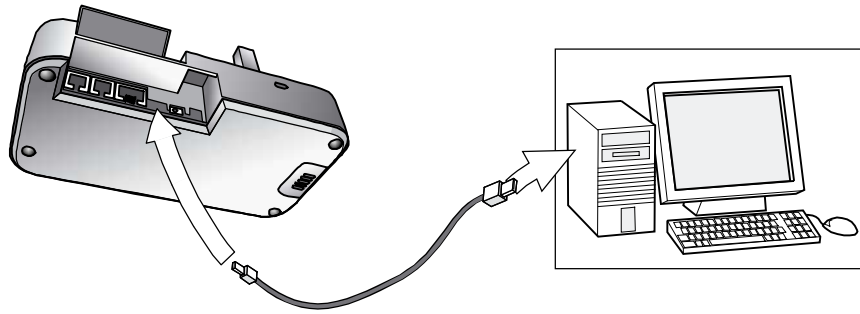



Figure 15: Connecting to a computer

To connect the Jabra PRO base to your computer:

1. Locate a free USB port on your computer. USB ports are usually marked with a  symbol and might be located anywhere on your computer body, keyboard or screen.
2. Find the USB cable included with your headset; it has a large connector on one end and a smaller connector on the other end.
3. Plug the larger connector of the USB cable into the USB port you found on your computer. Plug the other end into the port marked with a  symbol on the Jabra PRO base. The base is now connected to your computer.
4. Install the Jabra PC Suite software on your computer. (See *Chapter 5: Installing and Running the Jabra PC Suite for details.*)

4.7 USING A REMOTE ONLINE INDICATOR

All Jabra PRO models support a remote online indicator (OLI), which connects to your base via a cable and lights up to show when you are on the phone.

Because headset users often wear their headset all day, even when not talking on the phone, it can be difficult for colleagues to know whether or not you are on the phone when they want to talk to you in the office. By attaching an OLI device to your base, your colleagues will be able to see when you are online.

1. To connect an OLI to your base:
2. Unpack and assemble your OLI device as described in its documentation.
3. Connect the cable from your OLI device to the port marked  on the Jabra PRO base

Your base and online indicator are now connected. No additional settings are required to make it work.

See also the documentation that came with your OLI for more information about that product.

5. INSTALLING AND RUNNING THE JABRA PC SUITE

5.1 JABRA PC SUITE FEATURES

The Jabra PC Suite is a collection of programs that support and expand your headset's features. It enables you to:

- Control several types of softphone programs from your headset
- Configure the base and headset from your PC
- Update the firmware for your base and headset
- Save and recall headset configuration to/from your PC
- Upload language packs for touchscreen menus
- Upgrade your Jabra solution by entering license keys for locked features

5.2 INSTALLING THE JABRA PC SUITE

To install the Jabra PC Suite, do the following:

1. If you have not already installed your softphone, then we highly recommend that you do so before you install Jabra PC Suite. This will ensure that Jabra support is correctly added to your softphone program. If you add a new softphone program to your computer after installing Jabra PC Suite, then we recommend that you reinstall Jabra, which is quite easy.
2. Insert the CD included with your Jabra PRO headset into your computer's CD drive.

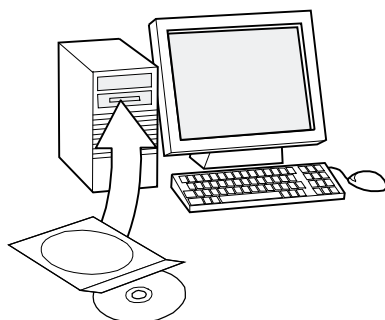

3. If your computer is set up to support CD autorun, then the Jabra setup program will launch right away. Otherwise, use the Windows file explorer to navigate to the root folder of your CD-ROM drive and execute the file named **JabraPcSuiteSetup.exe**.
4. Follow the instructions on your computer screen. Installation is very simple and should take just a minute or so. Please note the following as you work through the installation wizard:
 - The wizard will ask which components of the Jabra PC Suite you would like to install. Usually, you should install all of them. They do not take up very much space and none of them will affect the performance of your computer when they are not running.
 - The wizard will ask if you would like to start the Jabra Device Service when Windows starts (see also the descriptions of these programs below). If you will often use your headset with a softphone, then we recommend that you enable the Device Service. This will make your headset solution easiest to use; otherwise, you will need to start this program manually each time you wish to use your softphone. However, you might consider disabling it if you do not use softphones.

5.3 JABRA PC SUITE PROGRAMS

After installing the software, you will have an **All Programs > Jabra > Jabra PC Suite** folder in your Windows **Start** menu. It provides links to the following programs:

Jabra Control Center

This program enables you to configure your Jabra PRO system from your computer. Many of the settings here are the same as those presented on your touchscreen. In addition, this program enables you to configure the interaction between your headset and your softphone programs.

Jabra Device Firmware Updater

This program enables you to update the firmware of your Jabra PRO devices. Firmware is a type of software that runs inside many types of electronic devices, managing their various internal processes. Occasionally, Jabra may release updates that can improve performance, update graphics or add new functionality to your base and headset.

Jabra Devices Service

This simple program runs in the background and monitors your USB ports for Jabra devices. It makes sure that Windows will recognize these devices and enables the Jabra Control Center and Softphone drivers to interact with their advanced features.

- **Skype Driver**
This simple background program manages the connection between your headset solution and the Skype Softphone program. Among other things, it enables you to answer a Skype call using the controls on your headset.

In addition to the above programs, the PC Suite also provides the following:

- **Driver for Cisco IP Communicator**
This is a library (DLL) that is added to a Cisco IP Communicator installation if it is present when you install Jabra PC Suite. It enables you to control Cisco IP Communicator from your headset, but is otherwise invisible and does not require you to run or configure it. If you install Cisco IP Communicator after installing Jabra PC Suite, then reinstall the PC Suite to get the Cisco driver.
- **Microsoft Office Communicator support**
This softphone from Microsoft supports the latest USB human-interface standards and is therefore able to react to signals from your headset automatically without requiring any additional drivers. However, you must unlock Jabra PRO support for this solution by entering a license key in Jabra Control Center. See *1.2: Enabling New Features* for more information about how to purchase and enable new licenses.
- **Support for other softphones and audio programs**
Your Jabra headset appears just like a standard sound card in Windows, thereby enabling you to use any softphone, media player or other audio program together with the headset. However, most of these will not recognize any signals coming from your headset, so you will need to answer and place calls using your mouse and the program's standard graphical interface.

Note: Jabra is constantly evaluating the softphone market to see which new programs should be supported with a dedicated driver. Contact your Jabra representative or see the Jabra web site for the latest news on softphone driver development.

5.4 FIRMWARE UPDATES

Firmware is a type of software that runs inside many types of electronic devices, including your Jabra base and headset. Occasionally, Jabra may release updates that can improve performance and/or add new functionality to your base and headset.

Obtaining Firmware Updates

Visit the Jabra web site to find out if firmware updates are available for any of your Jabra PRO products. You will be able to download the updates from there as they become available.

Applying Firmware Updates

To apply a firmware update:

1. If you have not already done so, then attach your Jabra PRO Base to your computer using the supplied USB cable. (See *4.6: Connecting the Base to Your Computer*).
2. Place your headset in its cradle on the base.
3. If you have not already done so, then download the firmware update from Jabra and save it on your hard disk or network in a location where you can see it from your computer.
4. On your PC, run the firmware-update application of the Jabra PC Suite.
5. Follow the instructions on your screen to identify your Jabra PRO model, select the firmware update file and apply it. See also the Jabra PC Suite online help for more details.

5.5 CENTRAL ADMINISTRATION AND MASS DEPLOYMENT

If you are an IT manager at a large organization that is rolling out a large number of Jabra PRO solutions, then you may wish to take advantage of the administration mode of the Jabra Control Center, which is part of the Jabra PC Suite. This enables you to establish a set of standard settings and then install these on each of several Jabra PRO units. Administration mode also enables you to apply several settings that are not available via the standard user interface, including:

Password for locking the Intellitone (noise-exposure) level and other settings.

Password for locking administration mode for the Jabra Control Center.

5.6 JABRA PC SUITE DOCUMENTATION

All programs of the Jabra PC Suite include complete online help. Where appropriate, this manual refers to settings and features provided by the Jabra PC Suite, but please see the online help for complete details about all software features.

6. DAILY USE—CALLING, ANSWERING AND HANGING UP

6.1 HEADSET CONTROLS AND INDICATORS

The Multifunction Button

The table below summarizes the various gestures recognized by the multifunction button. The terms listed in the table are often used in this manual when describing how to use the headset.

Gesture name	How to make it
Tap	Tap and release instantly (not longer than 0.8 seconds).
Double tap	Two quick taps (less than half a second between them).
Press	Press and hold the button for 1 - 3 seconds.
Long press	Press and hold the button for 3 - 5 seconds.

Table 2: Gestures for using the headset multifunction button; the terms here are used throughout this manual.

The precise effect of each type of gesture depends on what you are currently doing (e.g., if you are already on a call, which phone is the current target, etc.).

See also 7.4: Headset Controls and Signals for complete details of all headset commands.

Headset Visual Indicators

The headset includes a multicolor LED, which indicates the status of the headset as outlined in the table below.

Headset state	LED when battery level is good	LED when battery level is low
Powered on and idle	Green, single flash Repeats for 60 seconds	Red, single short flash Repeats indefinitely
Pairing to base	Blue, constant	Red, constant
Ringling	Green, double flash Repeat indefinitely	Red, double short flash Repeat indefinitely
Charging	Yellow, constant	Red, constant
Fully charged and in cradle	Green, constant	N/A
Powered on, but not connected	Green, triple flash Stops after 60 seconds	Red, triple short flash Repeats indefinitely
Battery level information (shown at startup)	Shows the following LED color for 1 second: Low: Red (then continues flashing red) Medium: Orange High: Green	
Pairing succeeded	Green, 5 quick flashes	Red, 5 quick flashes
Power just turned on	Green, 4 quick flashes	Red, 4 quick flashes
Power just tuned off	Green, 4 quick flashes, then power off	Red, 4 quick flashes, then power off

Table 3: Headset visual signals and their meanings

See also 7.4: Headset Controls and Signals for complete details of all headset displays and audio signals.

6.2 THE 'TARGET PHONE' CONCEPT

Whenever your headset is connected to more than one type of phone, one of those phones is always defined as being the current target phone, which is the phone you will use the next time you open a connection (e.g., by tapping on the headset multi-function button when no calls are active).

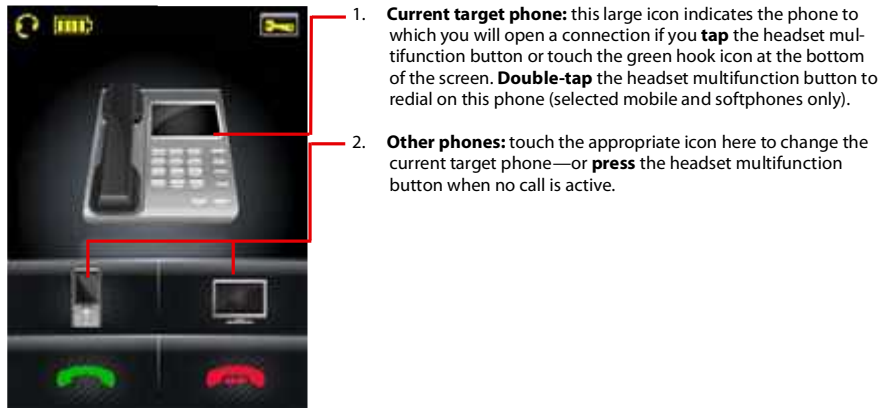

Figure 16: The current target phone is indicated by the large icon on the touchscreen; change the target by touching on one of the other icons.

Often the correct target will be selected for you automatically. However, you must select a target manually in the following situations:

- When you would like to dial out using your desk phone, then you must make sure that your desk phone is the target and open the connection before dialing.
- If the headset and touchscreen do not respond when a given phone is ringing, then ring detection is not possible with that phone. You must therefore target the ringing phone before you can answer it.
- When you would like to redial the last number you called on a supported mobile- or softphone, you must make sure that the current target is the phone you used when dialing the number originally.
- If your mobile phone supports voice-activated dialing from a Bluetooth headset, then you can activate this feature by **tapping** on the headset multifunction button (or touching the open-connection icon on the touchscreen) provided the mobile phone is the target phone.

To set the current target phone, do one of the following:

- Look at the touchscreen. The largest icon there indicates the current target. To change the target, touch the icon for the phone you wish to use. This is the easiest way to view and change the current target.
- When no call is active, **press** the headset's multifunction button for about 2 seconds and then release. Listen to the voice or melody that is played; you can configure the headset to play either an English voice or a distinct melody to identify the current target (See also 7.4: *Headset Controls and Signals*). Cycle through the settings until you have selected the right target.

Jabra PRO applies intuitive logic when choosing the current target phone. The following rules apply:

- The default target is the last one that you selected using the touchscreen or headset button. An icon on the touchscreen shows you which phone is the current target.
- You can change the target at any time using the touchscreen or multifunction button on the headset (see above).
- If the headset can detect that a phone is ringing, then that phone will be selected and answered automatically when you **tap** the multifunction button or touchscreen icon. Ring detection is supported for all mobile phones, softphones for which a Jabra driver is available and desk phones fitted with a GN1000 Handset Lifter. Most, but not all, electronic-hookswitch solutions also provide ring detection.
- You do not need to manually change the target when you dial using your mobile-phone keypad. The connection from your headset to mobile phone opens automatically when you press the connect button on your mobile phone.
- You do not need to manually change the target when you dial using the graphical interface of a supported softphone. The connection from your headset to the softphone opens automatically when you press the connect button on your softphone.

6.3 HOW TO MAKE A CALL

Calling through a Desk Phone

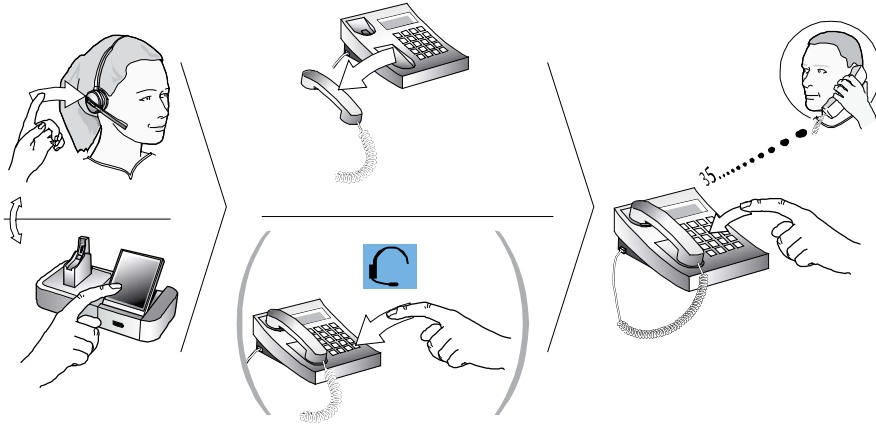

Figure 17: Placing a call with your headset and desk phone

To place a call through your desk phone:

1. If necessary, set the desk phone as the current target for your headset (see also 6.2: The 'Target Phone' Concept.)
2. Do one of the following to get a dial tone:
 - **If you are using a handset lifter or electronic hookswitch:**
Open the audio link to the headset by doing one of the following: tap the headset's multifunction button or touch the call icon on the base touchscreen. You should now hear a dial tone.
 - **If you do not have a handset lifter or electronic hookswitch:**
Open the audio link to the headset by doing one of the following: **tap** the headset's multifunction button or touch the call icon on the base touchscreen. Then lift your desk phone handset from the receiver and set it aside—or press the headset button, if your desk phone has one—to get a dial tone.
3. Dial the number using your desk phone's buttons.

Calling through a Softphone

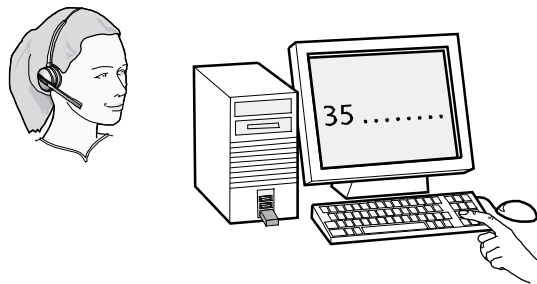

Figure 18: To make a call on your softphone, simply dial as usual while wearing the headset.

To place a call through your softphone, dial the number or choose a contact using your softphone program. The audio connection to your headset will open automatically as soon as your recipient's phone begins ringing.

Note: The above procedure assumes that you are using a softphone supported by Jabra PC Suite. If you are using an unsupported softphone, then you may need to use Jabra Control Center to open the audio link from your PC to your mobile phone before dialing. See the PC Suite online help for details. See also Chapter 5: Installing and Running the Jabra PC Suite.

Standard Mobile Phone Dialing (Jabra PRO 9470 Only)

To place a call through your mobile phone, dial the number as usual and then press the call button on the mobile. On most phones, the audio link from the mobile phone to your headset opens automatically.



Figure 19: To make a call on your mobile phone, simply dial as usual while wearing the headset.

Note: some mobile phones may work differently and/or require you to configure them to work as described above. Please see your mobile phone documentation for complete details about how to use it with a Bluetooth headset.

Voice-Activated Mobile Phone Dialing (Jabra PRO 9470 Only)

Some mobile phones support a feature called voice-activated dialing, in which the phone uses voice recognition to dial numbers from its address book. This feature requires that your mobile phone supports the hands-free Bluetooth profile. See your mobile phone's documentation for details about how to set up voice-activated dialing and whether this feature is supported over Bluetooth.

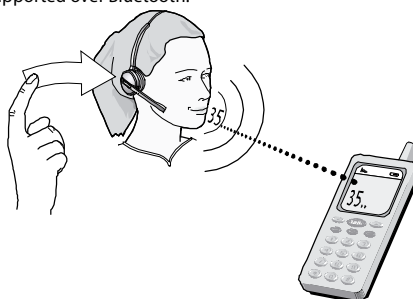

Figure 20: To use voice-activated dialing, tap the multifunction button and speak the appropriate voice tag.

To use voice-activated dialing with a mobile phone that supports it:

1. If necessary, set the mobile phone as the current target for your headset (see also 6.2: The 'Target Phone' Concept).
2. Tap the headset's multifunction button or touch the open-connection icon on the touchscreen. You will then hear the voice-dialing prompt generated by your mobile phone. Speak the trigger for the number you want and allow the phone to dial.

Tip: Your voice tags may work better if you record them using the headset rather than your phone's built-in microphone. This will make sure that the sound the phone "hears" coming from the headset when dialing will be the closest possible match to the recorded voice tag.

6.4 HOW TO ANSWER A CALL

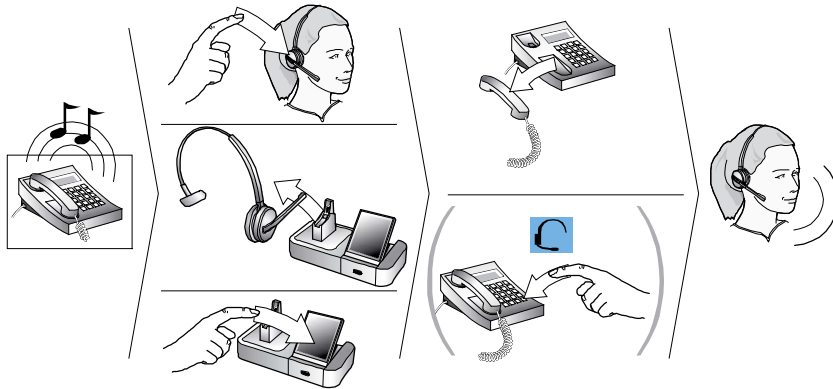

Figure 21: Answering a call

To answer a call from any connected phone:

- You will hear a ring tone from the target phone, Jabra PRO base and/or headset. Usually, the touchscreen indicates which phone is ringing and (if possible) shows the incoming phone number. The ringtone played in the headset normally also indicates which phone is ringing (see also 7.4: Headset Controls and Signals). Do one of the following:
 - For desk phones where the ring is not detected by the base or headset:**
In this situation, you will hear your desk phone ring but will not hear a ringtone in your headset or see a ring indicator on the touchscreen. Set the desk phone as the current target by touching the desk-phone icon on the touchscreen or **pressing** the headset's multifunction button until you hear the desk-phone audio indicator (see also 6.2: The 'Target Phone' Concept). This is not necessary if you have a GN1000 handset lifter or electronic hookswitch connection that supports ring detection.
 - For all other types of phones:**
The base automatically switches the target phone to the one that is ringing, as indicated by the touchscreen icon and ringtone in the headset. You do not need to change the target manually.
- Do one of the following to answer the call:
 - For desk phones where the ring is not detected by the base or headset:**
Open the audio link to the headset by doing one of the following: **tap** the headset's multifunction button or touch the answer icon on the base touchscreen. Then lift the handset from your desk phone and set it aside or press the desk-phone headset button (if present) to answer the call. (In this case, lifting the headset from its charging cradle will not open the audio link because the base cannot tell that a phone is ringing.)
 - For all other types of phones and desk phones:**
Do one of the following: **Tap** the multifunction button, touch the answer-call icon on the touchscreen or lift the headset from its cradle.

6.5 HANGING UP

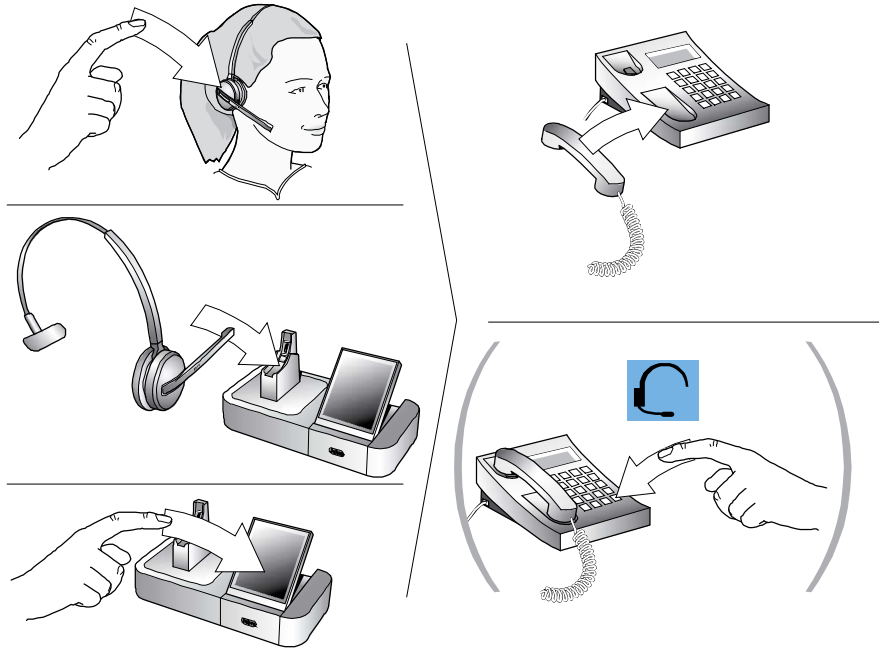

Figure 22: Hanging up

To terminate the current call when no calls are on hold, do one of the following:

- **For desk phones without a handset lifter or electronic hookswitch:**
Place the desk phone handset back onto its receiver or press the desk-phone headset button (if present) to terminate the call. Then close the audio link to the headset by doing one of the following: **tap** the headset multifunction button, touch the end-call icon on the base touchscreen, or dock the headset to the base.
- **For all other types of phones:**
Tap the headset multifunction button, touch the end-call icon on the base touchscreen, or dock the headset to the base.

6.6 CONTROLLING THE SPEAKER VOLUME AND MICROPHONE

The headset features a touch panel that is similar to the touch pad included with many laptop computers. Use it to adjust the volume you hear in your headset and to mute/enable the microphone.

Adjusting the Listening Volume

To change the volume level that you hear in the headset:

- Slide your finger down the touch panel (towards your jaw) to turn down the headset speaker volume.
- Slide your finger up the touch panel (towards your ear) to turn up the headset speaker volume.

You can also adjust the volume using the touchscreen; see [8.6: Setting Active-Call and Audio Preferences](#) for details.

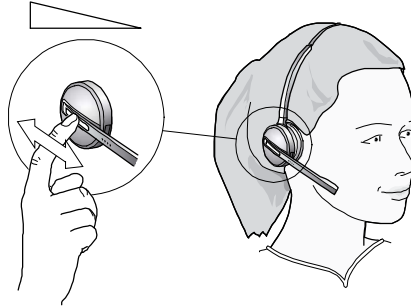

Figure 23: Use the headset's touch panel to control listening volume.

Muting Your Headset Microphone

When you mute the microphone, you will be able to hear what the other party is saying, but they will not be able to hear you. Use this for extra privacy when needed. The feature works as follows:

- To activate microphone muting, double-tap on the touch panel. You will then hear a quick medium-pitched tone followed by a short rest and a quick low-pitched tone. This signal will repeat every 20 seconds until you reactivate the microphone.
- To reactivate a currently muted microphone, repeat the above gesture (double-tap on the touch panel).
- If you hang up while the microphone is muted, it will automatically be re-enabled and ready for the next time you place or answer a call.

You can also mute/unmute the microphone using the touchscreen; see [8.6: Setting Active-Call and Audio Preferences](#) for details.

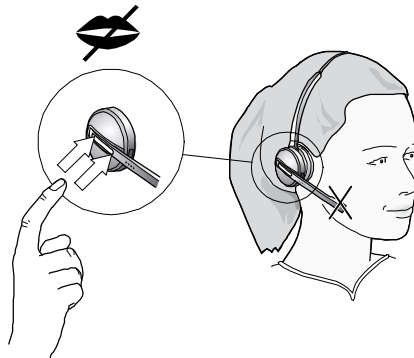

Figure 24: Use the headset's touch panel to mute or unmute the microphone.

6.7 SWITCHING BETWEEN YOUR PHONE AND HEADSET

It is possible to enable or disable the headset without interrupting your current call. You may decide to do this for added comfort during longer calls or in situations where your headset battery is running low. The procedure is intuitive but slightly different depending on which type of phone you are using, as outlined below.

To go from desk-phone handset to your headset:

1. Open the audio connection from the headset to your desk phone by tapping the headset multifunction button, lifting the headset from its cradle on the Jabra PRO base or touching the open-connection icon on the base touchscreen.
2. Listen to hear if you are now connected through the headset. With most phones, you should now be connected. With others, you may need to press the desk-phone headset button. See also your desk-phone documentation
3. Place the handset on your desk, but do not hang up, because this will terminate your call.

To go from headset to desk-phone handset:

1. Lift the handset to your ear.
2. Do one of the following:
 - If you are using a traditional phone without a headset button or electronic hookswitch, then close the audio connection to your headset by tapping the headset multifunction button, docking the headset in its cradle on the Jabra PRO base or touching the close-connection icon on the base touchscreen. (This applies also if you are using a GN1000 headset lifter.)
 - If your desk phone has a dedicated headset port and/or electronic hookswitch, then please see your desk-phone documentation for details. In some cases, you must press a button on your desk phone, while in others it will be automatic. Also, some solutions may terminate the connection if you close the audio link to the headset (e.g., by tapping its multifunction button or docking it in its charge cradle), while others may require you to do this before you can speak on the handset. Experiment to find out what works best for you.

For softphones, your headset is likely to be your only option, but if other audio devices are connected to your PC, you may be able to switch to them by changing the audio preferences for Windows and/or your softphone program.

For mobile phones (Jabra PRO 9470 only), the procedure for switching to and from the headset varies by phone model. Please see your mobile phone documentation for details.

6.8 LAST NUMBER REDIAL

Jabra PRO is able to send a redial command to the current target phone, thereby calling the same number you last dialed on that phone. It does not send the full number, just the single command. This feature therefore requires that the target phone supports the redial command, which is possible with some mobile phones and supported softphones but not on desk phones. Check your mobile and softphone documentation for details about whether last-number redial is supported via headset signals.

To use last-number redial with a mobile- or softphone that supports it:

1. If necessary, set the mobile- or softphone as the current target for your headset (see also *6.2: The 'Target Phone' Concept*.)
2. **Double-tap** the headset's multifunction button. Jabra PRO sends the redial command to the selected phone and opens the audio link.

6.9 MANAGING CALL COLLISIONS AND CALL WAITING

Call collision and call waiting both refer to situations in which you are already on the phone when another call comes in.

- **Call Collision**
Occurs when you are talking on one phone and a call comes in on a different phone that is also connected to your headset. Jabra PRO informs you that the collision occurred and shows the incoming number (if possible), but is not able to place calls on hold. You must therefore choose to answer the new call (thus terminating your current call) or to ignore the new call (possibly sending it to voicemail, depending on the details of your phone network). See *8.7: Managing Call Collision* for complete details about how to manage call collisions.
- **Call waiting**
Enables you to place a current call on hold to answer another call coming in (or on hold) on the same phone. This feature is available only for selected softphones and mobile phones. See *8.8: Managing Call Waiting* for complete details about how to manage call waiting.

6.10 LISTENING TO MUSIC

To listen to music from your PC, use the Jabra Control Center and/or its icon in the Windows notification area to open the audio link from the PC to the Jabra PRO base. Provided no other phone lines are active, your headset will then begin to play all of the sounds generated by your PC, including music from your media player. See also the Jabra PC Suite online help for details.

To listen to music from a mobile phone, use the controls provided by your phone as described in its user manual.

Note also the following:

- Music sounds best when you use wideband audio when possible. See *8.12: Narrowband vs. Wideband Audio*.
- If you are using a supported media player and softphone on your PC, then the Jabra softphone driver will automatically pause the music when a call comes in. You must manually restart the music, however.

7. THE JABRA PRO HEADSET

This chapter provides in-depth details about the Jabra PRO headset.

7.1 HEADSET DIAGRAMS

Jabra PRO models are available with several headset options, each of which is illustrated below. The following key applies to all three headset illustrations:

1. Multifunction button (answer/end call, among other functions)
2. Touch panel for volume and mute control
3. Activity and status indicator (multicolor LED)
4. Noise-cancelling port or noise-blackout microphone
5. Voice microphone
6. Boom arm (flex or midi)
7. Mount for wearing-style attachments
8. Speaker(s)

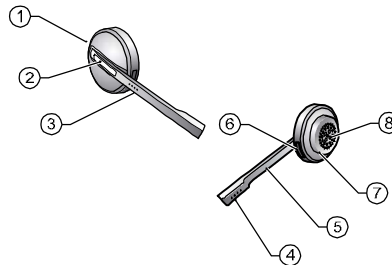

Figure 25: Jabra PRO Midi headset (included with Jabra PRO 9470 and Jabra PRO 9460) as seen from the outer and inner sides, respectively



Figure 26: Jabra PRO Flex headset (included with Jabra PRO 9450) as seen from the outer and inner sides, respectively



Figure 27: Jabra PRO 9450-Duo headset

Note: most of the other illustrations in this manual show the Jabra PRO Midi headset; all other headset models feature similar controls at similar locations, as illustrated in the figures above.

7.2 HOW TO WEAR THE HEADSET

Jabra PRO headsets are available in a variety of styles, which affect both the headset functionality and the wearing options available to you. Depending on your model, you may be able to wear your headset in any of several styles by attaching accessories to the basic unit.

Headset Style	Jabra PRO Model	Wearing Style Options
Flex	9450	Ear hook Headband Neckband
Flex Duo	9450-Duo	Dual-speaker headband
Midi	9460 9470	Ear hook Headband Neckband

Table 4: wearing styles available for each model of Jabra PRO headset

All styles can be worn on either the left or right ear (except for the flex duo, which is a headband that provides a speaker for each ear). The various available styles include:

- **Ear hook**
The ear hook is the most discreet and light-weight style. It attaches the headset directly to either ear.
- **Headband**
The headband goes over your head as with traditional headphones, but without a matching speaker on the other side. You can wear the headband with the headset on either ear.
- **Neckband**
A neckband is available as an optional accessory (please contact your Jabra representative for details). It is similar to the headband, except that it goes around the back of your neck rather than over the top of your head. It therefore will not affect your hairstyle or choice of other types of headwear (such as hats, scarves or turbans). The neckband always holds the headset on your right ear.
- **Flex Duo**
This is a special wearing style provided only with Jabra PRO 9450-Duo. It is always worn as a headset and includes two speakers—one for each ear. The same signal comes out of each speaker, so it is technically a dual-mono headset rather than a true stereo one. This option is unique because other Jabra PRO headset cannot be fitted in this way and the Duo headset cannot be modified to any of the other wearing styles listed above.

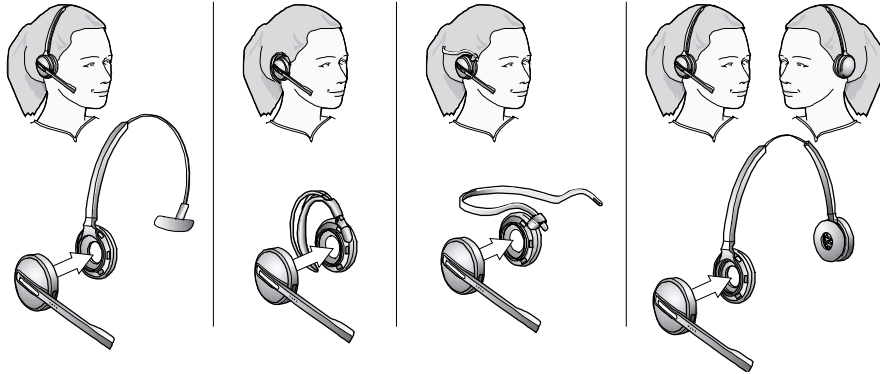

Figure 28: Wearing the Jabra PRO headset in various styles

Important: Regardless of which wearing style you choose, always be sure to adjust the headset so that the microphone is positioned as close to your mouth as possible. This will maximize the noise-cancelling effect of its microphone and make sure that your voice comes through loud and clear.

7.3 ASSEMBLING OR CHANGING THE WEARING STYLE

Note: this does not apply to Jabra PRO 9450-Duo, which is always worn as a headband.

All Jabra PRO headsets other than 9450-Duo use a modular system that enables you to adapt your headset to a variety of wearing styles. You can change your wearing style at any time.

Connecting a New Wearing Style Attachment

To connect a new wearing style attachment:

1. Select a wearing-style attachment (e.g., headband or ear hook).
2. Gently press the headset assembly onto the outer side of the attachment until it clicks into place.
3. Gently press the ear cushion assembly onto the inner side of the attachment, also until it clicks into place.
4. Rotate the boom arm for left- or right-ear use as needed. Always position the microphone so that it sits as close to the corner of your mouth as possible when you wear the headset.



Figure 29: Assembling the Jabra PRO headset into a wearing style

Removing a Wearing-Style Attachment

To remove a wearing-style attachment:

1. Hold the assembly firmly in both hands, supporting both the headset and its wearing-style attachment.
2. Place your thumb through the hole in the middle of the ear cushion of the wearing-style attachment and up against the headset speaker grill.
3. Press gently with your thumb until the headset comes free.
4. If you need the ear cushion (for example, for use on another wearing-style attachment), then gently pry it away from the inner side of the current attachment.

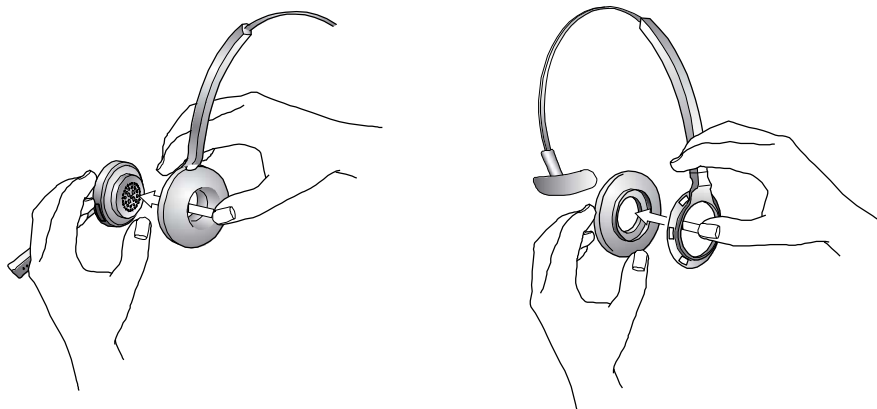

Figure 30: Removing a wearing-style attachment from the headset

7.4 HEADSET CONTROLS AND SIGNALS

All Jabra PRO headsets feature a collection of controls and indicators that enable you to manage and monitor your calls. These are:

1. Multifunction button

This button is located near the back of the headset. Through a combination of taps, double-taps, short presses and long presses, you will be able to execute all of the most-needed functions, including answering a call, hanging up, switching between held calls, and more.

2. Touch panel

This touch-sensitive panel is similar to the touch pad included with many laptop computers. It enables you to adjust the speaker volume and mute/unmute the microphone.

3. Audio signal tones

The headset generates several types of soft signal tones to let you know when you have an incoming call, muted call, call on hold, low battery, or other type of event. It also responds each time you use the multifunction button.

4. Headset visual indicator

A multicolor LED lets others see when you are on the phone and also gives feedback for certain types of events, such as low battery, power turning on/off, Bluetooth pairing, etc.

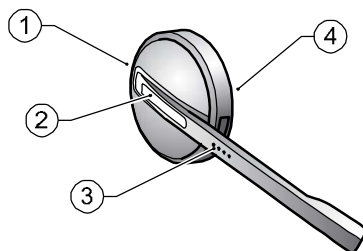

Figure 31: Jabra PRO headset

The sub s below provide full details about each of the above controls and indicators. Together, they provide an overview of all of the types of settings you can make using these controls and all of the types of feedback that you can expect from the indicators.

The Multifunction Button

The multifunction button makes it easy for you to execute all of the most commonly used functions of the headset, such as placing a call, answering a call and switching between held calls. The function executed depends on what you are currently doing and the type of gesture you use on the button (**tap, double-tap, press, etc.**).

The table below summarizes the various gestures recognized by the multifunction button and gives an example of the type of actions each will invoke. The terms listed in the table are often used in this manual when describing how to use the headset.

Gesture name	How to make it
Tap	Tap and release instantly (not longer than 0.8 seconds).
Double tap	Two quick taps (less than half a second between them).
Press	Press and hold the button for 1 - 3 seconds.
Long press	Press and hold the button for 3 - 5 seconds.

Table 5: Gestures for using the headset multifunction button; the terms here are used throughout this manual.

The precise effect of each type of gesture depends on what you are currently doing (e.g., if you are already on a call, which phone is the current target, etc.). The table below summarizes all of the control possibilities presented by the multifunction button.

Function	Tap	Double-Tap	Press (hold 1-3 sec)	Long Press (hold 3-5 sec)
Answer incoming call	✓			
Open a connection on current target phone				
(e.g., go to dial tone; voice-activated dialing)	✓			
Enable voice-activated dialing (when target is a cell phone that supports this)	✓			
End current call (and activate held or incoming call, if any)	✓			
Call the last number dialed on current target phone (supported softphones and mobile phones only)		✓		
Reject incoming call (when already on a call)		✓		
Switch target phone (when no call is active)			✓	
Power-on headset (when power is off)			✓	
Reject incoming call (when no call is active)			✓	
Hold current call and switch to held or incoming call (supported softphones and mobile phones only)			✓	
Power-off headset (when power is on)				✓

Table 6: All multifunction button commands

The Volume Strip and Microphone Mute Control

The headset features a touch-sensitive panel that is similar to the touch pad included with many laptop computers. Use it to adjust the volume you hear in your headset and to mute/enable the microphone.

- Slide your finger up the touch panel (away from your mouth) to increase the volume.
- Slide your finger down the touch panel to decrease the volume.
- Double-tap on the touch panel to mute or unmute the microphone.

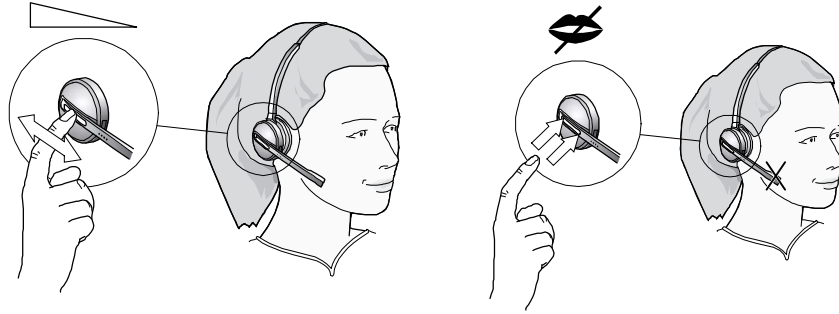

Figure 32: Use the headset's touch panel to control listening volume and microphone mute.

Headset Signal Tones

The headset uses a variety of soft tones to alert you to events such as an incoming call, multifunction button presses, volume changes, and more. These enable you to keep track of what is going on while you are wearing the headset.





















State or event	Tone description	Sample (click to play)
Power on	A slow melody ending on a high note	
Power off	A slow melody ending on a medium-low note	
Call ended	A quick melody ending on a low note	
Pairing succeeded	Three slow tones ending on a medium-high note.	
Button tap	A quick medium tone	
Button double-tap	Two button-tap tones	
Button press	The button-tap tone followed by a longer tone	
Turn volume up	A short, high tone that indicates the new volume	
Turn volume down	A short, low tone that indicates the new volume	
Maximum volume reached	Two short, high notes	
Minimum volume reached	Two short, low notes	
Target changed to desk phone	A slow, high melody or a human voice announcing "desk phone" in English	
Target changed to softphone	A slow, medium melody or a human voice announcing "softphone" in English	
Target changed to mobile phone	A slow, deep melody or a human voice announcing "mobile phone" in English	
Calls on hold via call waiting	Two slow medium-pitch notes, a long rest, and then two more; repeats occasionally	
Error (such as pairing failed)	Three quick tones followed by a lower long tone	
Incoming softphone call	A very fast, medium-pitch melody	
Incoming mobile phone call	A very fast, low-pitch melody	
Incoming desk phone call	A very fast, high-pitch melody	
Battery low	Two very quick, low tones; repeats occasionally	
Mute	A quick medium tone, rest and quick low tone; repeats occasionally	

Table 7: Headset signal tones and their meanings

Choosing Voice or Tones for Target indicators

As mentioned above in Table 7, the headset is capable of playing either a tone or a human voice when you change the target phone, thus telling you what the new target is. The human voice is always in English, regardless of your other language settings. By default, the human voice will be played. However, if you do not like hearing the English voice, you can switch to using the tones.

To change this setting, use the Jabra Control Center program of the Jabra PC Suite running on your PC. See the online help for complete details.

Headset Visual Indicators

The headset includes a multicolor LED, which indicates the status of the headset as outlined in the table below.

Headset state	LED when battery level is good	LED when battery level is low
Powered on and idle	Green, single flash	
Repeats for 60 seconds	Red, single short flash	
Repeats indefinitely		
Pairing to base	Blue, constant	Red, constant
Ringing	Green, double flash	
Repeat indefinitely	Red, double short flash	
Repeat indefinitely		
Charging	Yellow, constant	Red, constant
Fully charged and in cradle	Green, constant	N/A
Powered on, but not connected	Green, triple flash	
Stops after 60 seconds	Red, triple short flash	
Repeats indefinitely		
Battery level information		
(shown at startup)	Shows the following LED color for 1 second:	
Low: Red (then continues flashing red)		
Medium: Orange		
High: Green		
Pairing succeeded	Green, 5 quick flashes	Red, 5 quick flashes
Power just turned on	Green, 4 quick flashes	Red, 4 quick flashes
Power just turned off	Green, 4 quick flashes, then power off	Red, 4 quick flashes, then power off

Table 8: Headset visual signals and their meanings

7.5 BATTERY INDICATORS, RECHARGE AND REPLACEMENT

Battery indicators

The headset and touchscreen base indicate the current headset battery level as follows:

- When you turn on the headset, its multicolor LED shows one of the following colors for one second: green (battery level is high); orange (battery level is medium); red (battery is low and should be recharged as soon as possible).
- Whenever the battery is low, the headset multicolor LED will display red for all of its usual signals.
- While the battery is low, you will hear an audio signal (two quick, low tones) every minute or so in the headset.
- When the headset is paired with a touchscreen base, you can read the current battery level on the touchscreen.

Recharging the Headset

To recharge your headset battery, place the headset in its cradle on the base. To help make sure your headset is always ready for use, keep it in the cradle whenever you are not wearing it. See also [4.3: Assembling the Base and Headset](#).

How to replace the battery

All rechargeable batteries have a limited lifetime, losing a very small portion of their full charge capacity with each recharge. After a period of about three years, you may begin to notice that you get significantly fewer talking minutes out of your headset between charges. If the reduced charge time begins to impact your work, then you should consider replacing the battery.

To replace the headset battery:

1. Order a Jabra PRO battery-replacement kit from Jabra (contact your Jabra representative or see our web site for details). The kit includes a replacement battery and a small screwdriver.
2. Remove the wearing-style attachment from your headset (see also [7.3: Assembling or Changing the Wearing Style](#)).
3. Place the headset down on a table with the speaker facing up.
4. Use the screwdriver supplied with the battery-replacement kit to remove the three screws indicated in the figure below. Set the screws aside in a small cup or bowl to make sure you will not lose them.

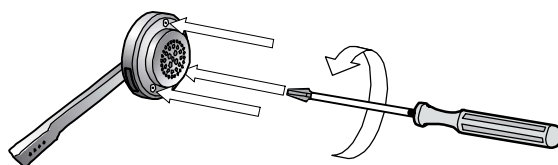

5. Carefully tilt the speaker plate up, allowing it to rotate around the edge where the boom arm sticks out. Be careful because the speaker plate remains attached to the rest of the headset by a pair of wires, as shown below.

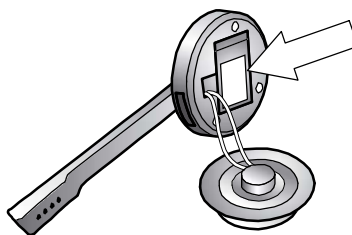

6. The battery is the rectangular component now visible in the center of the headset body. Use your fingernail or the screwdriver to gently pry the battery up and out of the headset. Be careful when removing the battery because it will remain attached to the headset by a pair of very thin wires.
7. Grab the two wires that connect the old battery to the headset and gently pull them straight away from the socket inside the headset until they are free.

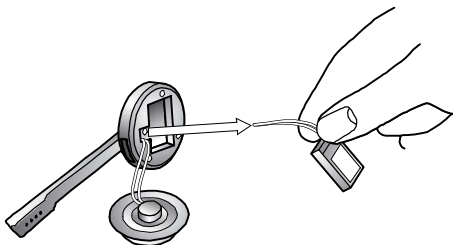

8. Take the new battery included with your Jabra PRO battery-replacement kit. It also has a pair of wires and a connector. Align the new connector with the socket inside the headset and press it all the way in (using, for example, your fingernail). If you have trouble, you might have the connector upside down—try the other way.
9. Folder the wires underneath the new battery and press the new battery down into place in the headset.
- 10 Replace the speaker plate and insert and tighten each of the three screws you removed at the start of this procedure.

7.6 STAYING WITHIN RANGE

Jabra PRO uses DECT wireless technology, which supports a maximum range of up to 150m. In practice, you will probably find the range to be somewhat shorter due to physical obstructions and electromagnetic interference.

The sound in your headset will slowly deteriorate as you move farther from the base; move back into range to restore sound quality. All sound will stop if you move all the way out of range.

If you stay out of range for longer than 60 seconds, then the headset will disconnect from the base and the current call, if any, will be terminated.

After moving out of range, the headset will try to reconnect to the base every 20 seconds for the first 100 seconds and then every 15 minutes for the next 5 hours. After that it gives up (to conserve battery power). You can manually force a reconnect attempt at any time by manually **tapping** on the multifunction button while the lost device is the target.

7.7 NOISE-BLACKOUT MICROPHONE (JABRA PRO 9460 AND 9470)

The Jabra PRO midi headset features an advanced, two-microphone noise-blackout system that will help ensure that your voice will be clear and easy to understand—even when you are sitting in a crowded office or other noisy environment. It works by using a pair of directional microphones: one facing towards your mouth and one facing away. These two signals are combined inside the headset, which subtracts the room-noise signal from the voice signal, leaving only your voice behind when it is sent to your phone.

This system works best when the headset's voice microphone is placed as close as possible to your mouth and when the out-facing microphone is completely unblocked. Avoid covering the out-facing microphone with your hand or any other substance. (Some users assume that blocking the out-facing microphone will reduce noise, but the opposite is true!)

7.8 NOISE-CANCELLING MICROPHONE (JABRA PRO 9450 AND 9450-DUO)

The Jabra PRO 9450 and 9450-Duo feature electronic noise cancelling, which will help reduce the noise transmitted by your headset, making your voice easier to hear and understand. For best results, always make sure to place the microphone as close to your mouth as possible.

8. THE JABRA PRO TOUCHSCREEN BASE

This chapter describes how to work with the features of the Jabra PRO Touchscreen Base.

8.1 BASE DIAGRAM

1. Headset cradle
2. Recharge contact
3. Touchscreen
4. Desk-phone termination switch (not included on the Jabra PRO 9470 base, where this is software controlled)
5. Cover for desk-phone control (not included on the Jabra PRO 9470 base)
6. Telephone port
7. Handset port
8. AUX port
9. USB port
10. Power adapter port
11. Remote online-indicator port
12. Security slot
13. Speaker for ring tones and touchscreen audio feedback

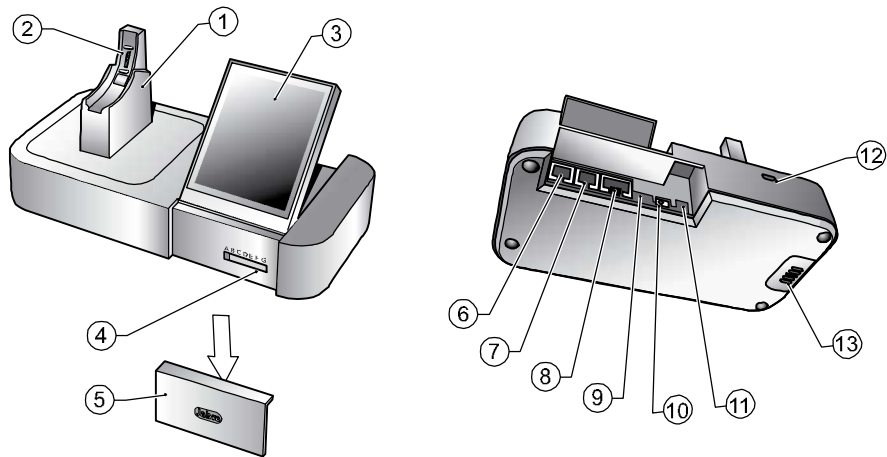

Figure 33: Jabra PRO Touchscreen Base, seen from the front and back, respectively

6 Telephone port



7 Handset port



8 AUX port



9 USB port



10 Power adapter port



11 Remote online-indicator port



8.2 BASE CONNECTIONS AND SETUP

For details about how to set up the base and connect it to your various phones, please see *Chapter 4: System Setup and Connections*.

8.3 USING THE TOUCHSCREEN

Jabra PRO Touchscreen Base features a color touchscreen that enables you to configure the solution, set preferences and manage everyday calls. Its display changes to adapt to the task at hand. To issue commands, simply touch the screen with your finger to activate icons, scroll down a page, select a target device and execute other tasks. The touchscreen is the key to working effectively with the double- and triple-convergence possibilities of these Jabra PRO models.

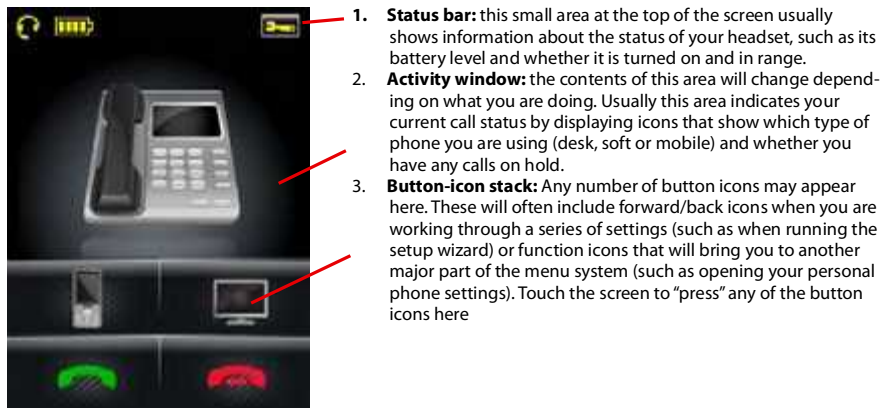

Figure 34: Touchscreen elements

The entire area of the touchscreen is fully dynamic, both in terms of what it shows and where you can touch, adapting itself to the current task. The conventions outlined above may therefore be modified in some situations. For example, when you are selecting a language, the button-icon stack takes up the entire screen and a scroll bar is shown.

8.4 STANDARD OPERATION

During normal operation, the touchscreen shows status information about your headset, displays the current target phone and indicates its status. From here you can answer an incoming call, end the current call, access your base settings, choose a target phone and open an audio link to the current target phone.

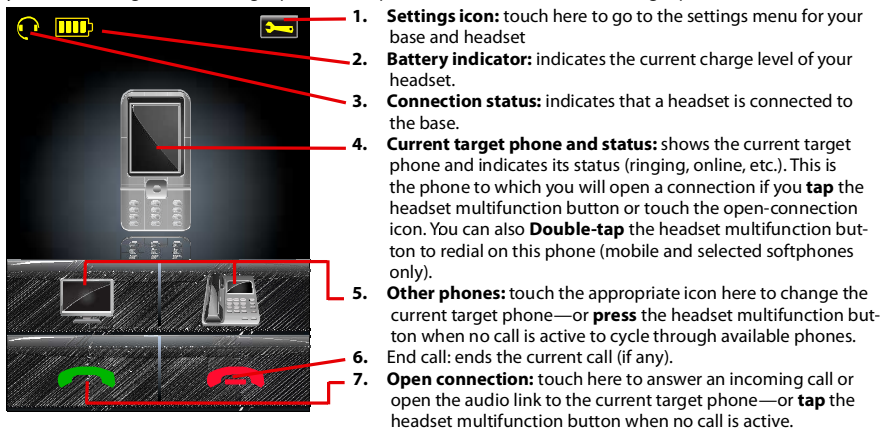

Figure 35: Touchscreen controls for standard, everyday operation

8.5 PAIRING AND CONNECTING THE BASE AND HEADSET

To enable secure wireless communication between the Jabra PRO headset and its base, you must pair the two units. Once paired, they will find, connect and communicate with each other as needed whenever they are in range and turned on, but they will ignore all other DECT devices in the area. This system helps ensure that others will not be able to overhear or otherwise interfere with your conversations.

Pairing the DECT Base and Headset

The headset can only be paired with one base at a time, while the base is able to pair with one primary headset and an optional and temporary secondary headset. The secondary pairing enables you to share your conversation with another headset user to support conference calling (see [8.13: Conference Calling](#)). You cannot pair the Jabra PRO base or headset with other types of DECT products.

To pair your base and headset:

1. Dock the headset to the charging cradle of the target base.
2. If the headset is not already paired with that base, then the touchscreen will ask you if you would like to do one of the following:
 - **Pair as primary:** touch this icon to make the current headset the new primary device for the current base. This will remove any previous primary headset.
 - **Pair as secondary:** touch this icon to make a temporary connection to the current headset. This connection will only last until the end of the next (or current) call. The current primary headset will be kept and all audio will be shared with both headsets.
 - **Do not pair:** touch this icon to charge the current headset without pairing with it.
3. Touch the icon of your choice and you are done.

Note: A similar pairing mechanism is also used by Bluetooth devices. Jabra PRO 9470 supports Bluetooth for the purpose of adding a mobile phone to your headset solution. However, the Bluetooth pairing is completely independent of the DECT pairing mechanism described above. See [9.2: Pairing and Connecting the Base with Other Bluetooth Devices](#) for details.

Managing the DECT Connection

Once you have paired the base and headset, the base manages the connection automatically even as you take the headset out of range and/or turn off the devices from time to time. The connection will usually activate itself again automatically the next time the Jabra PRO Base and headset are turned on and in range. Operation is automatic, logical and intuitive so you will not normally need to think about it. However Jabra PRO does provide controls for managing the connection manually if necessary, as described below.

If you would like to drop the connection from the base to your headset, do one of the following:

- Use the base touchscreen menus as described in [8.9: Setting General User Preferences](#).
- Use the Jabra Control Center application of the Jabra PC Suite (see the PC Suite online help for details).

When you use the touchscreen menu or Jabra PC Suite to disconnect the base and headset, as described above, then these two devices will not attempt to reconnect with each other, even if they remain turned on and in range. Usually, this is what you want when you manually disconnect them in this way. It can also sometimes occur that the two devices become disconnected for some other reason and have stopped trying to reconnect. To reconnect them, do one of the following:

- Place the headset into its recharge cradle on the base.
- Use the base touchscreen menus. See [8.9: Setting General User Preferences for instructions](#).
- Use the Jabra Control Center application of the Jabra PC Suite (see the PC Suite online help for details).

8.6 SETTING ACTIVE-CALL AND AUDIO PREFERENCES

When you are on a call you can access your call options and audio preferences by touching on the  icon in the upper right-hand corner, as shown in Figure 36. This opens the **Call Options** menu.



Figure 36: Finding your active call and audio preferences

To view and make the settings available here, touch one of the following icons from the **Call Options** menu:

- **Speaker volume:** enables you to adjust the level of the sound you hear. You can also do this using the touch-panel on the side of your headset.
- **Tone setting:** enables you to adjust the level of bass and treble in the sound you hear. Use this setting to help make people easier to understand and/or to make music sound better.
- **Mute:** enables you to mute/unmute the microphone on your headset. You can also do this by double-tapping on the touch-panel on the side of your headset.
- **Recording:** enables you to manage the recording of your conversation to a file on your PC. See also Chapter 10: Recording Your Calls for complete details about this feature.

8.7 MANAGING CALL COLLISION

When you have more than one phone connected to your base, it becomes possible that more than one call will become active simultaneously. This might occur under the following circumstances:

- You are talking on one phone (e.g., your desk phone) when a call comes in on one of your other phones (e.g., your mobile phone).
- You press the connect button on your mobile-phone keypad or softphone graphic interface (thereby opening a connection) while you are talking on one of your other phones.

Events such as these are called call collision, because here we have two or more different phones competing for access to your single headset. When a collision occurs, you can choose to answer the incoming call or reject it (possibly sending it to voicemail, if available), but you are not able to place either call on hold.

In the event of a call collision, the touchscreen will display the incoming number (if possible), show which other phone is ringing and provide controls for handling the call, as shown in Figure 37. You can also use your headset multifunction button to manage the call, also as noted in Figure 37.