



RADIO TEST REPORT

Test Report No. : 10191682A-H

Applicant : CASIO COMPUTER CO., LTD.
Type of Equipment : Electronic Cash Register
Model No. : V-R7100-C
FCC ID : BBQVR7100
Test regulation : FCC Part 15 Subpart E: 2013
(DFS test only)
Test Result : Complied

1. This test report shall not be reproduced in full or partial, without the written approval of UL Japan, Inc.
2. The results in this report apply only to the sample tested.
3. This sample tested is in compliance with above regulation.
4. The test results in this report are traceable to the national or international standards.
5. This test report must not be used by the customer to claim product certification, approval, or endorsement by NVLAP, NIST, or any agency of the Federal Government.

Date of test: February 19, 2014

Representative test engineer: 
Katsunori Okai
Engineer of WiSE Japan,
UL Verification Service

Approved by: 
Takahiro Hatakeda
Leader of WiSE Japan,
UL Verification Service



NVLAP LAB CODE: 200572-0

This laboratory is accredited by the NVLAP LAB CODE 200572-0, U.S.A. The tests reported herein have been performed in accordance with its terms of accreditation. *As for the range of Accreditation in NVLAP, you may refer to the WEB address, <http://www.ul.com/japan/jpn/pages/services/emc/about/mark1/index.jsp#nvlap>

UL Japan, Inc.

Head Office EMC Lab.

4383-326 Asama-cho, Ise-shi, Mie-ken 516-0021 JAPAN

Telephone : +81 596 24 8999

Facsimile : +81 596 24 8124

13-EM-F0429

REVISION HISTORY

Original Test Report No.: 10191682A-H

Revision	Test report No.	Date	Page revised	Contents
- (Original)	10191682A-H	February 27, 2014	-	-

<u>CONTENTS</u>	<u>PAGE</u>
SECTION 1: Customer information	4
SECTION 2: Equipment under test (E.U.T.)	4
SECTION 3: Scope of Report	6
SECTION 4: Test specification, procedures & results	6
SECTION 5: Operation of E.U.T. during testing.....	11
SECTION 6: Channel Move Time, Channel Closing Transmission Time	17
SECTION 7: Non-Occupancy Period.....	19
APPENDIX 1: Test instruments	21
APPENDIX 2: Photographs of test setup.....	22

SECTION 1: Customer information

Company Name : CASIO COMPUTER CO., LTD.
Address : 2-1, Sakaecho 3-chome, Hamura-shi, Tokyo 205-8555 Japan

SECTION 2: Equipment under test (E.U.T.)

2.1 Identification of E.U.T.

Type of Equipment : Electronic Cash Register
Model No. : V-R7100-C
Serial No. : Refer to Section 4, Clause 4.2
Rating : AC 120V (AC Adapter output: DC24V)
Receipt Date of Sample : December 24, 2013
Country of Mass-production : Indonesia
Condition of EUT : Production prototype
(Not for Sale: This sample is equivalent to mass-produced items.)
Modification of EUT : No Modification by the test lab

UL Japan, Inc.

Head Office EMC Lab.

4383-326 Asama-cho, Ise-shi, Mie-ken 516-0021 JAPAN

Telephone : +81 596 24 8999

Facsimile : +81 596 24 8124

2.2 Product Description

Radio Specification

[Bluetooth (Ver. 2.0)]

Equipment Type	Transceiver
Frequency of Operation	2402-2480MHz
Type of Modulation	FHSS: GFSK, $\pi/4$ DQPSK, 8DPSK
Antenna Type	FPC Antenna
Antenna connector type	Internal Antenna
Antenna Gain	4.09dBi (2.4GHz Main)
Power Supply (radio part input)	DC3.7V

[WLAN (IEEE802.11a/b/g/n-20)]

Equipment Type	Transceiver	
Frequency of Operation	2412-2462MHz	5180-5320MHz 5500-5700MHz * 5745-5825MHz
Type of Modulation	DSSS, OFDM	OFDM
Antenna Type	FPC Antenna	
Antenna connector type	Internal Antenna	
Antenna Gain	4.09dBi (2.4GHz Main)	4.25 dBi (W52/53 Aux), 4.18 dBi (W56 Aux), 4.62 dBi (W58 Aux)

*5600MHz-5640MHz is not used in Canada.

[WLAN (IEEE802.11n-40)]

Equipment Type	Transceiver	
Frequency of Operation	2422-2452MHz	5190-5310MHz 5510-5670MHz * 5755-5795MHz
Type of Modulation	OFDM	OFDM
Antenna Type	FPC Antenna	
Antenna connector type	Internal Antenna	
Antenna Gain	4.09dBi (2.4GHz Main)	4.25 dBi (W52/53 Aux), 4.18 dBi (W56 Aux), 4.62 dBi (W58 Aux)

*5590MHz-5630MHz is not used in Canada.

Model difference

Model	WLAN Bluetooth	iButton	Power cord (enclosed)
V-R7100-C*	X	-	X
V-R7100-AUS	X	-	-

*Tested model

UL Japan, Inc.

Head Office EMC Lab.

4383-326 Asama-cho, Ise-shi, Mie-ken 516-0021 JAPAN

Telephone : +81 596 24 8999

Facsimile : +81 596 24 8124

SECTION 3: Scope of Report

This report only covers DFS requirement, as specified by the following referenced procedures.

SECTION 4: Test specification, procedures & results

4.1 Test Specification

Test Specification	:	FCC Part 15 Subpart E: 2013, final revised on June 11, 2013 and effective July 11, 2013
Title	:	FCC 47CFR Part15 Radio Frequency Device Subpart E Unlicensed National Information Infrastructure Devices Section 15.407 General technical requirements
Test Specification	:	FCC 06-96 APPENDIX
Title	:	COMPLIANCE MEASUREMENT PROCEDURES FOR UNLICENSED- NATIONAL INFORMATION INFRASTRUCTURE DEVICES OPERATING IN THE 5250-5350 MHz AND 5470-5725MHz BANDS INCORPORATING DYNAMIC FREQUENCY SELECTION

FCC 15.31 (e)

This EUT provides stable voltage (DC3.7V) constantly to RF Part regardless of input voltage. Therefore, this EUT complies with the requirement.

FCC Part 15.203 Antenna requirement

It is impossible for end users to replace the antenna, because the antenna is mounted inside of the EUT. Therefore, the equipment complies with the antenna requirement of Section 15.203.

UL Japan, Inc.

Head Office EMC Lab.

4383-326 Asama-cho, Ise-shi, Mie-ken 516-0021 JAPAN

Telephone : +81 596 24 8999

Facsimile : +81 596 24 8124

4.2 Procedures and results

Table 1 Applicability of DFS Requirements

Requirement	Operating Mode	Test Procedures & Limits	Deviation	Results
	Client without Radar Detection			
U-NII Detection Bandwidth	Not required	FCC 06-96 Appendix 7.8.1	N/A	N/A
Channel Availability Check Time	Not required	FCC15.407 (h)	N/A	N/A
		FCC 06-96 Appendix 7.8.2.1		
		Appendix 7.8.2.2		
		Appendix 7.8.2.3		
RSS-210 A9.3				
Channel Move Time, Channel Closing Transmission Time	Yes	FCC15.407 (h)	N/A	Complied
		FCC 06-96 Appendix 7.8.3		
		RSS-210 A9.3		
Non-Occupancy period	Yes	FCC15.407 (h)	N/A	Complied
		FCC 06-96 Appendix 7.8.3		
		RSS-210 A9.3		
In-Service Monitoring	Not required	FCC15.407 (h)	N/A	N/A
		FCC 06-96 Appendix 7.8.4		
Overlapping Channel Tests	Not required	FCC15.407 (h)	N/A	N/A

Table 2 DFS Detection Thresholds for Master Devices and Client Devices With Radar

Maximum Transmit Power	Value (See Notes 1 and 2)
≥ 200 milliwatt	-64 dBm
< 200 milliwatt	-62 dBm
<p>Note 1: This is the level at the input of the receiver assuming a 0 dBi receive antenna.</p> <p>Note 2: Throughout these test procedures an additional 1 dB has been added to the amplitude of the test transmission waveforms to account for variations in measurement equipment. This will ensure that the test signal is at or above the detection threshold level to trigger a DFS response.</p>	

UL Japan, Inc.

Head Office EMC Lab.

4383-326 Asama-cho, Ise-shi, Mie-ken 516-0021 JAPAN

Telephone : +81 596 24 8999

Facsimile : +81 596 24 8124

Table 3 DFS Response Requirement Values

Parameter	Value
Non-occupancy period	Minimum 30 minutes
Channel Availability Check Time	60 seconds
Channel Move Time	10 seconds See Note 1
Channel Closing Transmission Time	200 milliseconds + an aggregate of 60 milliseconds over remaining 10 second period. See Notes 1 and 2
U-NII Detection Bandwidth	Minimum 80% of the U-NII 99% transmission power bandwidth See Note 3
<p>Note 1: The instant that the Channel Move Time and the Channel Closing Transmission Time begins is as follows:</p> <ul style="list-style-type: none"> • For the Short Pulse Radar Test Signals this instant is the end of the <i>Burst</i>. • For the Frequency Hopping radar Test Signal, this instant is the end of the last radar <i>Burst</i> generated • For the Long Pulse Radar Test Signal this instant is the end of the 12 second period defining the <i>Radar Waveform</i>. <p>Note 2: The Channel Closing Transmission Time is comprised of 200 milliseconds starting at the beginning of the Channel Move Time plus any additional intermittent control signals required to facilitate a Channel move (an aggregate of 60 milliseconds) during the remainder of the 10 second period. The aggregate duration of control signal will not count quiet periods in between transmissions.</p> <p>Note 3: During the U-NII Detection Bandwidth detection test, radar type 1 is used and for each frequency step the minimum percentage of detection is 90 percent. Measurements are performed with no data traffic.</p>	

UL Japan, Inc.

Head Office EMC Lab.

4383-326 Asama-cho, Ise-shi, Mie-ken 516-0021 JAPAN

Telephone : +81 596 24 8999

Facsimile : +81 596 24 8124

Table 4 Short Pulse Radar Test Waveform

Radar Type	Pulse Width (μsec)	PRI (μsec)	Number of Pulses	Minimum Percentage of Successful Detection	Minimum Number of Trials
1	1	1428	18	60%	30
2	1-5	150-230	23-29	60%	30
3	6-10	200-500	16-18	60%	30
4	11-20	200-500	12-16	60%	30
Aggregate (Rader Types 1-4)				80%	120

Table 5 Long Pulse Radar Test Waveform

Radar Type	Pulse Width (μsec)	Chip Width (MHz)	PRI (μsec)	Number of Pulses per Burst	Number of Burst	Minimum Percentage of Successful Detection	Minimum Number of Trials
5	50-100	5-20	1000-2000	1-3	8-20	80%	30

Table 6 Frequency Hopping Radar Test Waveform

Radar Type	Pulse Width (μsec)	PRI (μsec)	Pulse per Hop (kHz)	Hopping Rate (kHz)	Hopping Sequence Length (msec)	Minimum Percentage of Successful Detection	Minimum Number of Trials
6	1	333	9	0.333	300	70%	30

4.3 Test Location

UL Japan, Inc. Head Office EMC Lab. *NVLAP Lab. code: 200572-0
4383-326 Asama-cho, Ise-shi, Mie-ken 516-0021 JAPAN
Telephone : +81 596 24 8999 Facsimile : +81 596 24 8124

	FCC Registration Number	IC Registration Number	Width x Depth x Height (m)	Size of reference ground plane (m) / horizontal conducting plane	Other rooms
No.1 semi-anechoic chamber	313583	2973C-1	19.2 x 11.2 x 7.7m	7.0 x 6.0m	No.1 Power source room
No.2 semi-anechoic chamber	655103	2973C-2	7.5 x 5.8 x 5.2m	4.0 x 4.0m	-
No.3 semi-anechoic chamber	148738	2973C-3	12.0 x 8.5 x 5.9m	6.8 x 5.75m	No.3 Preparation room
No.3 shielded room	-	-	4.0 x 6.0 x 2.7m	N/A	-
No.4 semi-anechoic chamber	134570	2973C-4	12.0 x 8.5 x 5.9m	6.8 x 5.75m	No.4 Preparation room
No.4 shielded room	-	-	4.0 x 6.0 x 2.7m	N/A	-
No.5 semi-anechoic chamber	-	-	6.0 x 6.0 x 3.9m	6.0 x 6.0m	-
No.6 shielded room	-	-	4.0 x 4.5 x 2.7m	4.0 x 4.5 m	-
No.6 measurement room	-	-	4.75 x 5.4 x 3.0m	4.75 x 4.15 m	-
No.7 shielded room	-	-	4.7 x 7.5 x 2.7m	4.7 x 7.5m	-
No.8 measurement room	-	-	3.1 x 5.0 x 2.7m	N/A	-
No.9 measurement room	-	-	8.8 x 4.6 x 2.8m	2.4 x 2.4m	-
No.11 measurement room	-	-	6.2 x 4.7 x 3.0m	2.4 x 3.4m	-

* Size of vertical conducting plane (for Conducted Emission test) : 2.0 x 2.0m for No.1, No.2, No.3, and No.4 semi-anechoic chambers and No.3 and No.4 shielded rooms.

4.4 Uncertainty

The following uncertainties have been calculated to provide a confidence level of 95% using a coverage factor k=2.
Time Measurement uncertainty for this test was: (±) 0.012%

4.5 Data of DFS test, Test instruments of DFS, Test set up

Refer to APPENDIX.

SECTION 5: Operation of E.U.T. during testing

5.1 Operating Modes

The EUT, which is a Client Device without Radar detection capability, operates over the 5250-5350MHz and 5470-5725MHz.

Power level(EIRP) of the EUT[dBm]

5250-5350MHz Band*		5470-5725MHz Band*	
Output Power (Min)	Output Power(Max)	Output Power (Min)	Output Power(Max)
7.04	20.51	8.00	20.02

*Refer to 10191682A-G, FCC Part 15E (FCC 15.407) report for other parts than DFS.

WLAN traffic is generated by streaming the MPEG Test file “6 ½ Magic Hours” from the Master to the Client in full motion video mode.

The EUT utilizes the 802.11a architecture, with a nominal channel bandwidth.

The FCC ID for the Master Device used with EUT for DFS testing is LDK102073.

The rated output power of the Master unit is >200mW(23dBm). Therefore the required interference threshold level is -64 dBm. After correction for antenna gain and procedural adjustments, the required conducted threshold at the antenna port is $-64 + 1 + 3.5 = -59.5$ dBm (threshold level + additional 1dB + antenna gain).

It is impossible for users to change DFS control, because the DFS function is written on the firmware and users cannot access it.

The EUT was set by the software as follows:

Software name & version:

MxPLAYER version1.7.21

CODEC(For MxPLAYER ARMv7) Version1.7.24

Esfileexplorer version3.0.8.0

UL Japan, Inc.

Head Office EMC Lab.

4383-326 Asama-cho, Ise-shi, Mie-ken 516-0021 JAPAN

Telephone : +81 596 24 8999

Facsimile : +81 596 24 8124

5.2 Configuration and peripherals

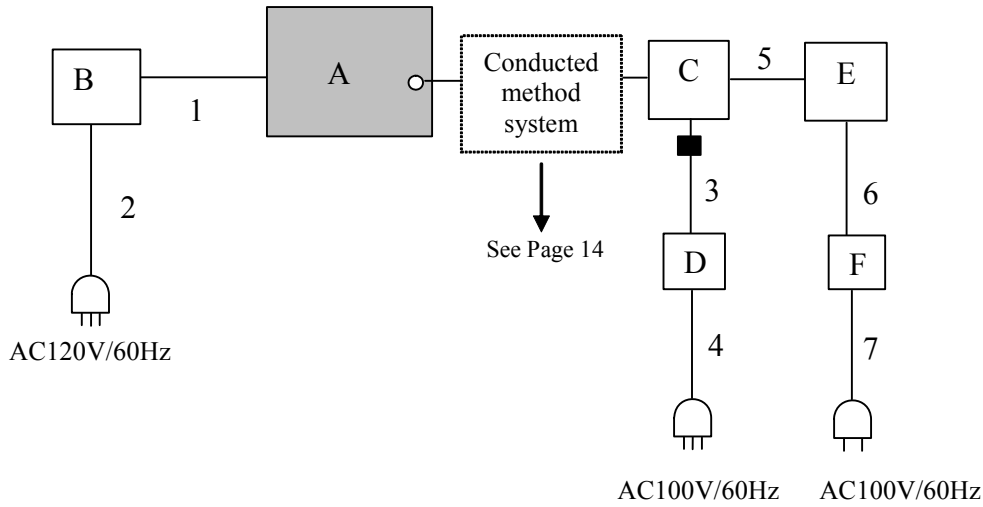

■ : Standard Ferrite Core

Description of EUT and Support equipment

No.	Item	Model number	Serial number	Manufacturer	Remarks
A	Electronic Cash Register	V-R7100-C	CS-43	CASIO COMPUTER CO., LTD.	EUT
B	AC Adaptor	EKF2400250X1B A	-	Mass Power Electronic Limited	-
C	Wireless LAN access point	AIR-AP1262N-A-K9	FTX1620K39Q	Cisco Systems	-
D	AC Adaptor	AA25480L	ALD0520G7R6	Cisco Systems	-
E	Laptop PC	FMV-S8370	R8Z03059	FUJITSU	-
F	AC Adaptor	FMV-AC325	08Z15123A	FUJITSU	-

List of cables used

No.	Name	Length (m)	Shield	
			Cable	Connector
1	DC Cable	1.8	Unshielded	Unshielded
2	AC Cable	2.0	Unshielded	Unshielded
3	DC Cable	1.8	Unshielded	Unshielded
4	AC Cable	2.3	Unshielded	Unshielded
5	LAN Cable	3.0	Unshielded	Unshielded
6	DC Cable	1.9	Unshielded	Unshielded
7	AC Cable	1.8	Unshielded	Unshielded

UL Japan, Inc.

Head Office EMC Lab.

4383-326 Asama-cho, Ise-shi, Mie-ken 516-0021 JAPAN

Telephone : +81 596 24 8999

Facsimile : +81 596 24 8124

5.3 Test and Measurement System

SYSTEM OVERVIEW

The measurement system is based on a conducted test method.

The software selects waveform parameters from within the bounds of the signal type on a random basis using uniform distribution. The short pulse types 2, 3, and 4, the long pulse type 5, and the frequency hopping type 6 parameters are randomized at run-time.

The signal monitoring equipment consists of a spectrum analyzer with the capacity to display 8001 bins on the horizontal axis. A time-domain resolution of 2 msec/bin is achievable with a 16 second sweep time, meeting the 10 seconds short pulse reporting criteria. The aggregate ON time is calculated by multiplying the number of bins above a threshold during a particular observation period by the dwell time per bin, with the analyzer set to peak detection. A time-domain resolution of 3 msec/bin is achievable with a 24 second sweep time, meeting the 22 second long pulse reporting criteria and allowing a minimum of 10 seconds after the end of the long pulse waveform.

FREQUENCY HOPPING RADAR WAVEFORM GENERATING SUBSYSTEM

The first 100 frequencies are selected out of the hopping sequence of the randomized 475 hop frequencies.

Only a *Burst* that has the frequency falling within the receiver bandwidth of the tested U-NII device is selected among those frequencies. (Frequency-domain simulation). The radar waveform generated at the start time of the selected *Burst* (Time-domain simulation) is download to the Signal Generator.

If all of the randomly selected 100 frequencies do not fall within the receiver bandwidth of the U-NII device, the radar waveform is not used for the test.

UL Japan, Inc.

Head Office EMC Lab.

4383-326 Asama-cho, Ise-shi, Mie-ken 516-0021 JAPAN

Telephone : +81 596 24 8999

Facsimile : +81 596 24 8124

CONDUCTED METHODS SYSTEM BLOCK DIAGRAM

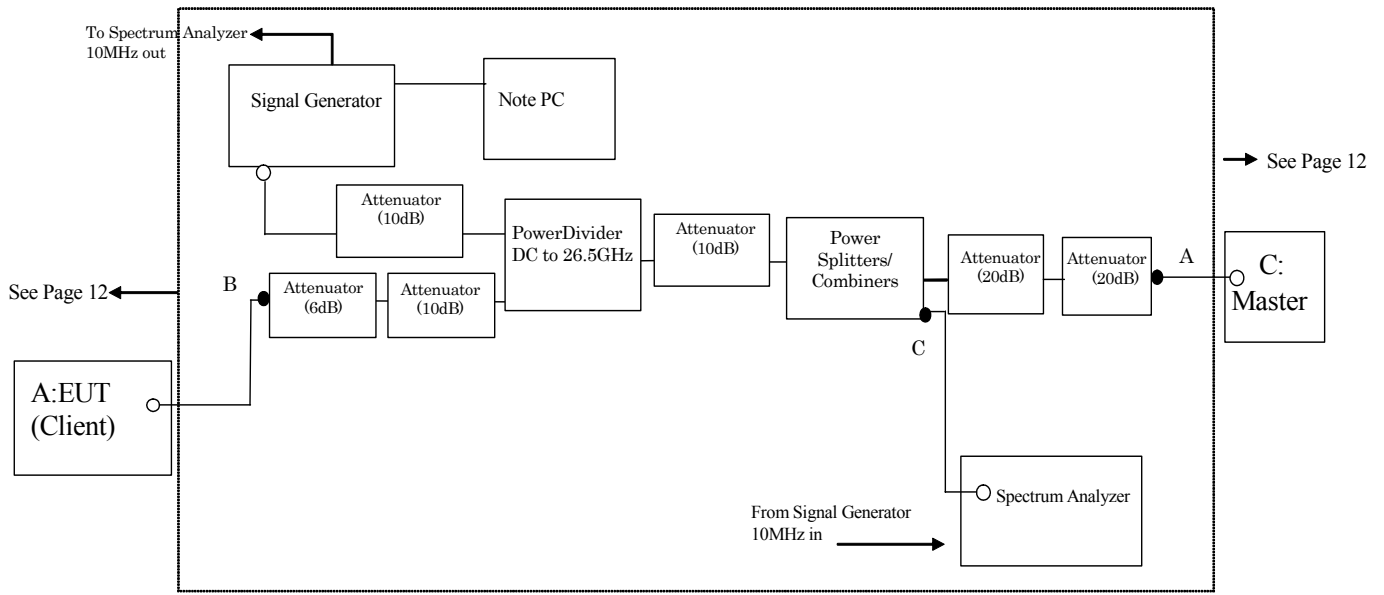

MEASUREMENT SYSTEM FREQUENCY REFERENCE

Lock the signal generator and the spectrum analyzer to the same reference sources as follows: Connect the 10MHz OUT on the signal generator to the 10MHz IN on the spectrum analyzer and set the spectrum analyzer 10MHz In to On.

SYSTEM CALIBRATION

Step 1: Set the system as shown in Figure 3 of FCC 06-96 7.2.1.

Step 2: Adjust each attenuator to fulfill the following three conditions:

- WLAN can be communicated, and
- Rader detection threshold level is bigger than Client Device traffic level on the spectrum analyzer, and
- Master Device traffic level is not displayed on the spectrum analyzer.

Step 3: Terminate 50 ohm at B and C points, and connect the spectrum analyzer to the point A. (See the figure on page 14)

At the point A, adjust the signal generator and spectrum analyzer to the center frequency of the channel to be measured.

Download the applicable radar waveforms to the signal generator. Select the radar waveform, trigger a burst manually and measure the amplitude on the spectrum analyzer. Readjust the amplitude of the signal generator as required so that the peak level of the waveform is at a displayed level equal to the required or desired interference detection threshold.

Separate signal generator amplitude settings are determined as required for each radar type.

Step 4: Without changing any of the instrument settings, restore the system setting to Step 2 and adjust the Reference Level Offset of the spectrum analyzer to the level at Step 3.

By taking the above steps 1 to 4, the spectrum analyzer displays the level of the signal generator as received at the antenna ports of the Master Device.

See Clause 5.4 for Plots of Noise, Rader Waveforms, and WLAN signals.

5.4 Plots of Noise, Rader Waveforms, and WLAN signals

Plots of System Noise Floor

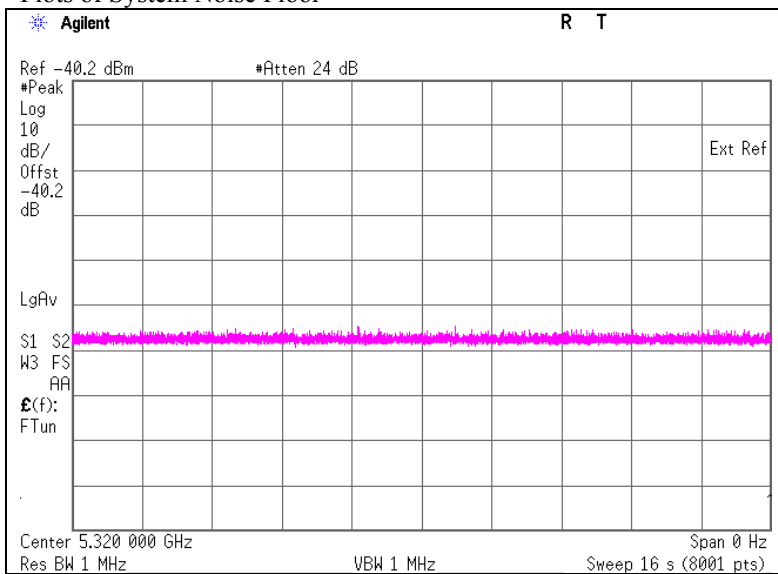

UL Japan, Inc.

Head Office EMC Lab.

4383-326 Asama-cho, Ise-shi, Mie-ken 516-0021 JAPAN

Telephone : +81 596 24 8999

Facsimile : +81 596 24 8124

Plots of Radar Waveforms

Rader Type 1

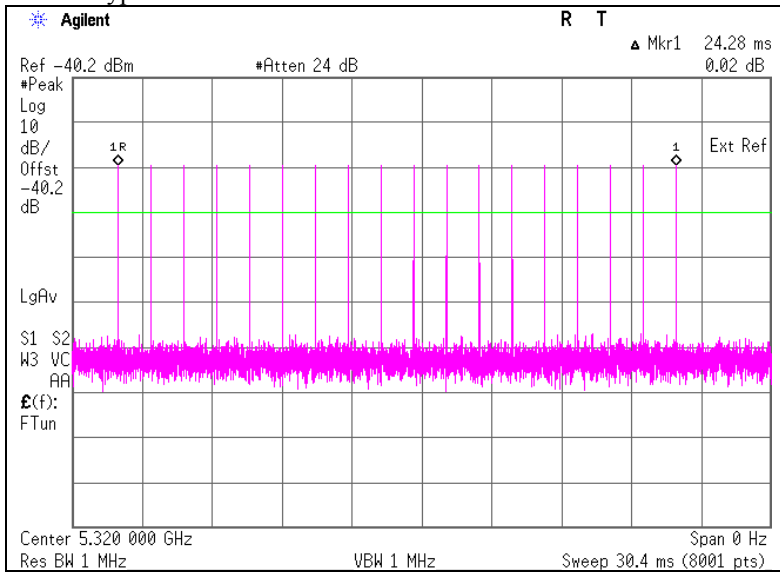

Plots of WLAN Traffic

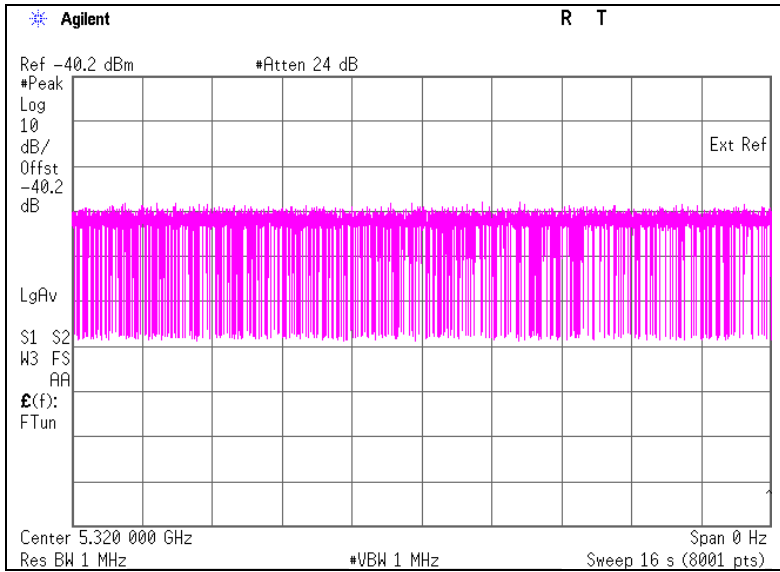

UL Japan, Inc.

Head Office EMC Lab.

4383-326 Asama-cho, Ise-shi, Mie-ken 516-0021 JAPAN

Telephone : +81 596 24 8999

Facsimile : +81 596 24 8124

SECTION 6: Channel Move Time, Channel Closing Transmission Time

6.1 Operating environment

Test place : No.6 measurement room
Temperature : 23 deg. C
Humidity : 45 % RH

6.2 Test Procedure

Stream the MPEG test file from the Master Device to the Client Device on the test Channel for the entire period of the test.

The Radar Waveform generator sends a Burst of pulses for one of the Short Pulse Radar Types 1-4 at levels defined , on the Operating Channel. An additional 1 dB is added to the radar test signal to ensure it is at or above the DFS Detection Threshold, accounting for equipment variations/errors.

Observe the transmissions of the EUT at the end of the radar Burst on the Operating Channel for duration greater than 10 seconds.

6.3 Test data

Test Item	Unit	Measurement Time	Limit	Results
Channel Move Time *1)	[sec]	6.814	10.000	Pass
Channel Closing Transmission Time *2)	[msec]	20	60	Pass

*1) Channel Move Time is calculated as follows:

$$(\text{Channel Move Time}) = (\text{End of Transmission}) - (\text{End of Burst}) = 8.192 - 1.378$$

*2) Channel Closing Transmission Time is calculated from (End of Burst + 200msec) to (End of Burst + 10sec)

$$\begin{aligned} (\text{Channel Closing Transmission Time}) &= (\text{Number of analyzer bins showing transmission}) * (\text{dwell time per bin}) \\ &= 10 * 2(\text{msec}) \end{aligned}$$

UL Japan, Inc.

Head Office EMC Lab.

4383-326 Asama-cho, Ise-shi, Mie-ken 516-0021 JAPAN

Telephone : +81 596 24 8999

Facsimile : +81 596 24 8124

Radar Type 1

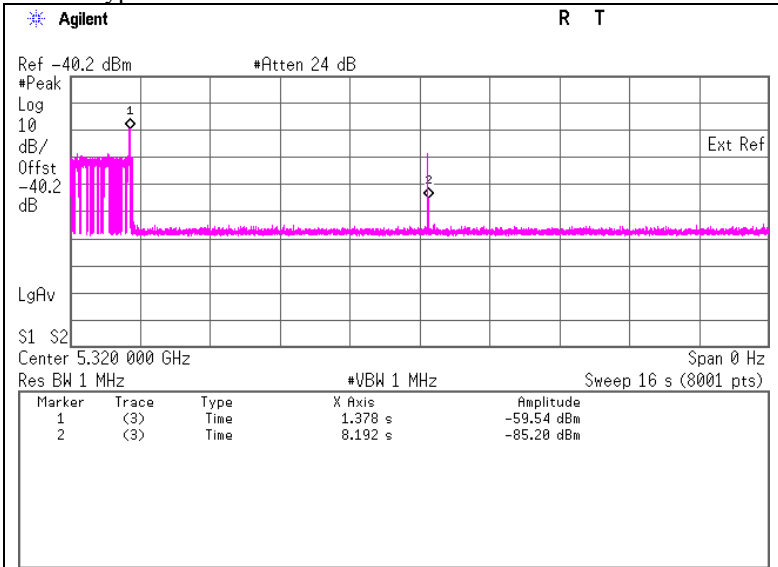

Marker 1 : End of Burst : 1378 ms
Marker 2 : End of Transmission : 8192 ms

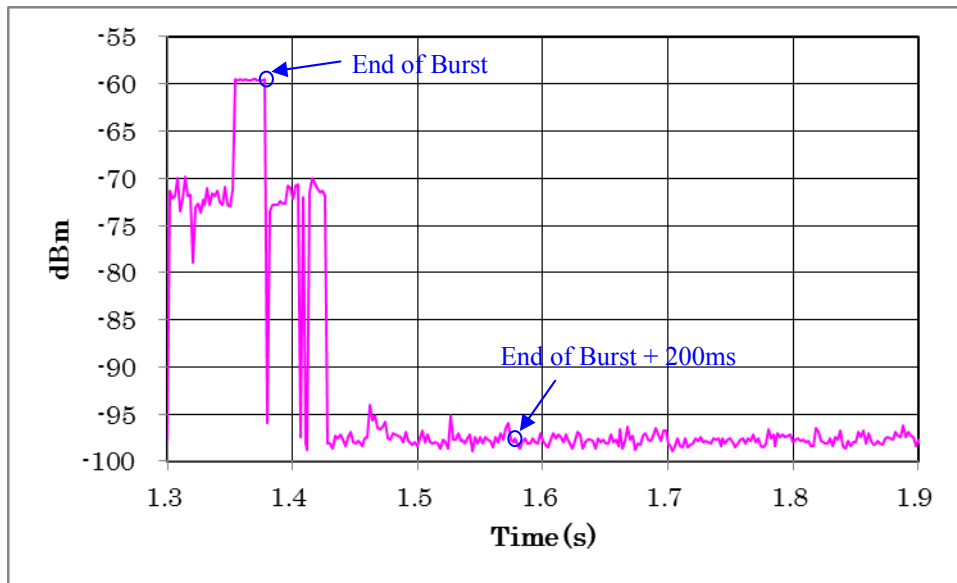

6.4 Test result

Test result: Pass

Date: February 19, 2014

Test engineer: Katsunori Okai

UL Japan, Inc.

Head Office EMC Lab.

4383-326 Asama-cho, Ise-shi, Mie-ken 516-0021 JAPAN

Telephone : +81 596 24 8999

Facsimile : +81 596 24 8124

SECTION 7: Non-Occupancy Period

7.1 Operating environment

Test place : No.6 measurement room
Temperature : 23 deg. C
Humidity : 45 % RH

7.2 Test Procedure

The following two tests are performed:

1).Stream the MPEG test file from the Master Device to the Client Device on the test Channel for the entire period of the test.

The Radar Waveform generator sends a Burst of pulses for one of the Radar Types 1-6 at levels defined on the Operating Channel. An additional 1 dB is added to the radar test signal to ensure it is at or above the DFS Detection Threshold, accounting for equipment variations/errors.

Observe the transmissions of the EUT after the Channel Move Time on the Operating Channel for duration greater than 30 minutes.

2). Stream the MPEG test file from the Master Device to the Client Device on the test Channel for the entire period of the test.

Observe the transmissions of the EUT on the Operating Channel for duration greater than 30 minutes after the Master Device is shut off.

7.3 Test data

1). Non-Occupancy Period

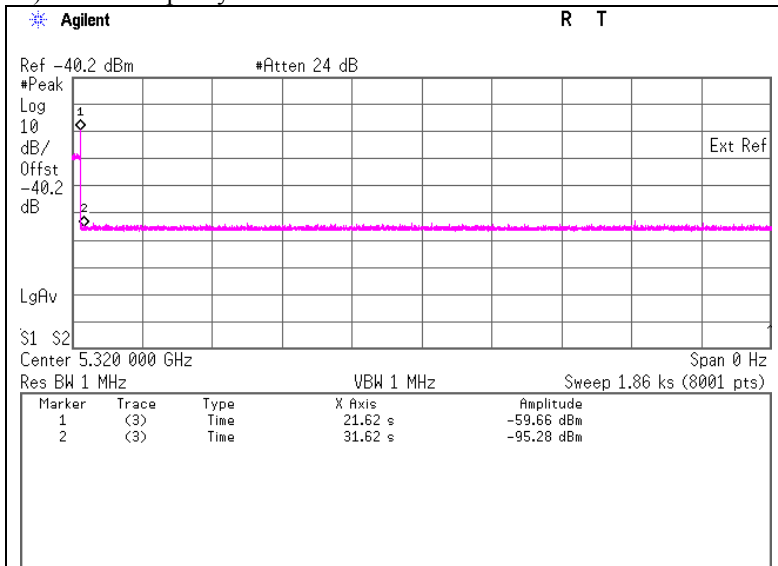

Marker 1 : End of Burst : 21.62 sec

Marker 2 : End of Burst +10sec : 31.62 sec

UL Japan, Inc.

Head Office EMC Lab.

4383-326 Asama-cho, Ise-shi, Mie-ken 516-0021 JAPAN

Telephone : +81 596 24 8999

Facsimile : +81 596 24 8124

2).Master is shut off

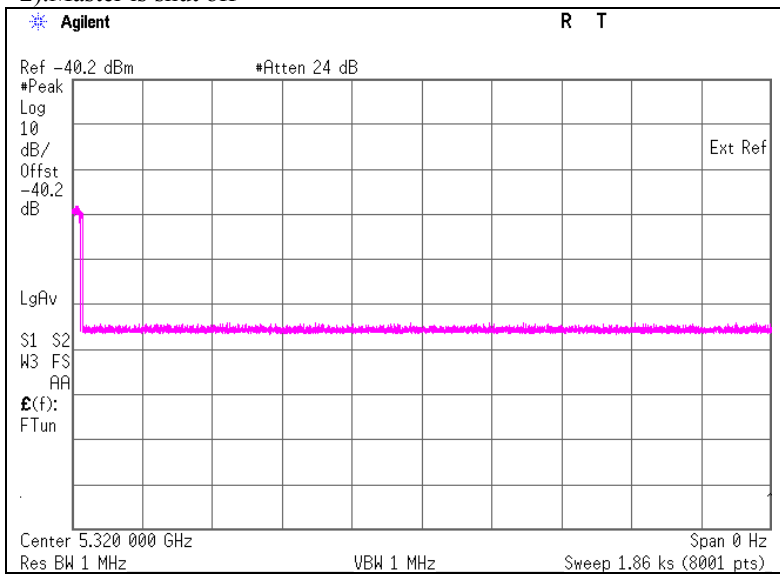

7.4 Test result

Test result: Pass

Date: February 19, 2014

Test engineer: Katsunori Okai

APPENDIX 1: Test instruments

EMI Test Equipment

Control No.	Instrument	Manufacturer	Model No	Serial No	Test Item	Calibration Date * Interval(month)
MOS-14	Thermo-Hygrometer	Custom	CTH-201	1401	DFS	2013/02/26 * 12
MSA-04	Spectrum Analyzer	Agilent	E4448A	US44300523	DFS	2013/11/25 * 12
EST-48 *1)	Signal Generator	Agilent	E4438C	MY45090353	DFS	2013/12/10 * 12
MCC-91	Microwave Cable 1G-40GHz	Schner	SUCOFLEX102	30812/2	DFS	2013/05/31 * 12
MCC-93	Microwave Cable 1G-40GHz	Schner	SUCOFLEX102	30814/2	DFS	2013/05/31 * 12
MCC-93	Microwave Cable 1G-40GHz	Schner	SUCOFLEX102	30814/2	DFS	2013/05/31 * 12
MCC-99	Microwave Cable 1G-40GHz	Schner	SUCOFLEX102	30820/2	DFS	2013/05/31 * 12
MCC-137	Microwave cable	HUBER+SUHNER	SUCOFLEX 102	37954/2	DFS	2013/10/18 * 12
MCC-144	Microwave Cable	Junkosha	MWX221	1207S407	DFS	2013/08/19 * 12
MAT-56	Attenuator(10dB)	Suhner	6810.19.A	-	DFS	2014/01/15 * 12
MAT-57	Attenuator(10dB)	Suhner	6810.19.A	-	DFS	2014/01/15 * 12
MAT-58	Attenuator(10dB)	Suhner	6810.19.A	-	DFS	2014/01/15 * 12
MAT-60	Attenuator(20dB)	Suhner	6820.19.A	-	DFS	Pre Check
MAT-61	Attenuator(20dB)	Suhner	6820.19.A	-	DFS	Pre Check
MPD-01	PowerDivider DC to 26.5GHz	Agilent	11636B	52258	DFS	2013/03/28 * 12
MPSC-02	Power Splitters/Combiners	Mini-Circuit	ZFSC-2-10G	0127	DFS	2013/09/30 * 12
COTS-MDFS-01	Signal Studio Software for DFS	Agilent	N7620A-101	5010-7739	DFS	-
COTS-MDFS-02	Radar Generating Software for DFS	Agilent	-	-	DFS	-

***1) Signal generator is only used to generate radar test signal, and the wave form is confirmed with spectrum analyzer every time before the test.**

The expiration date of the calibration is the end of the expired month.

All equipment is calibrated with valid calibrations. Each measurement data is traceable to the national or international standards.

As for some calibrations performed after the tested dates, those test equipment have been controlled by means of an unbroken chains of calibrations.

DFS: Dynamic Frequency Selection

UL Japan, Inc.

Head Office EMC Lab.

4383-326 Asama-cho, Ise-shi, Mie-ken 516-0021 JAPAN

Telephone : +81 596 24 8999

Facsimile : +81 596 24 8124