



RADIO TEST REPORT

Test Report No. : 11242579M-A

Applicant : CASIO COMPUTER CO., LTD.
Type of Equipment : Handheld Terminal
Model No. : IT-G500-C21E-US
FCC ID : BBQITG500
Test regulation : FCC Part 15 Subpart C: 2016
(Wireless LAN part)
Test Result : Complied

1. This test report shall not be reproduced in full or partial, without the written approval of UL Japan, Inc.
2. The results in this report apply only to the sample tested.
3. This sample tested is in compliance with the above regulation.
4. The test results in this report are traceable to the national or international standards.
5. The opinions and the interpretations to the result of the description in this report are outside scopes where UL Japan has been accredited.
6. This test report covers Radio technical requirements. It does not cover administrative issues such as Manual or non-Radio test related Requirements. (if applicable)

Date of test: May 12, 16, 18, 19, 20, 22, 26-28, 2016

Representative test engineer:

Kazuhiro Ando
Engineer
Consumer Technology Division

Approved by:

Masanori Nishiyama
Manager
Consumer Technology Division



CERTIFICATE 1266.01

- The testing in which "Non-accreditation" is displayed is outside the accreditation scopes in UL Japan.
 There is no testing item of "Non-accreditation".

UL Japan, Inc.

Kashima EMC Lab.

1614, Mushiata, Katori-shi, Chiba-ken, 289-0341 Japan

Telephone : +81-478-88-6500

Facsimile : +81-478-82-3373

CONTENTS	PAGE
SECTION 1: Customer information.....	4
SECTION 2: Equipment under test (E.U.T.).....	4
SECTION 3: Test specification, procedures & results.....	6
SECTION 4: Operation of E.U.T. during testing.....	9
SECTION 5: Conducted Emission.....	12
SECTION 6: Radiated Spurious Emission	13
SECTION 7: Antenna Terminal Conducted Tests.....	15
APPENDIX 1: Test data	16
Conducted Emission	16
6dB Bandwidth	18
Maximum Peak Output Power.....	21
Average Output Power.....	24
Radiated Spurious Emission	27
Conducted Spurious Emission	42
Power Density	43
99%Occupied Bandwidth	46
APPENDIX 2: Test instruments	48
APPENDIX 3: Photographs of test setup	50
Conducted Emission	50
Radiated Spurious Emission	52
Worst Case Position	53

SECTION 1: Customer information

Company Name : CASIO COMPUTER CO., LTD.
Address : 2951-5, Ishikawa-Machi, Hachioji-shi Tokyo 192-8556, Japan
Telephone Number : +81-42-639-5188
Facsimile Number : +81-42-639-5046
Contact Person : KATSUMASA MOTOKI

SECTION 2: Equipment under test (E.U.T.)

2.1 Identification of E.U.T.

Type of Equipment : Handheld Terminal
Model No. : IT-G500-C21E-US
Serial No. : Refer to Section 4, Clause 4.2
Rating : Li-ion battery DC3.7V 1850mAh/6.9Wh, M/N:HA-D20BAT-A
Option Battery : Li-ion battery DC3.7V 3700mAh/14Wh, M/N:HA-D21LBAT-A
Receipt Date of Sample : April 18, 2016
Country of Mass-production : Japan
Condition of EUT : Production prototype
(Not for Sale: This sample is equivalent to mass-produced items.)
Modification of EUT : No Modification by the test lab

2.2 Product Description

Model: IT-G500-C21E-US (referred to as the EUT in this report) is a Handheld Terminal.

General Specification

Clock frequency(ies) in the system	CPU: 1.5 GHz
Power Supply (inner)	DC 3.3 V / 1.8 V

UL Japan, Inc.

Kashima EMC Lab.

1614, Mushiata, Katori-shi, Chiba-ken, 289-0341 Japan

Telephone : +81-478-88-6500

Facsimile : +81-478-82-3373

Radio Specification

WLAN (IEEE802.11b/g/a/n-20)

Equipment Type	Transceiver
Frequency of Operation	2412-2462MHz, 5180-5825MHz
Type of Modulation	DSSS, OFDM
Antenna type	Inverted F antenna (IEEE802.11b/g/n) Dipole antenna (IEEE802.11a/n)
Antenna Gain	0.79dBi (2412-2462MHz) 1.05dBi (5180-5825MHz)

BT

Equipment Type	Transceiver
Frequency of Operation	2402-2480MHz
Type of Modulation	FHSS
Antenna type	Inverted F antenna
Antenna Gain	0.79dBi

RFID

Equipment Type	Transceiver
Frequency of Operation	13.56MHz
Type of Modulation	ASK
Antenna type	Loop antenna

- * Refer to the test reports: 11242579M-B for 2.4 GHz band (Bluetooth part).
- * Refer to the test reports: 11242579M-C and 11242579M-D for 5 GHz band.
- * Refer to the test reports: 11242579M-E for 13.56 MHz band (RFID).

SECTION 3: Test specification, procedures & results

3.1 Test Specification

Test Specification : FCC Part 15 Subpart C
FCC part 15 final revised on April 6, 2016.

Title : FCC 47CFR Part15 Radio Frequency Device Subpart C Intentional Radiators
Section 15.207 Conducted limits
Section 15.247 Operation within the bands 902-928MHz,
2400-2483.5MHz, and 5725-5850MHz

* Also the EUT complies with FCC Part 15 Subpart B.

3.2 Procedures and results

Item	Test Procedure	Specification	Worst margin	Results	Remarks
Conducted Emission	FCC: ANSI C63.10-2013 6. Standard test methods IC: RSS-Gen 8.8	FCC: Section 15.207 IC: RSS-Gen 8.8	QP 14.4 dB, 0.47705 MHz, N AV 11.4 dB, 0.50000 MHz, N	Complied	-
6dB Bandwidth	FCC: KDB 558074 D01 DTS Meas Guidance v03r05 IC: -	FCC: Section 15.247(a)(2) IC: RSS-247 5.2(1)	See data.	Complied	Conducted
Maximum Peak Output Power	FCC: KDB 558074 D01 DTS Meas Guidance v03r05 IC: RSS-Gen 6.12	FCC: Section 15.247(b)(3) IC: RSS-247 5.4(4)		Complied	Conducted
Power Density	FCC: KDB 558074 D01 DTS Meas Guidance v03r05 IC: -	FCC: Section 15.247(e) IC: RSS-247 5.2(2)		Complied	Conducted
Spurious Emission Restricted Band Edges	FCC: KDB 558074 D01 DTS Meas Guidance v03r05 IC: RSS-Gen 6.13	FCC: Section 15.247(d) IC: RSS-247 5.5 RSS-Gen 8.9 RSS-Gen 8.10	0.5 dB 2483.500 MHz, AV, Hori.	Complied	Conducted (below 30 MHz)/ Radiated (above 30 MHz) *1)

Note: UL Japan, Inc.'s EMI Work Procedures No. 13-EM-W0420 and 13-EM-W0422.

*1) Radiated test was selected over 30 MHz based on section 15.247(d) and KDB 558074 D01 DTS Meas Guidance v03r05 12.2.7.

* In case any questions arise about test procedure, ANSI C63.10: 2013 is also referred.

FCC Part 15.31 (e)

This EUT provides stable voltage (DC 1.8V) constantly to RF Part regardless of input voltage. Therefore, this EUT complies with the requirement.

FCC Part 15.203 Antenna requirement

It is impossible for end users to replace the antenna, because the antenna is mounted inside of the EUT. Therefore, the equipment complies with the antenna requirement of Section 15.203.

UL Japan, Inc.

Kashima EMC Lab.

1614, Mushihata, Katori-shi, Chiba-ken, 289-0341 Japan

Telephone : +81-478-88-6500

Facsimile : +81-478-82-3373

3.3 Addition to standard

Item	Test Procedure	Specification	Worst margin	Results	Remarks
99% Occupied Bandwidth	IC: RSS-Gen 6.6	IC: -	N/A	-	Conducted

Other than above, no addition, exclusion nor deviation has been made from the standard.

3.4 Uncertainty

EMI

The following uncertainties have been calculated to provide a confidence level of 95 % using a coverage factor $k = 2$.

Item	Frequency range	Uncertainty (+/-)
		No. 1 SAC / SR
Radiated emission (Measurement distance: 3m)	30MHz - 300MHz	4.7dB
	300MHz - 1GHz	3.6dB
	1GHz - 10GHz	5.1dB
Radiated emission (Measurement distance: 1m)	10GHz - 18GHz	5.7dB
	18GHz - 26.5GHz	5.1dB

Antenna terminal test	Uncertainty (+/-)
Power Measurement above 1GHz	0.7dB
Spurious emission (Conducted) below 1GHz	1.6dB
Spurious emission (Conducted) 1GHz - 3GHz	1.4dB
Spurious emission (Conducted) 3GHz - 18GHz	2.8dB
Spurious emission (Conducted) 18GHz - 26.5GHz	2.5dB
Bandwidth Measurement	5.4%

Conducted Emission test

The data listed in this test report has enough margin, more than the site margin.

Radiated emission test

The data listed in this report meets the limits unless the uncertainty is taken into consideration.

3.5 Test Location

UL Japan, Inc. Kashima EMC Lab.
1614 Mushihata, Katori-shi, Chiba-ken, 289-0341 JAPAN
Telephone: +81 478 88 6500, Facsimile: +81 478 82 3373
A2LA Accreditation No. 1266.01

Test site	IC Registration Number	Width x Depth x Height (m)	Size of reference ground plane (m) / horizontal conducting plane	Maximum measurement distance
No.1 Open site	4659A-1	6.0 x 5.5 x 2.5	20 x 40	10 m
No.2 Open site	4659A-2	4.4 x 4.4 x 2.15	18 x 20	10 m
No.5 Open site	4659A-5	8.6 x 7.1 x 2.4	18 x 23	10 m
No.1 Shielded room	4659A-1	5.4 x 4.5 x 2.3	-	-
No.2 Shielded room	4659A-2	3.6 x 2.7 x 2.3	-	-
No.3 Shielded room	-	5.4 x 3.6 x 2.3	-	-
No.4 Shielded Room	-	6.1 x 6.1 x 3.1	-	-
No.5 Shielded Room	4659A-5	4.2 x 3.1 x 2.5	-	-
No.3 Fully Anechoic Chamber	-	7.0 x 3.5 x 3.5	-	-
No.6 Semi-anechoic Chamber	4659A-6	8.5 x 5.5 x 5.2	-	3 m
No.10 Semi-anechoic Chamber	4659A-10	18.4 x 9.9 x 7.7	-	10 m
No.11 Semi-anechoic Chamber	4659A-7	9.0 x 6.5 x 5.2	-	3 m
No.1 Measurement room	-	5.0 x 3.7 x 2.6	-	-
No.2 Measurement room	-	4.3 x 4.4 x 2.7	-	-
No.3 Measurement room	-	4.3 x 4.4 x 2.7	-	-

3.6 Test data, Test instruments, and Test set up

Refer to APPENDIX.

SECTION 4: Operation of E.U.T. during testing

4.1 Operating Mode(s)

Test operating mode was determined as follows according to “Section 1 of 6 802.11 a/b/g/n testing - Managing Complex Regulatory Approvals - ” of TCB Council Workshop October 2009.

Mode	Remarks*
IEEE 802.11b (11b)	2 Mbps, PN9
IEEE 802.11g (11g)	6 Mbps, PN9
IEEE 802.11n SISO 20 MHz BW (11n-20)	MCS 0, PN9
*The worst condition was determined based on the test result of Maximum Peak Output Power (Mid Channel)	
*Power of the EUT was set by the software as follows; Power settings: 11b (2412 MHz: 11000, 2437 MHz: 11000, 2462 MHz: 11000) 11g (2412 MHz: 11000, 2437 MHz: 25000, 2462 MHz: 11000) 11n-20 (2412 MHz: 11000, 2437 MHz: 25000, 2462 MHz: 11000) Software: WL127X_TOOL	
*This setting of software is the worst case. Any conditions under the normal use do not exceed the condition of setting. In addition, end users cannot change the settings of the output power of the product.	

*The details of Operating mode(s)

Test Item	Operating Mode	Tested frequency
Conducted Emission *1)	11n-20 Tx	2437 MHz
Spurious Emission above 1 GHz (Radiated)	11b Tx 11g Tx 11n-20 Tx	2412 MHz 2437 MHz 2462 MHz
Spurious Emission below 1 GHz (Radiated) *1)	11n-20 Tx	2437 MHz
6dB Bandwidth, Maximum Peak Output Power, Power Density, 99% Occupied Bandwidth	11b Tx 11g Tx 11n-20 Tx	2412 MHz 2437 MHz 2462 MHz
Spurious Emission (Conducted) *1)	11n-20 Tx	2437 MHz

*1) The mode was tested as a representative, because it had the highest power at antenna terminal test.

UL Japan, Inc.

Kashima EMC Lab.

1614, Mushiata, Katori-shi, Chiba-ken, 289-0341 Japan

Telephone : +81-478-88-6500

Facsimile : +81-478-82-3373

4.2 Configuration and peripherals

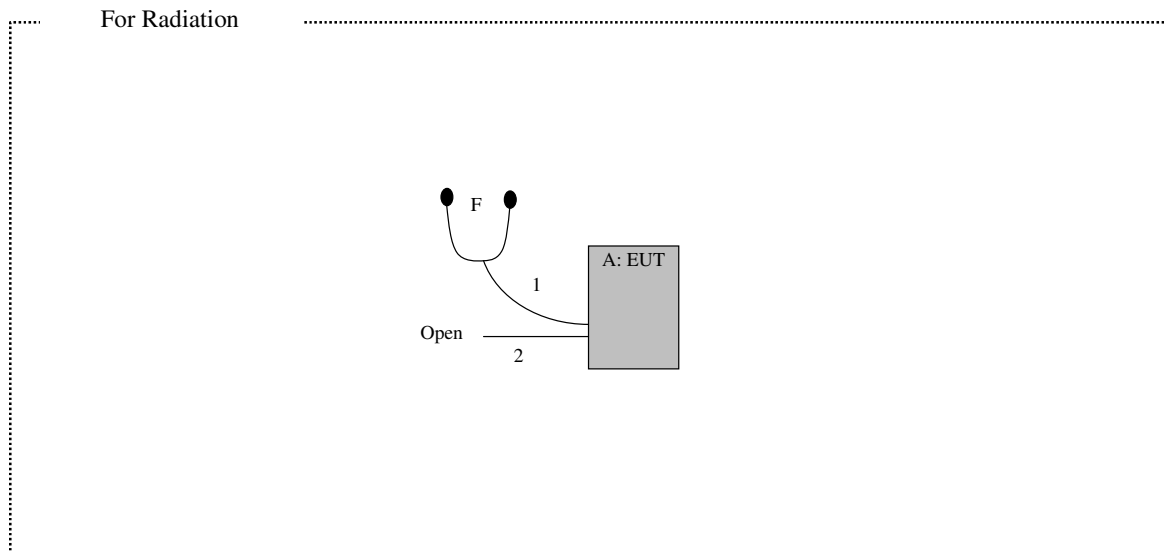
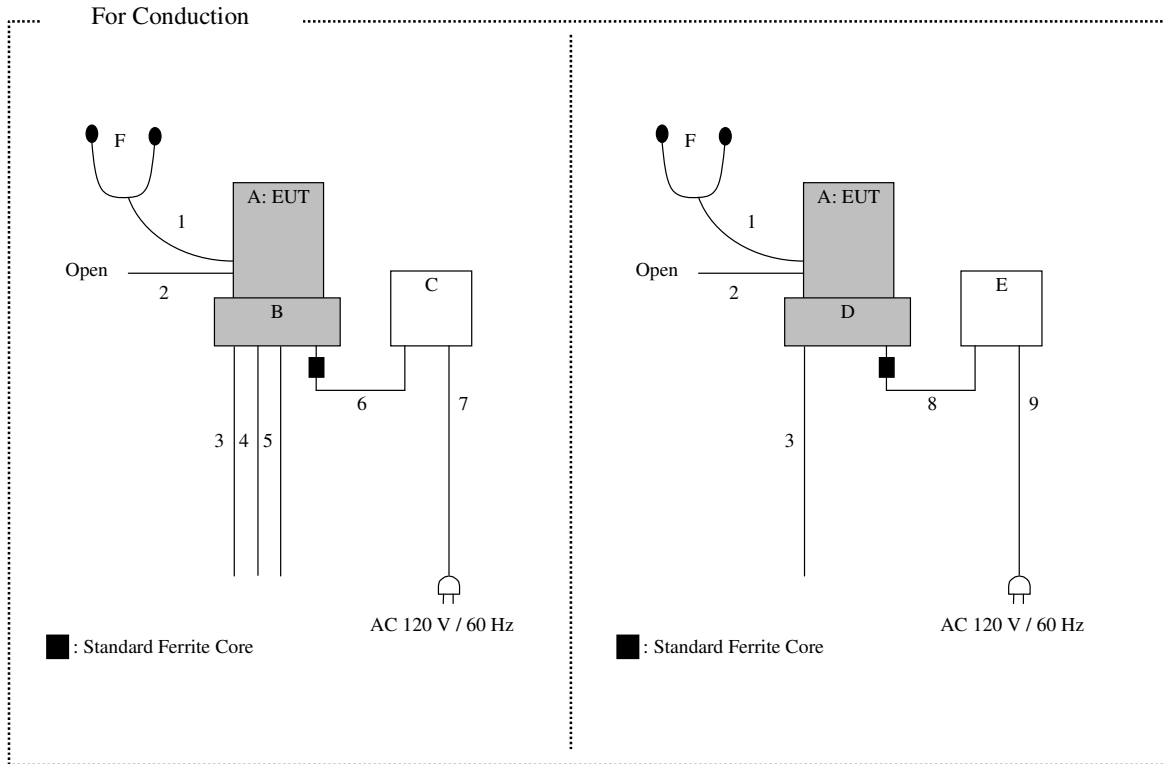

* Cabling and setup(s) were taken into consideration and test data was taken under worse case conditions.

Description of EUT and Support equipment

No.	Item	Model number	Serial number	Manufacturer	Remarks
A	Handheld Terminal	IT-G500-C21E-US	024SE LG6200795IAAD1 *1) 024SE LG6100692IAAC1 *2)	CASIO COMPUTER CO., LTD.	EUT
B	Cradle	HA-P62IO	244AA JX4B00502 GAAA1	CASIO COMPUTER CO., LTD.	EUT
C	AC Adapter	AD-S42120C	0915C	CASIO COMPUTER CO., LTD.	-
D	Cradle	HA-P60IO	241AA JW4B00501 GAAA1	CASIO COMPUTER CO., LTD.	EUT
E	AC Adapter	AD-S15050B	0711C	CASIO COMPUTER CO., LTD.	-
F	Ear phone	-	-	-	-

*1) Used for Antenna Terminal conducted tests

*2) Used for Conducted Emission test and Radiated Spurious Emission tests

List of cables used

No.	Name	Length (m)	Shield		Remarks
			Cable	Connector	
1	Ear phone	1.2	Unshielded	Unshielded	-
2	USB	1.8	Shielded	Shielded	-
3	USB	1.8	Shielded	Shielded	-
4	USB	2.0	Shielded	Shielded	-
5	LAN	1.0	Unshielded	Unshielded	-
6	DC	1.5	Unshielded	Unshielded	-
7	AC	2.0	Unshielded	Unshielded	-
8	DC	1.5	Unshielded	Unshielded	-
9	AC	2.0	Unshielded	Unshielded	-

UL Japan, Inc.

Kashima EMC Lab.

1614, Mushihata, Katori-shi, Chiba-ken, 289-0341 Japan

Telephone : +81-478-88-6500

Facsimile : +81-478-82-3373

SECTION 5: Conducted Emission

Test Procedure and conditions

EUT was placed on a wooden table of nominal size, 1.0 m by 2.0 m, raised 0.8m above the conducting ground plane. The rear of tabletop was located 40 cm to the vertical conducting plane. The rear of EUT, including peripherals aligned and flushed with rear of tabletop. All other surfaces of tabletop were at least 80 cm from any other grounded conducting surface. EUT was located 80 cm from a Line Impedance Stabilization Network (LISN) / Artificial mains Network (AMN) and excess AC cable was bundled in center.

I/O cables that were connected to the peripherals were bundled in center. They were folded back and forth forming a bundle 30 cm to 40 cm long and were hanged at a 40 cm height to the ground plane.

The AC Mains Terminal Continuous disturbance Voltage has been measured with the EUT in a Semi Anechoic Chamber.

The EUT was connected to a LISN (AMN).

An overview sweep with peak detection has been performed.

The test results and limit are rounded off to one decimal place, so some differences might be observed.

Detector : QP and CISPR AV
Measurement range : 0.15 MHz - 30 MHz
Test data : APPENDIX
Test result : Pass

SECTION 6: Radiated Spurious Emission

Test Procedure

It was measured based on "11.0 Emissions in non-restricted frequency bands" of "558074 D01 DTS Meas Guidance v03r05".

[For below 1 GHz]

EUT was placed on a urethane platform of nominal size, 0.5 m by 0.5 m, raised 0.8 m above the conducting ground plane. The Radiated Electric Field Strength has been measured in a Semi Anechoic Chamber with a ground plane.

[For above 1 GHz]

EUT was placed on a urethane platform of nominal size, 0.5 m by 0.5 m, raised 1.5 m above the conducting ground plane.

The Radiated Electric Field Strength has been measured in a Semi Anechoic Chamber with absorbent materials lined on a ground plane.

The height of the measuring antenna varied between 1 and 4 m and EUT was rotated a full revolution in order to obtain the maximum value of the electric field strength.

The measurements were performed for both vertical and horizontal antenna polarization with the Test Receiver, or the Spectrum Analyzer.

The measurements were made with the following detector function of the test receiver and the Spectrum analyzer (in linear mode).

The test was made with the detector (RBW/VBW) in the following table.

When using Spectrum analyzer, the test was made with adjusting span to zero by using peak hold.

Test Antennas are used as below;

Frequency	Below 1 GHz	Above 1 GHz
Antenna Type	Hybrid	Horn

In any 100 kHz bandwidth outside the restricted band in which the spread spectrum intentional radiator is operating, the radio frequency power that is produced by the intentional radiator confirmed 20 dB below that in the 100 kHz bandwidth within the band that contains the highest level of the desired power, based on a radiated measurement.

20 dBc was applied to the frequency over the limit of FCC 15.209 / Table 4 of RSS-Gen 8.9(IC) and outside the restricted band of FCC15.205 / Table 6 of RSS-Gen 8.10 (IC).

Frequency	Below 1 GHz	Above 1 GHz		20 dBc
Instrument used	Test Receiver	Spectrum Analyzer		Spectrum Analyzer
Detector	QP	PK	AV *3)	PK
IF Bandwidth	BW 120 kHz	RBW: 1 MHz VBW: 3 MHz	Average Power Method: RBW: 1 MHz VBW: 3 MHz Detector: Power Averaging (RMS) Trace: 100 traces If duty cycle was less than 98%, a duty factor was added to the results.	RBW: 100 kHz VBW: 300kHz
Test Distance	3.0 m	4.5 m *1) (1 GHz - 10 GHz), 1.0 m *2) (10 GHz - 26.5 GHz)		4.5 m *1) (1 GHz - 10 GHz), 1.0 m *2) (10 GHz - 26.5 GHz)

*1) Distance Factor: $20 \times \log(4.5 \text{ m} / 3.0 \text{ m}) = 3.5 \text{ dB}$

*2) Distance Factor: $20 \times \log(1.0 \text{ m} / 3.0 \text{ m}) = -9.5 \text{ dB}$

*3) Average Power Measurement was performed based on 6.0 & 12.2.5 of "KDB 558074 D01 DTS Meas Guidance v03r05"

UL Japan, Inc.

Kashima EMC Lab.

1614, Mushihata, Katori-shi, Chiba-ken, 289-0341 Japan

Telephone : +81-478-88-6500

Facsimile : +81-478-82-3373

- The carrier level and noise levels were confirmed at each position of X, Y and Z axes of EUT and EUT on the cradle to see the position of maximum noise, and the test was made at the position that has the maximum noise.

The test results and limit are rounded off to one decimal place, so some differences might be observed.

Measurement range : 30 MHz - 26.5 GHz
Test data : APPENDIX
Test result : Pass

SECTION 7: Antenna Terminal Conducted Tests

Test Procedure

The tests were made with below setting connected to the antenna port.

Test	Span	RBW	VBW	Sweep time	Detector	Trace	Instrument used
6dB Bandwidth	50 MHz	100 kHz	300 kHz	Auto	Peak	Max Hold	Spectrum Analyzer
99% Occupied Bandwidth *1)	Enough width to display emission skirts	1 to 5 % of OBW	Three times of RBW	Auto	Peak	Max Hold	Spectrum Analyzer
Maximum Peak Output Power	-	-	-	Auto	Peak/Average *2)	-	Power Meter (Sensor: 160 MHz BW)
Peak Power Density	1.5 times the 6dB Bandwidth	3 kHz	9.1 kHz	Auto	Peak	Max Hold	Spectrum Analyzer *3)
Conducted Spurious Emission *4)	9kHz to 150kHz	200 Hz	620 Hz	Auto	Peak	Max Hold	Spectrum Analyzer
	150kHz to 30MHz	10 kHz	30 kHz				

*1) Peak hold was applied as Worst-case measurement.

*2) Reference data

*3) Section 10.2 Method PKPSD (peak PSD) of "KDB 558074 D01 DTS Meas Guidance v03r05".

*4) In the frequency range below 30MHz, RBW was narrowed to separate the noise contents.

Then, wide-band noise near the limit was checked separately, however the noise was not detected as shown in the chart.

(9 kHz - 150 kHz: RBW = 200 Hz, 150 kHz - 30 MHz: RBW = 10 kHz)

The test results and limit are rounded off to two decimals place, so some differences might be observed.

Test data : APPENDIX

Test result : Pass

UL Japan, Inc.

Kashima EMC Lab.

1614, Mushihata, Katori-shi, Chiba-ken, 289-0341 Japan

Telephone : +81-478-88-6500

Facsimile : +81-478-82-3373

APPENDIX 1: Test data

Conducted Emission
(Cradle: HA-P62IO)

DATA OF CONDUCTED EMISSION TEST

UL Japan, Inc. Kashima EMC Lab, No.2 Shielded Room
Date : 2016/05/26

Mode : Tx, 11n-20, MCS0, 2437MHz
Order No. : 11242579M
Power : AC 120V / 60Hz
Temp./Humi. : 22deg.C / 59%RH

Limit1 : FCC 15C (15.207) ClassB QP
Limit2 : FCC 15C (15.207) ClassB AV

Tested by : Kazuhiro Ando

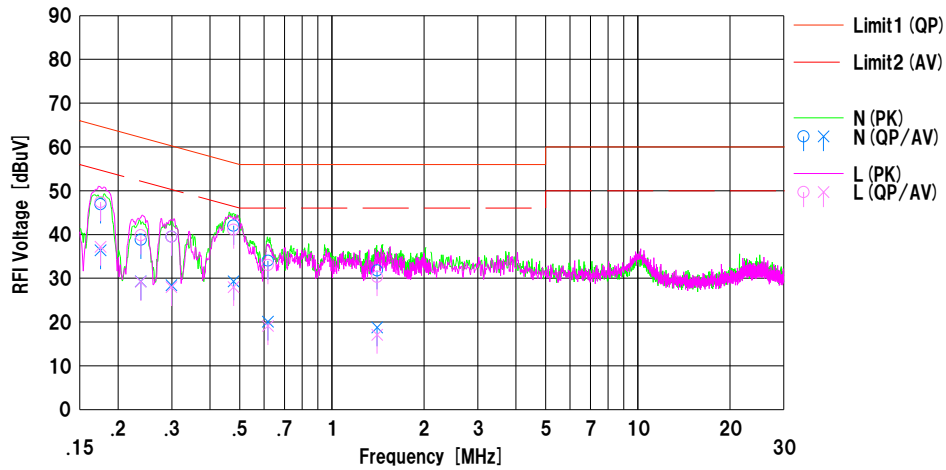

No.	Freq. [MHz]	Reading		C.Fac	Results		Limit		Margin		Phase	Comment
		<QP> [dBuV]	<AV> [dBuV]		<QP> [dBuV]	<AV> [dBuV]	<QP> [dBuV]	<AV> [dBuV]	<QP> [dB]	<AV> [dB]		
1	0.17530	37.2	26.7	9.7	46.9	36.4	64.7	54.7	17.8	18.3	N	
2	0.23732	29.1	19.6	9.7	38.8	29.3	62.2	52.2	23.4	22.9	N	
3	0.29907	29.8	18.7	9.7	39.5	28.4	60.3	50.3	20.8	21.9	N	
4	0.47705	32.3	19.6	9.7	42.0	29.3	56.4	46.4	14.4	17.1	N	
5	0.61800	24.3	10.4	9.7	34.0	20.1	56.0	46.0	22.0	25.9	N	
6	1.40636	22.0	9.0	9.8	31.8	18.8	56.0	46.0	24.2	27.2	N	
7	0.17530	37.7	27.5	9.7	47.4	37.2	64.7	54.7	17.3	17.5	L	
8	0.23732	30.1	19.5	9.7	39.8	29.2	62.2	52.2	22.4	23.0	L	
9	0.29907	29.8	18.3	9.7	39.5	28.0	60.3	50.3	20.8	22.3	L	
10	0.47705	31.4	18.3	9.7	41.1	28.0	56.4	46.4	15.3	18.4	L	
11	0.61800	23.3	9.4	9.7	33.0	19.1	56.0	46.0	23.0	26.9	L	
12	1.40636	20.5	7.3	9.8	30.3	17.1	56.0	46.0	25.7	28.9	L	

Calculation:Result [dBuV] =Reading [dBuV] +C.Fac (LISN+Cable) [dB]
LISN:CLS-25

Conducted Emission
(Cradle: HA-P60IO)

DATA OF CONDUCTED EMISSION TEST

UL Japan, Inc. Kashima EMC Lab. No.2 Shielded Room
Date : 2016/05/26

Mode : Tx, 11n-20, MCS0, 2437MHz
Order No. : 11242579M
Power : AC 120V / 60Hz
Temp./Humi. : 22deg.C / 59%RH

Limit1 : FCC 15C (15.207) ClassB QP
Limit2 : FCC 15C (15.207) ClassB AV

Tested by : Kazuhiro Ando

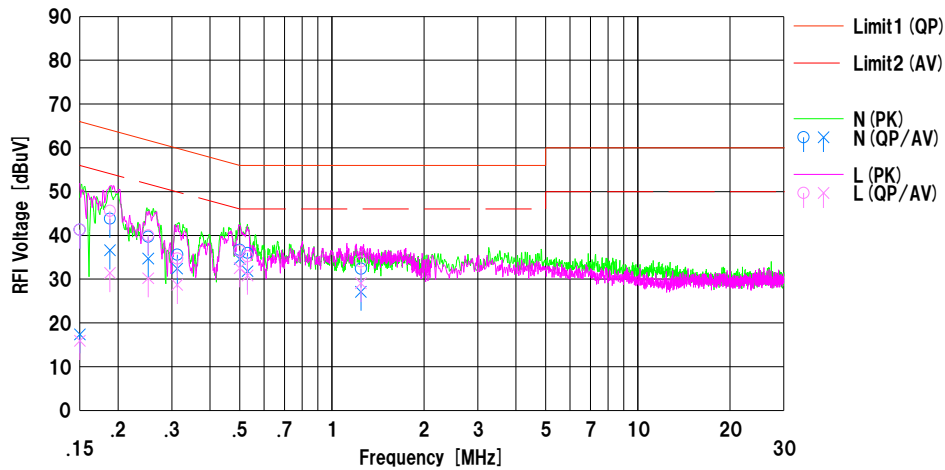

No.	Freq. [MHz]	Reading		C.Fac [dB]	Results		Limit		Margin		Phase	Comment
		<QP> [dBuV]	<AV> [dBuV]		<QP> [dBuV]	<AV> [dBuV]	<QP> [dB]	<AV> [dB]				
1	0.15000	31.6	7.7	9.7	41.3	17.4	66.0	56.0	24.7	38.6	N	
2	0.18820	34.1	26.9	9.7	43.8	36.6	64.1	54.1	20.3	17.5	N	
3	0.25115	30.0	25.0	9.7	39.7	34.7	61.7	51.7	22.0	17.0	N	
4	0.31225	25.9	22.7	9.7	35.6	32.4	59.9	49.9	24.3	17.5	N	
5	0.50000	27.0	24.9	9.7	36.7	34.6	56.0	46.0	19.3	11.4	N	
6	0.53025	26.3	22.1	9.7	36.0	31.8	56.0	46.0	20.0	14.2	N	
7	1.24447	22.6	17.3	9.8	32.4	27.1	56.0	46.0	23.6	18.9	N	
8	0.15000	31.6	6.2	9.7	41.3	15.9	66.0	56.0	24.7	40.1	L	
9	0.18820	35.9	21.7	9.7	45.6	31.4	64.1	54.1	18.5	22.7	L	
10	0.25115	30.3	20.5	9.7	40.0	30.2	61.7	51.7	21.7	21.5	L	
11	0.31225	25.0	19.0	9.7	34.7	28.7	59.9	49.9	25.2	21.2	L	
12	0.50000	26.8	22.8	9.7	36.5	32.5	56.0	46.0	19.5	13.5	L	
13	0.53025	25.5	21.1	9.7	35.2	30.8	56.0	46.0	20.8	15.2	L	
14	1.24447	24.2	19.3	9.8	34.0	29.1	56.0	46.0	22.0	16.9	L	

Calculation:Result [dBuV] =Reading [dBuV] +C.Fac (LISN+Cable) [dB]
LISN:CLS-25

6dB Bandwidth

Test place Kashima EMC Lab. No.2 Measurement Room
Report No. 11242579M
Date May 27, 2016
Temperature / Humidity 23 deg. C / 41 % RH
Engineer Kazuhiro Ando
Mode Tx

Mode	Frequency [MHz]	6dB Bandwidth [MHz]	Limit [kHz]
11b	2412	9.515	> 500
	2437	9.619	> 500
	2462	9.660	> 500
11g	2412	15.193	> 500
	2437	15.194	> 500
	2462	15.331	> 500
11n-20	2412	15.336	> 500
	2437	15.292	> 500
	2462	15.291	> 500

6dB Bandwidth

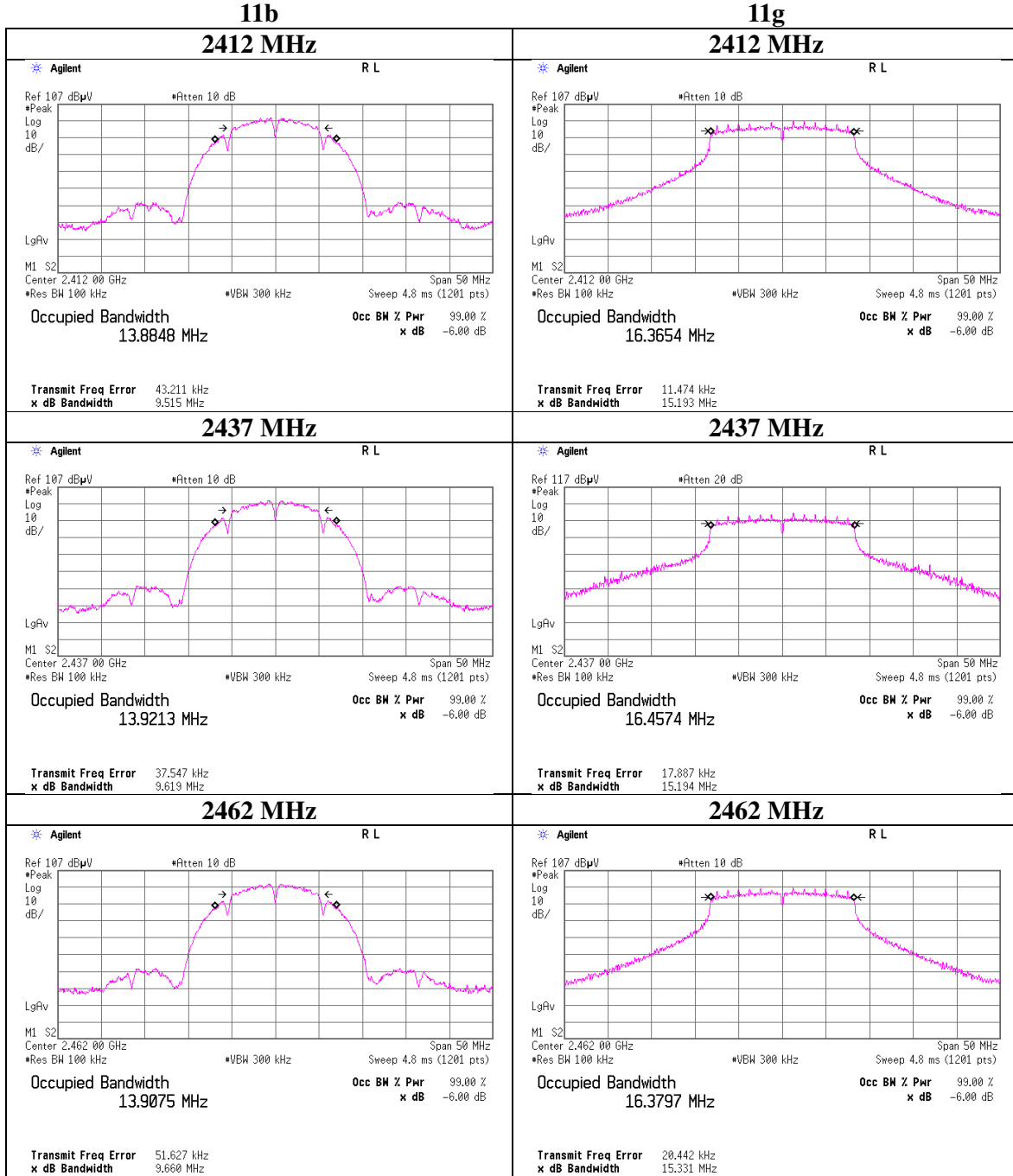

6dB Bandwidth

11n-20

2412 MHz

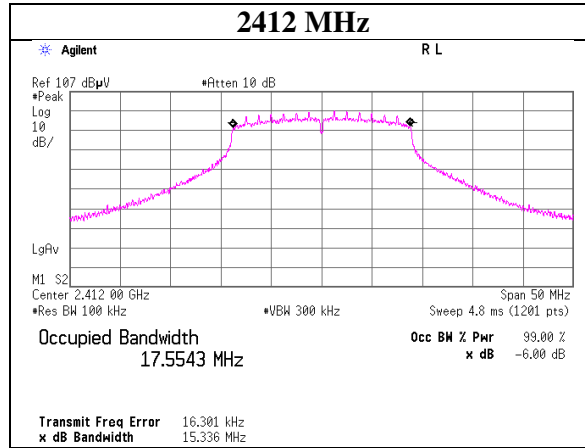

2437 MHz

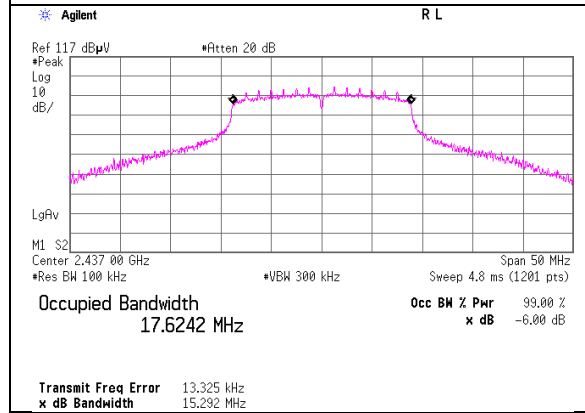

2462 MHz

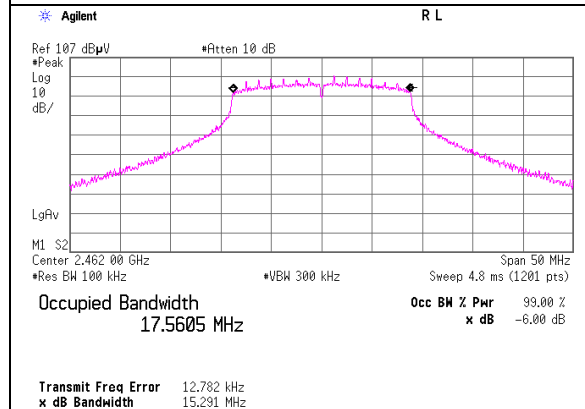

Maximum Peak Output Power

Test place	Kashima EMC Lab. No.2 Measurement Room
Report No.	11242579M
Date	May 27, 2016
Temperature / Humidity	23 deg. C / 41 % RH
Engineer	Kazuhiro Ando
Mode	Tx 11b

Freq. [MHz]	Reading [dBm]	Cable Loss [dB]	Atten. Loss [dB]	Result		Limit		Margin [dB]
				[dBm]	[mW]	[dBm]	[mW]	
2412	2.73	1.28	10.03	14.04	25.35	30.00	1000	15.96
2437	2.91	1.28	10.03	14.22	26.42	30.00	1000	15.78
2462	3.07	1.28	10.03	14.38	27.42	30.00	1000	15.62

Sample Calculation:

Result = Reading + Cable Loss (including the cable(s) customer supplied) + Attenuator Loss

*The equipment and cables were not used for factor 0 dB of the data sheets.

2437MHz

Rate [Mbps]	Reading [dBm]	Remark
1	2.85	
2	2.91	*
5.5	2.68	
11	2.56	

*: Worst Rate

All comparison were carried out on same frequency and measurement factors.

UL Japan, Inc.

Kashima EMC Lab.

1614, Mushiata, Katori-shi, Chiba-ken, 289-0341 Japan

Telephone : +81-478-88-6500

Facsimile : +81-478-82-3373

Maximum Peak Output Power

Test place	Kashima EMC Lab. No.2 Measurement Room
Report No.	11242579M
Date	May 27, 2016
Temperature / Humidity	23 deg. C / 41 % RH
Engineer	Kazuhiro Ando
Mode	Tx 11g

Freq. [MHz]	Reading [dBm]	Cable Loss [dB]	Atten. Loss [dB]	Result		Limit		Margin [dB]
				[dBm]	[mW]	[dBm]	[mW]	
2412	10.65	1.28	10.03	21.96	157.04	30.00	1000	8.04
2437	11.61	1.28	10.03	22.92	195.88	30.00	1000	7.08
2462	10.64	1.28	10.03	21.95	156.68	30.00	1000	8.05

Sample Calculation:

Result = Reading + Cable Loss (including the cable(s) customer supplied) + Attenuator Loss

*The equipment and cables were not used for factor 0 dB of the data sheets.

2437 MHz

Rate [Mbps]	Reading [dBm]	Remark
6	11.61	*
9	11.58	
12	11.58	
18	11.57	
24	11.59	
36	11.39	
48	11.45	
54	11.50	

*: Worst Rate

All comparison were carried out on same frequency and measurement factors.

UL Japan, Inc.

Kashima EMC Lab.

1614, Mushihata, Katori-shi, Chiba-ken, 289-0341 Japan

Telephone : +81-478-88-6500

Facsimile : +81-478-82-3373

Maximum Peak Output Power

Test place Kashima EMC Lab. No.2 Measurement Room
Report No. 11242579M
Date May 27, 2016
Temperature / Humidity 23 deg. C / 41 % RH
Engineer Kazuhiro Ando
Mode Tx 11n-20

Freq. [MHz]	Reading [dBm]	Cable Loss [dB]	Atten. Loss [dB]	Result		Limit		Margin [dB]
				[dBm]	[mW]	[dBm]	[mW]	
2412	10.71	1.28	10.03	22.02	159.22	30.00	1000	7.98
2437	11.76	1.28	10.03	23.07	202.77	30.00	1000	6.93
2462	10.79	1.28	10.03	22.10	162.18	30.00	1000	7.90

Sample Calculation:

Result = Reading + Cable Loss (including the cable(s) customer supplied) + Attenuator Loss

*The equipment and cables were not used for factor 0 dB of the data sheets.

2437 MHz

MCS Number	Reading [dBm]	Remark
0	11.76	*
1	11.75	
2	11.74	
3	11.63	
4	11.58	
5	11.59	
6	11.52	
7	11.40	

*: Worst Rate

All comparison were carried out on same frequency and measurement factors.

Average Output Power
(Reference data)

Test place : Kashima EMC Lab. No.2 Measurement Room
Report No. : 11242579M
Date : May 27, 2016
Temperature / Humidity : 23 deg. C / 41 % RH
Engineer : Kazuhiro Ando
Mode : Tx

11b 2 Mbps

Freq. [MHz]	Reading [dBm]	Cable Loss [dB]	Atten. Loss [dB]	Result (Frame power)		Duty factor [dB]	Result (Burst power)	
				[dBm]	[mW]		[dBm]	[mW]
2412	0.35	1.28	10.03	11.66	14.66	0.02	11.68	14.72
2437	0.57	1.28	10.03	11.88	15.42	0.02	11.90	15.49
2462	0.74	1.28	10.03	12.05	16.03	0.02	12.07	16.11

11g 6 Mbps

Freq. [MHz]	Reading [dBm]	Cable Loss [dB]	Atten. Loss [dB]	Result (Frame power)		Duty factor [dB]	Result (Burst power)	
				[dBm]	[mW]		[dBm]	[mW]
2412	0.05	1.28	10.03	11.36	13.68	0.08	11.44	13.93
2437	4.66	1.28	10.03	15.97	39.54	0.08	16.05	40.27
2462	0.35	1.28	10.03	11.66	14.66	0.08	11.74	14.93

11n-20 MCS 0

Freq. [MHz]	Reading [dBm]	Cable Loss [dB]	Atten. Loss [dB]	Result (Frame power)		Duty factor [dB]	Result (Burst power)	
				[dBm]	[mW]		[dBm]	[mW]
2412	-0.05	1.28	10.03	11.26	13.37	0.09	11.35	13.65
2437	4.71	1.28	10.03	16.02	39.99	0.09	16.11	40.83
2462	0.27	1.28	10.03	11.58	14.39	0.09	11.67	14.69

Sample Calculation:

Result (Frame power) = Reading + Cable Loss (including the cable(s) customer supplied) + Attenuator

Result (Burst power) = Frame power + Duty factor

*The equipment and cables were not used for factor 0 dB of the data sheets.

Average Output Power
(Reference data)

Test place : Kashima EMC Lab. No.2 Measurement Room
Report No. : 11242579M
Date : May 27, 2016
Temperature / Humidity : 23 deg. C / 41 % RH
Engineer : Kazuhiro Ando
Mode : Tx

2437 MHz

Mode	Rate Mbps	Reading [dBm]	Duty factor [dB]	Burst power [dBm]	Remarks
11b	1	0.56	0.01	0.57	
	2	0.57	0.02	0.59	*
	5.5	0.55	0.06	0.61	
	11	0.37	0.10	0.47	
11g	6	4.66	0.09	4.75	*
	9	4.56	0.13	4.69	
	12	4.08	0.17	4.25	
	18	3.97	0.25	4.22	
	24	2.04	0.32	2.36	
	36	1.89	0.45	2.34	
	48	1.82	0.56	2.38	
	54	1.75	0.64	2.39	

* Worst rate

Sample Calculation:

$$\text{Burst power} = \text{Reading (timed average)} + \text{Duty factor}$$

All comparison were carried out on same frequency and measurement factors.

2437 MHz

Mode	Rate MCS	Reading [dBm]	Duty factor [dB]	Burst power [dBm]	Remarks
11n-20	0	4.71	0.09	4.80	*
	1	4.18	0.17	4.35	
	2	4.04	0.25	4.29	
	3	2.11	0.33	2.44	
	4	2.06	0.47	2.53	
	5	1.86	0.57	2.43	
	6	1.86	0.62	2.48	
	7	0.83	0.68	1.51	

* Worst rate

Sample Calculation:

$$\text{Burst power} = \text{Reading (timed average)} + \text{Duty factor}$$

All comparison were carried out on same frequency and measurement factors.

UL Japan, Inc.

Kashima EMC Lab.

1614, Mushiata, Katori-shi, Chiba-ken, 289-0341 Japan

Telephone : +81-478-88-6500

Facsimile : +81-478-82-3373

Burst rate confirmation

Test place : Kashima EMC Lab. No.2 Measurement Room
Report No. : 11242579M
Date : May 27, 2016
Temperature / Humidity : 23 deg. C / 41 % RH
Engineer : Kazuhiro Ando
Mode : Tx

11b 2 Mbps

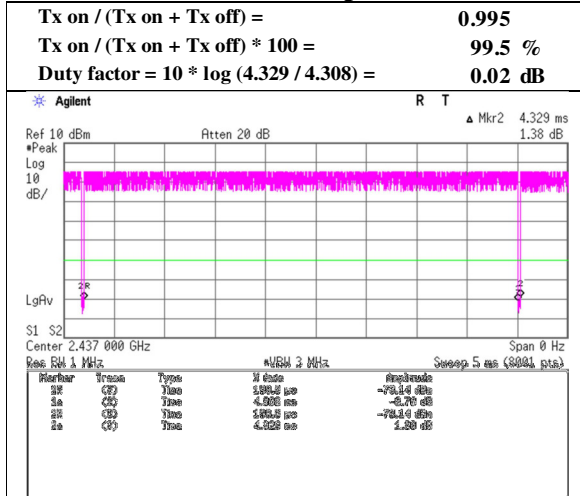

11g 6 Mbps

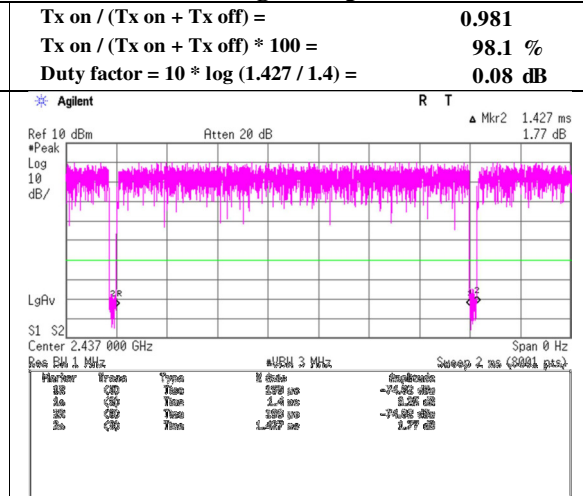

11n-20 MCS 0

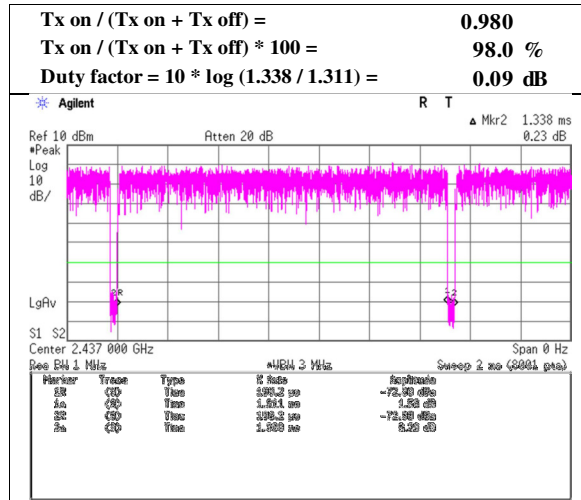

Radiated Spurious Emission

Test place	Kashima EMC Lab. No.10,6 Semi Anechoic Chamber		
Report No.	11242579M		
Date	May 20, 2016	May 12, 2016	May 16, 2016
Temperature / Humidity	24 deg. C / 49 % RH	21 deg. C / 47 % RH	24 deg. C / 49 % RH
Engineer	Kazuhiro Ando	Kazuhiro Ando	Kazuhiro Ando
	(1-10GHz) (AC10)	(10-18GHz) (AC10)	(18-26.5GHz) (AC6)
Mode	Tx 11b 2412 MHz		

Polarity	Frequency [MHz]	Detector	Reading [dBuV]	Ant.Fac. [dB/m]	Loss [dB]	Gain [dB]	Distance Factor [dB]	Result [dBuV/m]	Limit [dBuV/m]	Margin [dB]	Height [cm]	Angle [deg]	Remark
Hori.	2390.000	PK	50.6	27.6	13.9	44.4	3.5	51.2	73.9	22.7	188	220	
Hori.	4824.000	PK	58.8	31.3	6.2	46.1	3.5	53.7	73.9	20.2	170	217	
Hori.	7236.000	PK	50.0	36.3	7.7	44.6	3.5	52.9	73.9	21.0	150	0	Floor noise
Hori.	19296.000	PK	52.1	40.4	6.2	46.0	-9.5	43.2	73.9	30.7	163	174	
Hori.	24120.000	PK	49.1	40.2	7.0	47.5	-9.5	39.3	73.9	34.6	155	180	
Hori.	2390.000	AV	41.7	27.6	13.9	44.4	3.5	42.3	53.9	11.6	188	220	
Hori.	4824.000	AV	53.4	31.3	6.2	46.1	3.5	48.3	53.9	5.6	170	217	
Hori.	7236.000	AV	40.3	36.3	7.7	44.6	3.5	43.2	53.9	10.7	150	0	Floor noise
Hori.	19296.000	AV	51.3	40.4	6.2	46.0	-9.5	42.4	53.9	11.5	163	174	
Hori.	24120.000	AV	48.7	40.2	7.0	47.5	-9.5	38.9	53.9	15.0	155	180	
Vert.	2390.000	PK	50.4	27.6	13.9	44.4	3.5	51.0	73.9	22.9	194	118	
Vert.	4824.000	PK	56.3	31.3	6.2	46.1	3.5	51.2	73.9	22.7	182	203	
Vert.	7236.000	PK	48.5	36.3	7.7	44.6	3.5	51.4	73.9	22.5	150	0	Floor noise
Vert.	19296.000	PK	51.1	40.4	6.2	46.0	-9.5	42.2	73.9	31.7	155	186	
Vert.	24120.000	PK	50.5	40.2	7.0	47.5	-9.5	40.7	73.9	33.2	150	180	
Vert.	2390.000	AV	41.3	27.6	13.9	44.4	3.5	41.9	53.9	12.0	194	118	
Vert.	4824.000	AV	51.4	31.3	6.2	46.1	3.5	46.3	53.9	7.6	182	203	
Vert.	7236.000	AV	40.3	36.3	7.7	44.6	3.5	43.2	53.9	10.7	150	0	Floor noise
Vert.	19296.000	AV	49.5	40.4	6.2	46.0	-9.5	40.6	53.9	13.3	155	186	
Vert.	24120.000	AV	49.5	40.2	7.0	47.5	-9.5	39.7	53.9	14.2	150	180	

Result = Reading + Ant.Fac. + Loss (Cable+(Attenuator or Filter)(below 18 GHz)) - Gain(Amplifier) + Distance factor

Distance factor : 1 GHz - 10 GHz : 20log (4.5 m / 3.0 m) = 3.5 dB

10 GHz - 26.5 GHz : 20log (1.0 m / 3.0 m) = -9.5 dB

20 dBc Data Sheet (RBW 100 kHz, VBW 300 kHz)

Polarity	Frequency [MHz]	Detector	Reading [dBuV]	Ant.Fac. [dB/m]	Loss [dB]	Gain [dB]	Distance Factor [dB]	Result [dBuV/m]	Limit [dBuV/m]	Margin [dB]	Remark
Hori.	2412.000	PK	97.0	27.6	14.0	44.4	3.5	97.7	-	-	Carrier
Hori.	2400.000	PK	46.1	27.6	13.9	44.4	3.5	46.7	77.7	31.0	
Vert.	2412.000	PK	96.5	27.6	14.0	44.4	3.5	97.2	-	-	Carrier
Vert.	2400.000	PK	45.8	27.6	13.9	44.4	3.5	46.4	77.2	30.8	

Result = Reading + Ant.Fac. + Loss (Cable+(Attenuator or Filter)(below 18 GHz)) - Gain(Amplifier) + Distance factor

Distance factor : 1 GHz - 10 GHz : 20log (4.5 m / 3.0 m) = 3.5 dB

10 GHz - 26.5 GHz : 20log (1.0 m / 3.0 m) = -9.5 dB

UL Japan, Inc.

Kashima EMC Lab.

1614, Mushihata, Katori-shi, Chiba-ken, 289-0341 Japan

Telephone : +81-478-88-6500

Facsimile : +81-478-82-3373

Radiated Spurious Emission
(Reference Plot for band-edge)

Test place : Kashima EMC Lab. No.10 Semi Anechoic Chamber
 Report No. : 11242579M
 Date : May 20, 2016
 Temperature / Humidity : 24 deg. C / 49 % RH
 Engineer : Kazuhiro Ando
 (1-10GHz)
 Mode : Tx 11b 2412 MHz

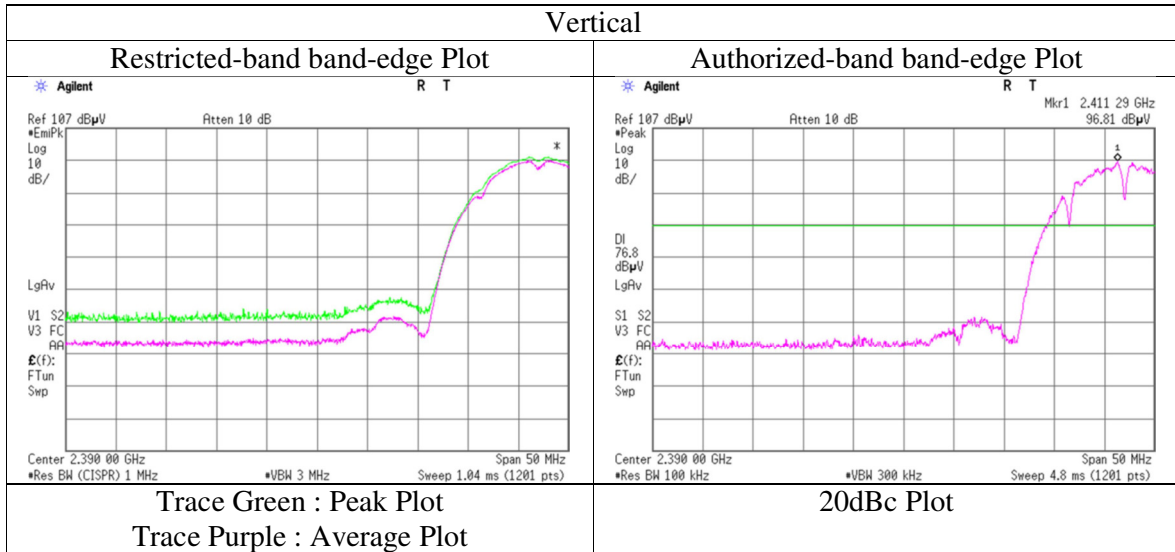
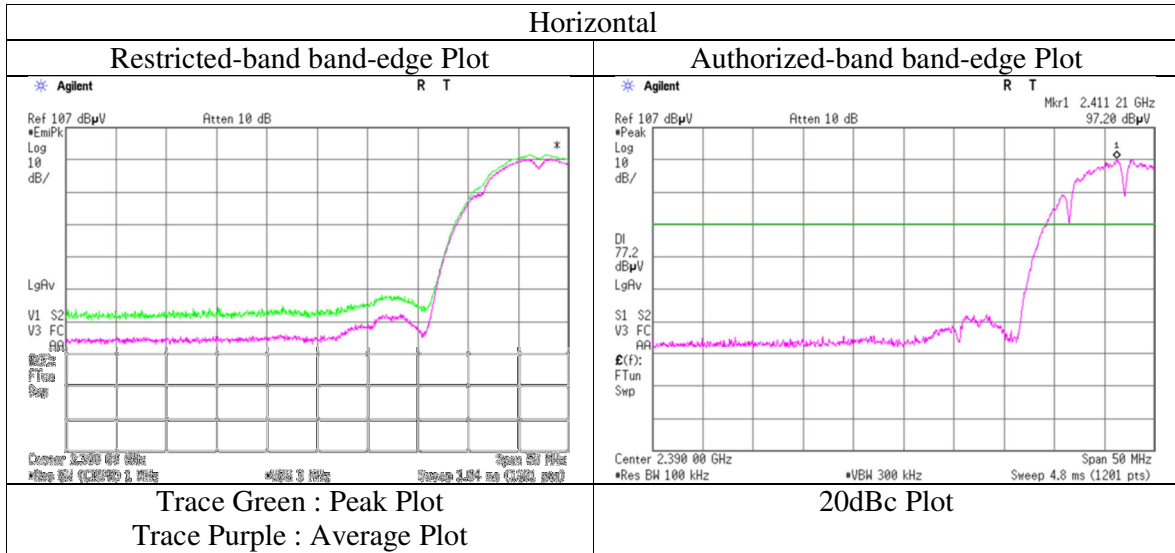

* Final result of restricted band edge was shown in tabular data.

Radiated Spurious Emission

Test place	Kashima EMC Lab. No.10,6 Semi Anechoic Chamber		
Report No.	11242579M		
Date	May 20, 2016	May 12, 2016	May 16, 2016
Temperature / Humidity	24 deg. C / 49 % RH	21 deg. C / 47 % RH	24 deg. C / 49 % RH
Engineer	Kazuhiro Ando	Kazuhiro Ando	Kazuhiro Ando
	(1-10GHz) (AC10)	(10-18GHz) (AC10)	(18-26.5GHz) (AC6)
Mode	Tx 11b 2437 MHz		

Polarity	Frequency [MHz]	Detector	Reading [dBuV]	Ant.Fac. [dB/m]	Loss [dB]	Gain [dB]	Distance Factor [dB]	Result [dBuV/m]	Limit [dBuV/m]	Margin [dB]	Height [cm]	Angle [deg]	Remark
Hori.	4874.000	PK	59.5	31.2	6.4	46.1	3.5	54.5	73.9	19.4	180	227	
Hori.	7311.000	PK	48.0	36.4	7.9	44.5	3.5	51.3	73.9	22.6	150	0	Floor noise
Hori.	19496.000	PK	51.7	40.4	6.3	46.1	-9.5	42.8	73.9	31.1	158	178	
Hori.	24370.000	PK	50.5	40.2	7.0	47.4	-9.5	40.8	73.9	33.1	160	184	
Hori.	4874.000	AV	54.4	31.2	6.4	46.1	3.5	49.4	53.9	4.5	180	227	
Hori.	7311.000	AV	39.9	36.4	7.9	44.5	3.5	43.2	53.9	10.7	150	0	Floor noise
Hori.	19496.000	AV	51.2	40.4	6.3	46.1	-9.5	42.3	53.9	11.6	158	178	
Hori.	24370.000	AV	49.3	40.2	7.0	47.4	-9.5	39.6	53.9	14.3	160	184	
Vert.	4874.000	PK	57.2	31.2	6.4	46.1	3.5	52.2	73.9	21.7	197	201	
Vert.	7311.000	PK	48.3	36.4	7.9	44.5	3.5	51.6	73.9	22.3	150	0	Floor noise
Vert.	19496.000	PK	52.0	40.4	6.3	46.1	-9.5	43.1	73.9	30.8	153	184	
Vert.	24370.000	PK	49.8	40.2	7.0	47.4	-9.5	40.1	73.9	33.8	150	193	
Vert.	4874.000	AV	53.0	31.2	6.4	46.1	3.5	48.0	53.9	5.9	197	201	
Vert.	7311.000	AV	39.5	36.4	7.9	44.5	3.5	42.8	53.9	11.1	150	0	Floor noise
Vert.	19496.000	AV	51.0	40.4	6.3	46.1	-9.5	42.1	53.9	11.8	153	184	
Vert.	24370.000	AV	48.7	40.2	7.0	47.4	-9.5	39.0	53.9	14.9	150	193	

Result = Reading + Ant.Fac. + Loss (Cable+(Attenuator or Filter)(below 18 GHz)) - Gain(Amplifier) + Distance factor

Distance factor : 1 GHz - 10 GHz : 20log (4.5 m / 3.0 m) = 3.5 dB

10 GHz - 26.5 GHz : 20log (1.0 m / 3.0 m) = -9.5 dB

Radiated Spurious Emission

Test place	Kashima EMC Lab. No.10,11 Semi Anechoic Chamber		
Report No.	11242579M		
Date	May 19, 2016	May 28, 2016	May 28, 2016
Temperature / Humidity	23 deg. C / 56 % RH	22 deg. C / 55 % RH	22 deg. C / 55 % RH
Engineer	Kazuhiro Ando (1-10GHz) (AC10)	Kazuhiro Ando (10-18GHz) (AC11)	Kazuhiro Ando (18-26.5GHz) (AC11)
Mode	Tx 11b 2462 MHz		

Polarity	Frequency [MHz]	Detector	Reading [dBuV]	Ant.Fac. [dB/m]	Loss [dB]	Gain [dB]	Distance Factor [dB]	Result [dBuV/m]	Limit [dBuV/m]	Margin [dB]	Height [cm]	Angle [deg]	Remark
Hori.	2483.500	PK	50.5	27.5	14.0	44.3	3.5	51.2	73.9	22.7	155	215	
Hori.	4924.000	PK	60.0	31.3	6.4	46.1	3.5	55.1	73.9	18.8	163	0	
Hori.	7386.000	PK	48.5	36.7	7.9	44.3	3.5	52.3	73.9	21.6	150	0	Floor noise
Hori.	19696.000	PK	48.0	40.2	6.3	46.2	-9.5	38.8	73.9	35.1	150	171	
Hori.	24620.000	PK	46.7	40.3	7.0	47.4	-9.5	37.1	73.9	36.8	150	175	
Hori.	2483.500	AV	42.0	27.5	14.0	44.3	3.5	42.7	53.9	11.2	155	215	
Hori.	4924.000	AV	56.3	31.3	6.4	46.1	3.5	51.4	53.9	2.5	163	0	
Hori.	7386.000	AV	40.0	36.7	7.9	44.3	3.5	43.8	53.9	10.1	150	0	Floor noise
Hori.	19696.000	AV	43.8	40.2	6.3	46.2	-9.5	34.6	53.9	19.3	150	171	
Hori.	24620.000	AV	41.5	40.3	7.0	47.4	-9.5	31.9	53.9	22.0	150	175	
Vert.	2483.500	PK	51.5	27.5	14.0	44.3	3.5	52.2	73.9	21.7	167	135	
Vert.	4924.000	PK	60.7	31.3	6.4	46.1	3.5	55.8	73.9	18.1	153	202	
Vert.	7386.000	PK	41.0	36.7	7.9	44.3	3.5	44.8	73.9	29.1	150	0	Floor noise
Vert.	19696.000	PK	48.7	40.2	6.3	46.2	-9.5	39.5	73.9	34.4	150	157	
Vert.	24620.000	PK	47.5	40.3	7.0	47.4	-9.5	37.9	73.9	36.0	150	200	
Vert.	2483.500	AV	41.5	27.5	14.0	44.3	3.5	42.2	53.9	11.7	167	135	
Vert.	4924.000	AV	57.9	31.3	6.4	46.1	3.5	53.0	53.9	0.9	153	202	
Vert.	7386.000	AV	39.8	36.7	7.9	44.3	3.5	43.6	53.9	10.3	150	0	Floor noise
Vert.	19696.000	AV	45.0	40.2	6.3	46.2	-9.5	35.8	53.9	18.1	150	157	
Vert.	24620.000	AV	42.3	40.3	7.0	47.4	-9.5	32.7	53.9	21.2	150	200	

Result = Reading + Ant.Fac. + Loss (Cable+(Attenuator or Filter)(below 18 GHz)) - Gain(Amplifier) + Distance factor

Distance factor : 1 GHz - 10 GHz : 20log (4.5 m / 3.0 m) = 3.5 dB

10 GHz - 26.5 GHz : 20log (1.0 m / 3.0 m) = -9.5 dB

UL Japan, Inc.

Kashima EMC Lab.

1614, Mushihata, Katori-shi, Chiba-ken, 289-0341 Japan

Telephone : +81-478-88-6500

Facsimile : +81-478-82-3373

Radiated Spurious Emission
(Reference Plot for band-edge)

Test place	Kashima EMC Lab. No.10 Semi Anechoic Chamber
Report No.	11242579M
Date	May 19, 2016
Temperature / Humidity	23 deg. C / 56 % RH
Engineer	Kazuhiro Ando (1-10GHz) (AC10)
Mode	Tx 11b 2462 MHz

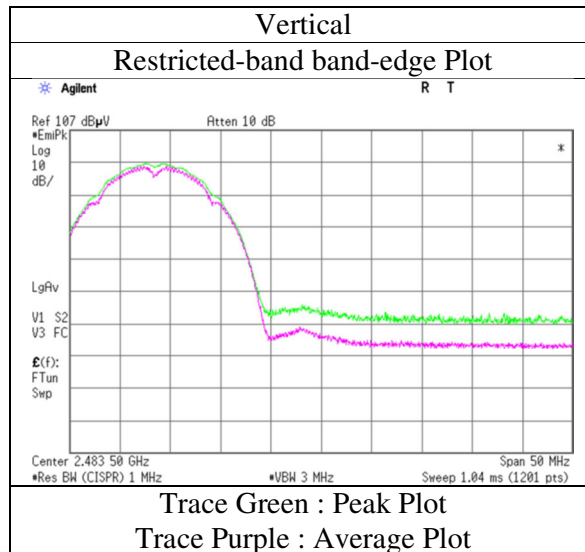
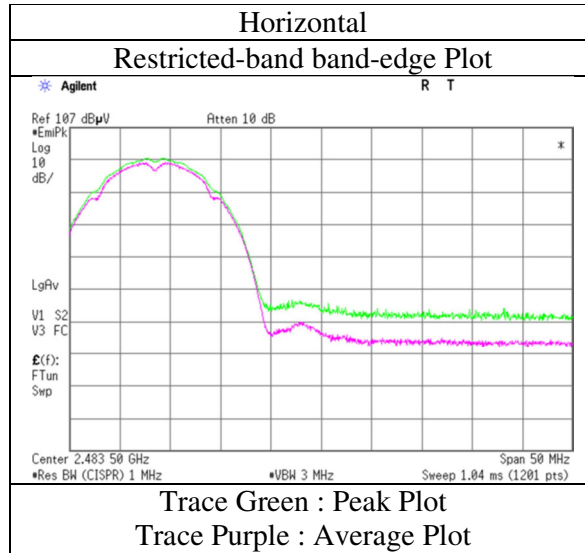

* Final result of restricted band edge was shown in tabular data.

Radiated Spurious Emission

Test place : Kashima EMC Lab. No.10 Semi Anechoic Chamber
Report No. : 11242579M
Date : May 20, 2016 May 12, 2016 May 16, 2016
Temperature / Humidity : 24 deg. C / 49 % RH 21 deg. C / 47 % RH 24 deg. C / 49 % RH
Engineer : Kazuhiro Ando Kazuhiro Ando Kazuhiro Ando
 (1-10GHz) (AC10) (10-18GHz) (AC10) (18-26.5GHz) (AC6)
Mode : Tx 11g 2412 MHz

Polarity	Frequency [MHz]	Detector	Reading [dBuV]	Ant.Fac. [dB/m]	Loss [dB]	Gain [dB]	Distance Factor [dB]	Result [dBuV/m]	Limit [dBuV/m]	Margin [dB]	Height [cm]	Angle [deg]	Remark
Hori.	2390.000	PK	68.0	27.6	13.9	44.4	3.5	68.6	73.9	5.3	160	210	
Hori.	2390.000	AV	52.7	27.6	13.9	44.4	3.5	53.3	53.9	0.6	160	210	
Vert.	2390.000	PK	67.8	27.6	13.9	44.4	3.5	68.4	73.9	5.5	160	127	
Vert.	2390.000	AV	52.6	27.6	13.9	44.4	3.5	53.2	53.9	0.7	160	127	

Result = Reading + Ant.Fac. + Loss (Cable+(Attenuator or Filter)(below 18 GHz)) - Gain(Amplifier) + Distance factor
Distance factor : 1 GHz - 10 GHz : $20\log(4.5\text{ m} / 3.0\text{ m}) = 3.5\text{ dB}$
10 GHz - 26.5 GHz : $20\log(1.0\text{ m} / 3.0\text{ m}) = -9.5\text{ dB}$

20 dBc Data Sheet (RBW 100 kHz, VBW 300 kHz)

Polarity	Frequency [MHz]	Detector	Reading [dBuV]	Ant.Fac. [dB/m]	Loss [dB]	Gain [dB]	Distance Factor [dB]	Result [dBuV/m]	Limit [dBuV/m]	Margin [dB]	Remark
Hori.	2412.000	PK	98.0	27.6	14.0	44.4	3.5	98.7	-	-	Carrier
Hori.	2400.000	PK	68.5	27.6	13.9	44.4	3.5	69.1	78.7	9.6	
Vert.	2412.000	PK	97.5	27.6	14.0	44.4	3.5	98.2	-	-	Carrier
Vert.	2400.000	PK	68.4	27.6	13.9	44.4	3.5	69.0	78.2	9.2	

Result = Reading + Ant.Fac. + Loss (Cable+(Attenuator or Filter)(below 18 GHz)) - Gain(Amplifier) + Distance factor
Distance factor : 1 GHz - 10 GHz : $20\log(4.5\text{ m} / 3.0\text{ m}) = 3.5\text{ dB}$
10 GHz - 26.5 GHz : $20\log(1.0\text{ m} / 3.0\text{ m}) = -9.5\text{ dB}$

*This mode was performed only band edge measurement.

UL Japan, Inc.

Kashima EMC Lab.

1614, Mushihata, Katori-shi, Chiba-ken, 289-0341 Japan

Telephone : +81-478-88-6500

Facsimile : +81-478-82-3373

Radiated Spurious Emission
(Reference Plot for band-edge)

Test place	Kashima EMC Lab. No.10 Semi Anechoic Chamber
Report No.	11242579M
Date	May 20, 2016
Temperature / Humidity	24 deg. C / 49 % RH
Engineer	Kazuhiro Ando
	(1-10GHz) (AC10)
Mode	Tx 11g 2412 MHz

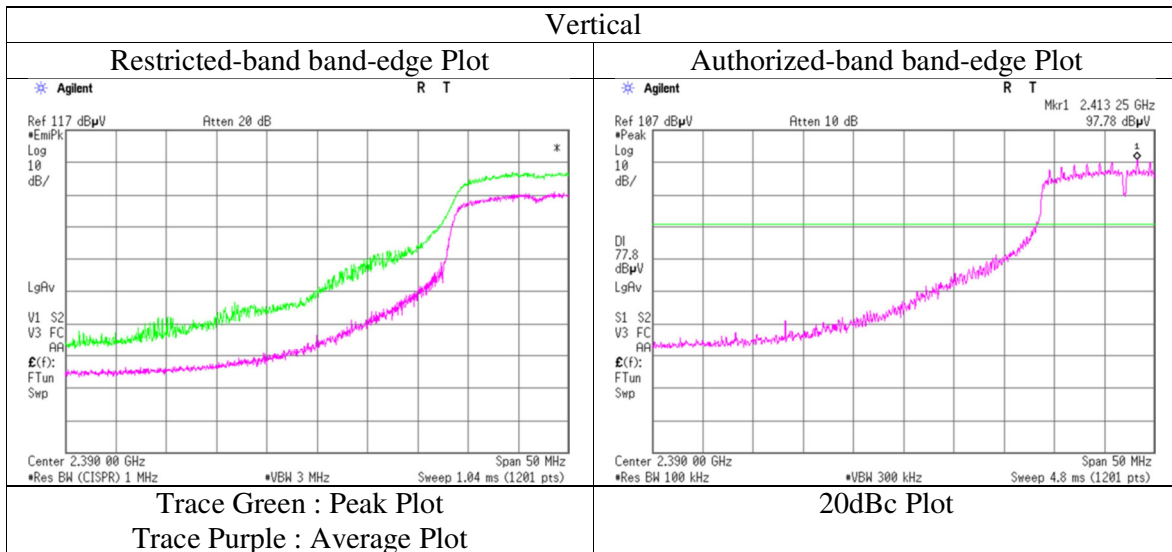
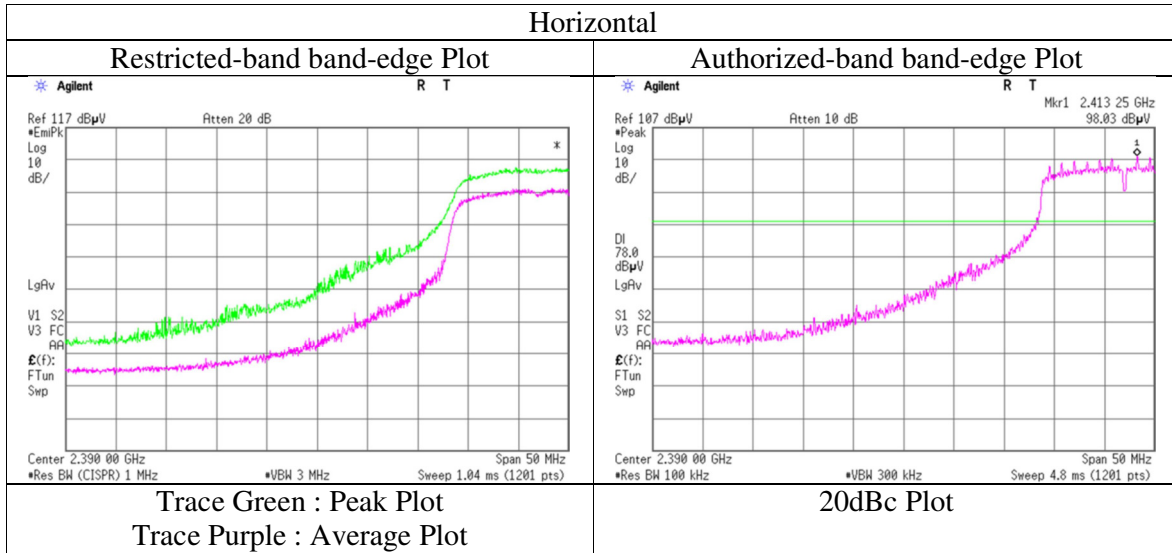

* Final result of restricted band edge was shown in tabular data.

Radiated Spurious Emission

Test place : Kashima EMC Lab. No.10 Semi Anechoic Chamber
Report No. : 11242579M
Date : May 20, 2016
Temperature / Humidity : 24 deg. C / 49 % RH
Engineer : Kazuhiro Ando
(1-10GHz) (AC10)
Mode : Tx 11g 2462 MHz

Polarity	Frequency [MHz]	Detector	Reading [dBuV]	Ant.Fac. [dB/m]	Loss [dB]	Gain [dB]	Distance Factor [dB]	Result [dBuV/m]	Limit [dBuV/m]	Margin [dB]	Height [cm]	Angle [deg]	Remark
Hori.	2483.500	PK	70.1	27.5	14.0	44.3	3.5	70.8	73.9	3.1	160	220	
Hori.	2483.500	AV	51.4	27.5	14.0	44.3	3.5	52.1	53.9	1.8	160	220	
Vert.	2483.500	PK	69.3	27.5	14.0	44.3	3.5	70.0	73.9	3.9	150	215	
Vert.	2483.500	AV	51.0	27.5	14.0	44.3	3.5	51.7	53.9	2.2	150	215	

Result = Reading + Ant.Fac. + Loss (Cable+(Attenuator or Filter)(below 18 GHz)) - Gain(Amplifier) + Distance factor

Distance factor : 1 GHz - 10 GHz : $20\log(4.5\text{ m} / 3.0\text{ m}) = 3.5\text{ dB}$

10 GHz - 26.5 GHz : $20\log(1.0\text{ m} / 3.0\text{ m}) = -9.5\text{ dB}$

*This mode was performed only band edge measurement.

Radiated Spurious Emission
(Reference Plot for band-edge)

Test place : Kashima EMC Lab. No.10 Semi Anechoic Chamber
Report No. : 11242579M
Date : May 20, 2016
Temperature / Humidity : 24 deg. C / 49 % RH
Engineer : Kazuhiro Ando
(1-10GHz) (AC10)
Mode : Tx 11g 2462 MHz

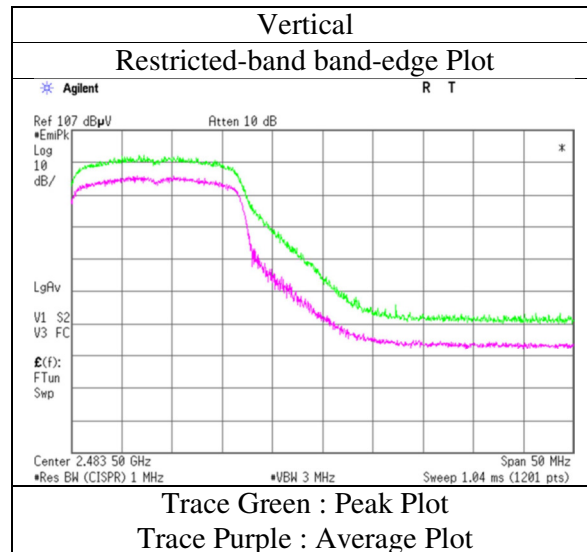
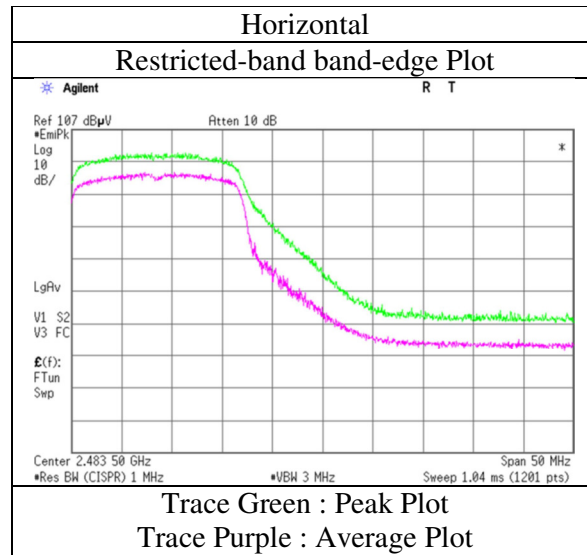

* Final result of restricted band edge was shown in tabular data.

Radiated Spurious Emission

Test place : Kashima EMC Lab. No.10,6 Semi Anechoic Chamber
Report No. : 11242579M
Date : May 20, 2016 May 12, 2016 May 16, 2016
Temperature / Humidity : 24 deg. C / 49 % RH 21 deg. C / 47 % RH 24 deg. C / 49 % RH
Engineer : Kazuhiro Ando Kazuhiro Ando Kazuhiro Ando
 (1-10GHz) (AC10) (10-18GHz) (AC10) (18-26.5GHz) (AC6)
Mode : Tx 11n-20 2412 MHz

Polarity	Frequency [MHz]	Detector	Reading [dBuV]	Ant.Fac. [dB/m]	Loss [dB]	Gain [dB]	Distance Factor [dB]	Result [dBuV/m]	Limit [dBuV/m]	Margin [dB]	Height [cm]	Angle [deg]	Remark
Hori.	2390.000	PK	70.3	27.6	14.0	44.4	3.5	71.0	73.9	2.9	195	210	
Hori.	2493.235	PK	53.8	27.5	14.1	44.3	3.5	54.6	73.9	19.3	150	215	
Hori.	4824.000	PK	63.0	31.3	6.1	46.1	3.5	57.8	73.9	16.1	150	240	
Hori.	7236.000	PK	48.6	36.3	7.5	44.6	3.5	51.3	73.9	22.6	150	0	Floor noise
Hori.	19296.000	PK	51.7	40.4	6.2	46.0	-9.5	42.8	73.9	31.1	159	176	
Hori.	24120.000	PK	49.5	40.2	7.0	47.5	-9.5	39.7	73.9	34.2	158	180	
Hori.	2390.000	AV	52.5	27.6	14.0	44.4	3.5	53.2	53.9	0.7	195	210	
Hori.	2493.235	AV	41.6	27.5	14.1	44.3	3.5	42.4	53.9	11.5	150	215	
Hori.	4824.000	AV	55.5	31.3	6.1	46.1	3.5	50.3	53.9	3.6	150	240	
Hori.	7236.000	AV	40.8	36.3	7.5	44.6	3.5	43.5	53.9	10.4	150	0	Floor noise
Hori.	19296.000	AV	51.3	40.4	6.2	46.0	-9.5	42.4	53.9	11.5	159	176	
Hori.	24120.000	AV	49.0	40.2	7.0	47.5	-9.5	39.2	53.9	14.7	158	180	
Vert.	2390.000	PK	69.0	27.6	14.0	44.4	3.5	69.7	73.9	4.2	180	130	
Vert.	2537.020	PK	42.6	27.5	14.1	44.3	3.5	43.4	73.9	30.5	150	240	
Vert.	4824.000	PK	60.7	31.3	6.1	46.1	3.5	55.5	73.9	18.4	150	210	
Vert.	7236.000	PK	49.4	36.3	7.5	44.6	3.5	52.1	73.9	21.8	150	0	Floor noise
Vert.	19296.000	PK	50.8	40.4	6.2	46.0	-9.5	41.9	73.9	32.0	100	159	
Vert.	24120.000	PK	51.7	40.2	7.0	47.5	-9.5	41.9	73.9	32.0	100	196	
Vert.	2390.000	AV	49.8	27.6	14.0	44.4	3.5	50.5	53.9	3.4	180	130	
Vert.	2537.020	AV	41.0	27.5	14.1	44.3	3.5	41.8	53.9	12.1	150	240	
Vert.	4824.000	AV	51.0	31.3	6.1	46.1	3.5	45.8	53.9	8.1	150	210	
Vert.	7236.000	AV	40.9	36.3	7.5	44.6	3.5	43.6	53.9	10.3	150	0	Floor noise
Vert.	19296.000	AV	49.3	40.4	6.2	46.0	-9.5	40.4	53.9	13.5	100	159	
Vert.	24120.000	AV	50.5	40.2	7.0	47.5	-9.5	40.7	53.9	13.2	100	196	

Result = Reading + Ant.Fac. + Loss (Cable+(Attenuator or Filter)(below 18 GHz)) - Gain(Amplifier) + Distance factor

Distance factor : 1 GHz - 10 GHz : 20log (4.5 m / 3.0 m) = 3.5 dB

10 GHz - 26.5 GHz : 20log (1.0 m / 3.0 m) = -9.5 dB

20 dBc Data Sheet (RBW 100 kHz, VBW 300 kHz)

Polarity	Frequency [MHz]	Detector	Reading [dBuV]	Ant.Fac. [dB/m]	Loss [dB]	Gain [dB]	Distance Factor [dB]	Result [dBuV/m]	Limit [dBuV/m]	Margin [dB]	Remark
Hori.	2412.000	PK	97.3	27.6	14.1	44.4	3.5	98.1	-	-	Carrier
Hori.	2400.000	PK	69.7	27.6	14.0	44.4	3.5	70.4	78.1	7.7	
Vert.	2412.000	PK	96.3	27.6	14.1	44.4	3.5	97.1	-	-	Carrier
Vert.	2400.000	PK	69.4	27.6	14.0	44.4	3.5	70.1	77.1	7.0	

Result = Reading + Ant.Fac. + Loss (Cable+(Attenuator or Filter)(below 18 GHz)) - Gain(Amplifier) + Distance factor

Distance factor : 1 GHz - 10 GHz : 20log (4.5 m / 3.0 m) = 3.5 dB

10 GHz - 26.5 GHz : 20log (1.0 m / 3.0 m) = -9.5 dB

Radiated Spurious Emission
(Reference Plot for band-edge)

Test place	Kashima EMC Lab. No.10 Semi Anechoic Chamber
Report No.	11242579M
Date	May 20, 2016
Temperature / Humidity	24 deg. C / 49 % RH
Engineer	Kazuhiro Ando (1-10GHz) (AC10)
Mode	Tx 11n-20 2412 MHz

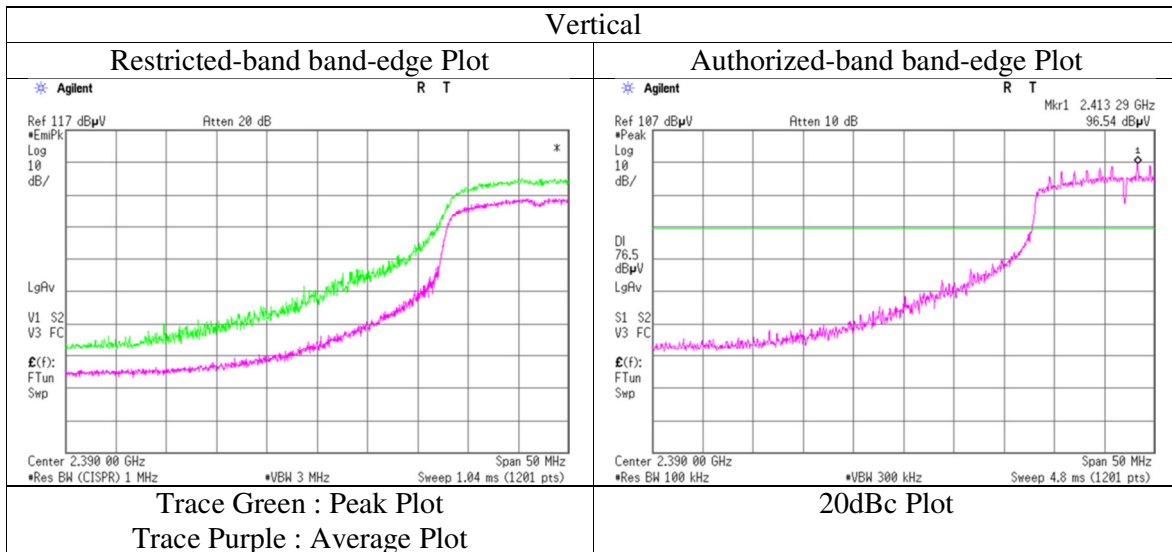
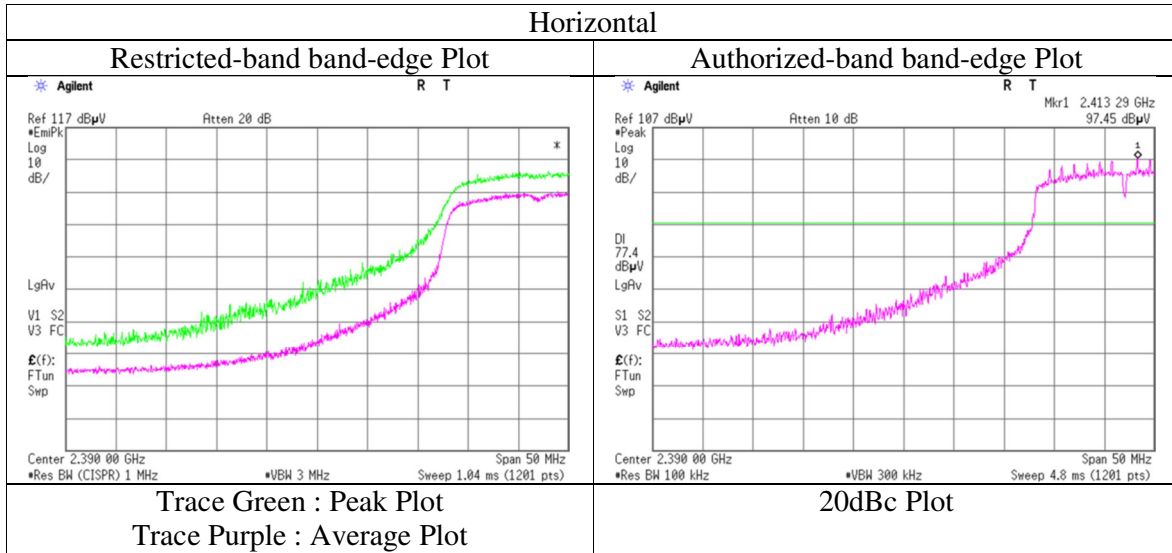

* Final result of restricted band edge was shown in tabular data.

Radiated Spurious Emission

Test place Kashima EMC Lab. No.10,6 Semi Anechoic Chamber
Report No. 11242579M
Date May 22, 2016 May 20, 2016 May 12, 2016 May 16, 2016
Temperature / Humidity 22 deg. C / 45 % RH 24 deg. C / 49 % RH 21 deg. C / 47 % RH 24 deg. C / 49 % RH
Engineer Kazuhiro Ando Kazuhiro Ando Kazuhiro Ando Kazuhiro Ando
 (30-1000MHz) (AC10) (1-10GHz) (AC10) (10-18GHz) (AC10) (18-26.5GHz) (AC6)
Mode Tx 11n-20 2437 MHz

Polarity	Frequency [MHz]	Detector	Reading [dBuV]	Ant.Fac. [dB/m]	Loss [dB]	Gain [dB]	Distance Factor [dB]	Result [dBuV/m]	Limit [dBuV/m]	Margin [dB]	Height [cm]	Angle [deg]	Remark
Hori.	182.832	QP	38.2	11.3	5.3	32.4	0.0	22.4	43.5	21.1	100	0	
Hori.	560.762	QP	35.8	19.1	7.2	32.3	0.0	29.8	46.0	16.2	130	165	
Hori.	4874.000	PK	65.3	31.2	6.2	46.1	3.5	60.1	73.9	13.8	130	240	
Hori.	7311.000	PK	48.3	36.4	7.8	44.5	3.5	51.5	73.9	22.4	150	0	Floor noise
Hori.	19496.000	PK	51.5	40.4	6.3	46.1	-9.5	42.6	73.9	31.3	154	181	
Hori.	24370.000	PK	50.0	40.2	7.0	47.4	-9.5	40.3	73.9	33.6	160	180	
Hori.	4874.000	AV	56.1	31.2	6.2	46.1	3.5	50.9	53.9	3.0	130	240	
Hori.	7311.000	AV	40.1	36.4	7.8	44.5	3.5	43.3	53.9	10.6	150	0	Floor noise
Hori.	19496.000	AV	51.1	40.4	6.3	46.1	-9.5	42.2	53.9	11.7	154	181	
Hori.	24370.000	AV	48.5	40.2	7.0	47.4	-9.5	38.8	53.9	15.1	160	180	
Vert.	109.690	QP	46.2	10.1	4.7	32.4	0.0	28.6	43.5	14.9	100	280	
Vert.	182.832	QP	46.2	11.3	5.3	32.4	0.0	30.4	43.5	13.1	100	180	
Vert.	207.214	QP	43.2	10.1	5.4	32.4	0.0	26.3	43.5	17.2	100	0	
Vert.	512.000	QP	39.2	18.1	6.9	32.3	0.0	31.9	46.0	14.1	100	280	
Vert.	4874.000	PK	64.4	31.2	6.2	46.1	3.5	59.2	73.9	14.7	145	210	
Vert.	7311.000	PK	49.4	36.4	7.8	44.5	3.5	52.6	73.9	21.3	150	0	Floor noise
Vert.	19496.000	PK	50.8	40.4	6.3	46.1	-9.5	41.9	73.9	32.0	150	183	
Vert.	24370.000	PK	51.3	40.2	7.0	47.4	-9.5	41.6	73.9	32.3	150	180	
Vert.	4874.000	AV	53.5	31.2	6.2	46.1	3.5	48.3	53.9	5.6	145	210	
Vert.	7311.000	AV	40.2	36.4	7.8	44.5	3.5	43.4	53.9	10.5	150	0	Floor noise
Vert.	19496.000	AV	49.3	40.4	6.3	46.1	-9.5	40.4	53.9	13.5	150	183	
Vert.	24370.000	AV	49.7	40.2	7.0	47.4	-9.5	40.0	53.9	13.9	150	180	

Result = Reading + Ant.Fac. + Loss (Cable+(Attenuator or Filter)(below 18 GHz)) - Gain(Amplifier) + Distance factor

Distance factor : 1 GHz - 10 GHz : 20log (4.5 m / 3.0 m) = 3.5 dB

10 GHz - 26.5 GHz : 20log (1.0 m / 3.0 m) = -9.5 dB

Radiated Spurious Emission

Test place	Kashima EMC Lab. No.10,11 Semi Anechoic Chamber		
Report No.	11242579M		
Date	May 20, 2016	May 18, 2016	May 28, 2016
Temperature / Humidity	24 deg. C / 49 % RH	22 deg. C / 55 % RH	22 deg. C / 55 % RH
Engineer	Kazuhiro Ando	Kazuhiro Ando	Kazuhiro Ando
	(1-10GHz) (AC10)	(10-18GHz) (AC11)	(18-26.5GHz) (AC11)
Mode	Tx 11n-20 2462 MHz		

Polarity	Frequency [MHz]	Detector	Reading [dBuV]	Ant.Fac. [dB/m]	Loss [dB]	Gain [dB]	Distance Factor [dB]	Result [dBuV/m]	Limit [dBuV/m]	Margin [dB]	Height [cm]	Angle [deg]	Remark
Hori.	2483.500	PK	71.0	27.5	14.0	44.3	3.5	71.7	73.9	2.2	156	215	
Hori.	4924.000	PK	61.5	31.3	6.4	46.1	3.5	56.6	73.9	17.3	173	107	
Hori.	7386.000	PK	49.3	36.7	7.9	44.3	3.5	53.1	73.9	20.8	150	0	Floor noise
Hori.	19696.000	PK	48.5	40.2	6.3	46.2	-9.5	39.3	73.9	34.6	150	167	
Hori.	24620.000	PK	45.3	40.3	7.0	47.4	-9.5	35.7	73.9	38.2	150	180	
Hori.	2483.500	AV	52.7	27.5	14.0	44.3	3.5	53.4	53.9	0.5	156	215	
Hori.	4924.000	AV	51.5	31.3	6.4	46.1	3.5	46.6	53.9	7.3	173	107	
Hori.	7386.000	AV	40.3	36.7	7.9	44.3	3.5	44.1	53.9	9.8	150	0	Floor noise
Hori.	19696.000	AV	42.7	40.2	6.3	46.2	-9.5	33.5	53.9	20.4	150	167	
Hori.	24620.000	AV	39.3	40.3	7.0	47.4	-9.5	29.7	53.9	24.2	150	180	
Vert.	2483.500	PK	70.7	27.5	14.0	44.3	3.5	71.4	73.9	2.5	160	7	
Vert.	4924.000	PK	63.8	31.3	6.4	46.1	3.5	58.9	73.9	15.0	155	210	
Vert.	7386.000	PK	49.0	36.7	7.9	44.3	3.5	52.8	73.9	21.1	150	0	Floor noise
Vert.	19696.000	PK	47.7	40.2	6.3	46.2	-9.5	38.5	73.9	35.4	150	170	
Vert.	24620.000	PK	48.0	40.3	7.0	47.4	-9.5	38.4	73.9	35.5	150	200	
Vert.	2483.500	AV	51.7	27.5	14.0	44.3	3.5	52.4	53.9	1.5	160	7	
Vert.	4924.000	AV	54.3	31.3	6.4	46.1	3.5	49.4	53.9	4.5	155	210	
Vert.	7386.000	AV	40.0	36.7	7.9	44.3	3.5	43.8	53.9	10.1	150	0	Floor noise
Vert.	19696.000	AV	43.0	40.2	6.3	46.2	-9.5	33.8	53.9	20.1	150	170	
Vert.	24620.000	AV	42.3	40.3	7.0	47.4	-9.5	32.7	53.9	21.2	150	200	

Result = Reading + Ant.Fac. + Loss (Cable+(Attenuator or Filter)(below 18 GHz)) - Gain(Amplifier) + Distance factor

Distance factor : 1 GHz - 10 GHz : 20log (4.5 m / 3.0 m) = 3.5 dB

10 GHz - 26.5 GHz : 20log (1.0 m / 3.0 m) = -9.5 dB

UL Japan, Inc.

Kashima EMC Lab.

1614, Mushihata, Katori-shi, Chiba-ken, 289-0341 Japan

Telephone : +81-478-88-6500

Facsimile : +81-478-82-3373

Radiated Spurious Emission
(Reference Plot for band-edge)

Test place : Kashima EMC Lab. No.10 Semi Anechoic Chamber
Report No. : 11242579M
Date : May 20, 2016
Temperature / Humidity : 24 deg. C / 49 % RH
Engineer : Kazuhiro Ando
(1-10GHz) (AC10)
Mode : Tx 11n-20 2462 MHz

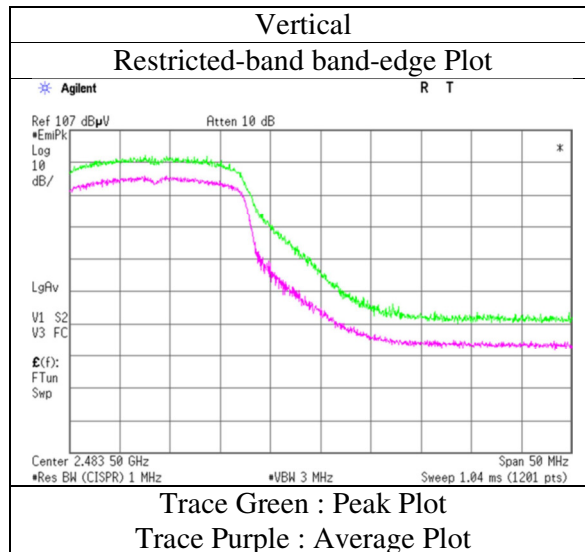
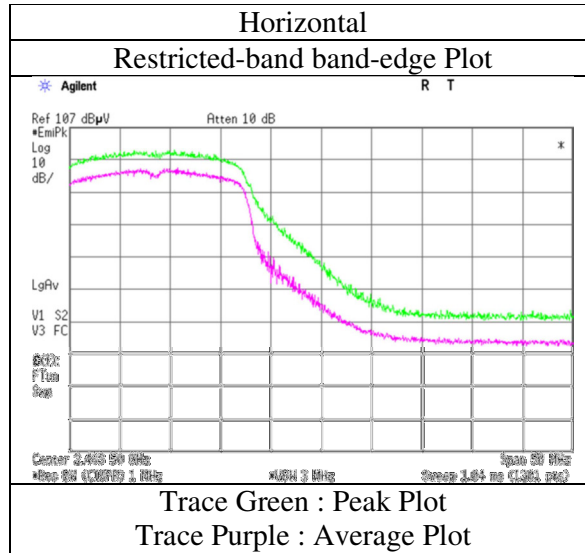

* Final result of restricted band edge was shown in tabular data.

Radiated Spurious Emission
(Plot data, Worst case)

Test place	Kashima EMC Lab. No.10,11 Semi Anechoic Chamber		
Report No.	11242579M		
Date	May 20, 2016	May 28, 2016	May 28, 2016
Temperature / Humidity	24 deg. C / 49 % RH	22 deg. C / 55 % RH	22 deg. C / 55 % RH
Engineer	Kazuhiro Ando	Kazuhiro Ando	Kazuhiro Ando
	(1-10GHz) (AC10)	(10-18GHz) (AC10)	(18-26.5GHz) (AC11)
Mode	Tx 11n-20 2462 MHz		

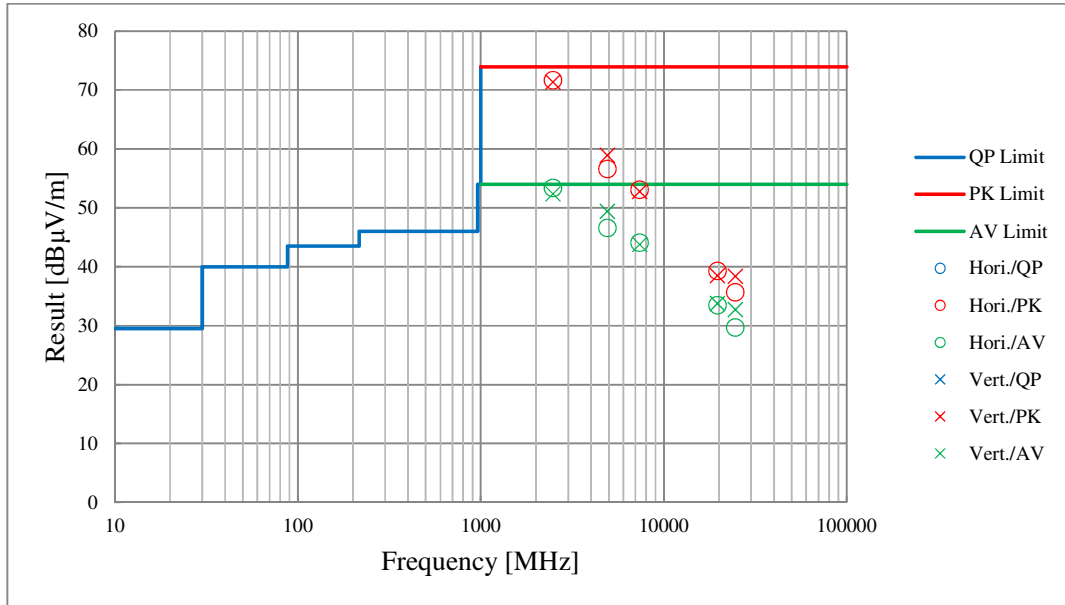

*These plots data contains sufficient number to show the trend of characteristic features for EUT.

Conducted Spurious Emission

Test place	Kashima EMC Lab. No.2 Measurement Room
Report No.	11242579M
Date	May 27, 2016
Temperature / Humidity	23 deg. C / 41 % RH
Engineer	Kazuhiro Ando
Mode	Tx 11n-20 2437 MHz

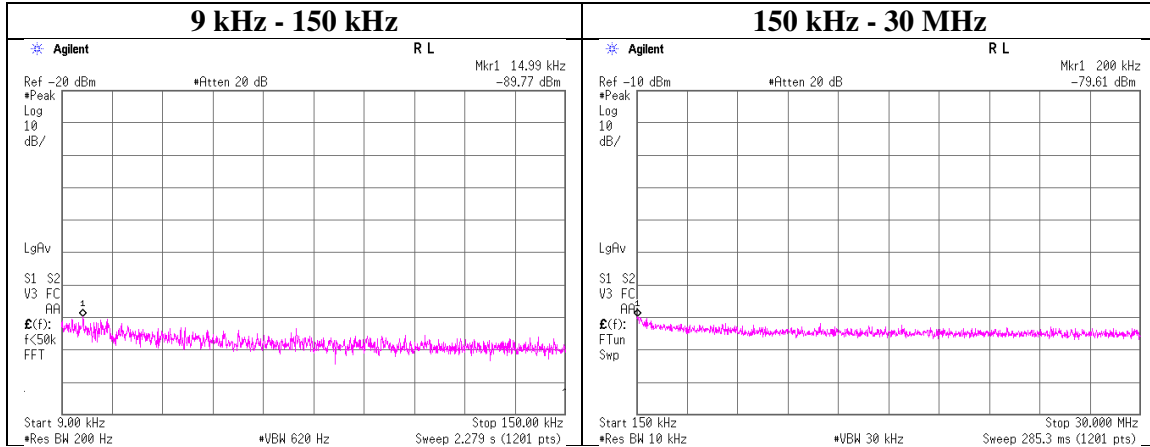

Frequency [kHz]	Reading [dBm]	Cable Loss [dB]	Attenuator Loss [dB]	Antenna Gain [dBi]	N (Number of Output)	EIRP [dBm]	Distance [m]	Ground bounce [dB]	E (field strength) [dBuV/m]	Limit [dBuV/m]	Margin [dB]	Remark
14.99	-89.8	0.01	9.97	2.0	1	-77.8	300	6.0	-16.5	44.0	60.5	
200.00	-79.6	0.01	9.97	2.0	1	-67.6	300	6.0	-6.4	21.5	27.9	

E = EIRP - 20 log (D) + Ground bounce + 104.8 [dBuV/m]

EIRP = Reading + Cable Loss + Attenuator Loss + Antenna Gain + 10 * log (N)

Power Density

Test place Kashima EMC Lab. No.2 Measurement Room
Report No. 11242579M
Date May 27, 2016
Temperature / Humidity 23 deg. C / 41 % RH
Engineer Kazuhiro Ando
Mode Tx

11b

Freq.	Reading	Cable Loss	Atten. Loss	Result	Limit	Margin
[MHz]	[dBm]	[dB]	[dB]	[dBm]	[dBm]	[dB]
2412.00	-20.91	1.28	10.03	-9.60	8.00	17.60
2437.00	-21.37	1.28	10.03	-10.06	8.00	18.06
2462.00	-20.99	1.28	10.03	-9.68	8.00	17.68

11g

Freq.	Reading	Cable Loss	Atten. Loss	Result	Limit	Margin
[MHz]	[dBm]	[dB]	[dB]	[dBm]	[dBm]	[dB]
2412.00	-24.26	1.28	10.03	-12.95	8.00	20.95
2437.00	-17.52	1.28	10.03	-6.21	8.00	14.21
2462.00	-23.90	1.28	10.03	-12.59	8.00	20.59

11n-20Tx

Freq.	Reading	Cable Loss	Atten. Loss	Result	Limit	Margin
[MHz]	[dBm]	[dB]	[dB]	[dBm]	[dBm]	[dB]
2412.00	-24.55	1.28	10.03	-13.24	8.00	21.24
2437.00	-18.99	1.28	10.03	-7.68	8.00	15.68
2462.00	-23.88	1.28	10.03	-12.57	8.00	20.57

Sample Calculation:

Result = Reading + Cable Loss (including the cable(s) customer supplied) + Attenuator

*The equipment and cables were not used for factor 0 dB of the data sheets.

Power Density

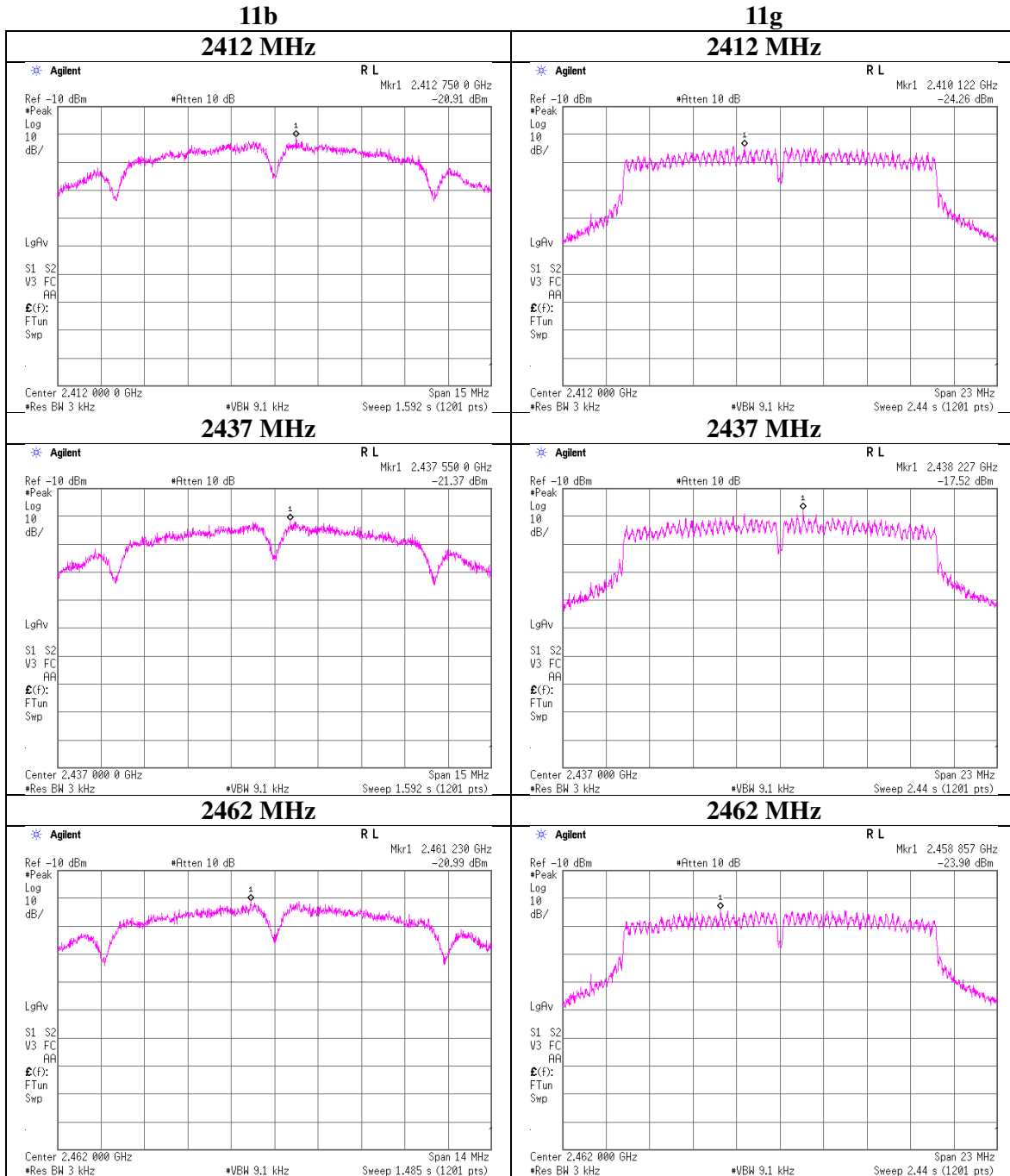

Power Density

11n-20

2412 MHz

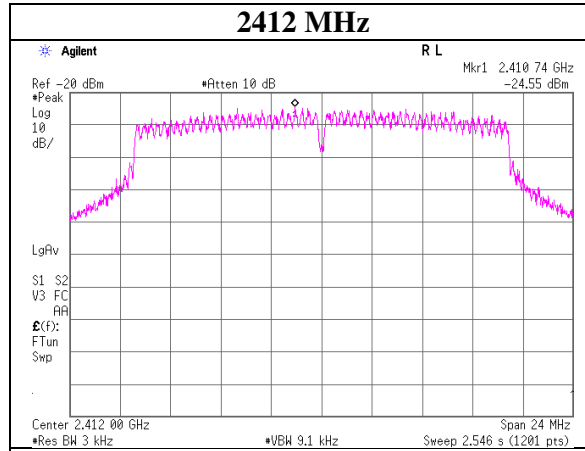

2437 MHz

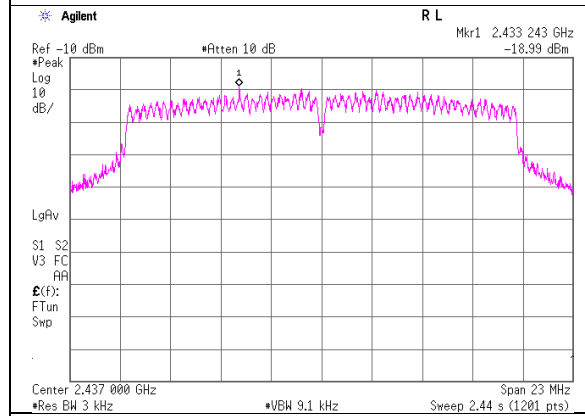

2462 MHz

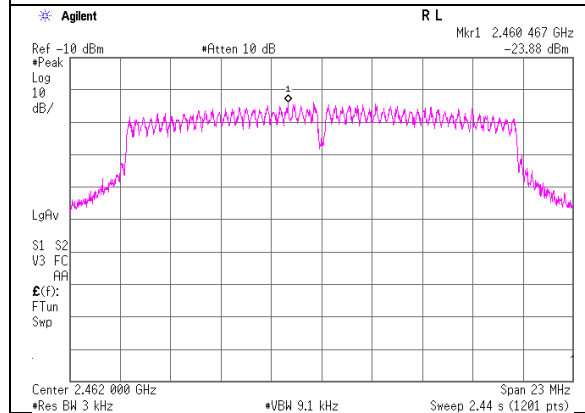

99% Occupied Bandwidth

Test place	Kashima EMC Lab. No.2 Measurement Room
Report No.	11242579M
Date	May 27, 2016
Temperature / Humidity	23 deg. C / 41 % RH
Engineer	Kazuhiro Ando
Mode	Tx

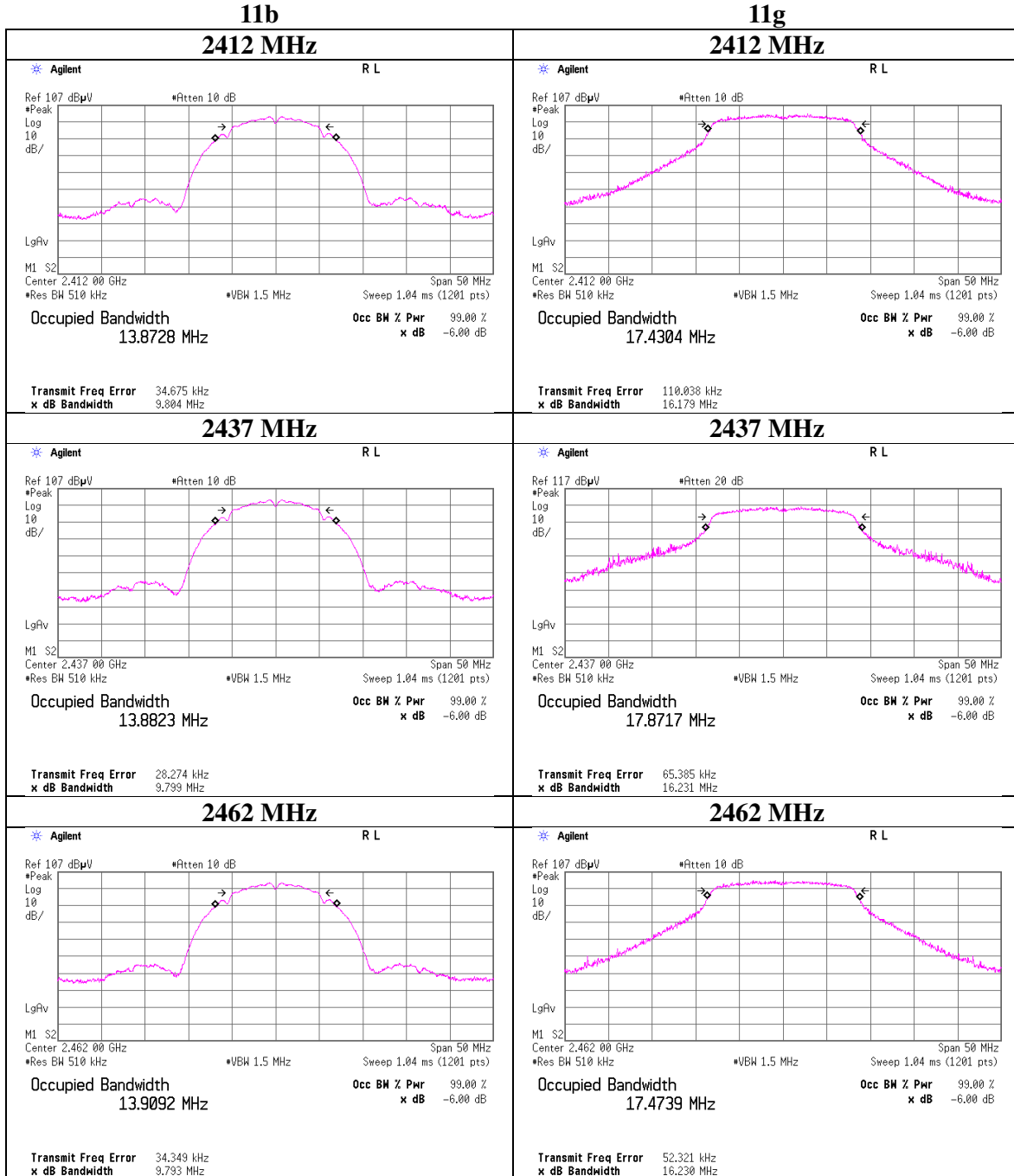

99% Occupied Bandwidth

Test place	Kashima EMC Lab. No.2 Measurement Room
Report No.	11242579M
Date	May 27, 2016
Temperature / Humidity	23 deg. C / 41 % RH
Engineer	Kazuhiro Ando
Mode	Tx

11n-20

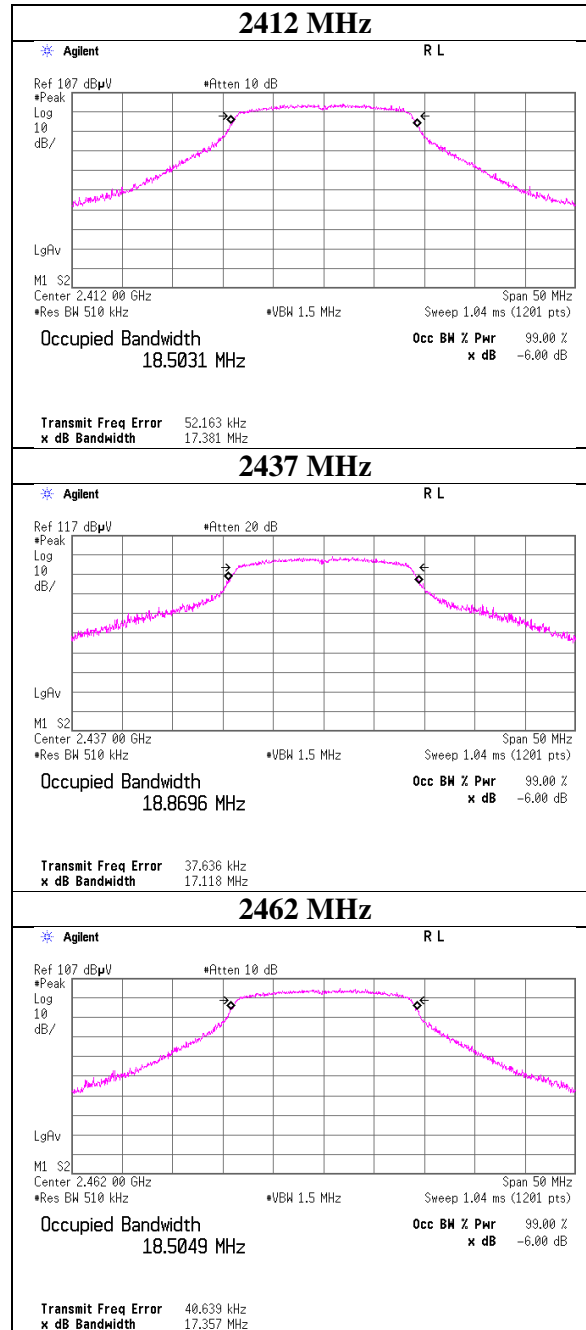

APPENDIX 2: Test instruments

Test equipment

Control No.	Instrument	Manufacturer	Model No	Serial No	Test Item	Calibration Date * Interval(month)
CSA-07	Spectrum Analyzer	Agilent	E4448A	MY52490024 Version A.11.21	AT	2015/05/28 * 12
CAT10-17	10dB Fixed Atten.	Weinschel	54A-10	56251	AT	2015/05/26 * 12
CCC-W01	Micro Wave Cable	SUHNER	SUCOFLEX102	MY3662/2	AT	2015/05/26 * 12
CPM-16	Peak Power Analyzer	Agilent	8990B	MY51000276	AT	2015/06/16 * 12
CPSO-24	Power Sensor	Agilent	N1923A	MY54070024	AT	2015/06/16 * 12
COS-12	Temperature & Humidity Indicator	A&D	AD-5681	6876017	AT	2015/07/13 * 12
CLS-25	A.M.N.	Rohde & Schwarz	ENV216	101042	CE	2015/08/06 * 12
CCC-S2-C(2/ 6/7/8)	Coaxial Cable	Fujikura,Fujikura, Fujikura,Fujikura	5D-2W,5D-2W,5 D-2W,5D-2W	-	CE	2015/07/14 * 12
CTM-32	Terminator	Suhner	65_BNC-50-0-2/ 133_NE	none	CE	2015/11/19 * 12
CTR-05	Test Receiver	Rohde & Schwarz	ESCI	100608 Rev 4.32	CE	2015/09/24 * 12
CSCL-02	Ruler	Tajima	L19-55	none	CE	2016/02/22 * 12
COS-02	Temperature & Humidity Indicator	A&D	AD-5681	6878345	CE	2015/07/13 * 12
CTS-06	Digital Multimeter	FLUKE	112	89790159	CE	2015/09/08 * 12
CTR-09	Test Receiver	Agilent	N9038A	MY53290016 Version A.14.03	RE	2015/06/28 * 12
CBL-08	LOGBICON	Schwarzbeck	VULB 9168	343	RE	2015/11/15 * 12
CAT3-04	3dB Fixed Atten.	TAMAGAWA	UFA-01	none	RE	2015/09/03 * 12
CCC-S10-R(2/4/CATS-11 /5/6/7/8/11/1 2)	Coaxial Cable	Fujikura,Fujikura, Agilent,Fujikura,F ujikura,Fujikura,F uhjikura,Fujikura, Fujikura	5D-2W,5D-2W,8 494A,5D-2W,5D -2W,5D-2W,5D- 2W,5D-2W,5D-2 W	MY41110200(St ep Att)	RE	2015/08/11 * 12
CAF-08	Pre-Amplifier	Hewlett Packard	8447D	2944A09041	RE	2015/08/11 * 12
CSCL-13	Ruler	Tajima	L19-55	none	RE	2016/02/22 * 12
COS-10	Temperature & Humidity Indicator	HIOKI	3641/9680-50	090999895/0909 05406	RE	2015/05/17 * 12
CTS-14	Digital Multimeter	FLUKE	115	994460954	RE	2015/10/01 * 12
COTS-CEMI -02	EMI Software	TSJ	TEPTO-DV(RE, CE,MF,PE)	Ver, RE: 2.5.0131, CE: 2.5.0131	RE	-

UL Japan, Inc.

Kashima EMC Lab.

1614, Mushihata, Katori-shi, Chiba-ken, 289-0341 Japan

Telephone : +81-478-88-6500

Facsimile : +81-478-82-3373

Control No.	Instrument	Manufacturer	Model No	Serial No	Test Item	Calibration Date * Interval(month)
CSA-06	Spectrum Analyzer	Agilent	N9030A	MY53310670 Version A.13.12	RE	2015/05/28 * 12
CSA-07	Spectrum Analyzer	Agilent	E4448A	MY52490024 Version A.11.21	RE	2015/05/28 * 12
CHA-20	Broad Band Horn	Schwarzbeck	BBHA 9120D	9120D-1270	RE	2015/07/31 * 12
CHA-07	Double Ridged Horn	ETS-Lindgren	3160-09	00166043	RE	2015/06/28 * 12
CAF-21	Pre-Amplifier	Micro Wave Factory	MPR-1G26.5-35	161398	RE	2016/05/06 * 12
CAF-19	Pre-Amplifier	TOYO	HAP18-26W	00000035	RE	2015/06/28 * 12
CAT10-16	10dB Fixed Atten.	Weinschel	54A-10	56246	RE	2015/05/26 * 12
CHF-03	HPF	Micro-Tronics	HPM50111-02	008	RE	2015/05/25 * 12
CCC-W05	Micro Wave Cable	Junkosha	MWX241	MRA-12-14-145	RE	2015/05/26 * 12
CCC-W07	Micro Wave Cable	Junkosha	MWX221	MRA-12-14-148	RE	2015/05/26 * 12
CCC-W09	Micro Wave Cable	SUHNER	SUCOFLEX104	MY588/4	RE	2015/07/13 * 12

**The expiration date of the calibration is the end of the expired month.
All equipment is calibrated with valid calibrations. Each measurement data is traceable to the national or international standards.**

As for some calibrations performed after the tested dates, those test equipment have been controlled by means of an unbroken chains of calibrations.

**Test Item: CE: Conducted Emission test
RE: Radiated Emission test
AT: Antenna Terminal Conducted test**