



FCC Test Report

Issued Date : Jun. 18, 2014
Project No. : 1404167
Equipment : DIGITAL CAMERA
Model Name : EX-FR10

Applicant : CASIO COMPUTER CO., LTD.
Address : 2-1, Sakaecho 3-chome, Hamura-shi,
Tokyo 205-8555, Japan

Tested by: Neutron Engineering Inc. EMC Laboratory
Date of Receipt: Apr. 10, 2014
Date of Test: Apr. 10, 2014 ~ Jun. 16, 2014

Testing Engineer: Kener Wu
(Kener Wu)

Technical Manager: Jeff Yang
(Jeff Yang)

Authorized Signatory: Andy Chiu
(Andy Chiu)

Neutron Engineering Inc.
B1, No. 37, Lane 365, YangGuang St.,
NeiHu District 114, Taipei, Taiwan.
TEL: +886-2-2657-3299
FAX: +886-2-2657-3331





Declaration

Neutron represents to the client that testing is done in accordance with standard procedures as applicable and that test instruments used has been calibrated with the standards traceable to National Measurement Laboratory (**NML**) of **R.O.C.**, or National Institute of Standards and Technology (**NIST**) of **U.S.A.**

Neutron's reports apply only to the specific samples tested under conditions. It is manufacture's responsibility to ensure that additional production units of this model are manufactured with the identical electrical and mechanical components. **Neutron** shall have no liability for any declarations, inferences or generalizations drawn by the client or others from **Neutron** issued reports.

Neutron's reports must not be used by the client to claim product endorsement by the authorities or any agency of the Government.

This report is the confidential property of the client. As a mutual protection to the clients, the public and **Neutron-self**, extracts from the test report shall not be reproduced except in full with **Neutron's** authorized written approval.

Neutron's laboratory quality assurance procedures are in compliance with the **ISO Guide 17025** requirements, and accredited by the conformity assessment authorities listed in this test report.

Limitation

For the use of the authority's logo is limited unless the Test Standard(s)/Scope(s)/Item(s) mentioned in this test report is (are) included in the conformity assessment authorities acceptance respective.



Table of Contents	Page
REPORT ISSUED HISTORY	4
1 . CERTIFICATION	5
2 . SUMMARY OF TEST RESULTS	6
2.1 TEST FACILITY	7
2.2 MEASUREMENT UNCERTAINTY	8
3 . GENERAL INFORMATION	9
3.1 GENERAL DESCRIPTION OF EUT	9
3.2 DESCRIPTION OF TEST MODES	10
3.3 BLOCK DIAGRAM SHOWING THE CONFIGURATION OF SYSTEM TESTED	11
3.4 DESCRIPTION OF SUPPORT UNITS	12
4 . EMC EMISSION TEST	13
4.1 CONDUCTED EMISSION TEST	13
4.1.1 LIMITS	13
4.1.2 MEASUREMENT INSTRUMENTS LIST	13
4.1.3 TEST PROCEDURE	14
4.1.4 DEVIATION FROM TEST STANDARD	14
4.1.5 TEST SETUP	14
4.1.6 EUT OPERATING CONDITIONS	15
4.1.7 TEST RESULTS	16
4.2 RADIATED EMISSION TEST	20
4.2.1 LIMITS	20
4.2.2 MEASUREMENT INSTRUMENTS LIST	21
4.2.3 TEST PROCEDURE	22
4.2.4 DEVIATION FROM TEST STANDARD	23
4.2.5 TEST SETUP	23
4.2.6 EUT OPERATING CONDITIONS	23
4.2.7 TEST RESULTS-BELOW 1 GHZ	24
4.2.8 TEST RESULTS-ABOVE 1 GHZ	34
5 . EUT TEST PHOTO	42



REPORT ISSUED HISTORY

Issue No.	Description	Issued Date
NEI-FCCE-1-1404167	Original Issue.	Jun. 18, 2014



1. CERTIFICATION

Equipment : DIGITAL CAMERA
Brand Name : CASIO
Model Name : EX-FR10
Applicant : CASIO COMPUTER CO., LTD.
Date of Test : Apr. 10, 2014 ~ Jun. 16, 2014
Standard(s) : FCC Part 15, Subpart B: 2013 Class B
ICES-003 Issue 5: 2012 Class B
CAN/CSA CISPR 22-10 Class B
CISPR 22: 2008 Class B
ANSI C63.4-2009

The above equipment has been tested and found compliance with the requirement of the relative standards by Neutron Engineering Inc. EMC Laboratory.

The test data, data evaluation, and equipment configuration contained in our test report (Ref No. NEI-FCCE-1-1404167) were obtained utilizing the test procedures, test instruments, test sites that has been accredited by the Authority of TAF according to the ISO-17025 quality assessment standard and technical standard(s).



2. SUMMARY OF TEST RESULTS

Test procedures according to the technical standards:

Emission				
Standard(s)	Test Item	Limit	Judgment	Remark
FCC Part 15, Subpart B: 2013 ICES-003 Issue 5: 2012 CAN/CSA CISPR 22-10 CISPR 22: 2008	Conducted emission	Class B	PASS	
	Radiated emission Below 1 GHz	Class B	PASS	
	Radiated emission Above 1 GHz	Class B	PASS	NOTE (2)

NOTE:

- (1) "N/A" denotes test is not applicable in this Test Report.
- (2) If the EUT's max operating frequency does not exceed 108 MHz, the test will not be performed.



2.1 TEST FACILITY

The test facilities used to collect the test data in this report:

Conducted emission Test:

C03: (VCCI RN: C-4461)

B1, No. 37, Lane 365, YangGuang St., NeiHu District 114, Taipei, Taiwan.

Radiated emission Test (Below 1 GHz):

OS01: (VCCI RN: R-2829; FCC RN: 95335; FCC DN: TW1010)

No.132-1, Ln. 329, Sec. 2, Balian Rd., Xizhi Dist., New Taipei City 221, Taiwan (R.O.C.)

Radiated emission Test (Above 1 GHz):

CB08: (VCCI RN: G-91; FCC RN: 614388; FCC DN: TW1054; IC Assigned Code: 4428C-1)

1F., No. 61, Ln. 77, Sing-ai Rd., Neihu Dist., Taipei City 114, Taiwan (R.O.C.)



2.2 MEASUREMENT UNCERTAINTY

The measurement uncertainty is not specified by FCC/ Industry Canada rules and for reference only.

The reported uncertainty of measurement $y \pm U$, where expanded uncertainty U is based on a standard uncertainty multiplied by a coverage factor of $k=2$, providing a level of confidence of approximately **95%**.

The measurement instrumentation uncertainty considerations contained in CISPR 16-4-2.

A. Conducted emission test:

Test Site	Measurement Frequency Range	U , (dB)	NOTE
C03	150 kHz ~ 30 MHz	1.94	

B. Radiated emission test:

Test Site	Measurement Frequency Range	Ant. H / V	U , (dB)	NOTE
OS01	30 MHz ~ 200 MHz	V	2.86	
	30 MHz ~ 200 MHz	H	2.56	
	200 MHz ~ 1, 000 MHz	V	2.88	
	200 MHz ~ 1, 000 MHz	H	2.98	

Test Site	Item	Measurement Frequency Range	Uncertainty	NOTE	
CB08	Radiated emission at 3m	Horizontal Polarization	30 - 200MHz	3.35 dB	
			200 - 1000MHz	3.11 dB	
			1 - 18GHz	3.97 dB	
			18 - 40GHz	4.01 dB	
		Vertical Polarization	30 - 200MHz	3.22 dB	
			200 - 1000MHz	3.24 dB	
			1 - 18GHz	4.05 dB	
			18 - 40GHz	4.04 dB	

Our calculated Measurement Instrumentation Uncertainty is shown in the tables above.

These are our U_{lab} values in CISPR 16-4-2 terminology.

Since Table 1 of CISPR 16-4-2 has values of measurement instrumentation uncertainty, called U_{CISPR} , as follows:

Conducted Disturbance (mains port) – 150 kHz – 30 MHz : 3.6 dB

Radiated Disturbance (electric field strength on an open area test site or alternative test site) – 30 MHz – 1000 MHz : 5.2 dB

It can be seen that our U_{lab} values are smaller than U_{CISPR} .



3. GENERAL INFORMATION

3.1 GENERAL DESCRIPTION OF EUT

Equipment	DIGITAL CAMERA
Brand Name	CASIO
Model Name	EX-FR10
OEM Brand/Model Name	N/A
Model Difference	N/A
Product Description	More details of EUT technical specification please refer to the User's Manual.
Power Source	#1 DC Voltage supplied USB host. #2 Battery supplied.
Power Rating	#1 USB host (1) USB host: DC 5V (2) Adapter: CASIO/AD-C53U I/P AC 100-240V 50/60Hz 100mA O/P DC 5V 650mA #2 DC 3.7V 700mAh 2.6Wh
Connecting I/O Port(s)	Please refer to the User's Manual
Products Covered	N/A
EUT Modification(s)	N/A

Note:

1. For a more detailed features description, please refer to the manufacturer's specifications or the User's Manual.



3.2 DESCRIPTION OF TEST MODES

To investigate the maximum EMI emission characteristics generates from EUT, the test system was pre-scanning tested base on the consideration of following EUT operation mode or test configuration mode which possible have effect on EMI emission level. Each of these EUT operation mode(s) or test configuration mode(s) mentioned above was evaluated respectively.

Pretest Test Mode	Description
Mode 1	PLAYBACK
Mode 2	RECORD
Mode 3	CHARGE(Power off)
Mode 4	WIFI LINK
Mode 5	Mass Storage(PC Link)

Conducted emission test	
Final Test Mode	Description
Mode 3	CHARGE(Power off)
Mode 5	Mass Storage(PC Link)

Radiated emission test	
Final Test Mode	Description
Mode 1	PLAYBACK
Mode 2	RECORD
Mode 3	CHARGE(Power off)
Mode 4	WIFI LINK
Mode 5	Mass Storage(PC Link)



3.3 BLOCK DIAGRAM SHOWING THE CONFIGURATION OF SYSTEM TESTED

MODE 1, 2, 3 and 4

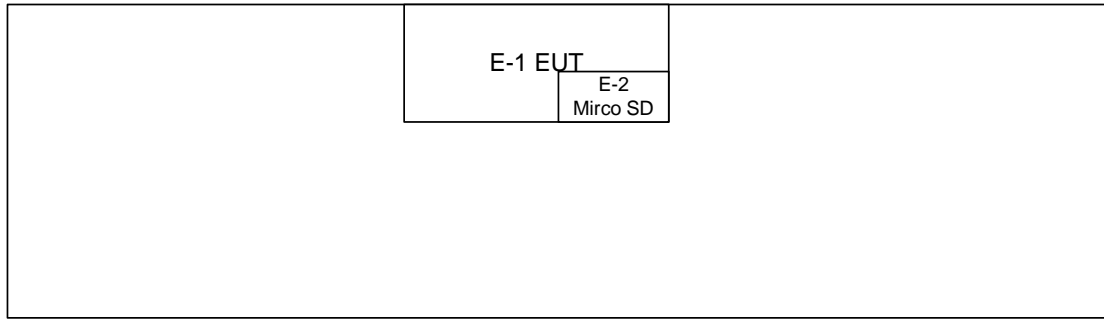

MODE 5

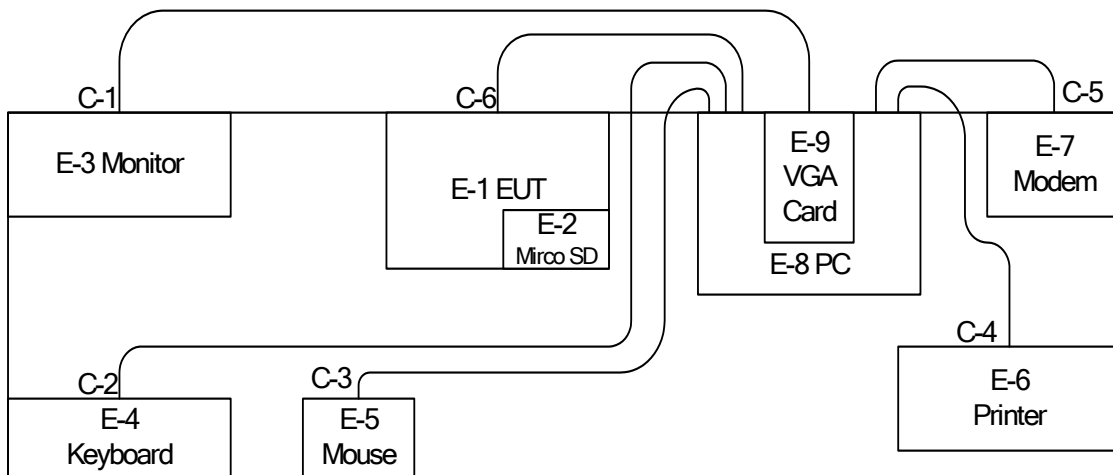

- C-1 D-SUB Cable
- C-2 USB Cable
- C-3 USB Cable
- C-4 USB Cable
- C-5 RS232 Cable
- C-6 USB Cable



3.4 DESCRIPTION OF SUPPORT UNITS

The EUT has been tested as an independent unit together with other necessary accessories or support units. The following support units or accessories were used to form a representative test configuration during the tests.

Item	Equipment	Mfr/Brand	Model/Type No.	Series No.	Note
E-1	DIGITAL CAMERA	CASIO	EX-FR10	N/A	EUT
E-2	Micro SD Card	Sandisk	SDSDQXP-016G-X 46	N/A	
E-3	24" LCD Monitor	DELL	U2410f	CN-OJ257M-72872- 09J-067L	
E-4	USB K/B	DELL	L50U	CN-0H9F99-65890- 17P-06WP-A01	
E-5	USB Mouse	DELL	MS111-L	CN-09RRC7-44751- 17J-OH1F	
E-6	Printer	HP	VCVRA-1004	CN17511HHK	
E-7	Modem	ACEEX	DM-1414V	8041708	
E-8	PC	DELL	D09M	54NJVBX	
E-9	VGA Card	Gigabyte	GTX 550 Ti	122951008613	

Item	Shielded Type	Ferrite Core	Length	Note
C-1	YES	YES	1.8M	
C-2	YES	NO	1.8M	
C-3	YES	NO	1.8M	
C-4	YES	NO	1.7M	
C-5	YES	NO	1.7M	
C-6	YES	YES	0.8M	

Note:

- (1) The support equipment was authorized by Declaration of Conformity (DOC).



4. EMC EMISSION TEST

4.1 CONDUCTED EMISSION TEST

4.1.1 LIMITS (FREQUENCY RANGE 150 KHZ-30MHZ)

FREQUENCY (MHz)	Class A (dBuV)		Class B (dBuV)	
	Quasi-peak	Average	Quasi-peak	Average
0.15 - 0.5	79.00	66.00	66 - 56 *	56 - 46 *
0.50 - 5.0	73.00	60.00	56.00	46.00
5.0 - 30.0	73.00	60.00	60.00	50.00

NOTE:

- (1) The tighter limit applies at the band edges.
- (2) The limit of " * " marked band means the limitation decreases linearly with the logarithm of the frequency in the range.
- (3) The test result calculated as following:
 Measurement Value = Reading Level + Correct Factor
 Correct Factor = Insertion Loss + Cable Loss + Attenuator Factor(if use)
 Margin Level = Measurement Value – Limit Value

4.1.2 MEASUREMENT INSTRUMENTS LIST

Item	Kind of Equipment	Manufacturer	Type No.	Serial No.	Calibrated until
1	TWO-LINE V-NETWORK	R&S	ENV216	101051	Jan. 16, 2015
2	Test Cable	TIMES	CFD300-NL	C03	Jun. 15, 2015
3	EMI Test Receiver	R&S	ESCI	100080	May. 11, 2015
4	Measurement Software	EZ	EZ_EMCC (Version NB-03A)	N/A	N/A

Remark: "N/A" denotes No Model Name, No Serial No. or No Calibration specified.

4.1.3 TEST PROCEDURE

- a. The EUT was placed 0.8 meters from the horizontal ground plane with EUT being connected to the power mains through a line impedance stabilization network (LISN). All other support equipments powered from additional LISN(s). The LISN provide 50 Ohm/ 50uH of coupling impedance for the measuring instrument.
- b. Interconnecting cables that hang closer than 40 cm to the ground plane shall be folded back and forth in the center forming a bundle 30 to 40 cm long.
- c. I/O cables that are not connected to a peripheral shall be bundled in the center. The end of the cable may be terminated, if required, using the correct terminating impedance. The overall length shall not exceed 1 m.
- d. LISN at least 80 cm from nearest part of EUT chassis.
- e. For the actual test configuration, please refer to the related Item –EUT Test Photos.

NOTE:

- a. Reading in which marked as Peak, QP or AVG means measurements by using are Quasi-Peak or Average Mode with Detector BW=9 kHz (6 dB Bandwidth).
- b. All readings are Peak Mode value unless otherwise stated QP or AVG in column of Note. If the Peak or QP Mode Measured value compliance with the QP Limits and lower than AVG Limits, the EUT shall be deemed to meet both QP & AVG Limits and then only Peak or QP Mode was measured, but AVG Mode didn't perform.

4.1.4 DEVIATION FROM TEST STANDARD

No deviation

4.1.5 TEST SETUP

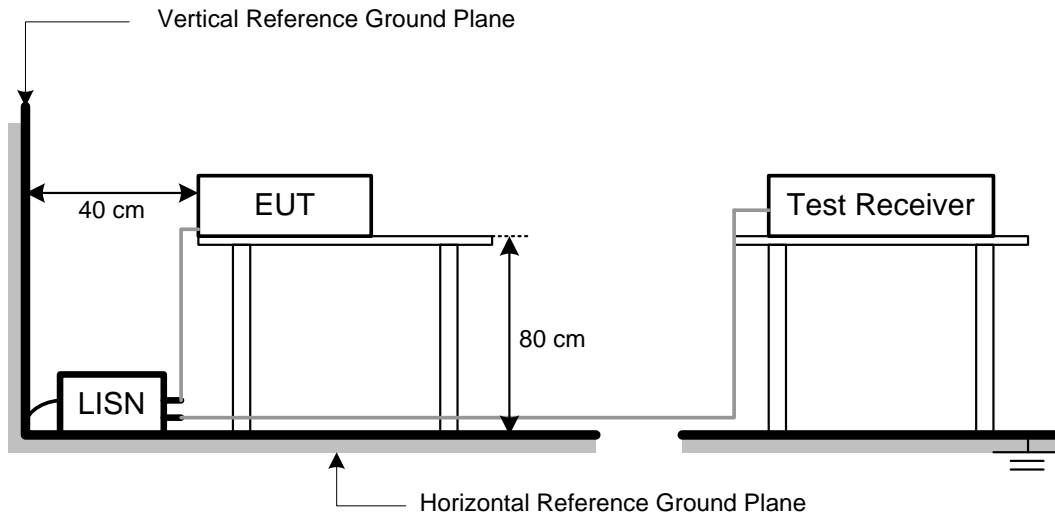



4.1.6 EUT OPERATING CONDITIONS

Mode 1, 2, 3 and 4:

The EUT exercise program used during radiated and/or conducted emission measurement was designed to exercise the various system components in a manner similar to a typical use.

The sequence used is:

Mode 1: The EUT read from MicroSD and play image continuously.

Mode 2: The EUT receive image and write to MicroSD continuously.

Mode 3: The EUT power off and connect to adapter and charge continuously.

Mode 4: The EUT connect to remote system via WIFI continuously.

Mode 5:

The PC exercise program (EMC TEST) used during radiated and/or conducted emission measurement was designed to exercise the various system components in a manner similar to a typical use. The program contained on a PC hard disk and is auto-starting on power-up. Once loaded, the program sequentially exercises each system component in turn. The sequence used is:

1. Read (write) from (to) mass storage device (MicroSD via EUT).
2. Send "H" pattern to video port device (Monitor).
3. Send "H" pattern to serial port device (Modem).
4. Send "H" pattern to USB port device (Printer).
5. Repeated from 2 to 5 continuously.

As the keyboard and mouse are strictly input devices, no data is transmitted to (from) them during test. They are, however, continuously scanned for data input activity.



4.1.7 TEST RESULTS

EUT	DIGITAL CAMERA	Model Name	EX-FR10
Temperature	25 °C	Relative Humidity	48%
Test Voltage	AC 120V/60Hz		
Test Mode	CHARGE(Power off)		

Phase: Line

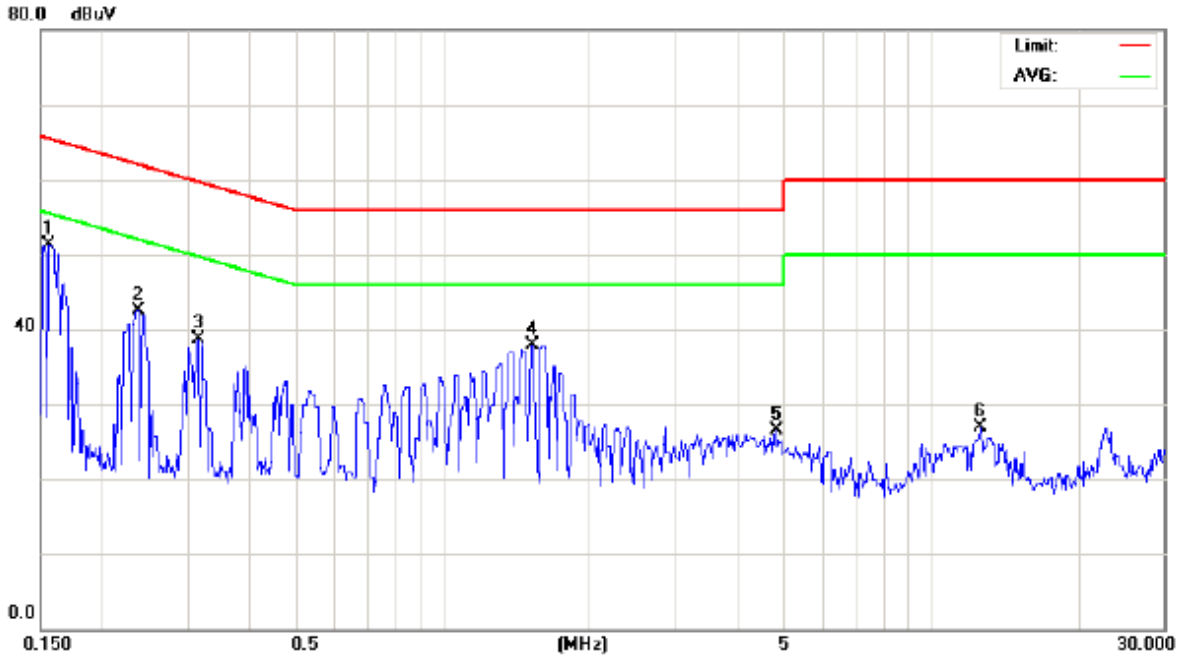

No.	Mk.	Freq. MHz	Reading Level dBuV	Correct Factor dB	Measure- ment dBuV	Limit dBuV	Over dB	Detector	Comment
1	*	0.1556	41.76	9.63	51.39	65.69	-14.30	peak	
2		0.2368	32.93	9.65	42.58	62.20	-19.62	peak	
3		0.3144	29.13	9.64	38.77	59.85	-21.08	peak	
4		1.5260	28.23	9.62	37.85	56.00	-18.15	peak	
5		4.8110	16.74	9.72	26.46	56.00	-29.54	peak	
6		12.6000	16.92	10.00	26.92	60.00	-33.08	peak	



EUT	DIGITAL CAMERA	Model Name	EX-FR10
Temperature	25 °C	Relative Humidity	48%
Test Voltage	AC 120V/60Hz		
Test Mode	CHARGE(Power off)		

Phase: Neutral

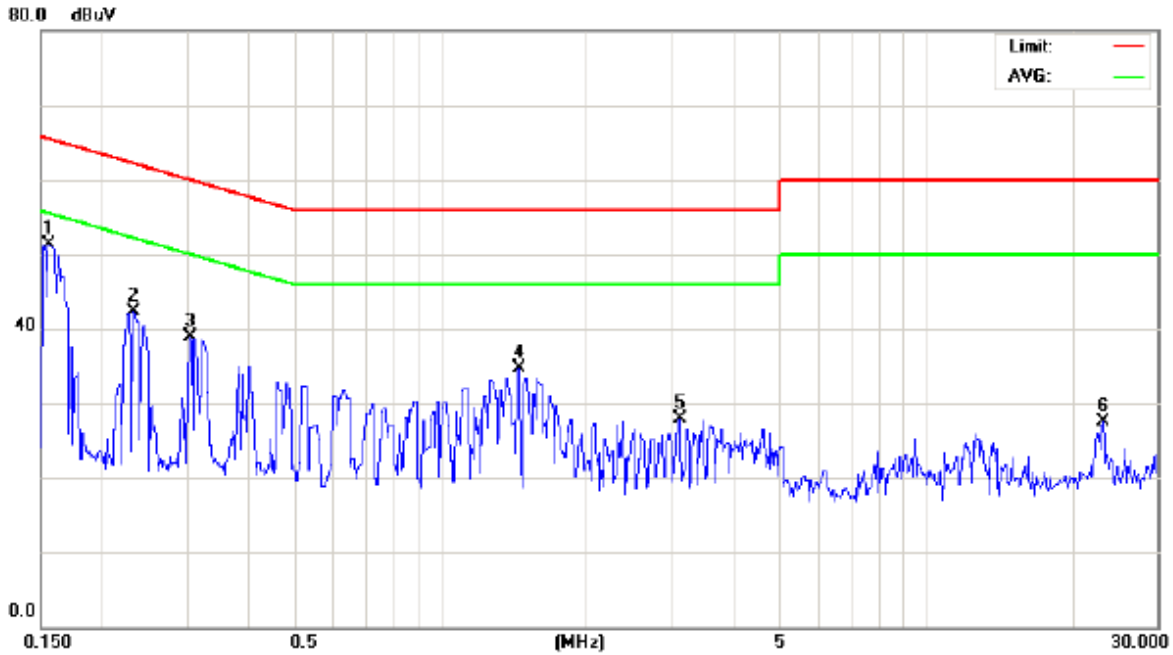

No.	Mk.	Freq. MHz	Reading Level dBuV	Correct Factor dB	Measure- ment dBuV	Limit dBuV	Over dB	Detector	Comment
1	*	0.1556	41.60	9.61	51.21	65.69	-14.48	peak	
2		0.2319	32.61	9.64	42.25	62.38	-20.13	peak	
3		0.3047	29.18	9.64	38.82	60.11	-21.29	peak	
4		1.4450	25.19	9.60	34.79	56.00	-21.21	peak	
5		3.0920	18.21	9.65	27.86	56.00	-28.14	peak	
6		23.1000	17.32	10.10	27.42	60.00	-32.58	peak	



EUT	DIGITAL CAMERA	Model Name	EX-FR10
Temperature	25 °C	Relative Humidity	48%
Test Voltage	AC 120V/60Hz		
Test Mode	Mass Storage(PC Link)		

Phase: Line

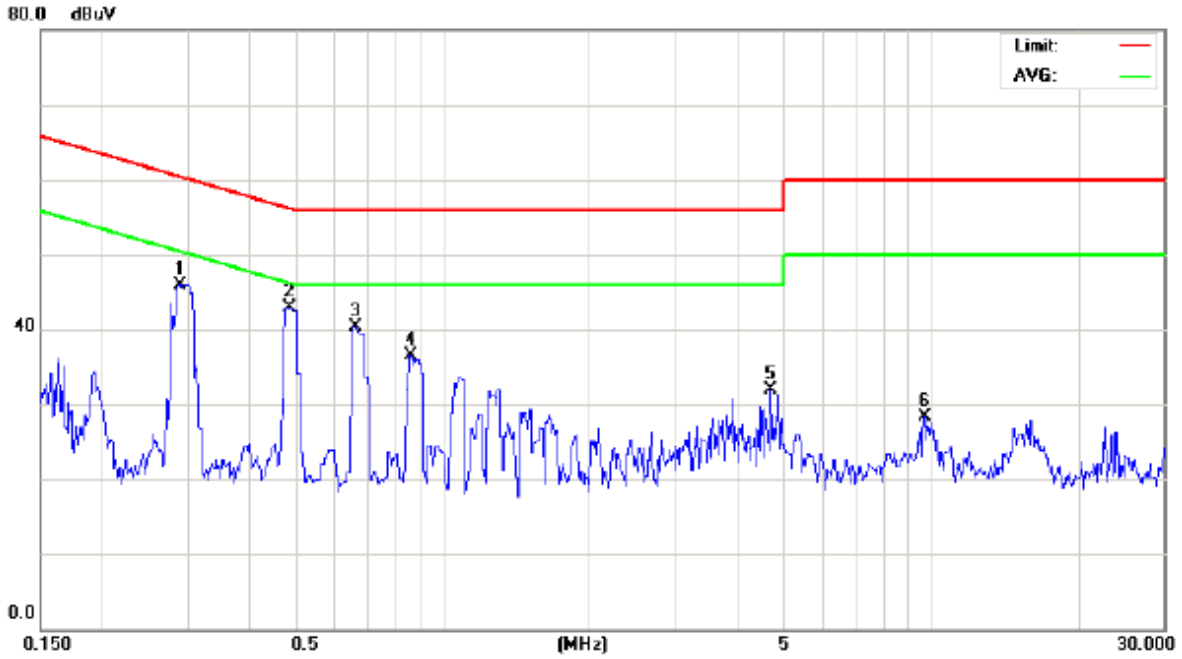

No. Mk.	Freq. MHz	Reading Level dBuV	Correct Factor dB	Measure- ment dBuV	Limit dBuV	Over dB	Detector	Comment
1	0.2886	36.34	9.64	45.98	60.56	-14.58	peak	
2 *	0.4846	33.31	9.62	42.93	56.26	-13.33	peak	
3	0.6620	30.72	9.61	40.33	56.00	-15.67	peak	
4	0.8600	26.86	9.62	36.48	56.00	-19.52	peak	
5	4.6760	22.18	9.72	31.90	56.00	-24.10	peak	
6	9.7000	18.52	9.88	28.40	60.00	-31.60	peak	



EUT	DIGITAL CAMERA	Model Name	EX-FR10
Temperature	25 °C	Relative Humidity	48%
Test Voltage	AC 120V/60Hz		
Test Mode	Mass Storage(PC Link)		

Phase: Neutral

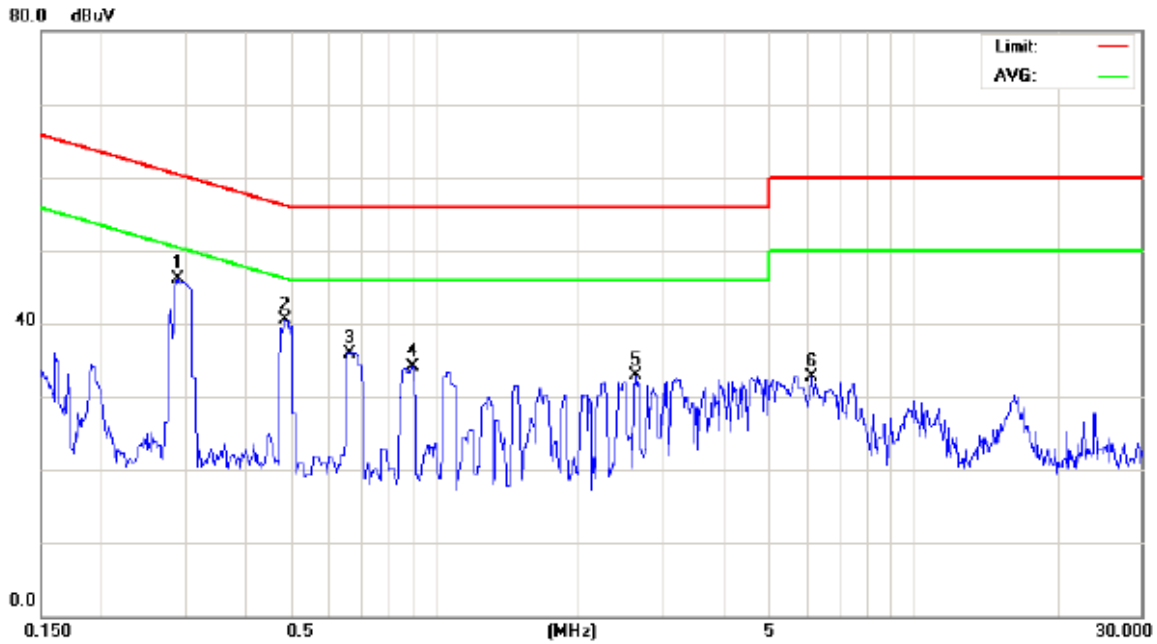

No.	Mk.	Freq. MHz	Reading Level dBuV	Correct Factor dB	Measure- ment dBuV	Limit dBuV	Over dB	Detector	Comment
1	*	0.2893	36.46	9.63	46.09	60.54	-14.45	peak	
2		0.4839	30.90	9.62	40.52	56.27	-15.75	peak	
3		0.6620	26.34	9.61	35.95	56.00	-20.05	peak	
4		0.8960	24.58	9.60	34.18	56.00	-21.82	peak	
5		2.6330	23.32	9.64	32.96	56.00	-23.04	peak	
6		6.1500	23.02	9.76	32.78	60.00	-27.22	peak	



4.2 RADIATED EMISSION TEST

4.2.1 LIMITS

Below 1 GHz

FREQUENCY (MHz)	Class A (at 10m)	Class B (at 10m)
	dBuV/m	dBuV/m
30 - 230	40	30
230 - 1000	47	37

NOTE:

- (1) The limit for radiated test was performed according to as following:
FCC Part 15, Subpart B: 2013; ICES-003 Issue 5: 2012; CAN/CSA-CISPR 22-10; CISPR 22: 2008.
- (2) The tighter limit applies at the band edges.
- (3) Emission level (dBuV/m) = 20log Emission level (uV/m).
- (4) The test result calculated as following:
Measurement Value = Reading Level + Correct Factor
Correct Factor = Antenna Factor + Cable Loss - Amplifier Gain(if use)
Margin Level = Measurement Value - Limit Value

Above 1 GHz

FREQUENCY (MHz)	Class A (dBuV/m) (at 3m)		Class A (dBuV/m) (at 10m)	
	PEAK	AVERAGE	PEAK	AVERAGE
Above 1000	80	60	69.5	49.5
FREQUENCY (MHz)	Class B (dBuV/m) (at 3m)			
	PEAK	AVERAGE		
Above 1000	74	54		

NOTE:

- (1) The limit for radiated test was performed according to as following:
FCC Part 15, Subpart B: 2013; ICES-003 Issue 5: 2012.
- (2) The tighter limit applies at the band edges.
- (3) Emission level (dBuV/m) = 20log Emission level (uV/m).
3m Emission level = 10m Emission level + 20log(10m/3m).
- (4) The test result calculated as following:
Measurement Value = Reading Level + Correct Factor
Correct Factor = Antenna Factor + Cable Loss - Amplifier Gain(if use)
Margin Level = Measurement Value - Limit Value

FREQUENCY RANGE OF RADIATED MEASUREMENT (FOR UNINTENTIONAL RADIATORS)

Highest frequency generated or Upper frequency of measurement used in the device or on which the device operates or tunes (MHz)	Range (MHz)
Below 1.705	30
1.705 - 108	1000
108 - 500	2000
500 - 1000	5000
Above 1000	5 th harmonic of the highest frequency or 40 GHz, whichever is lower



4.2.2 MEASUREMENT INSTRUMENTS LIST

Below 1 GHz:

Item	Kind of Equipment	Manufacturer	Type No.	Serial No.	Calibrated until
1	Pre-Amplifier	Anritsu	MH648A	M09961	May. 28, 2015
2	Test Cable	TIMES	LMR-400	30M	May. 28, 2015
3	Test Cable	TIMES	LMR-400	OS01-1	May. 28, 2015
4	EMI Measuring Receiver	SHCAFFNER	SCR 3501	408	Jan. 7, 2015
5	Spectrum Analyzer	ADVANTEST	R3162	140100131	Sep. 24, 2014
6	Positioning Controller (OS01)	CT	SC100	N/A	N/A
7	Turn Table	Chance Most	CMTB-1.5	N/A	N/A
8	Measurement Software	EZ	EZ_EMG (Version NB-03A)	N/A	N/A
9	Log-Bicon Antenna	Schwarzbeck	VULB 9161	4022	Apr. 22, 2015

Above 1 GHz:

Item	Kind of Equipment	Manufacturer	Type No.	Serial No.	Calibrated until
1	Horn Antenna (1G)	Schwarzbeck	BBHA 9120 D	9120D-325	Jun. 12, 2015
2	Pre_Amplifier	Agilent	8449B	3008A01714	Apr. 15, 2015
3	Microflex Cable	HARBOUR INDUSTRIES	27478 LL142	1M	May. 12, 2015
4	Microflex Cable	AISI	S104-SMAP-1	10M	May. 14, 2015
5	Microflex Cable	HARBOUR INDUSTRIES	27478 LL142	3M	May. 12, 2015
6	Spectrum Analyzer	R&S	FSP-40	100129	Apr. 21, 2015
7	Measurement Software	EZ	EZ_EMG (Version NB-03A)	N/A	N/A

Remark: "N/A" denotes No Model Name, No Serial No. or No Calibration specified.



4.2.3 TEST PROCEDURE

- a. The EUT was placed on the top of a rotating table 0.8 meters above the ground at a 3m or 10 meter open area test site. The table was rotated 360 degrees to determine the position of the highest radiation.
- b. The height of the equipment or of the substitution antenna shall be 0.8 m; the height of the test antenna shall vary between 1 m to 4 m. Both horizontal and vertical polarizations of the antenna are set to make the measurement.
- c. The initial step in collecting radiated emission data is a spectrum analyzer peak detector mode pre-scanning the measurement frequency range. Significant peaks are then marked and then Quasi Peak detector mode re-measured.
- d. If the Peak Mode measured value compliance with and lower than Quasi Peak Mode Limit, the EUT shall be deemed to meet QP Limits and then no additional QP Mode measurement performed.
- e. For the actual test configuration, please refer to the related Item –EUT Test Photos.

NOTE: (Below 1 GHz)

- a. Reading in which marked as QP or Peak means measurements by using are Quasi-Peak Mode with Detector BW=120 kHz.
- b. All readings are Peak unless otherwise stated QP in column of Note. Peak denotes that the Peak reading compliance with the QP Limits and then QP Mode measurement didn't perform.

NOTE: (Above 1 GHz)

- a. Reading in which marked as Peak means measurements by using are Peak Mode with instrument setting in RBW= 1 MHz, VBW= 1 MHz.
Reading in which marked as AV means measurements by using are Average Mode with instrument setting in RBW= 1 MHz, VBW= 10 Hz.
- b. All readings are Peak Mode value unless otherwise stated AVG in column of Note. If the Peak Mode Measured value compliance with the Peak Limits and lower than AVG Limits, the EUT shall be deemed to meet both Peak & AVG Limits and then only Peak Mode was measured, but AVG Mode didn't perform.

4.2.4 DEVIATION FROM TEST STANDARD

No deviation

4.2.5 TEST SETUP

Below 1 GHz

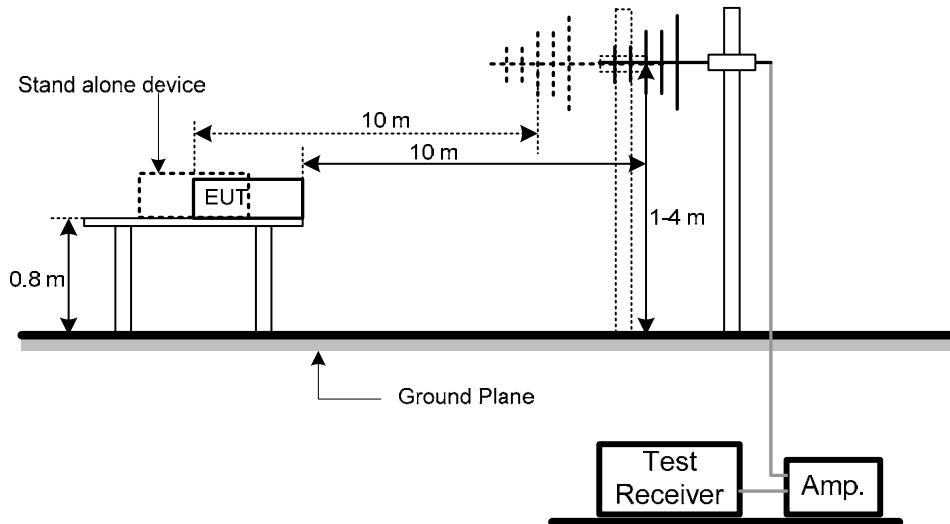

Above 1 GHz

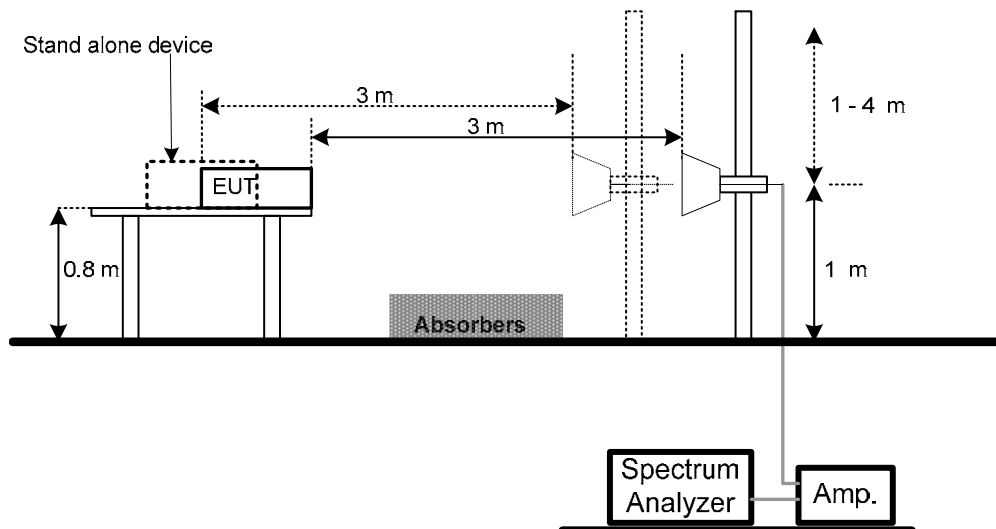

4.2.6 EUT OPERATING CONDITIONS

The EUT tested system was configured as the statements of 4.1.6 Unless otherwise a special operating condition is specified in the follows during the testing.



4.2.7 TEST RESULTS-BELOW 1 GHZ

EUT	DIGITAL CAMERA	Model Name	EX-FR10
Temperature	25° C	Relative Humidity	65%
Test Voltage	DC 3.7V		
Test Mode	PLAYBACK		

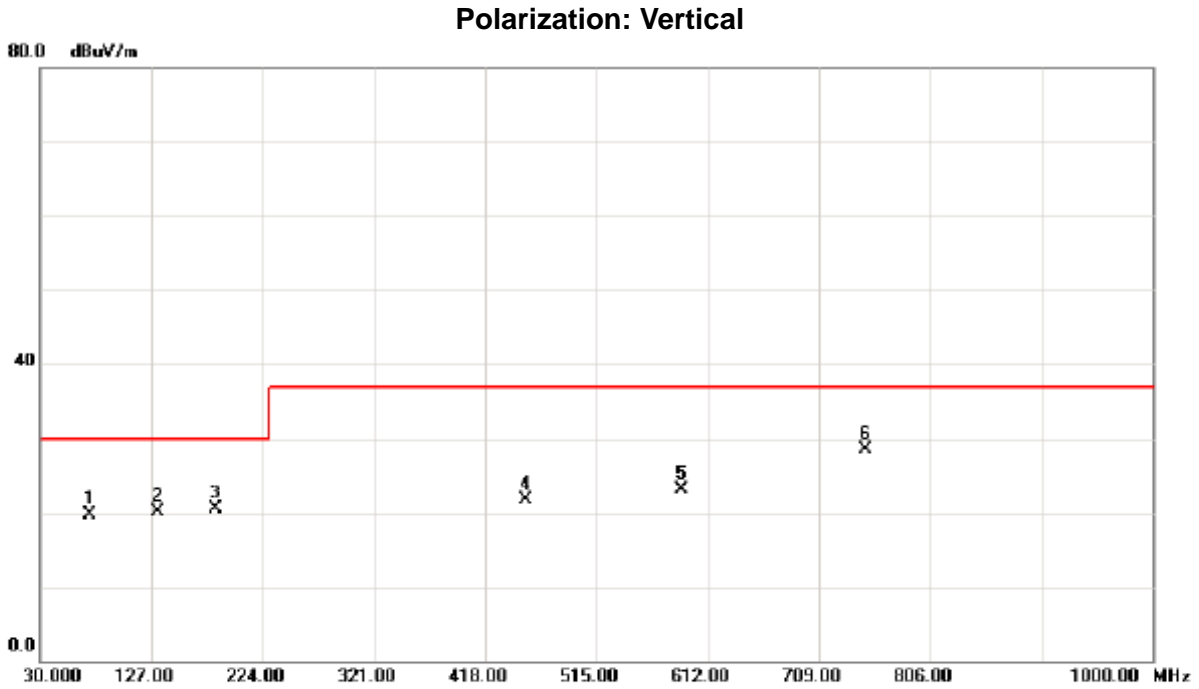

No. Mk.	Freq. MHz	Reading Level dBuV	Correct Factor dB	Measurement dBuV/m	Limit dBuV/m	Over dB	Detector	Comment
1	72.7745	30.89	-11.22	19.67	30.00	-10.33	peak	
2	132.8303	24.90	-4.88	20.02	30.00	-9.98	peak	
3	183.8124	26.13	-5.63	20.50	30.00	-9.50	peak	
4	453.9820	21.74	0.05	21.79	37.00	-15.21	peak	
5	589.9880	21.32	1.87	23.19	37.00	-13.81	peak	
6 *	749.6710	23.57	4.99	28.56	37.00	-8.44	peak	



EUT	DIGITAL CAMERA	Model Name	EX-FR10
Temperature	25° C	Relative Humidity	65%
Test Voltage	DC 3.7V		
Test Mode	PLAYBACK		

Polarization: Horizontal



No.	Mk.	Freq. MHz	Reading Level dBuV	Correct Factor dB	Measure- ment dBuV/m	Limit dBuV/m	Over dB	Detector	Comment
1	*	111.1200	28.84	-7.47	21.37	30.00	-8.63	peak	
2		147.5000	22.34	-2.07	20.27	30.00	-9.73	peak	
3		178.5400	24.75	-4.78	19.97	30.00	-10.03	peak	
4		203.2800	24.48	-6.59	17.89	30.00	-12.11	peak	
5		259.0600	21.07	-6.32	14.75	37.00	-22.25	peak	
6		333.7500	21.25	-4.12	17.13	37.00	-19.87	peak	



EUT	DIGITAL CAMERA	Model Name	EX-FR10
Temperature	25° C	Relative Humidity	65%
Test Voltage	DC 3.7V		
Test Mode	RECORD		

Polarization: Vertical

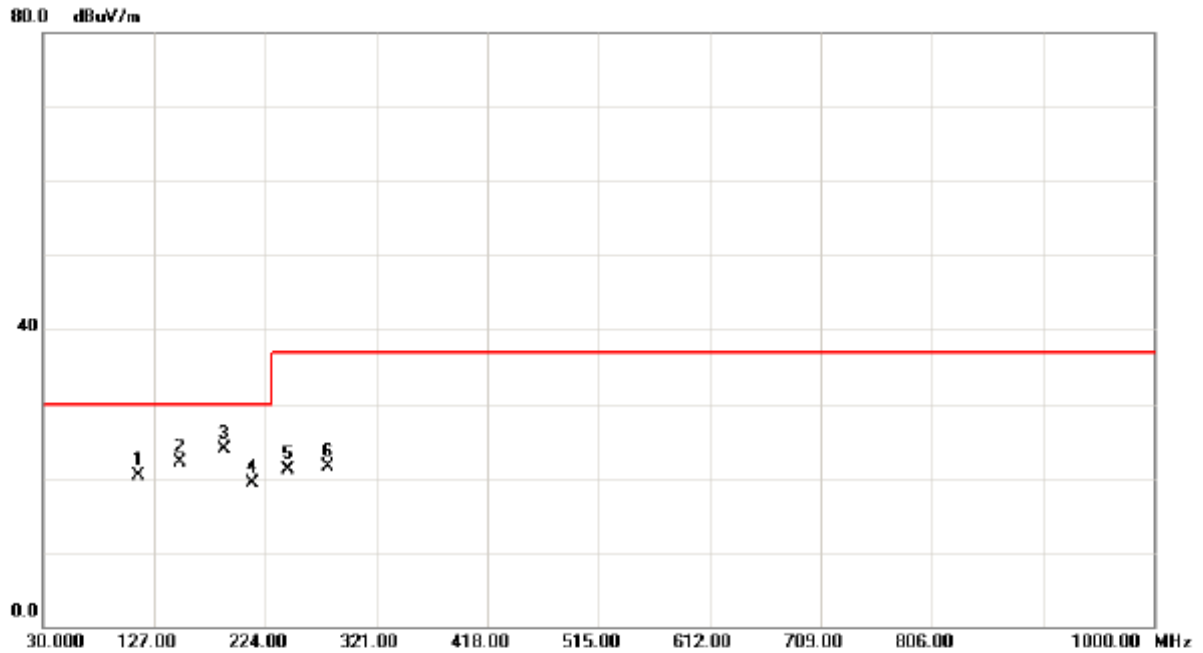

No.	Mk.	Freq. MHz	Reading Level dBuV	Correct Factor dB	Measure- ment dBuV/m	Limit dBuV/m	Over dB	Detector	Comment
1		112.9700	27.85	-7.46	20.39	30.00	-9.61	peak	
2		149.1800	23.90	-1.82	22.08	30.00	-7.92	peak	
3	*	188.4800	30.29	-6.46	23.83	30.00	-6.17	peak	
4		213.1300	25.41	-6.18	19.23	30.00	-10.77	peak	
5		243.9500	28.09	-7.01	21.08	37.00	-15.92	peak	
6		279.0000	27.06	-5.52	21.54	37.00	-15.46	peak	



EUT	DIGITAL CAMERA	Model Name	EX-FR10
Temperature	25° C	Relative Humidity	65%
Test Voltage	DC 3.7V		
Test Mode	RECORD		

Polarization: Horizontal

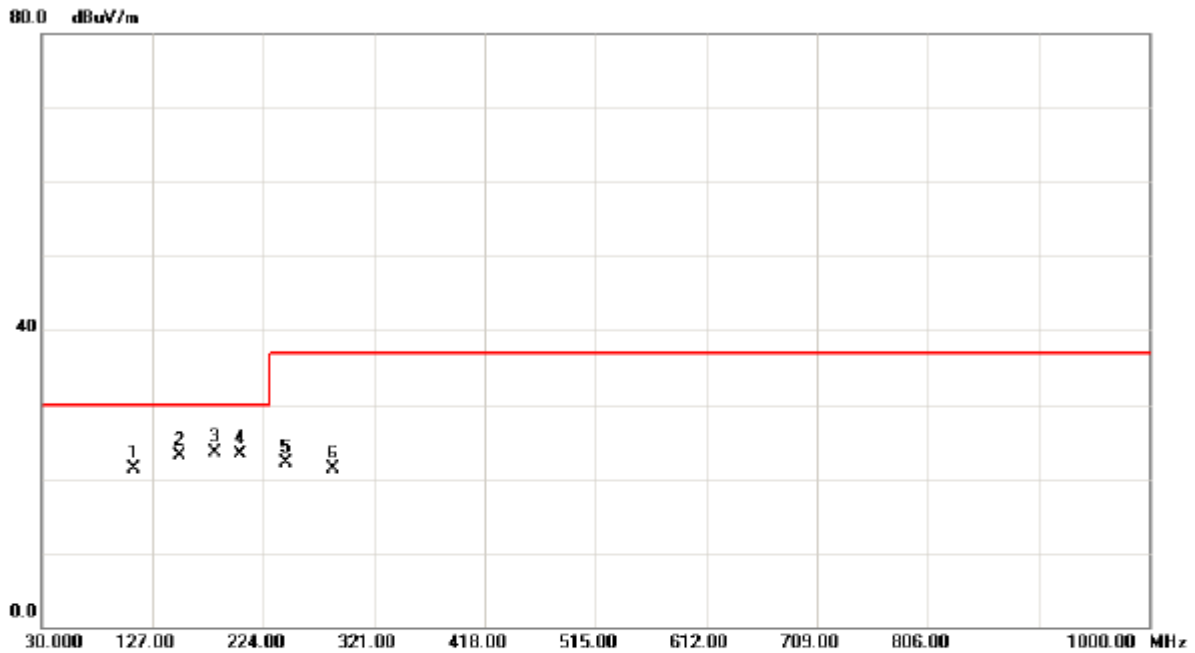

No.	Mk.	Freq. MHz	Reading Level dBuV	Correct Factor dB	Measure- ment dBuV/m	Limit dBuV/m	Over dB	Detector	Comment
1		111.0400	28.74	-7.47	21.27	30.00	-8.73	peak	
2		150.3400	24.81	-1.65	23.16	30.00	-6.84	peak	
3	*	182.3100	28.93	-5.35	23.58	30.00	-6.42	peak	
4		203.8900	29.81	-6.52	23.29	30.00	-6.71	peak	
5		243.9500	29.05	-7.01	22.04	37.00	-14.96	peak	
6		285.9400	26.53	-5.28	21.25	37.00	-15.75	peak	



EUT	DIGITAL CAMERA	Model Name	EX-FR10
Temperature	25° C	Relative Humidity	65%
Test Voltage	AC 120V/60Hz		
Test Mode	CHARGE(Power off)		

Polarization: Vertical

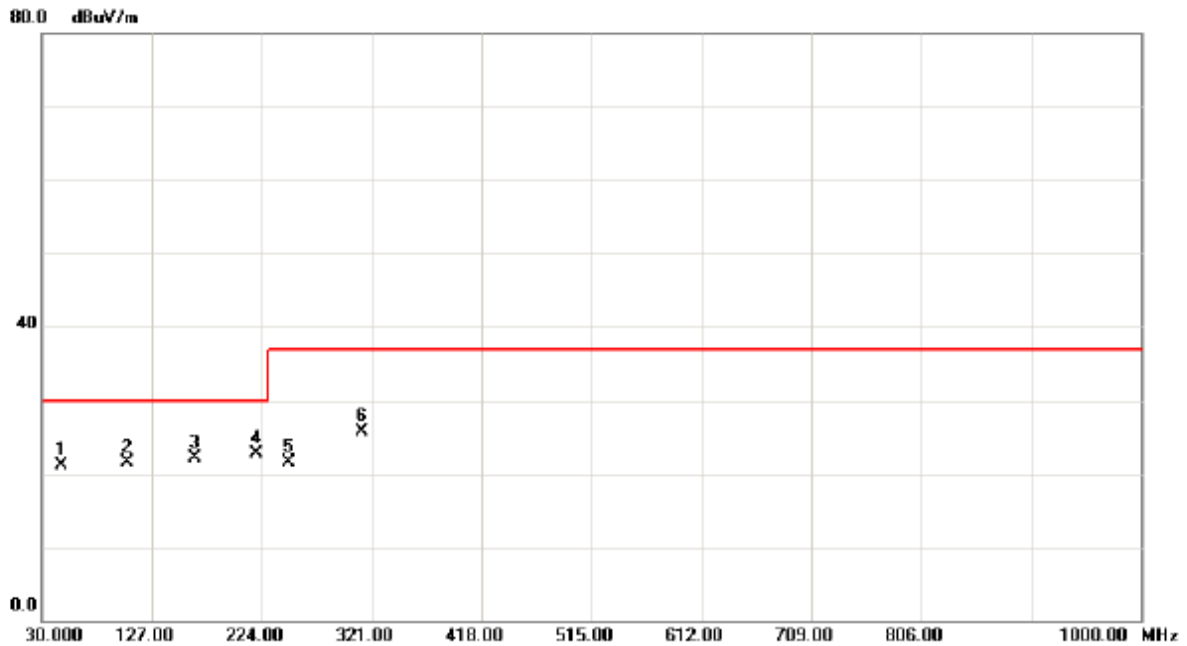

No.	Mk.	Freq. MHz	Reading Level dBuV	Correct Factor dB	Measure- ment dBuV/m	Limit dBuV/m	Over dB	Detector	Comment
1		46.9900	28.98	-7.95	21.03	30.00	-8.97	peak	
2		106.2700	28.99	-7.46	21.53	30.00	-8.47	peak	
3		165.5500	24.33	-2.18	22.15	30.00	-7.85	peak	
4	*	218.9000	29.68	-6.90	22.78	30.00	-7.22	peak	
5		248.5400	28.26	-6.73	21.53	37.00	-15.47	peak	
6		311.9700	30.20	-4.59	25.61	37.00	-11.39	peak	



EUT	DIGITAL CAMERA	Model Name	EX-FR10
Temperature	25° C	Relative Humidity	65%
Test Voltage	AC 120V/60Hz		
Test Mode	CHARGE(Power off)		

Polarization: Horizontal

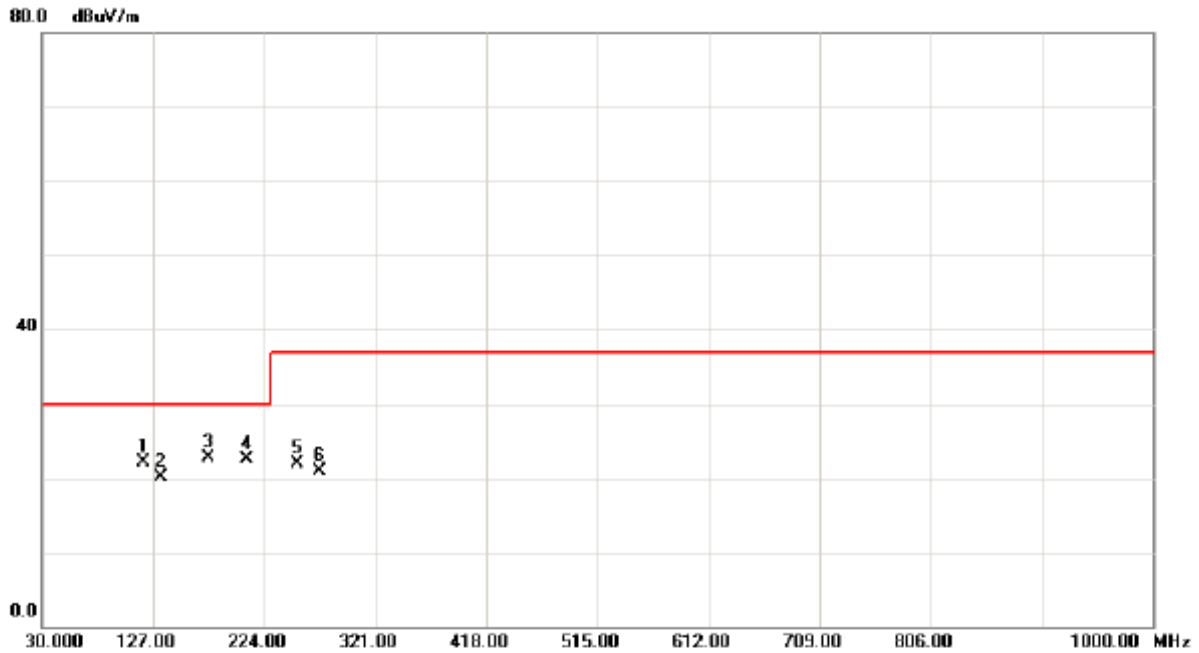

No.	Mk.	Freq. MHz	Reading Level dBuV	Correct Factor dB	Measure- ment dBuV/m	Limit dBuV/m	Over dB	Detector	Comment
1		118.1200	29.51	-7.43	22.08	30.00	-7.92	peak	
2		134.7200	24.56	-4.45	20.11	30.00	-9.89	peak	
3	*	175.6300	27.12	-4.44	22.68	30.00	-7.32	peak	
4		209.4200	28.43	-5.87	22.56	30.00	-7.44	peak	
5		253.2900	28.46	-6.52	21.94	37.00	-15.06	peak	
6		272.2600	26.67	-5.83	20.84	37.00	-16.16	peak	



EUT	DIGITAL CAMERA	Model Name	EX-FR10
Temperature	25° C	Relative Humidity	65%
Test Voltage	DC 3.7V		
Test Mode	WIFI LINK		

Polarization: Vertical

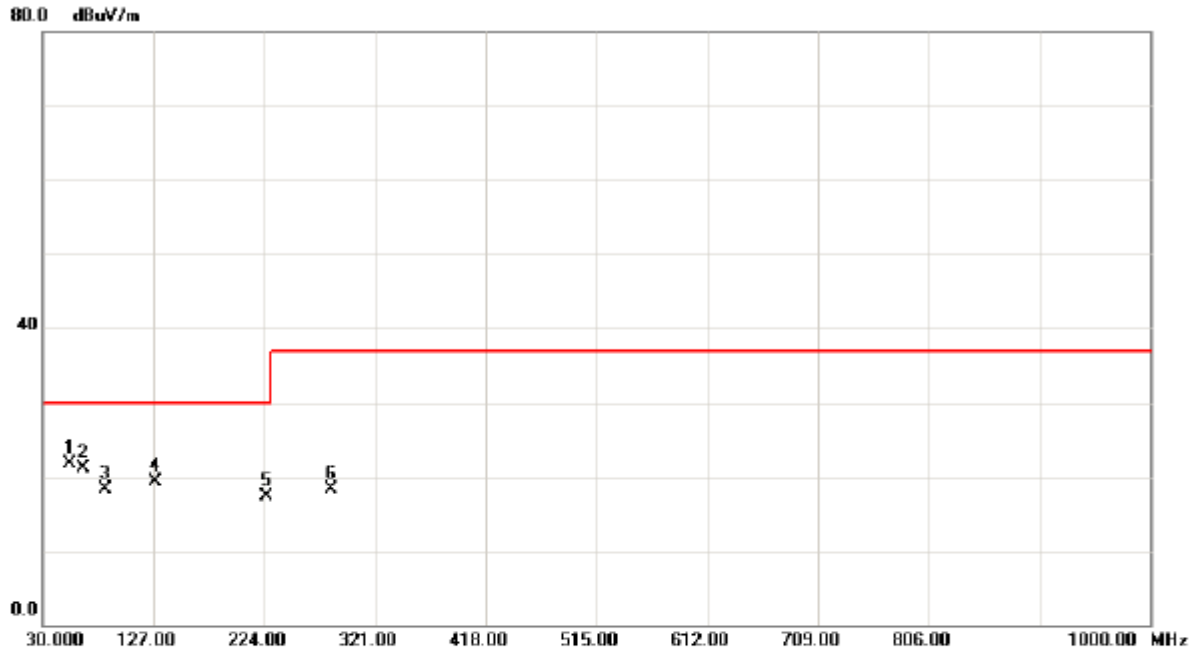

No.	Mk.	Freq. MHz	Reading Level dBuV	Correct Factor dB	Measure- ment dBuV/m	Limit dBuV/m	Over dB	Detector	Comment
1	*	54.4530	29.51	-7.85	21.66	30.00	-8.34	peak	
2		65.9560	30.75	-9.69	21.06	30.00	-8.94	peak	
3		85.2530	28.00	-9.76	18.24	30.00	-11.76	peak	
4		129.1500	24.96	-5.66	19.30	30.00	-10.70	peak	
5		225.4600	24.50	-7.15	17.35	30.00	-12.65	peak	
6		283.2400	23.67	-5.37	18.30	37.00	-18.70	peak	



EUT	DIGITAL CAMERA	Model Name	EX-FR10
Temperature	25° C	Relative Humidity	65%
Test Voltage	DC 3.7V		
Test Mode	WIFI LINK		

Polarization: Horizontal

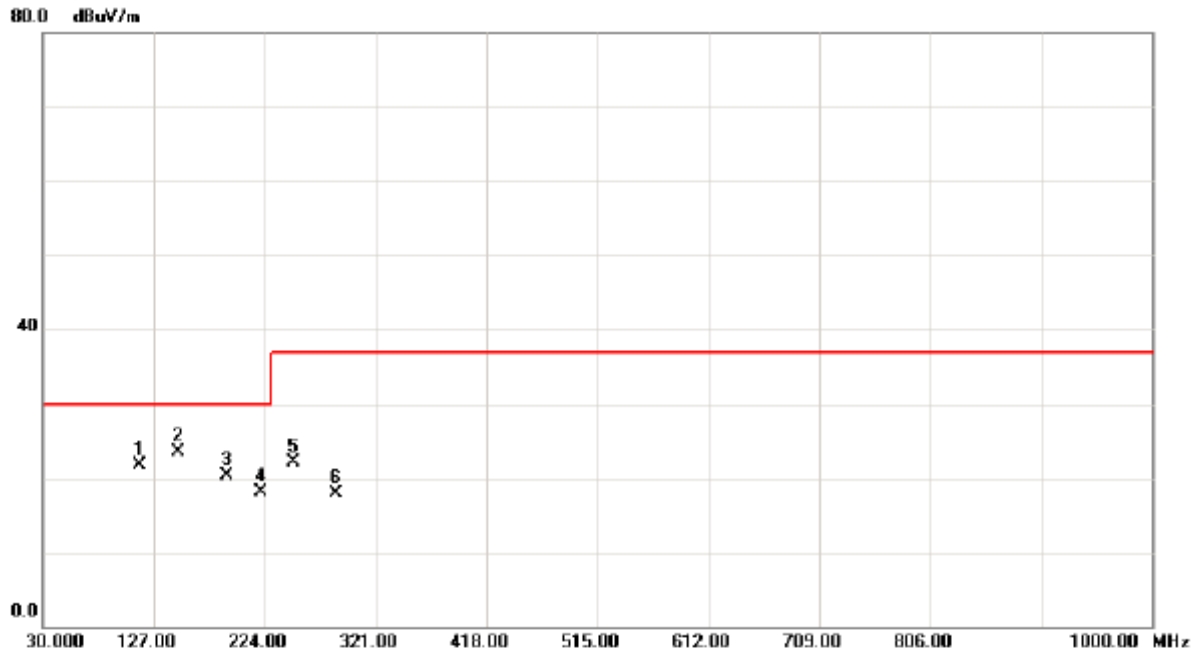

No.	Mk.	Freq. MHz	Reading Level dBuV	Correct Factor dB	Measure- ment dBuV/m	Limit dBuV/m	Over dB	Detector	Comment
1		114.5100	29.18	-7.44	21.74	30.00	-8.26	peak	
2	*	148.8000	25.40	-1.87	23.53	30.00	-6.47	peak	
3		191.5600	27.11	-6.77	20.34	30.00	-9.66	peak	
4		220.4500	25.20	-7.04	18.16	30.00	-11.84	peak	
5		249.3400	28.71	-6.69	22.02	37.00	-14.98	peak	
6		286.7100	23.24	-5.26	17.98	37.00	-19.02	peak	



EUT	DIGITAL CAMERA	Model Name	EX-FR10
Temperature	25° C	Relative Humidity	65%
Test Voltage	AC 120V/60Hz		
Test Mode	Mass Storage(PC Link)		

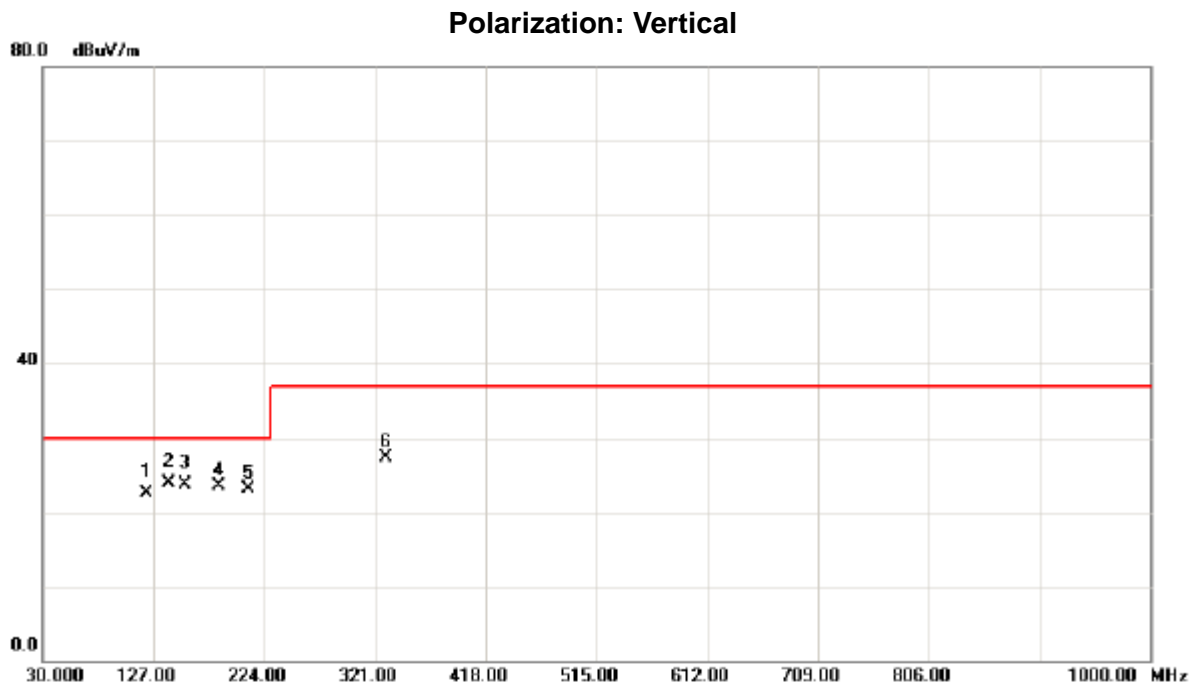

No.	Mk.	Freq. MHz	Reading Level dBuV	Correct Factor dB	Measure- ment dBuV/m	Limit dBuV/m	Over dB	Detector	Comment
1		120.2700	29.92	-7.35	22.57	30.00	-7.43	QP	
2	*	138.6600	27.36	-3.55	23.81	30.00	-6.19	QP	
3		153.9900	24.90	-1.21	23.69	30.00	-6.31	QP	
4		184.6500	29.34	-5.78	23.56	30.00	-6.44	peak	
5		209.9400	28.83	-5.81	23.02	30.00	-6.98	peak	
6		331.2000	31.45	-4.18	27.27	37.00	-9.73	peak	



EUT	DIGITAL CAMERA	Model Name	EX-FR10
Temperature	25° C	Relative Humidity	65%
Test Voltage	AC 120V/60Hz		
Test Mode	Mass Storage(PC Link)		

Polarization: Horizontal

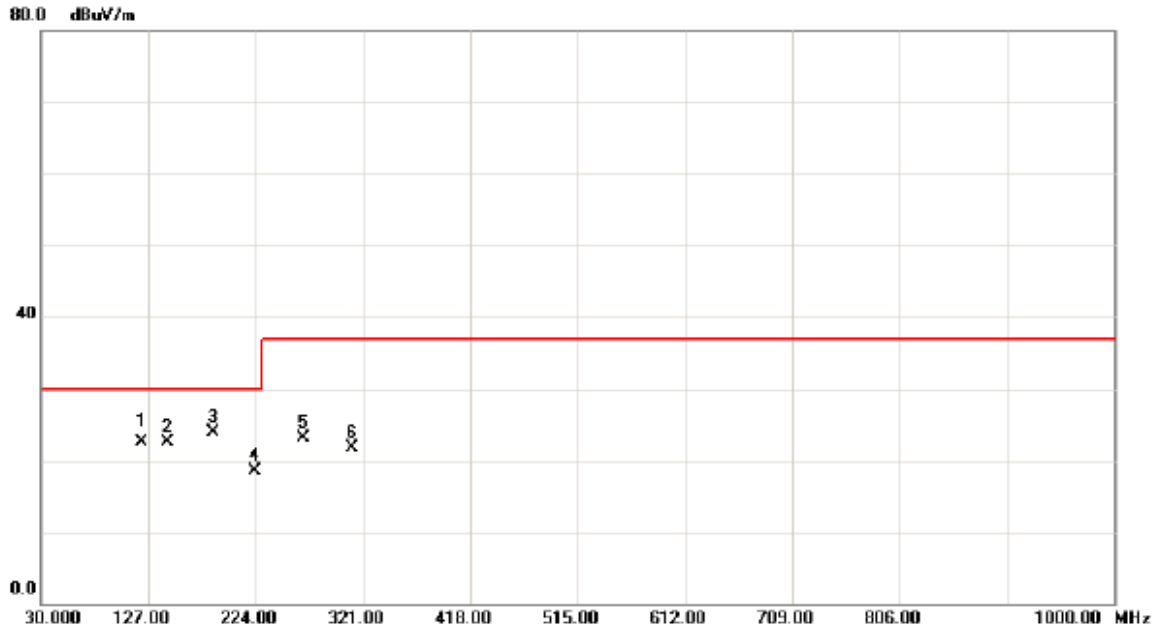

No. Mk.	Freq. MHz	Reading Level dBuV	Correct Factor dB	Measurement dBuV/m	Limit dBuV/m	Over dB	Detector	Comment
1	120.0000	29.94	-7.41	22.53	30.00	-7.47	QP	
2	144.3300	25.07	-2.57	22.50	30.00	-7.50	peak	
3 *	185.3300	29.74	-5.90	23.84	30.00	-6.16	peak	
4	223.1400	25.61	-7.10	18.51	30.00	-11.49	peak	
5	267.4900	29.11	-6.03	23.08	37.00	-13.92	peak	
6	311.5600	26.40	-4.60	21.80	37.00	-15.20	peak	



4.2.8 TEST RESULTS-ABOVE 1 GHZ

EUT	DIGITAL CAMERA	Model Name	EX-FR10
Temperature	25° C	Relative Humidity	65%
Test Voltage	DC 3.7V		
Test Mode	PLAYBACK		

Polarization: Vertical

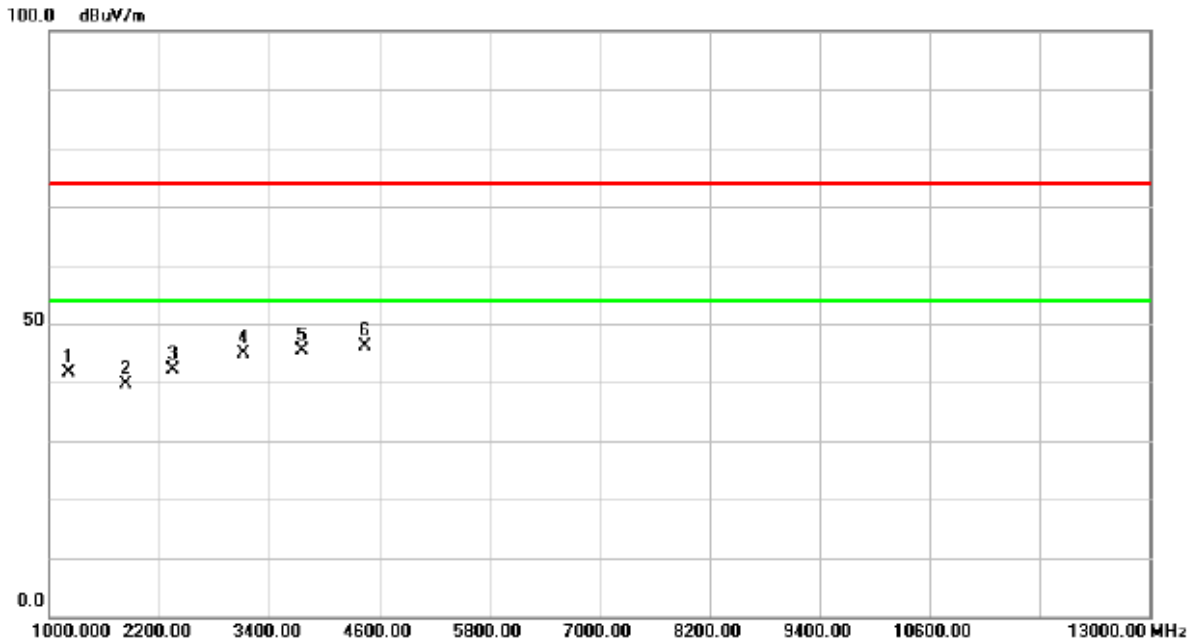

No.	Mk.	Freq. MHz	Reading Level dBuV	Correct Factor dB	Measure- ment dBuV/m	Limit dBuV/m	Over dB	Detector	Comment
1		1220.000	46.82	-5.14	41.68	74.00	-32.32	peak	
2		1840.000	42.17	-2.59	39.58	74.00	-34.42	peak	
3		2355.000	42.52	-0.50	42.02	74.00	-31.98	peak	
4		3115.000	41.36	3.40	44.76	74.00	-29.24	peak	
5		3758.000	40.01	5.38	45.39	74.00	-28.61	peak	
6	*	4450.000	39.80	6.37	46.17	74.00	-27.83	peak	



EUT	DIGITAL CAMERA	Model Name	EX-FR10
Temperature	25° C	Relative Humidity	65%
Test Voltage	DC 3.7V		
Test Mode	PLAYBACK		

Polarization: Horizontal

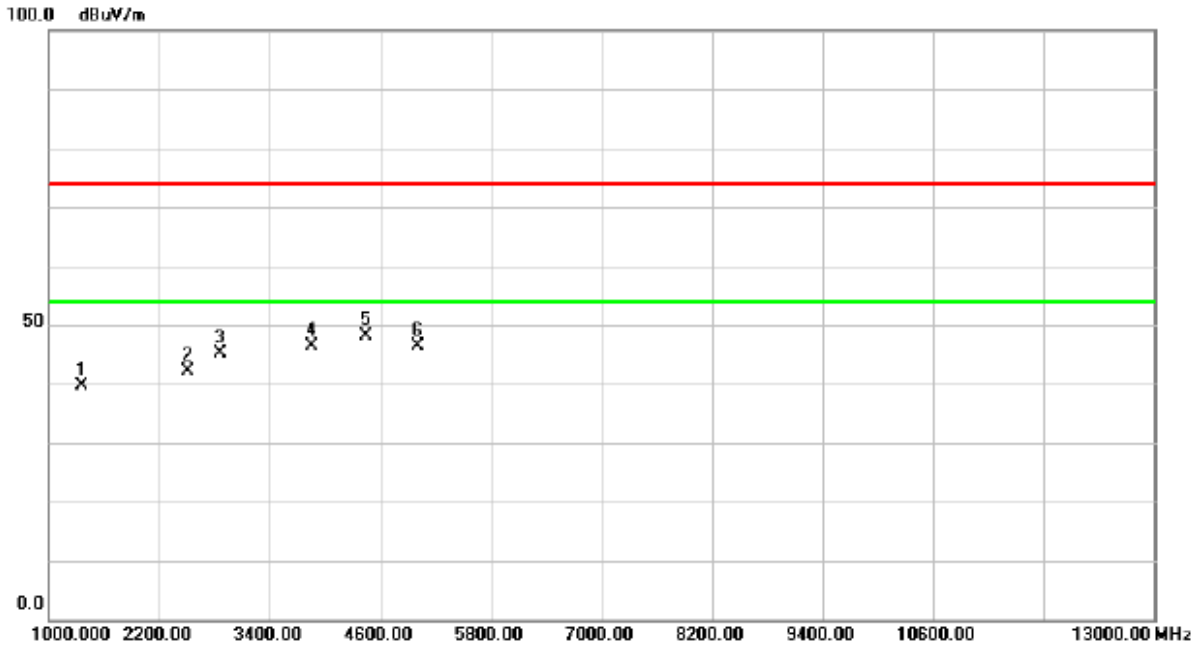

No. Mk.	Freq. MHz	Reading Level dBuV	Correct Factor dB	Measure- ment dBuV/m	Limit dBuV/m	Over dB	Detector	Comment
1	1355.000	44.42	-4.75	39.67	74.00	-34.33	peak	
2	2505.000	42.02	0.03	42.05	74.00	-31.95	peak	
3	2870.000	42.78	2.33	45.11	74.00	-28.89	peak	
4	3860.000	40.54	5.83	46.37	74.00	-27.63	peak	
5 *	4450.000	41.68	6.37	48.05	74.00	-25.95	peak	
6	5000.000	38.32	8.07	46.39	74.00	-27.61	peak	



EUT	DIGITAL CAMERA	Model Name	EX-FR10
Temperature	25° C	Relative Humidity	65%
Test Voltage	DC 3.7V		
Test Mode	RECORD		

Polarization: Vertical

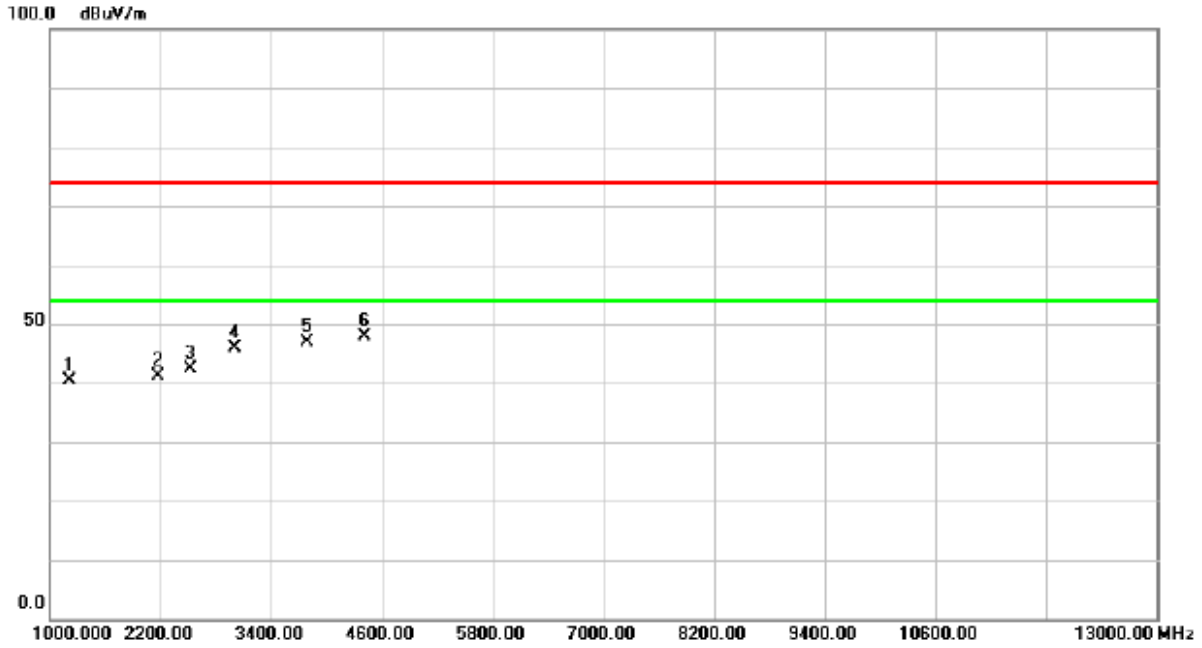

No.	Mk.	Freq. MHz	Reading Level dBuV	Correct Factor dB	Measure- ment dBuV/m	Limit dBuV/m	Over dB	Detector	Comment
1		1210.000	45.50	-5.17	40.33	74.00	-33.67	peak	
2		2170.000	42.17	-1.16	41.01	74.00	-32.99	peak	
3		2530.000	42.18	0.19	42.37	74.00	-31.63	peak	
4		3010.000	42.62	3.17	45.79	74.00	-28.21	peak	
5		3790.000	41.30	5.52	46.82	74.00	-27.18	peak	
6	*	4420.000	41.52	6.38	47.90	74.00	-26.10	peak	



EUT	DIGITAL CAMERA	Model Name	EX-FR10
Temperature	25° C	Relative Humidity	65%
Test Voltage	DC 3.7V		
Test Mode	RECORD		

Polarization: Horizontal

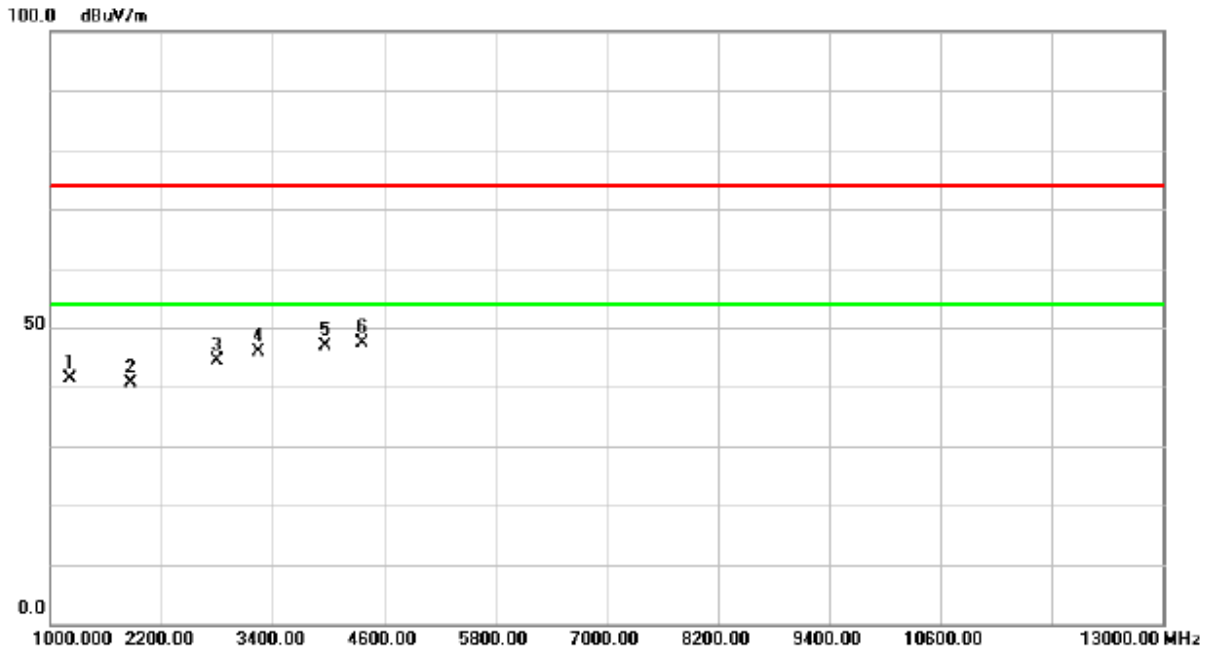

No.	Mk.	Freq. MHz	Reading Level dBuV	Correct Factor dB	Measure- ment dBuV/m	Limit dBuV/m	Over dB	Detector	Comment
1		1210.000	46.63	-5.17	41.46	74.00	-32.54	peak	
2		1870.000	43.09	-2.44	40.65	74.00	-33.35	peak	
3		2800.000	42.59	1.89	44.48	74.00	-29.52	peak	
4		3250.000	42.30	3.69	45.99	74.00	-28.01	peak	
5		3970.000	40.56	6.31	46.87	74.00	-27.13	peak	
6	*	4360.000	40.92	6.38	47.30	74.00	-26.70	peak	



EUT	DIGITAL CAMERA	Model Name	EX-FR10
Temperature	25° C	Relative Humidity	65%
Test Voltage	DC 3.7V		
Test Mode	WIFI LINK		

Polarization: Vertical



No. Mk.	Freq. MHz	Reading Level dBuV	Correct Factor dB	Measurement dBuV/m	Limit dBuV/m	Over dB	Detector	Comment
1	1210.000	47.43	-5.17	42.26	74.00	-31.74	peak	
2	1840.000	41.01	-2.59	38.42	74.00	-35.58	peak	
3	2440.000	43.02	-0.21	42.81	74.00	-31.19	peak	
4	3070.000	42.54	3.30	45.84	74.00	-28.16	peak	
5	3820.000	40.89	5.65	46.54	74.00	-27.46	peak	
6 *	4300.000	41.65	6.40	48.05	74.00	-25.95	peak	



EUT	DIGITAL CAMERA	Model Name	EX-FR10
Temperature	25° C	Relative Humidity	65%
Test Voltage	DC 3.7V		
Test Mode	WIFI LINK		

Polarization: Horizontal

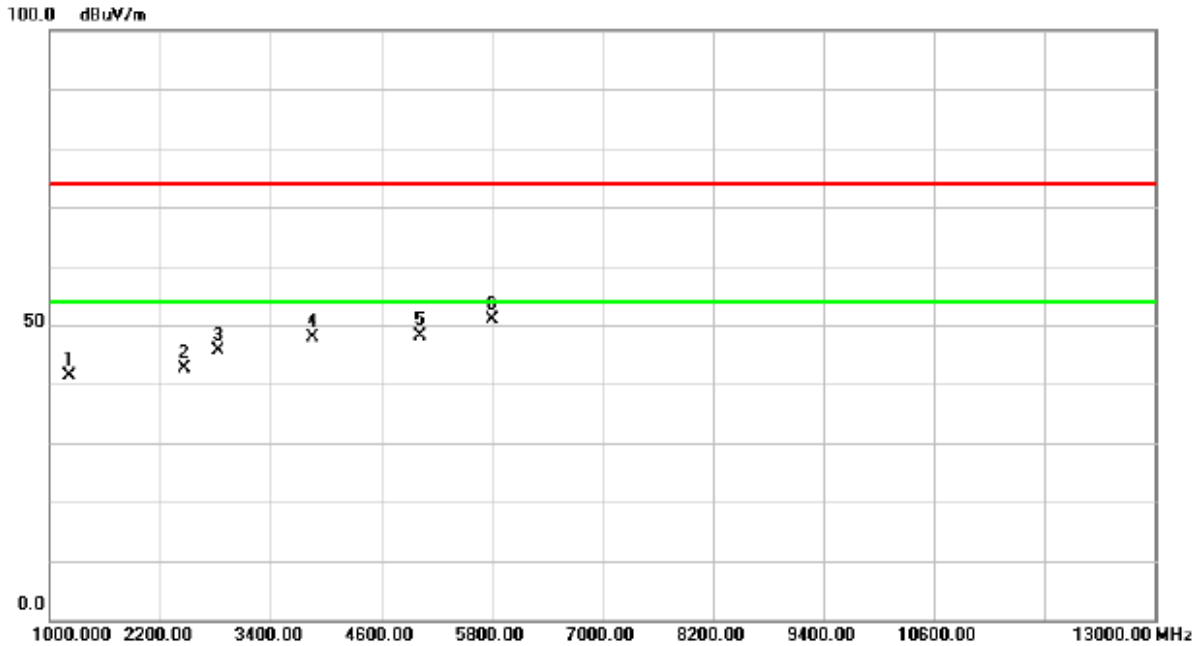

No.	Mk.	Freq. MHz	Reading Level dBuV	Correct Factor dB	Measure- ment dBuV/m	Limit dBuV/m	Over dB	Detector	Comment
1		1210.000	46.66	-5.17	41.49	74.00	-32.51	peak	
2		2470.000	42.68	-0.10	42.58	74.00	-31.42	peak	
3		2830.000	43.53	2.08	45.61	74.00	-28.39	peak	
4		3850.000	42.12	5.78	47.90	74.00	-26.10	peak	
5		5020.000	40.12	8.09	48.21	74.00	-25.79	peak	
6	*	5800.000	41.29	9.61	50.90	74.00	-23.10	peak	



EUT	DIGITAL CAMERA	Model Name	EX-FR10
Temperature	25° C	Relative Humidity	65%
Test Voltage	AC 120V/60Hz		
Test Mode	Mass Storage(PC Link)		

Polarization: Vertical



No.	Mk.	Freq. MHz	Reading Level dBuV	Correct Factor dB	Measure- ment dBuV/m	Limit dBuV/m	Over dB	Detector	Comment
1		1215.000	47.67	-5.16	42.51	74.00	-31.49	peak	
2		1835.000	41.32	-2.62	38.70	74.00	-35.30	peak	
3		2445.000	42.35	-0.19	42.16	74.00	-31.84	peak	
4		3080.000	41.95	3.33	45.28	74.00	-28.72	peak	
5		3830.000	40.67	5.70	46.37	74.00	-27.63	peak	
6	*	4500.000	41.32	6.37	47.69	74.00	-26.31	peak	



EUT	DIGITAL CAMERA	Model Name	EX-FR10
Temperature	25° C	Relative Humidity	65%
Test Voltage	AC 120V/60Hz		
Test Mode	Mass Storage(PC Link)		

Polarization: Horizontal

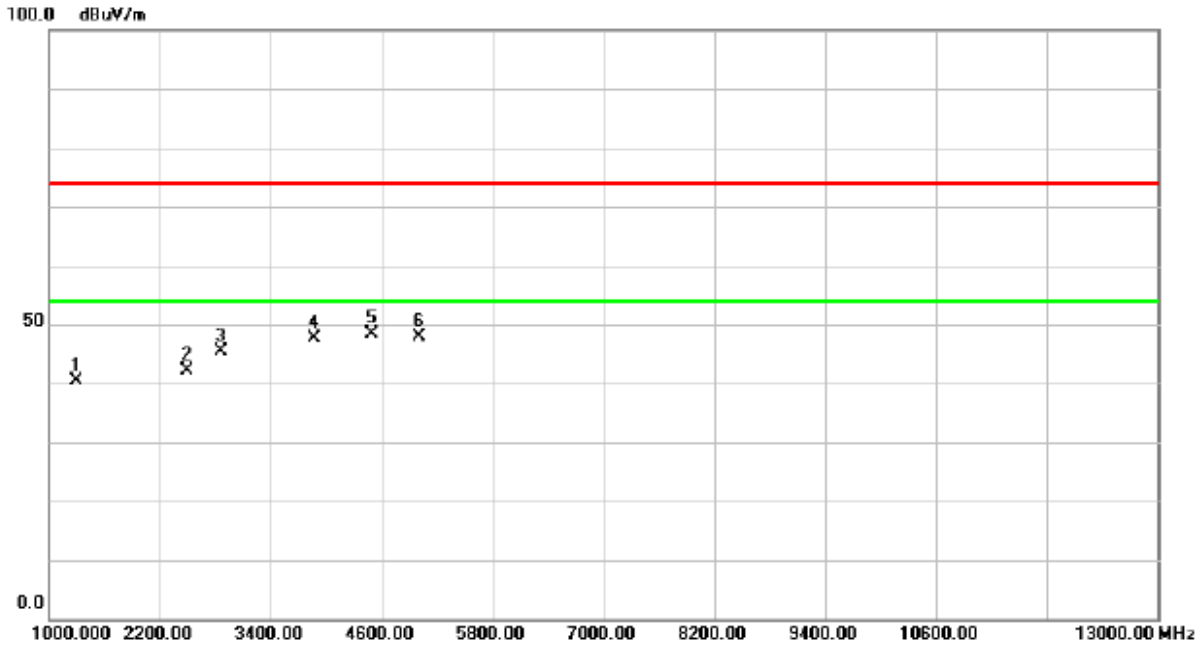

No.	Mk.	Freq. MHz	Reading Level dBuV	Correct Factor dB	Measure- ment dBuV/m	Limit dBuV/m	Over dB	Detector	Comment
1		1300.000	45.28	-4.92	40.36	74.00	-33.64	peak	
2		2500.000	42.11	0.00	42.11	74.00	-31.89	peak	
3		2860.000	43.02	2.26	45.28	74.00	-28.72	peak	
4		3870.000	41.74	5.87	47.61	74.00	-26.39	peak	
5	*	4500.000	41.99	6.37	48.36	74.00	-25.64	peak	
6		5000.000	39.82	8.07	47.89	74.00	-26.11	peak	