



TEST REPORT

REPORT NUMBER : ANKK-102271
APPLICANT : CASIO COMPUTER CO., LTD.
MODEL NUMBER : DT-X10M30U
FCC ID : BBQDT-X10M30U
REGULATION : FCC Part15C Section 15.247



NVLAP accreditation is valid for
FCC Part15 (Digital Devices),
CISPR22 and AS/NZS 3548.
NVLAP accreditation does not cover
ICES-003.

Akzo Nobel K. K.
EMC Division
Kashima Site

1, Oaza Sunayama, Hasaki-machi, Kashima-gun
Ibaraki-ken, 314-0255 Japan
Tel.: +81 479 40 1097 Fax.: +81 479 46 1788

TABLE OF CONTENTS

	Page
ABBREVIATIONS.....	3
SECTION 1. TEST CERTIFICATION	4
SECTION 2. SUMMARY OF RESULTS	5
SECTION 3. EQUIPMENT UNDER TEST.....	6
SECTION 4. SUPPORT EQUIPMENT USED.....	9
SECTION 5. CABLE (S) USED	10
SECTION 6. CONSTRUCTION OF EQUIPMENT.....	11
SECTION 7. GENERAL TEST CONDITIONS	12
SECTION 8. TEST PROCEDURE(S)	14
SECTION 9. TEST DATA.....	16
9.1 20dB Bandwidth [15.247(a)(1)(ii)]	16
9.2 Carrier Frequency Separation [15.247(a)(1)]	19
9.3 Number of Hopping Frequencies [15.247(a)(1)(ii)].....	21
9.4 Time of Occupancy (Dwell Time) [15.247(a)(1)(ii)].....	26
9.5 Maximum Peak Output Power – RF Antenna Conducted [15.247(b)(1)]	30
9.6 Band Edge Compliance of RF Conducted Emissions [15.247(c)]	32
9.7 Spurious Emissions – RF Antenna Conducted Test [15.247(c)]	34
9.8 Spurious Emissions – Radiated Emission Test [15.247(c), 15.205, 15.209]	36
9.9 Restricted Bands of Operation [15.247(c),15.205,15.209].....	41
9.10 Power Spectral Density [15.247(f), 15.247(d)].....	44
SECTION 10. MEASUREMENT UNCERTAINTY.....	47
SECTION 11. DESCRIPTION OF TEST LABORATORY	48

ABBREVIATIONS

LISN = Line Impedance Stabilization Network

AMN = Artificial Mains Network

ANT = Antenna

BBA = Broad-band Antenna

DIP = Dipole Antenna

AMP = Amplifier

ATT = Attenuator

EUT = Equipment Under Test

Q-P = Quasi-peak

AVG = Average

ch = Channel

SECTION 1. TEST CERTIFICATION

APPLICANT INFORMATION

Company	: CASIO COMPUTER CO., LTD.
Address	: 3-2-1, Sakae-cho, Hamura-shi, Tokyo, 205-0002 Japan

DESCRIPTION OF TEST ITEM

Kind of equipment	: Handheld Terminal
Condition of equipment	: Pre-Production
Type	: Table-Top (Handheld type)
Trademark	: CASIO
FCC ID	: BBQDT-X10M30U
Model number	: DT-X10M30U
Serial number	: CS139

TEST PERFORMED

Location	: Kashima No. 3 Test Site (FCC Reg. No. : 90433)
EUT received	: November 5, 2002
Test started	: November 5, 2002
Test completed	: November 12, 2002
Regulation	: FCC Part15 Subpart C Section 15.247 Intentional Radiators
Test setup	: ANSI C63.4-1992

Report issue date : December 2, 2002

Test engineer : Kazuo Masuda



Report approved by : Kazuhiro Ando
[Site Assistant Manager]



On the basis of the measurements made, the equipment tested is capable of operation in compliance with the requirements of Part 15 of the FCC Rules under normal use and maintenance.

Note

- a. The test result of this report is effective for equipment under test itself and under the test configuration described on the report.
- b. This test report does not assure that whether the test result taken in other testing laboratory is compatible or reproducible to the test result on this report or not.
- c. This test report shall not be reproduced except in full, without issuer's permission.

SECTION 2. SUMMARY OF RESULTS

Test	Reference	Result
AC Conducted Emission	15.207	N/A for battery operated device
20dB Bandwidth	15.247(a)(1)(ii)	Pass
Carrier Frequency Separation	15.247(a)(1)	Pass
Number of Hopping Frequencies	15.247(a)(1)(ii)	Pass
Time of Occupancy (Dwell Time)	15.247(a)(1)(ii) 15.247(f)	Pass
Maximum Peak Output Power -RF Antenna Conducted	15.247(b)(1)	Pass
Band Edge Compliance of RF Conducted Emissions	15.247(c)	Pass
Spurious Emissions - RF Antenna Conducted Test	15.247(c)	Pass
Spurious Emissions - Radiated Emission Test	15.247(c) 15.205 15.209	Pass
Restricted Bands of Operation	15.247(c) 15.205 15.209	Pass
Power Spectral Density	15.247(d) 15.247(f)	Pass

Note : As for the FCC Part 15 Subpart B-Unintentional Radiators, the EUT has been measured and declared as DoC by CASIO COMPUTER CO., LTD.

SECTION 3. EQUIPMENT UNDER TEST

The equipment under test (EUT) consisted of the following equipment.
Indication in the following left side column corresponds to Section 6.

Symbol	Item	Model No.	Serial No.	FCC ID / DoC	Manufacturer	Remarks
A)	Handheld Terminal	DT-X10M30U	CS139	BBQDT-X10M30U	CASIO COMPUTER CO., LTD.	

Power ratings of EUT : DC 3.7V / 5V (1.5A)

DoC : Device for Declaration of Conformity

3.1 Overview of EUT

Frequency Range	2402 – 2480 MHz
Communication Method	Bluetooth specification Ver.1.1
Number of RF Channel	79
Carrier Spacing	1.0 MHz
Modulation Method	Gaussian Frequency Shift Keying (GFSK)
Spread Method	Frequency Hopping Spread Spectrum (FHSS)
Nominal Hop Rate	1600 hops/s
Symbol Rate on channel	1Mbps
Receiver Input Bandwidth	1 MHz
Output Power	0.57mW
Antenna Gain	-0.95dBi

3.2 Operating channels and frequencies

Ch	Frequency (GHz)	Ch	Frequency (GHz)	Ch	Frequency (GHz)
1	2.402	28	2.429	55	2.456
2	2.403	29	2.430	56	2.457
3	2.404	30	2.431	57	2.458
4	2.405	31	2.432	58	2.459
5	2.406	32	2.433	59	2.460
6	2.407	33	2.434	60	2.461
7	2.408	34	2.435	61	2.462
8	2.409	35	2.436	62	2.463
9	2.410	36	2.437	63	2.464
10	2.411	37	2.438	64	2.465
11	2.412	38	2.439	65	2.466
12	2.413	39	2.440	66	2.467
13	2.414	40	2.441	67	2.468
14	2.415	41	2.442	68	2.469
15	2.416	42	2.443	69	2.470
16	2.417	43	2.444	70	2.471
17	2.418	44	2.445	71	2.472
18	2.419	45	2.446	72	2.473
19	2.420	46	2.447	73	2.474
20	2.421	47	2.448	74	2.475
21	2.422	48	2.449	75	2.476
22	2.423	49	2.450	76	2.477
23	2.424	50	2.451	77	2.478
24	2.425	51	2.452	78	2.479
25	2.426	52	2.453	79	2.480
26	2.427	53	2.454		
27	2.428	54	2.455		

Note:

1. This is for sure that all frequencies are in 2.402GHz to 2.480GHz.
2. Section 15.31(m): Measurements on intentional radiators or receivers shall be performed at three frequencies for operating frequency range over 10 MHz. (The locations of these frequencies one near the low, one near the middle and one near the high.)
3. After test, the EUT operating frequencies are in 2.402GHz to 2.480GHz. So all the items as followed in testing report are need to test these three frequencies: low: ch 1, middle: ch 40, high: ch 79.

3.3 Port(s)/Connector(s) :

Port name	Connector type	Connector pin	Remarks
USB	mini B	5 pin	
Earphones Jack	mini pin-Jack	1 pin	

3.4 Oscillator(s)/Crystal(s) :

Oscillator	Operating frequency	Board name	Remarks
32.768 kHz	32.768 kHz	Main Board	Real Time Clock
3.68 MHz	25 MHz	Main Board	Audio
	50 MHz	Main Board	System
	100 MHz	Main Board	Memory Access
16 MHz	2402 – 2480 MHz	Main Board	Bluetooth Module Highest frequency

3.5 Variation of Model(s) :

Model	Scanning Method	Remarks
DT-X10M30U	2 dimensions	Tested model
DT-X10M20U	1 dimension	

SECTION 4. SUPPORT EQUIPMENT USED

The EUT was supported by the following equipment during the test.
Indication in the following left side column corresponds to Section 6.

Symbol	Item	Model No.	Serial No.	FCC ID / DoC	Manufacturer	Remarks
B)	Headset	RBEM07	None	N.A.	Telephone Lease	
C)	Computer	DCS	TG3VG	DoC	Dell Computer Corporation	
D)	CRT Display	6543-476	97-48819	BEJCS587J	IBM CORPORATION	
E)	Keyboard	SK-1000REW	M970431006	GYUR36SK	Dell Computer Corporation	
F)	Mouse	Mouse Port Compatible Mouse 2.1A	3406976-00000	C3KKMP1	Microsoft	
G)	Printer	C3941A	JPCD204480	B94C3941A	HEWLETT PACKARD	

DoC : Device was tested and authorized under a Declaration of Conformity to the applicable FCC rules.

SECTION 5. CABLE (S) USED

The following cable(s) was used for the test.

Indication number in the following left side column corresponds to Section 6.

Number	Name	Length	Shield	Connector	Core
1)	USB cable	2.00 m	Yes	Metal	Fixed × 2
2)	Headset cable	1.10 m	None	Metal	
3)	Video cable	1.80 m	Yes	Metal	Fixed × 2
4)	Keyboard cable	1.80 m	Yes	Metal	
5)	Mouse cable	1.90 m	Yes	Metal	
6)	Centronics cable	2.40 m	Yes	Metal	
7)	Power cable for Computer	1.80 m	None		
8)	Power cable for CRT Display	2.30 m	None		
9)	Power cable for Printer	2.20 m	None		

SECTION 6. CONSTRUCTION OF EQUIPMENT

The construction of EUT during the test was as follows.

System configuration

* : EUT
 ■ : Ferrite core

6.1 System use

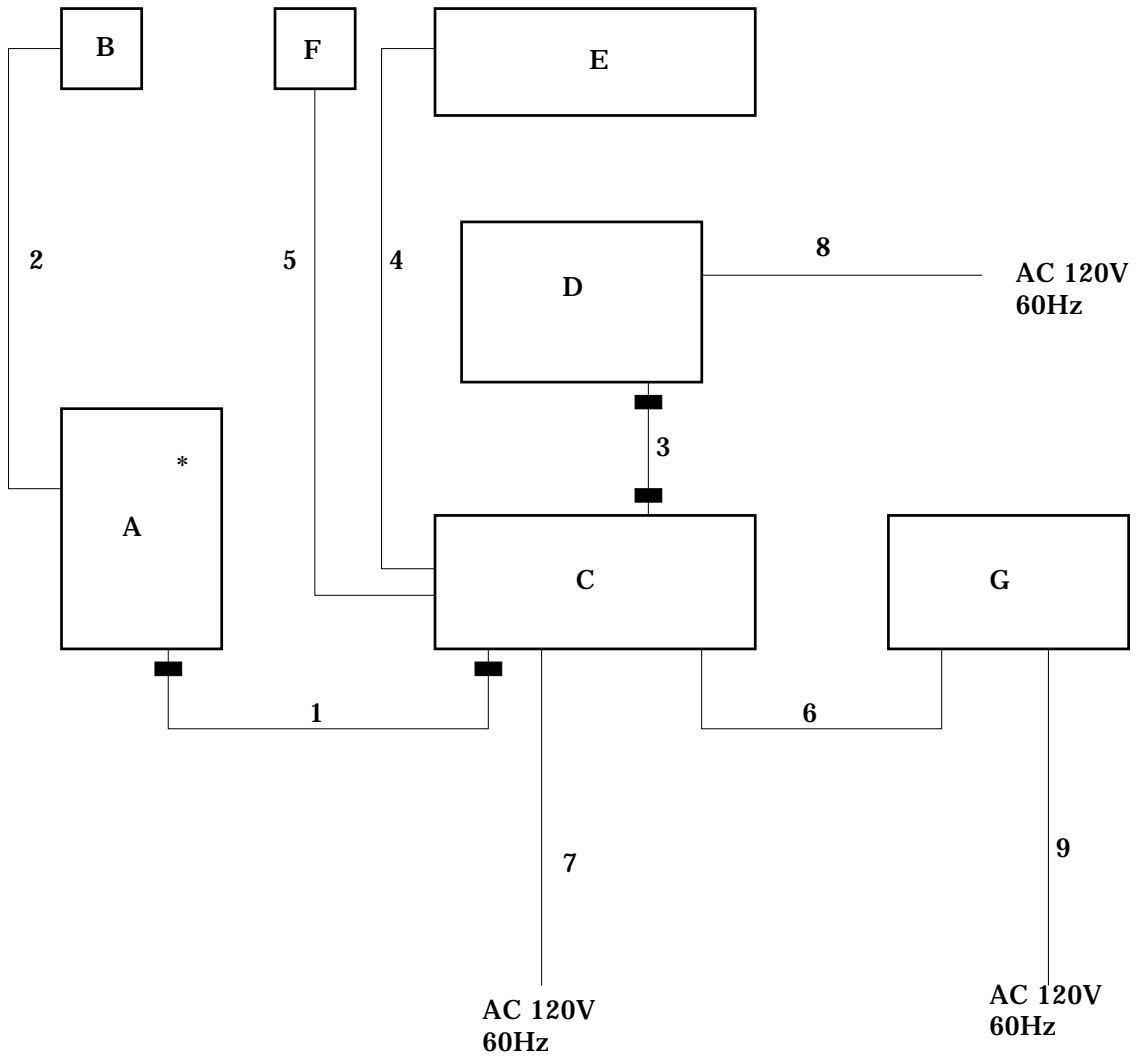

6.2 Single use

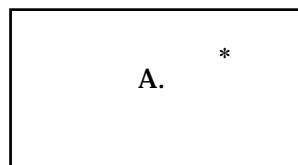

Symbols or numbers assigned to equipment or cables on this diagram are corresponded to the symbols or numbers assigned to equipment or cables on tables in Sections 3 to 5.

SECTION 7. GENERAL TEST CONDITIONS

The EUT was operated under the following conditions during the test.

7.1 Operating condition

The test was carried out under Test mode, Inquiry mode and Page mode.
EUT was examined in the operating conditions that had maximum emissions.

7.2 Operating flow

7.2.1 Test mode

Following programs were performed continuously.

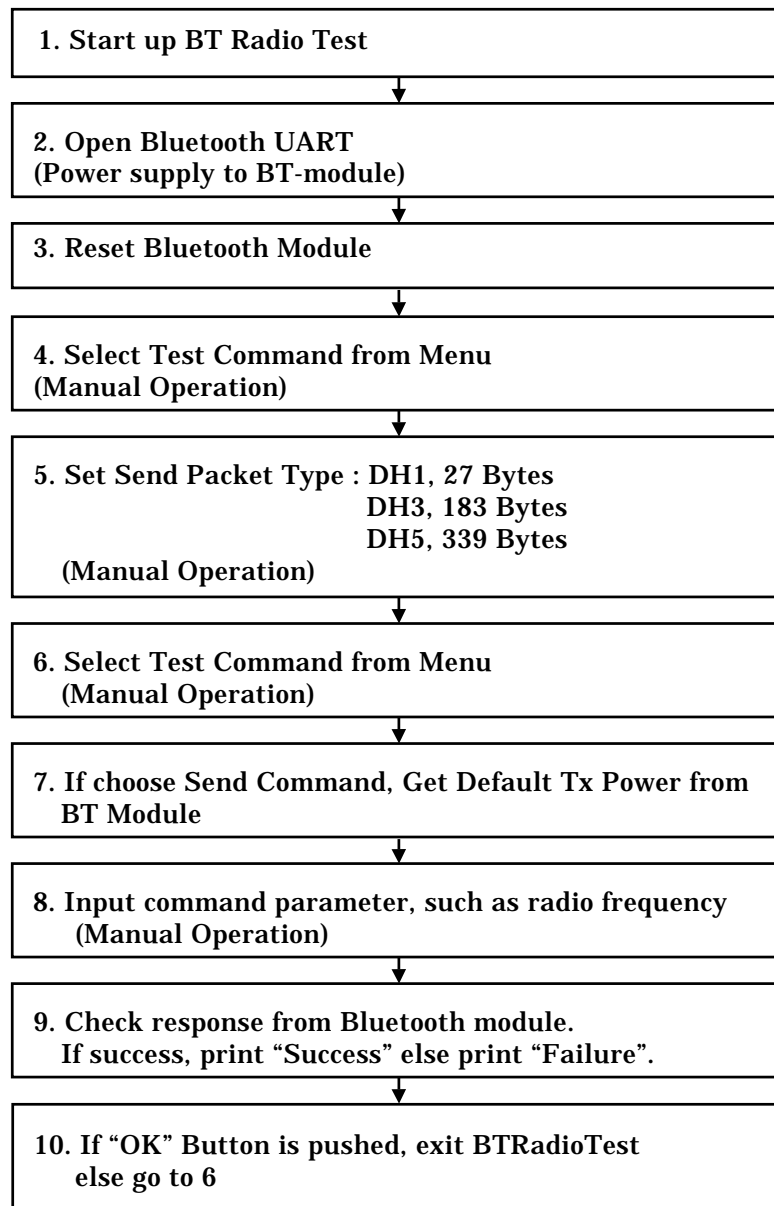

Example of a hopping sequence in data mode

Example of a 79 hopping sequence in data mode:

40, 21, 44, 23, 42, 53, 46, 55, 48, 33, 52, 35, 50, 65, 54, 67, 56, 37, 60, 39, 58, 69, 62, 71, 64, 25,
68, 27, 66, 57, 70, 59, 72, 29, 76, 31, 74, 61, 78, 63, 01, 41, 05, 43, 03, 73, 07, 75, 09, 45, 13, 47,
11, 77, 15, 00, 64, 49, 66, 53, 68, 02, 70, 06, 01, 51, 03, 55, 05, 04.

7.2.2 Inquiry mode and Page mode

Following programs were performed continuously.

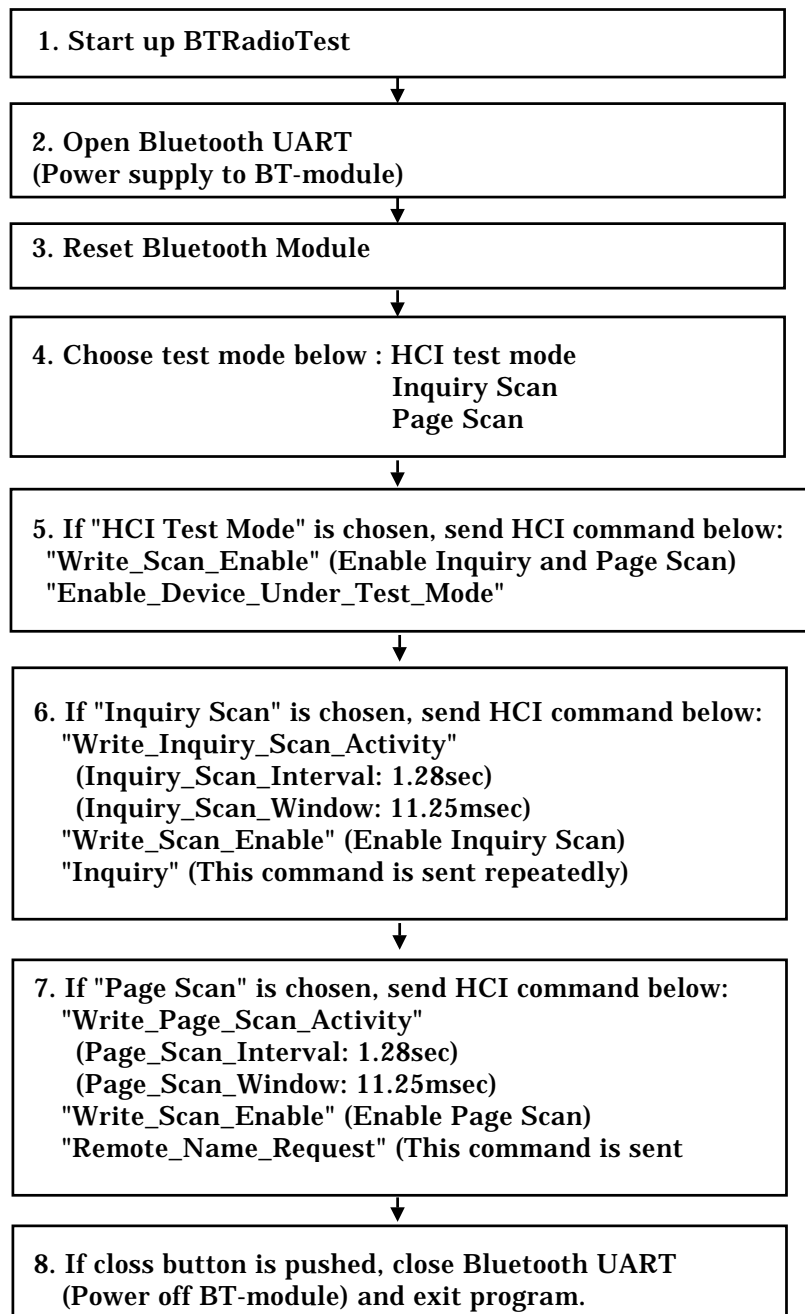

Example of hopping sequence in inquiry mode:

48, 50, 09, 13, 52, 54, 41, 45, 56, 58, 11, 15, 60, 62, 43, 47, 00, 02, 64, 68, 04, 06,
17, 21, 08, 10, 66, 70, 12, 14, 19, 23

Example of hopping sequence in page mode:

08, 57, 68, 70, 51, 02, 42, 40, 04, 61, 44, 46, 63, 14, 50, 48, 16, 65, 52, 54, 67, 18,
58, 56, 20, 53, 60, 62, 55, 06, 66, 64

SECTION 8. TEST PROCEDURE(S)

Test was carried out under the following conditions.

Test was carried out with no deviations from standards and test methods.

8.1 Radiated Emission Test [15.247(b), 15.247(c), 15.205, 15.209]

8.1.1 Equipment Setup

System configuration and Equipment setup are shown on Section 6.

8.1.1.1 Table-Top Equipment

EUT is placed on the wooden table raised 0.8meter above the metal ground plane (turntable).

8.1.1.2 Interconnecting Cables

Excess part of the interconnecting cables longer than 1 meter are bundled in the center. Cables that hang closer than 40 cm to the ground plane is folded back and forth forming bundle 30 to 40 cm long, hanging approx, in the middle between ground plane and table.

8.1.2 Measuring Instruments

Brief description of Measuring Instruments are as follows;

8.1.2.1 Antennas

The Double ridged guide antenna and the Standard gain horn antennas are used for frequency higher than 1000 MHz.

If uncertain result was obtained, the broadband antenna is replaced by the half wave length dipole, then measurement is carried out over again.

8.1.2.2 Pre-amplifier

The broadband pre-amplifier is used for radiated emission measurement.

The signal to noise ratio is improved by using pre-amplifier.

8.1.2.3 Spectrum Analyzer

The spectrum analyzer is used for preliminary measurement of frequency range 30 – 1000 MHz, and also used for final measurement of higher than 1000 MHz

8.1.2.4 EMI Test Receiver

The Quasi-peak detector (IF bandwidth : 120 kHz) built in test receiver is used for final measurement of the frequency 30 – 1000 MHz.

The test receiver is complied with the specification of the CISPR publication 16.

8.1.2.5 Turntable

The turntable is capable for EUT weight and rotatable 0 to 360 degree horizontally by remote control in the test room.

8.1.2.6 Antenna Mast

The antenna mast is attachable to all antennas described on clause 8.2.2.1 and antenna height is adjustable 1 to 4 meters continuously by remote control at the test room, and antenna polarization is also changed by the remote control.

8.1.3 Test Procedure

8.1.3.1 Preliminary Measurement

EUT is tested on all operating conditions.

The spectrum analyzer is set max-hold mode and swept during turntable was rotated 0 to 360 degree. Then spectrum chart are plotted out to detect the worst conditions in configuration, operating mode, or ambient noise notation.

8.1.3.2 Final Measurement

The EUT operated in the condition where maximum emission is detected in the preliminary test.

The turntable azimuth (EUT direction) and antenna height are adjusted the position so that maximum field strength is obtained for each frequency spectrum to be measured. The equipment and cables are arranged or manipulated within the range of the test standard in the above condition.

When the uncertain result was obtained, the measurement is retried by using the half wave dipole antenna instead of the broadband antenna.

SECTION 9. TEST DATA

9.1 20dB Bandwidth [15.247(a)(1)(ii)]

9.1.1 Test mode

MEASUREMENT PROCEDURE:

1. The EUT was set to operate with following conditions.
 - Single use
 - No hopping [ch 1(low), ch 40(mid) and ch 79(high)]
 - DH5 packet (Max. Length of 5 time slots)
2. The Spectrum Analyzer was connected directly to the transmitter output.
3. The Spectrum Analyzer was setup using RBW = 30kHz, VBW = 30kHz, span = 3.0MHz and sweep time = Auto.
4. Following data is the worst case.
5. As for the chart of the observed RF profiles, refer to Annex A.

Test date : November 5, 2002
 Temperature : 21 °C
 Humidity : 48 %

[Modulated-carrier] – DH5 packet (Max. Length of 5 time slots)

ch	Frequency (MHz)	20dB Bandwidth (MHz)	15.247(a)(1) Maximum (MHz)	Chart
1	2402.0	0.950	1	Annex A Page 2
40	2441.0	0.955	1	Annex A Page 2
79	2480.0	0.955	1	Annex A Page 3

9.1.2 Inquiry mode and Page mode

MEASUREMENT PROCEDURE:

1. The EUT was set to operate with following conditions.
 - Single use
 - No hopping [ch 40(mid)]
2. The Spectrum Analyzer was connected directly to the transmitter output.
3. The Spectrum Analyzer was setup using RBW = 30kHz, VBW = 30kHz, span = 3.0MHz and seep time = Auto.
4. As for the chart of the observed RF profiles, refer to Annex A.

Test date : November 5, 2002
 Temperature : 21 °C
 Humidity : 48 %

[Inquiry mode]

ch	Frequency (MHz)	20dB Bandwidth (MHz)	15.247(a)(1) Maximum (MHz)	Chart
40	2441.0	0.825	1	Annex A Page 4

[Page mode]

ch	Frequency (MHz)	20dB Bandwidth (MHz)	15.247(a)(1) Maximum (MHz)	Chart
40	2441.0	0.800	1	Annex A Page 4

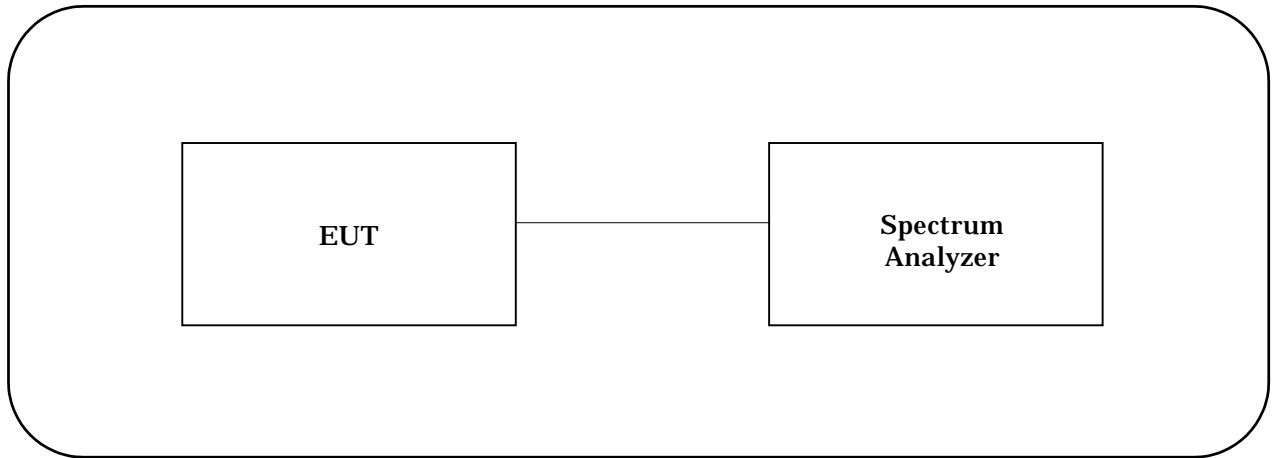
TEST INSTRUMENTS CONFIGURATION**TEST INSTRUMENTS**

Instrument	Model No.	Serial No.	Manufacturer	Last cal. date	Period
Spectrum Analyzer	8564E	3643A00665	HEWLETT PACKARD	Jun. 28, 02	1 Year

9.2 Carrier Frequency Separation [15.247(a)(1)]

9.2.1 Test mode

MEASUREMENT PROCEDURE:

1. The EUT was set to operate with following conditions.
 - Single use
 - Hopping
 - DH5 packet (Max. Length of 5 time slots)
2. The Spectrum Analyzer was connected directly to the transmitter output.
3. The Spectrum Analyzer was setup using RBW = 100kHz, VBW = 300kHz, span = 5MHz and sweep time = Auto.
4. The measurements were carried out between each of 5 hopping channels in the middle of the authorized band.
5. The next page shows the chart of the observed RF profiles.

Test date : November 5, 2002
Temperature : 21 °C
Humidity : 48 %

[Modulated-carrier] – DH5 packet (Max. Length of 5 time slots)

Channel Separation (MHz)	FCC Limit
1.000	> 20 dB Bandwidth

TEST INSTRUMENTS CONFIGURATION

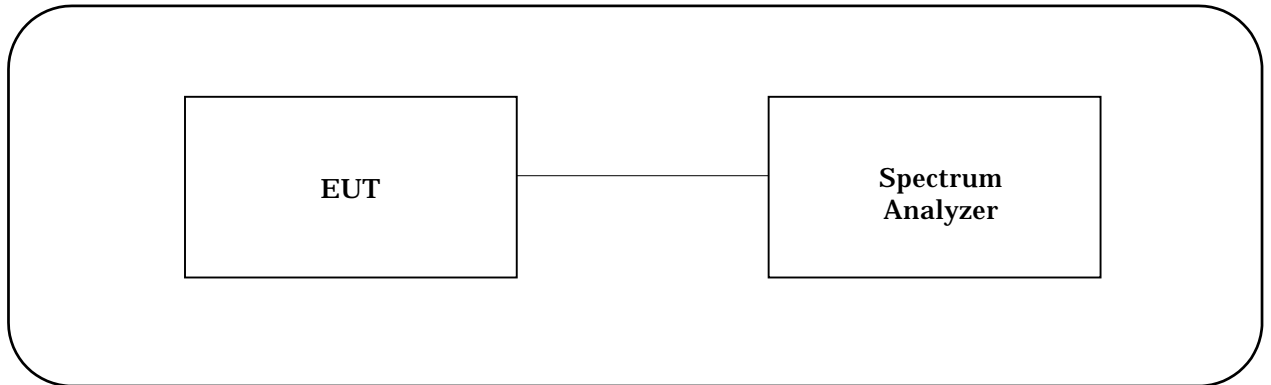

Instrument	Model No.	Serial No.	Manufacturer	Last cal. date	Period
Spectrum Analyzer	8564E	3643A00665	HEWLETT PACKARD	Jun. 28, 02	1 Year

Chart of Carrier Frequency Separation in ch 40

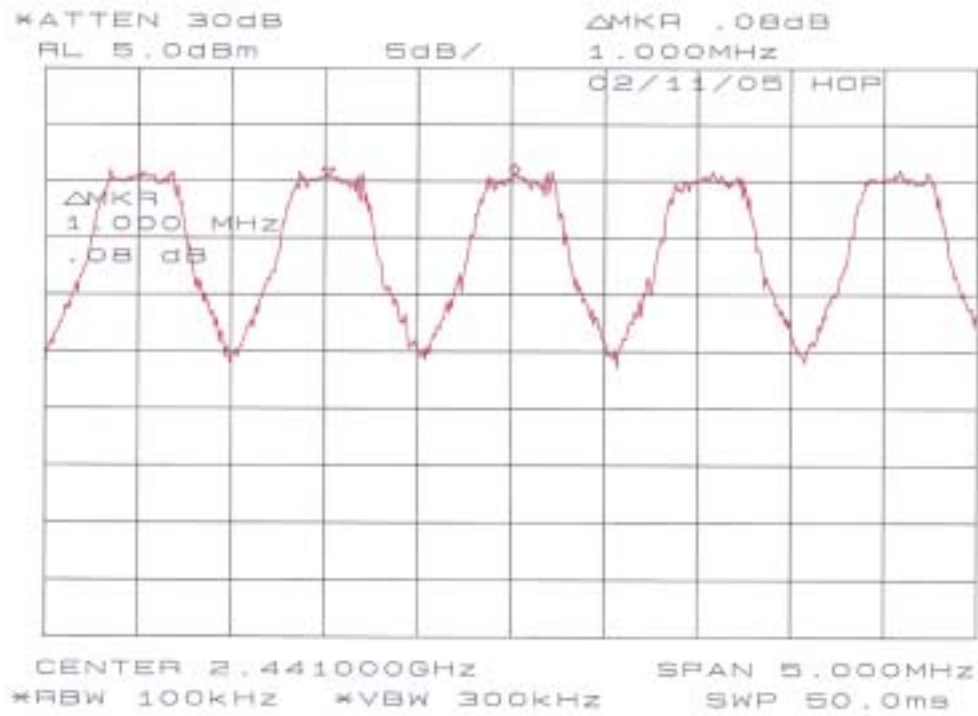

9.3 Number of Hopping Frequencies [15.247(a)(1)(ii)]

9.3.1 Test mode

MEASUREMENT PROCEDURE:

1. The EUT was set to operate with following conditions.
 - Single use
 - Hopping
 - DH5 packet (Max. Length of 5 time slots)
2. The Spectrum Analyzer was connected directly to the transmitter output.
3. The Spectrum Analyzer was setup using RBW = 1.0MHz, VBW = 1.0MHz and sweep time = Auto.
4. The next page shows the chart of the observed RF profiles.

Test date : November 5, 2002
Temperature : 21 °C
Humidity : 48 %

[Modulated-carrier] – DH5 packet (Max. Length of 5 time slots)

Number of channels	FCC Limit
79	≥ 75

9.3.2 Inquiry mode and Page mode

MEASUREMENT PROCEDURE:

1. The EUT was set to operate with following conditions.
 - Single use
 - Hopping
2. The Spectrum Analyzer was connected directly to the transmitter output.
3. The Spectrum Analyzer was setup using RBW = 1.0MHz, VBW = 1.0MHz and sweep time = Auto.
4. The next page shows the chart of the observed RF profiles.

Test date : November 5, 2002
 Temperature : 21 °C
 Humidity : 48 %

[Inquiry mode]

Number of channels	32
--------------------	----

[Page mode]

Number of channels	32
--------------------	----

TEST INSTRUMENTS CONFIGURATION

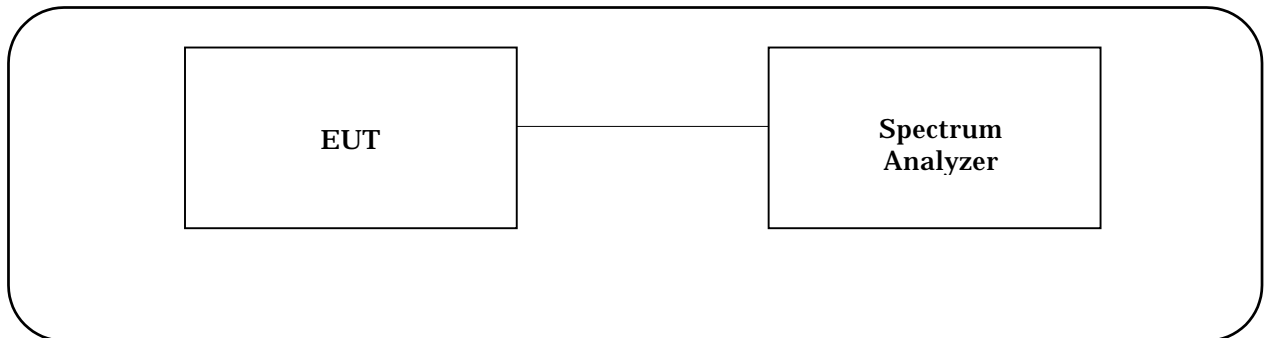

Instrument	Model No.	Serial No.	Manufacturer	Last cal. date	Period
Spectrum Analyzer	8564E	3643A00665	HEWLETT PACKARD	Jun. 28, 02	1 Year

Chart of Test mode – DH5 packet (Max. Length of 5 time slots)

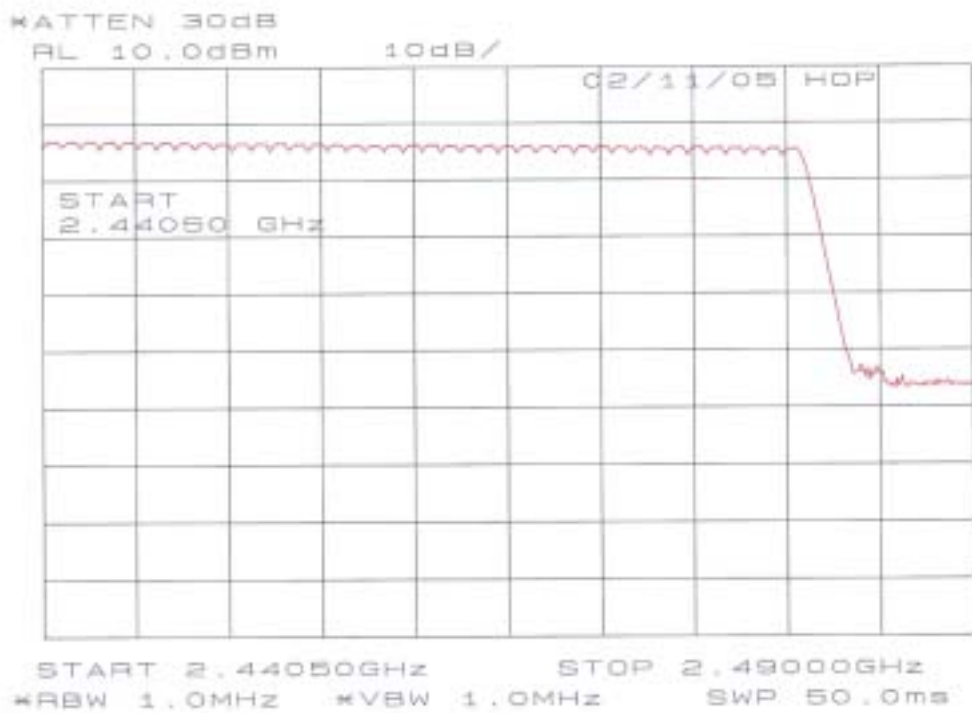
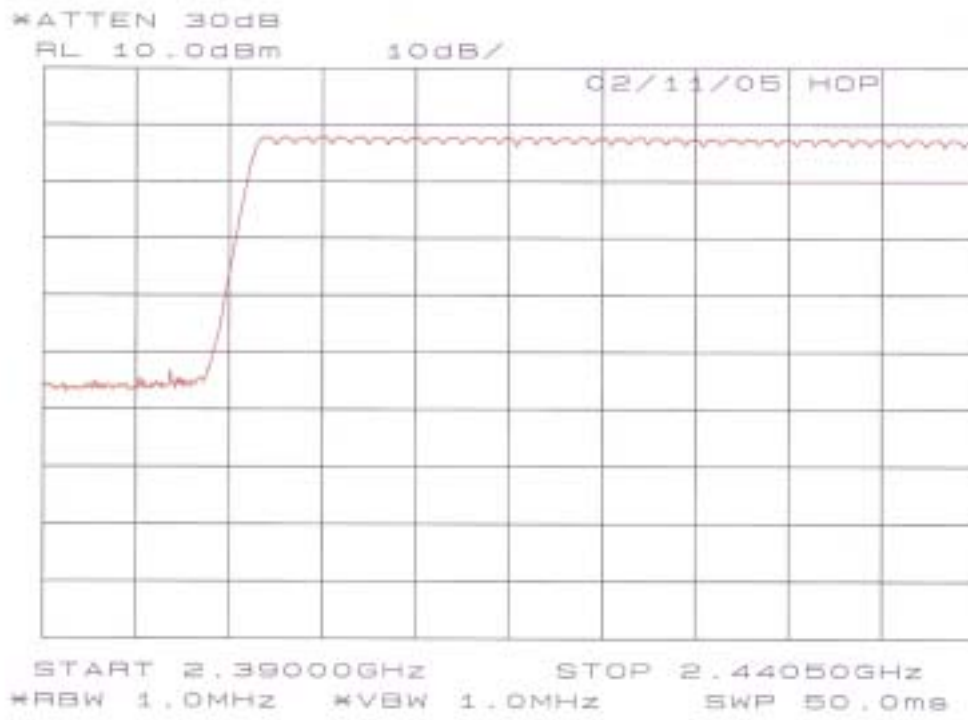

Chart of Inquiry mode

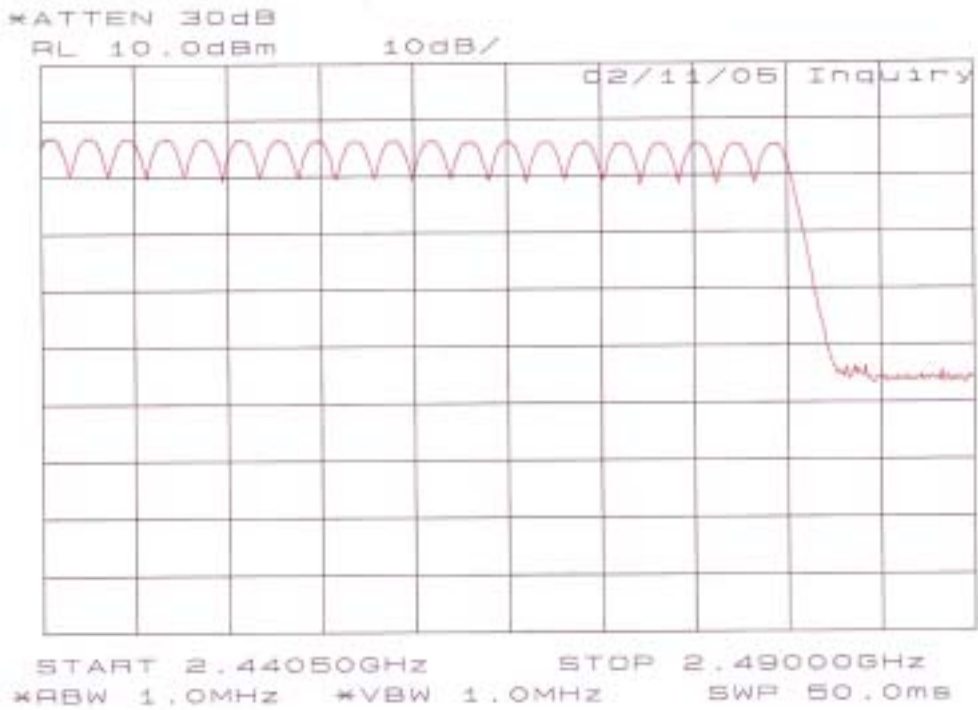
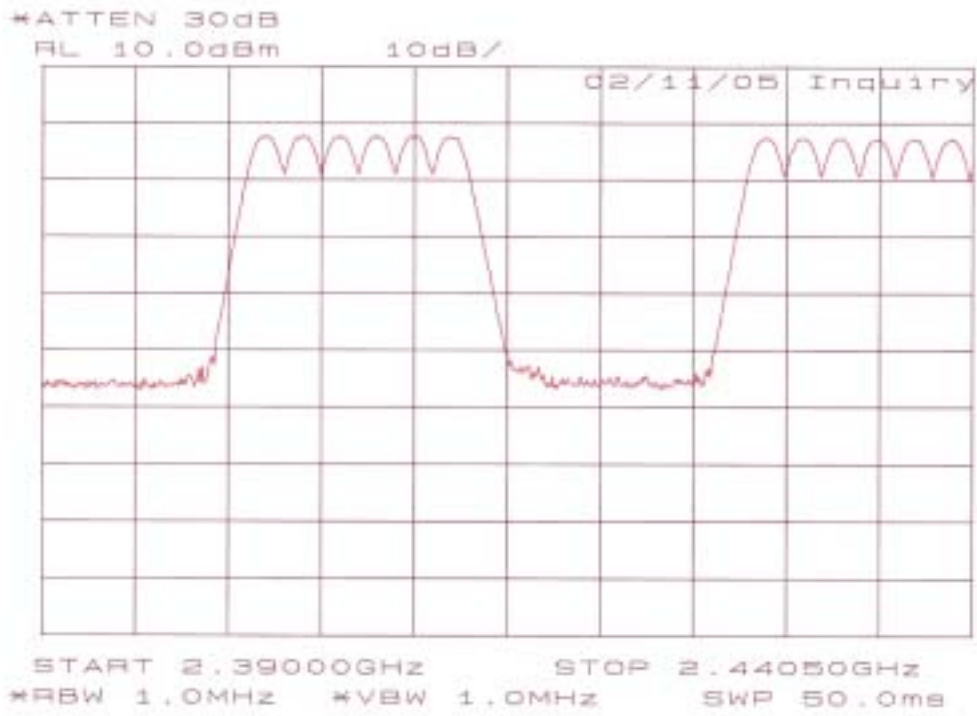
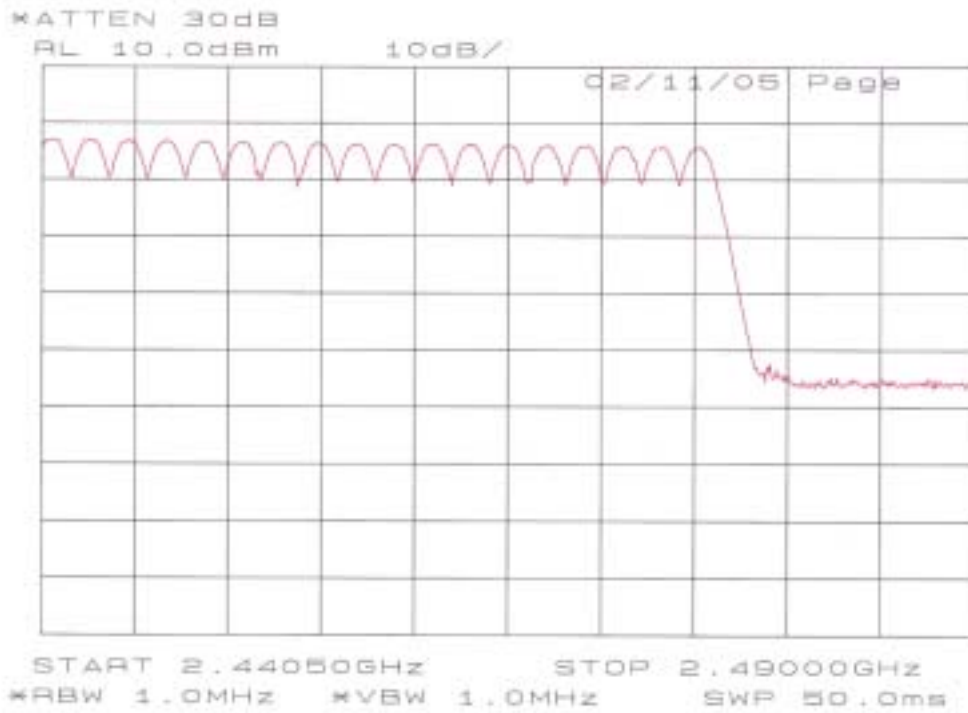
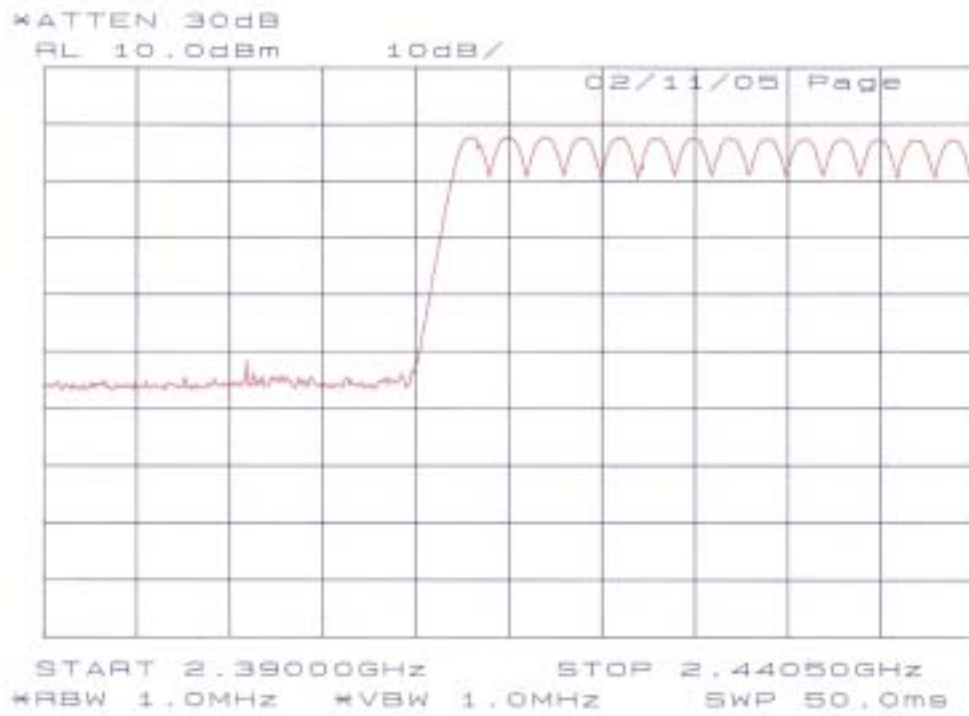

Chart of Page mode



9.4 Time of Occupancy (Dwell Time) [15.247(a)(1)(ii)]**9.4.1 Test mode****MEASUREMENT PROCEDURE:**

1. The EUT was set to operate with following conditions.
 - Single use
 - Hopping
 - DH1 packet (Max. length of 1 time slot) and DH5 packet (Max. length of 5 time slot)
2. The Spectrum Analyzer was setup using RBW = 100kHz, VBW = 30kHz, sweep time = 30 sec. and span = zero span.
3. The average dwell time per hopping channel was measured at ch 40.
4. Following data is the worst case.
5. As for the chart of the observed RF profiles, refer to Annex B.

Test date : November 5, 2002
 Temperature : 21 °C
 Humidity : 48 %

[DH5 packet (Max. length of 5 time slot)]

SWEEP #	# of Transmissions on a Single Channel in a 30 second period
1	101
2	101
3	103
4	101
5	102
Average	101.6

$$2.95\text{mS} \times 101.6 = 299.72\text{mS}$$

Average time of occupancy during a 30 second period	15.247(a)(1)(ii) Limit
299.72mS	< 400mS

9.4.2 Inquiry mode and Page mode

MEASUREMENT PROCEDURE:

1. The EUT was set to operate with following conditions.
 - Single use
 - Hopping
2. The Spectrum Analyzer was setup using RBW = 100kHz, VBW = 30kHz, sweep time = 30 sec. and span = zero span.
3. The average dwell time per hopping channel was measured at ch 40.
4. Following data is the worst case.
5. As for the chart of the observed RF profiles, refer to Annex B.

Test date : November 5, 2002
 Temperature : 21 °C
 Humidity : 48 %

[Inquiry mode]

SWEEP #	# of Transmissions on a Single Channel in an 1 second period
1	145
2	149
3	161
4	156
5	150
Average	152.2

$$0.134\text{mS} \times 152.2 = 20.40\text{mS}$$

Average time of occupancy during a 30 second period	15.247(a)(1)(ii) Limit
20.40mS	< 400mS

[Page mode]

SWEEP #	# of Transmissions on a Single Channel in an 1 second period
1	267
2	275
3	275
4	275
5	274
Average	273.2

$$0.133\text{mS} \times 273.2 = 36.34\text{mS}$$

Average time of occupancy during a 30 second period	15.247(a)(1)(ii) Limit
36.34mS	< 400mS

TEST INSTRUMENTS CONFIGURATION

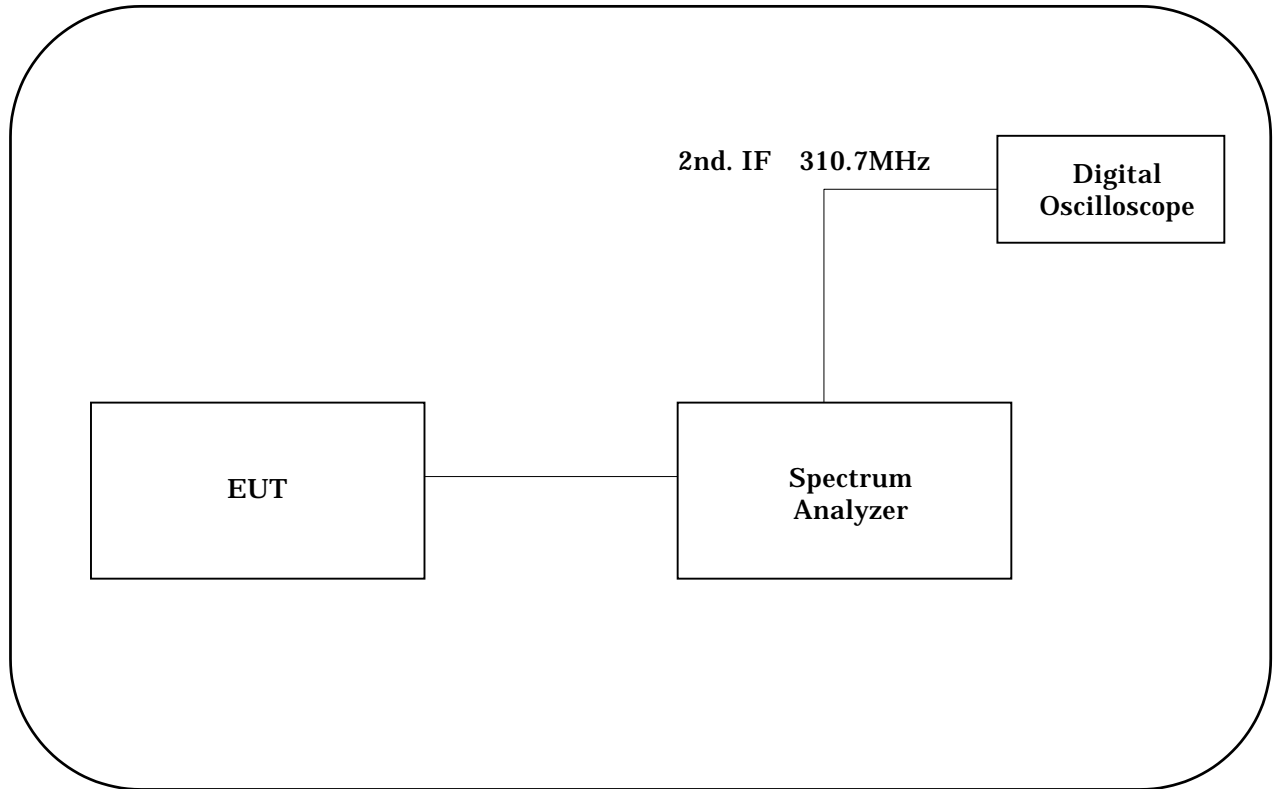

TEST INSTRUMENTS

Instrument	Model No.	Serial No.	Manufacturer	Last cal. date	Period
Spectrum Analyzer	8564E	3643A00665	HEWLETT PACKARD	Jun. 28, 02	1 Year
Digital Oscilloscope	TDS680B	B010205	Tektronix	May 10, 02	1 Year

9.5 Maximum Peak Output Power – RF Antenna Conducted [15.247(b)(1)]

9.5.1 Test mode

MEASUREMENT PROCEDURE:

1. The EUT was set to operate with following conditions.
 - Single use
 - No hopping [ch 1(low), ch 40(mid) and ch 79(high)]
 - Unmodulated-carrier
2. The Power Meter was connected directly to the transmitter output.
3. Maximum Antenna Gain : -0.95dBi
4. Following data is the worst case.

Test date : November 5, 2002
 Temperature : 21 °C
 Humidity : 48 %

ch	Freq. (MHz)	Reading (dBm)	Cable Loss (dB)	Maximum Peak Output Power (dBm)	Maximum Peak Output Power (mW)	15.247(b) Limit (mW)
1	2402.0	-2.65	0.2	-2.45	0.57	1000
40	2441.0	-3.65	0.2	-3.45	0.45	1000
79	2480.0	-5.00	0.2	-4.80	0.33	1000

Note : Maximum peak output power was detected at ch1.

= -2.45 dBm (= 0.57 mW)

Therefore, the maximum EIRP = -2.45 dBm -0.95 dBm = -3.4 dBm = 0.46 mW

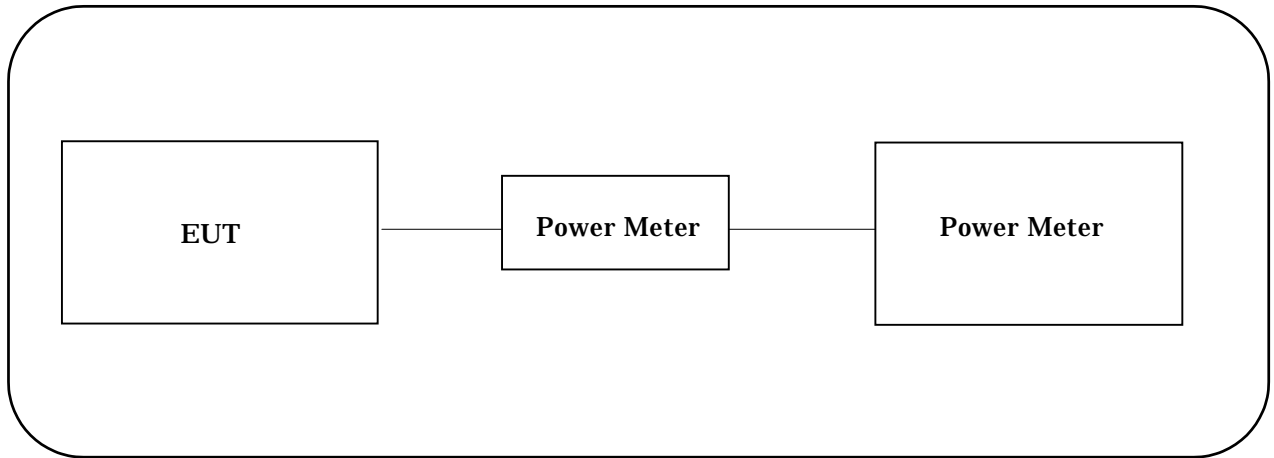
TEST INSTRUMENTS CONFIGURATION**TEST INSTRUMENTS**

Instrument	Model No.	Serial No.	Manufacturer	Last cal. date	Period
Power Meter	438A	2634A03211	HEWLETT PACKARD	Dec. 19, 01	1 Year
Power Sensor	HP8482A	2607A11551	HEWLETT PACKARD	Dec. 19, 01	1 Year

9.6 Band Edge Compliance of RF Conducted Emissions [15.247(c)]

9.6.1 Test mode

MEASUREMENT PROCEDURE:

- The EUT was set to operate with following conditions.
 - Single use
 - Hopping and no hopping [ch 1(low) and ch 79(high)]
 - DH5 packet (Max. Length of 5 time slots)
- The Spectrum Analyzer was setup using RBW = 100kHz, VBW = 100kHz, sweep time = Auto and span = 10MHz.
- Following data is the worst case.
- As for the chart of the observed RF profiles, refer to Annex C.

Test date : November 5, 2002
 Temperature : 21 °C
 Humidity : 48 %

[Hopping with modulated-carrier] – DH5 packet (Max. Length of 5 time slots)

ch	Frequency (MHz)	Difference of level	15.247(c) Limit (dB)	Chart
1	2402.0	32.17	20	Annex C Page 2
79	2480.0	30.83	20	Annex C Page 2

[No hopping with modulated-carrier] – DH5 packet (Max. Length of 5 time slots)

ch	Frequency (MHz)	Difference of level	15.247(c) Limit (dB)	Chart
1	2402.0	31.34	20	Annex C Page 3
79	2480.0	30.83	20	Annex C Page 3

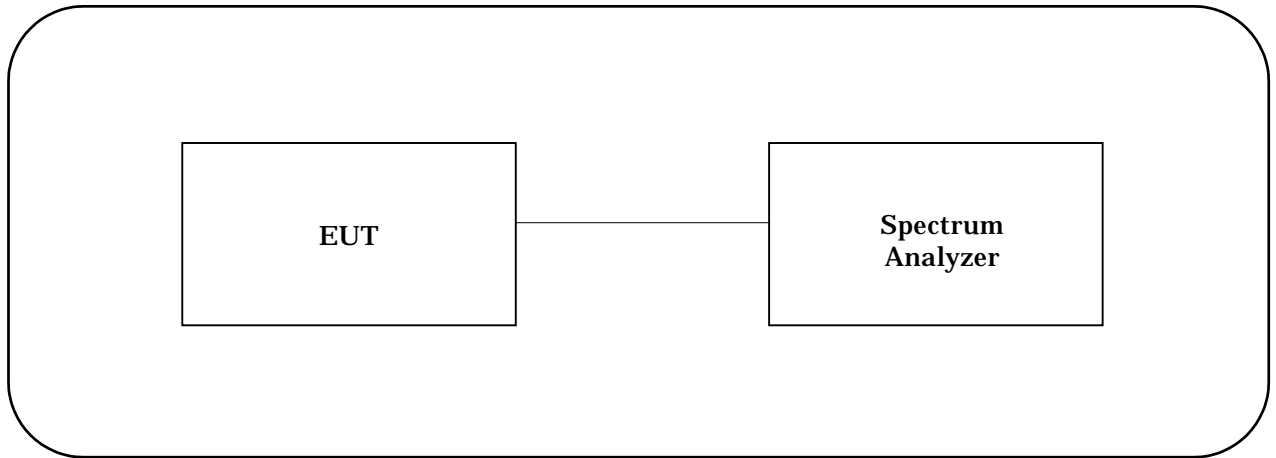
TEST INSTRUMENTS CONFIGURATION**TEST INSTRUMENTS**

Instrument	Model No.	Serial No.	Manufacturer	Last cal. date	Period
Spectrum Analyzer	8564E	3643E00665	HEWLETT PACKARD	Jun. 28, 02	1 Year

9.7 Spurious Emissions – RF Antenna Conducted Test [15.247(c)]

9.7.1 Test mode

MEASUREMENT PROCEDURE:

1. The EUT was set to operate with following conditions.
 - Single use
 - Hopping and no hopping [ch 1(low) , ch 40 (mid) and ch 79(high)]
 - DH5 packet (Max. Length of 5 time slots)
2. The Spectrum Analyzer was connected directly to the transmitter output.
3. The Spectrum Analyzer was setup using RBW = 100kHz, VBW = 100kHz and sweep time = Auto.
4. Following data is the worst case.
5. As for the chart of the observed RF profiles, refer to Annex D and E.

Test date : November 6, 2002
 Temperature : 20 °C
 Humidity : 45 %

[Hopping with modulated-carrier] – DH5 packet (Max. Length of 5 time slots)

Frequency (MHz)	Chart
2402.0 – 2480.0	Annex D page 2-4

[No hopping with modulated-carrier] – DH5 packet (Max. Length of 5 time slots)

ch	Frequency (MHz)	Chart
1	2402.0	Annex E page 2-4
40	2441.0	Annex E page 4-7
79	2480.0	Annex E page 8-10

Note :

1. All out-of-band conducted emissions were more than 20 dB below a carrier.

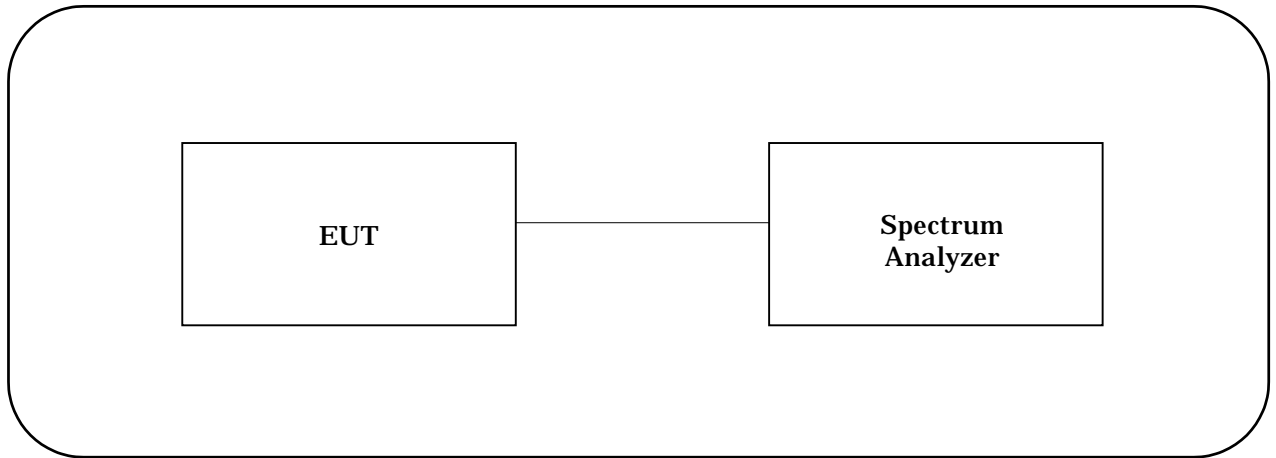
TEST INSTRUMENTS CONFIGURATION**TEST INSTRUMENTS**

Instrument	Model No.	Serial No.	Manufacturer	Last cal. date	Period
Spectrum Analyzer	8564E	3643E00665	HEWLETT PACKARD	Jun. 28, 02	1 Year

9.8 Spurious Emissions – Radiated Emission Test [15.247(c), 15.205, 15.209]

9.8.1 Test mode

MEASUREMENT PROCEDURE:

- 1. The EUT was set to operate with following conditions.**
 - System use
 - No hopping [ch 1(low), ch 40(mid) and ch 79(high)]
 - DH5 packet (Max. Length of 5 time slots)
- 2. The Spectrum Analyzer was setup using**
 - Peak mode: RBW = 1MHz, VBW = 1MHz
 - Average mode: RBW = 1MHz, VBW = 10Hz
- 3. Measurement distance was 1 meter.**
- 4. Following data is the worst case.**

Data of ch 1

Akzo Nobel K. K.

Kashima No.3 Test Site

INTERFERENCE RADIATION TEST

APPLICANT : Casio Computer Co.,Ltd.
 EUT NAME : Handy Terminal
 MODEL NO. : DT-X10M30U
 SERIAL NO. : CS137
 TEST MODE : No-Hopping (CH : 1)
 POWER SOURCE : DC 3.7V
 DATE TESTED : Nov 8 2002

FILE NO. : ANKK-102271
 REGULATION : FCC Part15C (15.209,247(C))
 TEST METHOD : ANSI C63.4:1992
 DISTANCE : 1.0 [m]
 TEMPERATURE : 21.0 [degC]
 HUMIDITY : 56.0 [%]

ENGINEER : Kazuo Masuda

No	FREQUENCY MODE		READING [dBuV]		FACTOR [dB/m]		EMISSION [dBuV/m]		LIMIT [dBuV/m]	MARGIN [dB]	
	[MHz]		Hori	Vert	Hori	Vert	Hori	Vert		Hori	Vert
1	3603.00	PEK	48.2	47.5	-6.7	-6.7	41.5	40.8	74.0	32.5	33.2
2	3603.00	AVG	35.5	35.5	-6.7	-6.7	28.8	28.8	54.0	25.2	25.2
3	4804.00	PEK	57.5	54.0	-1.7	-1.7	55.8	52.3	74.0	18.2	21.7
4	4804.00	AVG	49.9	46.2	-1.7	-1.7	48.2	44.5	54.0	5.8	9.5
5	7206.00	PEK	52.0	51.5	5.8	5.8	57.8	57.3	74.0	16.2	16.7
6	7206.00	AVG	39.9	39.9	5.8	5.8	45.7	45.7	54.0	8.3	8.3

Other frequencies : Below the FCC Part15C (15.209,247(C)) limit
 Emission Level = Read + Factor(Antenna,Antenna Pad,Cable,Preamp)

Data of ch 40

Akzo Nobel K. K.
Kashima No.3 Test Site
INTERFERENCE RADIATION TEST

APPLICANT : Casio Computer Co.,Ltd.
 EUT NAME : Handy Terminal
 MODEL NO. : DT-X10M30U
 SERIAL NO. : CS137
 TEST MODE : No-Hopping (CH : 40)
 POWER SOURCE : DC 3.7V
 DATE TESTED : Nov 8 2002

FILE NO. : ANKK-102271
 REGULATION : FCC Part15C (15.209,247(C))
 TEST METHOD : ANSI C63.4:1992
 DISTANCE : 1.0 [m]
 TEMPERATURE : 21.0 [degC]
 HUMIDITY : 56.0 [%]

ENGINEER : Kazuo Masuda

No	FREQUENCY MODE		READING [dBuV]		FACTOR [dB/m]		EMISSION [dBuV/m]		LIMIT [dBuV/m]	MARGIN [dB]	
	[MHz]		Hori	Vert	Hori	Vert	Hori	Vert		Hori	Vert
1	3661.00	PEK	47.5	47.8	-6.3	-6.3	41.2	41.5	74.0	32.8	32.5
2	3661.00	AVG	35.2	35.3	-6.3	-6.3	28.9	29.0	54.0	25.1	25.0
3	4882.00	PEK	57.2	54.2	-1.6	-1.6	55.6	52.6	74.0	18.4	21.4
4	4882.00	AVG	49.5	46.2	-1.6	-1.6	47.9	44.6	54.0	6.1	9.4
5	7323.00	PEK	51.9	51.7	6.0	6.0	57.9	57.7	74.0	16.1	16.3
6	7323.00	AVG	40.7	40.7	6.0	6.0	46.7	46.7	54.0	7.3	7.3

Other frequencies : Below the FCC Part15C (15.209,247(C)) limit
 Emission Level = Read + Factor(Antenna,Antenna Pad,Cable,Preamp)

Data of ch 79

Akzo Nobel K. K.

Kashima No.3 Test Site

INTERFERENCE RADIATION TEST

APPLICANT : Casio Computer Co.,Ltd.
 EUT NAME : Handy Terminal
 MODEL NO. : DT-X10M30U
 SERIAL NO. : CS137
 TEST MODE : No-Hopping (CH : 79)
 POWER SOURCE : DC 3.7V
 DATE TESTED : Nov 8 2002

FILE NO. : ANKK-102271
 REGULATION : FCC Part15C (15.209,247(C))
 TEST METHOD : ANSI C63.4:1992
 DISTANCE : 1.0 [m]
 TEMPERATURE : 21.0 [degC]
 HUMIDITY : 56.0 [%]

ENGINEER : Kazuo Masuda

No	FREQUENCY [MHz]	MODE	READING [dBUV]		FACTOR [dB/m]		EMISSION [dBUV/m]		LIMIT [dBUV/m]	MARGIN [dB]	
			Hori	Vert	Hori	Vert	Hori	Vert		Hori	Vert
1	3720.00	PEK	47.3	47.5	-5.9	-5.9	41.4	41.6	74.0	32.6	32.4
2	3720.00	AVG	35.4	35.4	-5.9	-5.9	29.5	29.5	54.0	24.5	24.5
3	4960.00	PEK	56.6	55.8	-1.4	-1.4	55.2	54.4	74.0	18.8	19.6
4	4960.00	AVG	49.0	48.2	-1.4	-1.4	47.6	46.8	54.0	6.4	7.2
5	7440.00	PEK	51.5	51.3	6.1	6.1	57.6	57.4	74.0	16.4	16.6
6	7440.00	AVG	40.4	40.5	6.1	6.1	46.5	46.6	54.0	7.5	7.4

Other frequencies : Below the FCC Part15C (15.209,247(C)) limit
 Emission Level = Read + Factor(Antenna,Antenna Pad,Cable,Preamp)

TEST INSTRUMENTS CONFIGURATION

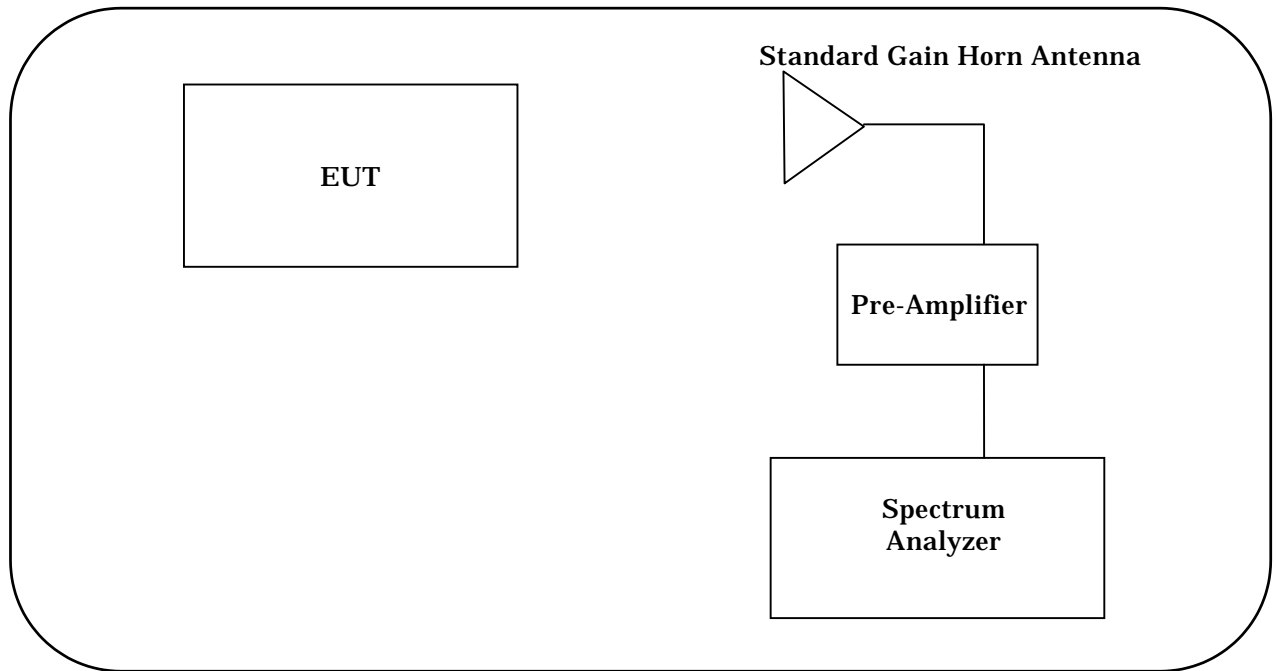

TEST INSTRUMENTS

Instrument	Model No.	Serial No.	Manufacturer	Last cal. date	Period
Spectrum Analyzer	8564E	3643A00665	HEWLETT PACKARD	Jun. 28, 02	1 Year
Pre-Amplifier	83051A	3332A00329	HEWLETT PACKARD	Jun. 2, 02	1 Year
Standard Gain Horn Antenna	3160-04	9702-1032	EMCO	Oct. 19, 01	3 Year
	3160-05	9701-1038	EMCO	Oct. 19, 01	3 Year
	3160-06	9612-1030	EMCO	Oct. 19, 01	3 Year
	3160-07	9703-1069	EMCO	Oct. 19, 01	3 Year
	3160-08	9703-1057	EMCO	Oct. 19, 01	3 Year
	3160-09	9703-1074	EMCO	Oct. 19, 01	3 Year

9.9 Restricted Bands of Operation [15.247(c),15.205,15.209]

9.9.1 Test mode

MEASUREMENT PROCEDURE:

- 1. The EUT was set to operate with following conditions.**
 - Single use
 - Hopping
 - DH5 packet (Max. length of 5 time slot)
- 2. The Spectrum Analyzer was setup using**
 - Peak mode: RBW = 1MHz, VBW = 1MHz
 - Average mode: RBW = 1MHz, VBW = 10Hz
- 3. Measurement distance was 1 meter.**
- 4. Following data is the worst case.**

Data of Hopping with DH5 packet**Akzo Nobel K. K.****Kashima No.3 Test Site****INTERFERENCE RADIATION TEST**

APPLICANT : Casio Computer Co.,Ltd.
 EUT NAME : Handy Terminal
 MODEL NO. : DT-X10M30U
 SERIAL NO. : CS137
 TEST MODE : Hopping
 POWER SOURCE : DC 3.7V
 DATE TESTED : Nov 7 2002

FILE NO. : ANKK-102271
 REGULATION : FCC Part15C (15.209,247(C))
 TEST METHOD : ANSI C63.4:1992
 DISTANCE : 1.0 [m]
 TEMPERATURE : 21.0 [degC]
 HUMIDITY : 56.0 [%]

ENGINEER : Kazuo Masuda

No	FREQUENCY MODE		READING [dBuV]		FACTOR [dB/m]		EMISSION [dBuV/m]		LIMIT [dBuV/m]	MARGIN [dB]	
	[MHz]		Hori	Vert	Hori	Vert	Hori	Vert		Hori	Vert
1	2390.00	PEK	29.3	29.0	26.5	26.5	55.8	55.5	74.0	18.2	18.5
2	2390.00	AVG	17.2	17.2	26.5	26.5	43.7	43.7	54.0	10.3	10.3
3	2483.50	PEK	30.5	29.8	26.8	26.8	57.3	56.6	74.0	16.7	17.4
4	2483.50	AVG	17.8	17.7	26.8	26.8	44.6	44.5	54.0	9.4	9.5

Other frequencies : Below the FCC Part15C (15.209,247(C)) limit
 Emission Level = Read + Factor(Antenna,Antenna Pad,Cable,Preamp)

TEST INSTRUMENTS CONFIGURATION

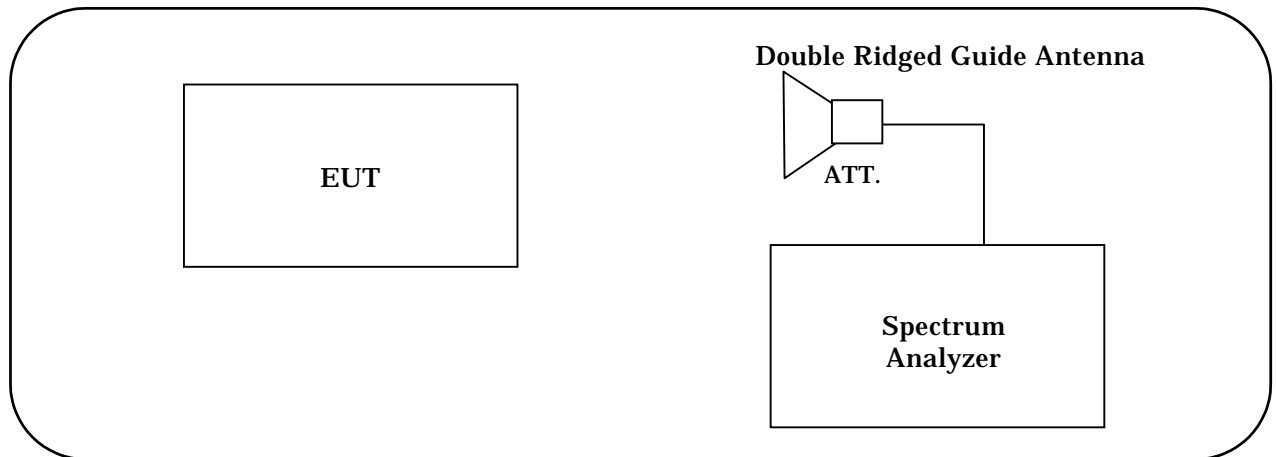

TEST INSTRUMENTS

Instrument	Model No.	Serial No.	Manufacturer	Last cal. date	Period
Spectrum Analyzer	8564E	3643A00665	HEWLETT PACKARD	Jun. 28, 02	1 Year
3dB Attenuator	6803.17.B	None	HEWLETT PACKARD	Jun. 2, 02	1 Year
Double Ridged Guide Antenna	3115	5044	EMCO	Jul. 9, 02	1 Year

9.10 Power Spectral Density [15.247(f), 15.247(d)]**9.10.1 Inquiry mode and Page mode****MEASUREMENT PROCEDURE:**

1. The EUT was set to operate with following conditions.
 - Single use
 - No hopping [ch 40 (mid)]
2. The Spectrum Analyzer was connected directly to the transmitter output.
3. The Spectrum Analyzer was setup using RBW = 3kHz, VBW = 10kHz, span = 300kHz and sweep = 100sec.(span/3kHz).
4. The next page shows the chart of the observed RF profiles.
5. Following data is the worst case.

Test date : November 6, 2002
 Temperature : 20 °C
 Humidity : 45 %

[Inquiry mode]

ch	Frequency (MHz)	Reading (dBm)	Cable Loss (dB)	Power Spectral Density (dBm)	15.247(d) Limit (dBm)	Chart
40	2441	-9.17	0.2	-8.97	8	Page 48

[Page mode]

ch	Frequency (MHz)	Reading (dBm)	Cable Loss (dB)	Power Spectral Density (dBm)	15.247(d) Limit (dBm)	Chart
40	2441	-10.67	0.2	-10.47	8	Page 48

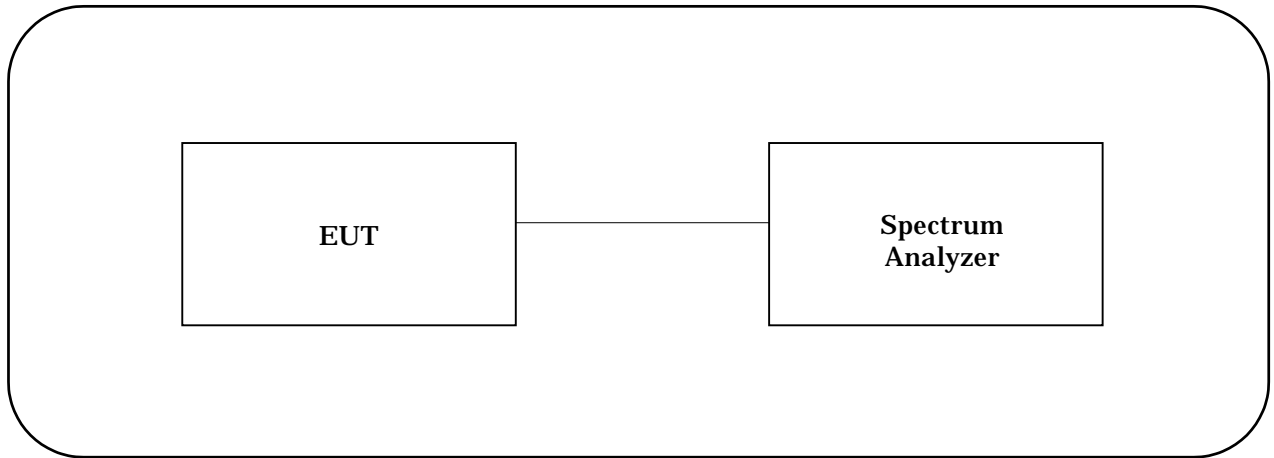
TEST INSTRUMENTS CONFIGURATION**TEST INSTRUMENTS**

Instrument	Model No.	Serial No.	Manufacturer	Last cal. date	Period
Spectrum Analyzer	8564E	3643A00665	HEWLETT PACKARD	Jun. 28, 02	1 Year

Chart of Inquiry mode

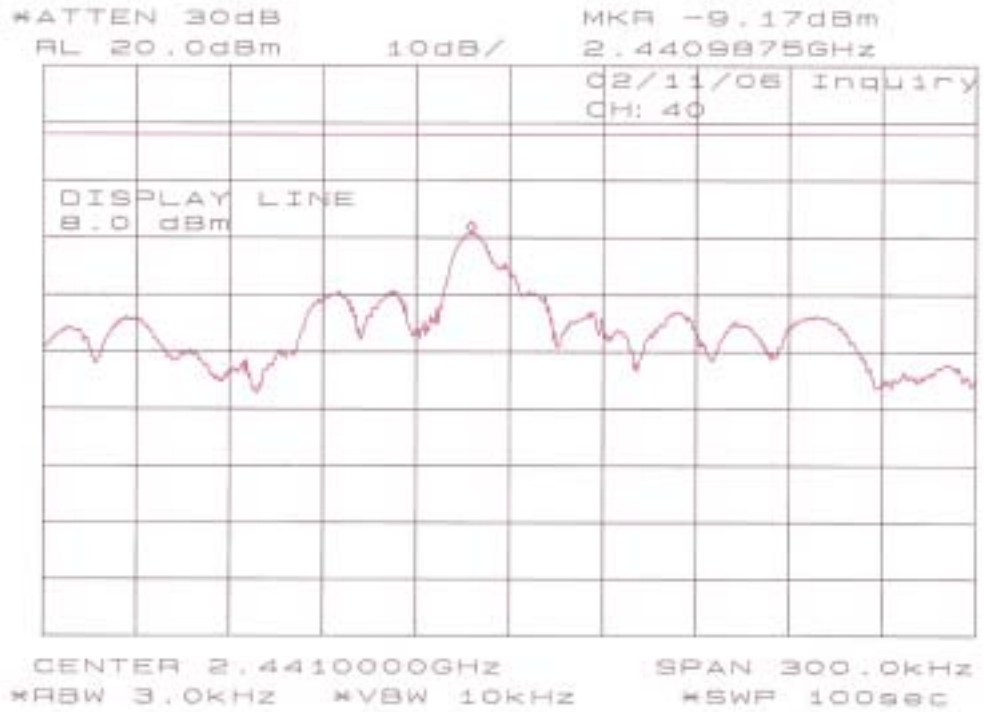

Chart of Page mode



SECTION 10. MEASUREMENT UNCERTAINTY

The uncertainty of the measurements performed for this report lies:

20dB Bandwidth	[15.247(a)(1)(ii)]
Above 1 GHz	+/- 46.7kHz
Carrier Frequency Separation	[15.247(a)(1)]
Above 1 GHz	+/- 46.7kHz
Time of Occupancy (Dwell Time)	[15.247(a)(1)(ii)]
.....	+/- 0.2 %
Maximum Peak Output Power	[15.247(b)(1)]
- RF Antenna Conducted	
Above 1 GHz	+/- 2.9 dB
Band Edge Compliance of RF Conducted Emission	[15.247(c)]
Above 1 GHz	+/- 2.9 dB
Spurious Emissions	[15.247(c)]
- RF Antenna Conducted Test	
Above 1 GHz	+/- 2.9 dB
Spurious Emissions	[15.247(c), 15.205, 15.209]
- Radiated Emission Test	
Above 1 GHz	+/- 3.9 dB
Power Spectral Density	[15.247(d)]
Above 1 GHz	+/- 2.9 dB
Restricted Bands of Operation	[15.247(c), 15.205, 15.209]
Above 1 GHz	+/- 3.9 dB
Radiated Emission from Digital Part	[15.109]
30 – 1000 MHz	+/- 3.6 dB

Note on Radiated Emission measurement uncertainty

The following items are not included in the calculations in spite of their own uncertainty components because it is impracticable to find the value. It is our problem awaiting solution in future.

(1) Repeatability of measurement

It is not possible to calculate repeatability since the measurement was carried out only one time.

(2) Antenna factor variation

The definition of measured (radiated electric field strength) is not completed on the referred standard(s).

(3) Loss of EUT radiation propagation

It is certainly one of the uncertainty components, however is not able to calculate.

Please note that these uncertainties are not reflected to the compliance judgement of the test results in this report.

SECTION 11. DESCRIPTION OF TEST LABORATORY

11.1 Outline of Akzo Nobel K. K. (formerly Akzo Kashima Limited), EMC Division

Akzo Nobel K. K., the country organization in Japan for Akzo Nobel NV, was established in 1968. The shares are owned by Akzo Nobel NV (100%). Akzo Nobel NV, headquartered in the Netherlands, is one of the world's leading companies in selected areas of chemicals, coatings, healthcare products and fibers with work force of approximately 70,000 people in over 50 countries.

In 1984, in order to respond to the growing testing demand, in particular, for FCC filing, Akzo Nobel K. K. started EMI testing business, installing the first open air test site in Kashima, Ibaraki prefecture. Further the business has been expanded by installing additional testing facilities not only in Ibaraki but also in other areas such as Shizuoka, Nagano, Kanagawa and Tochigi. As results, Akzo Nobel K. K. has now 16 open air test sites and 4 anechoic chambers for EMI/EMC testing. As the largest EMC testing laboratory in number of testing facilities and staffs, EMC Division has been organized separately in the company and independently operated in conformity with the requirements of ISO/IEC17025 for its competency as a testing laboratory.

Akzo Nobel K. K. EMC Division is the first foreign private laboratory accredited by NVLAP, National Voluntary Laboratory Accreditation Program-NIST, USA. The division has been certified, authorized and/or filed as a competent testing laboratory by various testing organizations/authorities as described below.

11.2 Filing, certification, authorization and accreditation list

EMI/EMC testing

FCC	(USA)
NVLAP	(USA)
NEMKO	(Norway)
VCCI	(Japan)
ETL SEMKO	(Sweden)
TÜV PRODUCT SERVICE	(Germany)

Telecommunications terminal testing

FCC	(USA)
NVLAP	(USA)
NATA	(Australia)
IC	(Canada)

Note 1 : NVLAP accreditation does not constitute any product endorsement by NVLAP or any agent of the U.S. Government.



Maximum Permissible Exposure (MPE) Evaluation

Applicant : CASIO COMPUTER CO., LTD.
Equipment : Handy Terminal
Model No. : DT-X10M30U
FCC ID : BBQDT-X10M30U

MPE Calculations

According to the OET Bulletin 65 (Edition 97-01)

$$S = \frac{PG}{4\pi R^2}$$

$$R = \sqrt{\frac{PG}{4\pi S}}$$

Where:

S=power density (in appropriate units, e.g. mW/cm²)

P=power input to antenna (in appropriate units, e.g., mW)

G=power gain of the antenna in the direction of interest relative to an isotropic radiator

R=distance to the center of radiation of the antenna (appropriate units, e.g., cm)

Tx Frequency= 2402 (MHz)
Maximum peak power= -2.45 (dBm)
Antenna gain= -0.95 (dBi)

S= 1 (mW/cm²)
P= 0.57 (mW)
G= 0.80 (numeric)
R= 0.19 (cm)

The calculated minimum separation distance from antenna : 0.19 (cm)

Notice in the User manual

FCC Radio-Frequency Exposure Statement

This equipment generates and radiates radio-frequency energy. In order to comply with FCC radio-frequency radiation exposure guidelines for an uncontrolled environment, this equipment has to be installed and operated while maintaining a minimum body to antenna distance of 20 cm.