



FCC TEST REPORT

REPORT NO.: RF110428D10

MODEL NO.: XJ-H1650

FCC ID: BBQ-XJH1650

RECEIVED: Apr. 28, 2011

TESTED: May 9 ~ 23, 2011

ISSUED: May 27, 2011

APPLICANT: CASIO COMPUTER CO. LTD.

ADDRESS: 2-1, Sakaecho 3-Chome Hamura-Shi, Tokyo
205-8555 Japan

ISSUED BY: Bureau Veritas Consumer Products Services (H.K.)
Ltd., Taoyuan Branch

LAB LOCATION: No. 47, 14th Ling, Chia Pau Tsuen, Lin Kou Hsiang,
Taipei Hsien, 244 Taiwan

This test report consists of 29 pages in total. It may be duplicated completely for legal use with the approval of the applicant. It should not be reproduced except in full, without the written approval of our laboratory. The client should not use it to claim product endorsement by TAF or any government agencies. The test results in the report only apply to the tested sample.



Table of Contents

| | |
|--|----|
| RELEASE CONTROL RECORD..... | 3 |
| 1. CERTIFICATION..... | 4 |
| 2. SUMMARY OF TEST RESULTS..... | 5 |
| 2.1 MEASUREMENT UNCERTAINTY..... | 5 |
| 3. GENERAL INFORMATION | 6 |
| 3.1 GENERAL DESCRIPTION OF EUT | 6 |
| 3.2 DESCRIPTION OF TEST MODES..... | 7 |
| 3.2.1 CONFIGURATION OF SYSTEM UNDER TEST | 7 |
| 3.2.2 TEST MODE APPLICABILITY AND TESTED CHANNEL DETAIL: | 8 |
| 3.3 GENERAL DESCRIPTION OF APPLIED STANDARDS | 10 |
| 3.4 DESCRIPTION OF SUPPORT UNITS | 10 |
| 4. TEST TYPES AND RESULTS..... | 11 |
| 4.1 CONDUCTED EMISSION MEASUREMENT | 11 |
| 4.1.1 LIMITS OF CONDUCTED EMISSION MEASUREMENT | 11 |
| 4.1.2 TEST INSTRUMENTS | 11 |
| 4.1.3 TEST PROCEDURES | 12 |
| 4.1.4 DEVIATION FROM TEST STANDARD | 12 |
| 4.1.5 TEST SETUP | 12 |
| 4.1.6 EUT OPERATING CONDITIONS | 12 |
| 4.1.7 TEST RESULTS..... | 13 |
| 4.2 RADIATED EMISSION MEASUREMENT | 15 |
| 4.2.1 LIMITS OF RADIATED EMISSION MEASUREMENT | 15 |
| 4.2.2 TEST INSTRUMENTS | 16 |
| 4.2.3 TEST PROCEDURES | 17 |
| 4.2.4 DEVIATION FROM TEST STANDARD | 17 |
| 4.2.5 TEST SETUP | 18 |
| 4.2.6 EUT OPERATING CONDITIONS | 18 |
| 4.2.7 TEST RESULTS..... | 19 |
| 4.3 BAND EDGES MEASUREMENT | 24 |
| 4.3.1 LIMITS OF BAND EDGES MEASUREMENT | 24 |
| 4.3.2 TEST INSTRUMENTS | 24 |
| 4.3.3 TEST PROCEDURE | 24 |
| 4.3.4 DEVIATION FROM TEST STANDARD | 24 |
| 4.3.5 EUT OPERATING CONDITION | 24 |
| 4.3.6 TEST RESULTS..... | 24 |
| 5. PHOTOGRAPHS OF THE TEST CONFIGURATION..... | 27 |
| 6. INFORMATION ON THE TESTING LABORATORIES | 28 |
| 7. APPENDIX A – MODIFICATIONS RECORDERS FOR ENGINEERING CHANGES TO THE EUT BY THE LAB | 29 |



A D T

RELEASE CONTROL RECORD

| ISSUE NO. | REASON FOR CHANGE | DATE ISSUED |
|-------------|-------------------|--------------|
| RF110428D10 | Original release | May 27, 2011 |



1. CERTIFICATION

PRODUCT: DATA PROJECTOR
BRAND NAME: CASIO
MODEL NO.: XJ-H1650
APPLICANT: CASIO COMPUTER CO. LTD.
TESTED: May 9 ~ 23, 2011
TEST ITEM: ENGINEERING SAMPLE
STANDARDS: FCC Part 15, Subpart C (Section 15.249)
ANSI C63.4-2003
ANSI C63.10-2009

The above equipment has been tested by **Bureau Veritas Consumer Products Services (H.K.) Ltd., Taoyuan Branch**, and found compliance with the requirement of the above standards. The test record, data evaluation & Equipment Under Test (EUT) configurations represented herein are true and accurate accounts of the measurements of the sample's EMC characteristics under the conditions specified in this report.

PREPARED BY : Celia Chen , **DATE:** May 27, 2011
(Celia Chen / Senior Specialist)

APPROVED BY : Ken Liu , **DATE:** May 27, 2011
(Ken Liu / Manager)

2. SUMMARY OF TEST RESULTS

The EUT has been tested according to the following specifications:

| APPLIED STANDARD: FCC Part 15, Subpart C (Section 15.249) | | | |
|---|--|--------|---|
| STANDARD SECTION | TEST TYPE AND LIMIT | RESULT | REMARK |
| 15.207 | Conducted Emission Test | PASS | Minimum passing margin is -20.73dB at 22.193MHz |
| 15.209 15.249 15.249 (d) | Radiated Emission Test Band Edge Measurement Limit: 50dB less than the peak value of fundamental frequency or meet radiated emission limit in section 12.209 | PASS | Minimum passing margin is -2.8dB at 67.12MHz |

2.1 MEASUREMENT UNCERTAINTY

Where relevant, the following measurement uncertainty levels have been estimated for tests performed on the EUT as specified in CISPR 16-4-2:

This uncertainty represents an expanded uncertainty expressed at approximately the 95% confidence level using a coverage factor of k=2.

| Measurement | Frequency | Uncertainty |
|---------------------|----------------|-------------|
| Conducted emissions | 150kHz ~ 30MHz | 2.41 dB |
| Radiated emissions | 30MHz ~ 1GHz | 3.87 dB |
| | Above 1GHz | 2.89 dB |

3. GENERAL INFORMATION

3.1 GENERAL DESCRIPTION OF EUT

| | |
|----------------------------|------------------------------------|
| EUT | DATA PROJECTOR |
| MODEL NO. | XJ-H1650 |
| FCC ID | BBQ-XJH1650 |
| POWER SUPPLY | 100-240Vac |
| MODULATION TYPE | MSK |
| OPERATING FREQUENCY | 2402MHz ~ 2479MHz |
| NUMBER OF CHANNEL | 78 |
| ANTENNA TYPE | Printed antenna with -1.51dBi gain |
| ANTENNA CONNECTOR | N/A |
| DATA CABLE | N/A |
| I/O PORTS | Refer to user's manual |
| ASSOCIATED DEVICES | N/A |

NOTE:

1. The EUT is a transceiver.
2. The above EUT information was declared by the manufacturer and for more detailed features description, please refer to the manufacturer's specifications or User's Manual.

3.2 DESCRIPTION OF TEST MODES

78 channels are provided to this EUT:

| CHANNEL | FREQ. (MHZ) | CHANNEL | FREQ. (MHZ) | CHANNEL | FREQ. (MHZ) | CHANNEL | FREQ. (MHZ) |
|---------|-------------|---------|-------------|---------|-------------|---------|-------------|
| 0 | 2402 | 20 | 2422 | 40 | 2442 | 60 | 2462 |
| 1 | 2403 | 21 | 2423 | 41 | 2443 | 61 | 2463 |
| 2 | 2404 | 22 | 2424 | 42 | 2444 | 62 | 2464 |
| 3 | 2405 | 23 | 2425 | 43 | 2445 | 63 | 2465 |
| 4 | 2406 | 24 | 2426 | 44 | 2446 | 64 | 2466 |
| 5 | 2407 | 25 | 2427 | 45 | 2447 | 65 | 2467 |
| 6 | 2408 | 26 | 2428 | 46 | 2448 | 66 | 2468 |
| 7 | 2409 | 27 | 2429 | 47 | 2449 | 67 | 2469 |
| 8 | 2410 | 28 | 2430 | 48 | 2450 | 68 | 2470 |
| 9 | 2411 | 29 | 2431 | 49 | 2451 | 69 | 2471 |
| 10 | 2412 | 30 | 2432 | 50 | 2452 | 70 | 2472 |
| 11 | 2413 | 31 | 2433 | 51 | 2453 | 71 | 2473 |
| 12 | 2414 | 32 | 2434 | 52 | 2454 | 72 | 2474 |
| 13 | 2415 | 33 | 2435 | 53 | 2455 | 73 | 2475 |
| 14 | 2416 | 34 | 2436 | 54 | 2456 | 74 | 2476 |
| 15 | 2417 | 35 | 2437 | 55 | 2457 | 75 | 2477 |
| 16 | 2418 | 36 | 2438 | 56 | 2458 | 76 | 2478 |
| 17 | 2419 | 37 | 2439 | 57 | 2459 | 77 | 2479 |
| 18 | 2420 | 38 | 2440 | 58 | 2460 | | |
| 19 | 2421 | 39 | 2441 | 59 | 2461 | | |

3.2.1 CONFIGURATION OF SYSTEM UNDER TEST

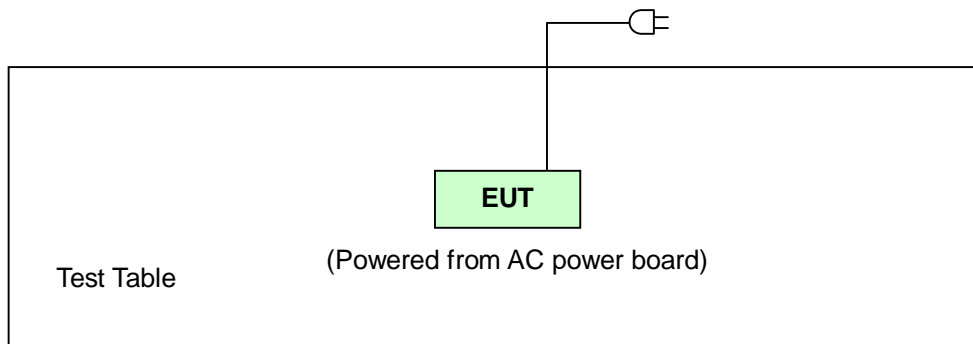



A D T

3.2.2 TEST MODE APPLICABILITY AND TESTED CHANNEL DETAIL:

| EUT configure mode | Applicable to | | | | Description |
|--------------------|---------------|-------|--------------------|----|-------------|
| | PLC | RE<1G | RE [≥] 1G | BM | |
| - | √ | √ | √ | √ | - |

Where PLC: Power Line Conducted Emission RE<1G RE: Radiated Emission below 1GHz
RE[≥]1G: Radiated Emission above 1GHz BM: Bandedge Measurement

Note: No need to concern of Conducted Emission due to the EUT is powered by battery.

POWER LINE CONDUCTED EMISSION TEST:

- Following channel(s) was (were) selected for the final test as listed below.

| AVAILABLE CHANNEL | TESTED CHANNEL | MODULATION TYPE |
|-------------------|----------------|-----------------|
| 0 to 77 | 0 | MSK |

RADIATED EMISSION TEST (BELOW 1 GHz):

- Pre-Scan has been conducted to determine the worst-case mode from all possible combinations between available modulations and antenna ports (if EUT with antenna diversity architecture).
 Following channel(s) was (were) selected for the final test as listed below.

| AVAILABLE CHANNEL | TESTED CHANNEL | MODULATION TYPE |
|-------------------|----------------|-----------------|
| 0 to 77 | 0 | MSK |

RADIATED EMISSION TEST (ABOVE 1 GHz):

- Pre-Scan has been conducted to determine the worst-case mode from all possible combinations between available modulations and antenna ports (if EUT with antenna diversity architecture).
 Following channel(s) was (were) selected for the final test as listed below.

| AVAILABLE CHANNEL | TESTED CHANNEL | MODULATION TYPE |
|-------------------|----------------|-----------------|
| 0 to 77 | 0, 39, 77 | MSK |

BANDEDGE MEASUREMENT:

- Pre-Scan has been conducted to determine the worst-case mode from all possible combinations between available modulations and antenna ports (if EUT with antenna diversity architecture).
- Following channel(s) was (were) selected for the final test as listed below.

| AVAILABLE CHANNEL | TESTED CHANNEL | MODULATION TYPE |
|-------------------|----------------|-----------------|
| 0 to 77 | 0, 77 | MSK |

TEST CONDITION:

| APPLICABLE TO | ENVIRONMENTAL CONDITIONS | INPUT POWER | TESTED BY |
|--------------------|---------------------------|--------------|-----------|
| PLC | 25deg. C, 85% RH, 1007hPa | 120Vac, 60Hz | Chad Lee |
| RE<1G | 24deg. C, 82% RH, 1006hPa | 120Vac, 60Hz | Chad Lee |
| RE ³ 1G | 23deg. C, 68% RH, 1008hPa | 120Vac, 60Hz | Chad Lee |
| BM | 23deg. C, 68% RH, 1008hPa | 120Vac, 60Hz | Chad Lee |



3.3 GENERAL DESCRIPTION OF APPLIED STANDARDS

The EUT is a RF product. According to the specifications of the manufacturer, it must comply with the requirements of the following standards:

FCC Part 15, Subpart C (Section 15.249)

ANSI C63.4-2003

ANSI C63.10-2009

All test items have been performed and recorded as per the above standards.

NOTE: The product has been verified to comply with the requirements of FCC Part 15, Subpart B, Class B (DoC). The test report has been issued separately.

3.4 DESCRIPTION OF SUPPORT UNITS

The EUT has been tested as an independent unit together without other necessary accessory.

4. TEST TYPES AND RESULTS

4.1 CONDUCTED EMISSION MEASUREMENT

4.1.1 LIMITS OF CONDUCTED EMISSION MEASUREMENT

| FREQUENCY OF EMISSION (MHz) | CONDUCTED LIMIT (dB μ V) | |
|-----------------------------|------------------------------|----------|
| | Quasi-peak | Average |
| 0.15-0.5 | 66 to 56 | 56 to 46 |
| 0.5-5 | 56 | 46 |
| 5-30 | 60 | 50 |

NOTE:

1. The lower limit shall apply at the transition frequencies.
2. All emanations from a class A/B digital device or system, including any network of conductors and apparatus connected thereto, shall not exceed the level of field strengths specified above.

4.1.2 TEST INSTRUMENTS

| DESCRIPTION & MANUFACTURER | MODEL NO. | SERIAL NO. | CALIBRATED DATE | CALIBRATED UNTIL |
|--|-----------------|--------------|-----------------|------------------|
| ROHDE & SCHWARZ Test Receiver | ESCS 30 | 100276 | Dec. 31, 2010 | Dec. 30, 2011 |
| ROHDE & SCHWARZ Artificial Mains Network (for EUT) | ESH3-Z5 | 100219 | Nov. 24, 2010 | Nov. 23, 2011 |
| LISN With Adapter (for EUT) | AD10 | C10Ada-001 | Nov. 24, 2010 | Nov. 23, 2011 |
| ROHDE & SCHWARZ Artificial Mains Network (for peripherals) | ESH3-Z5 | 100218 | Nov. 24, 2010 | Nov. 23, 2011 |
| Software | ADT_Cond_V7.3.7 | NA | NA | NA |
| Software | ADT_ISN_V7.3.7 | NA | NA | NA |
| RF cable (JYEBAO) | 5D-FB | Cable-C10.01 | Feb. 22, 2011 | Feb. 21, 2012 |
| SUHNER Terminator (For ROHDE & SCHWARZ LISN) | 65BNC-5001 | E1-010773 | Feb. 26, 2011 | Feb. 25, 2012 |

- NOTE:**
1. The calibration interval of the above test instruments is 12 months and the calibrations are traceable to NML/ROC and NIST/USA.
 2. The test was performed in Shielded Room No. 10.
 3. The VCCI Site Registration No. C-1852.

4.1.3 TEST PROCEDURES

- a. The EUT was placed 0.4 meters from the conducting wall of the shielded room with EUT being connected to the power mains through a line impedance stabilization network (LISN). Other support units were connected to the power mains through another LISN. The two LISNs provide 50 ohm/ 50uH of coupling impedance for the measuring instrument.
- b. Both lines of the power mains connected to the EUT were checked for maximum conducted interference.
- c. The frequency range from 150kHz to 30MHz was searched. Emission levels under limit - 20dB was not recorded.

4.1.4 DEVIATION FROM TEST STANDARD

No deviation.

4.1.5 TEST SETUP

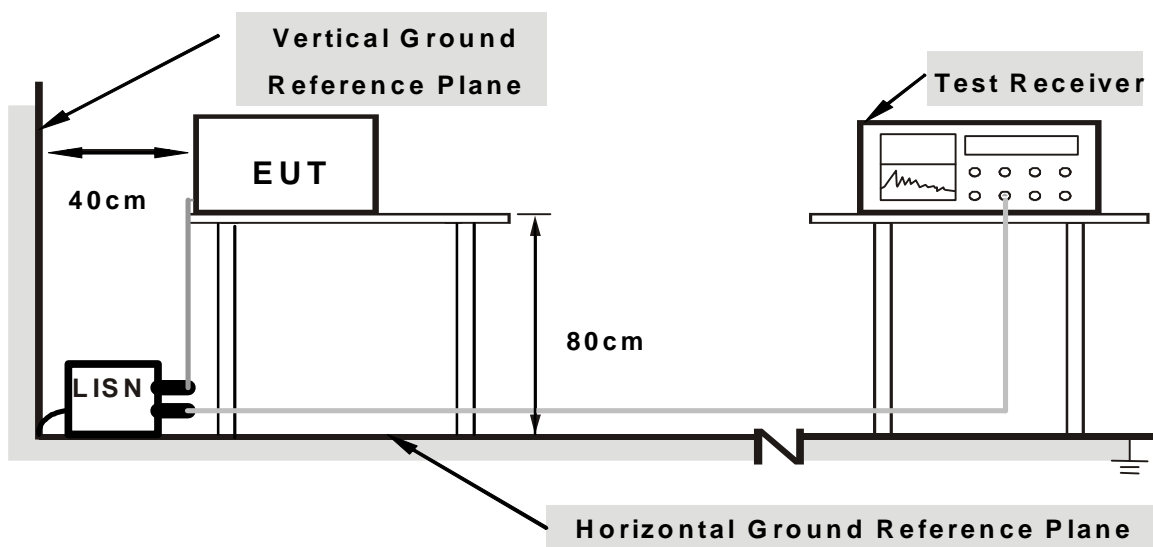

- Note:**
1. Support units were connected to second LISN.
 2. Both of LISNs (AMN) are 80 cm from EUT and at least 80 cm from other units and other metal planes

For the actual test configuration, please refer to the related item – Photographs of the Test Configuration.

4.1.6 EUT OPERATING CONDITIONS

Set the EUT under transmission condition continuously at specific channel frequency.

4.1.7 TEST RESULTS

CONDUCTED WORST CASE DATA

| | | | |
|--------------|--------|----------------------|-------|
| PHASE | Line 1 | 6dB BANDWIDTH | 9 kHz |
|--------------|--------|----------------------|-------|

| No | Freq. [MHz] | Corr. Factor (dB) | Reading Value | | Emission Level | | Limit | | Margin | |
|----|----------------|-------------------------|---------------|-----|----------------|-----|--------------|--------------|---------------|-----|
| | | | [dB (uV)] | | [dB (uV)] | | [dB (uV)] | | (dB) | |
| | | | Q.P. | AV. | Q.P. | AV. | Q.P. | AV. | Q.P. | AV. |
| 1 | 0.150 | 0.17 | 34.68 | - | 34.85 | - | 66.00 | 56.00 | -31.15 | - |
| 2 | 0.186 | 0.17 | 42.64 | - | 42.81 | - | 64.19 | 54.19 | -21.39 | - |
| 3 | 0.246 | 0.19 | 38.88 | - | 39.07 | - | 61.88 | 51.88 | -22.81 | - |
| 4 | 0.306 | 0.21 | 29.48 | - | 29.69 | - | 60.07 | 50.07 | -30.39 | - |
| 5 | 18.604 | 1.28 | 37.39 | - | 38.67 | - | 60.00 | 50.00 | -21.33 | - |
| 6 | 22.193 | 1.41 | 37.86 | - | 39.27 | - | 60.00 | 50.00 | -20.73 | - |

- REMARKS:**
1. Q.P. and AV. are abbreviations of quasi-peak and average individually.
 2. "-": The Quasi-peak reading value also meets average limit and measurement with the average detector is unnecessary.
 3. The emission levels of other frequencies were very low against the limit.
 4. Margin value = Emission level - Limit value
 5. Correction factor = Insertion loss + Cable loss
 6. Emission Level = Correction Factor + Reading Value.

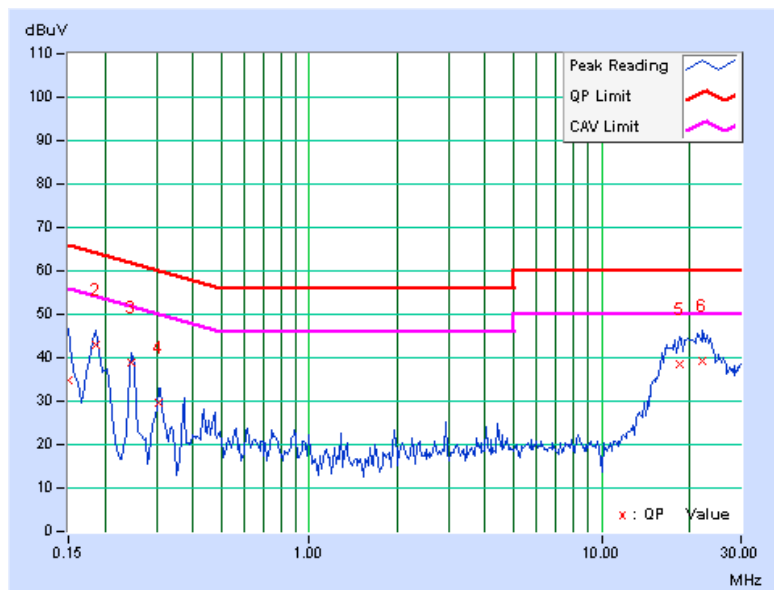

| | | | |
|--------------|--------|----------------------|-------|
| PHASE | Line 2 | 6dB BANDWIDTH | 9 kHz |
|--------------|--------|----------------------|-------|

| No | Freq. [MHz] | Corr. Factor (dB) | Reading Value | | Emission Level | | Limit | | Margin | |
|----|----------------|-------------------------|---------------|-----|----------------|-----|-----------|-------|--------|-----|
| | | | [dB (uV)] | | [dB (uV)] | | [dB (uV)] | | (dB) | |
| | | | Q.P. | AV. | Q.P. | AV. | Q.P. | AV. | Q.P. | AV. |
| 1 | 0.150 | 0.18 | 34.76 | - | 34.94 | - | 66.00 | 56.00 | -31.06 | - |
| 2 | 0.186 | 0.18 | 42.39 | - | 42.57 | - | 64.20 | 54.20 | -21.63 | - |
| 3 | 0.201 | 0.18 | 34.14 | - | 34.32 | - | 63.58 | 53.58 | -29.26 | - |
| 4 | 0.249 | 0.20 | 39.25 | - | 39.45 | - | 61.79 | 51.79 | -22.35 | - |
| 5 | 16.864 | 0.91 | 36.78 | - | 37.69 | - | 60.00 | 50.00 | -22.31 | - |
| 6 | 22.245 | 1.03 | 38.15 | - | 39.18 | - | 60.00 | 50.00 | -20.82 | - |

- REMARKS:**
1. Q.P. and AV. are abbreviations of quasi-peak and average individually.
 2. "-": The Quasi-peak reading value also meets average limit and measurement with the average detector is unnecessary.
 3. The emission levels of other frequencies were very low against the limit.
 4. Margin value = Emission level - Limit value
 5. Correction factor = Insertion loss + Cable loss
 6. Emission Level = Correction Factor + Reading Value.

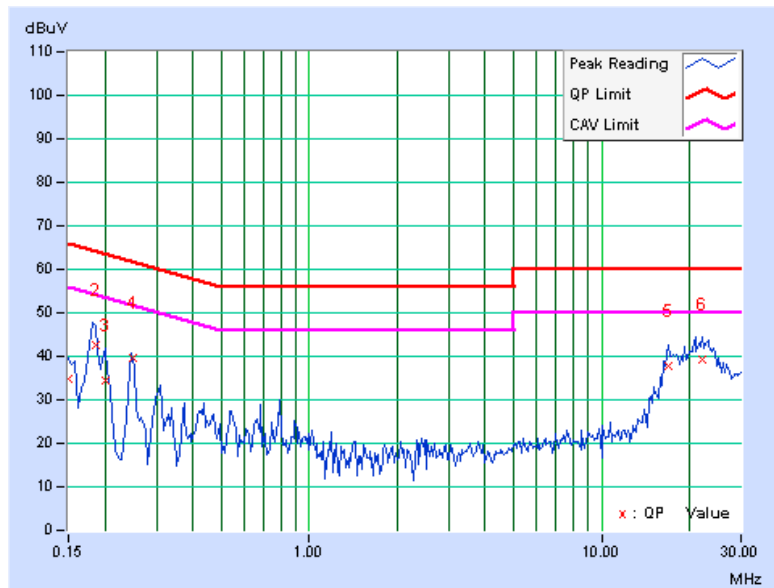

4.2 RADIATED EMISSION MEASUREMENT

4.2.1 LIMITS OF RADIATED EMISSION MEASUREMENT

Emissions radiated outside of the specified bands, shall be according to the general radiated limits in 15.209, 15.249 as following:

| 15.209 Limit | | |
|-----------------------|--|--|
| Frequencies (MHz) | Field strength (microvolts/meter) | Measurement distance (meters) |
| 0.009 ~ 0.490 | 2400/F(kHz) | 300 |
| 0.490 ~ 1.705 | 24000/F(kHz) | 30 |
| 1.705 ~ 30.0 | 30 | 30 |
| 30 ~ 88 | 100 | 3 |
| 88 ~ 216 | 150 | 3 |
| 216 ~ 960 | 200 | 3 |
| Above 960 | 500 | 3 |
| 15.249 Limit | | |
| Fundamental Frequency | Field Strength of Fundamental (millivolts/meter) | Field Strength of Harmonics (microvolts/meter) |
| 902 ~ 928 MHz | 50 | 500 |
| 2400 ~ 2483.5 MHz | 50 | 500 |
| 5725 ~ 5875 MHz | 50 | 500 |
| 24 ~ 24.25 GHz | 250 | 2500 |

NOTE:

1. The lower limit shall apply at the transition frequencies.
2. Emission level (dBuV/m) = 20 log Emission level (uV/m).
3. As shown in 15.35(b), for frequencies above 1000MHz, the field strength limits are based on average detector, however, the peak field strength of any emission shall not exceed the maximum permitted average limits, specified above by more than 20dB under any condition of modulation.

4.2.2 TEST INSTRUMENTS

| DESCRIPTION & MANUFACTURER | MODEL NO. | SERIAL NO. | CALIBRATED DATE | CALIBRATED UNTIL |
|--|------------------------------|------------|-----------------|------------------|
| HP Preamplifier | 8447D | 2432A03504 | Mar. 04, 2011 | Mar. 03, 2012 |
| HP Preamplifier | 8449B | 3008A01924 | Mar. 04, 2011 | Mar. 03, 2012 |
| HP Preamplifier | 8449B | 3008A01292 | Mar. 04, 2011 | Mar. 03, 2012 |
| ROHDE & SCHWARZ TEST RECEIVER | ESU26 | 100005 | Jun. 10, 2010 | Jun. 09, 2011 |
| Schwarzbeck Antenna | VULB 9168 | 137 | Apr. 12, 2011 | Apr. 11, 2012 |
| Schwarzbeck Antenna | VHBA 9123 | 480 | May 06, 2011 | May 05, 2012 |
| ADT. Turn Table | TT100 | 0306 | NA | NA |
| ADT. Tower | AT100 | 0306 | NA | NA |
| Software | ADT_Radiated_V 7.6.15.9.2 | NA | NA | NA |
| SUHNER RF cable | SF102 | CABLE-CH6 | Aug. 20, 2010 | Aug. 19, 2011 |
| EMCO Horn Antenna | 3115 | 6714 | Oct. 26, 2010 | Oct. 25, 2011 |
| EMCO Horn Antenna | 3115 | 9312-4192 | Apr. 22, 2011 | Apr. 21, 2012 |
| Highpass filter Wainwright Instruments | WHK 3.1/18G-10SS | SN 8 | NA | NA |

- NOTE:** 1. The calibration interval of the above test instruments is 12 months. And the calibrations are traceable to NML/ROC and NIST/USA.
2. The horn antenna and HP preamplifier (model: 8449B) are used only for the measurement of emission frequency above 1GHz if tested.
3. The test was performed in Chamber No. 6.
4. The Industry Canada Reference No. IC 7450E-6.
5. The FCC Site Registration No. is 447212.

4.2.3 TEST PROCEDURES

- a. The EUT was placed on the top of a rotating table 0.8 meters above the ground at a 3 meter semi-anechoic chamber room. The table was rotated 360 degrees to determine the position of the highest radiation.
- b. The EUT was set 3 meters away from the interference-receiving antenna, which was mounted on the top of a variable-height antenna tower.
- c. The height of antenna is varied from one meter to four meters above the ground to determine the maximum value of the field strength. Both horizontal and vertical polarizations of the antenna are set to make the measurement.
- d. For each suspected emission, the EUT was arranged to its worst case and then the antenna was tuned to heights from 1 meter to 4 meters and the rotatable table was turned from 0 degrees to 360 degrees to find the maximum reading.
- e. The test-receiver system was set to quasi-peak detect function and specified bandwidth with maximum hold mode when the test frequency is below 1 GHz.
- f. If the emission level of the EUT in peak mode was lower than the limit specified, then testing could be stopped and the peak values of the EUT would be reported. Otherwise the emissions would be re-tested one by one using peak, quasi-peak method or average method as specified and then reported in data sheet.

NOTE:

1. The resolution bandwidth and video bandwidth of test receiver/spectrum analyzer is 120kHz for Peak detection (PK) and Quasi-peak detection (QP) at frequency below 1GHz.
2. The resolution bandwidth of test receiver/spectrum analyzer is 1 MHz and video bandwidth is 3MHz for Peak detection at frequency above 1GHz.
3. The resolution bandwidth of test receiver/spectrum analyzer is 1MHz and the video bandwidth is 10Hz for Average detection (AV) at frequency above 1GHz.
4. All modes of operation were investigated and the worst-case emissions are reported.

4.2.4 DEVIATION FROM TEST STANDARD

No deviation

4.2.5 TEST SETUP

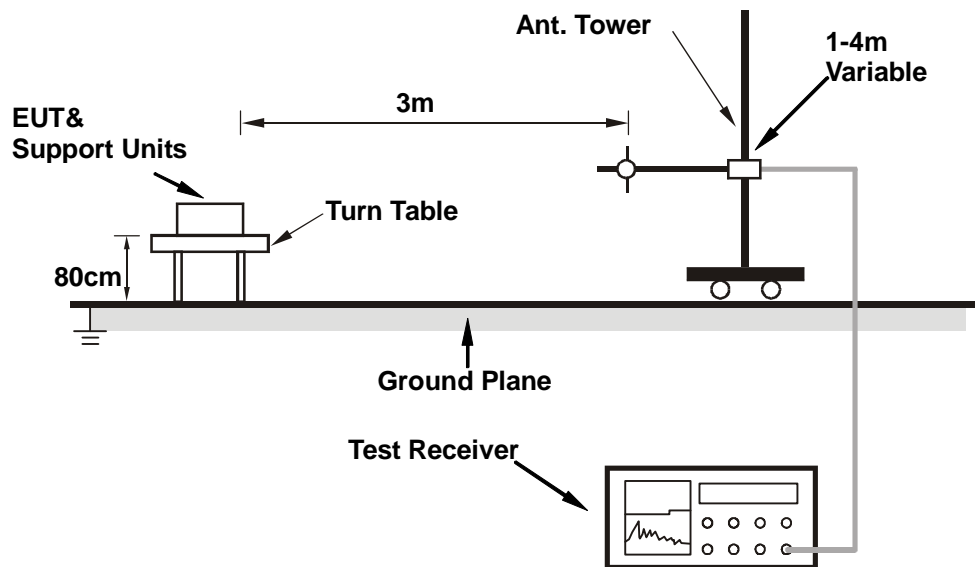

For the actual test configuration, please refer to the related item – Photographs of the Test Configuration.

4.2.6 EUT OPERATING CONDITIONS

Same as item 4.1.6



4.2.7 TEST RESULTS

ABOVE 1GHZ DATA

| EUT TEST CONDITION | | MEASUREMENT DETAIL | |
|--------------------------|-----------------------------|--------------------|---------------------------|
| CHANNEL | Channel 0 | FREQUENCY RANGE | 1 ~ 25GHz |
| INPUT POWER | 120Vac, 60 Hz | DETECTOR FUNCTION | Peak (PK) Average (AV) |
| ENVIRONMENTAL CONDITIONS | 23deg. C, 68%RH 1008 hPa | TESTED BY | Chad Lee |

| ANTENNA POLARITY & TEST DISTANCE: HORIZONTAL AT 3 M | | | | | | | | |
|---|-------------|-------------------------|----------------|-------------|--------------------|----------------------|------------------|--------------------------|
| NO. | FREQ. (MHz) | EMISSION LEVEL (dBuV/m) | LIMIT (dBuV/m) | MARGIN (dB) | ANTENNA HEIGHT (m) | TABLE ANGLE (Degree) | RAW VALUE (dBuV) | CORRECTION FACTOR (dB/m) |
| 1 | 2390.00 | 50.8 PK | 74.0 | -23.2 | 1.62 H | 89 | 17.37 | 33.39 |
| 2 | 2390.00 | 40.2 AV | 54.0 | -13.8 | 1.62 H | 89 | 6.77 | 33.39 |
| 3 | 2400.00 | 31.1 PK | 74.0 | -42.9 | 1.62 H | 89 | -2.33 | 33.45 |
| 4 | 2400.00 | 24.6 AV | 54.0 | -29.4 | 1.62 H | 89 | -8.83 | 33.45 |
| 5 | *2402.00 | 81.6 PK | 114.0 | -32.5 | 1.62 H | 89 | 48.10 | 33.45 |
| 6 | *2402.00 | 75.1 AV | 94.0 | -19.0 | 1.62 H | 89 | 41.60 | 33.45 |
| 7 | 4804.00 | 53.1 PK | 74.0 | -20.9 | 1.00 H | 249 | 11.29 | 41.82 |
| 8 | 4804.00 | 46.6 AV | 54.0 | -7.4 | 1.00 H | 249 | 4.79 | 41.82 |
| ANTENNA POLARITY & TEST DISTANCE: VERTICAL AT 3 M | | | | | | | | |
| NO. | FREQ. (MHz) | EMISSION LEVEL (dBuV/m) | LIMIT (dBuV/m) | MARGIN (dB) | ANTENNA HEIGHT (m) | TABLE ANGLE (Degree) | RAW VALUE (dBuV) | CORRECTION FACTOR (dB/m) |
| 1 | 2390.00 | 51.3 PK | 74.0 | -22.7 | 1.45 V | 161 | 17.91 | 33.39 |
| 2 | 2390.00 | 40.2 AV | 54.0 | -13.8 | 1.45 V | 161 | 6.77 | 33.39 |
| 3 | 2400.00 | 29.8 PK | 74.0 | -44.2 | 1.45 V | 161 | -3.63 | 33.45 |
| 4 | 2400.00 | 23.3 AV | 54.0 | -30.7 | 1.45 V | 161 | -10.13 | 33.45 |
| 5 | *2402.00 | 72.1 PK | 114.0 | -41.9 | 1.45 V | 161 | 38.67 | 33.45 |
| 6 | *2402.00 | 65.6 AV | 94.0 | -28.4 | 1.45 V | 161 | 32.17 | 33.45 |
| 7 | 4804.00 | 52.7 PK | 74.0 | -21.3 | 1.16 V | 74 | 10.87 | 41.82 |
| 8 | 4804.00 | 46.2 AV | 54.0 | -7.8 | 1.16 V | 74 | 4.37 | 41.82 |

- REMARKS:**
1. Emission level (dBuV/m) = Raw Value (dBuV) + Correction Factor (dB/m).
 2. Correction Factor (dB/m) = Antenna Factor (dB/m) + Cable Factor (dB).
 3. The other emission levels were very low against the limit.
 4. Margin value = Emission level – Limit value.
 5. “ * “ : Fundamental frequency
 6. The average value of fundamental frequency is: Average = Peak value + 20log(Duty cycle) Where the duty factor is calculated from following formula:
 $20 \log (\text{Duty cycle}) = 20 \log (12.56 \text{ ms} / 26.59 \text{ ms}) = -6.5 \text{ dB}$
 Please see page 22 for plotted duty.



A D T

| EUT TEST CONDITION | | MEASUREMENT DETAIL | |
|--------------------------|-----------------------------|--------------------|---------------------------|
| CHANNEL | Channel 39 | FREQUENCY RANGE | 1 ~ 25GHz |
| INPUT POWER | 120Vac, 60 Hz | DETECTOR FUNCTION | Peak (PK) Average (AV) |
| ENVIRONMENTAL CONDITIONS | 23deg. C, 68%RH 1008 hPa | TESTED BY | Chad Lee |

| ANTENNA POLARITY & TEST DISTANCE: HORIZONTAL AT 3 M | | | | | | | | |
|---|-------------|-------------------------|----------------|-------------|--------------------|----------------------|------------------|--------------------------|
| NO. | FREQ. (MHz) | EMISSION LEVEL (dBuV/m) | LIMIT (dBuV/m) | MARGIN (dB) | ANTENNA HEIGHT (m) | TABLE ANGLE (Degree) | RAW VALUE (dBuV) | CORRECTION FACTOR (dB/m) |
| 1 | *2441.00 | 82.0 PK | 114.0 | -32.0 | 1.69 H | 80 | 48.47 | 33.54 |
| 2 | *2441.00 | 75.5 AV | 94.0 | -18.5 | 1.69 H | 80 | 41.97 | 33.54 |
| 3 | 4882.00 | 53.4 PK | 74.0 | -20.6 | 1.00 H | 13 | 11.77 | 41.64 |
| 4 | 4882.00 | 46.9 AV | 54.0 | -7.1 | 1.00 H | 13 | 5.27 | 41.64 |
| ANTENNA POLARITY & TEST DISTANCE: VERTICAL AT 3 M | | | | | | | | |
| NO. | FREQ. (MHz) | EMISSION LEVEL (dBuV/m) | LIMIT (dBuV/m) | MARGIN (dB) | ANTENNA HEIGHT (m) | TABLE ANGLE (Degree) | RAW VALUE (dBuV) | CORRECTION FACTOR (dB/m) |
| 1 | *2441.00 | 71.2 PK | 114.0 | -42.9 | 1.68 V | 18 | 37.61 | 33.54 |
| 2 | *2441.00 | 64.7 AV | 94.0 | -29.4 | 1.68 V | 18 | 31.11 | 33.54 |
| 3 | 4882.00 | 53.4 PK | 74.0 | -20.6 | 1.00 V | 13 | 11.77 | 41.64 |
| 4 | 4882.00 | 46.9 AV | 54.0 | -7.1 | 1.00 V | 13 | 5.27 | 41.64 |

- REMARKS:**
1. Emission level (dBuV/m) = Raw Value (dBuV) + Correction Factor (dB/m).
 2. Correction Factor (dB/m) = Antenna Factor (dB/m) + Cable Factor (dB).
 3. The other emission levels were very low against the limit.
 4. Margin value = Emission level – Limit value.
 5. “ * “ : Fundamental frequency
 6. The average value of fundamental frequency is: Average = Peak value + 20log(Duty cycle) Where the duty factor is calculated from following formula:
 $20 \log (\text{Duty cycle}) = 20 \log (12.56 \text{ ms} / 26.59 \text{ ms}) = -6.5 \text{ dB}$
 Please see page 22 for plotted duty.



| EUT TEST CONDITION | | MEASUREMENT DETAIL | |
|--------------------------|-----------------------------|--------------------|---------------------------|
| CHANNEL | Channel 77 | FREQUENCY RANGE | 1 ~ 25GHz |
| INPUT POWER | 120Vac, 60 Hz | DETECTOR FUNCTION | Peak (PK) Average (AV) |
| ENVIRONMENTAL CONDITIONS | 23deg. C, 68%RH 1008 hPa | TESTED BY | Chad Lee |

| ANTENNA POLARITY & TEST DISTANCE: HORIZONTAL AT 3 M | | | | | | | | |
|---|-------------|-------------------------|----------------|-------------|--------------------|----------------------|------------------|--------------------------|
| NO. | FREQ. (MHz) | EMISSION LEVEL (dBuV/m) | LIMIT (dBuV/m) | MARGIN (dB) | ANTENNA HEIGHT (m) | TABLE ANGLE (Degree) | RAW VALUE (dBuV) | CORRECTION FACTOR (dB/m) |
| 1 | *2479.00 | 82.8 PK | 114.0 | -31.2 | 1.61 H | 94 | 49.18 | 33.62 |
| 2 | *2479.00 | 76.3 AV | 94.0 | -17.7 | 1.61 H | 94 | 42.68 | 33.62 |
| 3 | 2483.50 | 41.8 PK | 74.0 | -32.2 | 1.61 H | 94 | 8.17 | 33.63 |
| 4 | 2483.50 | 35.3 AV | 54.0 | -18.7 | 1.61 H | 94 | 1.67 | 33.63 |
| 5 | 4958.00 | 53.0 PK | 74.0 | -21.0 | 1.00 H | 243 | 10.95 | 42.01 |
| 6 | 4958.00 | 46.5 AV | 54.0 | -7.5 | 1.00 H | 243 | 4.45 | 42.01 |
| ANTENNA POLARITY & TEST DISTANCE: VERTICAL AT 3 M | | | | | | | | |
| NO. | FREQ. (MHz) | EMISSION LEVEL (dBuV/m) | LIMIT (dBuV/m) | MARGIN (dB) | ANTENNA HEIGHT (m) | TABLE ANGLE (Degree) | RAW VALUE (dBuV) | CORRECTION FACTOR (dB/m) |
| 1 | *2479.00 | 73.4 PK | 114.0 | -40.6 | 1.40 V | 75 | 39.81 | 33.61 |
| 2 | *2479.00 | 66.9 AV | 94.0 | -27.1 | 1.40 V | 75 | 33.31 | 33.61 |
| 3 | 2483.50 | 32.4 PK | 74.0 | -41.6 | 1.40 V | 75 | -1.21 | 33.63 |
| 4 | 2483.50 | 25.9 AV | 54.0 | -28.1 | 1.40 V | 75 | -7.71 | 33.63 |
| 5 | 4958.00 | 52.5 PK | 74.0 | -21.5 | 1.00 V | 113 | 10.48 | 42.01 |
| 6 | 4958.00 | 46.0 AV | 54.0 | -8.0 | 1.00 V | 113 | 3.98 | 42.01 |

- REMARKS:**
- Emission level (dBuV/m) = Raw Value (dBuV) + Correction Factor (dB/m).
 - Correction Factor (dB/m) = Antenna Factor (dB/m) + Cable Factor (dB).
 - The other emission levels were very low against the limit.
 - Margin value = Emission level – Limit value.
 - “ * “ : Fundamental frequency
 - The average value of fundamental frequency is: Average = Peak value + 20log(Duty cycle) Where the duty factor is calculated from following formula:
 $20 \log (\text{Duty cycle}) = 20 \log (12.56 \text{ ms} / 26.59 \text{ ms}) = -6.5 \text{ dB}$
 Please see page 22 for plotted duty.



A D T

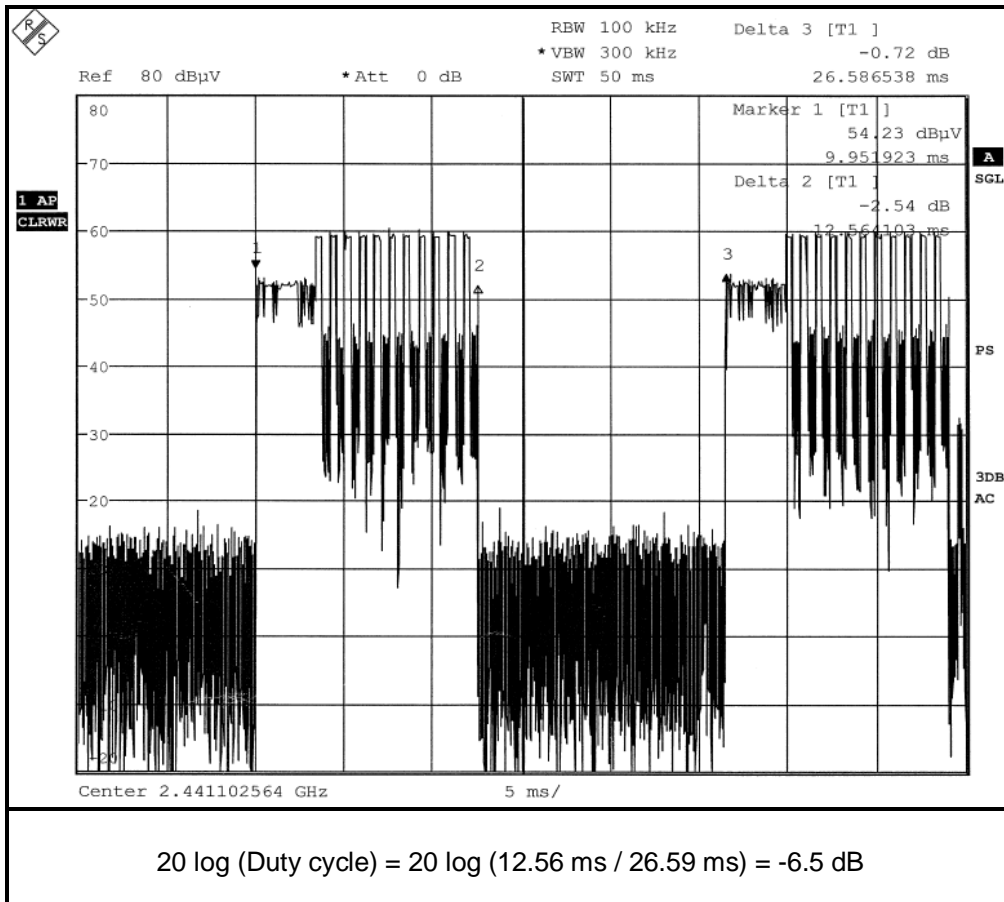



BELOW 1GHz WORST-CASE DATA

| EUT TEST CONDITION | | MEASUREMENT DETAIL | |
|--------------------------|-----------------------------|--------------------|---------------|
| CHANNEL | Channel 0 | FREQUENCY RANGE | Below 1000MHz |
| INPUT POWER | 120Vac, 60 Hz | DETECTOR FUNCTION | Quasi-Peak |
| ENVIRONMENTAL CONDITIONS | 24deg. C, 82%RH 1006 hPa | TESTED BY | Chad Lee |

| ANTENNA POLARITY & TEST DISTANCE: HORIZONTAL AT 3 M | | | | | | | | |
|---|-------------|-------------------------|----------------|-------------|--------------------|----------------------|------------------|--------------------------|
| NO. | FREQ. (MHz) | EMISSION LEVEL (dBuV/m) | LIMIT (dBuV/m) | MARGIN (dB) | ANTENNA HEIGHT (m) | TABLE ANGLE (Degree) | RAW VALUE (dBuV) | CORRECTION FACTOR (dB/m) |
| 1 | 67.12 | 26.2 QP | 40.0 | -13.8 | 1.55 H | 208 | 13.57 | 12.63 |
| 2 | 246.27 | 33.9 QP | 46.0 | -12.2 | 1.65 H | 139 | 20.36 | 13.49 |
| 3 | 262.41 | 32.0 QP | 46.0 | -14.0 | 1.34 H | 133 | 17.80 | 14.20 |
| 4 | 410.90 | 32.4 QP | 46.0 | -13.7 | 1.84 H | 151 | 13.76 | 18.59 |
| 5 | 641.70 | 33.9 QP | 46.0 | -12.1 | 1.32 H | 73 | 9.99 | 23.95 |
| 6 | 954.81 | 33.2 QP | 46.0 | -12.8 | 1.14 H | 94 | 4.60 | 28.63 |
| ANTENNA POLARITY & TEST DISTANCE: VERTICAL AT 3 M | | | | | | | | |
| NO. | FREQ. (MHz) | EMISSION LEVEL (dBuV/m) | LIMIT (dBuV/m) | MARGIN (dB) | ANTENNA HEIGHT (m) | TABLE ANGLE (Degree) | RAW VALUE (dBuV) | CORRECTION FACTOR (dB/m) |
| 1 | 60.67 | 30.6 QP | 40.0 | -9.4 | 1.08 V | 10 | 17.16 | 13.46 |
| 2 | 67.12 | 37.2 QP | 40.0 | -2.8 | 1.52 V | 160 | 24.59 | 12.63 |
| 3 | 407.67 | 31.3 QP | 46.0 | -14.7 | 1.33 V | 79 | 12.78 | 18.54 |
| 4 | 641.70 | 32.1 QP | 46.0 | -14.0 | 1.00 V | 73 | 8.10 | 23.95 |
| 5 | 895.09 | 33.6 QP | 46.0 | -12.4 | 1.00 V | 322 | 5.76 | 27.83 |
| 6 | 956.42 | 35.9 QP | 46.0 | -10.1 | 1.02 V | 121 | 7.23 | 28.65 |

- REMARKS:**
1. Emission level (dBuV/m) = Raw Value (dBuV) + Correction Factor (dB/m).
 2. Correction Factor (dB/m) = Antenna Factor (dB/m) + Cable Factor (dB).
 3. The other emission levels were very low against the limit.
 4. Margin value = Emission level – Limit value.

4.3 BAND EDGES MEASUREMENT

4.3.1 LIMITS OF BAND EDGES MEASUREMENT

Below -50dB of the highest emission level of operating band (in 100kHz Resolution Bandwidth).

4.3.2 TEST INSTRUMENTS

| DESCRIPTION & MANUFACTURER | MODEL NO. | SERIAL NO. | CALIBRATED DATE | CALIBRATED UNTIL |
|----------------------------|-----------|------------|-----------------|------------------|
| SPECTRUM ANALYZER | FSP 40 | 100036 | Apr. 06, 2011 | Apr. 05, 2012 |

NOTE: The calibration interval of the above test instruments is 12 months and the calibrations are traceable to NML/ROC and NIST/USA.

4.3.3 TEST PROCEDURE

The transmitter output was connected to the spectrum analyzer via a low lose cable. Set both RBW and VBW of spectrum analyzer to 100 kHz and 300 kHz with suitable frequency span including 100 MHz bandwidth from band edge. The band edges was measured and recorded.

The spectrum plots are attached on the following pages.

4.3.4 DEVIATION FROM TEST STANDARD

No deviation

4.3.5 EUT OPERATING CONDITION

Same as Item 4.2.6

4.3.6 TEST RESULTS

The spectrum plots are attached on the following 4 images. D1 line indicates the highest level, and D2 line indicates the 50dB offset below D1. It shows compliance with the requirement in part 15.249(d).



A D T

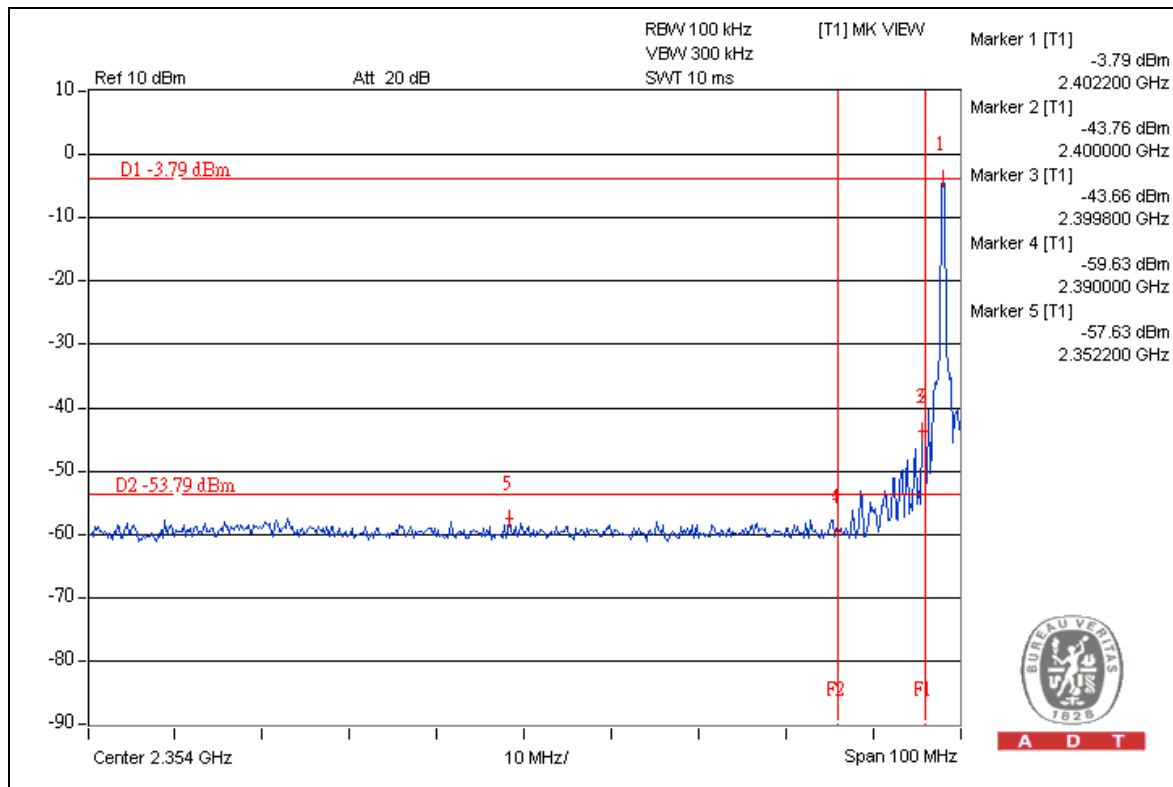

A D T

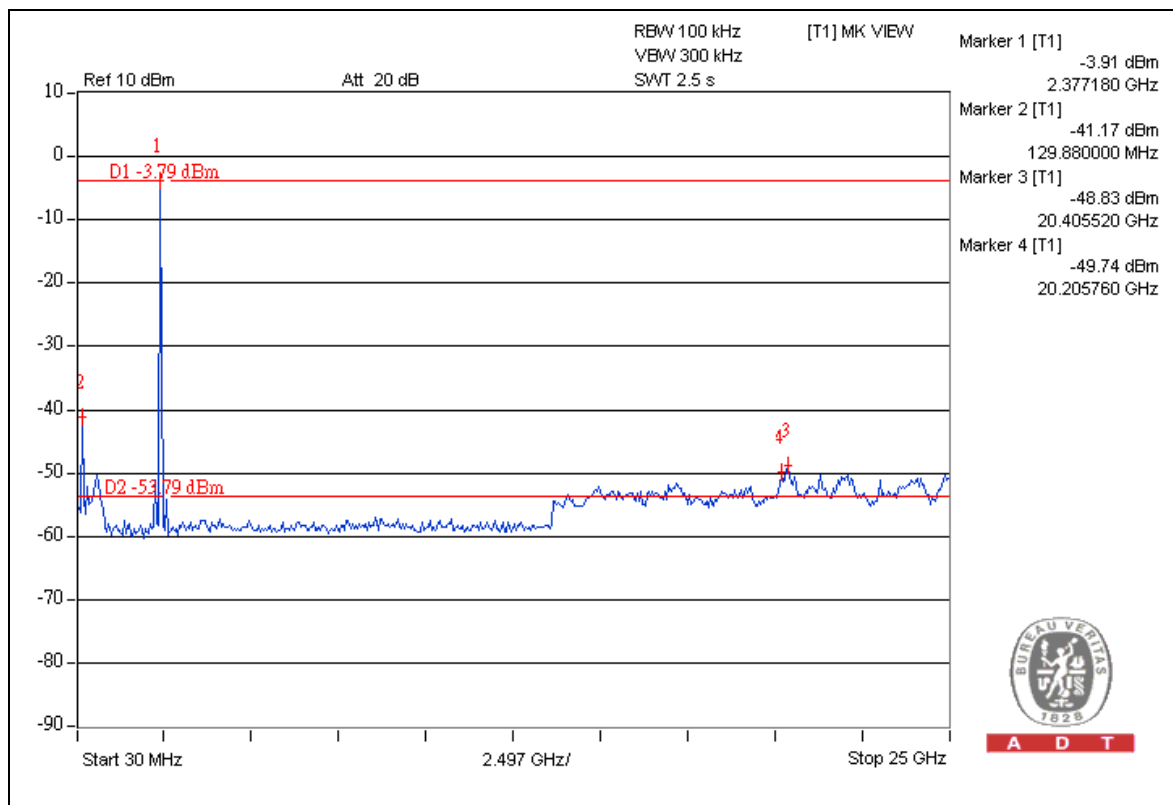

A D T



A D T

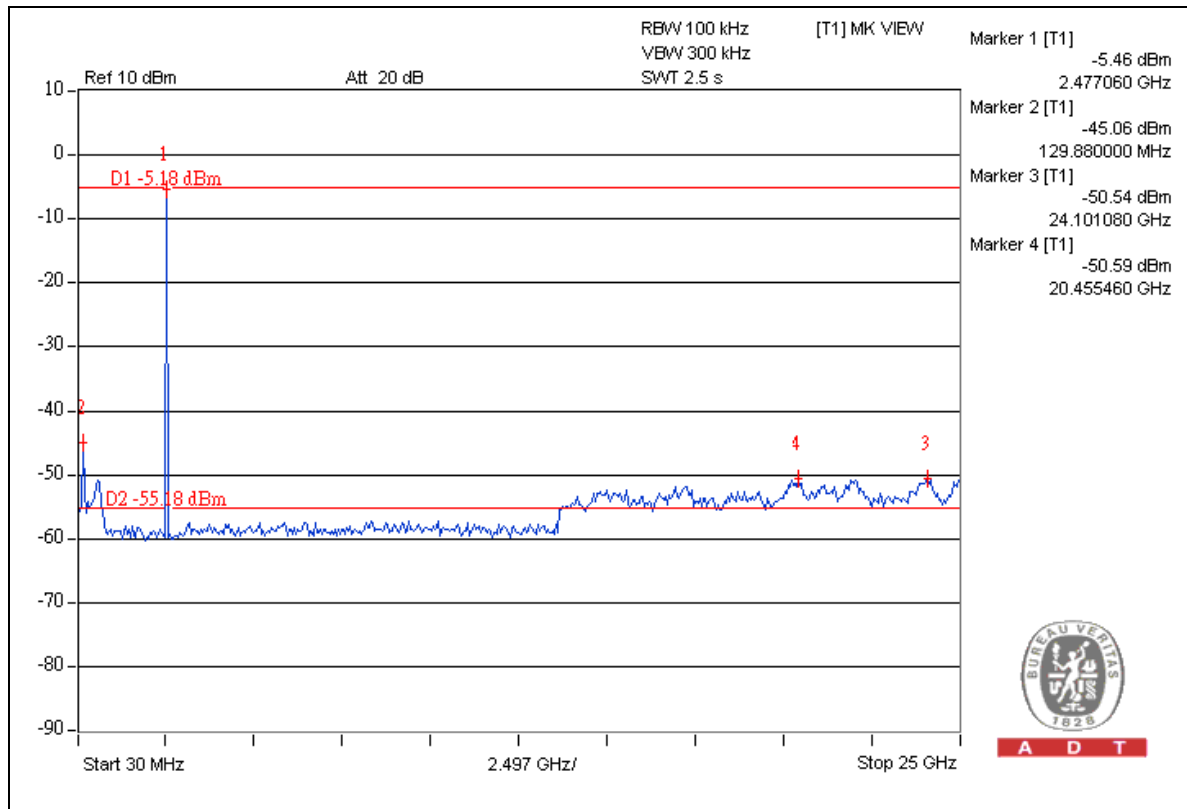
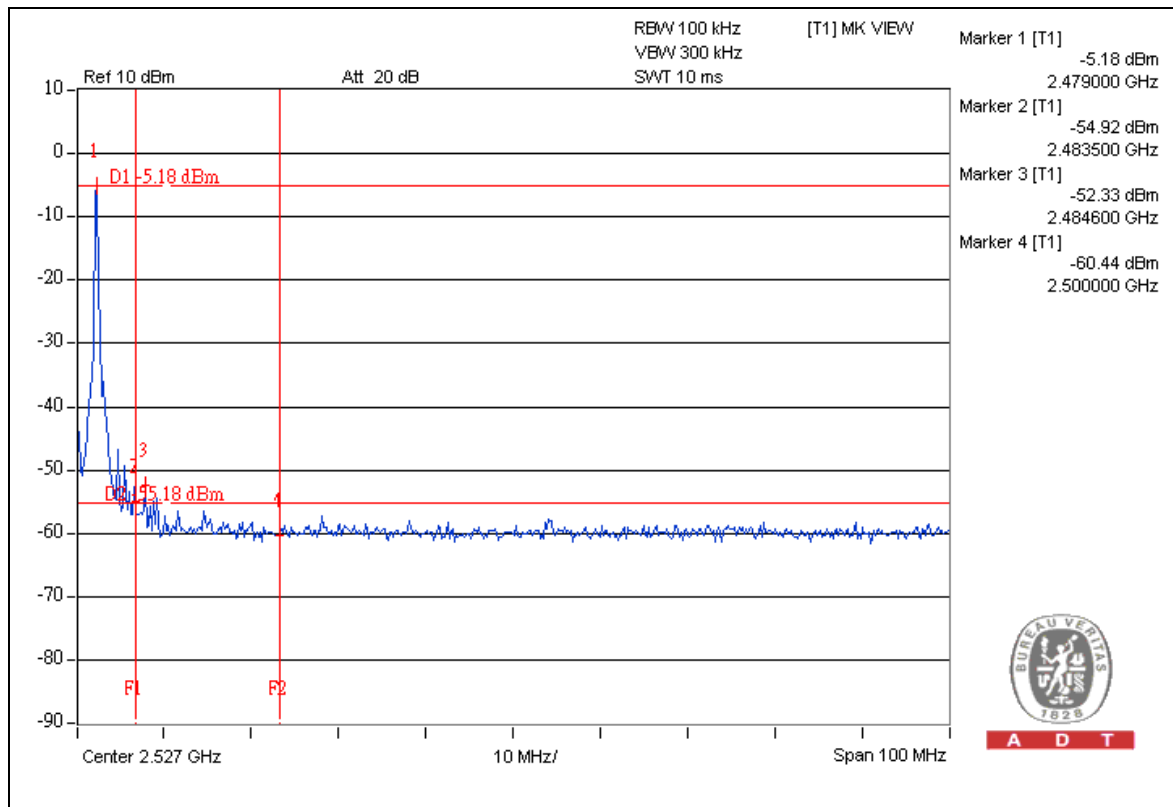

5. PHOTOGRAPHS OF THE TEST CONFIGURATION

Please refer to the attached file (Test Setup Photo).



6. INFORMATION ON THE TESTING LABORATORIES

We, Bureau Veritas Consumer Products Services (H.K.) Ltd., Taoyuan Branch, were founded in 1988 to provide our best service in EMC, Radio, Telecom and Safety consultation. Our laboratories are accredited and approved according to ISO/IEC 17025.

Copies of accreditation certificates of our laboratories obtained from approval agencies can be downloaded from our web site: www.adt.com.tw/index.5.phtml.
If you have any comments, please feel free to contact us at the following:

Linko EMC/RF Lab:

Tel: 886-2-26052180

Fax: 886-2-26051924

Hsin Chu EMC/RF Lab:

Tel: 886-3-5935343

Fax: 886-3-5935342

Hwa Ya EMC/RF/Safety Telecom Lab:

Tel: 886-3-3183232

Fax: 886-3-3185050

Web Site: www.adt.com.tw

The address and road map of all our labs can be found in our web site also.



A D T

7. APPENDIX A – MODIFICATIONS RECORDERS FOR ENGINEERING CHANGES TO THE EUT BY THE LAB

No any modifications are made to the EUT by the lab during the test.

---END---