

APPENDIX 1: Photographs of EUT and SAR test setup

Appendix 1-1: Photograph of Platform and antenna position

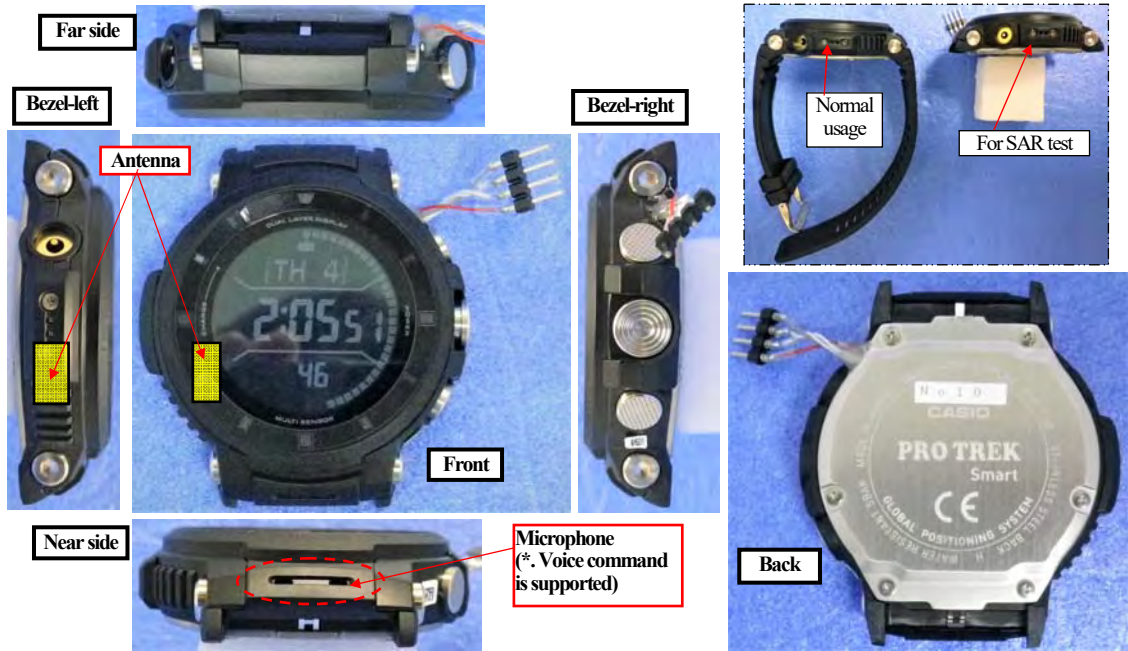

Antenna location and antenna distance [Unit: mm]

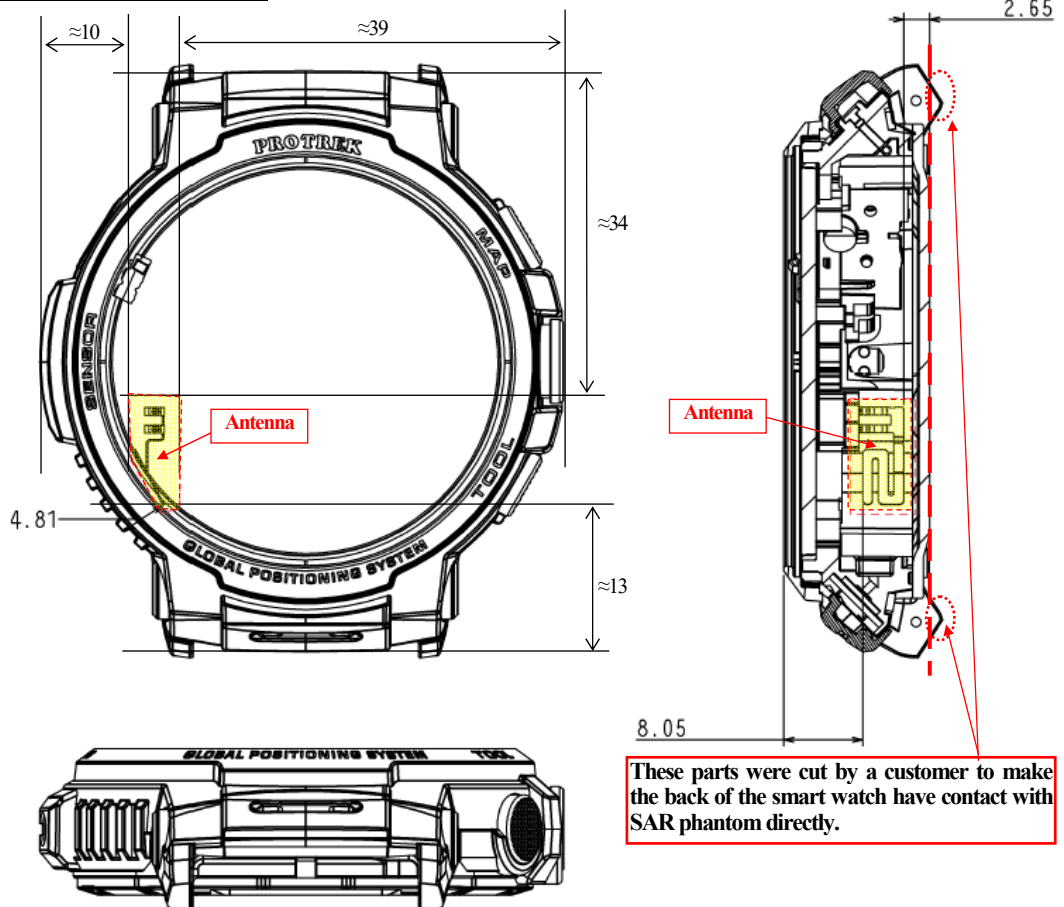

Appendix 1-2: EUT and support equipment

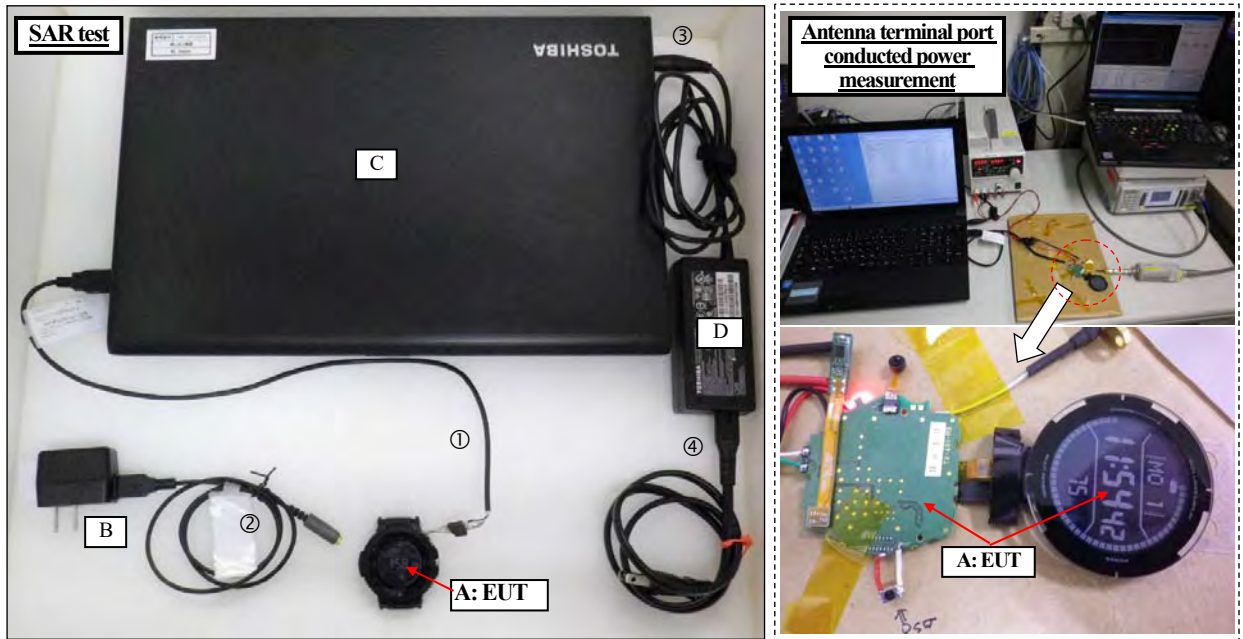

Description of EUT and Support Equipment







No.	Item	Model number	Serial number	Manufacturer	Remark
A	Smart Watch	WSD-F30	10	CASIO COMPUTER CO., LTD.	EUT.
B	AC Adaptor	AD-W50100U1	073	CASIO COMPUTER CO., LTD.	Support equipment.
C	Laptop Computer (UL control#: SRE-171)	dynabook Satellite B453 M	ZE127581H	Toshiba	Support equipment
D	AC Adaptor (Laptop PC)	(MN)PA3917U-1ACA	201140918507284	Toshiba	Support equipment

List of cables used

No.	Name	Length (m)	Shield
①	USB cable	0.5	Shielded
②	Charge cable (USB)	0.8	Shielded

No.	Name	Length (m)	Shield
③	DC cable (AC adaptor)	1.7	Unshielded
④	AC cable (AC adaptor)	0.85	Unshielded

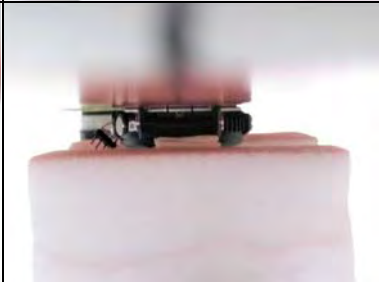
Appendix 1-3: Photograph of test setup

Position	Setup photographs		
Back (Touch)			
			
Front (10mm gap)	