APPENDIX 2: SAR Measurement data

Appendix 2-1: Evaluation procedure

The SAR evaluation was performed with the following procedure:

- Step 1:** Measurement of the E-field at a fixed location above the central position of flat phantom was used as a reference value for assessing the power drop.
- Step 2:** The SAR distribution at the exposed side of head or body position was measured at a distance of each device from the inner surface of the shell. The area covered the entire dimension of the antenna of EUT and suitable horizontal grid spacing of EUT (and/or platform). Based on these data, the area of the maximum absorption was determined by splines interpolation.
- Step 3:** Around this point found in the Step 2 (area scan), a volume of 30mm(X axis)×30mm(Y axis)×30mm(Z axis) (or more) was assessed by measuring 7×7×7 points (or more) under 3GHz.
And for any secondary peaks found in the Step2 which are within 2dB of the SAR limit (1.6W/kg), this Step3 (Zoom scan) is repeated.
On the basis of this data set, the spatial peak SAR value was evaluated under the following procedure:
- (1) The data at the surface were extrapolated, since the center of the dipoles is 1mm away from the tip of the probe and the distance between the surface and the lowest measuring point is 2mm. The extrapolation was based on a least square algorithm. A polynomial of the fourth order was calculated through the points in z-axes. This polynomial was then used to evaluate the points between the surface and the probe tip.
 - (2) The maximum interpolated value was searched with a straightforward algorithm. Around this maximum the SAR values averaged over the spatial volumes (1g or 10g) were computed by the 3D-Spline interpolation algorithm. The 3D-Spline is composed of three one-dimensional splines with the "Not a knot"-condition (in x, y and z-directions). The volume was integrated with the trapezoidal-algorithm. One thousand points (10×10×10) were interpolated to calculate the average.
 - (3) All neighboring volumes were evaluated until no neighboring volume with a higher average value was found.
- Step 4:** Re-measurement of the E-field at the same location as in Step 1 for the assessment of the power drift.
- Step 5:** Repeat Step 1-Step 4 with other condition or/and setup of EUT (and/or platform).
- *. The all SAR tests were conservatively performed with test separation distance 0mm. The distance between the SAR probe tip to the surface of test device which is touched the bottom surface of the phantom is approx. 3 mm for 2.4GHz band and 2.4 mm for 5GHz band. The phantom bottom thickness is approx. 2mm in the SAR test area.

Appendix 2-2: SAR measurement data

Worst SAR plot

Plot 1-1: Back & touch, 11b (1Mbps), 2462 MHz -> Highest reported extremity (wrist) SAR(10g)

EUT: RF Module (in Smart Outdoor Watch) ; Type: WSD-F21 (Platform:WSD-F21); Serial: 6 (Platform: 6)

Mode: 11b(1Mbps, DBPSK/DSSS) (UID: 0, Wi-fi 2.4GHz(0), Frame Length in ms: 0; PAR: 0; PMF: 1); **Frequency: 2462 MHz; Crest Factor: 1.0**

Medium: M2450(1903); Medium parameters used: f = 2462 MHz; $\sigma = 2.037$ S/m; $\epsilon_r = 50.65$; $\rho = 1000$ kg/m³

Measurement Standard: DASYS5 (IEEE/IEC/ANSI C63.19-2007)

DASY Configuration: -Electronics: DAE4 Sn626; Calibrated: 2018/10/15 ; -Phantom: ELI v4.0; Type: QDOVA001BA; Serial: 1059; Phantom section: Flat Section

-DASY52 52.10.2(1495); SEMCAD X 14.6.12(7450); -Probe: EX3DV4 - SN3907; ConvF(7.32, 7.32, 7.32) @ 2462 MHz; Calibrated: 2018/05/15

-Sensor-Surface: 2mm (Mechanical Surface Detection (Locations From Previous Scan Used)), Sensor-Surface: 2mm (Mechanical Surface Detection), z = 1.0, 31.0, 161.0

touch(10g),back,add 2/24b3;2462,back&d0,b(1m)/

Area:96x84,12 (8x9x1): Measurement grid: dx=12mm, dy=12mm; Maximum value of SAR (measured) = 0.0994 W/kg

Area:96x84,12 (71x81x1): Interpolated grid: dx=1.200 mm, dy=1.200 mm; Maximum value of SAR (interpolated) = 0.102 W/kg

Z:160,5 (1x1x33): Measurement grid: dx=20mm, dy=20mm, dz=5mm; Maximum value of SAR (measured) = 0.115 W/kg

Zoom1:30x30x30,5 (7x7x7)/Cube 0: Measurement grid: dx=5mm, dy=5mm, dz=5mm;

Reference Value = 6.494 V/m; Power Drift = 0.06 dB; Maximum value of SAR (measured) = 0.113 W/kg; Peak SAR (extrapolated) = 0.166 W/kg

SAR(1 g) = 0.076 W/kg; SAR(10 g) = 0.037 W/kg

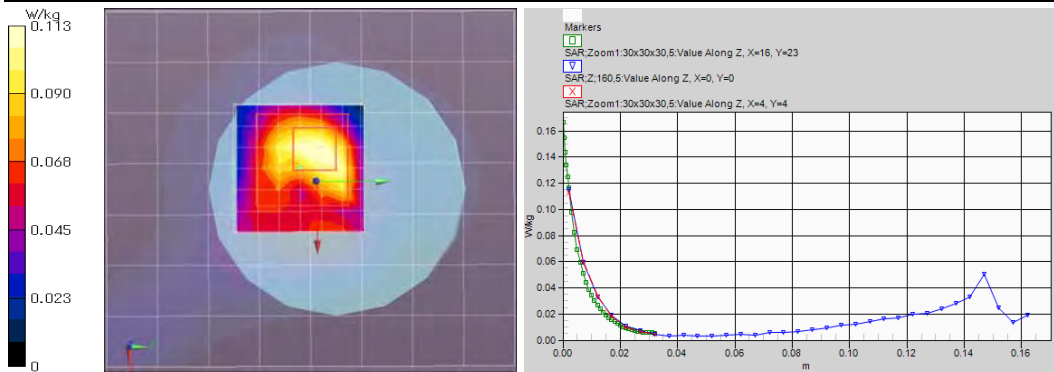

Remarks: * Date tested: 2019/03/05; Tested by: Hiroshi Naka; Tested place: No.7 shielded room,
 * liquid depth: 151 mm; Position: distance of EUT to phantom: 0 mm (2 mm to liquid); ambient: (23-24) deg.C. / (40-55) %RH,
 * liquid temperature: 22.0(start)/22.1(end)/22.0(in check) deg.C.; * White cubic: zoom scan area, Red cubic: big=SAR(10g) / small=SAR(1g)

Plot 2-1: Front & 10 mm gap, 11b (1Mbps), 2437 MHz -> Highest reported partial body (next-to-mouth) SAR(1g)

EUT: RF Module (in Smart Outdoor Watch) ; Type: WSD-F21 (Platform:WSD-F21); Serial: 6 (Platform: 6)

Mode: 11b(1Mbps, DBPSK/DSSS) (UID: 0, Wi-fi 2.4GHz(0), Frame Length in ms: 0; PAR: 0; PMF: 1); **Frequency: 2437 MHz; Crest Factor: 1.0**

Medium: HSL2450(1903); Medium parameters used: f = 2437 MHz; $\sigma = 1.857$ S/m; $\epsilon_r = 38.16$; $\rho = 1000$ kg/m³

Measurement Standard: DASYS5 (IEEE/IEC/ANSI C63.19-2007)

DASY Configuration: -Electronics: DAE4 Sn626; Calibrated: 2018/10/15 ; -Phantom: ELI v4.0; Type: QDOVA001BA; Serial: 1059; Phantom section: Flat Section

-DASY52 52.10.2(1495); SEMCAD X 14.6.12(7450); -Probe: EX3DV4 - SN3907; ConvF(7.31, 7.31, 7.31) @ 2437 MHz; Calibrated: 2018/05/15

-Sensor-Surface: 2mm (Mechanical Surface Detection (Locations From Previous Scan Used)), Sensor-Surface: 2mm (Mechanical Surface Detection), z = 1.0, 31.0, 161.0

touch,front24h9(fcc);2437,front&gap10,b(1m)/

Area:84x84,12 (8x8x1): Measurement grid: dx=12mm, dy=12mm; Maximum value of SAR (measured) = 0.0749 W/kg

Area:84x84,12 (71x71x1): Interpolated grid: dx=1.200 mm, dy=1.200 mm; Maximum value of SAR (interpolated) = 0.0849 W/kg

Z:160,5 (1x1x33): Measurement grid: dx=20mm, dy=20mm, dz=5mm; Maximum value of SAR (measured) = 0.0828 W/kg

Zoom:30x30x30,5 (7x7x7)/Cube 0: Measurement grid: dx=5mm, dy=5mm, dz=5mm;

Reference Value = 6.812 V/m; Power Drift = -0.02 dB; Maximum value of SAR (measured) = 0.0823 W/kg; Peak SAR (extrapolated) = 0.104 W/kg

SAR(1 g) = 0.060 W/kg; SAR(10 g) = 0.032 W/kg

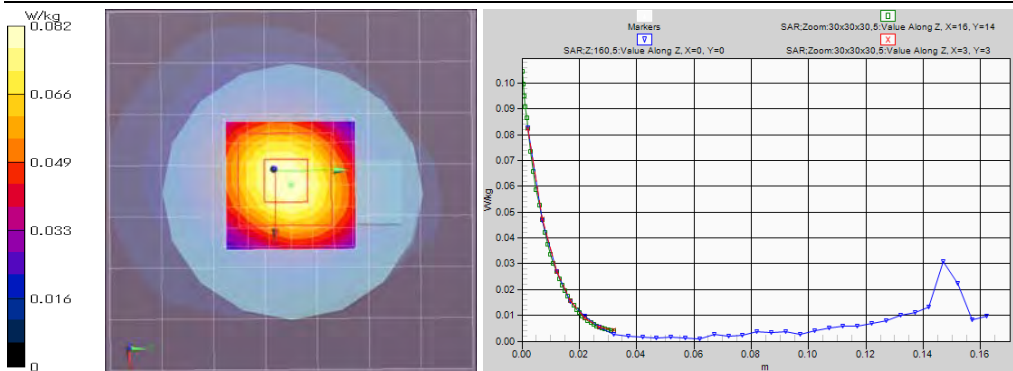

Remarks: * Date tested: 2019/03/04; Tested by: Hiroshi Naka; Tested place: No.7 shielded room,
 * liquid depth: 150 mm; Position: distance of EUT to phantom: 0 mm (2 mm to liquid); ambient: (24-25) deg.C. / (40-55) %RH,
 * liquid temperature: 24.0(start)/23.9(end)/23.9(in check) deg.C.; * White cubic: zoom scan area, Red cubic: big=SAR(10g) / small=SAR(1g)

Appendix 2-2: SAR measurement data (cont'd)

Other SAR plots

Plot 1-2: Back&touch, 11b (1Mbps), 2412 MHz

EUT: RF Module (in Smart Outdoor Watch) ; Type: WSD-F21 (Platform:WSD-F21); Serial: 6 (Platform: 6)

Mode: 11b(1Mbps, DBPSK/DSSS) (UID: 0, Wi-fi_2.4GHz(0), Frame Length in ms: 0; PAR: 0; PMF: 1); Frequency: 2412 MHz; Crest Factor: 1.0

Medium: M2450(1903); Medium parameters used: f = 2412 MHz; $\sigma = 1.966$ S/m; $\epsilon_r = 50.84$; $\rho = 1000$ kg/m³

Measurement Standard: DASYS (IEEE/IEC/ANSI C63.19-2007)

DASY Configuration: -Electronics: DAE4 Sn626; Calibrated: 2018/10/15 ; -Phantom: ELI v4.0; Type: QDOVA001BA; Serial: 1059; Phantom section: Flat Section

-DASY52 52.10.2(1495); SEMCAD X 14.6.12(7450); -Probe: EX3DV4 - SN3907; ConvF(7.32, 7.32, 7.32) @ 2412 MHz; Calibrated: 2018/05/15

-Sensor-Surface: 2mm (Mechanical Surface Detection), z = 1.0, 31.0

touch(10g),back,add 2/24b1;2412,back&d0,b(1m)/

Area:96x84,12 (8x9x1): Measurement grid: dx=12mm, dy=12mm; Maximum value of SAR (measured) = 0.103 W/kg

Area:96x84,12 (71x81x1): Interpolated grid: dx=1.200 mm, dy=1.200 mm; Maximum value of SAR (interpolated) = 0.109 W/kg

Zoom1:30x30x30,5 (7x7x7)/Cube 0: Measurement grid: dx=5mm, dy=5mm, dz=5mm;

Reference Value = 6.879 V/m; Power Drift = -0.10 dB; Maximum value of SAR (measured) = 0.108 W/kg; Peak SAR (extrapolated) = 0.143 W/kg

SAR(1 g) = 0.073 W/kg; SAR(10 g) = 0.035 W/kg

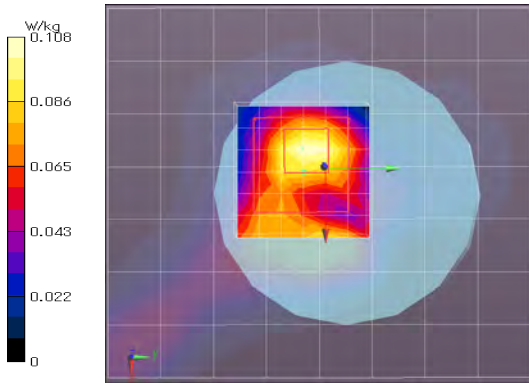

Remarks: * Date tested: 2019/03/05; Tested by: Hiroshi Naka; Tested place:No.7 shielded room,
* liquid depth: 151 mm; Position: distance of EUT to phantom: 0 mm (2 mm to liquid); ambient: (23~24) deg.C. / (40~55)%RH,
* liquid temperature: 22.0(start)/22.0(end)/22.0(in check) deg.C.; * White cubic: zoom scan area, Red cubic: big=SAR(10g)/small=SAR(1g)

Plot 1-3: Back&touch, 11b (1Mbps), 2437 MHz

EUT: RF Module (in Smart Outdoor Watch) ; Type: WSD-F21 (Platform:WSD-F21); Serial: 6 (Platform: 6)

Mode: 11b(1Mbps, DBPSK/DSSS) (UID: 0, Wi-fi_2.4GHz(0), Frame Length in ms: 0; PAR: 0; PMF: 1); Frequency: 2437 MHz; Crest Factor: 1.0

Medium: M2450(1903); Medium parameters used: f = 2437 MHz; $\sigma = 1.999$ S/m; $\epsilon_r = 50.75$; $\rho = 1000$ kg/m³

Measurement Standard: DASYS (IEEE/IEC/ANSI C63.19-2007)

DASY Configuration: -Electronics: DAE4 Sn626; Calibrated: 2018/10/15 ; -Phantom: ELI v4.0; Type: QDOVA001BA; Serial: 1059; Phantom section: Flat Section

-DASY52 52.10.2(1495); SEMCAD X 14.6.12(7450); -Probe: EX3DV4 - SN3907; ConvF(7.32, 7.32, 7.32) @ 2437 MHz; Calibrated: 2018/05/15

-Sensor-Surface: 2mm (Mechanical Surface Detection (Locations From Previous Scan Used)), Sensor-Surface: 2mm (Mechanical Surface Detection), z = 1.0, 31.0

touch(10g),back,add 2/24b2;2437,back&d0,b(1m)/

Area:96x84,12 (8x9x1): Measurement grid: dx=12mm, dy=12mm; Maximum value of SAR (measured) = 0.0928 W/kg

Area:96x84,12 (71x81x1): Interpolated grid: dx=1.200 mm, dy=1.200 mm; Maximum value of SAR (interpolated) = 0.0959 W/kg

Zoom1:30x30x30,5 (7x7x7)/Cube 0: Measurement grid: dx=5mm, dy=5mm, dz=5mm;

Reference Value = 6.396 V/m; Power Drift = 0.20 dB; Maximum value of SAR (measured) = 0.109 W/kg; Peak SAR (extrapolated) = 0.154 W/kg

SAR(1 g) = 0.074 W/kg; SAR(10 g) = 0.035 W/kg

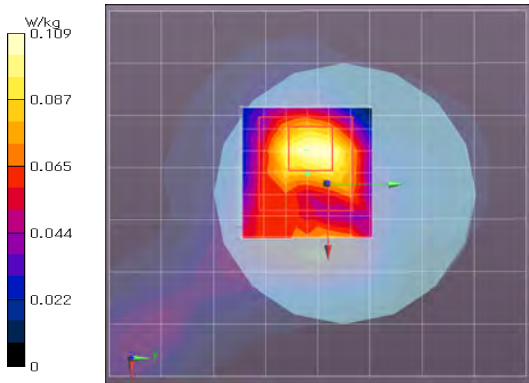

Remarks: * Date tested: 2019/03/05; Tested by: Hiroshi Naka; Tested place:No.7 shielded room,
* liquid depth: 151 mm; Position: distance of EUT to phantom: 0 mm (2 mm to liquid); ambient: (23~24) deg.C. / (40~55)%RH,
* liquid temperature: 22.0(start)/22.0(end)/22.0(in check) deg.C.; * White cubic: zoom scan area, Red cubic: big=SAR(10g)/small=SAR(1g)

Appendix 2-2: SAR measurement data (cont'd)**Plot 2-2: Front & 10 mm gap , 11b (1Mbps), 2412 MHz****EUT: RF Module (in Smart Outdoor Watch) ; Type: WSD-F21 (Platform:WSD-F21); Serial: 6 (Platform: 6)****Mode: 11b(1Mbps, DBPSK/DSSS)** (UID: 0, Wi-fi_2.4GHz(0), Frame Length in ms: 0, PAR: 0, PMF: 1); **Frequency: 2412 MHz; Crest Factor: 1.0****Medium: HSL2450(1903); Medium parameters used: f = 2412 MHz; $\sigma = 1.826$ S/m; $\epsilon_r = 38.25$; $\rho = 1000$ kg/m³**

Measurement Standard: DASYS (IEEE/IEC/ANSI C63.19-2007)

DASY Configuration: -Electronics: DAE4 Sn626; Calibrated: 2018/10/15 ; -Phantom: ELI v4.0; Type: QDOVA001BA; Serial: 1059; Phantom section: Flat Section

-DASY52.52.10.2(1495); SEMCAD X 14.6.12(7450); -Probe: EX3DV4 - SN3907; ConvF(7.31, 7.31, 7.31) @ 2412 MHz; Calibrated: 2018/05/15

-Sensor-Surface: 2mm (Mechanical Surface Detection (Locations From Previous Scan Used)), Sensor-Surface: 2mm (Mechanical Surface Detection), z = 1.0, 31.0, 161.0

touch.front/24h8(fcc);2412.front&gap10,b(1m)/**Area:84x84,12 (8x8x1):** Measurement grid: dx=12mm, dy=12mm; Maximum value of SAR (measured) = 0.0748 W/kg**Area:84x84,12 (71x71x1):** Interpolated grid: dx=1.200 mm, dy=1.200 mm; Maximum value of SAR (interpolated) = 0.0861 W/kg**Z:160,5 (1x1x33):** Measurement grid: dx=20mm, dy=20mm, dz=5mm; Maximum value of SAR (measured) = 0.0850 W/kg**Zoom:30x30x30,5 (7x7x7)/Cube 0:** Measurement grid: dx=5mm, dy=5mm, dz=5mm;

Reference Value = 6.820 V/m; Power Drift = 0.08 dB; Maximum value of SAR (measured) = 0.0812 W/kg; Peak SAR (extrapolated) = 0.103 W/kg

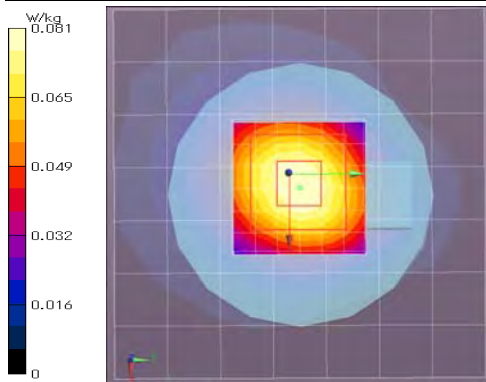
SAR(1 g) = 0.060 W/kg; SAR(10 g) = 0.033 W/kg

Remarks: * Date tested: 2019/03/04; Tested by: Hiroshi Naka; Tested place:No.7 shielded room,

* liquid depth: 150 mm; Position: distance of EUT to phantom: 0 mm (2 mm to liquid); ambient: (24~25) deg.C. / (40~55)%RH,

* liquid temperature: 24.0(start)/24.0(end)/23.9(in check) deg.C.; * White cubic: zoom scan area, Red cubic: big=SAR(10g)small=SAR(1g)

Plot 2-3: Front & 10 mm gap , 11b (1Mbps), 2462 MHz**EUT: RF Module (in Smart Outdoor Watch) ; Type: WSD-F21 (Platform:WSD-F21); Serial: 6 (Platform: 6)****Mode: 11b(1Mbps, DBPSK/DSSS)** (UID: 0, Wi-fi_2.4GHz(0), Frame Length in ms: 0, PAR: 0, PMF: 1); **Frequency: 2462 MHz; Crest Factor: 1.0****Medium: HSL2450(1903); Medium parameters used: f = 2462 MHz; $\sigma = 1.884$ S/m; $\epsilon_r = 38.05$; $\rho = 1000$ kg/m³**

Measurement Standard: DASYS (IEEE/IEC/ANSI C63.19-2007)

DASY Configuration: -Electronics: DAE4 Sn626; Calibrated: 2018/10/15 ; -Phantom: ELI v4.0; Type: QDOVA001BA; Serial: 1059; Phantom section: Flat Section

-DASY52.52.10.2(1495); SEMCAD X 14.6.12(7450); -Probe: EX3DV4 - SN3907; ConvF(7.31, 7.31, 7.31) @ 2462 MHz; Calibrated: 2018/05/15

-Sensor-Surface: 2mm (Mechanical Surface Detection (Locations From Previous Scan Used)), Sensor-Surface: 2mm (Mechanical Surface Detection), z = 1.0, 31.0

touch.front/24h10(fcc);2462.front&gap10,b(1m)/**Area:84x84,12 (8x8x1):** Measurement grid: dx=12mm, dy=12mm; Maximum value of SAR (measured) = 0.0611 W/kg**Area:84x84,12 (71x71x1):** Interpolated grid: dx=1.200 mm, dy=1.200 mm; Maximum value of SAR (interpolated) = 0.0687 W/kg**Zoom:30x30x30,5 (7x7x7)/Cube 0:** Measurement grid: dx=5mm, dy=5mm, dz=5mm;

Reference Value = 6.083 V/m; Power Drift = 0.02 dB; Maximum value of SAR (measured) = 0.0669 W/kg; Peak SAR (extrapolated) = 0.0850 W/kg

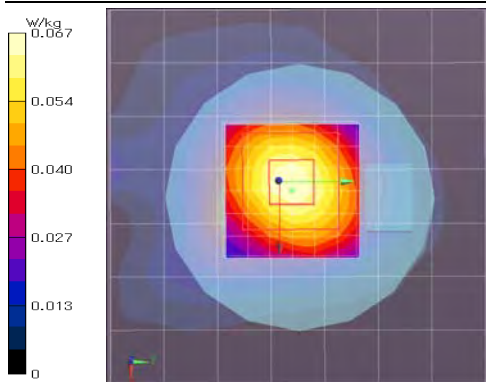
SAR(1 g) = 0.048 W/kg; SAR(10 g) = 0.026 W/kg

Remarks: * Date tested: 2019/03/04; Tested by: Hiroshi Naka; Tested place:No.7 shielded room,

* liquid depth: 150 mm; Position: distance of EUT to phantom: 0 mm (2 mm to liquid); ambient: (24~25) deg.C. / (40~55)%RH,

* liquid temperature: 23.9(start)/23.9(end)/23.9(in check) deg.C.; * White cubic: zoom scan area, Red cubic: big=SAR(10g)small=SAR(1g)

UL Japan, Inc.**Shonan EMC Lab.**

1-22-3 Megumigaoka, Hiratsuka-shi, Kanagawa-ken, 259-1220 JAPAN

Telephone: +81 463 50 6400 / Facsimile: +81 463 50 6401

Report Cover Page - 13-EM-F0429 Issue # 14.0

APPENDIX 3: Test instruments**Appendix 3-1: Equipment used**

Local ID	Test Name	LIMS ID	Description	Manufacturer	Model	Serial	Last Calibration Date	Calibration Due Date	Calibration Interval (Month)
KAT10-S3	AT	144893	Attenuator	AGILENT	8490D 010	50924	2018/12/12	2019/12/31	12
KPM-08	AT	145105	Power meter	ANRITSU	ML2495A	6K00003356	2018/9/28	2019/9/30	12
KPSS-04	AT	144991	Power sensor	ANRITSU	MA2411B	12088	2018/9/28	2019/9/30	12
SDPS-04	AT	145346	Power Supply(DC)	TEXIO	PW8-5ADPS	14086035	-	-	-
SSA-02	AT	145800	Spectrum Analyzer	AGILENT	E4448A	MY48250106	2018/3/5	2019/3/31	12
COTS-SSAR-02	SAR	144885	DASY52 software	Schmid&Parmer Engineering AG	DASY5 PRO	Ver.52.10.2.1495	-	-	-
COTS-SSEP-02	SAR	144886	Dielectric assessment software	Schmid&Parmer Engineering AG	DAK	Ver.DAK1.10.317.11	-	-	-
KAT10-P1	SAR	144882	Attenuator	Weinschel - APF Technologies Corp	24-10-34	BY5937	2018/12/12	2019/12/31	12
KCPL-07	SAR	146100	Directional Coupler	Pulsar Microwave Corp.	CCS30-B26	621	-	-	-
KDAE-01	SAR	144944	Data Acquisition Electronics	Schmid&Parmer Engineering AG	DAE4	626	2018/10/15	2019/10/31	12
KIU-08	SAR	145059	Power sensor	Rohde & Schwarz	NRV-Z4	100372	2018/9/28	2019/9/30	12
KIU-09	SAR	145099	Power sensor	Rohde & Schwarz	NRV-Z4	100371	2018/9/28	2019/9/30	12
KOS-13	SAR	144985	Digital thermometer	HANNA	Checktemp-2	KOS-13	2018/12/5	2019/12/31	12
KOS-14	SAR	144986	Thermo-Hygrometer data logger	SATO KEIRYOKI	SK-L200TH10/SK-LTH10-2	015246/08169	2018/12/5	2019/12/31	12
KPA-12	SAR	145359	RF Power Amplifier	Milmega	AS2560-50	1018582	-	-	-
KPFL-01	SAR	145560	Flat Phantom	Schmid&Parmer Engineering AG	Oval flat phantom ELI 4.0	1059	2018/8/27	2019/8/31	12
KPM-05	SAR	144988	Power meter	AGILENT	E4417A	GB41290718	2018/4/12	2019/4/30	12
KPM-06	SAR	144989	Power Meter	Rohde & Schwarz	NRVD	101599	2018/9/28	2019/9/30	12
KPSS-01	SAR	144990	Power sensor	AGILENT	E9327A	US40440544	2018/4/12	2019/4/30	12
KRU-01	SAR	144993	Ruler(300mm)	SHNWA	13134	-	2019/2/18	2020/2/29	12
KRU-05	SAR	145087	Ruler(100x50mm,L)	SHNWA	12101	-	2018/5/23	2019/5/31	12
KRU-06	SAR	145088	Ruler(500x250mm,L)	SHNWA	10640	-	2018/5/23	2019/5/31	12
KSDA-01	SAR	145090	Dipole Antenna	Schmid&Parmer Engineering AG	D2450V2	822	2019/1/18	2020/1/31	12
KSDH-01	SAR	145596	Device holder	Schmid&Parmer Engineering AG	Mounting device for transmitter	-	2018/9/27	2019/9/30	12
KSG-08	SAR	145109	Signal Generator	Rohde & Schwarz	SMTO6	100763	2018/9/27	2019/9/30	12
KSLH245-01	SAR	145363	Tissue simulation liquid (2450MHz,head)	Schmid&Parmer Engineering AG	HSL2450V2	SL AAH 245 BA	-	-	-
KSLM245-01	SAR	145365	Tissue simulation liquid (2450MHz,body)	Schmid&Parmer Engineering AG	MSL2450V2	SL AAM 245 BA	-	-	-
SALC-01	SAR	146112	Primepure Ethanol	Kanto Chemical Co., Inc.	14032-79	-	-	-	-
SAT20-SAR1	SAR	145149	Attenuator	TME	SFA-01AXPJ-20	-	2018/12/12	2019/12/31	12
SCC-SAR2	SAR	145405	Coaxial Cable	Huber-Suhner	SF104A/11PC3542/11N451/4M	MY699/4A	-	-	-
SEPP-02	SAR	145500	Dielectric probe	Schmid&Parmer Engineering AG	DAK3.5	1129	2018/8/17	2019/8/31	12
SOS-11	SAR	146296	Humidity Indicator	A&D	AD-5681	4063424	2019/1/11	2020/1/31	12
SOS-12	SAR	146320	Digital thermometer	HANNA	Checktemp-4	SOS-12	2019/1/11	2020/1/31	12
SOS-SAR1	SAR	146323	Digital thermometer	LKMelectronic	DTM3000	3171	2018/10/25	2019/10/31	12
SPB-02	SAR	146235	Dosimetric E-Field Probe	Schmid&Parmer Engineering AG	EX3DV4	3907	2018/5/15	2019/5/31	12
SSA-04	SAR	146176	Spectrum Analyzer	ADVANTEST	R3272	101100994	-	-	-
SSAR-02	SAR	146177	SAR measurement system	Schmid&Parmer Engineering AG	DASY5	1324	-	-	-
SSNA-01	SAR	146258	Network Analyzer	AGILENT	8753ES	US39171777	2018/12/17	2019/12/31	12
SSRBT-02	SAR	145621	SAR robot	Schmid&Parmer Engineering AG	TX60 Lspeag	F12/5L2QA1/A/01	2018/9/27	2019/9/30	12
SWTR-03	SAR	146185	DI water	MonotaRo	34557433	-	-	-	-

*. AT (antenna terminal conducted power measurement) was measured February 26, 2019. (Refer to Section 6 in this report.)

The expiration date of calibration is the end of the expired month.

As for some calibrations performed after the tested dates, those test equipment have been controlled by means of an unbroken chains of calibrations. All equipment is calibrated with valid calibrations. Each measurement data is traceable to the national or international standards.

[Test Item] SAR: Specific Absorption Rate, AT.pwr: Antenna terminal conducted power

Appendix 3-2: Configuration and peripherals

These measurements were performed with the automated near-field scanning system DASY5 from Schmid & Partner Engineering AG (SPEAG). The system is based on a high precision robot, which positions the probes with a positional repeatability of better than ± 0.02 mm. Special E- and H-field probes have been developed for measurements close to material discontinuity, the sensors of which are directly loaded with a Schottky diode and connected via highly resistive lines to the data acquisition unit. The SAR measurements were conducted with the dosimetry probes EX3DV4 (manufactured by SPEAG), designed in the classical triangular configuration and optimized for dosimetric evaluation.

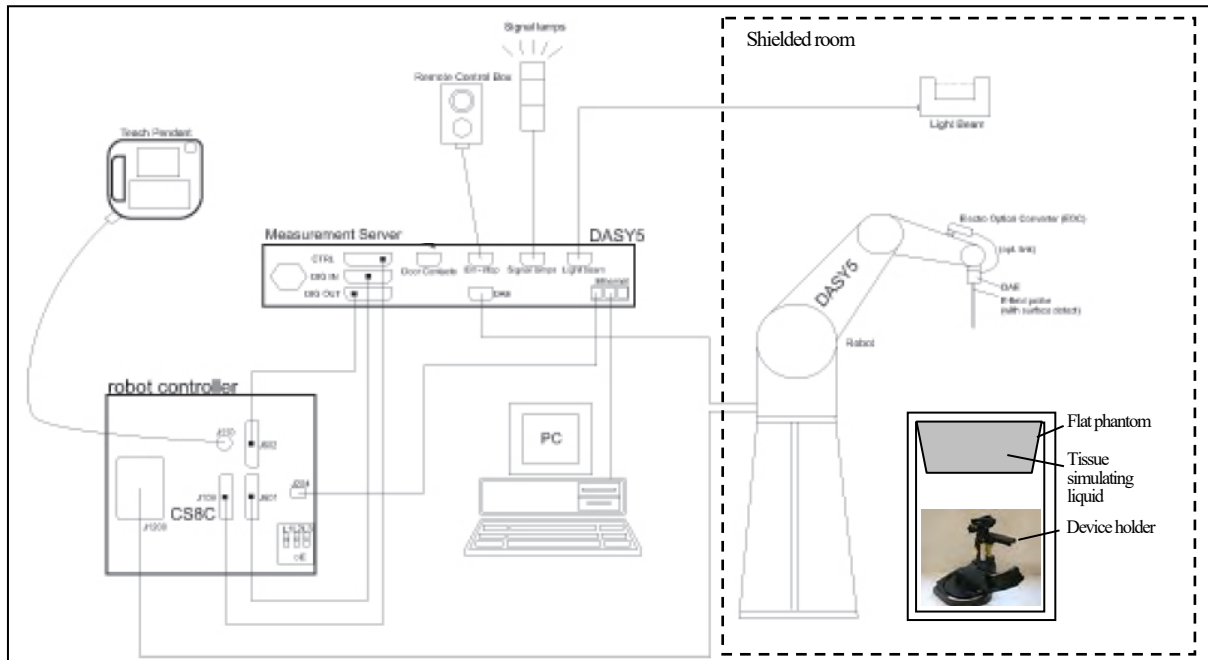

The DASY5 system for performing compliance tests consist of the following items:

1	A standard high precision 6-axis robot (Stäubli TX/RX family) with controller, teach pendant and software. An arm extension for accommodating the data acquisition electronics (DAE).
2	An isotropic field probe optimized and calibrated for the targeted measurement.
3	A data acquisition electronics (DAE) which performs the signal amplification, signal multiplexing, AD-conversion, offset measurements, mechanical surface detection, collision detection, etc. The unit is battery powered with standard or rechargeable batteries. The signal is optically transmitted to the EOC.
4	The Electro-optical converter (EOC) performs the conversion from optical to electrical signals for the digital communication to the DAE. To use optical surface detection, a special version of the EOC is required. The EOC signal is transmitted to the measurement server.
5	The function of the measurement server is to perform the time critical tasks such as signal filtering, control of the robot operation and fast movement interrupts.
6	The Light Beam used is for probe alignment. This improves the (absolute) accuracy of the probe positioning.
7	A computer running Win7 professional operating system and the DASY5 software.
8	R Remote control and teach pendant as well as additional circuitry for robot safety such as warning lamps, etc.
9	The phantom.
10	The device holder for EUT. (low-loss dielectric palette) (*. when it was used.)
11	Tissue simulating liquid mixed according to the given recipes.
12	Validation dipole kits allowing to validate the proper functioning of the system.

Appendix 3-3: Test system specification**TX60 Lsepag robot/CS8Csepag-TX60 robot controller**

- Number of Axes : 6
- Repeatability : ± 0.02 mm
- Manufacture : Stäubli Unimation Corp.

DASY5 Measurement server

- Features : The DASY5 measurement server is based on a PC/104 CPU board with a 400MHz intel ULV Celeron, 128MB chip-disk and 128MB RAM. The necessary circuits for communication with the DAE4 electronics box, as well as the 16 bit AD converter system for optical detection and digital I/O interface are contained on the DASY5 I/O board, which is directly connected to the PC/104 bus of the CPU board.
- Calibration : No calibration required.
- Manufacture : Schmid & Partner Engineering AG

Data Acquisition Electronic (DAE)

- Features : Signal amplifier, multiplexer, A/D converter and control logic. Serial optical link for communication with DASY5 embedded system (fully remote controlled). 2 step probe touch detector for mechanical surface detection and emergency robot stop (not in -R version)
- Measurement Range : 1 μ V to > 200 mV (16bit resolution and 2 range settings: 4 mV, 400 mV)
- Input Offset voltage : < 1 μ V (with auto zero)
- Input Resistance : 200 M Ω
- Battery Power : > 10 hrs. of operation (with two 9 V battery)
- Manufacture : Schmid & Partner Engineering AG

Electro-Optical Converter (EOC61)

- Manufacture : Schmid & Partner Engineering AG

Light Beam Switch (LB5/80)

- Manufacture : Schmid & Partner Engineering AG

SAR measurement software

- Item : Dosimetric Assessment System DASY5
- Software version : DASY52, V8.2 B969
- Manufacture : Schmid & Partner Engineering AG

E-Field Probe

- Model : EX3DV4 (serial number: 3907)
- Construction : Symmetrical design with triangular core. Built-in shielding against static charges. PEEK enclosure material (resistant to organic solvents, e.g., DGBE).
- Frequency : 10MHz to 6GHz, Linearity: ± 0.2 dB (30MHz to 6GHz)
- Conversion Factors : 2.45, 5.2, 5.25, 5.5, 5.6, 5.75, 5.8 GHz (Head)
2.45, 5.25, 5.6, 5.75 GHz (Body)
- Directivity : ± 0.3 dB in HSL (rotation around probe axis)
 ± 0.5 dB in tissue material (rotation normal to probe axis)
- Dynamic Range : 10 μ W/g to > 100 mW/g; Linearity: ± 0.2 dB (noise: typically < 1 μ W/g)
- Dimension : Overall length: 330 mm (Tip: 20 mm)
Tip diameter: 2.5 mm (Body: 12 mm)
Typical distance from probe tip to dipole centers: 1mm
- Application : High precision dosimetric measurement in any exposure scenario (e.g., very strong gradient fields). Only probe which enables compliance testing for frequencies up to 6GHz with precision of better 30%.
- Manufacture : Schmid & Partner Engineering AG

Phantom

- Type : **ELI 4.0 oval flat phantom**
- Shell Material : Fiberglass
- Shell Thickness : Bottom plate: 2 ± 0.2 mm
- Dimensions : Bottom elliptical: 600 \times 400 mm, Depth: 190 mm (Volume: Approx. 30 liters)
- Manufacture : Schmid & Partner Engineering AG

Device Holder

- Urethane foam
- KSDH-01: In combination with the ELI4, the Mounting Device enables the rotation of the mounted transmitter device in spherical coordinates. Transmitter devices can be easily and accurately positioned. The low-loss dielectric urethane foam was used for the mounting section of device holder.
- Material : POM
- Manufacture : Schmid & Partner Engineering AG

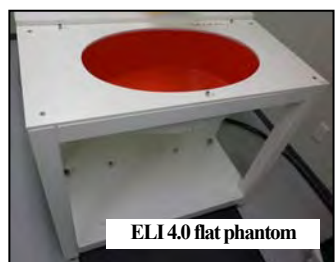
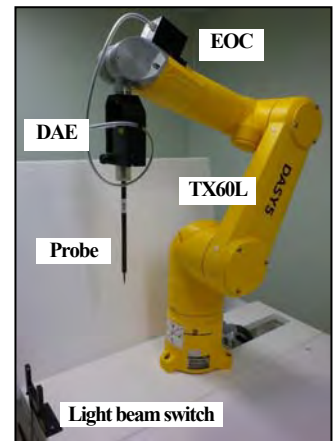

Appendix 3-4: Simulated tissue composition and parameter confirmation

Liquid type	Body	Head
Model No. / Product No.	MSL2450V2 / SL AAM 245 BA	HSL2450V2 / SL AAH 245 BA
Control number	KSLM245-01	KSLH245-01
Ingredient: Mixture (%)	Water:52-75%, DGBE:25-48%, NaCl:<1.0%	Water: 52-75%, DGBE: 25-48%, NaCl: <1.0%
Manufacture	Schmid & Partner Engineering AG	Schmid & Partner Engineering AG

*. The dielectric parameters were checked prior to assessment using the DAK3.5 dielectric probe kit.

Measured date	Freq. [MHz]	Liquid type	Ambient [deg.C.] / [%RH]	Liquid temp. [deg.C.]	Liquid Depth [mm]	Liquid parameters (*a)							ASAR			
						Permittivity (εr) [-]				Conductivity [S/m]			Limit	Target	Limit	Target
						Target	Measured		Limit	Target	Measured					
March 4, 2019	2450	Head	24/33	23.9	(150)	39.2	38.11	-2.8	±5%	1.80	1.871	+4.0	±5%	+2.52	+1.47	
March 5, 2019	2450	Body	23/35	22.0	(151)	52.7	50.69	-3.8	±5%	1.95	2.019	+3.5	±5%	+2.56	+1.52	

*a. The target value is a parameter defined in Appendix A of KDB865664 D01 (v01r04). The dielectric parameters suggested for head and body tissue simulating liquid are given at 2000, 2450 and 3000MHz. As an intermediate solution, dielectric parameters for the frequencies between 2000~2450MHz and 2450~3000MHz were obtained using linear interpolation.

f (MHz)	Standard				Interpolated				
	Head Tissue		Body Tissue		f (MHz)	Head Tissue		Body Tissue	
	εr	σ [S/m]	εr	σ [S/m]		εr	σ [S/m]	εr	σ [S/m]
(1800~)2000	40.0	1.40	53.3	1.52	2412	39.27	1.766	52.75	1.914
2450	39.2	1.80	52.7	1.95	2437	39.22	1.788	52.72	1.938
3000	38.5	2.40	52.0	2.73	2462	39.18	1.813	52.68	1.967

*b. The coefficients are parameters defined in IEEE Std. 1528(2013).

$$\Delta\text{SAR}(1g) = C_{\epsilon r} \times \Delta\epsilon r + C_{\sigma} \times \Delta\sigma, C_{\epsilon r} = -7.854E-4 \times f^3 + 9.402E-3 \times f^2 - 2.742E-2 \times f + 0.2026 / C_{\sigma} = 9.804E-3 \times f^3 - 8.661E-2 \times f^2 + 2.981E-2 \times f + 0.7829$$

$$\Delta\text{SAR}(10g) = C_{\epsilon r} \times \Delta\epsilon r + C_{\sigma} \times \Delta\sigma, C_{\epsilon r} = 3.456 \times 10^{-3} \times f^3 - 3.531 \times 10^{-2} \times f^2 + 7.675 \times 10^{-2} \times f - 0.1860 / C_{\sigma} = 4.479 \times 10^{-3} \times f^3 - 1.586 \times 10^{-2} \times f^2 - 0.1972 \times f + 0.7717$$

Appendix 3-5: Daily check results

Prior to the SAR assessment of EUT, the daily check (system check) was performed to test whether the SAR system was operating within its target of ±10%. The daily check results are in the table below. (*. Refer to Appendix 3-6 of measurement data.)

Daily check results																				
Date	Freq. [MHz]	Liquid Type	Daily check target & measured																	
			SAR (1g) [W/kg] (*d)								SAR (10g) [W/kg] (*d)									
			Meas. red (*c)	ASAR-correct	1W scaled	Target Cal. (*e)	STD (*f)	Deviation Cal. [%]	STD [%]	Limit [%]	Pass ?	Meas. red (*c)	ASAR-correct	1W scaled	Target Cal. (*e)	STD (*f)	Deviation Cal. [%]	STD [%]	Limit [%]	Pass ?
March 4, 2019	2450	Head	13.2	12.87	51.48	51.8	52.4	(-0.6)	-1.8	±10	Pass	6.09	6.00	24.00	24.3	24.0	(+0.2)	0	±10	Pass
March 5, 2019	2450	Body	12.9	12.57	50.28	50.7	n/a	-0.8	n/a	±10	Pass	6.01	5.92	23.68	23.7	n/a	-0.1	n/a	±10	Pass

*. Calculating formula: ΔSAR corrected SAR (1g,10g) (W/kg) = (Measured SAR(1g,10g) (W/kg)) × (100 - (ASAR(%)) / 100

*c. The "Measured" SAR value is obtained at 250 mW for 2450MHz.

*d. The measured SAR value of Daily check was compensated for tissue dielectric deviations (ASAR) and scaled to 1W of output power in order to compare with the manufacture's calibration target value which was normalized.

*e. The target value is a parameter defined in the calibration data sheet of D2450V2 (sn:822) dipole calibrated by Schmid & Partner Engineering AG (Certification No. D2450V2-822_Jan19, the data sheet was filed in this report).

*f. The target value (normalized to 1W) is defined in IEEE Std.1528.

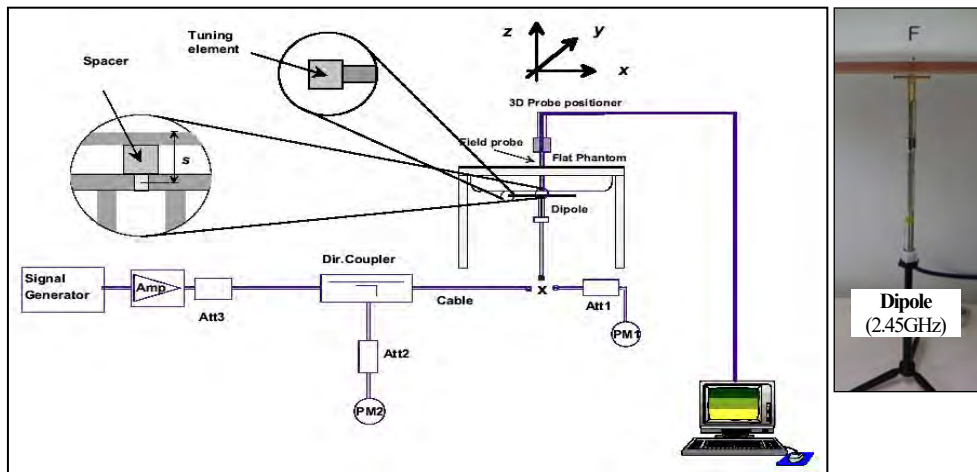

Test setup for the system performance check

Appendix 3-6: Daily check measurement data

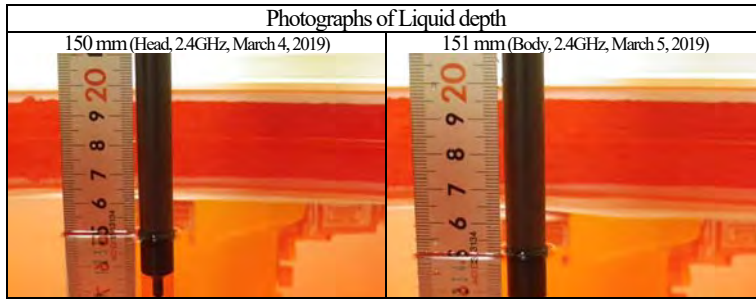

(Head liquid) EUT: Dipole(2.45GHz)(sn822); Type: D2450V2; Serial: 822; Forward conducted power: 250mW
Communication System: CW (* UID:0; Frame Length in ms: 0; PAR: 0; PMF: 1); **Frequency: 2450 MHz; Crest Factor: 1.0**
Medium: HSL2450(1902); Medium parameters used: f = 2450 MHz; $\sigma = 1.843$ S/m; $\epsilon_r = 38.27$; $\rho = 1000$ kg/m³

Measurement Standard: DASYS5 (IEEE/IEC/ANSI C63.19-2007)

DASY Configuration: -Electronics: DAE4 Sn626; Calibrated: 2018/10/15 ; -Phantom: ELI v4.0; Type: QDOVA001BA; Serial: 1059; Phantom section: Flat Section
 -DASY52.52.10.2(1495); SEMCAD X 14.6.12(7450); -Probe: EX3DV4 - SN3907; ConvF(7.31, 7.31, 7.31) @ 2450 MHz; Calibrated: 2018/05/15
 -Sensor-Surface: 2mm (Mechanical Surface Detection), z = 1.0, 31.0, 161.0

Area:60x60,15 (5x5x1): Measurement grid: dx=15mm, dy=15mm; Maximum value of SAR (measured) = 19.6 W/kg
Area:60x60,15 (41x41x1): Interpolated grid: dx=1.500 mm, dy=1.500 mm; Maximum value of SAR (interpolated) = 20.0 W/kg
Z;160,5 (1x1x33): Measurement grid: dx=20mm, dy=20mm, dz=5mm; Maximum value of SAR (measured) = 20.4 W/kg

Zoom:30x30x30,5 (7x7x7)/Cube 0: Measurement grid: dx=5mm, dy=5mm, dz=5mm;
 Reference Value = 104.9 V/m; Power Drift = 0.01 dB; Maximum value of SAR (measured) = 20.4 W/kg; Peak SAR (extrapolated) = 27.6 W/kg

SAR(1 g) = 13.2 W/kg; SAR(10 g) = 6.09 W/kg

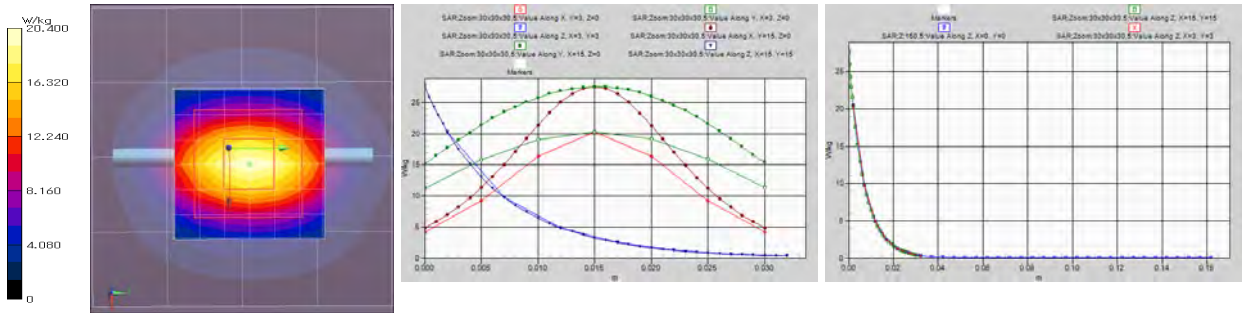

Remarks: * Date tested: 2019/03/04; Tested by: Hiroshi Naka; Tested place: No.7 shielded room,
 * liquid depth: 150 mm; Position: distance of dipole to phantom: 8mm (10mm to liquid); ambient: 25 deg.C. / 43 %RH,
 * liquid temperature: 23.8(start)23.7(end)23.9(in check) deg.C.; * White cubic: zoom scan area, Red cubic: big=SAR(10g)/small=SAR(1g)

(Body liquid) EUT: Dipole(2.45GHz)(sn822); Type: D2450V2; Serial: 822; Forward conducted power: 250mW
Communication System: CW (* UID:0; Frame Length in ms: 0; PAR: 0; PMF: 1); **Frequency: 2450 MHz; Crest Factor: 1.0**
Medium: M2450(1903); Medium parameters used: f = 2450 MHz; $\sigma = 2.019$ S/m; $\epsilon_r = 50.69$; $\rho = 1000$ kg/m³

Measurement Standard: DASYS5 (IEEE/IEC/ANSI C63.19-2007)

DASY Configuration: -Electronics: DAE4 Sn626; Calibrated: 2018/10/15 ; -Phantom: ELI v4.0; Type: QDOVA001BA; Serial: 1059; Phantom section: Flat Section
 -DASY52.52.10.2(1495); SEMCAD X 14.6.12(7450); -Probe: EX3DV4 - SN3907; ConvF(7.32, 7.32, 7.32) @ 2450 MHz; Calibrated: 2018/05/15
 -Sensor-Surface: 2mm (Mechanical Surface Detection), z = 1.0, 31.0, 161.0

Area:60x60,15 (5x5x1): Measurement grid: dx=15mm, dy=15mm; Maximum value of SAR (measured) = 18.9 W/kg
Area:60x60,15 (41x41x1): Interpolated grid: dx=1.500 mm, dy=1.500 mm; Maximum value of SAR (interpolated) = 19.1 W/kg
Z;160,5 (1x1x33): Measurement grid: dx=20mm, dy=20mm, dz=5mm; Maximum value of SAR (measured) = 19.7 W/kg

Zoom:30x30x30,5 (7x7x7)/Cube 0: Measurement grid: dx=5mm, dy=5mm, dz=5mm;
 Reference Value = 98.54 V/m; Power Drift = 0.03 dB; Maximum value of SAR (measured) = 19.6 W/kg; Peak SAR (extrapolated) = 26.2 W/kg

SAR(1 g) = 12.9 W/kg; SAR(10 g) = 6.01 W/kg

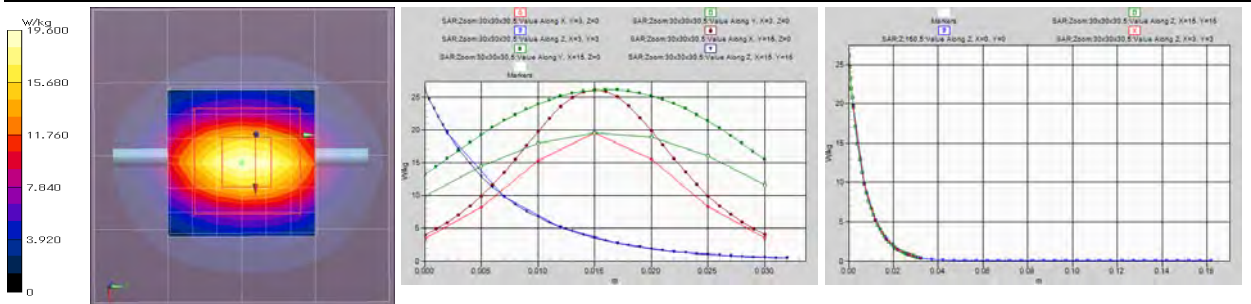

Remarks: * Date tested: 2019/03/05; Tested by: Hiroshi Naka; Tested place: No.7 shielded room,
 * liquid depth: 151 mm; Position: distance of dipole to phantom: 8mm (10mm to liquid); ambient: 23 deg.C. / 52 %RH,
 * liquid temperature: 22.0(start)22.0(end)22.0(in check) deg.C.; * White cubic: zoom scan area, Red cubic: big=SAR(10g)/small=SAR(1g)

Appendix 3-7: Daily check uncertainty

Although this standard determines only the limit value of uncertainty, there is no applicable rule of uncertainty in this. Therefore, the following results are derived depending on whether or not laboratory uncertainty is applied.

Uncertainty of daily check (2.4–6GHz) (*ε&σ tolerance: ≤±5%, DAK3.5, CW) (v08)							1g SAR	10g SAR	
Combined measurement uncertainty of the measurement system (k=1)							± 11.0 %	± 10.9 %	
Expanded uncertainty (k=2)							± 22.1 %	± 21.8 %	
	Error Description (v08)	Uncertainty Value	Probability distribution	Divisor	ci (1g)	ci (10g)	ui (1g)	ui (10g)	Vi, veff
A	Measurement System (DASY5)						(std. uncertainty)	(std. uncertainty)	
1	Probe Calibration Error	±6.55 %	Normal	1	1	1	±6.55 %	±6.55 %	∞
2	Axial isotropy error	±4.7 %	Rectangular	√3	√0.5	√0.5	±1.9 %	±1.9 %	∞
3	Hemispherical isotropy error	±9.6 %	Rectangular	√3	0	0	0 %	0 %	∞
4	Probe linearity	±4.7 %	Rectangular	√3	1	1	±2.7 %	±2.7 %	∞
5	Probe modulation response (CW)	±0.0 %	Rectangular	√3	1	1	0 %	0 %	∞
6	System detection limit	±1.0 %	Rectangular	√3	1	1	±0.6 %	±0.6 %	∞
7	Boundary effects	±4.8 %	Rectangular	√3	1	1	±2.8 %	±2.8 %	∞
8	System readout electronics (DAE)	±0.3 %	Normal	1	1	1	±0.3 %	±0.3 %	∞
9	Response Time Error (<5ms/100ms wait)	±0.0 %	Rectangular	√3	1	1	0 %	0 %	∞
10	Integration Time Error (CW)	±0.0 %	Rectangular	√3	1	1	0 %	0 %	∞
11	RF ambient conditions-noise	±3.0 %	Rectangular	√3	1	1	±1.7 %	±1.7 %	∞
12	RF ambient conditions-reflections	±3.0 %	Rectangular	√3	1	1	±1.7 %	±1.7 %	∞
13	Probe positioner mechanical tolerance	±3.3 %	Rectangular	√3	1	1	±1.9 %	±1.9 %	∞
14	Probe positioning with respect to phantom shell	±6.7 %	Rectangular	√3	1	1	±3.9 %	±3.9 %	∞
15	Max. SAR evaluation (Post-processing)	±4.0 %	Rectangular	√3	1	1	±2.3 %	±2.3 %	∞
B	Test Sample Related								
16	Deviation of the experimental source	±3.5 %	Normal	1	1	1	±3.5 %	±3.5 %	∞
17	Dipole to liquid distance (10mm±0.2mm, <2deg.)	±2.0 %	Rectangular	√3	1	1	±1.2 %	±1.2 %	∞
18	Drift of output power (measured, <0.2dB)	±2.3 %	Rectangular	√3	1	1	±1.3 %	±1.3 %	∞
C	Phantom and Setup								
19	Phantom uncertainty	±2.0 %	Rectangular	√3	1	1	±1.2 %	±1.2 %	∞
20	Algorithm for correcting SAR (ε',σ: ≤5%)	±1.2 %	Normal	1	1	0.84	±1.2 %	±0.97 %	∞
21	Liquid conductivity (meas.) (DAK3.5)	±3.0 %	Normal	1	0.78	0.71	±2.3 %	±2.1 %	∞
22	Liquid permittivity (meas.) (DAK3.5)	±3.1 %	Normal	1	0.23	0.26	±0.7 %	±0.8 %	∞
23	Liquid Conductivity-temp.uncertainty (≤2deg.C.)	±5.3 %	Rectangular	√3	0.78	0.71	±2.4 %	±2.2 %	∞
24	Liquid Permittivity-temp.uncertainty (≤2deg.C.)	±0.9 %	Rectangular	√3	0.23	0.26	±0.1 %	±0.1 %	∞
	Combined Standard Uncertainty						±11.0 %	±10.9 %	
	Expanded Uncertainty (k=2)						±22.1 %	±21.8 %	

*. This measurement uncertainty budget is suggested by IEEE Std. 1528(2013) and determined by Schmid & Partner Engineering AG (DASY5 Uncertainty Budget).

Appendix 3-8: Calibration certificate: E-Field Probe (EX3DV4)

**Calibration Laboratory of
Schmid & Partner
Engineering AG**
Zeughausstrasse 43, 8004 Zurich, Switzerland



S Schweizerischer Kalibrierdienst
C Service suisse d'étalonnage
S Servizio svizzero di taratura
Swiss Calibration Service

Accredited by the Swiss Accreditation Service (SAS)
The Swiss Accreditation Service is one of the signatories to the EA
Multilateral Agreement for the recognition of calibration certificates

Accreditation No.: **SCS 0108**

Client **UL Japan (Vitec)**

Certificate No: **EX3-3907_May18**

CALIBRATION CERTIFICATE

Object: **EX3DV4 - SN:3907**

Calibration procedure(s): **QA CAL-01.v9, QA CAL-14.v4, QA CAL-23.v5, QA CAL-25.v6
Calibration procedure for dosimetric E-field probes**

Calibration date: **May 15, 2018**

This calibration certificate documents the traceability to national standards, which realize the physical units of measurements (SI).
The measurements and the uncertainties with confidence probability are given on the following pages and are part of the certificate.

All calibrations have been conducted in the closed laboratory facility: environment temperature (22 ± 3)°C and humidity < 70%.

Calibration Equipment used (M&TE critical for calibration)

Primary Standards	ID	Cal Date (Certificate No.)	Scheduled Calibration
Power meter NRP	SN: 104778	04-Apr-18 (No. 217-02672/02673)	Apr-19
Power sensor NRP-Z91	SN: 103244	04-Apr-18 (No. 217-02672)	Apr-19
Power sensor NRP-Z91	SN: 103245	04-Apr-18 (No. 217-02673)	Apr-19
Reference 20 dB Attenuator	SN: S5277 (20x)	04-Apr-18 (No. 217-02682)	Apr-19
Reference Probe ES3DV2	SN: 3013	30-Dec-17 (No. ES3-3013_Dec17)	Dec-18
DAE4	SN: 660	21-Dec-17 (No. DAE4-660_Dec17)	Dec-18
Secondary Standards	ID	Check Date (in house)	Scheduled Check
Power meter E4419B	SN: GB41293874	06-Apr-16 (in house check Jun-16)	In house check: Jun-18
Power sensor E4412A	SN: MY41498087	06-Apr-16 (in house check Jun-16)	In house check: Jun-18
Power sensor E4412A	SN: 000110210	06-Apr-16 (in house check Jun-16)	In house check: Jun-18
RF generator HP 8648C	SN: US3642U01700	04-Aug-99 (in house check Jun-16)	In house check: Jun-18
Network Analyzer HP 8753E	SN: US37390585	18-Oct-01 (in house check Oct-17)	In house check: Oct-18

Calibrated by: **Claudio Leubler** (Name), **Laboratory Technician** (Function), *[Signature]* (Signature)

Approved by: **Katja Pokovic** (Name), **Technical Manager** (Function), *[Signature]* (Signature)

Issued: May 15, 2018

This calibration certificate shall not be reproduced except in full without written approval of the laboratory.

Appendix 3-8: Calibration certificate: E-Field Probe (EX3DV4) (cont'd)

**Calibration Laboratory of
Schmid & Partner
Engineering AG**
Zeughausstrasse 43, 8004 Zurich, Switzerland



S Schweizerischer Kalibrierdienst
C Service suisse d'étalonnage
S Servizio svizzero di taratura
S Swiss Calibration Service

Accredited by the Swiss Accreditation Service (SAS)

Accreditation No.: **SCS 0108**

The Swiss Accreditation Service is one of the signatories to the EA
Multilateral Agreement for the recognition of calibration certificates

Glossary:

TSL	tissue simulating liquid
NORM _{x,y,z}	sensitivity in free space
ConvF	sensitivity in TSL / NORM _{x,y,z}
DCP	diode compression point
CF	crest factor (1/duty_cycle) of the RF signal
A, B, C, D	modulation dependent linearization parameters
Polarization φ	φ rotation around probe axis
Polarization ϑ	ϑ rotation around an axis that is in the plane normal to probe axis (at measurement center), i.e., $\vartheta = 0$ is normal to probe axis
Connector Angle	information used in DASY system to align probe sensor X to the robot coordinate system

Calibration is Performed According to the Following Standards:

- IEEE Std 1528-2013, "IEEE Recommended Practice for Determining the Peak Spatial-Averaged Specific Absorption Rate (SAR) in the Human Head from Wireless Communications Devices: Measurement Techniques", June 2013
- IEC 62209-1, "Measurement procedure for the assessment of Specific Absorption Rate (SAR) from hand-held and body-mounted devices used next to the ear (frequency range of 300 MHz to 6 GHz)", July 2016
- IEC 62209-2, "Procedure to determine the Specific Absorption Rate (SAR) for wireless communication devices used in close proximity to the human body (frequency range of 30 MHz to 6 GHz)", March 2010
- KDB 865664, "SAR Measurement Requirements for 100 MHz to 6 GHz"

Methods Applied and Interpretation of Parameters:

- NORM_{x,y,z}:** Assessed for E-field polarization $\vartheta = 0$ ($f \leq 900$ MHz in TEM-cell; $f > 1800$ MHz: R22 waveguide). NORM_{x,y,z} are only intermediate values, i.e., the uncertainties of NORM_{x,y,z} does not affect the E²-field uncertainty inside TSL (see below ConvF).
- NORM(f)_{x,y,z} = NORM_{x,y,z} * frequency_response** (see Frequency Response Chart). This linearization is implemented in DASY4 software versions later than 4.2. The uncertainty of the frequency response is included in the stated uncertainty of ConvF.
- DCP_{x,y,z}:** DCP are numerical linearization parameters assessed based on the data of power sweep with CW signal (no uncertainty required). DCP does not depend on frequency nor media.
- PAR:** PAR is the Peak to Average Ratio that is not calibrated but determined based on the signal characteristics
- A_{x,y,z}; B_{x,y,z}; C_{x,y,z}; D_{x,y,z}; VR_{x,y,z}; A, B, C, D** are numerical linearization parameters assessed based on the data of power sweep for specific modulation signal. The parameters do not depend on frequency nor media. VR is the maximum calibration range expressed in RMS voltage across the diode.
- ConvF and Boundary Effect Parameters:** Assessed in flat phantom using E-field (or Temperature Transfer Standard for $f \leq 800$ MHz) and inside waveguide using analytical field distributions based on power measurements for $f > 800$ MHz. The same setups are used for assessment of the parameters applied for boundary compensation (alpha, depth) of which typical uncertainty values are given. These parameters are used in DASY4 software to improve probe accuracy close to the boundary. The sensitivity in TSL corresponds to NORM_{x,y,z} * ConvF whereby the uncertainty corresponds to that given for ConvF. A frequency dependent ConvF is used in DASY version 4.4 and higher which allows extending the validity from ± 50 MHz to ± 100 MHz.
- Spherical isotropy (3D deviation from isotropy):** in a field of low gradients realized using a flat phantom exposed by a patch antenna.
- Sensor Offset:** The sensor offset corresponds to the offset of virtual measurement center from the probe tip (on probe axis). No tolerance required.
- Connector Angle:** The angle is assessed using the information gained by determining the NORM_x (no uncertainty required).

Appendix 3-8: Calibration certificate: E-Field Probe (EX3DV4) (cont'd)

EX3DV4 – SN:3907

May 15, 2018

Probe EX3DV4

SN:3907

Manufactured: September 4, 2012

Calibrated: May 15, 2018

Calibrated for DASY/EASY Systems

(Note: non-compatible with DASY2 system!)

Appendix 3-8: Calibration certificate: E-Field Probe (EX3DV4) (cont'd)

EX3DV4- SN:3907

May 15, 2018

DASY/EASY - Parameters of Probe: EX3DV4 - SN:3907**Basic Calibration Parameters**

	Sensor X	Sensor Y	Sensor Z	Unc (k=2)
Norm ($\mu\text{V}/(\text{V/m})^2$) ^A	0.45	0.58	0.54	± 10.1 %
DCP (mV) ^B	104.8	98.0	99.2	

Modulation Calibration Parameters

UID	Communication System Name		A dB	B dB $\sqrt{\mu\text{V}}$	C	D dB	VR mV	Unc ^E (k=2)
0	CW	X	0.0	0.0	1.0	0.00	132.5	±3.8 %
		Y	0.0	0.0	1.0		131.4	
		Z	0.0	0.0	1.0		144.8	

The reported uncertainty of measurement is stated as the standard uncertainty of measurement multiplied by the coverage factor k=2, which for a normal distribution corresponds to a coverage probability of approximately 95%.

^A The uncertainties of Norm X,Y,Z do not affect the E²-field uncertainty inside TSL (see Pages 5 and 6).

^B Numerical linearization parameter: uncertainty not required.

^E Uncertainty is determined using the max. deviation from linear response applying rectangular distribution and is expressed for the square of the field value.

Appendix 3-8: Calibration certificate: E-Field Probe (EX3DV4) (cont'd)

EX3DV4- SN:3907

May 15, 2018

DASY/EASY - Parameters of Probe: EX3DV4 - SN:3907**Calibration Parameter Determined in Head Tissue Simulating Media**

f (MHz) ^C	Relative Permittivity ^F	Conductivity (S/m) ^F	ConvF X	ConvF Y	ConvF Z	Alpha ^G	Depth (mm) ^G	Unc (k=2)
2450	39.2	1.80	7.31	7.31	7.31	0.36	0.80	± 12.0 %
5200	36.0	4.66	5.31	5.31	5.31	0.35	1.80	± 13.1 %
5250	35.9	4.71	5.16	5.16	5.16	0.35	1.80	± 13.1 %
5500	35.6	4.96	4.73	4.73	4.73	0.40	1.80	± 13.1 %
5600	35.5	5.07	4.49	4.49	4.49	0.40	1.80	± 13.1 %
5750	35.4	5.22	4.70	4.70	4.70	0.40	1.80	± 13.1 %
5800	35.3	5.27	4.69	4.69	4.69	0.40	1.80	± 13.1 %

^C Frequency validity above 300 MHz of ± 100 MHz only applies for DASY v4.4 and higher (see Page 2), else it is restricted to ± 50 MHz. The uncertainty is the RSS of the ConvF uncertainty at calibration frequency and the uncertainty for the indicated frequency band. Frequency validity below 300 MHz is ± 10, 25, 40, 50 and 70 MHz for ConvF assessments at 30, 64, 128, 150 and 220 MHz respectively. Above 5 GHz frequency validity can be extended to ± 110 MHz.

^F At frequencies below 3 GHz, the validity of tissue parameters (ϵ and σ) can be relaxed to ± 10% if liquid compensation formula is applied to measured SAR values. At frequencies above 3 GHz, the validity of tissue parameters (ϵ and σ) is restricted to ± 5%. The uncertainty is the RSS of the ConvF uncertainty for indicated target tissue parameters.

^G Alpha/Depth are determined during calibration. SPEAG warrants that the remaining deviation due to the boundary effect after compensation is always less than ± 1% for frequencies below 3 GHz and below ± 2% for frequencies between 3-6 GHz at any distance larger than half the probe tip diameter from the boundary.

Appendix 3-8: Calibration certificate: E-Field Probe (EX3DV4) (cont'd)

EX3DV4- SN:3907

May 15, 2018

DASY/EASY - Parameters of Probe: EX3DV4 - SN:3907**Calibration Parameter Determined in Body Tissue Simulating Media**

f (MHz) ^c	Relative Permittivity ^F	Conductivity (S/m) ^F	ConvF X	ConvF Y	ConvF Z	Alpha ^G	Depth ^G (mm)	Unc (k=2)
2450	52.7	1.95	7.32	7.32	7.32	0.34	0.84	± 12.0 %
5250	48.9	5.36	4.49	4.49	4.49	0.45	1.90	± 13.1 %
5600	48.5	5.77	3.92	3.92	3.92	0.40	1.90	± 13.1 %
5750	48.3	5.94	4.00	4.00	4.00	0.45	1.90	± 13.1 %

^c Frequency validity above 300 MHz of ± 100 MHz only applies for DASY v4.4 and higher (see Page 2), else it is restricted to ± 50 MHz. The uncertainty is the RSS of the ConvF uncertainty at calibration frequency and the uncertainty for the indicated frequency band. Frequency validity below 300 MHz is ± 10, 25, 40, 50 and 70 MHz for ConvF assessments at 30, 64, 128, 150 and 220 MHz respectively. Above 5 GHz frequency validity can be extended to ± 110 MHz.

^F At frequencies below 3 GHz, the validity of tissue parameters (ϵ and σ) can be relaxed to ± 10% if liquid compensation formula is applied to measured SAR values. At frequencies above 3 GHz, the validity of tissue parameters (ϵ and σ) is restricted to ± 5%. The uncertainty is the RSS of the ConvF uncertainty for indicated target tissue parameters.

^G Alpha/Depth are determined during calibration. SPEAG warrants that the remaining deviation due to the boundary effect after compensation is always less than ± 1% for frequencies below 3 GHz and below ± 2% for frequencies between 3-6 GHz at any distance larger than half the probe tip diameter from the boundary.

Appendix 3-8: Calibration certificate: E-Field Probe (EX3DV4) (cont'd)

EX3DV4- SN:3907

May 15, 2018

Frequency Response of E-Field
(TEM-Cell: ifi110 EXX, Waveguide: R22)

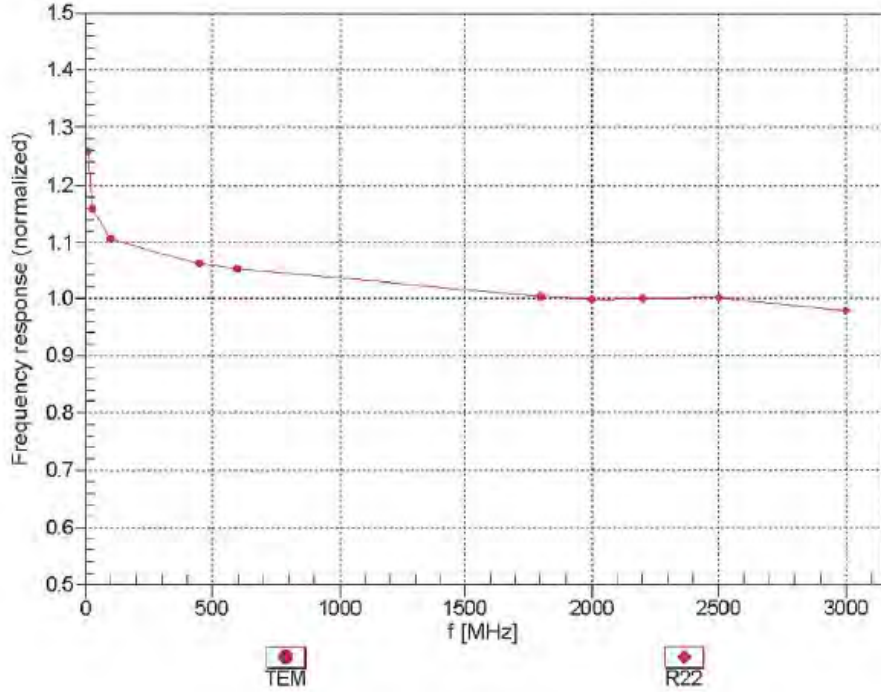

Uncertainty of Frequency Response of E-field: $\pm 6.3\%$ (k=2)

Appendix 3-8: Calibration certificate: E-Field Probe (EX3DV4) (cont'd)

EX3DV4- SN:3907

May 15, 2018

Receiving Pattern (ϕ), $\theta = 0^\circ$

f=600 MHz,TEM

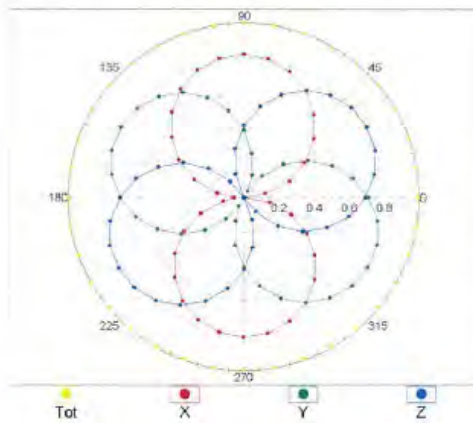

f=1800 MHz,R22

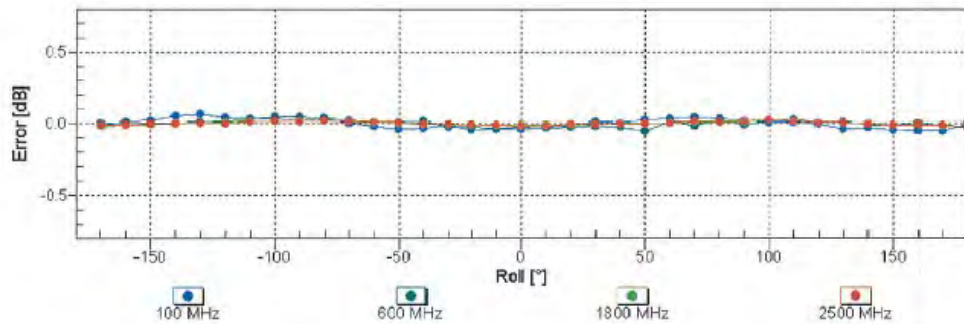
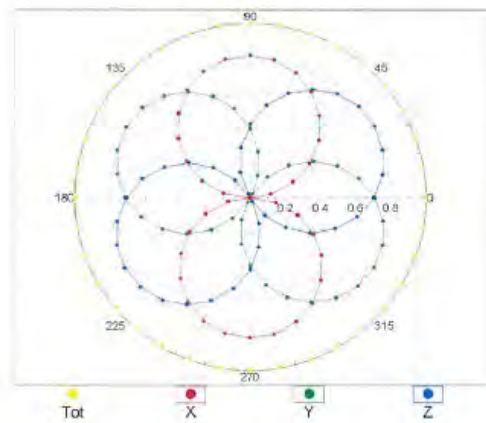

Uncertainty of Axial Isotropy Assessment: $\pm 0.5\%$ (k=2)

Appendix 3-8: Calibration certificate: E-Field Probe (EX3DV4) (cont'd)

EX3DV4- SN:3907

May 15, 2018

Dynamic Range $f(\text{SAR}_{\text{head}})$ (TEM cell, $f_{\text{eval}} = 1900 \text{ MHz}$)

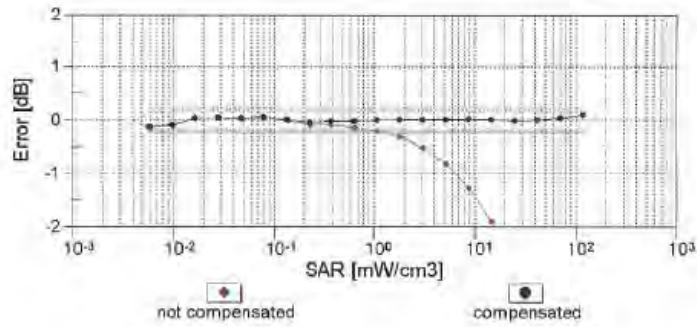
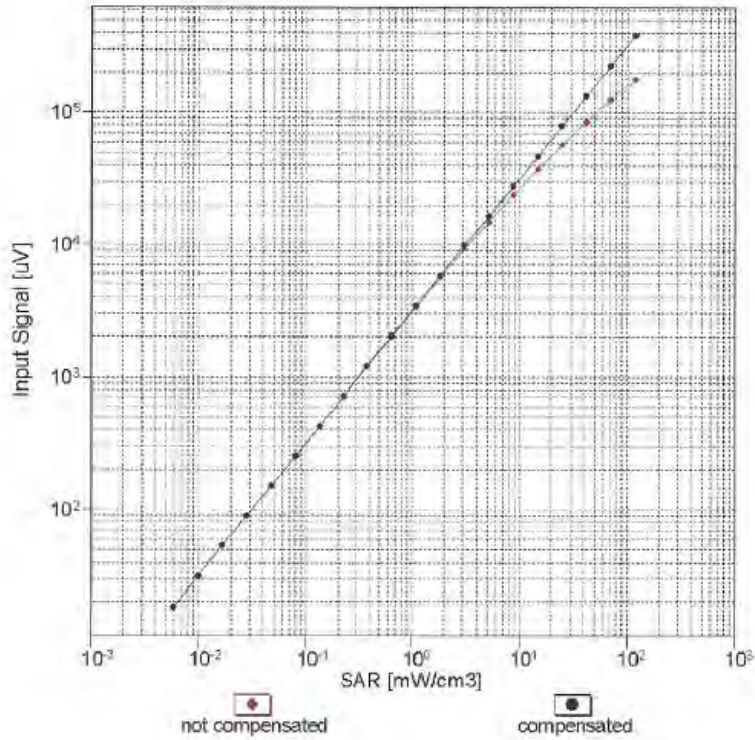

Uncertainty of Linearity Assessment: $\pm 0.6\%$ ($k=2$)

Appendix 3-8: Calibration certificate: E-Field Probe (EX3DV4) (cont'd)

EX3DV4- SN:3907

May 15, 2018

Conversion Factor Assessment

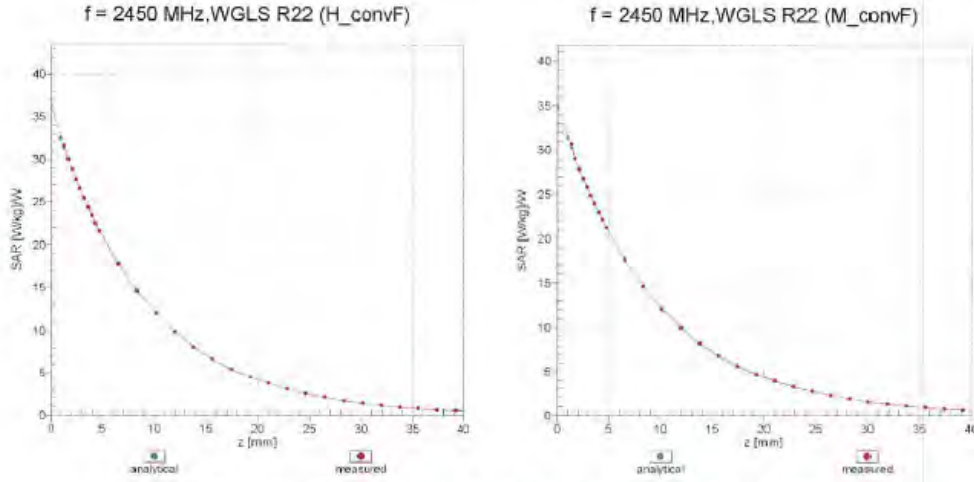

Deviation from Isotropy in Liquid

Error (ϕ, θ), f = 900 MHz

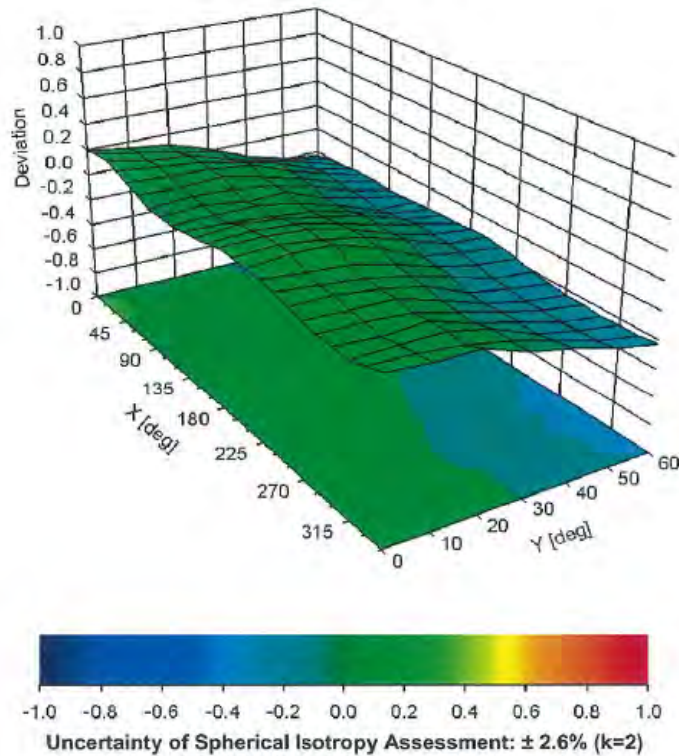

Appendix 3-8: Calibration certificate: E-Field Probe (EX3DV4) (cont'd)

EX3DV4- SN:3907

May 15, 2018

DASY/EASY - Parameters of Probe: EX3DV4 - SN:3907**Other Probe Parameters**

Sensor Arrangement	Triangular
Connector Angle (°)	39.9
Mechanical Surface Detection Mode	enabled
Optical Surface Detection Mode	disabled
Probe Overall Length	337 mm
Probe Body Diameter	10 mm
Tip Length	9 mm
Tip Diameter	2.5 mm
Probe Tip to Sensor X Calibration Point	1 mm
Probe Tip to Sensor Y Calibration Point	1 mm
Probe Tip to Sensor Z Calibration Point	1 mm
Recommended Measurement Distance from Surface	1.4 mm

Appendix 3-9: Calibration certificate: Dipole (D2450V2)

**Calibration Laboratory of
Schmid & Partner
Engineering AG**
Zeughausstrasse 43, 8004 Zurich, Switzerland



S Schweizerischer Kalibrierdienst
C Service suisse d'étalonnage
S Servizio svizzero di taratura
S Swiss Calibration Service

Accredited by the Swiss Accreditation Service (SAS)
The Swiss Accreditation Service is one of the signatories to the EA
Multilateral Agreement for the recognition of calibration certificates

Accreditation No.: **SCS 0108**

Client **UL Japan (Vitec)**

Certificate No: **D2450V2-822_Jan19**

CALIBRATION CERTIFICATE

Object: **D2450V2 - SN:822**

Calibration procedure(s): **QA CAL-05.v11
Calibration Procedure for SAR Validation Sources above 0.7-3 GHz**

Calibration date: **January 18, 2019**

This calibration certificate documents the traceability to national standards, which realize the physical units of measurements (SI).
The measurements and the uncertainties with confidence probability are given on the following pages and are part of the certificate.

All calibrations have been conducted in the closed laboratory facility: environment temperature (22 ± 3)°C and humidity < 70%.

Calibration Equipment used (M&TE critical for calibration)

Primary Standards	ID #	Cal Date (Certificate No.)	Scheduled Calibration
Power meter NRP	SN: 104778	04-Apr-18 (No. 217-02672/02673)	Apr-19
Power sensor NRP-Z91	SN: 103244	04-Apr-18 (No. 217-02672)	Apr-19
Power sensor NRP-Z91	SN: 103245	04-Apr-18 (No. 217-02673)	Apr-19
Reference 20 dB Attenuator	SN: 5058 (20k)	04-Apr-18 (No. 217-02682)	Apr-19
Type-N mismatch combination	SN: 5047.2 / 06327	04-Apr-18 (No. 217-02683)	Apr-19
Reference Probe EX3DV4	SN: 7349	31-Dec-18 (No. EX3-7349_Dec18)	Dec-19
DAE4	SN: 601	04-Oct-18 (No. DAE4-601_Oct18)	Oct-19
Secondary Standards	ID #	Check Date (in house)	Scheduled Check
Power meter EPM-442A	SN: GB37480704	07-Oct-15 (in house check Oct-18)	In house check: Oct-20
Power sensor HP 8481A	SN: US37292783	07-Oct-15 (in house check Oct-18)	In house check: Oct-20
Power sensor HP 8481A	SN: MY41092317	07-Oct-15 (in house check Oct-18)	In house check: Oct-20
RF generator R&S SMT-06	SN: 100972	15-Jun-15 (in house check Oct-18)	In house check: Oct-20
Network Analyzer Agilent E8358A	SN: US41080477	31-Mar-14 (in house check Oct-18)	In house check: Oct-19

Calibrated by:	Name Manu Seitz	Function Laboratory Technician	Signature
Approved by:	Name Katja Pokovic	Function Technical Manager	Signature

Issued: January 18, 2019

This calibration certificate shall not be reproduced except in full without written approval of the laboratory.

Appendix 3-9: Calibration certificate: Dipole (D2450V2) (cont'd)

**Calibration Laboratory of
Schmid & Partner
Engineering AG**
Zeughausstrasse 43, 8004 Zurich, Switzerland



S Schweizerischer Kalibrierdienst
C Service suisse d'étalonnage
S Servizio svizzero di taratura
S Swiss Calibration Service

Accredited by the Swiss Accreditation Service (SAS)
The Swiss Accreditation Service is one of the signatories to the EA
Multilateral Agreement for the recognition of calibration certificates

Accreditation No.: **SCS 0108**

Glossary:

TSL tissue simulating liquid
ConvF sensitivity in TSL / NORM x,y,z
N/A not applicable or not measured

Calibration is Performed According to the Following Standards:

- IEEE Std 1528-2013, "IEEE Recommended Practice for Determining the Peak Spatial-Averaged Specific Absorption Rate (SAR) in the Human Head from Wireless Communications Devices: Measurement Techniques", June 2013
- IEC 62209-1, "Measurement procedure for the assessment of Specific Absorption Rate (SAR) from hand-held and body-mounted devices used next to the ear (frequency range of 300 MHz to 6 GHz)", July 2016
- IEC 62209-2, "Procedure to determine the Specific Absorption Rate (SAR) for wireless communication devices used in close proximity to the human body (frequency range of 30 MHz to 6 GHz)", March 2010
- KDB 865664, "SAR Measurement Requirements for 100 MHz to 6 GHz"

Additional Documentation:

- DASY4/5 System Handbook

Methods Applied and Interpretation of Parameters:

- Measurement Conditions:** Further details are available from the Validation Report at the end of the certificate. All figures stated in the certificate are valid at the frequency indicated.
- Antenna Parameters with TSL:** The dipole is mounted with the spacer to position its feed point exactly below the center marking of the flat phantom section, with the arms oriented parallel to the body axis.
- Feed Point Impedance and Return Loss:** These parameters are measured with the dipole positioned under the liquid filled phantom. The impedance stated is transformed from the measurement at the SMA connector to the feed point. The Return Loss ensures low reflected power. No uncertainty required.
- Electrical Delay:** One-way delay between the SMA connector and the antenna feed point. No uncertainty required.
- SAR measured:** SAR measured at the stated antenna input power.
- SAR normalized:** SAR as measured, normalized to an input power of 1 W at the antenna connector.
- SAR for nominal TSL parameters:** The measured TSL parameters are used to calculate the nominal SAR result.

The reported uncertainty of measurement is stated as the standard uncertainty of measurement multiplied by the coverage factor $k=2$, which for a normal distribution corresponds to a coverage probability of approximately 95%.

Appendix 3-9: Calibration certificate: Dipole (D2450V2) (cont'd)**Measurement Conditions**

DASY system configuration, as far as not given on page 1.

DASY Version	DASY5	V52.10.2
Extrapolation	Advanced Extrapolation	
Phantom	Modular Flat Phantom	
Distance Dipole Center - TSL	10 mm	with Spacer
Zoom Scan Resolution	dx, dy, dz = 5 mm	
Frequency	2450 MHz \pm 1 MHz	

Head TSL parameters

The following parameters and calculations were applied.

	Temperature	Permittivity	Conductivity
Nominal Head TSL parameters	22.0 °C	39.2	1.80 mho/m
Measured Head TSL parameters	(22.0 \pm 0.2) °C	37.8 \pm 6 %	1.87 mho/m \pm 6 %
Head TSL temperature change during test	< 0.5 °C	----	----

SAR result with Head TSL

SAR averaged over 1 cm³ (1 g) of Head TSL	Condition	
SAR measured	250 mW input power	13.3 W/kg
SAR for nominal Head TSL parameters	normalized to 1W	51.8 W/kg \pm 17.0 % (k=2)

SAR averaged over 10 cm³ (10 g) of Head TSL	condition	
SAR measured	250 mW input power	6.18 W/kg
SAR for nominal Head TSL parameters	normalized to 1W	24.3 W/kg \pm 16.5 % (k=2)

Body TSL parameters

The following parameters and calculations were applied.

	Temperature	Permittivity	Conductivity
Nominal Body TSL parameters	22.0 °C	52.7	1.95 mho/m
Measured Body TSL parameters	(22.0 \pm 0.2) °C	51.1 \pm 6 %	2.03 mho/m \pm 6 %
Body TSL temperature change during test	< 0.5 °C	----	----

SAR result with Body TSL

SAR averaged over 1 cm³ (1 g) of Body TSL	Condition	
SAR measured	250 mW input power	13.0 W/kg
SAR for nominal Body TSL parameters	normalized to 1W	50.7 W/kg \pm 17.0 % (k=2)

SAR averaged over 10 cm³ (10 g) of Body TSL	condition	
SAR measured	250 mW input power	6.02 W/kg
SAR for nominal Body TSL parameters	normalized to 1W	23.7 W/kg \pm 16.5 % (k=2)

Appendix 3-9: Calibration certificate: Dipole (D2450V2) (cont'd)**Appendix (Additional assessments outside the scope of SCS 0108)****Antenna Parameters with Head TSL**

Impedance, transformed to feed point	53.8 Ω + 5.4 j Ω
Return Loss	- 24.0 dB

Antenna Parameters with Body TSL

Impedance, transformed to feed point	50.0 Ω + 8.3 j Ω
Return Loss	- 21.6 dB

General Antenna Parameters and Design

Electrical Delay (one direction)	1.158 ns
----------------------------------	----------

After long term use with 100W radiated power, only a slight warming of the dipole near the feedpoint can be measured.

The dipole is made of standard semirigid coaxial cable. The center conductor of the feeding line is directly connected to the second arm of the dipole. The antenna is therefore short-circuited for DC-signals. On some of the dipoles, small end caps are added to the dipole arms in order to improve matching when loaded according to the position as explained in the "Measurement Conditions" paragraph. The SAR data are not affected by this change. The overall dipole length is still according to the Standard.

No excessive force must be applied to the dipole arms, because they might bend or the soldered connections near the feedpoint may be damaged.

Additional EUT Data

Manufactured by	SPEAG
-----------------	-------

Appendix 3-9: Calibration certificate: Dipole (D2450V2) (cont'd)**DASY5 Validation Report for Head TSL**

Date: 18.01.2019

Test Laboratory: SPEAG, Zurich, Switzerland

DUT: Dipole 2450 MHz; Type: D2450V2; Serial: D2450V2 - SN:822

Communication System: UID 0 - CW; Frequency: 2450 MHz

Medium parameters used: $f = 2450$ MHz; $\sigma = 1.87$ S/m; $\epsilon_r = 37.8$; $\rho = 1000$ kg/m³

Phantom section: Flat Section

Measurement Standard: DASY5 (IEEE/IEC/ANSI C63.19-2011)

DASY52 Configuration:

- Probe: EX3DV4 - SN7349; ConvF(7.96, 7.96, 7.96) @ 2450 MHz; Calibrated: 31.12.2018
- Sensor-Surface: 1.4mm (Mechanical Surface Detection)
- Electronics: DAE4 Sn601; Calibrated: 04.10.2018
- Phantom: Flat Phantom 5.0 (front); Type: QD 000 P50 AA; Serial: 1001
- DASY52 52.10.2(1495); SEMCAD X 14.6.12(7450)

Dipole Calibration for Head Tissue/Pin=250 mW, d=10mm/Zoom Scan (7x7x7)/Cube 0:

Measurement grid: dx=5mm, dy=5mm, dz=5mm

Reference Value = 111.1 V/m; Power Drift = 0.05 dB

Peak SAR (extrapolated) = 26.7 W/kg

SAR(1 g) = 13.3 W/kg; SAR(10 g) = 6.18 W/kg

Maximum value of SAR (measured) = 20.8 W/kg

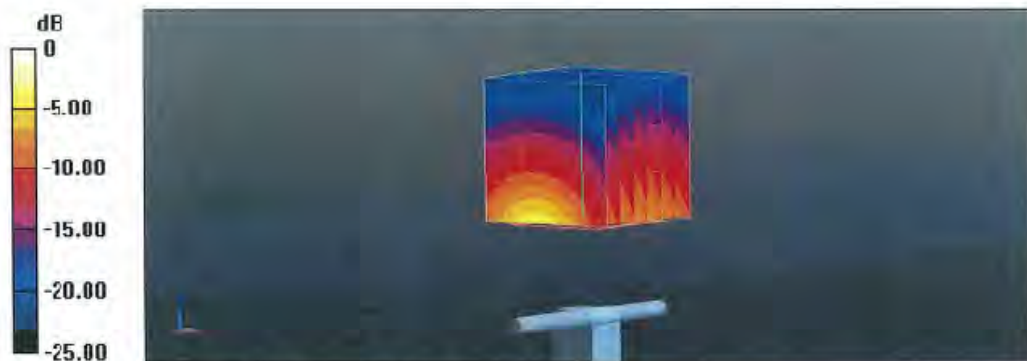

Appendix 3-9: Calibration certificate: Dipole (D2450V2) (cont'd)

Impedance Measurement Plot for Head TSL

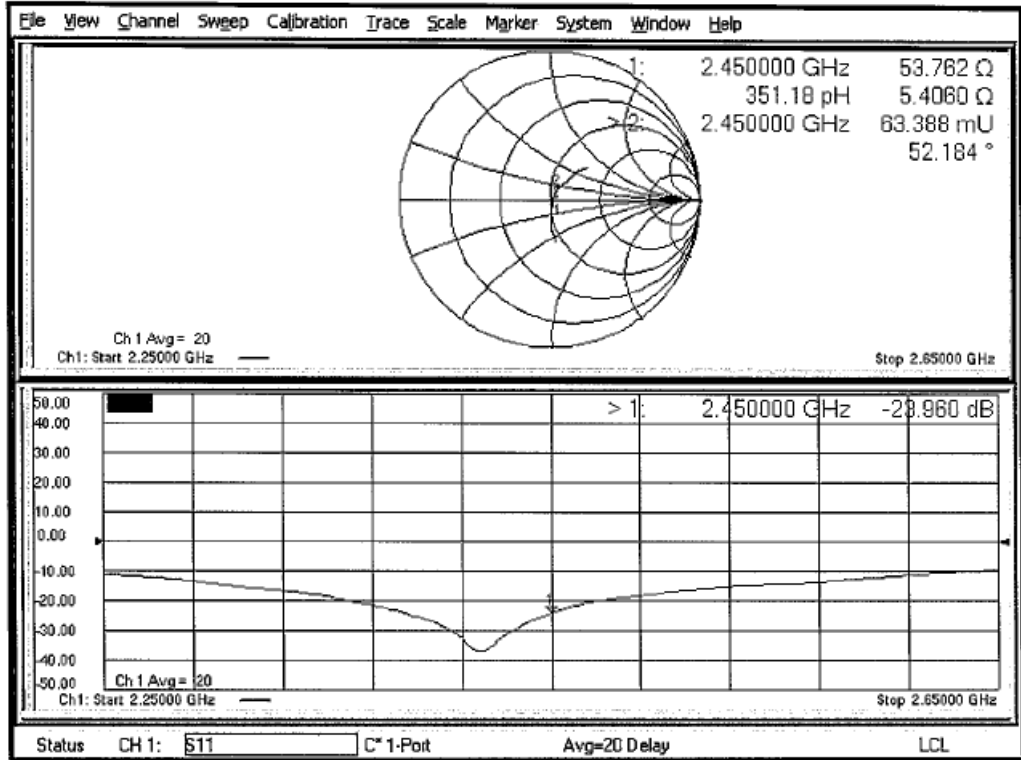

Appendix 3-9: Calibration certificate: Dipole (D2450V2) (cont'd)**DASY5 Validation Report for Body TSL**

Date: 18.01.2019

Test Laboratory: SPEAG, Zurich, Switzerland

DUT: Dipole 2450 MHz; Type: D2450V2; Serial: D2450V2 - SN:822

Communication System: UID 0 - CW; Frequency: 2450 MHz

Medium parameters used: $f = 2450$ MHz; $\sigma = 2.03$ S/m; $\epsilon_r = 51.1$; $\rho = 1000$ kg/m³

Phantom section: Flat Section

Measurement Standard: DASY5 (IEEE/IEC/ANSI C63.19-2011)

DASY52 Configuration:

- Probe: EX3DV4 - SN7349; ConvF(8.09, 8.09, 8.09) @ 2450 MHz; Calibrated: 31.12.2018
- Sensor-Surface: 1.4mm (Mechanical Surface Detection)
- Electronics: DAE4 Sn601; Calibrated: 04.10.2018
- Phantom: Flat Phantom 5.0 (back); Type: QD 000 P50 AA; Serial: 1002
- DASY52 52.10.2(1495); SEMCAD X 14.6.12(7450)

Dipole Calibration for Body Tissue/Pin=250 mW, d=10mm/Zoom Scan (7x7x7)/Cube 0:

Measurement grid: dx=5mm, dy=5mm, dz=5mm

Reference Value = 108.9 V/m; Power Drift = -0.02 dB

Peak SAR (extrapolated) = 26.1 W/kg

SAR(1 g) = 13 W/kg; SAR(10 g) = 6.02 W/kg

Maximum value of SAR (measured) = 21.5 W/kg

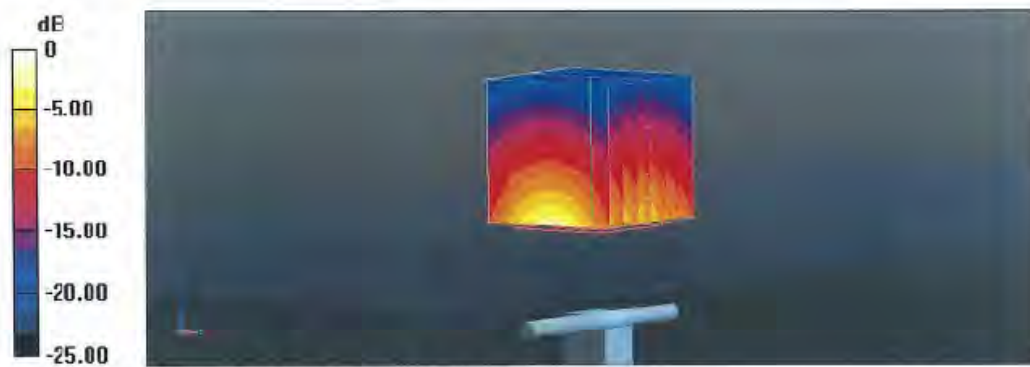

0 dB = 21.5 W/kg = 13.32 dBW/kg

Appendix 3-9: Calibration certificate: Dipole (D2450V2) (cont'd)

Impedance Measurement Plot for Body TSL

