



Safety Information

1. Information

2. Safety During Operation

3. Safety Labels of This Machine

4. Laws and Regulations

5. Important Safety Instructions

For information not in this manual, refer to the PDF files on the supplied CD-ROM.



Read this manual carefully before you use this machine and keep it handy for future reference. For safe and correct use, be sure to read the Safety Information in This manual before using the machine.

English



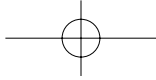

Information

Introduction

This manual contains detailed instructions and notes on the operation and use of this machine. For your safety and benefit, read this manual carefully before using the machine. Keep this manual in a handy place for quick reference.

Power Source

120-127 V, 11 A, 60 Hz

Be sure to connect the power cord to a power source as above.

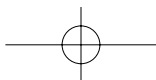
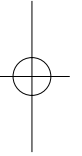
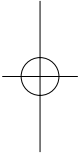

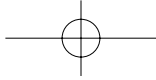

Safety During Operation

In this manual, the following important symbols are used:

⚠ WARNING:

Indicates a potentially hazardous situation which, if instructions are not followed, could result in death or serious injury.

⚠ CAUTION:

Indicates a potentially hazardous situation which, if instructions are not followed, may result in minor or moderate injury or damage to property.

Environments Where the Machine Can be Used

⚠ WARNING:

• ***Do not use flammable sprays or solvents in the vicinity of this machine. Doing so could result in fire or electric shock.***

• ***Do not place vases, plant pots, cups, toiletries, medicines, small metal objects, or containers holding water or any other liquids, on or close to this machine. Fire or electric shock could result from spillage or if such objects or substances fall inside this machine.***

⚠ CAUTION:

• *Keep the machine away from humidity and dust. Otherwise a fire or an electric shock might occur.*

• *Do not place the machine on an unstable or tilted surface. If it topples over, an injury might occur.*

• *Do not place heavy objects on the machine. Doing so can cause the machine to topple over, possibly resulting in injury.*

• *Make sure the room where you are using the machine is well ventilated and spacious. Good ventilation is especially important when the machine is used heavily.*

• *Keep the machine in an area that is within optimum environmental conditions. Operating the machine in an environment that is outside the recommended ranges of humidity and temperature can cause an electrical fire hazard. Keep the area around the socket free of dust. Accumulated dust can become an electrical fire hazard.*

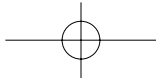

- *Do not obstruct the machine's vents. Doing so risks fire caused by over-heated internal components.*

Handling Power Cords and Power Plugs

⚠ WARNING:

- *Touching the prongs of the power cable's plug with anything metallic constitutes a fire and electric shock hazard.*
- *Do not use any frequencies other than those that match the specifications shown. Doing so could result in fire or electric shock.*
- *Do not use any power sources other than those that match the specifications shown in this manual. Doing so could result in fire or electric shock.*
- *Do not use multi-socket adaptors. Doing so could result in fire or electric shock.*
- *Do not use extension cords. Doing so could result in fire or electric shock.*
- *Do not use power cords that are damaged, broken, or modified. Also, do not use power cords that have been trapped under heavy objects, pulled hard, or bent severely. Doing so could result in fire or electric shock.*
- *It is dangerous to handle the power cord plug with wet hands. Doing so could result in electric shock.*
- *If the power cord is damaged and its inner wires are exposed or broken, contact your service representative for a replacement. Use of damaged power cords could result in fire or electric shock.*
- *Be sure to disconnect the power cord from the wall outlet at least once a year and check for the following:*
 - *The power cord's inner wires are exposed, broken, etc.*
 - *The power cord's coating has a crack or dent.*
 - *When bending the power cord, the power turns off and on.*
 - *Part of the power cord becomes hot.*
 - *The power cord is damaged.*
- *If any of the above conditions exist, do not use the power cord and consult your dealer or service representative. Use of the power cord could result in fire or electric shock.*

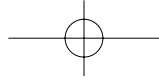

- **Be sure to disconnect the plug from the wall outlet at least once a year and check for the following:**
 - **There are burn marks on the plug.**
 - **The prongs on the plug are deformed.**
- **If any of the above conditions exist, do not use the plug and consult your dealer or service representative. Use of the plug could result in fire or electric shock.**

- **The supplied power cord is for use with this machine only. Do not use it with other appliances. Doing so could result in fire or electric shock.**

⚠ CAUTION:

- *Be sure to disconnect the plug from the wall outlet and clean the prongs and the area around the prongs at least once a year. Allowing dust to build up on the plug constitutes a fire hazard.*
- *Be sure to push the plug of the power cord fully into the wall outlet. Partially inserted plugs create an unstable connection that can result in unsafe buildup of heat.*
- *If this machine is not going to be used for several days or longer at a time, disconnect its power cord from the wall outlet.*
- *When disconnecting the power cord from the wall outlet, always pull the plug, not the cord. Pulling the cord can damage the power cord. Use of damaged power cords could result in fire or electric shock.*
- *When performing maintenance on the machine, always disconnect the power cord from the wall outlet.*
- *To reduce the risk of fire, use only No.26 AWG or larger telecommunication line cord.*

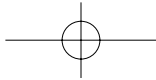

Handling the Machine

WARNING:

- *Be sure to locate the machine as close as possible to a wall outlet. This will allow easy disconnection of the power cord in the event of an emergency.*
- *If the machine emits smoke or odours, or if it behaves unusually, you must turn off its power immediately. After turning off the power, be sure to disconnect the power cord plug from the wall outlet. Then contact your service representative and report the problem. Do not use the machine. Doing so could result in fire or electric shock.*
- *If metal objects, or water or other fluids fall inside this machine, you must turn off its power immediately. After turning off the power, be sure to disconnect the power cord plug from the wall outlet. Then contact your service representative and report the problem. Do not use the machine. Doing so could result in fire or electric shock.*
- *Do not touch this machine if a lightning strike occurs in the immediate vicinity. Doing so could result in electric shock*
- *The following explains the warning messages on the plastic bag used in this product's packaging.*
- *Keep the polythene materials (bags, etc.) supplied with this machine away from babies and small children at all times. Suffocation can result if polythene materials are brought into contact with the mouth or nose.*

CAUTION:

- *When moving the machine, use the inset grips on both sides, and lift it up slowly. The machine may break or cause injury if dropped.*
- *Be careful not to trap your fingers when opening or closing the cover.*
- *Unplug the power cord from the wall outlet before you move the machine. While moving the machine, take care that the power cord is not damaged under the machine. Failing to take these precautions could result in fire or electric shock.*
- *Do not look into the lamp. It can damage your eyes.*

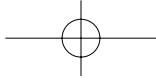

- *SP C250DN/SP C252DN weighs around 23.8 kg (52.5 lb). SP C250SF/SP C252SF weighs around 29.0 kg (64 lb.). When moving the machine, use the inset grips on both sides, and lift slowly in pairs. The machine will break or cause injury if dropped.*

Handling the Machine's Interior

⚠ WARNING:

- *Do not remove any covers or screws other than those explicitly mentioned in this manual. Inside this machine are high voltage components that are an electric shock hazard and laser components that could cause blindness. Contact your sales or service representative if any of the machine's internal components require maintenance, adjustment, or repair.*
- *Do not attempt to disassemble or modify this machine. Doing so risks burns and electric shock. Note again that exposure to the laser components inside this machine risks blindness.*

⚠ CAUTION:

- *Some of this machine's internal components get very hot. For this reason, take care when removing misfed paper. Not doing so could result in burns.*
- *When removing jammed paper, make sure not to trap or injure your fingers.*
- *When loading paper, take care not to trap or injure your fingers.*
- *During operation, rollers for transporting the paper and originals revolve. A safety device has been installed so that the machine can be operated safely. But take care not to touch the machine during operation. Otherwise, an injury might occur.*

Handling the Machine's Supplies

⚠ WARNING:

- *Do not use a vacuum cleaner to remove spilled toner (including used toner). Absorbed toner may cause a fire or explosion due to electrical contact flickering inside the vacuum cleaner. However, it is possible to use a vacuum cleaner that is explosion-proof and dust ignition-proof. If toner is spilled on the floor, remove the spilled toner slowly using a wet cloth, so that the toner is not scattered.*

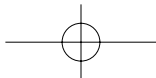

- ***Do not incinerate toner (new or used) or toner containers. Doing so risks burns. Toner will ignite on contact with naked flame.***

- ***Do not store toner (new or used) or toner containers anywhere near naked flames. Doing so risks fire and burns. Toner will ignite on contact with naked flame.***

- ***The following explains the warning messages on the plastic bag used in this product's packaging.***

- ***Keep the polythene materials (bags, gloves, etc.) supplied with this machine away from babies and small children at all times. Suffocation can result if polythene materials are brought into contact with the mouth or nose.***

⚠ CAUTION:

- *If toner or used toner is inhaled, gargle with plenty of water and move into a fresh air environment. Consult a doctor if necessary.*

- *When removing jammed paper or replacing toner, avoid getting toner (new or used) on your clothing. If toner comes into contact with your clothing, wash the stained area with cold water. Hot water will set the toner into the fabric and make removing the stain impossible.*

- *If toner or used toner gets into your eyes, flush immediately with large amounts of water. Consult a doctor if necessary.*

- *If toner or used toner is swallowed, dilute by drinking a large amount of water. Consult a doctor if necessary.*

- *When removing jammed paper or replacing toner, avoid getting toner (new or used) on your skin. If toner comes into contact with your skin, wash the affected area thoroughly with soap and water.*

- *Do not crush or squeeze toner containers. Doing so can cause toner spillage, possibly resulting in dirtying of skin, clothing, and floor, and accidental ingestion.*

- *Store toner (new or used), toner containers, and components that have been in contact with toner out of reach of children.*

- *When replacing a toner or waste toner container or consumables with toner, make sure that the toner does not splatter. Put the waste consumables in a bag after they are removed. For consumables with a lid, make sure that the lid is shut.*

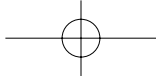

• *Our products are engineered to meet high standards of quality and functionality, and we recommend that you use only the expendable supplies available at an authorized dealer.*

• *Keep USB flash memory devices out of reach of children. If a child accidentally swallows an USB flash memory device, consult a doctor immediately.*

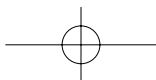
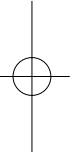
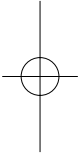

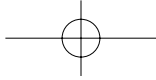

Safety Labels of This Machine

This section explains the machine's safety information labels.

Positions of ⚠️WARNING and ⚠️CAUTION labels

This machine has labels for ⚠️WARNING and ⚠️CAUTION at the positions shown below. For safety, please follow the instructions and handle the machine as indicated.

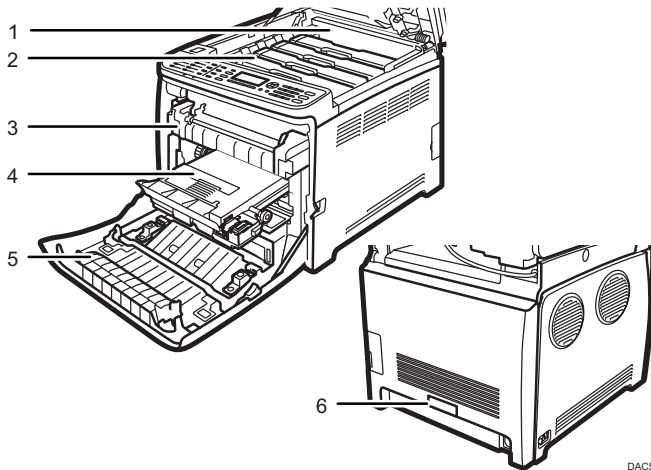

1.

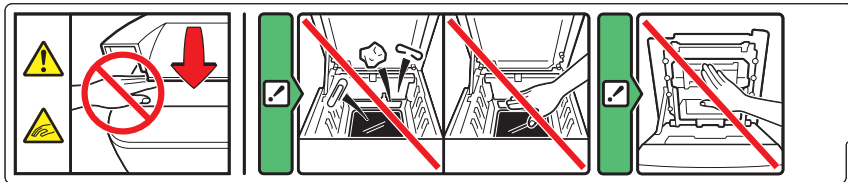

Be careful not to trap your fingers when opening or closing the top cover.

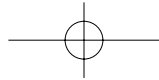

2.



DAC464

Do not incinerate used toner or toner containers. Toner dust might ignite when exposed to an open flame. Dispose of used toner containers in according with local regulations.

Do not use the cleaner to suck spilled toner (including used toner). Sucked toner may cause firing or explosion due to electrical contact flickering inside the cleaner. However, it is possible to use the cleaner designed for dust explosion- proof purpose. If toner is spilled over the floor, sweep up spilled toner slowly and clean remainder with wet cloth.

Store toner (new or used), toner containers, and components that have been in contact with toner out of reach of children.

3.



CES503

Do not touch the labelled area indicated by 3 in the illustration above. The area can get very hot.

4.

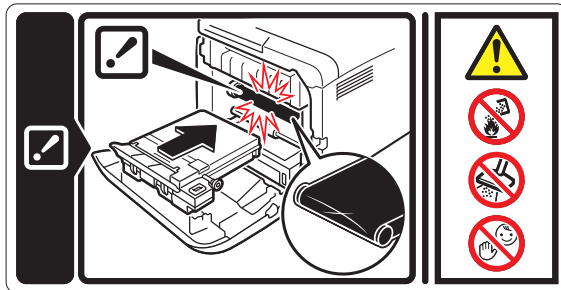

DAC465

Do not incinerate used toner or toner containers. Toner dust might ignite when exposed to an open flame. Dispose of used toner containers in according with local regulations.

Do not use the cleaner to suck spilled toner (including used toner). Sucked toner may cause firing or explosion due to electrical contact flickering inside the cleaner. However, it is possible to use the cleaner designed for dust explosion- proof purpose. If toner is spilled over the floor, sweep up spilled toner slowly and clean remainder with wet cloth.

Store toner (new or used), toner containers, and components that have been in contact with toner out of reach of children.

5.



Do not touch the labelled area indicated by 5 in the illustration above.
The area can get very hot.

6.

SP C250DN/SP C252DN



The printer weighs approximately 23.8 kg (52.5 lb.). When moving the printer, use the inset grips on both sides, and lift slowly in pairs.

SP C250SF/SP C252SF



The machine weighs approximately 29 kg (64 lb.). When moving the machine, use the inset grips on both sides, and lift slowly in pairs.

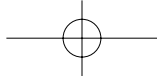

Power Switch Symbols

The meanings of the symbols for the switches on this machine are as follows:

- **I** :POWER ON.
- **O** :POWER OFF.

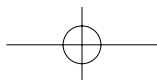
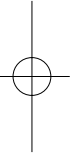
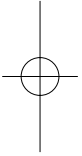

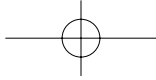

Laws and Regulations

Legal Prohibition

Do not copy or print any item for which reproduction is prohibited by law.

Copying or printing the following items is generally prohibited by local law:

bank notes, revenue stamps, bonds, stock certificates, bank drafts, checks, passports, driver's licenses.

The preceding list is meant as a guide only and is not inclusive. We assume no responsibility for its completeness or accuracy. If you have any questions concerning the legality of copying or printing certain items, consult with your legal advisor.

This machine is equipped with a function that prevents making counterfeit bank bills. Due to this function the original images similar to bank bills may not be copied properly.

Laser Safety

CDRH Regulations

This machine complies with the requirements of 21 CFR Subchapter J for class I laser product. This machine contains AlGaAs laser diode, 6.2-milliwatt, 770-795 nanometer wavelength for each emitter. The beam divergence angle is 25 degrees (minimum) and 38 degrees (maximum) in the vertical direction, and 8 degrees (minimum) and 14 degrees (maximum) in the horizontal direction, and laser beams are generated in Continuous Wave (CW) mode.

Caution:

Use of controls or adjustments or performance of procedures other than those specified in this manual might result in hazardous radiation exposure.

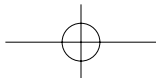

Notes to USA Users of FCC Requirements

Part 15 of the FCC Rules

❖ Note

This equipment has been tested and found to comply with the limits for a Class B digital device, pursuant to Part 15 of the FCC Rules. These limits are designed to provide reasonable protection against harmful interference in a residential installation. This equipment generates, uses and can radiate radio frequency energy and, if not installed and used in accordance with the instructions, may cause harmful interference to radio communications. However, there is no guarantee that interference will not occur in a particular installation. If this equipment does cause harmful interference to radio or television reception, which can be determined by turning the equipment off and on, the user is encouraged to try to correct the interference by one more of the following measures:

- Reorient or relocate the receiving antenna.
- Increase the separation between the equipment and receiver.
- Connect the equipment into an outlet on a circuit different from that to which the receiver is connected.
- Consult the dealer or an experienced radio /TV technician for help.

This device complies with part 15 of the FCC Rules.

Operation is subject to the following two conditions:

- (1) This device may not cause harmful interference, and
- (2) This device must accept any interference received, including interference that may cause undesired operation.

Changes or modifications not expressly approved by the party responsible for compliance could void the user's authority to operate the equipment.

❖ Caution

Changes or modifications not expressly approved by the party responsible for compliance could void the user's authority to operate the equipment.

❖ Country Code Statement

For product available in the USA/Canada market, only channel 1~11 can be operated. Selection of other channels is not possible.

❖ CAUTION:

Any changes or modifications not expressly approved by the grantee of this device could void the user's authority to operate the equipment. This transmitter must not be co-located or operating in conjunction with any other antenna or transmitter.

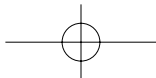

❖ Federal Communication Commission (FCC) Radiation Exposure Statement

This equipment complies with FCC radiation exposure limits set forth for an uncontrolled environment and meets the FCC radio frequency (RF) Exposure Guidelines. This equipment has very low levels of RF energy that it deemed to comply without maximum permissive exposure evaluation (MPE). But it is desirable that it should be installed and operated keeping the radiator at least 20cm or more away from person's body (excluding extremities: hands, wrists, feet and ankles).

Part 68 of the FCC Rules

❖ FCC Requirements

- 1) This equipment complies with Part 68 of the FCC rules and requirements adopted by the ACTA. On the cover of this equipment is a label that contains, among other information, a product identifier in the format US:AAAEQ##TXXXXX. If requested, this number must be provided to the telephone company.
- 2) This equipment uses the RJ11C USOC jack.
- 3) A plug and jack used to connect this equipment to the premises wiring and telephone network must comply with the applicable FCC Part 68 rules and requirements adopted by the ACTA. A compliant telephone cord and modular plug is provided with this product. It is designed to be connected to a compatible modular jack that is also compliant. See installation instructions for detail.
- 4) The REN is used to determine the number of devices that may be connected to a telephone line. Excessive RENs on a telephone line may result in the devices not ringing in response to an incoming call. In most but not all areas, the sum of RENs should not exceed five (5.0). To be certain of the number of devices that may be connected to a line, as determined by the total RENs, contact the local telephone company. The REN for this product is part of the product identifier that has the format US:AAAEQ##TXXXXX. The digits represented by ## are the REN without a decimal point (e.g., 03 is a REN of 0.3).
- 5) If this equipment causes harm to the telephone network, the telephone company will notify you in advance that temporary discontinuance of service may be required. But if advance notice is not practical, the telephone company will notify the customer as soon as possible. Also, you will be advised of your right to file a complaint with the FCC if you believe it is necessary.
- 6) The telephone company may make changes in its facilities, equipment, operations or procedures that could affect the operation of the equipment. If this happens the telephone company will provide advance notice in order for you to make necessary modifications to maintain uninterrupted service.
- 7) If trouble is experienced with this equipment, for repair or warranty information, please contact Ricoh Americas Corporation. CUSTOMER SUPPORT DEPT. at 1-800- FASTFIX. If the equipment is causing harm to the telephone network, the telephone company may request that you disconnect the equipment until the problem is resolved.
- 8) In the event of operation problems (document jam, copy jam, communication error indication), refer to the solving problems section in this manual.
- 9) Connection to party line service is subject to state tariffs. Contact the state public utility commission, public service commission or corporation commission for information.

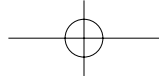

- 10) If your home has specially wired alarm equipment connected to the telephone line, ensure the installation of this equipment does not disable your alarm equipment. If you have questions about what will disable alarm equipment, consult your telephone company or a qualified installer.

❖ **WHEN PROGRAMMING EMERGENCY NUMBERS AND/OR MAKING TEST CALLS TO EMERGENCY NUMBERS:**

- 1) Remain on the line and briefly explain to the dispatcher the reason for the call before hanging up.
- 2) Perform such activities in the off-peak hours, such as early morning hours or late evenings.

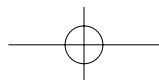
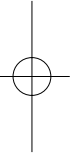
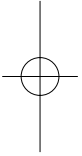

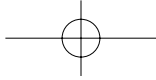

Important Safety Instructions

When using your telephone equipment, basic safety precautions should always be followed to reduce the risk of fire, electric shock and injury to persons, including the following:

1. Do not use this product near water, for example, near a bathtub, wash bowl, kitchen sink or laundry tub, in a wet basement or near a swimming pool.
2. Avoid using a telephone (other than a cordless type) during an electrical storm. There may be a remote risk of electric shock from lightning.
3. Do not use the telephone to report a gas leak in the vicinity of the leak.
4. Use only the power cord and batteries indicated in this manual. Do not dispose of batteries in a fire. They may explode. Check with local codes for possible special disposal instructions.

SAVE THESE INSTRUCTIONS.

IMPORTANTES MESURES DE SÉCURITÉ

Certaines mesures de sécurité doivent être prises pendant l'utilisation de matériel téléphonique afin de réduire les risques d'incendie, de choc électrique et de blessures. En voici quelques-unes:

1. Ne pas utiliser l'appareil près de l'eau, p.ex., près d'une baignoire, d'un lavabo, d'un évier de cuisine, d'un bac à laver, dans un sous-sol humide ou près d'une piscine.
2. Éviter d'utiliser le téléphone (sauf s'il s'agit d'un appareil sans fil) pendant un orage électrique. Ceci peut présenter un risque de choc électrique causé par la foudre.
3. Ne pas utiliser l'appareil téléphonique pour signaler une fuite de gaz s'il est situé près de la fuite.
4. Utiliser seulement le cordon d'alimentation et le type de piles indiqués dans ce manuel. Ne pas jeter les piles dans le feu: elles peuvent exploser. Se conformer aux règlements pertinents quant à l'élimination des piles.

CONSERVER CES INSTRUCTIONS.

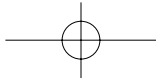

Notes to Canadian Users of SP C250SF/SP C252SF

This product meets the applicable Industry Canada technical specifications. The Ringer Equivalence Number is an indication of the maximum number of devices allowed to be connected to a telephone interface. The termination on an interface may consist of any combination of devices subject only to the requirement that the sum of the RENs of all the devices does not exceed five.

Remarques a l'attention des utilisateurs canadiens du SP C250SF/SP C252SF

Le présent matériel est conforme aux spécifications techniques applicables d'Industrie Canada.

L'indice d'équivalence de la sonnerie (IES) sert à indiquer le nombre maximal de terminaux qui peuvent être raccordés à une interface téléphonique. La terminaison d'une interface peut consister en une combinaison quelconque de dispositifs, à la seule condition que la somme d'indices d'équivalence de la sonnerie de tous les dispositifs n'excède pas 5.

Notice about the Telephone Consumer Protection Act (Valid in USA only)

The Telephone Consumer Protection Act of 1991 makes it unlawful for any person to use a computer or other electronic device, including FAX machines, to send any message unless such message clearly contains in a margin at the top or bottom of each transmitted page or on the first page of the transmission, the date and time it is sent and an identification of the business or other entity, or other individual sending the message and the telephone number of the sending machine or such business, other entity, or individual. (The telephone number provided may not be a 900 number or any other number for which charges exceed local or long-distance transmission charges.)

In order to program this information into your FAX machine, you should complete the following steps: Follow the FAX HEADER programming procedure in the Programming chapter of the operating instructions to enter the business identification and telephone number of the terminal or business. This information is transmitted with your document by the FAX HEADER feature. In addition to the information, be sure to program the date and time into your machine.

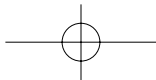

Note to users in Canada

❖ **Note**

This Class B digital apparatus complies with Canadian ICES- 003.

Remarque concernant les utilisateurs au Canada

❖ **Avertissement**

Cet appareil numérique de la classe B est conforme à la norme NMB-003 du Canada.

Notes to Canadian Users of IC Rules

❖ **Notes to users in Canada**

This device complies with Industry Canada licence-exempt RSS standard(s).

Operation is subject to the following two conditions:

- (1) this device may not cause interference, and
- (2) this device must accept any interference, including interference that may cause undesired operation of the device.

For product available in the USA/Canada market, only channel 1~11 can be operated. Selection of other channels is not possible.

Under Industry Canada regulations, this radio transmitter may only operate using an antenna of a type and maximum (or lesser) gain approved for the transmitter by Industry Canada. To reduce potential radio interference to other users, the antenna type and its gain should be so chosen that the equivalent isotropically radiated power (e.i.r.p.) is not more than that necessary for successful communication.

❖ **Remarques a l'attention des utilisateurs canadiens**

Le present appareil est conforme aux CNR d'Industrie Canada applicables aux appareils radio exempts de licence.

L'exploitation est autorisee aux deux conditions suivantes :

- (1) l'appareil ne doit pas produire de brouillage, et
- (2) l'utilisateur de l'appareil doit accepter tout brouillage radioelectrique subi, meme si le brouillage est susceptible d'en compromettre le fonctionnement.

Pour les produits disponibles aux États-Unis / Canada du marché, seul le canal 1 à 11 peuvent être exploités. Sélection d'autres canaux n'est pas possible.

Conformément à la réglementation d'Industrie Canada, le présent émetteur radio peut fonctionner avec une antenne d'un type et d'un gain maximal (ou inférieur) approuvé pour l'émetteur par Industrie Canada. Dans le but de réduire les risques de brouillage radioélectrique à l'intention des autres utilisateurs, il faut choisir le type d'antenne et son gain de sorte que la puissance isotrope rayonnée équivalente (p.i.r.e.) ne dépasse pas l'intensité nécessaire à l'établissement d'une communication satisfaisante.

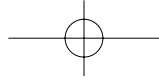

IMPORTANT NOTE:

IC Radiation Exposure Statement

This equipment complies with IC radiation exposure limits set forth for an uncontrolled environment and meets RSS-102 of the IC radio frequency (RF) Exposure rules. This equipment has very low levels of RF energy that it deemed to comply without maximum permissive exposure evaluation (MPE). But it is desirable that it should be installed and operated keeping the radiator at least 20cm or more away from person's body (excluding extremities: hands, wrists, feet and ankles).son's body (excluding extremities: hands, wrists, feet and ankles).

REMARQUE IMPORTANTE :

Declaration IC d'exposition aux rayons

Cet équipement est conforme aux limites d'exposition aux rayonnements énoncées pour un environnement non contrôlé et respecte les règles d'exposition aux fréquences radioélectriques (RF) CNR-102 de l'IC. Cet équipement émet une énergie RF très faible qui est considérée conforme sans évaluation de l'exposition maximale autorisée. Cependant, cet équipement doit être installé et utilisé en gardant une distance de 20 cm ou plus entre le dispositif rayonnant et le corps (à l'exception des extrémités : mains, poignets, pieds et chevilles).